



# University of HUDDERSFIELD

## University of Huddersfield Repository

Shebani, Amer and Iwnicki, Simon

Prediction of wheel and rail wear under different contact conditions using artificial neural networks

### Original Citation

Shebani, Amer and Iwnicki, Simon (2018) Prediction of wheel and rail wear under different contact conditions using artificial neural networks. *Wear*. ISSN 0043-1648

This version is available at <http://eprints.hud.ac.uk/id/eprint/34364/>

The University Repository is a digital collection of the research output of the University, available on Open Access. Copyright and Moral Rights for the items on this site are retained by the individual author and/or other copyright owners. Users may access full items free of charge; copies of full text items generally can be reproduced, displayed or performed and given to third parties in any format or medium for personal research or study, educational or not-for-profit purposes without prior permission or charge, provided:

- The authors, title and full bibliographic details is credited in any copy;
- A hyperlink and/or URL is included for the original metadata page; and
- The content is not changed in any way.

For more information, including our policy and submission procedure, please contact the Repository Team at: [E.mailbox@hud.ac.uk](mailto:E.mailbox@hud.ac.uk).

<http://eprints.hud.ac.uk/>

# Prediction of wheel and rail wear under different contact conditions using artificial neural networks

A. Shebani, S. Iwnicki

Institute of Railway Research, University of Huddersfield, Huddersfield, UK

**Abstract**— Wheel and rail wear is a significant issue in railway systems. Accurate prediction of this wear can improve economy, ride comfort, prevention of derailment and planning of maintenance interventions. Poor prediction can result in failure and consequent delay and increased costs if it is not controlled in an effective way. However, prediction of wheel and rail wear is still a great challenge for railway engineers and operators. The aim of this paper is to predict wheel wear and rail wear using an artificial neural network. Nonlinear Autoregressive models with exogenous input neural network (NARXNN) have been developed for wheel and rail wear prediction.

Testing with a twin disc rig, together with measurement of wear using replica material and a profilometer have been carried out for wheel and rail wear under dry, wet and lubricated conditions and after sanding. Tests results from the twin disk rig have been used to train, validate, and test the neural network. Wheel and rail profiles plus load, speed, yaw angle, and first and second derivative of the wheel and rail profiles were used as an inputs to the neural network, while the output of neural network was the wheel wear and rail wear. Accuracy of wheel and rail wear prediction using the neural network was investigated and assessed in term of mean absolute percentage error (MAPE).

The results demonstrate that the neural network can be used efficiently to predict wheel and rail wear. The methods of collecting wear data using the replica material and the profilometer have also proved effective for wheel and rail wear measurements for training and validating the neural network. The laboratory tests have aimed to validate the wear predictions for realistic wheel and rail profiles and materials but they necessarily cover only a limited set of conditions. The next steps for this work will be to test the methods for rail and wheel data from field tests.

**Keywords**— wheel wear, rail wear, replica material, Alicona profilometer, wheel/rail wear prediction, neural network.

## 1. INTRODUCTION

Due to the geometry of the wheel and rail and the non-uniform distribution of normal and tangential forces between them the contact conditions at the wheel-rail interface are complex. Different levels of wear can occur at different points on the wheel and rail and surface [1] and an example showing wear at the tread and flange of a railway wheel is shown in Fig. 1 [2].

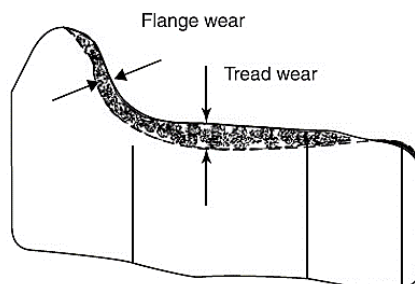

Fig. 1 Wheel wear [1]

Due to the vast length of railway track the cost of replacing worn rails is much greater than that of replacing any other damaged components [2]. Measurement of rail wear during inspection is normally made at three different positions as shown in Fig. 2: W1 is the vertical wear, W2 is the horizontal wear at a vertical distance  $h$ , and W3 is the wear measured at an angle  $\alpha$  from the horizontal [3].

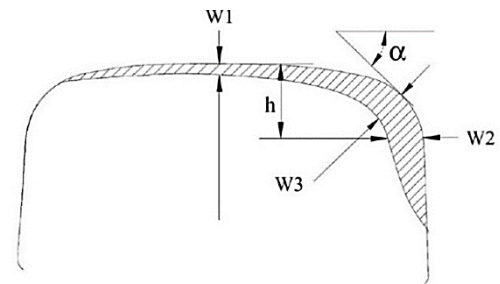

Fig. 2 Rail wear [3]

Wheel wear prediction is a very complicated process which is difficult to predict [4]. Rail maintenance and replacement represent some of the major costs of running a rail network. Rail lifetime is generally determined by two major factors; wear and rolling contact fatigue [5]. The development of wear mechanisms at the wheel and rail contact had been studied by various experimental and numerical methods.

Neural networks and other machine learning techniques have been used in earlier research to predict wheel and rail forces for railway operations [6] and to optimise the design of the railway suspension system [7]. They have also been widely used in railway and other industries for optimising tasks such as scheduling [8], [9] but they have not so far been applied to core engineering problems such as wheel or rail wear. Some relevant work is described below. Laboratory tests such as a twin disc test rig have previously been used to study the wheel and rail wear [10].

Singh et al., [11] used a back propagation neural network (BPNN) to predict drill wear. The inputs to the neural network in this work were thrust force, torque, feed-rate, drill diameter and spindle speed, while the output of the neural network was the flank wear. From the 49 datasets obtained in the experiment, 34 were selected at random for training the network, and the remaining 15 were used for testing the network. The simulation results show that the neural network is able effectively to predict the drill wear.

Huang et al., [12] used a nonlinear autoregressive network with exogenous inputs (NARXNN) based on load prediction to improve scheduling decisions in grid environments. In their paper, the configuration of NARXNN was as follows: input-memory order  $n=3$  and output-memory order  $m=3$ , initial weight of each component of  $W$  is randomly generated in the scope of  $(0, 1)$ , while the sigmoid function was used as an activation function. The data set used to train the NARXNN was collected using a number of entities of a grid including resources, users, brokers, information service, network components. The simulation results show that the NARXNN predictor provides good load prediction.

Kumar and Singh [13] used a backpropagation neural network (BPNN) in the prediction of wear loss quantities of A390 aluminium alloy. A pin-on-disc apparatus was used to perform dry sliding wear tests. The inputs to the neural network were the load, sliding speed and time; while the output of the neural network was mass loss. 45 examples were used to train the neural network. The simulation results show that the neural network results was close to experimental results. They concluded that neural network can be used efficiently for wear prediction.

Khudhair and Talib [14] used a back propagation neural network (BPNN) to predict wear. A pin-on-ring machine was used to study the 13%Cr steel. The inputs to the neural network model were the sliding speed, load, and test time, and the output of the neural network was the wear rate. The simulation results show that the neural network wear was close to actual wear with correlation coefficient of 0.99. The neural network model predictions in this work exhibited good results. They concluded that the neural network can be considered as an excellent tool for wear prediction.

Falomi et al., [15] use two approaches for the detection of the wheel-rail contact points. The first is the semi-analytical approach, which considers the wheel and the rail as two mathematical surfaces whose analytic expression is known. The second approach consists in the application of neural networks. The aim of this approach is to develop a model which is as reliable as the semi-analytical methods, but requiring a lower calculation time, consistent with real-time constraints of multibody simulations. The neural network algorithm is composed of a first part in which, on the basis of the wheelset geometric configuration, the number of contact points is defined. Then the location of the contact points is calculated with feed-forward neural networks. The networks are trained using the results of semi-analytical procedures based on the minimization of the surface defined as the difference between the wheel surface and the rail surface.

Pit [2], used a neural network for rail wear prediction. He studied experimentally the wear behaviour of carbide-free bainitic rails. Neural network modelling was carried out on the data received from the British Steel Swinden Technology Center in an attempt to produce a useful empirical model for rail wear prediction. The inputs to the neural network were rail hardness, rail microstructure, wheel hardness, wheel microstructure, Charpy fracture energy, and contact stress. The output of the neural network was the rail wear rate. British Steel Swinden Technology

Center provided rail/wheel wear rate, hardness and Charpy fracture energy. A microstructure parameter was used as an input to indicate whether each roller was pearlitic or bainitic; a pearlitic given value of zero and a bainitic given value of one. The author concluded that it is difficult to develop a model for rail wear prediction, the neural network was not successful as there was not enough data for a reliable model to be generated, but a small amount of data showed promising results.

## 2. ARTIFICIAL NEURAL NETWORKS (ANN)

Artificial neural networks (ANNs) are currently used to solve a wide range of complex engineering problems. An ANN has the ability to learn by example, consequently, it is very useful for simulations of any correlation that is difficult to describe with physical models or other mathematical approaches [14]. Though perfect prediction is seldom possible, neural networks can be used to make reasonably good predictions in a number of cases. In particular, feedforward neural networks have been used frequently in this respect [16]. ANNs have been used to predict the wear behaviour of materials [17].

In a feedforward neural network, the information is passed from the inputs of the network to the outputs without feedback between output layer and input layer. Fig. 3 shows a feedforward neural network with a single hidden layer. A feedforward neural network can consist of more than one hidden layer [18], [19]. Increasingly, feed-forward neural networks have been used in many areas; for instance, prediction in non-linear systems [19], [20].

In the work reported here, Nonlinear Autoregressive models with exogenous input neural network (NARXNN) have been developed to predict wheel and rail wear under different contact conditions.

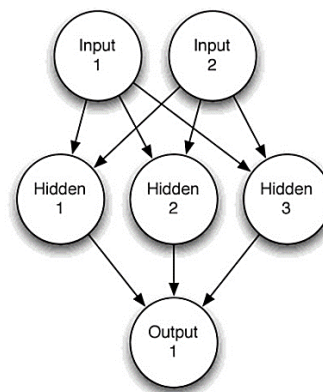

Fig. 3 Feedforward neural network [19]

Training of an artificial neural network is a process in which the neural network adjusts its weights. In this process, the actual output response converges to the desired output response until they effectively merge. The ANN is then considered to have completed the training phase. Training algorithms can be categorised into supervised training and unsupervised training [21].

Most ANNs are trained using supervised training methods. Supervised training needs an input vector and a target vector. During the training session the input vector is applied to the network, and a resulting output vector is produced. This response is compared with the target response. When the actual response differs from the target response, the network will generate an error signal. This error signal is then used to update the weights to ensure that the actual output matches the target output. The error minimisation in this type of training requires a supervisor or a teacher; hence, the name ‘supervised training’ [21].

The NARXNN can be implemented using a feedforward neural network such as shown in Fig. 4 [22]. This network simply uses a tapped delay line (TDL) with a feedback connection from the output of the network to the input [12]. The NARXNN is a recurrent dynamic network, with feedback connections enclosing several layers of the network [23].

Some important qualities about NARXNN with gradient-descending learning gradient algorithm such as the learning is more effective in NARXNN than in other neural network (the gradient descent is better in NARXNN), and the NARXNN converge much faster and generalize better than other networks [22].

The NARXNN was used in this work for wheel/rail wear prediction because the NARXNN has fast coverage, the output of NARXNN is fed back to the input of the feedforward neural network as part of the NARXNN architecture which led to more accurate training phase, and the NARXNN can be used to predict wear in case of new samples without retrain the network.

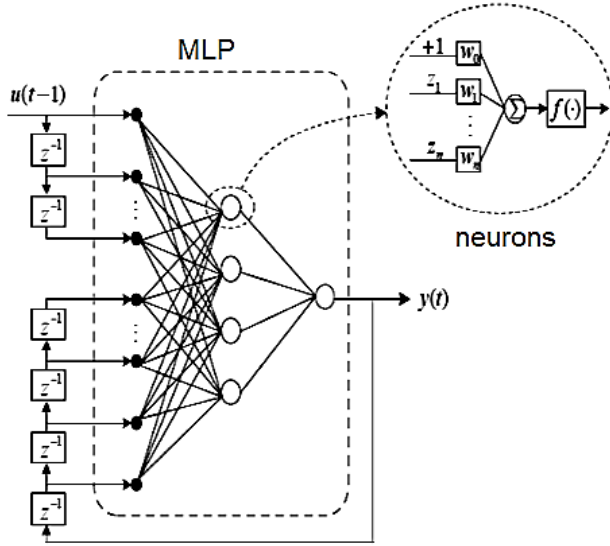

Fig. 4 The structure of NARXNN [22], [12]

The output of the NARXNN is represented using the following equation:

$$y(t) = f(u(t-1), u(t-2), \dots, u(t-n), y(t-1), y(t-2), \dots, y(t-m), W). \quad (1)$$

Where  $u(t)$  and  $y(t)$  represent the input and output of the network respectively,  $n$  and  $m$  are the input-memory order and output-memory order respectively,  $W$  is a matrix of weights, and  $f$  is a nonlinear function. The output at time  $t$  depends on its past  $m$  values as well as the past  $n$  values of the input.

The architecture of the NARXNN can be in parallel or series-parallel as shown in Fig. 5. In the parallel architecture arrangement the output of the NARXNN is fed back to the input of the neural network. This has some advantages such as the input to the feedforward network is more accurate. Where  $u(t)$  is the input,  $y(t)$  is the desired output, and  $\hat{y}(t)$  is the estimated output.

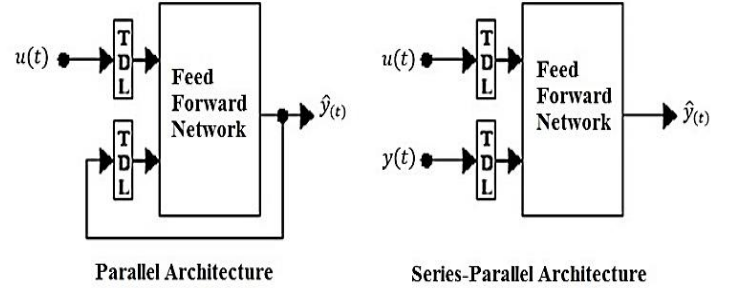
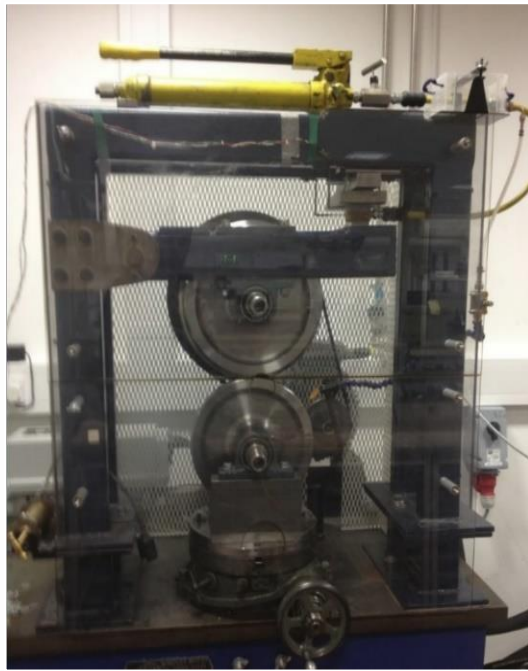

Fig. 5 Parallel and series-parallel architecture of NARXNN [23]

Both the series-parallel architecture and the parallel architecture of the NARXNN were used in this work for wheel/rail wear prediction. The Matlab ANN Toolbox function (closloop) was used to convert the NARXNN from the series-parallel structure (open loop) to the parallel structure (closed loop) to allow multi-step-ahead prediction (wheel/rail wear prediction in case of a new samples). The training of neural networks was carried out with an open loop which called the series-parallel architecture including the validation and testing. After that, the parallel architecture was used to execute the multistep-ahead prediction [24], [25].

### 3. WHEEL/RAIL WEAR MEASUREMENTS

The twin disc machine, together with replica material, and an Alicona profilometer were used in this paper for wheel/rail wear measurements. The data obtained in these tests was used to train, validate, and test the neural networks. The twin disc rig shown in Fig. 6 and Fig.7 consists of an upper steel wheel of 310mm diameter, and a lower steel wheel with a diameter of 290mm. The rollers and shafts are made of EN24T steel. A vertical force of up to 4kN can be applied to the two wheels using a jacking mechanism. The rig consists of a rotary table to allow a relative yaw angle between the wheels to be precisely set. A three phase motor is used to rotate the wheel roller at varying speeds, using a corresponding three phase inverter [26].



**Fig. 6 The University of Huddersfield twin disc test rig**

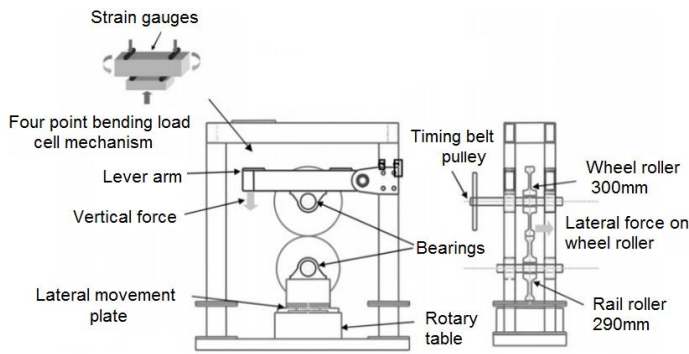

**Fig. 7 Schematic of the University of Huddersfield twin disc rig [26]**

Table (1) shows the technical details of the wheel and rail roller for the University of Huddersfield twin disc rig.

Parameters	Wheel roller	Rail roller
Profile	Standard UK wheel profile P8	BS 113A rail profile
Scale	1/3	1/3
Diameter	310 mm	290 mm
Thickness	50mm	25mm
Material	EN24T steel	EN24T steel

**Table 1 Technical details of the wheel and rail roller - University of Huddersfield**

The Alicona profilometer (INFINITE FOCUS G4) which is shown in Fig. 8 was used in this work for wheel/rail wear measurements.

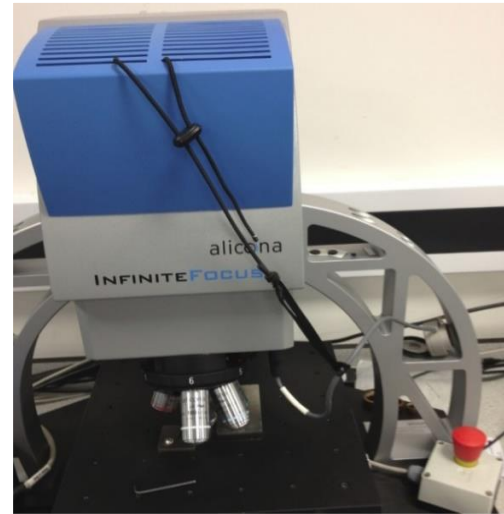

**Fig. 8 Alicona (INFINITE FOCUS G4) - University of Huddersfield**

The Alicona microscope has a motorized stage that moves in the xy direction, while the microscope objective moves in the z direction. It is non-contact microscope. The objectives has range from 2.5x - 100x magnification and has a vertical resolution of up to 10 nm at 100x magnification [27].

Table (2) shows the technical specifications of the Alicona profilometer which was used in this paper for wear measurement.

Measurement principle	Non-contact, optical.
Travel range X/Y/Z	100 mm x100 mm x100mm
Maximum measurable area	10000mm <sup>2</sup>
Maximum measurable profile length	100mm
Min. repeatability	0.001µm - 0.12µm
Vertical resolution	1µm
Maximum measurable slope angle	Up to 87 <sup>0</sup>

**Table 2 Technical specifications of Alicona profilometer [28], [29]**

The twin disc rig was used in this work to reflect some conditions of the real wheel/rail interface. Replica material together with an Alicona profilometer were used for wheel and rail wear measurements using the twin disc rig. Fig. 9 shows a sample of replica material for the wheel and rail surfaces; and after it had been removed.

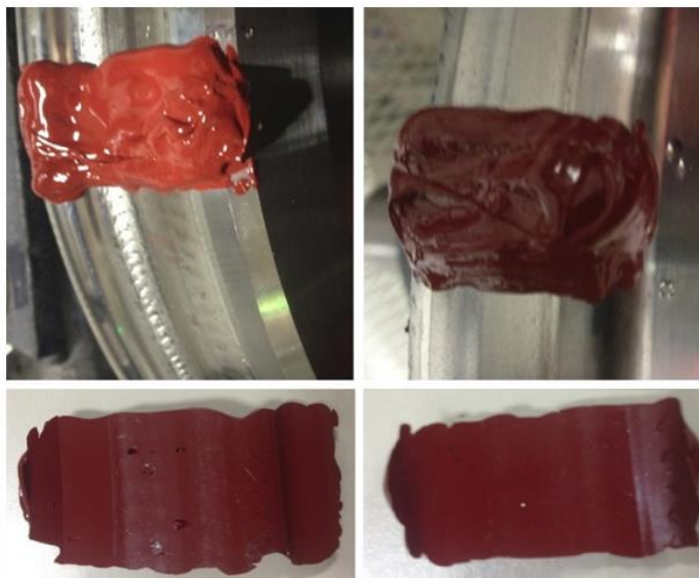

**Fig. 9 Sample of replica material on the wheel and rail surfaces; and after removal**

In this paper, the wheel and rail wear were measured using the Alicona profilometer using the Difference Measurements Module. The wear was measured by taking a digital image of the wheel and rail surfaces before the test and saving it as a reference 1, and taking another image of the wheel and rail surfaces after the test and saving it as a reference 2; then, the Difference Measurements Module in Alicona software was used to compute the wheel and rail wear in term of volume loss per unit area ( $\text{mm}^3/\text{mm}^2$ ) [30].

#### 4. NARXNN MODEL FOR WHEEL/RAIL WEAR PREDICTION

The neural networks are divided in terms of their structure into two types: feedforward network and recurrent network [31]. In feedforward neural networks the information flows in one direction without feedback (loops). The information travelled from the inputs to the outputs, and without feedback between output layer and input layer. The feedforward neural network can consists of more than one hidden layer [18], [19]. In recurrent neural network the information can a flow in forward direction and a backward direction (it contain feedback connections), the outputs of neurons can feedback to the same neurons or to neurons in previous layers [32].

The type of neural network was used in this work for prediction of wheel wear and rail wear is the recurrent neural network, it is a Nonlinear Autoregressive model with eXogenous input neural network (NARXNN). The advantages of the NARXNN are that it has fast training and the output of NARXNN is feedback to the input of the feedforward neural network so that the network output is available during the training of the NARXNN and more

efficient inputs can be used for training of neural network, this can lead to more accurate results.

In this work a neural network model for predicting wheel and rail wear was developed within Matlab as illustrated in Fig. 10.

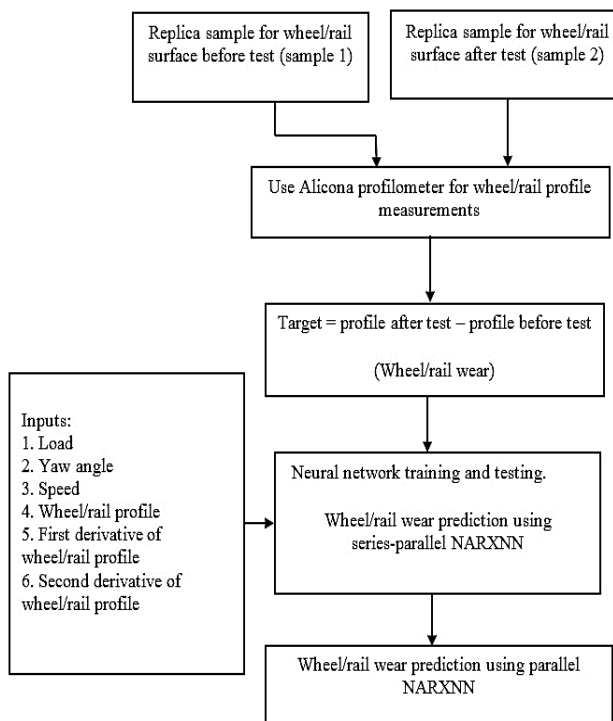

**Fig. 10 NARXNN model for wheel and rail wear prediction**

Training, validation, and testing process for the NARXNN is outlined in the following section. The neural network model shown in Fig. 10 was used for rail and wheel wear prediction. The dataset which was used for training, validation, and testing of the NARXNN was prepared using the twin disc rig tests as described above.

The inputs to the NARXNN were: load, yaw angle, speed, wheel/rail profile, first derivative of wheel/rail profile, and second derivative of wheel/rail profile; while the output of neural network was the wheel/rail wear.

The series-parallel NARXXNN and the parallel NARXNN were used to predict the wheel and rail wear such as in the following sections.

For wheel/rail wear prediction using the series-parallel NARXNN, the following cases were used to validate, train, and test the NARXNN: The vertical load was 1200N, 1400N, and 1600N; the yaw angle was 0.2 degree, 0.3 degree, and 0.4 degree; and the speed was 420rpm, 540rpm, and 660rpm. 261 samples were collected. In this test, the dataset was divided into 70% used for training (seen data), 15% used for validation, and 15% used for testing of the neural network (unseen input data). Wheel/rail wear prediction was carried out using a series-parallel network [24], [25], [33] such as shown in Fig. 11. The input delays were equal to 1:2, feedback delays was equal to 1:2, and 1 hidden layer with 10 neurons were used.

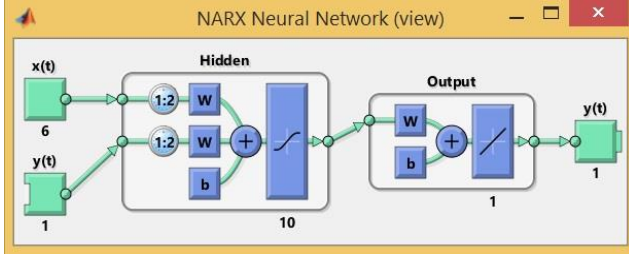

Fig. 11 Series-parallel network (NARXNN)

A logistic function was used as an activation functions of the neurons in the hidden layers such as shown in the following equation [34].

$$\text{logsig}(x) = (1 + (x))^{-1} \quad (2)$$

The performance function used in the training of the NARXNN was the mean square error (MSE), it is used reduce the error between actual output and estimated output such as in the following equation [22].

$$\text{MSE} = \frac{1}{N} \sum_{i=1}^N (e_i)^2 = \frac{1}{N} \sum_{i=1}^N (t_i - y_i)^2 \quad (3)$$

Where  $t_i$  the target is output and  $y_i$  is the estimated output.

## 5. SELECTION OF THE TRAINING ALGORITHM

The accuracy of wheel/rail wear prediction using neural network is dependent on the training method that we use, in recurrent neural network there are several training algorithms can be used, and these were evaluated prior to selection. The Levenberg-Marquardt algorithm was used as a network training function that updates the weight and bias values. It was implemented in Matlab and the training was continued until the validation error failed to decrease for six iterations (validation stop). The Levenberg-Marquardt algorithm has the fastest convergence for this type of network and this advantage is especially noticeable if very accurate training is required. In the Matlab toolbox, there are three algorithms that can be used to train the neural network. These are: Levenberg-Marquardt (trainlm); Bayesian Regularization (trainbr); and Scaled Conjugate Gradient (trainscg). In order to establish the best training algorithm for this work several tests were carried out to predict the wheel/rail wear

using these three training algorithms. The best result was obtained using the Levenberg-Marquardt algorithm. This was then used for all subsequent training.

The Levenberg-Marquardt algorithm blends the steepest descent method and the Gauss-Newton algorithm. It inherits the speed advantage of the Gauss-Newton algorithm and the stability of the steepest descent method and is more robust than the Gauss-Newton algorithm, because in many cases it can converge well even if the error surface is much more complex than the quadratic situation. Although the Levenberg-Marquardt algorithm tends to be slower than Gauss-Newton algorithm (in convergent situations), it converges much faster than the steepest descent method. The basic idea of the Levenberg-Marquardt algorithm is that it performs a combined training process: around the area with complex curvature, the Levenberg-Marquardt algorithm switches to the steepest descent algorithm, until the local curvature is proper to make a quadratic approximation; then it approximately becomes the Gauss-Newton algorithm, which can speed up the convergence significantly [35].

The Mean absolute percentage error (MAPE) was used to calculate the NARXNN accuracy. The mean absolute percentage error is shown in the following equation [35] :

$$\text{MAPE} = \frac{1}{N} \sum_{i=1}^N \frac{|A_i - P_i|}{A_i} \times 100 \quad (4)$$

Where  $A_i$  is the actual output,  $P_i$  is the predicted output,  $i$  is time period, and  $N$  is the number of time periods (number of observed values).

Wheel/rail wear was predicted using the parallel NARXNN. This test was carried out in order to perform the multi-step-ahead prediction task (predict wheel and rail wear in case of new samples without retraining the network). The series-parallel architecture which was shown in Fig. 11 was converted into a parallel architecture using a Matlab program such as shown in Fig. 12 [24]. In this test, the load was 1800N, the yaw angle was 0.5 degree, and the speed was 780rpm. 87 samples were used for wheel and rail wear prediction (unseen input data). The MAPE was again used to calculate the NARXNN model accuracy and was calculated using equation (4).

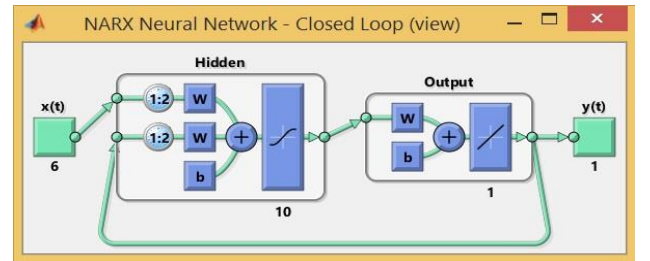

Fig. 12 Parallel network (NARXNN)

## 6. WHEEL/RAIL WEAR PREDICTION USING NARXNN

The developed NARXNN was used to predict wheel and rail wear for the twin disc rig experiments under dry, wet, lubricated, and sanded conditions such as shown in the following sections.

### A. Wheel/rail wear under dry conditions

The actual and predicted wheel wear using the series-parallel NARXNN are illustrated in Fig. 13.

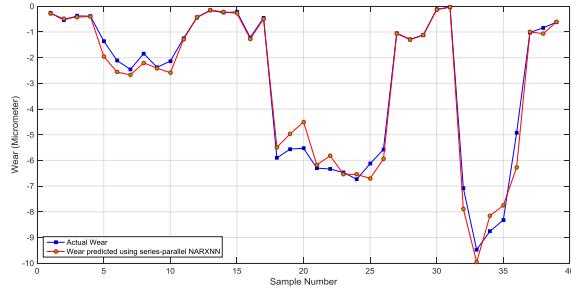

**Fig. 13 Actual and predicted wheel wear using series-parallel NARXNN under dry conditions (based on unseen input data)**

The actual and predicted wheel wear using the parallel NARXNN were provided in Fig.14

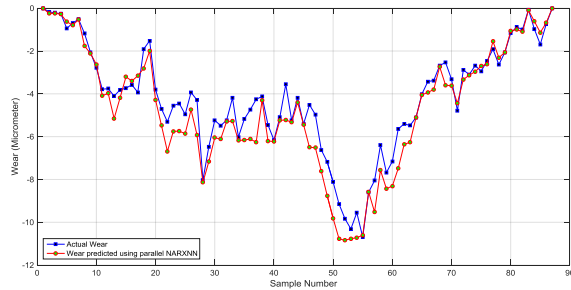

**Fig. 14 Actual and predicted wheel wear using parallel NARXNN under dry conditions (based on unseen input data)**

The actual and predicted rail wear using the series-parallel NARXNN are shown in Fig. 15.

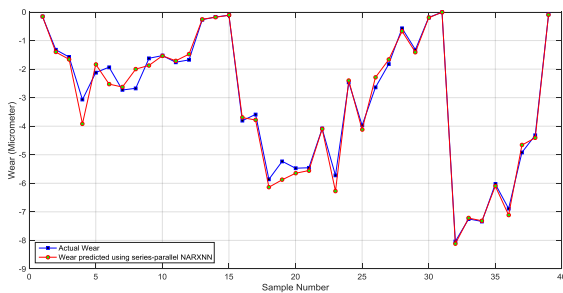

**Fig. 15 Actual and predicted rail wear using series-parallel NARXNN under dry conditions (based on unseen input data)**

The actual and predicted rail wear using the parallel NARXNN are shown in Fig. 16

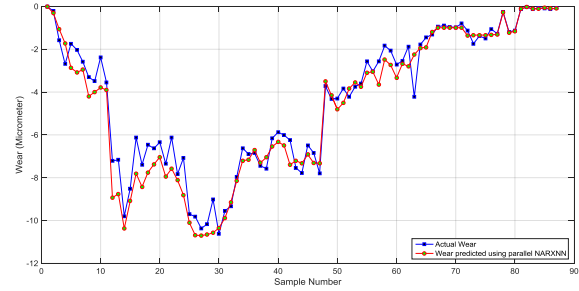
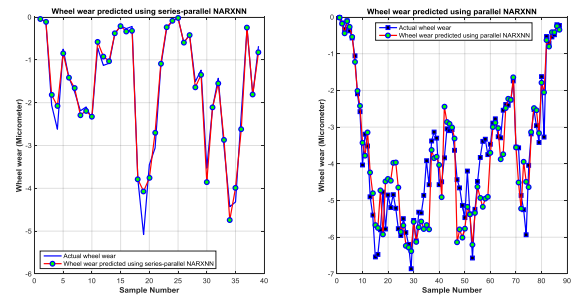

**Fig. 16 Actual and predicted rail wear using parallel NARXNN under dry conditions (Unseen data)**

In the following sections, the left graphs show the actual and predicted wheel wear using the series-parallel NARXNN; while the right graphs show the actual and predicted wheel wear using the parallel NARXNN.

### B. Wheel/rail wear under wet conditions

The actual and predicted wheel wear using series-parallel and parallel NARXNN are presented in Fig. 17.



**Fig. 17 Actual and predicted wheel wear using series-parallel and parallel NARXNN under wet conditions (Unseen data)**

The actual and predicted rail wear using series-parallel and parallel NARXNN are presented in Fig. 18.

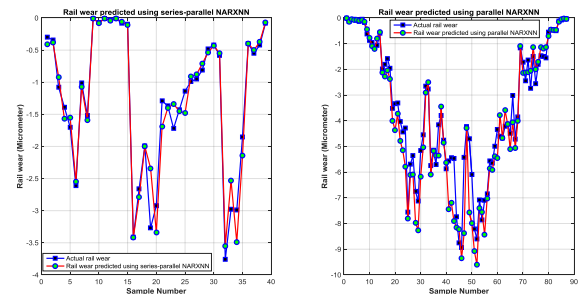
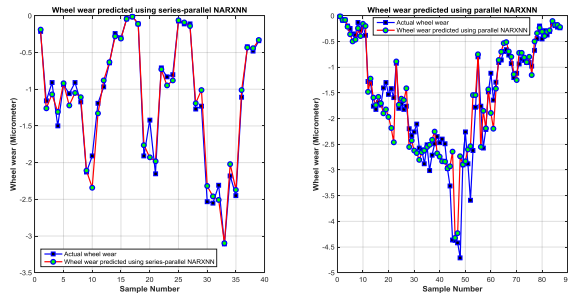

**Fig. 18 Actual and predicted rail wear using series-parallel and parallel NARXNN under wet conditions (based on unseen input data)**



### C. Wheel/rail wear under lubricated conditions

The actual and predicted wheel wear using series-parallel and parallel NARXNN are presented in Fig. 19.



**Fig. 19 Actual and predicted wheel wear using series-parallel and parallel NARXNN under lubricated conditions (based on unseen input data)**

The actual and predicted rail wear using series-parallel and parallel NARXNN are presented in Fig. 20.

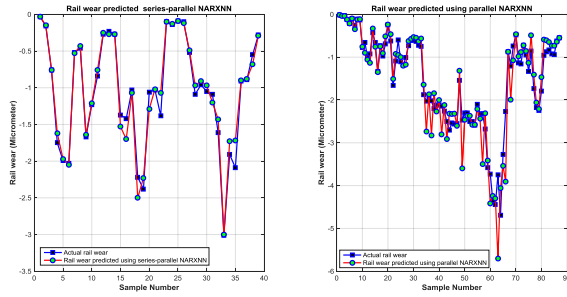

**Fig. 20 Actual and predicted rail wear using NARXNN under lubricated conditions (based on unseen input data)**

### D. Wheel/rail wear under sanded conditions

The actual and predicted rail wear using series-parallel and parallel NARXNN are presented in Fig. 21.

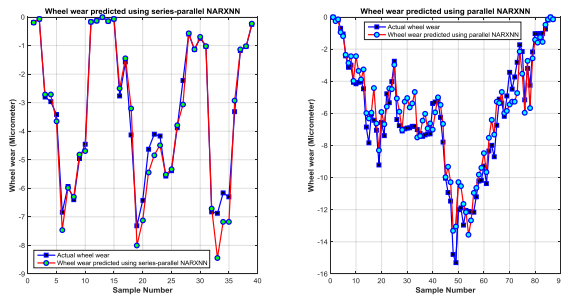

**Fig. 21 Actual and predicted wheel wear using series-parallel and parallel NARXNN under sanded conditions (based on unseen input data)**

The actual and predicted rail wear using series-parallel and parallel NARXNN are presented in Fig. 22.

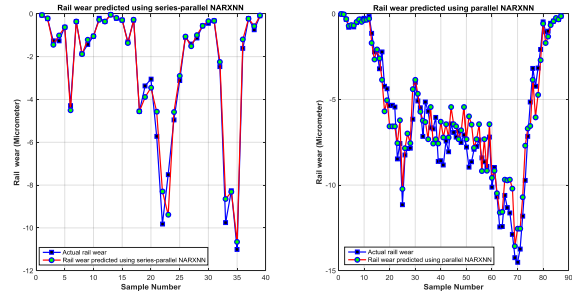

**Fig. 22 Actual and predicted rail wear using series-parallel and parallel NARXNN under sanded conditions (based on unseen input data)**

### E. Section discussion

The mean absolute percentage error (MAPE) between the actual and predicted wheel and rail wear are summarised in Table (3) and Table (4) respectively.

	Dry	Wet	Lubricated	Sanded
MAPE% for series-parallel NARXNN	8.58%	8.54%	8.94%	6.63%
MAPE% for parallel NARXNN	16.93%	14.46%	18.63%	17.49%

**Table 3 MAPE for wheel wear prediction using series-parallel and parallel NARXNN (for unseen input data)**

	Dry	Wet	Lubricated	Sanded
MAPE% for series-parallel NARXNN	7.17%	11.37%	7.54%	9.54%
MAPE% for parallel NARXNN	16.01%	15.31%	15.87%	15.95%

**Table 4 MAPE for rail wear prediction using series-parallel and parallel NARXNN (for unseen input data)**

The percentage error for wheel wear prediction was calculated, and the results show good prediction of wheel and rail wear in term of percentage of error, where the wheel and rail predicted using the NARXNN predicted wear was close to actual wheel and rail wear.

The MAPE was between 6.63% and 11.37% for the series-parallel NARXNN (using unseen input data); then, the accuracy of the NARXNN model was between 88.63% and 93.37%.

The MAPE was between 14.46% and 18.63% for the parallel NARXNN (using unseen input data); then, the accuracy of the NARXNN model was between 81.37% and 85.54%.

Therefore, the accuracy of the NARXNN model was between 81.37% and 93.37% (for unseen input data).

The optimal results during training and testing of the neural network was obtained with input delays were 1:2, feedback delay 1:2, and 1 hidden layer with 10 neurons.

The results show that the wear experienced at a wheel and a rail under laboratory conditions can be predicted using a neural network. It is recognised however that the laboratory tests do not cover all of the possible wear mechanisms encountered in real railway operations. Key variations in load, yaw angle and friction coefficients have been included but there are clearly other factors such as dynamic variations in load and position and a wide range of geometry variations that have not been included in these tests. Although validation has been carried out against laboratory tests using a twin disk rig and computer simulations of railway vehicles running on track it is recognised that further validation is required to establish the effectiveness of the methods proposed when real variations in all parameters are included. It is proposed that simultaneous simulations and measurements are carried out on wheels for vehicles running on main line track. Measured track irregularities and wheel and rail profiles will be included and the vehicle will be modelled in as much detail as possible. Wheel wear will be established using the replica material and profilometer methods presented in this paper and compared with the results from the Neural Network techniques.

#### 7. NEURAL NETWORK ARCHITECTURE SELECTION

To establish the best neural network architecture for this work a series of simulations with different architectures were evaluated. The wheel/rail wear predicted using the three NARXNN architecture were compared with the actual wheel/rail wear were:

- 6-7-1 (6 inputs, 7 hidden layer, and 1 output layer).
- 6-10-1 (6 inputs, 10 hidden layer, and 1 output layer).
- 6-13-1 (6 inputs, 13 hidden layer, and 1 output layer).

The accuracy of wheel/rail wear prediction using NARXNN was investigated and assessed in term of MAPE such as:

The MAPE for series-parallel NARXNN (6-10-1) was 8.58%, it was smaller than the MAPE for the series-parallel NARXNN (6-7-1) and series-parallel NARXNN (6-13-1). Therefore, the series-parallel NARXNN (6-10-1) was more accurate than the series-parallel NARXNN (6-7-1) and series-parallel NARXNN (6-13-1) for wheel wear prediction.

The MAPE for parallel NARXNN (6-10-1) was 7.17%, it was smaller than the MAPE for the parallel NARXNN (6-7-1) and parallel NARXNN (6-13-1). Therefore, the parallel NARXNN (6-10-1) was more accurate than the parallel NARXNN (6-7-1) and parallel NARXNN (6-13-1) for rail wear prediction.

For learning purposes, a dynamic back-propagation algorithm is required to compute the gradients, which is more computationally intensive than static back-propagation and takes more time. In addition, the error surfaces for dynamic networks can be more complex than those for static networks. Training is more likely to be trapped in local minima. For NARX neural network model the typical performance function used in training is MSE. In this paper, the network training function that updates the weight and bias values according to Levenberg-Marquardt algorithm (LM) because it has the fastest convergence. This advantage is especially noticeable if very accurate training is required. However, as the number of weights in the network increases, the advantage of this algorithm decreases. Other training algorithms were tested, but with a less good result. The neural network training was more efficient after certain preprocessing steps on the network inputs and targets are performed. The normalization of the input and target values mean to mapping them into the interval [-1, 1]. Where, the Matlab toolbox normalized the data set automatically.

#### 8. CONCLUSIONS

The University of Huddersfield twin disc test rig together with a replica technique and an Alicona profilometer were used for wheel wear and rail wear measurements. The replica material and Alicona profilometer were shown to be effective tools for the wheel wear and rail wear measurements.

In this paper, a Nonlinear Autoregressive models with exogenous input neural network (NARXNN) was developed to predict wheel wear and rail wear for the twin disc rig experiments under differ conditions such as dry, wet, lubricated, and sanded conditions. Both series-parallel and parallel NARXNN architectures were used for wheel/rail wear prediction. Results show that the wheel and rail wear predicted using the NARXNN were close to actual wear for unseen input data under dry, wet, lubricated, and sanded conditions. The findings obtained using the proposed neural approach yielded better results from the perspective of the mean absolute percentage error (MAPE) measure. The accuracy of the NARXNN model was between 81.37% and 93.37% (for unseen input data). Therefore, it can be concluded that an artificial neural network can be used efficiently as a predictor of wheel wear and rail wear.

The use of different neural network architectures has demonstrated that the accuracy of the wheel/rail wear prediction using a neural network is influenced by the specific architecture. In particular the parallel NARXNN (6-10-1) was shown to be more accurate than the parallel NARXNN (6-7-1) and parallel NARXNN (6-13-1).

This paper has demonstrated that the neural network can be a powerful tool for wheel and rail wear prediction. In this way the specific scientific challenges of applying computer learning techniques to the key engineering challenges of predicting wear at the critical interface between a railway wheel and rail has been addressed. Although the parameter variations considered have been a limited set of those encountered in the field, the laboratory tests and computer simulations have attempted to include the key factors influencing wheel and rail wear and the results show that there is significant potential in the methods presented.

The major contribution to knowledge of this work is outlined below:

- a. Neural network architecture: a nonlinear autoregressive model with exogenous input neural network (NARXNN) in series-parallel and parallel architecture were developed to predict the wheel and rail wear for a twin disc test rig experiments.
- b. Neural network inputs: the inputs to the neural network that are required to provide effective prediction of wheel/rail wear have been established. These include load, yaw angle, speed, wheel/rail profile, and first/second derivative of wheel/rail profile.
- c. Neural network parameters: the effect of various key neural network parameters on the ability to predict wheel/rail wear have been established. The effect on the accuracy of wheel/rail wear prediction of the correct selection of neural network parameters has been established.

The main scientific contribution of this work has been to establish and validate a method for prediction of railway wheel and rail wear using a neural network. The major conclusion in this paper is that a properly designed neural network together with appropriately chosen inputs can predict wheel wear and rail wear successfully. Laboratory test methods have been established to measure the wear under realistic wheel-rail contact conditions on a test rig and measurements of resulting wear. This has allowed the appropriate selection, development and training of the Neural Network architecture.

The next steps for this work will be to test the methods presented in this paper using field data. A successful wheel/rail, wear prediction tool could be used by railway operators in understanding remaining life of wheels or rails and in planning of maintenance interventions. It could therefore form part of a predictive maintenance strategy for reducing costs and improving reliability.

#### REFERENCES

- [1] S. Iwnicki, *Handbook of railway vehicle dynamics*: CRC press, 2006.
- [2] C. E. Pit, "Wear and microstructure relationships in Carbide-Free Bainitic rail steels " PhD, Cambridge University, UK, UK, 1999.
- [3] P. Waara, "Lubricant influence on flange wear in sharp railroad curves," *Industrial lubrication and tribology*, vol. 53, pp. 161-168, 2001.
- [4] X. Z. Z. W. G. Tao, X. Jin, "Effects of Wheel-Rail Contact Modelling on Wheel Wear Simulation," *Wear*, 2016.
- [5] S. Lewis, S. Fretwell-Smith, P. Goodwin, L. Smith, R. Lewis, M. Aslam, *et al.*, "Improving Rail Wear and RCF Performance using Laser Cladding," *Wear*, 2016.
- [6] H. Parkinson and S. D. Iwnicki, "An intelligent track monitoring system," *Infrastructure Maintenance & Renewal*, 1999.
- [7] I. Persson and S. Iwnicki, "Optimisation of railway wheel profiles using a genetic algorithm," *Vehicle System Dynamics*, vol. 41, pp. 517-526, 2004.
- [8] S. V. K. Nachtigall, "A genetic algorithm approach to periodic railway synchronization, Computers & Operations Research," *Elsevier*, vol. Math. 30,173-189 (1990). , 1996.
- [9] P. B. a. J. Hurink, "A railway scheduling problem," vol. Z., *Opns Res.* A223-A227 (1986), 1986.
- [10] L. Ma, C. He, X. Zhao, J. Guo, Y. Zhu, W. Wang, *et al.*, "Study on wear and rolling contact fatigue behaviors of wheel/rail materials under different slip ratio conditions," *Wear*, 2016.
- [11] A. Singh, S. Panda, D. Chakraborty, and S. Pal, "Predicting drill wear using an artificial neural network," *The International Journal of Advanced Manufacturing Technology*, vol. 28, pp. 456-462, 2006.
- [12] J. Huang, H. Jin, X. Xie, and Q. Zhang, "Using NARX neural network based load prediction to improve scheduling decision in grid environments," in *Natural Computation, 2007. ICNC 2007. Third International Conference on*, 2007, pp. 718-724.
- [13] A. J. P. Kumar and D. K. J. Singh, "Artificial neural network-based wear loss prediction for a390 aluminium alloy," *J. Theor. Appl. Inf. Technol.*, pp. 961-964, 2008.
- [14] A. Khudhair and N. A. Talib, "Neural Network Analysis For Sliding Wear of 13% Cr Steel Coatings by Electric Arc Spraying," in *Diyala Journal of Engineering Sciences-First Engineering Scientific Conference, College of Engineering–University of Diyala*, 2010, pp. 157-169.
- [15] S. Falomi, M. Malvezzi, E. Meli and A. Rindi, "Determination of wheel – rail contact points: comparison between classical and neural network based procedures" *Meccanica*, 44, 6, pp. 661 – 686, 2009
- [16] K. Mehrotra, C. K. Mohan, and S. Ranka, *Elements of artificial neural networks*: MIT press, 1997.
- [17] A. Fathy and A. Megahed, "Prediction of abrasive wear rate of in situ Cu–Al<sub>2</sub>O<sub>3</sub> nanocomposite using artificial neural networks," *The International Journal of Advanced Manufacturing Technology*, vol. 62, pp. 953-963, 2012.
- [18] J. Heaton, *Introduction to neural networks with Java*: Heaton Research, Inc., 2008.
- [19] C. R. Tosh and G. D. Ruxton, *Modelling perception with artificial neural networks*: Cambridge University Press, 2010.
- [20] D. W. Patterson, *Artificial neural networks*. USA: Simon & Schuster 1996.
- [21] M. Sivanandam, *Introduction to artificial neural networks*: vikas publishing House PVT LTD, 2009.
- [22] E. Diaconescu, "The use of NARX neural networks to predict chaotic time series," *WSEAS Transactions on Computer Research*, vol. 3, pp. 182-191, 2008.
- [23] Mathworks, "Design Time Series NARX Feedback Neural Networks " in *Matlab help*, ed, 2015.
- [24] Mathworks, "Multistep Neural Network Prediction," in *Matlab help*, ed, 2015.
- [25] Mathworks, "Modeling and Prediction with NARX and Time-Delay Networks," in *Matlab help*, ed, 2015.
- [26] S. S. Hsu, Z. Huang, S. D. Iwnicki, D. J. Thompson, C. J. Jones, G. Xie, *et al.*, "Experimental and theoretical investigation of railway wheel squeal," *Proceedings of the Institution of Mechanical Engineers, Part F:*

- Journal of Rail and Rapid Transit*, vol. 221, pp. 59-73, 2007.
- [27] D. A. Macdonald, "The application of focus variation microscopy for lithic use-wear quantification," *Journal of Archaeological Science*, vol. 48, pp. 26-33, 2014.
- [28] Alicona. Alicona InfiniteFocus Specification, Alicona, 2016,  
[http://www.alicon.com/home/fileadmin/alicon/pdfs/InfiniteFocusG5\\_System\\_and\\_technical\\_specification\\_E.pdf](http://www.alicon.com/home/fileadmin/alicon/pdfs/InfiniteFocusG5_System_and_technical_specification_E.pdf) [Online].
- [29] M. Tailor, "Automatic surface defect quantification in 3D," © Mitulkumar J. Tailor, 2013.
- [30] Alicona, *Optical 3D micro coordinate measurement from & roughness* vol. Version 3.9.1 EN, 2011.
- [31] A. Zalzal and X. Liu, "Neural Networks for Identification, Prediction and Control," ed: Great Britain: Springer-Verlag London Limited, 1995.
- [32] G. Mihalakakou, M. Santamouris, and D. Asimakopoulos, "Modeling ambient air temperature time series using neural networks," *Journal of Geophysical Research: Atmospheres (1984–2012)*, vol. 103, pp. 19509-19517, 1998.
- [33] Mathworks, "Neural Network Time Series Prediction and Modeling," in *Matlab help*, ed, 2015.
- [34] C. Cătălina-Lucia and G. Hakob, "An Artificial Neural Network for Data Forecasting Purposes," *Informatica Economica*, vol. 19, 2015.
- [35] Hao Yu, Bogdan M. Wilamowski, "Levenberg–Marquardt training", Auburn University, K10149\_C012.indd, 2010.
- [36] B. Mahadevan, *Operations management: Theory and practice*: Pearson Education India, 2010.