

LEAD ARTICLE

J. Appl. Cryst. (1997), **30**, 211–237

Macromolecular Cryocrystallography

ELSPETH F. GARMAN^a AND THOMAS R. SCHNEIDER^{bc}

^aLaboratory of Molecular Biophysics, University of Oxford, Oxford OX1 3QU, England, ^bEuropean Molecular Biology Laboratory (EMBL), c/o DESY, Notkestrasse 85, 22603 Hamburg, Germany, and ^cMax-Planck-Institute for Molecular Physiology, Rheinlanddamm 201, 44139 Dortmund, Germany. E-mail: elspeth@biop.ox.ac.uk

(Received 3 August 1996; accepted 10 February 1997)

Abstract

The current techniques for X-ray-diffraction data collection from macromolecular crystals at cryogenic temperatures are reviewed. The development of the experimental methods is outlined and the basic concepts pertaining to radiation damage and cryoprotection are summarized. Emphasis is placed on the practical aspects important to the success of the techniques, and a detailed account of these is presented.

1. Introduction

Currently, the proportion of X-ray diffraction experiments in macromolecular crystallography carried out at cryogenic temperatures is increasing exponentially. The beginning of this trend is indicated by an analysis of the temperatures reported for structure determinations in the

years 1990 to 1995 (Fig. 1). At present, cryogenic techniques are used routinely in many laboratories for data collection on in-house facilities as well as on synchrotron sources [e.g. 78% of all beam-time proposals for 1996 submitted to the EMBL Outstation (DESY, Hamburg) requested cryogenic facilities (Frost & Canella, 1996)]. The future will certainly see a continuation of this trend as more researchers become aware of the great advantages of collecting data below 120 K.

What are these advantages for the macromolecular crystallographer? The most far-reaching is the great reduction in X-ray-induced radiation damage to macromolecular crystals that is observed at low temperatures (Figs. 2 and 3), and this factor has been the main impetus for the development of cryogenic techniques. In contrast to most small-molecule crystals, macromolecular crystals can be very susceptible to radiative destruction owing to the presence of large amounts of water and the

Elspeth Garman works as a University Research Lecturer in the Laboratory of Molecular Biophysics, University of Oxford, England. She obtained a BSc in Physics at Durham University and then a Doctorate in Experimental Nuclear Physics at Oxford University in 1980. After working as a Research Officer in the Nuclear Physics Department at Oxford, she moved to Molecular Biophysics in 1987. Her main research interest is the development and optimization of data-collection techniques for macromolecular crystallography.

Thomas Schneider studied Physics at the University of Münster, Yale University and the Technical University of Munich and received his Diplom-Physiker degree in 1991. He then held an EMBL predoctoral fellowship to pursue his doctoral studies at the Hamburg Outstation of the European Molecular Biology Laboratory under the joint supervision of Professor K. S. Wilson and Professor F. Parak and received his doctoral degree in 1996 from the Technical University of Munich. Currently he is a postdoctoral worker at the Max-Planck-Institute for Molecular Physiology in Dortmund, Germany. His research interests are proteins and methods of studying their structure and dynamics.

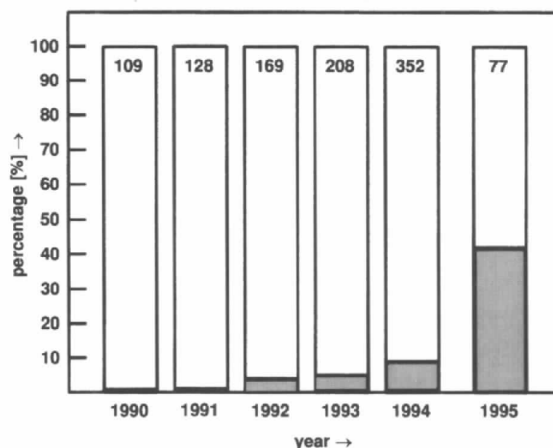

Fig. 1. The percentage of crystal structures determined with cryogenic methods versus year. For the years 1990 to 1994 these data were extracted from *Macromolecular Structures* (Hendrickson & Wüthrich, 1991, 1992, 1993, 1994, 1995). For the year 1995, all articles on macromolecular crystal structures as published in the journals *Cell*, *Nature* and *Science* were analysed. In cases where the temperature during the experiment was not reported, room-temperature was assumed. The total numbers for each year are shown at the top of each bar.

potential for diffusion within the sample. Cryocrystallographic techniques offer the possibility of combating the latter. X-ray diffraction can thus be exploited to greater effect for determining structures from a wide range of biologically important macromolecules such as proteins, nucleic acids and complexes of these, as well as large conglomerate structures, for instance viruses and ribosomal particles.

For data collected at low temperatures, the dramatic reduction in radiation damage allows complete data sets to be collected from a single crystal in many cases. Additionally, atomic motion is reduced at cryogenic temperatures and this, depending on the relative degree of dynamic and static disorder in crystals of a particular macromolecule, can render higher-resolution data accessible. The use of cryogenic techniques obviates the need to mount crystals in capillaries, thus avoiding background X-ray scatter from excess mother liquor and

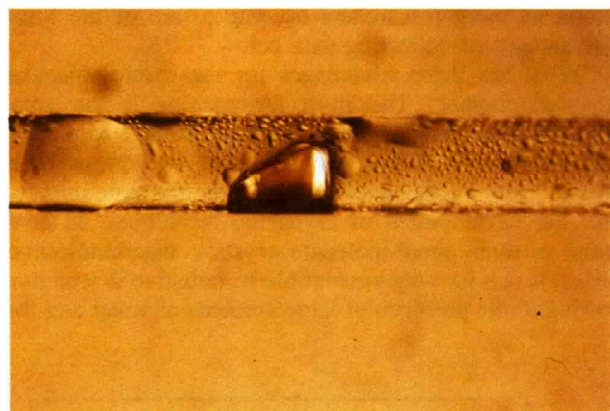

Fig. 2. A capillary-mounted triclinic crystal of hen-egg-white lysozyme after a total exposure time of 10 h at room temperature on beamline BW7B at EMBL-Hamburg (Silfhout & Hermes, 1995). Before exposure to X-rays, the entire crystal was colourless. The width of the brown trace on the crystal corresponds exactly to the width of the synchrotron beam (300 μm).

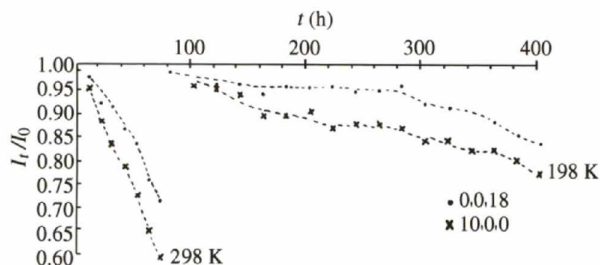

Fig. 3. The ratio I_t/I_0 plotted as a function of exposure time for two reference reflections measured on two typical crystals of lactate dehydrogenase at 298 and 198 K. I_0 and I_t represent the intensity at times $t = 0$ and $t = t$, respectively. Intensities for the 0,0,18 (dots) and 10,0,0 (crosses) reflections are shown. [Redrawn from Haas & Rossmann (1970).]

glass/quartz, resulting in improved signal-to-noise ratios. This is especially important for experiments on weakly diffracting crystals, previously unsuitable for detailed structural studies. Combination of the above factors results in more complete, higher-quality data extending to higher resolution.

Furthermore, cryocrystallographic mounting methods involve less manipulation of crystals than do room-temperature mounting methods, permitting data collection from fragile crystals. Perhaps even more importantly, crystals can readily be screened in the home laboratory and stored at cryogenic temperatures when in peak condition. Suitable crystals can then be retrieved at a later date when data-collection time becomes available. This procedure allows efficient use of X-ray facilities, which is of particular importance when data are collected on synchrotron sources.

The seminal book by Rudman (1976) gives an excellent account of low-temperature techniques used in X-ray diffraction experiments up to 1976. The field of macromolecular cryocrystallography has already been the topic of previous reviews (Hope, 1990; Watenpaugh, 1991; Rodgers, 1994; Rodgers, 1997).

In this article, we outline the developments in cryotechniques that pertain to macromolecular structural research. Since the main motivation behind these developments was the observation that radiation damage to protein crystals was reduced at low temperatures, we briefly present the mechanisms thought to be responsible for this damage. An extensive body of literature on the theory and practice of cooling biological samples to cryogenic temperatures has been published by cryo-electron microscopists and we summarize some pertinent knowledge drawn from their results. Because reliable cryostats are absolutely essential for all cryocrystallographic experiments, we discuss the principles of their operation and properties of relevance to the macromolecular crystallographer. The main focus of this article is the description of experimental techniques. Given that these techniques are currently developing at a very rapid pace in different laboratories, by necessity the discussion of practical aspects cannot cover all the possible ways of performing the steps involved in cryocooling. It will thus to some extent reflect the experiences, views and in some cases the prejudices of the authors. Nevertheless, we hope that the information presented will provide a sound basis for tackling most problems encountered when carrying out diffraction experiments on macromolecular crystals at cryogenic temperatures. In the final part of this article, we discuss current activities in the field of macromolecular crystallography that are benefiting from cryogenic techniques and also comment on some future possibilities.

2. History

The first investigation of the effects of cooling protein crystals to low temperatures dates back to 1966, when

Low *et al.* were confronted with severe radiation damage to insulin crystals containing heavy-metal atoms (Low, Chen, Berger, Singman & Pletcher, 1966). Cooling the crystals from room temperature to 123 K in about 1 min led to an unacceptable increase in mosaicity, which was attributed to thermal strain induced during the cooling process. Their attempts to prevent the formation of ice by the introduction of organic compounds ('cryoprotection') or to harden the crystals by cross-linking the protein molecules with glutaraldehyde (Quiocho & Richards, 1964) were unsuccessful. The method was abandoned and later studies were carried out at temperatures above the freezing point of the crystallization buffer (Cucka, Singman, Lovell & Low, 1970).

Shortly afterwards, Haas (1968) succeeded in cooling crystals of lysozyme mounted in capillaries to 223 K. They withstood soaking in a cryoprotective solution containing 50% glycerol after their surfaces had been cross-linked with glutaraldehyde. In a subsequent study by Haas & Rossmann (1970) on dogfish lactate dehydrogenase, cross-linking was not successful, but nevertheless sucrose could be introduced as a cryoprotectant up to high concentrations (3 M). In addition to using a cryoprotectant, they found it essential to perform the cooling of crystals rapidly and isotropically. Therefore, crystals were not mounted in capillaries, but instead were cleaned of all liquid, picked up with a glass fibre and immediately plunged into liquid nitrogen. The intensities of two reflections were monitored during data collections at room and low temperature, and it was shown that the crystal lifetime was extended more than tenfold by cooling (Fig. 3).

Recognizing that some of the damage to protein crystals during cooling is caused by expansion of the water within the crystal during the liquid/ice transition, Thomanek *et al.* used a completely different approach (Thomanek, Parak, Mössbauer, Formanek, Schwager & Hoppe, 1973). They exploited the fact that ice III (Fig. 4), a high-pressure modification of ice formed between 210 and 350 MPa, has a density higher than and closer to the density of water than that of hexagonal ice (ice I_H), which is normally formed at atmospheric pressure. Crystals of myoglobin were subjected to a hydrostatic pressure of 250 MPa and then cooled to 77 K, transforming water first into ice III and then into ice IX. The latter phase is metastable when the pressure is relaxed to atmospheric. Precession photographs taken after mounting of the cold crystal in a capillary were similar to corresponding photographs collected at room temperature, although changes in reflection intensities indicated structural changes within the crystal.

In 1975, Petsko presented a very general method in which the normal crystal mother liquor is replaced by an aqueous/organic mixture of high organic solvent concentration (Petsko, 1975). Solutions containing between 50 and 85% 2-methyl-2,4-pentanediol (MPD), ethanol, isopropanol, ethylene glycol, or glycerol were used

successfully to cool a number of systems to temperatures between 223 and 150 K while maintaining the solutions in the liquid state. The major advantage of this method is that substrates can be diffused into the crystal in a flow cell (Wyckoff, Doscher, Tsernoglou, Inagami, Johnson, Hardman, Allewell, Kelly & Richards, 1967; Petsko, 1985; Stoddard & Farber, 1995). Reaction intermediates can be accumulated and trapped at low temperatures for sufficiently long periods to be characterized structurally by means of X-ray diffraction [for reviews see Fink (1976), Makinen & Fink (1977), Fink & Petsko (1981), Douzou & Petsko (1984), Bartunik, Bartunik & Viehmann (1992) and Moffat & Henderson (1995)].

In a study aimed at the discrimination of static and dynamic disorder in the activation domain of trypsinogen, Huber *et al.* used a mixture of 70% methanol and 30% water as a cryoprotective buffer (Singh, Bode & Huber, 1980; Walter, Steigemann, Singh, Bartunik, Bode & Huber, 1982).

Another way of preventing the formation of ice within a protein crystal was chosen by Hartmann *et al.* for the structure determination of metmyoglobin at 80 K (Hartmann, Parak, Steigemann, Petsko, Ringe-Ponzi & Frauenfelder, 1982). To avoid any changes introduced by cooling the crystals under high pressure or by exchanging the mother liquor with a cryoprotective solution, the crystals were kept in their normal mother liquor and plunged into liquid propane, which resulted in a fast enough cooling rate to prevent ice formation inside the crystal.

Very slow cooling from 290 to 16 K in a closed-cycle liquid helium cryostat over a period of 3 d was used by Drew *et al.* in a study of a B-DNA dodecamer (Drew, Samson & Dickerson, 1982). An increase in mosaicity from 0.5° to more than 2.0° was observed, but this did not hamper structure determination to 2.7 Å resolution.

Based on a method previously used for air-sensitive small molecules (Hope, 1985), the first widely used technique for the cryocrystallography of biological macromolecules was described by Hope (1988). First, a crystal is transferred to a hydrocarbon environment ('magic oil') and the mother liquor is removed completely. The crystal is then picked up with a thin glass fibre and immediately cooled in a stream of cold nitrogen gas. The hydrocarbon oil protects the crystal during transfer and on solidification acts as a glue between the crystal and the glass fibre. This method has been used for the structure determination of numerous DNA oligomers (Eisenstein, Hope, Haran, Frolow, Shakked & Rabinovich, 1988; Joshua-Tor, Rabinovich, Hope, Frolow, Appella & Sussman, 1988; Shakked, Guenstein-Guzikevich, Eisenstein, Frolow & Rabinovich, 1989; Eisenstein, Frolow, Shakked & Rabinovich, 1990; Narayana, Ginell, Russu & Berman; Quintana, Lipanov & Dickerson, 1991; Joshua-Tor, Frolow, Appella, Hope, Rabinovich & Sussman, 1992; Ginell, Vojtechovsky, Gaffney, Jones & Berman, 1994; Bancroft, Williams, Rich & Egli, 1994) and a large number

of proteins (Teeter & Hope, 1986; Wagner, Werber, Beck, Hartman, Frolow & Sussmann, 1989; Freymann, Down, Carrington, Roditi, Turner & Wiley, 1990; Livnah & Sussman, 1990; Earnest, Fauman, Craik & Stroud, 1991; Wilke, Higaki, Craik & Fletterick, 1991; Watt, Tulinsky, Swenson & Watenpaugh, 1991; Harel, Su, Frolow, Ashani, Silman & Sussman, 1991; Harel, Su, Frolow, Silman & Sussmann, 1991; Chen & Herzberg, 1992; Day, Hsu, Joshua-Tor, Park, Zhou, Adams & Rees, 1992; Egli, Usman, Zhang & Rich, 1992; Georgiadis, Komiyama, Chakrabarti, Woo, Kornuc & Rees, 1992; Rini, Schulze-Gahmen & Wilson, 1992; Kim, Kwon, Myers & Rees, 1993; Lima, Wang & Mondragon, 1994; Knegtel, Strokopytov, Penninga, Faber, Rozeboom, Kalk, Dijkhuizen & Dijkstra, 1995; Kurinov & Harrison, 1995; Wagner, Müller, Schmitzberger, Falk & Kratky, 1995). For mounting the extremely radiation-sensitive and extremely fragile crystals of ribosomal subunits (Yonath, Glotz, Gewitz, Bartels, von Böhlen, Makowski & Wittmann, 1988), the method was modified in several respects (Hope, Frolow, von Böhlen, Makowski, Kratky, Halfon, Danz, Webster, Bartels & Yonath, 1989): the simple glass fibres were replaced by miniature glass spatulas that support the crystals mechanically and the crystals were immersed in viscous hydrophilic liquids instead of hydrocarbons before mounting. In some cases, it proved necessary to replace the mother liquor by cryoprotective buffers. To achieve maximum cooling rates, the crystals were plunged into liquid propane.

During investigation of the photolysis of carbonmonoxy-myoglobin (Teng, Srajer & Moffat, 1994), the need to minimize the absorption effects of mechanical supports for very thin and fragile crystals led to the development of a novel mounting technique by Teng (1990). In this method, the crystal is picked up from a cryoprotective solution with a small loop made out of thin (25 to 75 μm diameter) wire. The liquid inside the loop forms a thin film, in which the crystal is held by surface tension. Subsequently, the liquid and the crystal are cooled in a stream of cold nitrogen or in liquid cryogen. The advantages of this method, very gentle handling of crystals and greatly reduced background owing to minimization of additional scatter from glass and excess liquor surrounding the crystal, were to some extent outweighed by the shadowing of parts of reciprocal space by the wire holding the film of liquid. Thus, only a limited number of experiments were performed using this technique in its original form (Madden, Gorga, Strominger & Wiley, 1992; Silver, Guo, Strominger & Wiley, 1992; Clark, Halay, Lai & Burley, 1993; Kim & Lipscomb, 1993; Bullock, Branchaud & Remington, 1994; Andersen, Thirup, Nyborg, Dolmer, Jacobsen & Sottrup-Jensen, 1994; Watowich, Skehel & Wiley, 1995). Replacement of the wire by other materials such as glass (Burmeister, Huber & Bjorkman, 1994; Huber, Wang, Bieber & Bjorkman, 1994; Brown, Jardetzky, Gorga, Stern,

Urban, Strominger & Wiley, 1993), hair (Bennett & Eisenberg, 1994) or synthetic or natural fibres such as rayon, mohair or dental floss (Sharma, Hanai & Mondragon, 1994; Djinic-Carugo, Battiston, Carri, Polticelli, Desideri, Rotilio, Coda & Bolognesi, 1994; Brown, Jardetzky, Stern, Gorga, Strominger & Wiley, 1995; Owen, Noble, Garman, Papageorgiou & Johnson, 1995) alleviated this problem and the method has become increasingly popular and widely used (*e.g.* Bullough, Hughson, Treharne, Ruigrok, Skehel & Wiley, 1994; Oubridge, Nobutoshiki, Evans, Teo & Nagai, 1994; Mattevi, Valentini, Rizzi, Speranza, Bolognesi & Coda, 1995; Rodgers, Gamblin, Harris, Ray, Culp, Hellmig, Woolf, Debouck & Harrison, 1995; Reinisch, Chen, Verdine & Lipscomb, 1995).

3. Radiation damage

Although radiation damage has been a problem since the early days of protein crystallography, there have been only a few systematic experimental studies (Blake & Philips, 1962; Haas & Rossmann, 1970; Dewan & Tilton, 1987; Young, Dewan, Thompson & Nave, 1990; Gonzales, Thompson & Nave, 1992; Young, Dewan & Tilton, 1993; Gonzales & Nave, 1994; Watowich, Skehel & Wiley, 1995) and no comprehensive theory has been presented to date.

Experience has shown that there are two components to radiation damage at room temperature, one being dose-dependent and the other being time-dependent. Both can be explained in a two-stage model (Henderson, 1990; Nave, 1995). The incident X-ray-photons cause immediate damage to the molecules they hit by ejecting electrons (Jones, Lea, Symons & Taiwo, 1987; Symons, 1995), thereby initiating chemical reactions. These events represent the dose-dependent component of radiation damage and their number has been estimated to be on the order of hundreds per absorbed 8 keV ($\lambda = 1.54 \text{ \AA}$) X-ray photon (Blake & Philips, 1962; Henderson, 1990). The time-dependent component of radiation damage is associated with the presence of relatively large amounts of water in crystals of biological macromolecules (Matthews, 1968). This 'crystal water' is the source of radicals produced either by direct radiolysis of water molecules, or reactions initiated by radicals. The radicals produced (hydroxyl, hydroperoxyl, oxygen) are particularly dangerous to protein molecules ['oxygen effect' (Coggle, 1973)]. Their reactions with proteins cause a number of effects ranging from local damage to complete disintegration (Davies, 1987; Davies, Delsignore & Lin, 1987; Davies & Delsignore, 1987; Davies, Lin & Pacifici, 1987), and radical chain reactions are possible (Coggle, 1973). The 'crystal water' also facilitates the diffusion of radicals away from their production site and thereby mediates damage to distant regions of the crystal. In addition, sample heating by intense X-ray beams accelerates this diffusion, increasing the rate of

radiation damage. Radical production and diffusion vary from system to system, which leads to the relatively unpredictable behaviour of different crystals with respect to radiation damage.

Owing to the nature of diffraction experiments, ionization events directly caused by incident photons (primary radiation damage) cannot be avoided, but attempts can be made to limit the spread of damage by the slowing down of diffusional processes within the crystal. Lowering the temperature to around 273 K already affects diffusion sufficiently to prolong crystal lifetime significantly (Low, Chen, Berger, Singman & Pletcher, 1966; Marsh & Petsko, 1973; Drenth, 1994). Also, attempts have been made to trap free radicals inside the crystal by the introduction of scavengers such as styrene (Zaloga & Sarma, 1974). Crosslinking with glutaraldehyde (Quiocho & Richards, 1964) can limit the breakdown of crystalline order by acting as a scaffold (Haas, 1968; Ringe, Petsko, Yamakura, Sozaki & Ohmori, 1983), thus lessening the consequences of radiation damage.

The most effective way to reduce secondary damage is to perform the experiment at cryogenic temperatures where atomic diffusion within the crystal comes virtually to a complete halt. This was realized first by Haas & Rossman (1970). Later, radiation damage was found to be undetectable in a number of experiments performed at cryogenic temperatures, and it was found possible to collect complete data sets from a single crystal (Dewan & Tilton, 1987; Hope, Frolow, von Böhlen, Makowski, Kratky, Halfon, Danz, Webster, Bartels & Yonath, 1989; Young, Dewan, Thompson & Nave, 1990; Gonzales, Thompson & Nave, 1992; Young, Dewan & Tilton, 1993). In addition to eliminating atomic diffusion, the rigid solvent matrix provides a scaffold against the spreading of damage *via* 'domino effects' mediated by lattice contacts (Henderson, 1990).

However, even at cryogenic temperatures, primary radiation damage still occurs and can build up to detectable levels during data collection (Owen, Noble, Garman, Papageorgiou & Johnson, 1995) or cause crystals to change colour and to disintegrate upon being warmed up, indicating that chemical reactions have taken place (Hope, Frolow, von Böhlen, Makowski, Kratky, Halfon, Danz, Webster, Bartels & Yonath, 1989; Kurinov & Harrison, 1995). In some cases, where very high X-ray doses had to be used, it has been necessary to use several crystals to obtain a complete data set even at cryogenic temperatures (Watowich, Skehel & Wiley, 1995; Rodgers, Gamblin, Harris, Ray, Culp, Hellmig, Woolf, Debouck & Harrison, 1995; Yonath, 1996). In fact, the unavoidability of primary radiation damage will always lead to a certain number of destructive events per given dose, imposing a lower limit on the size of crystals from which complete datasets can be collected even with ever stronger synchrotron radiation sources (Henderson, 1990; Gonzales, Thompson & Nave, 1992).

4. Principles of cryoprotection

When an untreated crystal of a biological macromolecule is cooled to cryogenic temperatures, a major cause of damage is the mechanical stress induced by the 9% increase in specific volume that accompanies the phase transition from water to hexagonal ice (ice I_H ; Fig. 4). This problem has plagued the field of cryo-electron microscopy for decades and numerous techniques have been developed to suppress the formation of ice lattices in biological specimens. Excellent reviews describing the various methods of cryoprotection and the underlying physicochemical principles are available (Angell & Choi, 1986; Steinbrecht & Zierold, 1987; Echlin, 1992). Here, we concentrate on the principles of

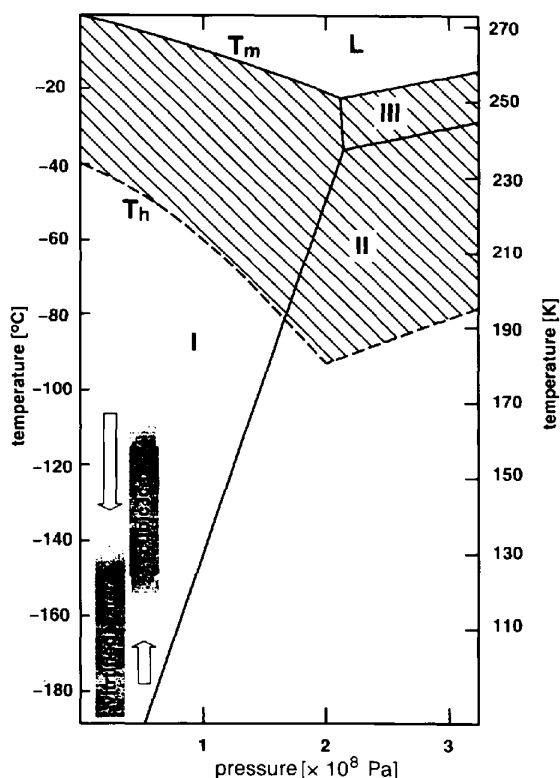

Fig. 4. Schematic drawing of a part of the pressure/temperature phase diagram for pure water [redrawn from Kanno, Speedy & Angell (1975) and Franks (1985)]. Full lines indicate the phase boundaries between the three ice polymorphs I, II and III and liquid water L. Ice I can exist in hexagonal (I_H) and cubic (I_C) forms. The boundary between liquid water and ice I corresponds to the pressure-dependent melting temperature T_m of ice I_H . The hatched area shows the region in which supercooled water can exist. The lower boundary of this area (shown as a dashed line) corresponds to the temperature of homogeneous nucleation T_h , *i.e.* the temperature at which statistical fluctuations within the liquid lead to the formation of crystal nuclei. The temperature ranges in which vitrified water and cubic ice can exist at atmospheric pressure depend on the history of the system (Dowell & Rinfret, 1960) and are indicated as grey bars.

importance to the cryoprotection of crystals of biological macromolecules.

Although the exact course of events inside a protein crystal when it is cooled is very complex, looking at the processes involved during the freezing of pure water and of ideal binary solutions can help in the devising and rationalizing of various strategies against ice formation in crystals.

The phase diagram for pure water is shown in Fig. 4. At atmospheric pressure ice melts at $T_m = 273$ K, whereas the solidification temperature T_h is much lower. When cooled to temperatures between T_m and T_h , the liquid is trapped in a metastable, the 'supercooled', state: it cannot reach thermodynamic equilibrium as nuclei necessary to allow crystal growth to start do not form. The rates of both the processes involved in crystallization, nucleation and crystal growth are correlated with the timescales of relaxation processes within the liquid, which in turn are strongly temperature dependent.

When pure water is cooled at moderate rates, density fluctuations within the liquid phase lead to formation of nuclei of sufficient size for subsequent crystal growth at approximately 233 K (homogeneous nucleation) (Kanno, Speedy & Angell, 1975). The presence of heterogeneities that provide initiation points for crystallization can accelerate the nucleation step, resulting in an elevated solidification temperature (heterogeneous nucleation). If heat is removed from the system fast compared to the timescales involved in crystallization, only negligible crystallization will occur and at the glass transition temperature [approximately 140 K for pure water (Angell & Tucker, 1980)] the system will transform into a rigid and nonordered glassy phase: the 'vitrified' water (Fig. 4). When warmed up, vitrified water transforms first into cubic ice I_C and then, at higher temperatures, undergoes a second transition to hexagonal ice I_H . Both these transitions (vitrified water $\rightarrow I_C$ and $I_C \rightarrow I_H$) can take place over a broad range of temperatures, the time taken for conversion between different states being strongly temperature dependent (Dowell & Rinfret, 1960).

From the thermodynamic point of view (Fig. 5a), the driving force of crystallization is the difference $\Delta G = G_c - G_l$ between the Gibbs free energies $G_{c,l} = H_{c,l} - TS_{c,l}$ [$H_{c,l}$ and $S_{c,l}$ are the enthalpy and entropy of the crystalline (c) and the liquid (l) states of water] at a temperature T (measured in K). In terms of enthalpy, the ice structure is more favoured than the liquid structure by $\Delta H = 44$ kJ mol⁻¹. However, it is only below the melting temperature T_m that the entropy term TS_l for the liquid state becomes small enough for the crystalline state to be the state of lowest free energy G .

The kinetics involved in crystallization and vitrification result in the aqueous systems considered here not always reaching their state of lowest free energy G , but instead becoming trapped in a metastable, the vitrified, state. These kinetics can be understood in

terms of a simple model based on the temperature dependence of two characteristic times (Uhlmann, 1972; Angell & Choi, 1986). For illustration, see Fig. 5(b). The time τ_{in} characterizes the timescale of relaxation processes within the liquid. τ_{in} increases monotonically with decreasing temperature, reflecting the decreasing molecular mobility (corresponding to an increase in macroscopic viscosity). The 'escape time', τ_{out} , is the time needed for a chosen fraction (e.g. 50%) of the sample to transform from the liquid to the crystalline state. τ_{out} combines the rates for nucleation and crystal growth, and rapidly decreases as the difference in free energy ΔG between the liquid and crystalline state [the 'motivating potential' for crystallization (Uhlmann, 1969)] builds up when the temperature is lowered below the melting point. Together, the acceleration of

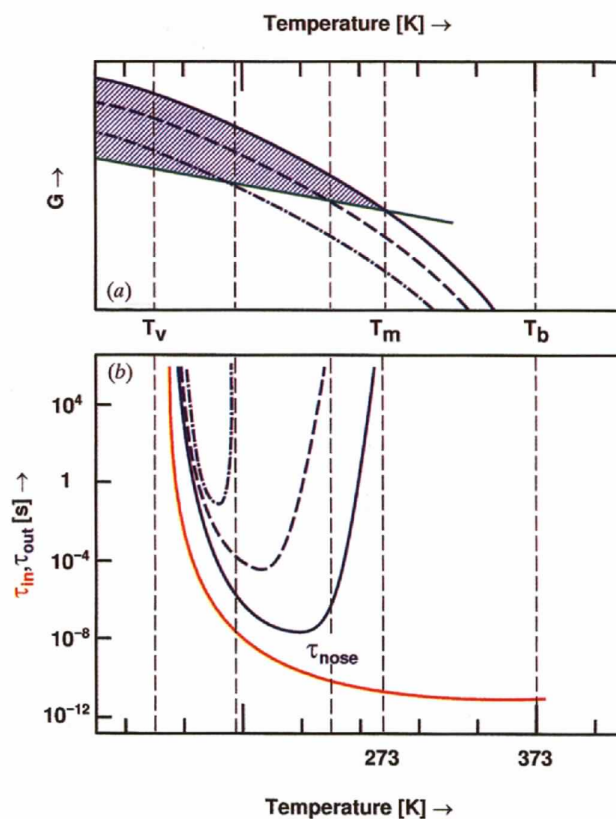

Fig. 5. (a) Thermodynamics and (b) kinetics during crystallization and glass formation for pure and mixed liquids at atmospheric pressure. Full lines correspond to pure liquid and dashed and dashed-dotted lines to increasing concentrations of a cryoprotectant. In (a), blue lines stand for the free energy in the liquid state and the green line corresponds to the free energy of ice. The blue hatched area is the difference in free energy ΔG between the liquid and the solid state. In (b), the red line corresponds to τ_{in} and the blue lines to τ_{out} (for definitions for τ_{in} and τ_{out} see the text). T_m stands for the melting temperature of ice, T_b for the boiling temperature of water and T_v for the vitrification temperature of pure water. [Redrawn from Angell & Choi (1986).]

crystallization due to the increase in ΔG (Uhlmann, 1969) and the reduction of molecular mobility with decreasing temperature result in a minimum value τ_{nose} (corresponding to the maximum rate of crystal growth) for τ_{out} with respect to temperature. At temperatures below the temperature corresponding to τ_{nose} , a regime is entered that is dominated by the quenching of particle fluctuations, resulting in an increase in τ_{out} as ice-crystal formation is greatly retarded. For pure water, τ_{nose} is of the order of 10^{-6} to 10^{-10} s (Angell & Choi, 1986). If cooling is performed on a timescale that is fast compared to τ_{nose} , only limited crystallization will occur. At the glass-transition temperature, the viscosity becomes infinite along with the relaxation time τ_{in} , as the system reaches the vitrified state.

For untreated macromolecular crystals, cooling rates fast enough to bypass the minimum of τ_{out} (τ_{nose}) are not reproducibly achievable. Nevertheless τ_{nose} can be manipulated by, for example, addition of a solute or the application of pressure, in such a way that crystallization becomes negligible at accessible cooling rates, as shown below.

4.1. Vitrification at atmospheric pressure

When a solute is added to a solution, the entropy of the liquid phase increases, decreasing the overall free energy of the liquid, whereas the free energy of the corresponding ice is unchanged as long as this solute is not incorporated into the ice lattice (Fig. 5a). Hence, as the driving force for crystallization becomes smaller, the characteristic time for crystallization, τ_{out} , will increase at every temperature. A way to visualize this is to see that the τ_{out} curve is squashed towards the τ_{in} curve and τ_{nose} is increased, corresponding to a reduction in the maximum rate of crystallization (Fig. 5b). Additionally, with added solute the melting temperature is lowered and the vitrification temperature increases. This is the principle of action of 'cryoprotective' or 'antifreeze' agents, the addition of which allows crystallization to be suppressed and the vitrified state to be reached at accessible cooling rates.

4.2. Vitrification at high pressure

When water is transformed into hexagonal ice I_H , its volume increases. Therefore, according to Le Chatelier's principle, crystallization can be hindered by the use of pressure to counteract this expansion. An increase in pressure will lower the melting point and reduce the rates of nucleation and crystal growth. The optimum pressure range can be deduced from the phase diagram of water (Fig. 4). At approximately 210 MPa, the melting temperature is depressed to a minimum of 251 K and the zone of supercooling is expanded down to 181 K (Kanno, 1975). In addition, when solidifying at this pressure, water will not crystallize as ice I_H , which has

a lower density, but as ice II or III, both of which have a density higher than liquid water. This behaviour of water is exploited in electron microscopy (Moor, 1987; Dahl & Staehelin, 1989) and apparatus for the high-pressure cooling of biological samples is commercially available (Dahl & Staehelin, 1989). To date, the only experiment to use this method for cooling protein crystals is the study by Thomanek *et al.* on crystals of sperm-whale myoglobin at 77 K (Thomanek, Parak, Mössbauer, Formanek, Schwager & Hoppe, 1973).

5. Cryostats

A great variety of systems for X-ray diffraction data collection at cryogenic temperatures have been described in the literature and a large number of systems are commercially available. Again, the book by Rudman (1976) provides a comprehensive review of developments before 1976 and covers most aspects involved in the design of cryostats for X-ray crystallography. Recently Larsen (1995) has given an overview of cryocrystallography at temperatures below 77 K.

The basic specifications of a cryostat include the accessible temperature range, the fluctuations around a preset temperature and the long-term stability of the entire apparatus. Other aspects to be considered when one is choosing a system for a particular laboratory or type of experiment are: accessibility for sample mounting and monitoring during the experiment, adaptability to different experimental situations, potential safety hazards due to pressurized or evacuated parts of the apparatus or due to the use of cryogenics, and last but not least the price of the cryostat and its running costs.

For the majority of cryogenic diffraction experiments on biological macromolecules, a temperature between 90 and 120 K at a stability of ± 1 K is sufficient. One should pay particular attention to the stability of the system over extended periods of time and while cryogenics are being refilled, especially when experiments are performed on conventional X-ray sources. If the system fails, the crystal will be lost and the experiment will then have to be repeated.

Open-flow nitrogen cryostats not only fulfil the above requirements, but also offer a number of other advantages. The basic principle of these systems is rather simple: either a stream of cold nitrogen gas is taken directly as the boil-off from a large reservoir of liquid nitrogen, or the nitrogen gas is cooled to the required temperature by a refrigeration mechanism and then directed onto the sample. Different designs have been proposed in the literature (Rudman, 1976; Cosier & Glazer, 1986; Bellamy, Phizackerly, Soltis & Hope, 1994) and a variety of systems are commercially available (Enraf Nonius, The Netherlands; Molecular Structure Corporation, USA; Oxford Cryosystems, United Kingdom; Siemens AG, USA). In virtually all the systems currently on the market, the formation of ice on the sample is in principle

prevented by surrounding the stream of cold nitrogen gas by a coaxial stream of warm dry gas (nitrogen or dried air) that shields the inner stream from any atmospheric moisture (Post, Schwartz & Fankuchen, 1951) and warms the goniostat. Ice formation on the sample and the surrounding equipment can be completely eliminated by enclosing of the relevant parts in a small container (Fig. 6) or in a tent made of *e.g.* polyethylene film [as suggested by Lipscomb (Haas & Rossman, 1970)], in which a dry atmosphere is maintained. For some geometries, a box is available commercially from Molecular Structure Corporation (USA). Alternatively, the entire diffractometer set-up can be kept in a dry box (Stalke, 1996). Such enclosed set-ups not only avoid ice formation but also protect the experiment against any draughts from the external environment. Differences between the various open-flow nitrogen cryostats mainly concern the methods utilized to minimize temperature fluctuations at the sample and to ensure stable performance during the refill of liquid nitrogen. Some systems contain pressurized tanks or glass vacuum transfer lines that can represent a safety hazard. The mechanical design of transfer lines in a cryostat system will determine its versatility with respect to different experimental set-ups.

A continuous flow of cold nitrogen gas has also been used to maintain a constant low temperature within an X-ray-transparent chamber large enough to accommodate a flow cell (Bartunik & Schubert, 1982; Hajdu, McLaughlin, Helliwell, Sheldon & Thompson, 1985).

The use of nitrogen gas as the cooling medium has the consequence that only temperatures above the liquefaction temperature of nitrogen (77 K at atmospheric pressure) are accessible. This limitation can be overcome by the use of helium as the cooling medium. Some of the open-flow cryostats normally used with nitrogen can be operated equally well with helium (Molecular Structure Corporation, USA) and some devices have been specifically designed for use with helium (Greubel, Gmelin, Moser, Mensing & Walz, 1990). Recently a cryostat that can be switched back and forth between nitrogen and helium during continuous operation has been described (Teng, Schildkamp, Dolmer & Moffat, 1994).

In cases where extremely low and stable temperatures are required, a completely different design can be employed, in which the crystal is placed inside a chamber shielding it from thermal radiation and from the outside atmosphere. Heat transfer from the crystal to a cold reservoir is facilitated either by a dry gas contained in the chamber (*e.g.* Albertsson, Oskarson & Ståhl, 1979) or by heat conduction through the crystal mount and heat-transfer links (*e.g.* Samson, Goldish & Dick, 1980; Adlhart & Huber, 1982). Such closed-cycle cryostats have only rarely been used in macromolecular crystallography owing to their technical complexity (Hartmann, Parak, Steigemann, Petsko, Ringe-Ponzi & Frauenfelder, 1982; Hartmann, Zinsler, Komminos, Schneider, Nienhaus & Parak, 1996).

6. Practical aspects

The overall success of a cryocrystallographic experiment depends on a number of small and seemingly unimportant details, which together determine the outcome of the experiment. Attention to these details can make the difference between failure and a structure solution. Several practical considerations must be addressed and this section describes these. Most of the aspects discussed in the following sections apply both to the oil-mounting technique proposed by Hope (1988) and to the loop-mounting method described by Teng (1990). Here, we concentrate on the latter technique. Fig. 7 summarizes the broad steps involved in conducting such

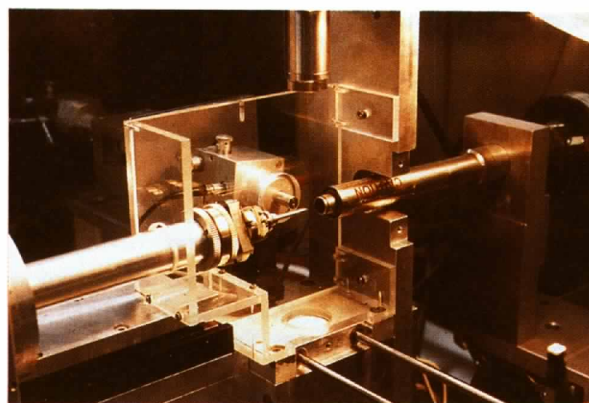

(a)

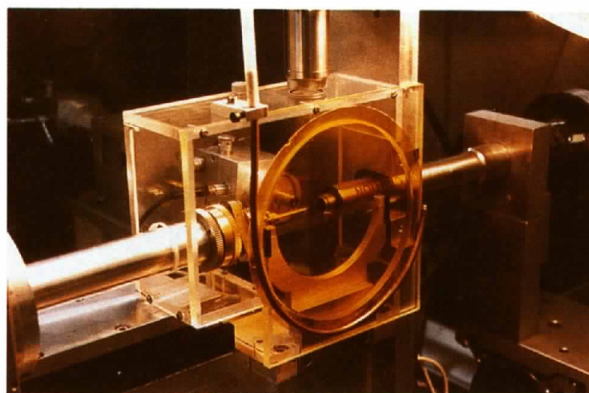

(b)

Fig. 6. X-ray diffraction arrangement on beamline BW7B at EMBL-Hamburg. The φ -axis goniometer enters from the left, the cold stream from the right and the camera for centring and monitoring the crystal from above. The box can be opened to mount and align the crystal (*a*). For the actual experiment the box is closed (*b*). The cold nitrogen and the dry air delivered by the Oxford Cryosystems Cryostream are sufficient to keep a positive pressure in the box, preventing any humid air from entering. The backstop can be positioned inside or outside the box, depending on the circumstances. The circular tube around the window is used to blow air across the window to avoid condensation.

an experiment and Fig. 8 shows a typical experimental arrangement.

The central and sometimes most difficult task is to establish a cooling procedure for a specific macromolecular crystal (see Fig. 7). This includes determining the cryoprotective conditions for the particular buffer and testing to what extent these affect the crystal quality (§6.1). On the crystal-handling side, special crystal-mounting techniques (§6.3) are required to facilitate flash cooling (§6.4).

Prerequisites for starting a cryogenic data collection are a reliable cryostat (§5), the ability to maintain an ice-free environment (§6.7), some crystal-mounting equipment (§6.2), a sufficient number of crystals and some manual dexterity for smooth and rapid operation on the part of the experimenter.

One of the great benefits of cryocrystallography is the possibility of the long-term storage of crystals at cryogenic temperatures, enabling screening for diffraction quality prior to data collection and/or additional data collection at a later date. Not only is this advantageous 'in house', but it also allows synchrotron beam

time to be used far more efficiently. The techniques of crystal storage, transfer and retrieval are described in §6.6. Some special considerations pertinent to cryogenic data collection and to structure solution, refinement and analysis are outlined in §§6.5 and 6.8, respectively.

6.1. Cryoprotectants

Cryoprotectants are employed to reduce the crystallization rates of the water both within the crystal and within the surrounding solvent, thereby minimizing any disruption of the crystal by ice formation during the cooling procedure (Fig. 5). The addition of extra solutes to crystal-stabilizing buffers, or any change of temperature, affects a number of physical and chemical parameters such as the protonic activity and the dielectric constant (Petsko, 1975; Douzou, Hui Bon Hoa, Maurel & Travers, 1990; Douzou & Balny, 1978; Fink & Petsko, 1981; Douzou & Petsko, 1984). Moreover, chemical

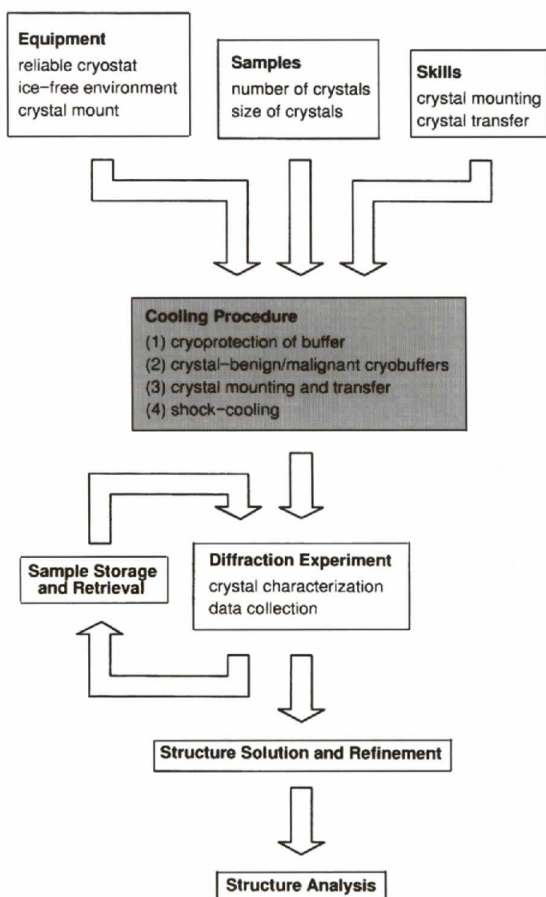

Fig. 7. Flow chart showing the general steps in a cryocrystallographic experiment. The steps are described in detail in the text.

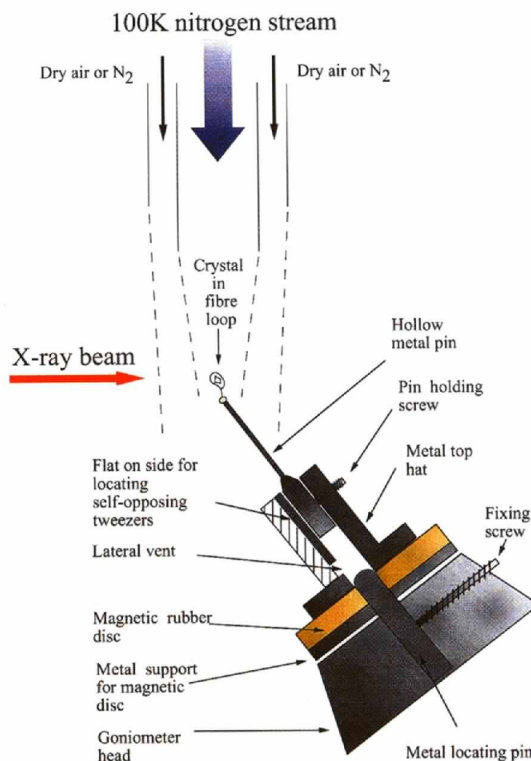

Fig. 8. Typical experimental arrangement for a cryocrystallographic data collection. A magnetic rubber disc is pierced with a stainless steel pin, the top of which is rounded and has the same diameter as a hole in the base of the pin holder or 'top hat' and the bottom of which fits into the hole in the goniometer head. The magnet must be strong enough to make a rigid connection, but weak enough to allow the experimenter fine control of the top hat. Another design has a raised metal rim round the disc magnet for accurate location, instead of a central pin. See §6.2 for a detailed discussion of the parts.

Table 1. *Compounds used as cryoprotectants below 120 K and representative examples of their usage*

Other potential candidates include: erythritol, inositol, raffinose, 1-2,3 butanediol, dimethylsulfoxide (DMSO), jeffamine and 1,6-hexanediol. Further lists of substances are given by Watenpaugh (1991), Gamblin & Rodgers (1993), Rodgers (1994) and Abdul-Meguid, Jeruzalmi & Sanderson (1996).

Compound	Example
Sucrose	Haas & Rossmann (1970) Sharma, Hanai & Mondragon (1994)
MPD	Petsko (1975), Kim & Lipscomb (1993)
Glycerol	Petsko (1975) Madden, Gorga, Strominger & Wiley (1992)
Ethylene glycol	Petsko (1975), Freymann <i>et al.</i> (1990)
Propylene glycol	Petsko (1975)
Ethanol	Petsko (1975)
Methanol	Petsko (1975)
Isopropanol	Petsko (1975)
PEG 400/600	Yan <i>et al.</i> (1993), Mattevi <i>et al.</i> (1995)
PEG ≥ 1000	Reinisch, Chen, Verdine & Lipscomb (1995) Leahy, Aukhil & Erickson (1996)
Xylitol	Watowich, Skehel & Wiley (1994)

Table 2. *The hkl indices, Bragg spacings d and relative intensities I/I_0 of reflections observed in powder diffraction from crystals of hexagonal ice at 98 K as reported by Dowell & Rinfret (1960)*

Note that the relative intensities of ice rings found in diffraction photographs from macromolecular crystals often deviate substantially from the values given in the table.

hkl	d (Å)	I/I_0	hkl	d (Å)	I/I_0
100	3.897	100	103	2.072	30
002	3.669	75	200	1.948	4
101	3.441	53	112	1.918	18
102	2.671	17	201	1.883	3
110	2.249	39	202	1.721	2

reactions between cryoprotective agents and molecules within the crystal cannot always be ruled out. As a consequence, the delicate balance of forces between the constituents of the crystal can be perturbed, leading to a breakdown of crystalline order. Such unwanted side-effects must be minimized by the suitable choice of an antifreeze agent, its concentration and the method of equilibration of the crystal with the cryoprotective buffer.

Before any experiments towards finding and optimizing cooling protocols are undertaken, crystals should be well characterized with respect to mosaic spread, ageing, transport and data collection at room temperature, in order to facilitate a clear separation between these factors and effects related to the flash-cooling procedure.

A large number of compounds have been used successfully for the cryoprotection of macromolecular crystals (Table 1). Unfortunately, finding the right cryoprotectant for a particular system is to some extent a matter of trial and error. In many instances, the cryoprotection of crystals grown from aqueous/organic

mixtures or from buffers of low salt concentration can be achieved easily by the addition of organic compounds (Fink & Petsko, 1981; Douzou & Petsko, 1984). In the experience of the authors, in a large proportion of these cases the following guidelines will lead to success. If a polyethylene glycol (PEG) with a molecular weight of less than 4000 or MPD is used as the precipitating agent, increasing the concentration of the precipitant can yield a good cryobuffer. For crystals induced by PEGs with molecular weights of 4000 and higher, the addition of small PEGs (*i.e.* PEG 400 or PEG 600) is recommended. For crystals grown by salting out at relatively low salt concentrations, MPD and ethylene glycol are promising candidates. In other cases, glycerol at concentrations up to 50% (Garman & Mitchell, 1996) seems to be an almost universal cryoprotective agent for a wide range of commonly used crystallization buffers.

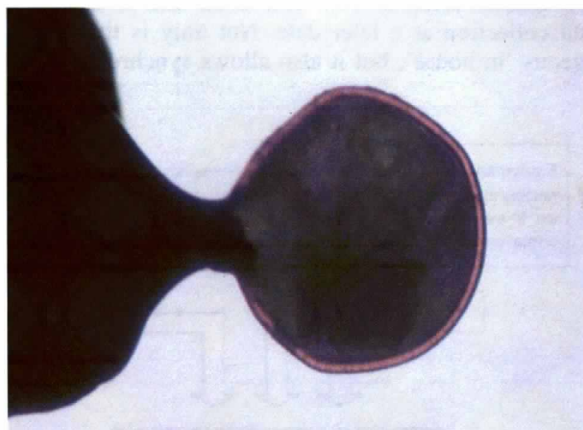

(a)

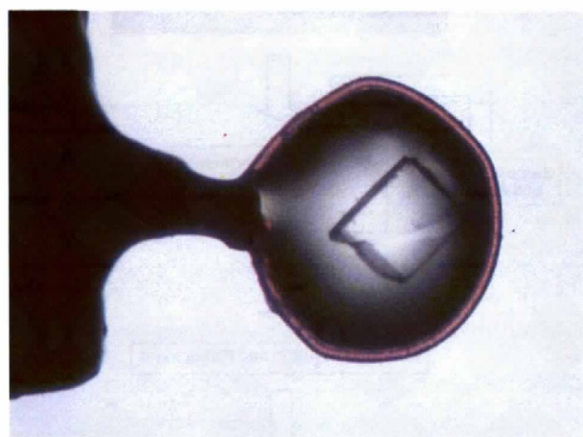

(b)

Fig. 9. A glycogen phosphorylase *b* crystal suspended in a thin film after flash cooling using (a) a noncryoprotective and (b) a cryoprotective buffer.

In the first step, the minimum concentration of cryoprotectant necessary to vitrify the stabilization buffer alone must be established. An increasing fraction of the water in the stabilization buffer is replaced by a cryoprotective agent until a small amount of such a solution can be cooled without ice formation, using the cooling procedure to be employed later for crystals. The formation of ice within the sample can be examined visually: if the sample stays transparent upon cooling, vitrification has taken place, whereas opacity indicates the formation of ice crystals (Fig. 9). To confirm the degree of vitrification within the sample, X-ray diffraction patterns should be recorded and checked for signs of powder diffraction rings ('ice rings') resulting from microcrystalline ice. The Bragg spacings at which ice rings can be found at 98 K are given in Table 2. The exact positions at other temperatures (e.g. for calibration purposes) can be derived from the temperature-dependent cell constants for hexagonal ice given by Röttger, Endriss, Ihringer, Doyle & Kuhs (1994). When checking cryoprotectants, one should ensure that any ice rings present can be detected (*i.e.* by appropriate positioning of the detector). If rings are seen in the diffraction pattern, care should be taken that they do not arise from other possible sources of powder diffraction such as the loop material, glue, Plasticine, collimator *etc.* Once the concentration of cryoprotectant sufficient for vitrification of the buffer alone has been determined, it can be increased by 2 to 5%. This provides a safety margin when at a later stage the larger thermal mass of liquid plus a crystal have to be cooled without ice formation.

Incompatibility of a crystal with a cryoprotected solution can result in cracking or dissolution. Less obvious damage to the crystal is seen in diffraction patterns, which will reveal possible crystal splitting and allow the estimation of mosaic spread and diffraction power for comparison with measurements at room temperature. The mosaic spread can be used as an indicator of crystal quality and will often increase when crystals are cooled to cryogenic temperatures. It should be emphasized that there are factors involved in cooling a crystal that are difficult to control quantitatively (amongst others the dexterity of the experimenter in handling the crystal) and that it is therefore advisable to perform several experiments for each set of cryoconditions [see Fig. 10 and Chen & Herzberg (1992)]. One should optimize the cryoprotection protocol to minimize the adverse effects of the cooling procedure on the crystal (Mitchell & Garman, 1994).

The osmotic shock experienced by a crystal when exposed to a cryoprotective buffer can be alleviated by a stepwise transfer from the stabilizing solution to the cryoprotected solution. For example, if 25% glycerol is necessary to cryoprotect a buffer, the equilibration of a crystal with this buffer can be performed in steps of 5% increments in cryoprotectant concentration (*i.e.* 5% → 10% → 15% → 20% → 25%). The actual stepwise

increase of cryoprotectant concentration can be carried out either by physical transfer of the crystal between different solutions or by withdrawal and replacement of the respective solutions leaving the crystal stationary, the latter method being mechanically less dangerous to fragile crystals and facilitating a more gradual change of buffer concentration. The steps can be made smaller than 5%, although when the number of steps becomes very large, continuous dialysis against the cryoprotective agent is a viable option.

The time necessary for equilibration between a crystal and a cryoprotective buffer of a given concentration depends on the size of the crystal, the nature of the solvent channels within the crystal, the temperature, the diffusion coefficient of the cryoprotectant and a number of other factors (Bishop & Richards, 1968). For small cryoprotective agents such as glycerol, soaking times of less than 1 min can be sufficient (Schneider, 1996a), whereas for larger cryoprotectants such as PEGs, soaking times of several minutes might be necessary to achieve equilibrium (Bishop & Richards, 1968; Fink & Petsko, 1981; Ray, Bolin, Puvathingal, Minor, Liu & Muchmore, 1991). Characteristic linear dimensions of loosely 'folded' PEG molecules with mean molecular weights of 1000 and higher are of the order of 60 Å or larger (Knoll & Hermans, 1983), making it difficult for such molecules to diffuse in solvent channels of crystals. Also, buffers containing cryoprotectants, especially high-molecular-weight PEGs, may withdraw water from macromolecular crystals resulting in damage to them.

Crystals induced by high salt concentrations are frequently difficult to cryoprotect owing to the limited solubility of many salts in aqueous/organic mixtures: when a cryoprotective agent is added to a salt-rich mother liquor, the salt precipitates, resulting in damage to the crystal. To circumvent this problem, the salt can be exchanged against another salt of higher solubility in aqueous/organic mixtures [e.g. ammonium acetate (Fink & Petsko, 1981)] prior to the addition of cryoprotective agents. Another option is the replacement of salt molecules in the crystal by cryoprotectants of small size that readily diffuse into the crystal. Several procedures for ensuring minimal osmotic pressure gradients between the crystal interior and the surrounding buffer containing the replacement solute have been described in the literature (Petsko, 1975; Fink & Petsko, 1981; Douzou & Petsko, 1984; Schreuder, Groendijk, van der Laan & Wierenga, 1988; David & Burley, 1991; Ray, Bolin, Puvathingal, Minor, Liu & Muchmore, 1991).

When an extended search for cryoprotective conditions proves unsuccessful, one should consider changing the crystallization conditions. Crystals have been grown from cryoprotective buffers (e.g. Kim & Lipscomb, 1993; Keefe, Ginell, Westbrook & Anderson, 1995). Fortunately, the presence of glycerol can also improve crystal growth (Sousa & Lafer, 1990; Sousa, 1995). In difficult cases, one remedy can be the very

short exposure of a native or cross-linked crystal to the cryoprotective buffer, where only the surrounding liquor is exchanged (Rini, Schulze-Gahmen & Wilson, 1992). Alternatively, a very fast cooling method can be employed on uncryoprotected crystals freed from any surrounding liquor immediately prior to the cooling process (Kurinov & Harrison, 1995).

In Fig. 10, diffraction images recorded at different stages during the establishment of a cryo-protocol for crystals of a hydrogen peroxide catalase point mutant are shown. The crystals were grown from 15% (w/v) PEG

3350 and 1.5 M LiCl in 0.2 M Tris-HCl at pH 9.0 and belong to space group $P2_1$ ($a = 94.1$, $b = 133.7$ and $c = 123.1$ Å; $\beta = 109.4^\circ$) with one tetramer (4×84 kDa) in the asymmetric unit (Bravo, Verdaguier, Tormo, Betzel, Switala, Loewen & Fita, 1995). Crystals mounted in capillaries and exposed at room temperature diffract initially to about 1.9 Å (Fig. 10a), but suffer from severe radiation damage. Although cooling of small amounts of the mother liquor in fibre loops did not reveal any ice formation, attempts to cool the crystals in the mother liquor were not successful. Ice that gave rise to powder

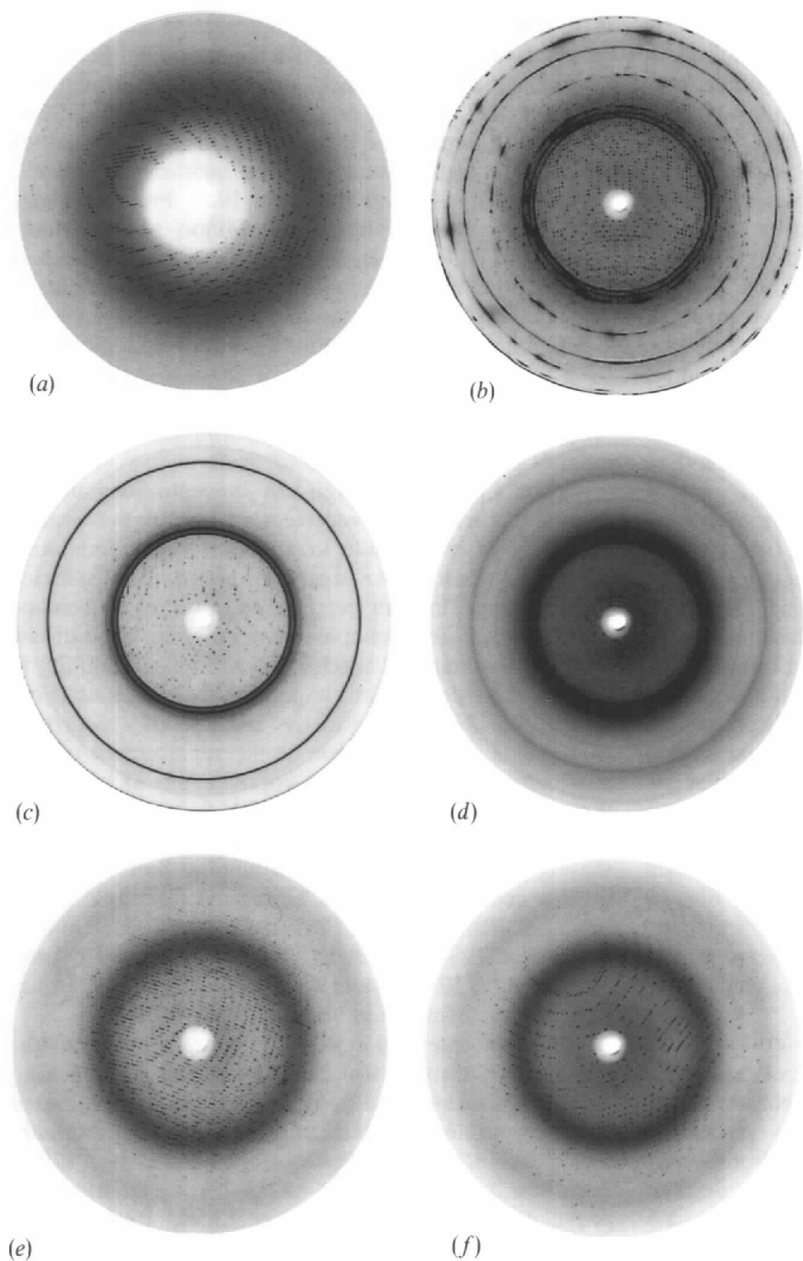

Fig. 10. Diffraction patterns recorded at different stages during establishment of a cryo-protocol for crystals of a point mutant of hydrogen peroxide catalase (Bravo, Verdaguier, Tormo, Betzel, Switala, Loewen & Fita, 1995). Images were taken on beamline X11 at EMBL at a wavelength of 0.927 Å with an oscillation angle of 0.5° . (a) Crystal mounted in capillary at room temperature ($d_{\text{edge}} = 2.0$ Å). (b) Crystal mounted in mother liquor (15% PEG 3350) in a fibre loop ($d_{\text{edge}} = 1.9$ Å) and flash cooled to 120 K in a stream of cold nitrogen gas. (c) The same as (b) but another crystal. (d) Crystal mounted in buffer containing 30% PEG 3350 in a fibre loop ($d_{\text{edge}} = 1.9$ Å). (e) The same as (d) but another crystal. (f) The same as (d) but another crystal; detector moved such that $d_{\text{edge}} = 1.85$ Å.

diffraction rings was formed and the crystals experienced serious damage, leading to an unacceptable increase in mosaic spread (Figs. 10*b* and *c*). Increasing the concentration of PEG 3350 in the cryoprotective buffer to 30% did prevent the formation of ice, but nonoptimal crystal-handling procedures led to partial destruction of crystalline order (Figs. 10*d* and *e*). The optimization of crystal handling, especially by minimization of the time spent between fishing the crystal from the cryoprotective buffer and cooling it in the cold nitrogen stream, allowed crystals to be cooled to 120 K without ice formation and with a mosaic spread increase from 0.2° to 0.3°, which was tolerable (Fig. 10*f*). The use of a loop slightly smaller than the crystal allowed the crystal to be positioned with its longest dimension perpendicular to the rotation axis in order to employ an efficient data-collection strategy. A data set consisting of about 90 000 unique reflections to 2.3 Å previously collected on three crystals could be replaced by a set of 206 000 unique reflections collected on only one crystal to a maximum resolution of 1.9 Å.

6.2. Crystal-mounting instrumentation

An important part of a cryocrystallographic data collection is the method of crystal mounting and the hardware associated with it. Macromolecular crystals require special treatment compared to crystals of small molecules, since the former are not true solids, having a solvent content ranging from approximately 30 to 95% (Matthews, 1968).

For room-temperature data collection, in many cases small-molecule crystals can be glued onto a glass fibre. In contrast, the more aqueous macromolecular crystals easily dehydrate and must be sealed with some mother liquor in quartz or glass capillaries (Bernal & Crowfoot, 1934). However, contact with the capillary walls sometimes causes the crystal to bend, leading to an increase in the rocking widths of the reflections. To some extent this problem can be overcome by the use of flattened capillary tubes, but difficulties still arise for fragile crystals.

Small-molecule crystallographers have collected diffraction data at low-temperatures for many years, cooling crystals that are stuck on to glass fibres with epoxy glue. Dewan *et al.* (Dewan & Tilton, 1987) have used this method for mounting protein crystals. An extension of it was pioneered by Hope (1988), in which the protein crystals are coated in oil, to prevent dehydration, prior to being placed onto a standard small-molecule-type glass fibre soldered into a copper pin for flash cooling. This method has been used successfully for a number of DNA fragments and several proteins (§2). However, the oil sometimes destroys the crystal order and the fibre can cause differential absorption problems when X-rays pass through it. Also, the method cannot be used for fragile crystals, so a design emerged

that uses a very thin small glass 'spatula' attached to the end of the fibre to support the crystal (Hope, Frolow, von Böhlen, Makowski, Kratky, Halfon, Danz, Webster, Bartels, Wittmann & Yonath, 1989). Spatulas were developed that have their plane perpendicular to the pin or parallel with the pin, or which hold the crystal between two layers of thin glass. A method similar to the Hope technique was employed by Ray *et al.* (Ray, Bolin, Puvathingal, Minor, Liu & Muchmore, 1991), who embedded the crystal in vacuum grease on the end of a fine glass capillary and then flash cooled it.

The currently most widely used technique is the loop method described by Teng (1990). Teng originally used a 1–2 mm-diameter gold-plated tungsten wire loop to suspend the crystal by surface tension in a thin film of cryoprotected buffer. Experiments on hen-egg-white lysozyme and myoglobin crystals showed a significant reduction in observed reflection rocking widths over previous flash-cooling mounting methods, owing to the lack of any mechanical distortion of the crystals. The metal loops used by Teng were soon replaced by loops made from various fine (10–50 µm diameter) fibres that do not absorb and scatter X-rays to the same extent as metal, such as hair, fibres of glass, nylon, rayon, fly-fishing threads, unwaxed dental floss, cotton, surgical thread and mohair wool. In Teng's method, the crystal mount reduces to the loop, the loop-holding pin and the hardware for attaching the pin to a goniometer.

In spite of the range of loop fibres used in different laboratories, some useful general guidelines have emerged for loop material and manufacture. The chosen fibre should not show significant scattering or diffraction in the X-ray beam. Glass fibres give very low absorption and scattering, although they are brittle and cannot be bent to a small radius and therefore are harder to make into loops than other fibres. Of other fibres in use, rayon and mohair wool fibres diffract comparatively little, with nylons and dental floss giving more pronounced scattering features, including fibre diffraction. The diameter of the fibre is important, since the smaller it is, the thinner the film of cryoprotected buffer that can be obtained, reducing the background X-ray scatter. However, if the fibre is too thin to support the crystal and film in the gas stream, a compromise must be reached.

There are probably as many methods of loop construction as laboratories doing macromolecular cryocrystallography, and rayon loops are now also available commercially (Hampton Research, USA). A very simple recipe for constructing knotted fibre loops is presented in Table 3, and many laboratories have designed jigs for manufacturing uniform twisted loops. Another technique is to thread the fibre through a short (about 5 mm) glass capillary and then to feed the fibre end back through the capillary, pulling it until a loop of the desired size is obtained. Glue is then applied to the end of the capillary away from the loop to secure the fibre ends. Both this and the twisting method described above tend to produce

Table 3. *A simple cryo-loop-building recipe*

The whole procedure can be carried out under a microscope if this is easier.

Equipment and materials required:

- A piece of polystyrene
- Some needles
- Mohair wool (or the chosen fibre)
- Two pairs of fairly sharp tweezers
- One pair of sharp-ended scissors (*e.g.* dissecting scissors)
- Quick-setting glue
- A microscope slide on which to put dabs of glue
- A mounting pin to hold your loop for data collection
- Some drill bits of the diameter of the desired loop, *e.g.* 0.2, 0.5, 0.75 or 1.0 mm

The procedure:

- (i) Position the polystyrene so it is stable.
 - (ii) Push the selected drill (cutting end) into the polystyrene at a height at which it is comfortable to work.
 - (iii) Pull one fibre out of the mohair wool using the tweezers. (Try to minimize fibre handling with your fingers because otherwise the fibres can become greasy.)
 - (iv) Use fingers or tweezers to tie the wool round the smooth drill end. Tie four reef/square knots (eight knots altogether), to make a stalk of knots.
 - (v) Put a spot of quick-setting glue on the last two knots, and let it dry.
 - (vi) Cut off the excess ends of wool. Move the drill down to near the bottom of the polystyrene box.
 - (vii) Place the mounting pin under the knots and glue them into the hollow pin end. If the drill is at the right height, the pin will sit vertically on the bench with the loop and drill bit above it.
 - (viii) When the glue is dry, use your fingernails to take the wool loop gently off the end of the drill. If there is glue on the drill end, your loop will break at this step!
- NB.* You can twist the wool instead of tying it. This makes 'tear drop' shaped loops, whereas the drill end produces more circular ones.

'tear drop' shaped loops, whereas the method outlined in Table 3 makes more circular ones (Fig. 11). For best results, the amount of glue should be minimized and a low-scattering glue should be chosen.

Variations on the single-loop mounting method are continually developing (*e.g.* Blond, Pares & Kahn, 1995; Nakasako, Ueki, Toyoshima & Umeda, 1995). For instance, two parallel loops mounted one above the other with a small gap can be used to hold the crystal in a sandwich with little or no liquid (Ginell, 1996).

A variety of materials are in use as loop supports: metal pins that fit directly into the goniometer head as used in the original Hope method, flexible narrow gauge wire, fine aluminium and stainless steel pins of various diameters and designs, syringe needles and glass fibres. Many are hollow so that the loop can be stuck neatly into them.

In our experience, there are two overriding design considerations for loop supports. Firstly, their shape and size should be such that turbulence in the cold nitrogen stream is minimized. Secondly, a heat-conducting material should bridge the cold nitrogen/warm gas boundary

of the stream. This avoids the build-up of ice on the pin in nonaxial geometries (§6.7).

There are several ways of connecting the loop-supporting pin to the goniometer head. Two widely used methods are insertion of a pin directly into the hole in the goniometer head and attachment of a magnet to the goniometer head, to which a magnetic pin-holder is attracted and rigidly held (Gamblin & Rodgers, 1993; Rodgers, 1994).

Many pin-holder (so-called 'top hats'; Fig. 8) and pin designs are in use and two are shown in Fig. 12. One of these has a flat surface on one side of the crown of the hat to facilitate handling with tweezers. Some top hats are more like bowler hats in shape, which improves the laminar flow of the cold nitrogen stream for coaxial geometries. For crystal storage in a cryovial (Rodgers, 1997) and subsequent transport and retrieval, certain design features are helpful. One of these is a vent right through the top hat to allow nitrogen in and out of the cryovials (Fig. 12). A facility to adjust the pin length is advantageous, since the total height from the base of the hat to the top of the loop should stay approximately constant. This avoids ice formation caused by the crystal moving out of the centre of the cold nitrogen stream during retrieval.

Any metal parts of the crystal-mounting hardware should be coated with noncorroding material, since both salt-containing buffers and water gradually attack them. Even stainless steel eventually becomes rusty and uneven. For top hats, pure nickel or nickel-plated magnetic stainless steel are ideal choices.

When 'fishing' for (trying to pick up) and transferring crystals, it is helpful to use self-opposing tweezers that

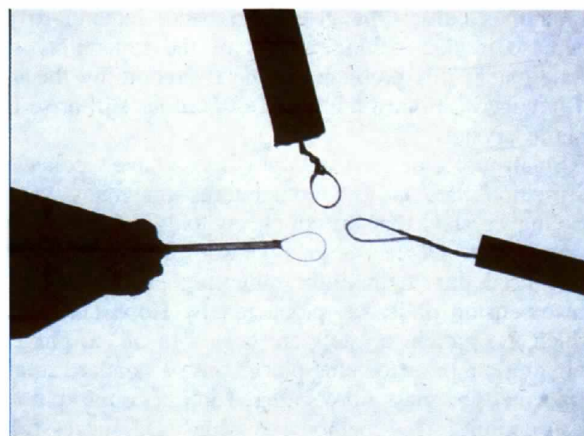

Fig. 11. Three different fibre loops. Left: dental-floss fibre loop made in a glass capillary. The capillary is then trimmed and glued onto a hollow metal pin. Centre: mohair knotted loop glued into a hollow aluminium pin. Right: twisted mohair loop glued into a hollow stainless steel pin.

hold the pin or top hat firmly. A pair of tongs has been designed by Hope (1996) in which extra jaws made of a split piece of stainless-steel cylindrical bar are welded onto the ends of ordinary tongs, the bar being perpendicular to the plane of the tong handles. These jaws have a hole drilled in them that is the same diameter as the pin or top hat to achieve a firm grip when the jaws are together. The mass of stainless steel can be precooled in liquid nitrogen and used to keep the crystal cold for up to half a minute during transfer and storage operations (§6.6).

6.3. Crystal mounting and transfer

For crystal mounting, a suitable loop is first selected. The size and shape of the loop depend on the size, shape and mechanical properties of the chosen crystal and whether the crystal has to be in a certain orientation. Sturdy crystals can be picked up with loops that are smaller than the crystal, allowing the crystal to be scooped out of the buffer in a chosen orientation. For very fragile crystals, especially for thin plates, a loop larger than the crystal is advantageous, the drawback being that it is sometimes difficult to locate the crystal after cooling. Prior to crystal mounting, the loop should be cleaned with alcohol or clean water, dried by dabbing on soft tissue paper and prealigned on the X-ray camera. It should also be checked for extraneous material, since any protruberances can cause stream turbulence or lead to a thicker film of liquid.

For final equilibration with the cryoprotective buffer, a crystal should be transferred into a convenient well (e.g. a round-bottomed microbridge). If the crystal sticks

to the surface of the well, the loop can be used to detach it. Otherwise, the loop should not touch the crystal. Gentle stirring of the liquid with the loop in an upward direction will bring the crystal up to the meniscus, where it should stay for some time and can be picked up. The crystal is caught by a swift upward motion of the loop alongside the crystal and out of the liquid. The loop will form a film of liquid into which the crystal will be drawn by surface tension. Very thin films, which are preferable in terms of cooling rates and background during X-ray data collection, can be obtained by moving the loop out of the liquid with its plane perpendicular to the surface of the drop. If the crystal sinks too fast to the bottom of the well to be picked up from the meniscus, it is advantageous to use a flat depression well. In such a well, the crystal can be manoeuvred into a small 'bay' of liquid and picked up with a more horizontal motion.

Evaporation from the film is very rapid because of its large surface-to-volume ratio. Therefore, one of the most critical parameters in a cryocrystallographic experiment is the time between picking up the crystal and flash cooling it. This time should be as short as possible, ideally less than 1 s, otherwise the crystal can dehydrate or components of the buffer can precipitate. The microscope and the goniostat should be as close to each other as possible and all obstacles should be removed beforehand. All manipulations and motions should be practised on several 'dry runs' with nothing in the fibre loop, to ensure smooth and rapid operation later on. This is especially important when working on an unfamiliar set-up, e.g. on a synchrotron beamline. No time should be wasted in viewing the crystal within the loop, since flash cooling an empty loop is less harmful than losing crystals before cooling by stopping to check whether they really are in the loop.



Fig. 12. Two different top-hat and pin designs, used at EMBL-Heidelberg (left, reproduced by kind permission of Paul Tucker) and at the Laboratory of Molecular Biophysics, Oxford (right), respectively. The small lateral Allen screw enables the overall length to be adjusted in both designs. The hats are held on the goniometer by a magnetic rubber disc.

6.4. Flash cooling

As already described (§4), achieving a fast cooling rate is vital to avoid ice formation. Two physical properties of the crystal combine to affect the rate of heat transfer during flash cooling. These are the heat-conduction rate through the crystal and the shape of the crystal, in particular its surface-to-volume ratio (S/V). The heat-conduction rate varies between crystal types, being dependent on the properties of the particular protein crystal (solvent content, packing, mother-liquor composition *etc.*) and cannot easily be controlled by the experimenter. However, often a selection can be made between different crystal shapes. Crystals with larger values of S/V will cool faster than those with smaller S/V , where larger temperature gradients occur between the surface and centre of the crystal, causing greater thermal stress. This stress can result in differential shrinkage or expansion, hence sometimes increasing the mosaic spread and reducing the observed resolution (e.g. Chen & Herzberg, 1992). In our experience, better

results are generally obtained from crystals with S/V above 12 mm^{-1} . For example, the surface-to-volume ratios of cubic crystals of sizes 0.4^3 mm , 0.5^3 mm and 0.6^3 mm are 15, 12 and 10 mm^{-1} , respectively, whereas for a rectangular crystal of size $0.2 \times 0.4 \times 0.5\text{ mm}$, S/V is 19 mm^{-1} . Needle-shaped crystals can have high values of S/V (e.g. for a crystal of size $0.1 \times 0.1 \times 0.8\text{ mm}$, S/V is 43 mm^{-1}) but nevertheless may be difficult to cool homogeneously. For optimum results, it may be necessary to cut such crystals into shorter pieces.

Crystals can be flash cooled either as already described in a stream of gaseous nitrogen [melting point (MP) 63 K, boiling point (BP) 78 K], or plunged straight into liquid cryogens such as nitrogen, propane (Thomanek, Parak & Wintergerst, 1977) (MP 86 K, BP 231 K), ethane (MP 90 K, BP 184 K), freon 12 (MP 115 K, BP 243 K), freon 22 (MP 113 K, BP 233 K) or methylcyclopentane (Ray, Bolin, Puvathingal, Minor, Liu & Muchmore, 1991) (MP 130 K, BP 345 K). There is some debate concerning the effective cooling rates obtained with each of these methods. Measurements are notoriously difficult to make because of the heat brought into the system by the measuring device itself. Values compiled from electron-microscopy literature, although not entirely internally consistent (Plattner & Bachmann, 1982), imply that, in the range between 293 and 193 K, the fastest cooling rate is obtained with propane at close to liquid-nitrogen temperatures.

However, these observations are at variance with those reported by Hope (1994), who measured cooling rates for a bare and for a cement-covered (0.75 mm -diameter sphere to simulate the thermal mass of a macromolecular crystal) thermocouple cooled to 140 K. For both the bare and the cemented thermocouple, Hope concluded that liquid nitrogen was the fastest coolant, taking 0.15 s (bare) and 0.6 s (cemented) to reach 140 K. Liquid propane took 0.18 s (bare) and 1.2 s (cemented), and gaseous nitrogen was slowest at 0.8 s (bare) and 2.0 s (cemented). It is generally thought that liquid propane is fastest because it tends not to form as many insulating bubbles of gas round the sample as liquid nitrogen, although possibly for small samples such as protein crystals the gas bubbles formed in liquid nitrogen do not retard the cooling rate. It should be noted that a large temperature difference quickly builds up between the base and the surface of a volume of liquid propane, unless it is thoroughly stirred.

In practice, liquid propane, liquid nitrogen and gaseous nitrogen are all commonly used for flash cooling macromolecular crystals. For storing crystals, some experimenters prefer a propane bath, which solidifies when immersed in liquid nitrogen and forms a 'lollipop' ('popsicle') with the crystal inside. When the crystal is required for data collection, the 'lollipop' can be placed onto the usual goniometer head and the solid propane evaporates away in the

cold gas stream. However, there are additional safety considerations that must be addressed when propane is used (§6.9).

To increase the cooling rate and to achieve reproducibility, various devices have been developed to plunge the crystal swiftly into liquid nitrogen or propane. For instance, ribosome crystals have been flash cooled by being plunged into liquid propane and then transferred into the cold nitrogen gas-stream by a simple mechanical flipping device (Hope, Frolow, von Böhlen, Makowski, Kratky, Halfon, Danz, Webster, Bartels & Yonath, 1989). Other devices are available in some laboratories. For example Abdel-Meguid *et al.* (Abdel-Meguid, Jeruzalmi & Sanderson, 1996) have described a system in which a simple propane plunger attaches to the cold-stream nozzle so that, on removal of the cryovial of propane, the crystal is already in the gaseous nitrogen stream and can then be transferred *in situ* onto the goniometer with tweezers. Note that plunging the crystal into liquid cryogen carries the risk of losing the crystal on impact.

For most protein crystals, flash cooling in a gas stream is perfectly adequate and represents the safest and simplest option. From a practical standpoint, for gas-stream flash cooling it is helpful at first to have a second experimenter present who can divert the cold gas stream by holding a piece of card over it as soon as the 'fisher' signals that the crystal is caught. Once the crystal is positioned, the card is then swiftly whipped away ensuring rapid and reproducible cooling. Experienced cryocrystallographers tend to divert the cold gas stream themselves or do not divert it at all while placing the crystal on the goniometer head, success depending on the quickness and certainty of their action. Other experimenters switch off the outer dry air/nitrogen stream while flash cooling to prevent unnecessary dehydration of the crystal and film as it passes through the warm dry stream.

6.5. Data collection

Although once a crystal has been flash cooled data collection can proceed in the same manner as at room temperature, there are a few additional points to be considered.

Centring of the flash-cooled crystal in the X-ray beam can be surprisingly difficult. The refractive index of the crystal and surrounding amorphous glass are often very similar, making the crystal hard to locate. This is especially true if the loop is much bigger than the crystal. A hand-held light is useful for providing illumination from different directions. A more sophisticated solution is to view the loop and the crystal through crossed polarizers. Sometimes the loop can appear to be moving, as though being blown by a breeze. In most cases this effect is an optical illusion due to the different refractive

index of the room air and the gas of the cold nitrogen stream.

Since all the data can usually be obtained from one crystal, no compromises are necessary in data collection. In most cases, only one continuous run is necessary, allowing simple data-collection strategies. For data collection from crystals of low-symmetry space groups, a flexible wire pin (*e.g.* platinum) can be used, which can then be bent into a completely different orientation to access missing parts of reciprocal space (David, 1996). This is especially useful on goniometers having only one axis of rotation, which results in a cusp of inaccessible data (the blind region). An alternative method is to use a swivel device or an arc that can rotate the crystal through 90° on the goniometer head, as implemented in some storage and retrieval devices (§6.6).

Once data collection at 100 K is under way, the only difference from room-temperature data collection is that regular checks should be made for ice formation (§6.7), both as evident on the crystal or as indicated by powder rings on the diffraction pattern, since once ice appears it will continue growing. Ice can be cleaned off the crystal very carefully with a needle or fine artist's brush, but this procedure carries a risk of loss of the crystal. If ice rings do appear in the diffraction pattern, data may still be processed to give useful information. However, the data quality and completeness will be compromised.

A hidden advantage of cryocrystallography is that there is no crystal slippage during data collection. Thus, once indexing has been successful, there should be no substantial change in the setting angles.

6.6. Crystal storage and transport

One of the enormous advantages of cryocrystallography is the potential for storing and/or transporting crystals once they have been flash cooled. There are several reasons why this can be beneficial. First, the crystals can be screened at 100 K in house and the better-quality ones earmarked for synchrotron data collection. Second, the crystals might grow to a limiting size and subsequently degrade. Such crystals can be flash cooled while in peak condition and stored until data collection facilities are available. Third, the required data need not be collected all at one time: incomplete data can be made more complete at a later date using the same stored crystal. Fourth, fragile crystals suffer less damage during transportation when in a frozen matrix than when suspended in a liquid buffer. Last, temporary storage of crystals for up to a few hours for on-line crystal screening enables the best sample to be selected for a full data collection.

The steps involved in storing a crystal that is in a gaseous nitrogen stream are illustrated in Fig. 13. The holding magnet is mounted on an adapted goniometer head (see Fig. 13a) equipped with an attachable asymmetric arc (or equivalent: see below) and a movable

platform (see Fig. 13b). This arrangement enables the crystal to remain in the same position in the cold stream when rotated to point downwards (see Fig. 13c). A small plastic container filled with a liquid cryogen, a 'cryovial', is then brought up around the crystal and the whole top hat removed into the vial (see Fig. 13d). The vial is then immediately transferred into liquid nitrogen.

The equipment required for crystal storage, transport and retrieval is still under development in many laboratories so some possible options are described. The main basic pieces of hardware required are: cryovials for holding the top hat (Rodgers, 1997) or a similar arrangement, a liquid-nitrogen storage dewar with a method of organizing the cryovials (*e.g.* cryocanes), an asymmetric large-arc goniometer, a small liquid-nitrogen dewar or a small Styrofoam box for filling the vials and initial storage, and pairs of protective gloves and goggles.

Dewars for storing biological cultures that have metal canes for holding cryovials are commercially available. Usually, up to six 1.5–2.0 ml volume cryovials can be held on one cane and a 25 l dewar can accommodate up to six protective cylinders on rods each taking up to three canes. Small (around 2 l) stainless-steel dewars as deep as a cryocane are ideal for providing a working volume of liquid nitrogen. For transporting stored crystals safely, 'dry' dewars with carrying cases are available. These are precooled with liquid nitrogen and contain an adsorbent

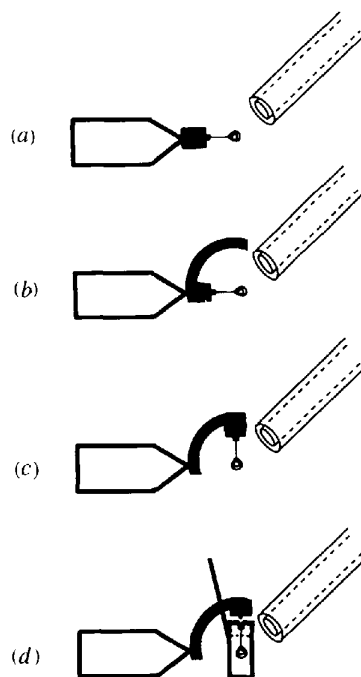

Fig. 13. Steps in the crystal storing procedure. In (a) a modified goniometer is shown and the removable arc has been attached to this in (b). In (c) the crystal has been moved to the vertical position and in (d) a cryovial is brought up for crystal removal and storage.

matrix that remains cold for up to three weeks if the dewar is not opened. They are unpressurized and allowed by most airlines, although it is worth checking this and obtaining written agreement before arriving with it at the airport. Note that, if warmed up, these dry dewars should be thoroughly dried out to clear the adsorbent matrix of any water.

The size of the cryovial used will affect the design of the pin and the top hat. The dimensions of the top hat should be chosen such that the crystal is firmly held upside down in the liquid cryogen. The vial and/or the hat has holes drilled in it to allow liquid nitrogen in and to act as a gas vent (Fig. 12).

As already mentioned, an extension arm for the goniometer head is valuable to facilitate crystal storage. The angle through which the crystal + pin must be moved depends on the type of goniometer on the equipment. On a goniometer with a horizontal φ axis only a 90° movement is required, whereas on one with a vertical φ axis a rotation of 180° must be provided, and on a three-circle goniometer 135° are needed. Various designs of large-arm goniometer (Rodgers, 1997) have been developed. Designs fall broadly into three categories: those with a nonremovable arc, those with a removable arc (Engel, Wierenga & Tucker, 1996) and Charles Supper (USA), and those with a simpler flipper arrangement (Mancia, Oubridge, Hellon, Woollard, Groves & Nagai, 1995). Examples of the last two of these are shown in Figs. 14 (Pickford, 1996) and 15 (Mancia, 1996). It is most convenient if the arm is removable so that it does not interfere with data collection. The flipper-arm design

(Fig. 15) is significantly easier than the arc to fabricate, since no accurate jigs are required.

The 'tongs' already described in §6.2 are a useful alternative to removable arcs or flippers, since they can be precooled in liquid nitrogen and used to transfer the crystal from the goniostat to the storage dewar. It is possible, if the experimenter has a very steady hand, to use self-opposing tweezers to remove the crystal, rotate it in the stream, and store it successfully in a vial without the use of an extension arm/arc.

Once the crystal has been placed in the vial, it is put into an intermediate storage dewar and allowed to equilibrate before being transferred to a cryocane and then into a long-term storage dewar.

The vials containing the crystals must be systematically labelled at room temperature before storage to avoid confusion later on. If they are to be taken to another data-collection facility, it is also important to find out the geometrical constraints on the goniometer and cold stream at the other site before storing the crystals, since the pin length may need changing, smaller cryovials may have to be used to be compatible with the local arrangement or the removable arc may not have a large enough angular range to retrieve the crystals.

Crystals are retrieved from storage by a reversal of the procedure used for storage. An empty loop on a pin, which is the same length as those of the stored crystals, is first aligned on the extended-arm goniometer. If the retrieval is on a different X-ray camera from the storage, a 'dry run' with an empty vial and empty loop is helpful in order to check the space available for manipulation. A

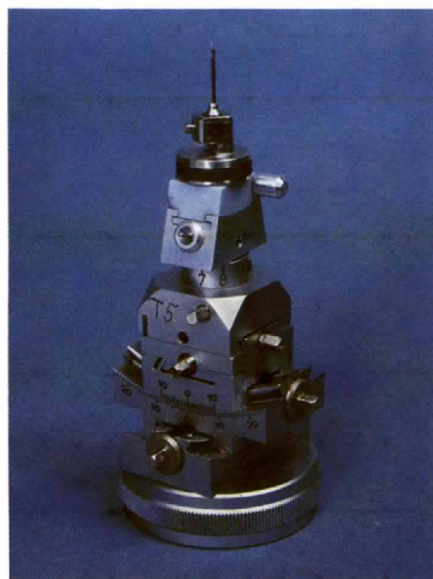

(a)



(b)

Fig. 14. Removable arc for use in crystal storage (Pickford, 1996). It has a very light weight (aluminium alloy) removable 90 to 180° arc with a plastic sliding platform for the magnet + top hat + crystal. It is shown (a) without and (b) with the arc.

major practical consideration is that all the loops holding the crystals must be the same distance above the base, so that any stored crystal chosen for data collection is already approximately aligned when retrieved.

Storage dewars should not be opened unless really necessary, since the liquid nitrogen in them becomes contaminated with moisture from the air, subsequently forming 'snow' that floats on the top. This can result in ice formation on the crystal during retrieval.

6.7. Ice-free environment

The most common difficulty experienced by experimenters starting to use cryotechniques is ice around, near, on and in the crystal. By attention to the details mentioned below, it is possible to eliminate icing entirely. Table 4 summarizes the potential ice problems, their possible causes and the remedial action that can be attempted.

During a diffraction experiment, ice can appear immediately after or during flash cooling or it can nucleate and gradually grow in various locations. This can result in lower-quality diffraction images. Therefore, the state of the crystal and its environs should be checked regularly during the experiment, since small amounts of ice can be carefully removed.

Ice in the thin film supporting the crystal is usually a result of insufficient cryoprotection of the buffer. This

can happen even if a cryoprotection protocol has been established as described in §6.1 and there are three possible reasons for ice occurring at this stage. First, too large a volume of the mother liquor might have been added with the crystal to the cryoprotected buffer, resulting in dilution to a point where the cryoprotection was inadequate. Second, the film formed around the crystal might be thicker than in previous tests, resulting in a larger volume that has to be cooled. In both these cases the cryoprotective agent concentration can be increased by 5% before another crystal is tried. A third reason for ice forming in the thin film is that the crystal has been cooled too slowly (§4).

If the cold stream is temporarily diverted from the crystal position by a draught, the thin film may melt and recool too slowly, causing it to form internal ice. The draught can be the result of opening and shutting of the doors of the shelter, turning air conditioners on and off, or the hot breath of experimenters.

There are several reasons for ice forming around the crystal. The end of the cryonozzle may be positioned too far from the crystal: ideally it should be as close as possible since the temperature profile of the cold nitrogen stream is very sharp (the temperature rises from 100 K to room temperature over a few millimetres for most open-flow cryostats). In addition, further away from the nozzle the gas stream becomes dissipated and is thus more susceptible to the effects of turbulence

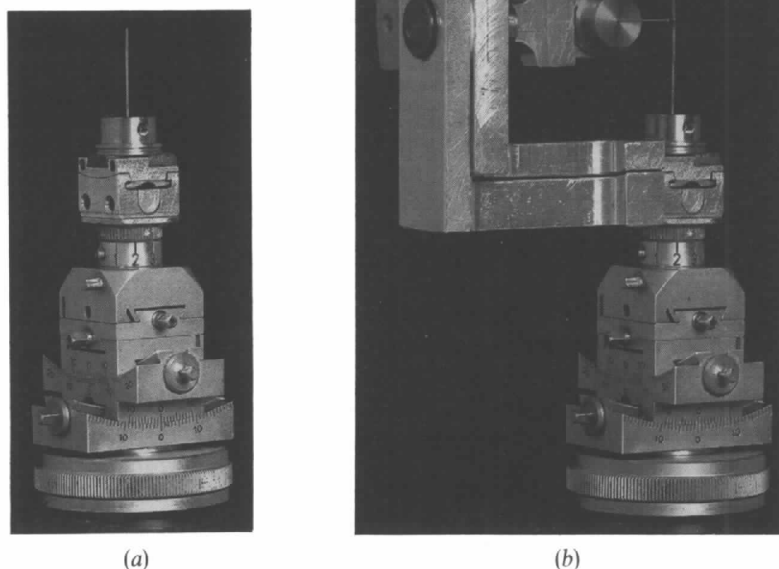

Fig. 15. Removable flipper for use in crystal storage (Mancia, 1996). It allows a rotation of up to 180° about a pivot and can thus be used on all types of goniometer. The basis of the device is an arc from an old goniometer head, which holds the magnet and has four locating holes in the side arranged in a square for the removable pivot arm [see (a)]. The pivot arm consists of two 'L'-shaped strips of metal each with two locating pins that fit into the old head above and below the arc. The strips fit inside one another and are attached to each other by a rotating joint at the top. The arc + top hat + crystal can then be rotated on the inner arm to any convenient position for storage. (b) shows a multiple-exposure view of the flipper in three different positions.

Table 4. *Troubleshooter's guide to ice*

Location	Possible causes	Remedy
(i) Ice in thin film supporting crystal	Cryoprotectant conditions are not optimized	Check cryoprotected buffer alone
	Too much mother liquor added with the crystal to the cryoprotected buffer	Increase cryoprotectant-agent concentration by 5% or optimize crystal transfer
	Melting and re-cooling	Avoid
(ii) Ice around crystal	Cryonozzle not centered properly	Check alignment (cryoalignment tip)
	Cryonozzle too far away	Move it in as close as possible
	Draught in the shelter/hutch	Switch off fans Shield rotating-anode fan belt Flow dry air through enclosure Polyethylene film tent Perspex box
(iii) Ice on the pin	Cold and warm gas-flow velocities not matched	Adjust warm-gas rate
	No heat-conducting path between the cold and warm gas streams?	Make pin from metal
(iv) Ice/snowball on loop	Insufficient cleaning of loop	More care next time
(v) Ice on cryonozzle	Dry gas stream not switched on	Switch it on
	Dry gas not really dry	Check drier is operating properly
	Dry gas stream not concentric with the cold gas	Adjust outer tube
(vi) Ice on the goniometer	An obstruction in the dry gas exit (<i>e.g.</i> Plasticine)	Remove it
	Draughty environment?	See (ii) Heat the goniometer Shield with aluminium foil Put heated Teflon cone on head
(vii) Ice inside dewar	Top of dewar not properly covered	Install proper plug
	Moisture in liquid nitrogen supply	Install line drier
	Old liquid nitrogen	Replace with fresh liquid nitrogen

and draughts. If placing the cryonozzle near the crystal results in a shadow on the X-ray detector, thought should be given to changing the angle of approach of the stream. If this proves impossible, the shadow can be masked out during data processing.

It is also very important that the cold nitrogen stream is centred properly so that the crystal is both in the coldest part of the stream and as far away as possible from the boundary between the cold gas and warm dry gas/air. An empty loop can be placed on the goniometer to aid alignment, or a pin device that attaches to the cryonozzle can be used (Mitchell & Garman, 1994).

A question that often arises concerns the optimum angle of incidence of the cold stream on the crystal. This is not an important factor in a draught-free and carefully monitored experiment. However, most cold streams operate better with the gas flowing downwards. Also, experimental constraints must be taken into account. For instance, for crystal storage enough space must be available to allow cryovial access.

If the cold gas stream is not coaxial with the pin attached to the fibre loop (as is usually the case for a three-circle, four-circle or κ goniostat), a localized pile of ice can build up where the pin bridges the boundary between the cold gas and warm dry gas/air. Eventually the ice reaches the crystal and causes ice scattering

and absorption of the diffracted X-rays. Although the presence of the pin will always cause some turbulence in the nitrogen flow, this particular problem can be eliminated by the use of a metal pin that conducts some heat into the area. If the pins are made from heat-insulating materials such as glass and plastic, they can become too cold, creating a local environment conducive to ice formation by moisture in the warm 'dry' gas/air (commonly used 'dry' air has a finite dew point of about 210 K, which is still well above 100 K).

Ice can form on the fibre loop if it has not been cleaned adequately. In the presence of any turbulence to the nitrogen stream, protuberances can act as nucleation points for ice formation and then this ice causes additional turbulence, compounding the problem.

In general, a major reason for ice formation is turbulent flow at the boundaries between the cold gas and warm coaxial stream and between the latter and warm wet air in the room. To prevent this and to allow the desired laminar flow, the flow velocities of the cold and warm dry gases must be matched. To match the flows, the relative areas of the two gas streams can be calculated and the rates scaled accordingly.

Disturbance to the cold stream also arises when there are draughts within the radiation shelter or synchrotron hutch, since new humid air will be sucked into the

crystal environment increasing the probability of ice formation. For in-house shelters, the situation can be greatly improved by the switching off of all shelter fans and if necessary also continuous purging of the shelter with dry air. The motion of the rotating-anode fan belt is also a major source of air disturbance and a screen around the anode tower will prevent this. At a synchrotron, such measures are usually unnecessary, although if required the simplest and cheapest solution is to build a tent of flexible wire and polyethylene film around the crystal. A more elegant solution, which completely eliminates this problem, is illustrated in Fig. 6. However, if the area is not too draughty, it is generally possible to work without a box or tent.

Ice and snow can appear on the cryonozzle and gradually invade the crystal position, in extreme cases forming a large snowball around the crystal. If so, the concentric dry gas supply may not have been switched on, or the gas may not be as dry as it should be. If the ice appears asymmetrically around the nozzle, the dry-gas delivery tube is probably not concentric with the cold gas tube. Localized patches of ice can appear on cryonozzles if foreign bodies (*e.g.* small balls of Plasticine from experiments with capillary-mounted crystals) are lodged up the dry gas tube. If ice on the cryonozzle is a permanent feature, it may be necessary to surround the end with a heated Teflon cone (Hope *et al.*, 1989).

The goniometer and goniostat may also become covered with ice. The simplest remedy is to wrap the head in aluminium foil. Alternatively a disc can be placed under the magnetic mount to deflect the cold stream away from the goniometer. A more permanent conical deflector can also be constructed to fit round the top of the goniometer head. Once formed, ice on the goniometer can be removed during an experiment by the pipetting of methanol onto it. A more sophisticated solution is to build an electric heater for the goniometer head, for instance a chain of resistors wound around the head. Alternatively, a heated Teflon cone can be fitted over the adjustment arcs and translations (Hope *et al.*, 1989), or a heated metal plate and crystal holder can be attached to the top of the goniometer head (Engel, Wierenga & Tucker, 1996).

Lastly, ice can accumulate in the supply dewar causing unnecessary and avoidable blockages in the cooling device. This is most commonly the result of water contamination infiltrating the liquid-nitrogen supply. Although most commercially supplied liquid nitrogen is in fact very dry, water is often introduced during transfer and use. If the nitrogen gas is at room temperature at any point in the cooling process, the installation of a line drier (Oxford Cryosystems, UK) is well worthwhile. For systems using a nonpressurized dewar, most ingress of moisture can be avoided by fabrication of a top that seals the nitrogen dewar well. This plug can be made out of a plastic (*e.g.* acetal), with a hole for the nitrogen leg, a hole to allow the nitrogen level to

be measured and an *O* ring on the edge that bears on the top of the dewar to allow the escape of gas if the dewar becomes overpressurized. 'Viton' *O* rings withstand cycles of hot and cold much better than general-purpose *O* rings. Since humid air is also sucked into open nitrogen dewars during refilling, dewars should be regularly (approximately every three months if being continually 'topped up') emptied, allowed to reach room temperature and then thoroughly dried out with warm air.

In crystal-storage dewars, build-up of ice can be significant over time, especially if the dewar is opened frequently for crystal retrieval or further storage. White 'snow' can be observed floating on top of the liquid nitrogen, and this will greatly increase the probability of ice formation during retrieval. In such circumstances, the contaminated liquid nitrogen should be exchanged as soon as possible.

6.8. Structure solution and refinement

Data collected at cryogenic temperatures are superior to data recorded at room temperature in many respects and generally facilitate smoother progress in structure solution and refinement, often making the difference between success and failure. However, the use of cryoprotectants and the fact that the system is observed at a temperature very different from that of its normal habitat induce changes that can create complications in structure solution and refinement. These must be taken into account when results obtained at cryogenic temperatures are interpreted in terms of structure and function at ambient temperatures.

Additional problems may be encountered, especially when multiple isomorphous replacement (MIR) is used for initial phasing. Changes in the unit cell or in the structural and thermal parameters can add to already existing nonisomorphism between native and derivative crystals. To minimize these effects, native and derivative crystals should be cooled by the same procedure and data should be collected at the same temperature.

When experiments are carried out at different temperatures on very similar or identical macromolecules that crystallize with closely related unit-cell parameters, the molecule often has to be positioned by a rigid-body translation/rotation prior to any refinement or calculation of electron-density maps. In some cases, an alternative method is to scale all coordinates to the new cell constants, since often the changes in fractional coordinates are small.

The effects of temperature on the overall structure are relatively limited and mainly concern small movements of secondary structure elements or entire domains relative to one another. In contrast, atomic displacement parameters and multiple-site disorders both exhibit pronounced temperature dependence due to the 'freezing out' of dynamic processes at lower temperatures

(Frauenfelder *et al.*, 1987; Parak, Hartmann, Aumann, Reuscher, Rennekamp, Bartunik & Steigemann, 1987; Earnest, Fauman, Craik & Stroud, 1991; Tilton, Dewan & Petsko, 1992; Young, Tilton & Dewan, 1994; Kurinov & Harrison, 1995; Schneider, 1996a). A number of physical and chemical parameters, such as the dielectric constant and the protonic activities, are temperature dependent (Douzou & Balny, 1978) and can lead to subtle changes in the structures observed at low temperatures. The most important are changes induced by the binding of cryoprotectant molecules (Schneider, 1996a), especially when binding takes place in regions of particular interest. For example, the cryoprotectant glycerol was found to be a competitive substrate in inhibitor-binding studies on glycogen phosphorylase *b* (Watson, 1996). The complexes of interest could be characterized only after MPD was used for cryoprotection. It should be borne in mind that, when data to only relatively low resolution are available, cryoprotectant molecules might not be identified as such in electron-density maps and thus might give rise to misinterpretations of the protein structure.

6.9. Safety

An aspect of using cryogenic techniques that is often neglected is consideration of the potential hazards of work with cryogenics and cryogenic equipment. Before starting any experimental work involving cryogenic temperatures, all experimenters must become familiar with the potential hazards and the actions to be taken if an accident occurs. Some basic facts are given here and more information is given in work by Sitte, Neumann & Edelmann (1987) and Ryan & Liddicoat (1987) and in the references therein.

To avoid implosions, pieces of equipment kept under vacuum should be handled with care, especially if they are made from glass. One must always remember that many materials commonly used in the laboratory change their properties dramatically when exposed to liquid-nitrogen or lower temperatures (*e.g.* most plastics become brittle upon cooling). Home-made equipment should never be operated before an experimenter experienced in using cryogenic techniques has been consulted.

Liquid nitrogen should be used only in well ventilated areas, since 1 l of liquid nitrogen will produce approximately 700 l of gas on evaporation. In rooms that are not well ventilated, gaseous nitrogen can accumulate and reduce the relative oxygen content of the air to a level at which, without warning, a human being will suffer sudden asphyxia followed by deep unconsciousness. Liquid nitrogen can inflict serious skin burns if improperly handled. Appropriate gloves and goggles should be worn whenever dewars are being filled or changed.

Liquid cryogenics used for plunging techniques (*e.g.* liquid propane, ethane or halogenated hydrocarbons kept well below their boiling temperature) cause serious

damage to skin and eyes upon contact. Protective shields must be used.

Gaseous ethane and propane can form explosive mixtures with air (Ryan & Liddicoat, 1987), and appropriate precautions must therefore be taken.

7. Current activities and outlook

There are many areas of macromolecular crystallography where the use of cryogenic techniques has had a major impact.

Structure determinations using the 'classical' phasing methods based on MIR and molecular replacement (MR) have profited from higher-quality data obtained from flash-cooled crystals [*e.g.* Freymann, Down, Carrington, Roditi, Turner & Wiley (1990), Rini, Schulze-Gahmen & Wilson (1992), Day, Hsu, Joshua-Tor, Park, Zhou, Adams & Rees (1992) and Nissen, Kjeldgaard, Thirup, Polekhina, Reshetnikova, Clark & Nyborg (1995) (MR) and Brown, Jardetzky, Gorga, Stern, Urban, Strominger & Wiley (1993) (MIR)]. In several cases, where structure solution by MIR was not possible on the basis of room-temperature data because of radiation damage, interpretable initial electron-density maps could be derived from low-temperature data (*e.g.* Lima, Wang & Mondragon, 1994).

Multiple anomalous dispersion (MAD) methods (Hendrickson, 1991; Smith, 1991) have become more widely used with the increasing availability of synchrotron radiation sources offering tuneable wavelengths. Since these methods rely on small differences between measured structure factors, the collection of very accurate data is essential. The success rate of the method is enhanced when all the data are collected from a single nondecaying crystal, minimizing problems otherwise caused by nonisomorphism and/or radiation damage. Given extremely high-quality MAD data, detailed electron-density maps can be calculated based exclusively on measured structure factors and measured phases (Burling, Weis, Flaherty & Brünger, 1996). This approach eliminates the uncertainties encountered in structure determination caused by model-bias introduced during refinement (Hodel, Kim & Brünger, 1992).

Ab initio methods (*i.e.* those based purely on measured structure factors) for structure solution have recently been applied successfully to several large oligopeptides and small proteins (Pohl, Heine, Sheldrick, Dauter, Schneider, Wilson & Kallen, 1995; Frazao, Soares, Carondo, Pohl, Dauter, Wilson, Hervas, Navarro, De la Rosa & Sheldrick, 1995; Weeks, Hauptman, Smith, Blessing, Teeter & Miller, 1995; Anderson, Weiss & Eisenberg, 1996). The use of cryogenic techniques will significantly extend the range of structures that can be solved by these methods, which rely on complete good-quality high-resolution data.

Cryocooling has in a number of cases enabled the collection of data beyond 1.0 Å on macromolecular

crystals (Dauter, Lamzin & Wilson, 1995). The large number of unique reflections contained in such a data set allows for the refinement of more detailed models while maintaining the ratio of observables to parameters within an acceptable range. In principle, restraints normally used in the refinement of macromolecules can be loosened or turned off completely, allowing an unbiased view of macromolecular geometry. Additional parameters that can be refined include anisotropic displacement parameters and disorder. The analysis of such quantities can lead to new insights into the properties of proteins in the crystalline state (Stec, Rongsheng & Teeter, 1995; Schneider, 1996*b*).

Cryoenzymological experiments inside crystals (Fink, 1976; Makinen & Fink, 1977; Fink & Petsko, 1981; Douzou & Petsko, 1984) allow the structural characterization of transient states in reactions mediated by proteins. Once populated to a sufficient degree, intermediate states can be stabilized by cryocooling of the crystal, allowing collection of X-ray data (Rasmussen, Stock, Ringe & Petsko, 1992; Chen & Herzberg, 1992; Ding, Rasmussen, Petsko & Ringe, 1994). However, in some cases temperatures well below 77 K are required to allow the characterization of nonequilibrium states, as for example in crystallographic studies on photolyzed carbonmonoxy-myoglobin (Schlichting, Berendzen, Phillips & Sweet, 1994; Teng, Srajer & Moffat, 1994; Hartmann, Zinser, Korninos, Schneider, Nienhaus & Parak, 1996). Similarly, the preservation of defined redox states for the duration of a crystallographic data collection represents a major experimental problem at room temperature, which can be solved by stabilization of the system at cryogenic temperatures (Watt, Tulinsky, Swenson & Watenpaugh, 1991; Day, Hsu, Joshua-Tor, Park, Zhou, Adams & Rees, 1992; Williams, Fülöp, Garman & Hajdu, 1996; Walsh, McCarthy, Higgins, O'Farrell & Mayhew, 1996).

Crystallography on three-dimensional crystals of membrane proteins and viruses is experimentally difficult in many respects. Application of cryogenic methods holds promise in overcoming some of the problems involved and encouraging advances are currently being made (Hobough, Song, Cheley, Shustak, Bayley & Gouaux, 1995; Lee, Chan, Law, Kwon & Jap, 1995; Rossmann, 1996). Similarly, very large molecules and molecular conglomerates are now within the reach of structure determination by cryocrystallographic methods (Volkman, Hottenträger, Hansen, Zayzev-Bashan, Sharon, Berkovitch-Yellin, Yonath & Wittmann, 1990; Andersen, Thirup, Nyborg, Dolmer, Jacobsen & Sottrup-Jensen, 1994; Braig, Otwinowski, Hedge, Boisvert, Joachimiak, Horwich & Sigler, 1994).

8. Conclusions

The repeated theme of this article has been that the use of cryogenic techniques brings great advantages to the

macromolecular crystallographer. In fact, the increasing use of the techniques described is having a major impact on the range of problems that are now tractable, many of which were previously intractable.

The first advantage is that the great reduction in radiation damage to crystals at cryogenic temperatures gives the crystallographer effectively infinite crystal lifetimes on an in-house source and vastly extended lifetimes on a synchrotron. This can allow structure solution of systems that were previously problematic due to the severe radiation damage sustained by the crystals. In addition, the lack of crystal degradation during data collection results in data with lower systematic errors. The counting time per frame and the total number of frames can be increased to give data that are statistically more sound due to higher redundancy and better counting statistics. Furthermore, for a given macromolecular crystal, higher-resolution data are often obtained at cryogenic temperatures as compared to room temperature, since thermal vibrations within the crystal are reduced at low temperature.

The second major advantage of cryogenic data collection is that the crystal-mounting methods used are mechanically gentler and involve less sample handling. Some crystals that were too fragile or too sensitive to be mounted in a capillary can now be mounted in a loop or on a spatula. These mounting methods also contribute to the higher data quality obtained, since they result in intrinsically lower background X-ray scatter and thus give higher signal-to-noise ratios. In addition, there is usually less absorption of the X-ray beam compared with a capillary-mounted crystal, and thus fewer systematic errors are introduced.

A third advantage of the technique is the facility for in-house screening of flash-cooled crystals and the possibility of storing and transporting them. This allows optimum utilization of crystals and of data-collection facilities, especially synchrotron beam time.

All these potential advantages must be weighed against the disadvantages. Establishing cryocrystallographic facilities in a laboratory initially requires some monetary investment to purchase a reliable cryostat and some time must be devoted to becoming familiar with the technicalities (such as avoiding ice formation). For each new macromolecular system, time and crystals have to be sacrificed in order to establish a reproducible cooling procedure. With the methods available, an increase in mosaic spread should not be a limiting problem in the majority of cases, since it can be minimized by careful optimization of the cryoprotectant conditions.

Structural models refined against higher-quality data obtained from cryogenic diffraction experiments are more accurate and detailed, and thus represent a more reliable source of biological information. Even more importantly, cryocrystallographic techniques have enabled and will enable structural investigations of biolog-

ical systems previously inaccessible to crystallographic methods.

We are grateful to all those who have, directly or indirectly, contributed to this article through discussions and by sharing their expertise with us, particularly: Jeronimo Bravo, Robert Esnouf, Steve Gamblin, Louise Johnson, Arnon Lavie, Filippo Mancina, Martin Noble, Derryck Mills, Adelia Razeto, Michael Rossmann, Dietmar Stalke, Paul Tucker, Johan Turkenberg and also all the students and co-tutors we have met on various courses. We thank Stephen Lee for the photography. We are especially indebted to Peter David for his meticulous and constructive reading of the manuscript and to the referees for their time and helpful suggestions. TRS gratefully acknowledges support by an EMBL Predoctoral Fellowship and by a grant from the European Union (BI02-CT92-0524). This work has been supported by the UK Medical Research Council.

References

- Abdul-Meguid, S. S., Jeruzalmi, D. & Sanderson, M. R. (1996). *Crystallographic Methods and Protocols*, edited by C. Jones, B. Mulloy & M. R. Sanderson, pp. 55–87. New Jersey: Humana Press.
- Adlhart, W. & Huber, H. (1982). *J. Appl. Cryst.* **15**, 241–244.
- Albertsson, J., Oskarson, Å. & Ståhl, K. (1979). *J. Appl. Cryst.* **12**, 537–544.
- Andersen, G. R., Thirup, S., Nyborg, J., Dolmer, K., Jacobsen, L. & Sottrup-Jensen, L. (1994). *Acta Cryst.* **D50**, 298–301.
- Anderson, D. H., Weiss, M. S. & Eisenberg, D. (1996). *Acta Cryst.* **D52**, 469–480.
- Angell, C. A. & Choi, Y. (1986). *J. Microsc.* **141**, 251–261.
- Angell, C. A. & Tucker, J. C. (1980). *J. Phys. Chem.* **84**, 268–272.
- Bancroft, D., Williams, L. D., Rich, A. & Egli, M. (1994). *Biochemistry*, **33**, 1073–1086.
- Bartunik, H. D. & Schubert, P. (1982). *J. Appl. Cryst.* **15**, 277–231.
- Bartunik, H. D., Bartunik, L. J. & Viehmann, H. (1992). *Philos. Trans. R. Soc. London Ser. A*, **340**, 41–52.
- Bellamy, H. D., Phizackerly, R. P., Soltis, S. M. & Hope, H. (1994). *J. Appl. Cryst.* **27**, 967–970.
- Bennett, M. J. & Eisenberg, D. (1994). *Prot. Sci.* **3**, 1464–1475.
- Bernal, J. D. & Crowfoot, D. (1934). *Nature (London)*, **133**, 794–795.
- Bishop, W. H. & Richards, F. M. (1968). *J. Mol. Biol.* **38**, 315–328.
- Blake, C. C. F. & Philips, D. C. (1962). *Biological Effects of Ionizing Radiation at the Molecular Level*, Symposium of the International Atomic Energy Agency, Vienna, Austria, pp. 183–191.
- Blond, L., Pares, S. & Kahn, R. (1995). *J. Appl. Cryst.* **28**, 653–654.
- Braig, K., Otwinowski, Z., Hedge, R., Boisvert, D. C., Joachimiak, A., Horwich, A. L. & Sigler, P. B. (1994). *Nature (London)*, **371**, 578–586.
- Bravo, J., Verdaguier, N., Tormo, J., Betzel, C., Switala, J., Loewen, P. C. & Fita, I. (1995). *Structure*, **3**, 491–502.
- Brown, J. H., Jardetzky, T. S., Gorga, J. C., Stern, L. J., Urban, R. G., Strominger, J. L. & Wiley, D. (1993). *Nature (London)*, **364**, 33–39.
- Brown, J. H., Jardetzky, T. S., Stern, L. J., Gorga, J. C., Strominger, J. L. & Wiley, D. C. (1995). *Acta Cryst.* **D51**, 946–961.
- Bullock, T. L., Branchaud, B. & Remington, J. S. (1994). *Biochemistry*, **33**, 11127–11134.
- Bullough, P. A., Hughson, F. M., Treharne, A. C., Ruigrok, R. W. H., Skehel, J. J. & Wiley, D. C. (1994). *J. Mol. Biol.* **236**, 1262–1265.
- Burling, F. T., Weis, W. I., Flaherty, K. M. & Brünger, A. T. (1996). *Science*, **271**, 72–77.
- Burmeister, W. P., Huber, A. H. & Bjorkman, P. J. (1994). *Nature (London)*, **372**, 379–383.
- Chen, C. C. H. & Herzberg, O. (1992). *J. Mol. Biol.* **224**, 1103–1113.
- Clark, K. L., Halay, E. B., Lai, E. & Burley, S. (1993). *Nature (London)*, **364**, 412–420.
- Cogle, E. (1973). *Biological Effects of Radiation*. London: Wykeham Publications.
- Cosier, J. & Glazer, A. M. (1986). *J. Appl. Cryst.* **19**, 105–107.
- Cucka, R., Singman, L., Lovell, F. M. & Low, B. W. (1970). *Acta Cryst.* **B26**, 1756–1760.
- Dahl, R. & Staehelin, L. A. (1989). *J. Electron Microsc. Tech.* **13**, 165–174.
- Dauter, Z., Lamzin, V. S. & Wilson, K. S. (1995). *Curr. Op. Struct. Biol.* **5**, 784–790.
- David, P. (1996). Personal communication.
- David, P. R. & Burley, S. K. (1991). *J. Appl. Cryst.* **24**, 1073–1074.
- Davies, K. J. A. (1987). *J. Biol. Chem.* **262**, 9895–9901.
- Davies, K. J. A. & Delsignore, M. E. (1987). *J. Biol. Chem.* **262**, 9908–9913.
- Davies, K. J. A., Delsignore, M. E. & Lin, S. W. (1987). *J. Biol. Chem.* **262**, 9902–9907.
- Davies, K. J. A., Lin, S. W. & Pacifici, R. E. (1987). *J. Biol. Chem.* **262**, 9914–9920.
- Day, M. W., Hsu, B. T., Joshua-Tor, L., Park, J.-B., Zhou, Z. H., Adams, M. W. W. & Rees, D. C. (1992). *Prot. Sci.* **1**, 1494–1507.
- Dewan, J. C. & Tilton, R. F. (1987). *J. Appl. Cryst.* **20**, 130–132.
- Ding, X., Rasmussen, B. F., Petsko, G. A. & Ringe, D. (1994). *Biochemistry*, **33**, 9285–9183.
- Djinovic-Carugo, K., Battiston, A., Carri, M. T., Politicelli, F., Desideri, A., Rotilio, G., Coda, A. & Bolognesi, M. (1994). *FEBS Lett.* **349**, 93–98.
- Douzou, P. & Balny, C. (1978). *Adv. Prot. Chem.* **32**, 77–190.
- Douzou, P. & Petsko, G. A. (1984). *Adv. Prot. Chem.* **36**, 245–361.
- Douzou, P., Hui Bon Hoa, G., Maurel, P. & Travers, F. (1990). *Handbook of Biochemistry and Molecular Biology*, Vol. I, edited by G. D. Fasman, pp. 520–539. Cleveland, Ohio: CRC Press.
- Dowell, L. W. & Rinfret, A. P. (1960). *Nature (London)*, **188**, 1141–1148.
- Drenth, J. (1994). *Principles of Protein X-ray Crystallography*. New York: Springer-Verlag.

- Drew, H. R., Samson, S. & Dickerson, R. E. (1982). *Proc. Natl Acad. Sci. USA*, **79**, 4040–4044.
- Earnest, T., Fauman, E., Craik, C. S. & Stroud, R. (1991). *Proteins*, **10**, 171–187.
- Echlin, P. (1992). *Low-Temperature Microscopy and Analysis*. New York: Plenum Press.
- Egli, M., Usman, N., Zhang, S. & Rich, A. (1992). *Proc. Natl Acad. Sci. USA*, **89**, 534–538.
- Eisenstein, M., Frolow, F., Shakked, Z. & Rabinovich, D. (1990). *Nucl. Acid. Res.* **18**, 3185–3194.
- Eisenstein, M., Hope, H., Haran, T. E., Frolow, F., Shakked, Z. & Rabinovich, D. (1988). *Acta Cryst.* **B44**, 625–628.
- Engel, C., Wierenga, R. & Tucker, P. A. (1996). *J. Appl. Cryst.* **29**, 208–210.
- Fink, A. L. & Petsko, G. A. (1981). *Adv. Enzymol. Relat. Areas Mol. Biol.* **52**, 177–246.
- Fink, A. L. (1976). *J. Theor. Biol.* **61**, 419–445.
- Franks, F. (1985). *Biophysics and Biochemistry at Low Temperatures*. Cambridge University Press.
- Frauenfelder, H., Hartmann, H., Karplus, M., Kuntz, I. D. Jr, Kuriyan, J., Parak, F., Petsko, G. A., Ringa, D., Tilton, R. F., Conolly, M. L. & Max, N. (1987). *Biochemistry*, **26**, 254–261.
- Frazao, C., Soares, C. M., Carrondo, A. M., Pohl, E., Dauter, Z., Wilson, K. S., Hervas, M., Navarro, J. A., De la Rosa, M. A. & Sheldrick, G. M. (1995). *Structure*, **3**, 1159–1169.
- Freymann, D., Down, J., Carrington, M., Roditi, I., Turner, M. & Wiley, D. (1990). *J. Mol. Biol.* **216**, 141–160.
- Frost, G. & Canella, S. (1996). Personal communication.
- Gamblin, S. J. & Rodgers, D. W. (1993). *Proc. CCP4 Study Weekend*, edited by L. Sawyer, N. Isaacs & S. Bailey, pp. 28–32. Daresbury Laboratory, Warrington, England.
- Garman, E. F. & Mitchell, E. (1996). *J. Appl. Cryst.* **29**, 584–587.
- Georgiadis, M. M., Komiya, H., Chakrabarti, P., Woo, D., Kornuc, J. J. & Rees, D. (1992). *Science*, **257**, 1653–1659.
- Ginell, S. (1996). Personal communication.
- Ginell, S. L., Vojtechovsky, J., Gaffney, B., Jones, R. & Berman, H. M. (1994). *Biochemistry*, **33**, 3487–3493.
- Gonzales, A. & Nave, C. (1994). *Acta Cryst.* **D50**, 874–877.
- Gonzales, A., Thompson, A. W. & Nave, C. (1992). *Rev. Sci. Instrum.* **63**, 1177–1180.
- Greubel, K. H., Gmelin, E., Moser, N., Mensing, C. & Walz, L. (1990). *Proc. 13th Cryogenic Engineering Conference*, Beijing, China, pp. 457–462.
- Haas, D. J. & Rossmann, M. G. (1970). *Acta Cryst.* **B26**, 998–1004.
- Haas, D. J. (1968). *Acta Cryst.* **B24**, 604–605.
- Hajdu, J., McLaughlin, P. J., Helliwell, J. R., Sheldon, J. & Thompson, A. W. (1985). *J. Appl. Cryst.* **18**, 528–532.
- Harel, M., Su, C.-T., Frolow, F., Ashani, Y., Silman, I. & Sussman, J. L. (1991). *J. Mol. Biol.* **221**, 909–918.
- Harel, M., Su, C.-T., Frolow, F., Silman, I. & Sussman, J. L. (1991). *Biochemistry*, **30**, 5217–5225.
- Hartmann, H., Parak, F., Steigemann, W., Petsko, G., Ringe-Ponzi, D. & Frauenfelder, H. (1982). *Proc. Natl Acad. Sci. USA*, **79**, 4967–4971.
- Hartmann, H., Zinser, S., Komminos, P., Schneider, T. R., Nienhaus, G. U. & Parak, F. (1996). *Proc. Natl Acad. Sci. USA*, **93**, 7013–7016.
- Henderson, R. (1990). *Proc. R. Soc. London Ser. B*, **241**, 6–8.
- Hendrickson, W. A. & Wüthrich, K. (1991). Editors. *Macromolecular Structures 1991*. London: Current Biology.
- Hendrickson, W. A. & Wüthrich, K. (1992). Editors. *Macromolecular Structures 1992*. London: Current Biology.
- Hendrickson, W. A. & Wüthrich, K. (1993). Editors. *Macromolecular Structures 1993*. London: Current Biology.
- Hendrickson, W. A. & Wüthrich, K. (1994). Editors. *Macromolecular Structures 1994*. London: Current Biology.
- Hendrickson, W. A. & Wüthrich, K. (1995). Editors. *Macromolecular Structures 1995*. London: Current Biology.
- Hendrickson, W. A. (1991). *Science*, **254**, 51–58.
- Hobough, M. R., Song, L., Cheley, S., Shustak, C., Bayley, H. & Gouaux, J. E. (1995). *Annu. Meet. Am. Crystallogr. Assoc.* Abstract WO48.
- Hodel, A., Kim, S.-H. & Brünger, A. T. (1992). *Acta Cryst.* **A48**, 851–858.
- Hope, H. (1985). *Annu. Meet. Am. Crystallogr. Assoc.* Abstract PA3:24.
- Hope, H. (1988). *Acta Cryst.* **B44**, 22–26.
- Hope, H. (1990). *Annu. Rev. Biophys. Biophys. Chem.* **19**, 107–126.
- Hope, H. (1994). *Annu. Meet. Am. Crystallogr. Assoc.* Abstract PE01.
- Hope, H. (1996). Personal communication.
- Hope, H., Frolow, F., von Böhlen, K., Makowski, I., Kratky, C., Halfon, Y., Danz, H., Webster, P., Bartels, K. S., Wittmann, H. G. & Yonath, A. (1989). *Acta Cryst.* **B45**, 190–199.
- Huber, A. H., Wang, Y. E., Bieber, A. J. & Bjorkman, P. J. (1994). *Neuron*, **12**, 717–731.
- Jones, G. D. D., Lea, J. S., Symons, M. C. R. & Taiwo, F. A. (1987). *Nature (London)*, **330**, 772–773.
- Joshua-Tor, L., Frolow, F., Appella, E., Hope, H., Rabinovich, D. & Sussman, J. L. (1992). *J. Mol. Biol.* **225**, 397–431.
- Joshua-Tor, L., Rabinovich, D., Hope, H., Frolow, F., Appella, E. & Sussman, J. (1988). *Nature (London)*, **334**, 82–84.
- Kanno, H., Speedy, R. J. & Angell, C. A. (1975). *Science*, **189**, 880–881.
- Keefe, L. J., Ginell, S. L., Westbrook, E. & Anderson, C. W. (1995). *Prot. Sci.* **4**, 1658–1660.
- Kim, H. & Lipscomb, W. N. (1993). *Biochemistry*, **32**, 8465–8478.
- Kim, K.-H., Kwon, B.-M., Myers, A. G. & Rees, D. C. (1993). *Science*, **262**, 1042–1046.
- Knegtel, R. M. A., Strokopytov, B., Penninga, D., Faber, O., Rozeboom, H. J., Kalk, K. H., Dijkhuizen, L. & Dijkstra, B. W. (1995). *J. Biol. Chem.* **270**, 29256–29264.
- Knoll, D. & Hermans, J. (1983). *J. Biol. Chem.* **258**, 5710–5715.
- Kurinov, I. V. & Harrison, R. W. (1995). *Acta Cryst.* **D51**, 98–109.
- Larsen, F. K. (1995). *Acta Cryst.* **B51**, 468–582.
- Leahy, D. J., Aukhil, I. & Erickson, H. P. (1996). *Cell*, **84**, 155–164.
- Lee, J. W., Chan, M., Law, T. V., Kwon, H. J. & Jap, B. K. (1995). *J. Mol. Biol.* **252**, 15–19.
- Lima, C. D., Wang, J. C. & Mondragon, A. (1994). *Nature (London)*, **367**, 138–145.
- Livnah, L. & Sussman, J. L. (1990). *Methods Enzymol.* **184**, 90–93.
- Low, B. W., Chen, C. C. H., Berger, J. E., Singman, L. & Pletcher, J. F. (1966). *Proc. Natl Acad. Sci. USA*, **56**, 1746–1750.

- Madden, D. R., Gorga, J. C., Strominger, J. L. & Wiley, D. (1992). *Cell*, **70**, 1035–1048.
- Makinen, M. W. & Fink, A. L. (1977). *Ann. Rev. Biophys. Bioeng.* **6**, 301–343.
- Mancia, F. (1996). Unpublished work.
- Mancia, F., Oubridge, C., Hellon, C., Woollard, T., Groves, J. & Nagai, K. (1995). *J. Appl. Cryst.* **28**, 224–225.
- Marsh, D. J. & Petsko, G. A. (1973). *J. Appl. Cryst.* **6**, 76–80.
- Mattevi, A., Valentini, G., Rizzi, M., Speranza, M. L., Bolognesi, M. & Coda, A. (1995). *Structure*, **3**, 729–741.
- Matthews, B. W. (1968). *J. Mol. Biol.* **33**, 491–497.
- Mitchell, E. P. & Garman, E. F. (1994). *J. Appl. Cryst.* **27**, 1070–1074.
- Moffat, K. & Henderson, R. (1995). *Curr. Op. Struct. Biol.* **5**, 656–663.
- Moor, H. (1987). *Cryotechniques in Biological Electron Microscopy*, edited by R. A. Steinbrecht & K. Zierold, pp. 175–191. Berlin: Springer-Verlag.
- Nakasako, M., Ueki, T., Toyoshima, C. & Umeda, Y. (1995). *J. Appl. Cryst.* **28**, 856–857.
- Narayana, N., Ginell, S. L., Russu, I. M. & Berman, H. M. (1991). *Biochemistry*, **30**, 4449–4453.
- Nave, C. (1995). *Radiat. Phys. Chem.* **45**, 483–490.
- Nissen, P., Kjeldgaard, M., Thirup, S., Polekhina, G., Reshetnikova, L., Clark, B. F. C. & Nyborg, J. (1995). *Science*, **270**, 1464–1472.
- Oubridge, C., Nobutoshi, I., Evans, P. R., Teo, C.-H. & Nagai, K. (1994). *Nature (London)*, **372**, 432–438.
- Owen, D. J., Noble, M. E. M., Garman, E. F., Papageorgiou, A. C. & Johnson, L. N. (1995). *Structure*, **3**, 467–482.
- Parak, F., Hartmann, H., Aumann, K. D., Reuscher, H., Rennekamp, G., Bartunik, H. & Steigemann, W. (1987). *Eur. Biophys. J.* **15**, 237–249.
- Petsko, G. A. (1975). *J. Mol. Biol.* **96**, 381–392.
- Petsko, G. A. (1985). *Methods Enzymol.* **114**, pp. 141–147.
- Pickford, M. (1996). Personal communication.
- Plattner, H. & Bachmann, L. (1982). *Int. Rev. Cyt.* **79**, 237–304.
- Pohl, E., Heine, A., Sheldrick, G. M., Dauter, Z., Schneider, T. R., Wilson, K. S. & Kallen, J. (1995). *Acta Cryst.* **D51**, 60–68.
- Post, B., Schwartz, R. S. & Fankuchen, I. (1951). *Rev. Sci. Instrum.* **22**, 218–219.
- Quintana, J. R., Lipanov, A. A. & Dickerson, R. E. (1991). *Biochemistry*, **30**, 10294–10306.
- Quiocho, F. A. & Richards, F. M. (1964). *Proc. Natl Acad. Sci. USA*, **52**, 833–839.
- Röttger, K., Endriss, A., Ihringer, J., Doyle, S. & Kuhs, W. F. (1994). *Acta Cryst.* **B50**, 644–648.
- Rasmussen, B. F., Stock, A. M., Ringe, D. & Petsko, G. A. (1992). *Nature (London)*, **357**, 423–424.
- Ray, W. J., Bolin, T. B., Puvathingal, J. M., Minor, W., Liu, Y. & Muchmore, S. W. (1991). *Biochemistry*, **30**, 6866–6875.
- Reinisch, K. M., Chen, L., Verdine, G. L. & Lipscomb, W. N. (1995). *Cell*, **82**, 143–153.
- Ringe, D., Petsko, G. A., Yamakura, F., Sozaki, K. & Ohmori, D. (1983). *Proc. Natl Acad. Sci. USA*, **80**, 3879–3883.
- Rini, J. M., Schulze-Gahmen, U. & Wilson, I. (1992). *Science*, **255**, 959–965.
- Rodgers, D. (1997). *Methods Enzymol.* **276**, 183–203.
- Rodgers, D. W. (1994). *Structure*, **2**, 1135–1140.
- Rodgers, D. W., Gamblin, S. J., Harris, B. A., Ray, S., Culp, J. S., Hellmig, B., Woolf, D. J., Debouck, C. & Harrison, S. C. (1995). *Proc. Natl Acad. Sci. USA*, **92**, 1222–1226.
- Rossmann, M. G. (1996). Personal communication.
- Rudman, R. (1976). *Low-Temperature X-ray Diffraction*. New York: Plenum Press.
- Ryan, K. P. & Liddicoat, M. I. (1987). *Proc. R. Microsc. Soc.* **147**, 337–340.
- Samson, S., Goldish, E. & Dick, C. J. (1980). *J. Appl. Cryst.* **13**, 425–432.
- Schlichting, I., Berendzen, J., Phillips, N. & Sweet, R. M. (1994). *Nature (London)*, **371**, 808–812.
- Schneider, T. (1996a). PhD thesis. Technical University, Munich, Germany.
- Schneider, T. R. (1996b). *Proc. CCP4 Study Weekend*, edited by E. J. Dodson, M. Moore, A. Ralf & S. Bailey, pp. 133–134. Daresbury Laboratory, Warrington, England.
- Schreuder, H. A., Groendijk, H., van der Laan, J. M. & Wierenga, R. K. (1988). *J. Appl. Cryst.* **21**, 426–429.
- Shakked, Z., Guerststein-Guzikevich, G., Eisenstein, M., Frolow, F. & Rabinovich, D. (1989). *Nature (London)*, **342**, 456–459.
- Sharma, A., Hanai, R. & Mondragon, A. (1994). *Structure*, **2**, 767–777.
- Silfhout, R. G. & Hermes, C. (1995). *Rev. Sci. Instrum.* **66**, 1818–1820.
- Silver, M. L., Guo, H.-C., Strominger, J. L. & Wiley, D. C. (1992). *Nature (London)*, **360**, 367–369.
- Singh, T. P., Bode, W. & Huber, R. (1980). *Acta Cryst.* **B36**, 621–627.
- Sitte, H., Neumann, K. & Edelmann, L. (1987). *Cryotechniques in Biological Electron Microscopy*, edited by R. A. Steinbrecht & K. Zierold, pp. 285–290. Berlin: Springer-Verlag.
- Smith, J. L. (1991). *Curr. Op. Struct. Biol.* **1**, 1002–1011.
- Sousa, R. & Lafer, E. M. (1990). *Methods: A Companion to Methods in Enzymology*, **1**, 50–56.
- Sousa, R. (1995). *Acta Cryst.* **D51**, 271–277.
- Stalke, D. (1996). *Chemistry of the Alkali- and Alkaline Earth Metals*, edited by R. Snath. In the press. Weinheim, Germany: VCH.
- Stec, B., Rongsheng, Z. & Teeter, M. M. (1995). *Acta Cryst.* **D51**, 663–681.
- Steinbrecht, R. A. & Zierold, K. (1987). Editors. *Cryotechniques in Biological Electron Microscopy*. Berlin: Springer-Verlag.
- Stoddard, B. & Farber, G. K. (1995). *Structure*, **3**, 991–996.
- Symons, M. C. R. (1995). *Radiat. Phys. Chem.* **45**, 837–845.
- Teeter, M. M. & Hope, H. (1986). *Ann. N. Y. Acad. Sci.* **482**, 163–165.
- Teng, T. Y. (1990). *J. Appl. Cryst.* **23**, 387–391.
- Teng, T. Y., Schildkamp, W., Dolmer, P. & Moffat, K. (1994). *J. Appl. Cryst.* **27**, 133–139.
- Teng, T. Y., Srajer, V. & Moffat, K. (1994). *Nature Structural Biology*, **1**, 701–705.
- Thomanek, U. F., Parak, F. & Wintergerst, B. (1977). *Z. Naturforsch* **32c**, 11–19.
- Thomanek, U. F., Parak, F., Mössbauer, R. L., Formanek, H., Schwager, P. & Hoppe, W. (1973). *Acta Cryst.* **A29**, 263–265.
- Tilton, R. F., Dewan, J. C. & Petsko, G. A. (1992). *Biochemistry*, **31**, 2469–2481.
- Uhlmann, D. R. (1969). *Kinetics of Reactions in Ionic Systems*, edited by T. J. Gray & V. D. Frechette, *Material Science Research*, Vol. 4, pp. 172–197. New York: Plenum.

- Uhlmann, D. R. (1972). *J. Non-Cryst. Solids*, **7**, 337–348.
- Volkman, N., Hottentraeger, S., Hansen, H. A. S., Zayzsev-Bashan, A., Sharon, R., Berkovitch-Yellin, Z., Yonath, A. & Wittmann, H. G. (1990). *J. Mol. Biol.* **216**, 239–241.
- Wagner, U. G., Müller, N., Schmitzberger, W., Falk, H. & Kratky, C. (1995). *J. Mol. Biol.* **247**, 326–337.
- Wagner, U. G., Werber, M. M., Beck, Y., Hartman, J. R., Frolow, F. & Sussmann, J. L. (1989). *J. Mol. Biol.* **206**, 787–788.
- Walsh, M. A., McCarthy, A., Higgins, T., O'Farrell, P. & Mayhew, S. G. (1996). XVII IUCr Congress, Seattle, USA. MS01.01.07.
- Walter, J., Steigemann, W., Singh, T. P., Bartunik, H., Bode, W. & Huber, R. (1982). *Acta Cryst.* **B38**, 1462–1472.
- Watenpaugh, K. D. (1991). *Curr. Op. Struct. Biol.* **1**, 1012–1015.
- Watowich, S. J., Skehel, J. J. & Wiley, D. C. (1994). *Structure*, **2**, 719–731.
- Watowich, S. J., Skehel, J. J. & Wiley, D. C. (1995). *Acta Cryst.* **D51**, 7–12.
- Watson, K. (1996). Personal communication.
- Watt, W., Tulinsky, A., Swenson, R. P. & Watenpaugh, K. D. (1991). *J. Mol. Biol.* **218**, 195–208.
- Weeks, C., Hauptman, H. A., Smith, G. D., Blessing, R. H., Teeter, M. M. & Miller, R. (1995). *Acta Cryst.* **D51**, 33–38.
- Wilke, M. E., Higaki, J. N., Craik, C. S. & Fletterick, R. J. (1991). *J. Mol. Biol.* **219**, 511–523.
- Williams, P. A., Fülöp, V., Garman, E. F. & Hajdu, J. (1996). XVII IUCr Congress, Seattle, USA. MS01.01.02.
- Wyckoff, H. W., Doscher, M., Tsernoglou, D., Inagami, T., Johnson, L. N., Hardman, K. D., Allewell, N. M., Kelly, D. M. & Richards, F. M. (1967). *J. Mol. Biol.* **27**, 563–578.
- Yan, Y., Winograd, E., Viel, A., Cronin, T., Harrison, S. C. & Branton, D. (1993). *Science*, **262**, 2027–2030.
- Yonath, A. (1996). Personal communication.
- Yonath, A., Glotz, C., Gewitz, H. S., Bartels, K. S., von Böhlen, K., Makowski, I. & Wittmann, H. G. (1988). *J. Mol. Biol.* **203**, 831–834.
- Young, A. C. M., Dewan, J. C., Nave, C. & Tilton, R. F. (1993). *J. Appl. Cryst.* **26**, 309–319.
- Young, A. C. M., Dewan, J. C., Thompson, A. W. & Nave, C. (1990). *J. Appl. Cryst.* **23**, 215–218.
- Young, A. C. M., Tilton, R. F. & Dewan, J. C. (1994). *J. Mol. Biol.* **235**, 302–317.
- Zaloga, G. & Sarma, R. (1974). *Nature (London)*, **251**, 551–552.