

DOPED POLY-CO MEASUREMENTS IN LOW EARTH ORBIT

REBELSAT / UNLV

Batya Vishnepolsky and Adam Sheta



REBELSAT / UNLV

RebelSat is a team composed of 55 undergrad and graduate students at the University of Nevada, Las Vegas



PRESENTERS



BATYA VISHNEPOLSKY
DEPUTY PROJECT LEAD



ADAM SHETA
LEAD SYSTEMS ENGINEER

DOPED POLY-CO

- Stable irradiated solid carbon monoxide
- Wide band gap semiconductor
- Synthesized by Dr. Michael Pravica with HiPSEC and the Department of Physics at UNLV
- Photoluminescence test in low earth orbit (LEO)

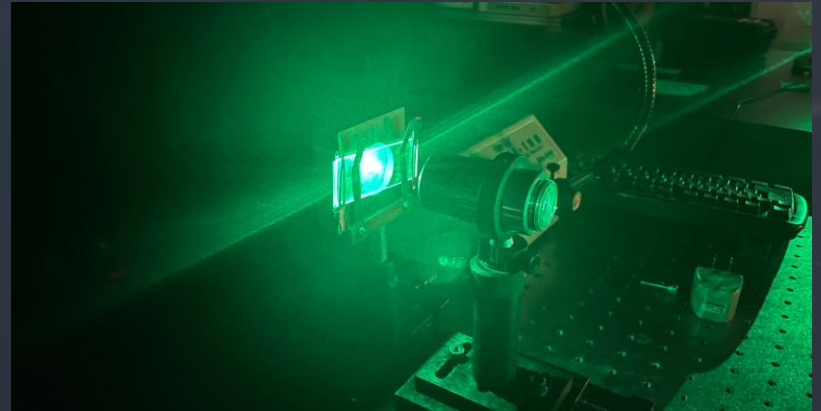
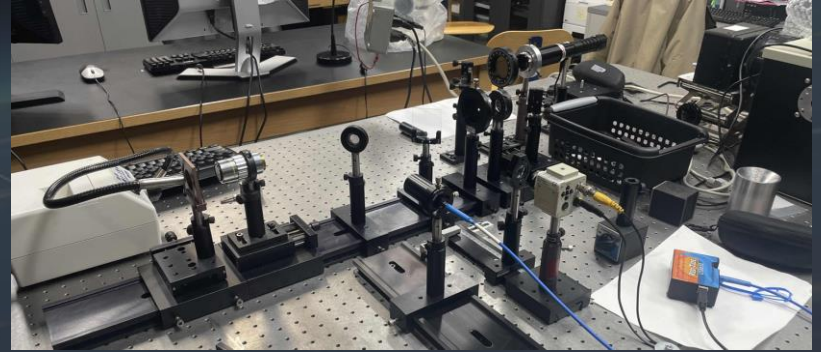

MISSION OBJECTIVE

Doped Poly-CO shall remain stable in conditions of Low Earth Orbit, demonstrating its usability in such conditions.

- Photoluminescence spectroscopy
- Experiment execution
- Experiment requirements
 - Power draw
 - Data transmission
 - Material survivability

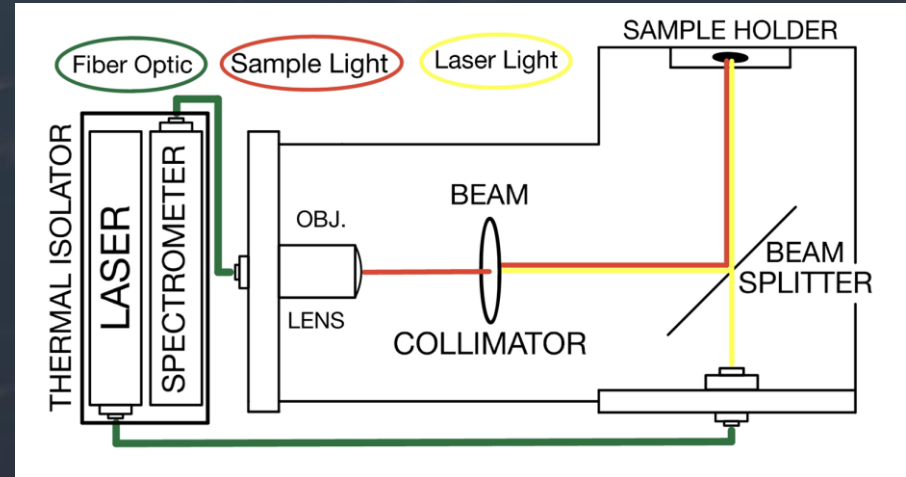

BENEFITS

- Doped Poly-CO that could be a viable alternative to traditional electronic board materials.
- Lower cost of space hardware
 - GaN and Silicon and other materials can be costly
 - Big savings over the next few years
- If proven space rated, electronic components can become more efficient by using Doped Poly-CO

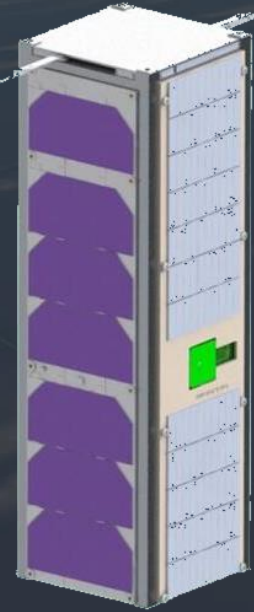

RS-1 Rendering

DEVELOPMENT CHALLENGES

- Budget
- Low pass filter
- Ruby tests
- Optical cage

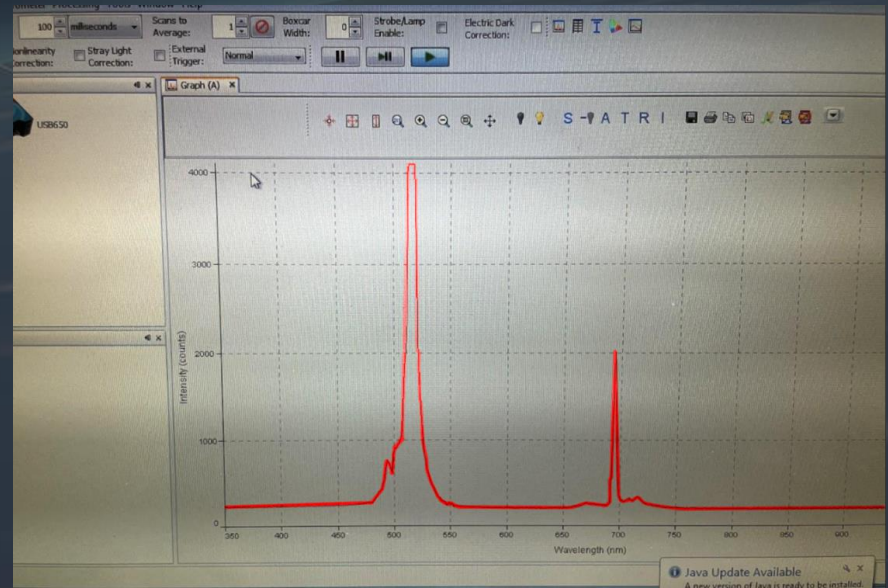
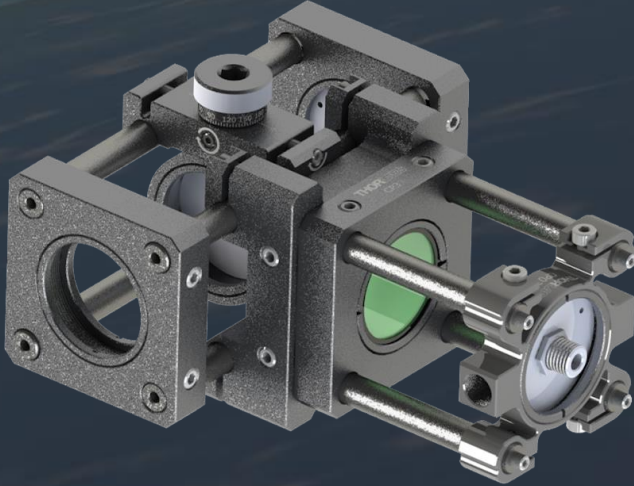

FUTURE STEPS



Further
testing

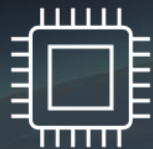

FlatSat



Integration



Launch



Data
Collection





THANK YOU



REBELSAT.COM
@REBELSATUNLV