

Manufactured by

443
77
1944

TM 5-272

WAR DEPARTMENT TECHNICAL MANUAL

3. 1st Army
...

STEEL-TREADWAY

BRIDGE M2

WAR DEPARTMENT

9 MAY 1944

WAR DEPARTMENT TECHNICAL MANUAL

TM 5-272

This manual supersedes TM 5-272, 10 July 1942, and TB 5-272-1, 26 January 1944

STEEL-TREADWAY

BRIDGE M2



WAR DEPARTMENT

• 9 MAY 1944

United States Government Printing Office

Washington : 1944

WAR DEPARTMENT,
WASHINGTON 25, D. C., 9 May 1944.

TM 5-272, Steel-Treadway Bridge M2, is published for the information and guidance of all concerned.

[A. G. 300.7 (27 Mar 44).]

BY ORDER OF THE SECRETARY OF WAR:

G. C. MARSHALL,
Chief of Staff.

OFFICIAL:

J. A. ULIO,
Major General,
The Adjutant General.

DISTRIBUTION:

As prescribed in paragraph 9a, FM 21-6; Armies (10) ; Corps (10) ;
D 17 (10) ; R 17 (15) Bn 17 (15) ; I Bn 5 (15) ; AAF Schs (10) ;
Engr RTC (100) ; Engr Unit Tng Cen (100) ; Com Z (Engr Hq)
(10) ; Com Z Sections (Engr Hq) (10).

IBn 5: T/O 5-215, Armored Engr Bn.

For explanation of symbols see FM 21-6.

U. 113
12

TM 5:270
1944

★ ★ CONTENTS

	<i>Paragraph</i>	<i>Page</i>
SECTION I. GENERAL.		
Purpose.....	1	1
Design.....	2	1
Capacity.....	3	5
Size of working party required.....	4	5
Estimated times for construction.....	5	5
Composition and assignment of equipment.....	6	5
SECTION II. DESCRIPTION AND USE OF EQUIPMENT.		
Pneumatic float.....	7	8
Saddle.....	8	9
Steel treadway.....	9	11
Treadway-connecting pin.....	10	11
Treadway-spacing hook.....	11	15
Treadway wedges.....	12	15
Anchors.....	13	15
Trestle.....	14	15
Trestle-bracing equipment.....	15	16
Treadway adaptor.....	16	17
Outboard motor and motor bracket.....	17	17
Tools and accessories.....	18	17
Portable air compressor.....	19	17
Motorized air compressor.....	20	19
Truck crane.....	21	19
Power utility boat.....	22	19
Blackout markers.....	23	21
SECTION III. TRANSPORTATION.		
General.....	24	24
Treadway truck.....	25	24
Contents of truck loads.....	26	25
Operation of treadway truck.....	27	26
SECTION IV. SELECTION AND PREPARATION OF BRIDGE SITES.		
Reconnaissance.....	28	30
Site requirements.....	29	30
Preparation of site.....	30	30
Lay-out of site.....	31	30
SECTION V. WORKING PARTY.		
Organization of working party.....	32	34
Duties of construction details.....	33	34

M558166

III

	<i>Paragraph</i>	<i>Page</i>
SECTION VI. CONSTRUCTION.		
Methods of construction.....	34	42
Advantages of different methods of construction....	35	42
Anchorage of bridge.....	36	43
Shore connections.....	37	47
Alinement of bridge.....	38	54
Dismantling bridge.....	39	54
Use of trestle equipment.....	40	54
Expedient use of equipment.....	41	54
Use of drawspan.....	42	56
 SECTION VII. RAFTS.		
Ferry set.....	43	57
Construction of rafts.....	44	57
Capacity.....	45	58
Ferry sites.....	46	60
Ferry party.....	47	60
Rigging arrangement.....	48	61
Loading and unloading rafts.....	49	61
Methods of propulsion.....	50	61
 SECTION VIII. TRAFFIC CONTROL AND MAINTENANCE OF BRIDGE.		
Bridge guard.....	51	64
Traffic control.....	52	64
Traffic capacity.....	53	64
Maintenance of bridge.....	54	64
Blackout delineation.....	55	65
Protection against air attack.....	56	65
Protection against debris.....	57	68
Precautions during floods.....	58	68
Maintenance of equipage.....	59	68

SECTION I

GENERAL

1. PURPOSE. This manual describes the steel-treadway bridge M2 (fig. 1) which furnishes a rapid means of stream crossing for medium tanks and other heavy vehicles.

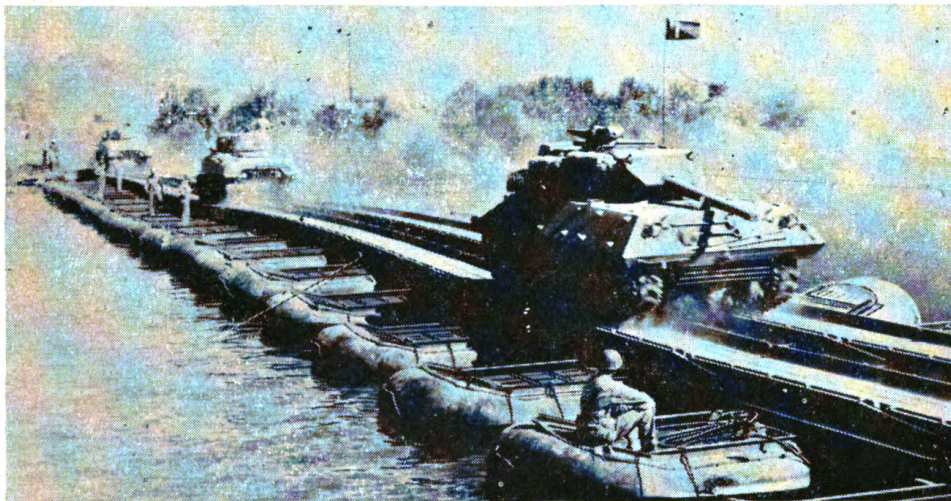

Figure 1. Tanks crossing steel-treadway floating bridge M2.

2. DESIGN. The treadway bridge can be built of floating spans, fixed spans, or a combination of both.

a. Floating bridge (fig. 2). (1) The roadway of the bridge consists of two tracks of continuous-beam-action steel treadways formed of 12-foot lengths connected rigidly at each joint by two treadway pins. The treadways are supported by pneumatic pontons spaced 12 feet center to center. The pontons consist of saddles carried upon pneumatic floats. Shore connections are made by resting the end treadways upon abutment sills on the banks or by using one or more trestle spans.

(2) The type shore connections used depends upon how close to the banks the shoreward pontons can be placed, the slope of the banks, and the bearing quality of the soil close to the water's edge. Trestles require firm foundations and take considerable time to erect and should be used only when shore supports for the end treadways cannot be employed.

b. Fixed bridges (fig. 3). Short-span fixed bridges employing one or two lengths of treadway for each track and supported on abutments can be built without intermediate supports. Bridges employing three or more

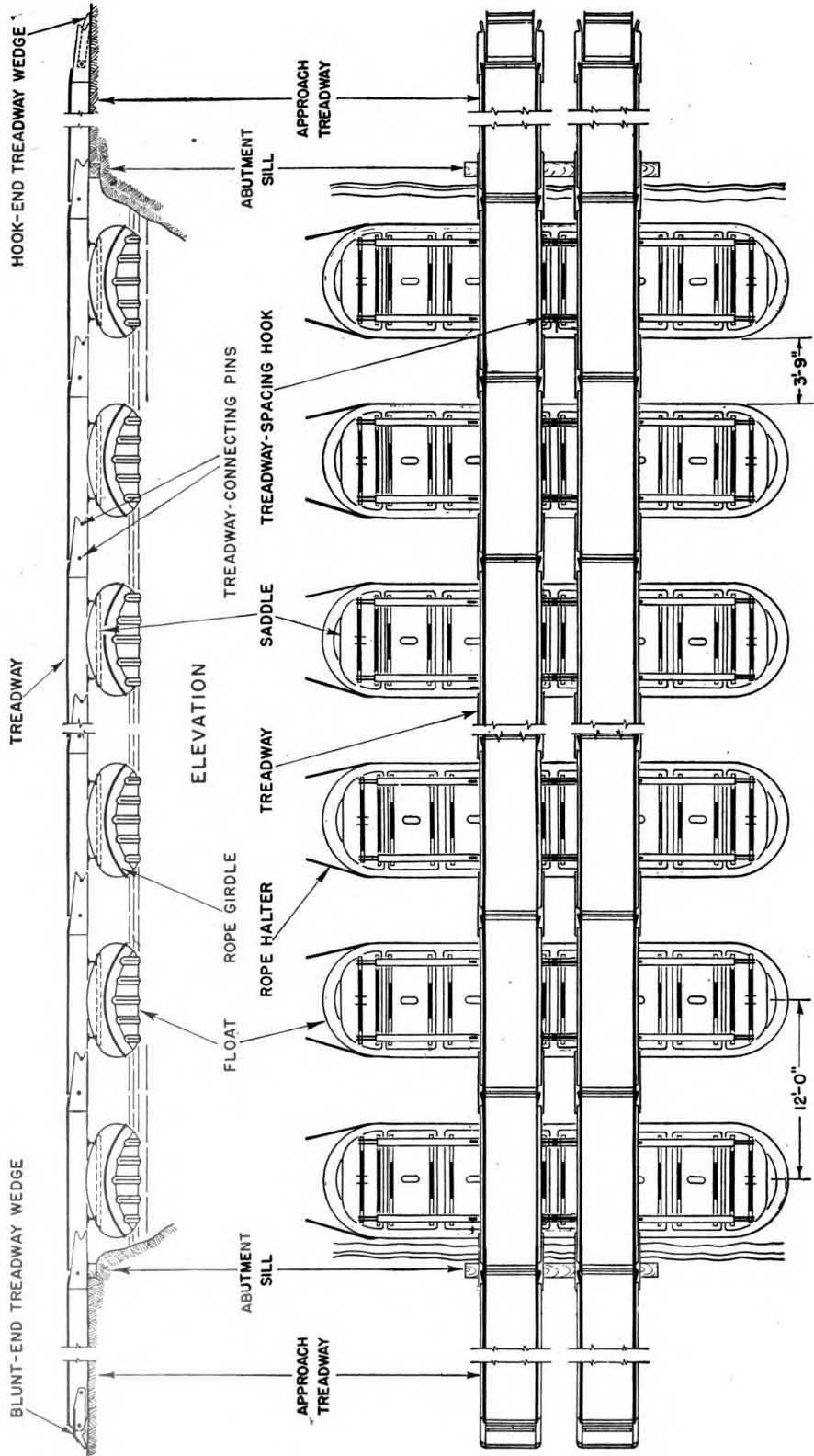

PLAN

Figure 2. Steel-treadway floating bridge M2.

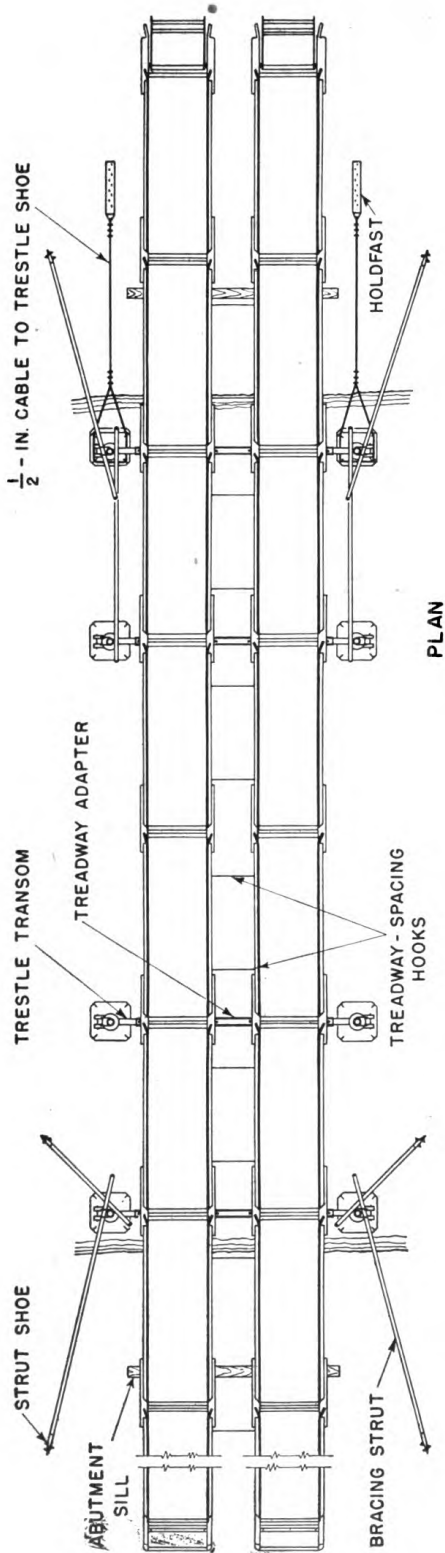

PLAN

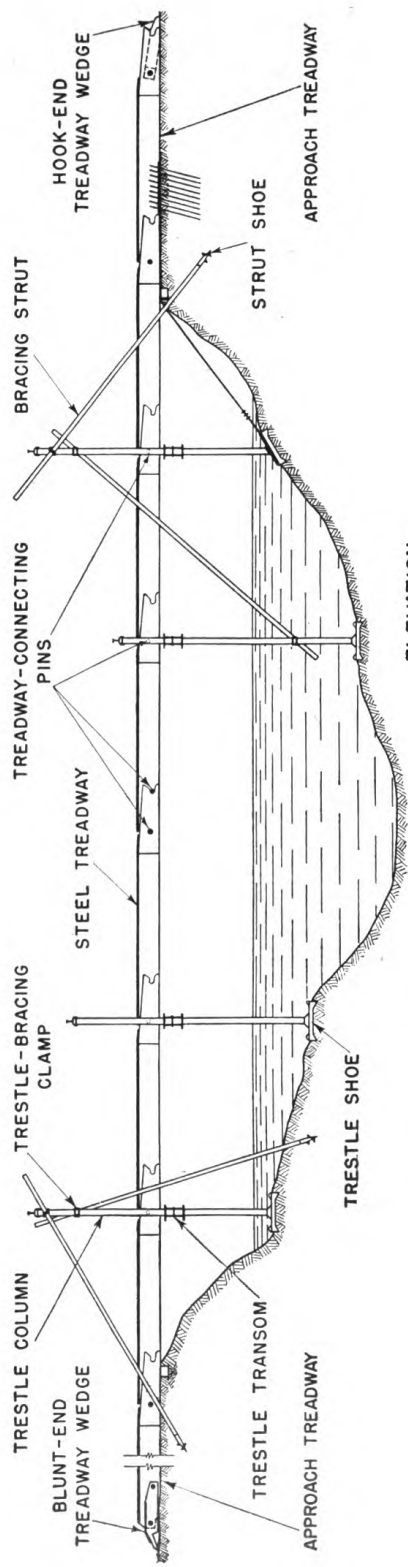

ELEVATION

Figure 3. Steel-treadway fixed bridge M2.

		STEEL TREADWAY BRIDGE M-2						
		FLOATING ②			FIXED			
VEHICLE		CAPACITY IN TONS POSTED ON BRIDGE						
		40	46	46	18	35	46	60
		MAXIMUM STREAM VELOCITY IN FEET PER SECOND			MAXIMUM SPAN IN FEET			
		7	5	3	40	26	23	18
Truck, 2½-T, w/8-T tlr.	17							
Truck, 4-T, cargo (same as distributor, water)	13							
Truck, 4-T, ponton	13							
Truck, 4-T, w/155-mm How., carr., M1	16							
Crane, trk.-mtd. (Engr.)	12							
Crane, trk.-mtd., w/crane attachments tlr.	15							
Tank, light, M2A4	12							
Truck, 4-T, cargo, w/8-T tlr.	20							
Truck, wrecking, C-1 (AC)	16							
Tank, light, M3	14							
Truck, 6-T, cargo	18							
Truck, 6-T, bridge	19							
Truck, 6-T, w/90-mm AA gun, M1	23							
Truck, 6-T, w/3-in. AA gun, M2A2	22							
Truck, 6-T, w/distributor, bituminous, 1,250-gal.	23							
Tank, light, M5	16							
Tractor, D-7, w/dozer	15							
Motor carriage, M8	16							
Tractor-trk, 6-T, w/semi-tlr., wrecking, C2	26							
Truck, 7½-T, cargo & prime mover	21							
Tank, light, 18-T	18							
Tank, medium, M2A1	21							
Tractor-trk, 7½-T w/semi-tlr., fuel service, F-1 (AC)	26							
Truck, 6-T, w/16-T tlr.	31				①		①	
Truck, 7½-T, w/155-mm gun, carr., M2 & M3	28							
Truck, 7½-T, w/8-in. gun, carr., M2, transporter, M1	34							
Truck, 6-T, w/20-T tlr.	37							
Tractor-trk, 5 to 6-T, w/20-T semi-tlr.	32				①		①	
Truck, 7½-T, w/20-T tlr.	39							
Motor carriage, M7	24							
Tractor, D-8 w/dozer	22							
Motor carriage, M12	27							
Motor carriage, M10	29							
Tank, medium, M3	33							
Tank, medium, M4	34							
Tank, assault, T-14	46							
Tank, heavy, M6	60							

Date: 1 Jan. 1944

Vehicle ratings based on 4-inch minimum freeboard at upstream end of float; 45,000 P.S.I. maximum stress for steel in bending.

LEGEND

SAFE

CAUTION ③

UNSAFE

W/=WITH

NOTES

① Unable to pass because of gap between treadways.

② Normal construction, with one pair of treadways per float.

③ Vehicle on centerline of deck. Maximum speed—3 M.P.H.

Table I. Capacity of steel-treadway floating and fixed bridges

lengths of treadway for each track require trestles as intermediate supports to carry heavier loads.

3. CAPACITY. a. Table I gives the posted and vehicle capacities of the steel-treadway floating and fixed bridges M2.

b. Multi-wheel trailers can cross the M2 bridge, provided their weight class does not exceed the posted capacity of the bridge and timbers are placed on the treadway-spacing hooks between the treadways. Two 4- by 12-inch timbers, 14 feet or greater in length, placed side by side, give a 24-inch roadway between treadways. The timbers are connected end to end by nailing 2- by 6-inch by 6-foot timbers over the joints.

4. SIZE OF WORKING PARTY REQUIRED. The steel-treadway bridge normally is constructed by a company of armored engineers using the equipment of and assisted by the treadway bridge company. See paragraph 32 for organization of working party.

5. ESTIMATED TIMES FOR CONSTRUCTION. Table II gives estimated times for construction of various lengths of steel-treadway floating bridges.

Table II. Estimated times for construction of steel-treadway floating bridges

Length of bridge (in feet)	Number of floats	Construction time (in hours)	
		Daylight	Blackout
216.....	18	2	3
432.....	36	3	4½
648.....	54	4	6
864.....	72	5	7½

The above estimates for daylight construction assume 45 minutes for initial adjustments, 3 minutes per float, and 20 minutes for final adjustments. They do not provide for work on approaches other than that done by abutment details simultaneously with bridge construction or for preliminary clearing which may be necessary at construction sites.

6. COMPOSITION AND ASSIGNMENT OF EQUIPMENT. a. **Bridge set.** One unit of steel-treadway bridge equipage provides 864 feet of floating bridge. The bridge can be built to this length entirely by floating spans or by a combination of fixed and floating spans. When fixed spans are used exclusively the maximum length depends upon the spans of the 24 available trestles (see table I). Table III gives the component parts of the steel-treadway bridge set.

b. **Basis of issue.** One unit of steel-treadway bridge is issued per engineer treadway bridge company.

Table III. M2 steel-treadway floating bridge set

Item	Quantity
Adaptor, treadway, steel	24
Anchor, kedge, 100-lb.	80
Bag, canvas, paddle, 9-paddle-capacity	16
Binder, load, lever-type, heavy-duty	36
Block, snatch, steel-shell, iron-sheave, graphite-bronze-bushed, for manila rope:	
$\frac{3}{4}$ -in. rope, 6-in. shell	8
$\frac{7}{8}$ -in. rope, 7-in. shell	8
Box, sign, interior-illuminated, electric, 4- by 15-in., message	8
Bracket, stern-attachment, 22-hp outboard-motor, pneumatic- float, 18-ton, M1	8
Bracket, auxiliary trestle, 25-ton	12
Chain, log, w/hook and ring, $\frac{1}{2}$ -in. by 10-ft	72
Clamp, column-bracing (trestle-bracing), 25-ton	20
Clip, wire-rope, steel, galvanized:	
$\frac{1}{2}$ -in.	360
$\frac{5}{8}$ -in.	160
Float, pneumatic, with emergency kit, 18-ton, w/carrying case, M1	98
Grip, cable, $\frac{5}{8}$ -in., wire-rope	32
Hammer, machinists, ball-pein, type L, class 1, handled, 1 $\frac{1}{2}$ -lb.	24
Hoist, chain, ratchet, 1 $\frac{1}{2}$ - to 3-ton, 2 hoists w/spares per chest sets	20
Holdfast, complete w/9 pickets	12
Hook, boat, ball point, 10-ft	36
Hook, treadway-spacing	144
Hose, pneumatic, braided, w/couplings, $\frac{3}{4}$ -in.-dia., 50-ft	20
Lamp, electric, debris patrol and rescue boat	3
Lantern, electric, portable, hand, dry-cell, 6-volt	3
Marker, luminous (radioactive), type II, 1 $\frac{3}{4}$ -in., bolt-back	240
Paddle, boat, single-blade, 5-ft., single	144
Picket, steel, 1 $\frac{3}{4}$ -in. by 3-ft	144
Pin, lifting, trestle, 25-ton	24
Pin, treadway, steel	72
Pin assembly, strut-shoe, complete	8
Rope, manila, 3-strand:	
$\frac{1}{2}$ -in. feet	2,800
$\frac{3}{4}$ -in. feet	8,400
1-in. feet	14,400
Rope, wire, steel-cast, galvanized, fiber-core, regular-lay:	
6 by 19 stranding $\frac{1}{2}$ -in. rope feet	3,000
6 by 19 stranding $\frac{5}{8}$ -in. rope feet	2,000
Saddle, steel-treadway, knockdown, M1 (pneumatic float, 18- ton, M1)	72
Shoe, bracing-strut	8
Sledge, blacksmith's, double-faced, class II, handled, 12-lb	12
Snap, harness, round-eye, $\frac{3}{4}$ -in., rubber-finish	300
Strut, bracing (trestle-bracing), pipe, standard-black, 2 $\frac{1}{2}$ -in. by 22-ft	8

Table III. M2 steel-treadway floating bridge set—Continued

Item	Quantity
Tool, aligning, treadway.....	8
Treadway, steel, complete with 2 pins, w/I-beam lok open type flooring, M1, 45½-in., 12-ft.....	144
Trestle, complete wo/hoist, steel, 25-ton.....	24
Wedge, treadway:	
Blunt-end.....	8
Hook-end.....	8
Wrench, adjustable, crescent type, single-end, 1½-in. jaw opening 10 in. long.....	36

SECTION II

DESCRIPTION AND USE OF EQUIPMENT

7. PNEUMATIC FLOAT. a. The 18-ton pneumatic float (fig. 4) is 8 feet 3 inches wide, 33 feet long, and 33 inches deep. It is made of rubberized canvas tubing and consists of an outer tube, a floor, and a removable center tube. Each tube is 33 inches in diameter. The float weighs approximately 975 pounds and has a maximum displacement of 35,500 pounds when the voids between the center and outer tubes are filled with water. Deflated, it is rolled and packed in a carrying case 4 feet long and 3 feet 9 inches in diameter. Included in each case is an emergency repair kit.

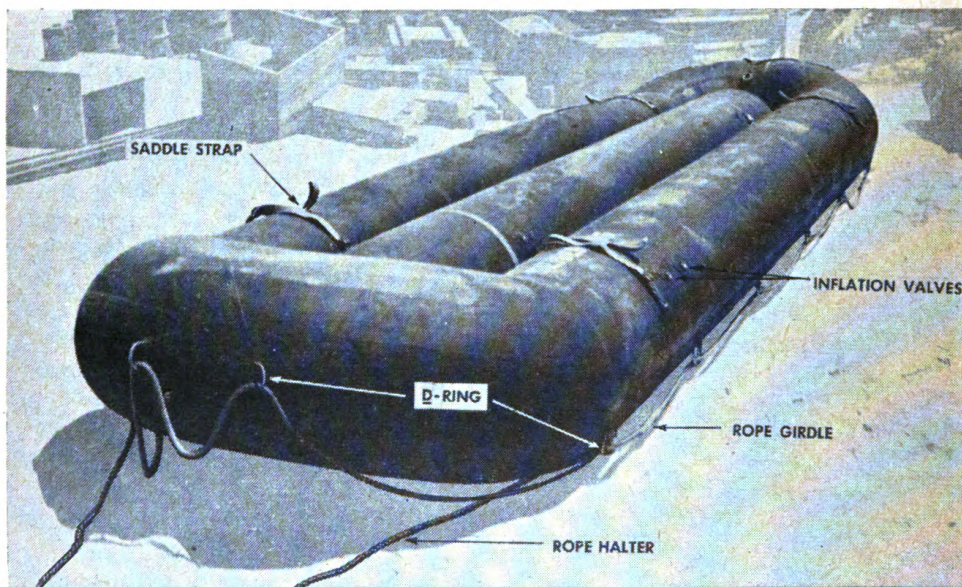

Figure 4. Eighteen-ton pneumatic float. (Length, 33 feet; diameter of tubing, 33 inches.)

b. The ends of the float are turned up to lessen the effect of currents pushing against it. D-rings (fig. 4) attached to the outside of the float support the rope girdle running completely around it. At each end a rope halter for anchoring the float (fig. 5) is spliced to the girdle. Straps attached to D-rings on the outer side of the outer tube fasten the saddle to the float. Straps attached to D-rings on the inner side of the outer tube hold the center tube in place. The removable center tube adds rigidity and buoyancy to the float when it is submerged.

c. Bulkheads divide the outer tube into 12 and the center tube into four

air compartments, each having a separate inflation valve. Using two four-hose manifolds and the 105-cfm motorized air compressor, the float can be inflated in about 5 minutes. The air pressure in the float should be maintained at 2 psi, at which pressure the air chambers are firm but yield to pressure applied by the heel of the hand. Additional pressure adds nothing to buoyancy and damages the float. Changes in temperature should be anticipated. To maintain proper pressure air must be released as the temperature rises or added as the temperature drops. Air pressure should be checked regularly. Deflate floats by removing valve caps and allowing air to escape. Draw out the remaining air with the inflation-deflation manifold to make the float easier to pack in small space.

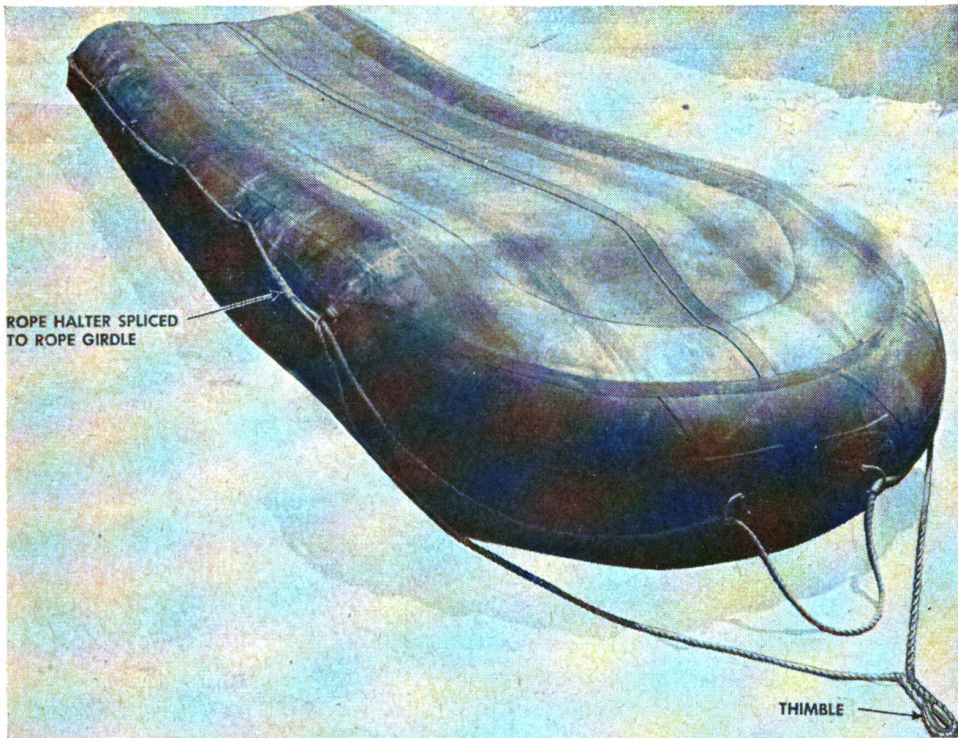

Figure 5. Bottom of pneumatic float.

8. SADDLE. a. The load on the bridge and the weight of the treadways are transmitted to the floats by a knockdown saddle (figs. 6 and 7①) which consists of two saddle beams surmounting eight bearing plates. The beams transmit the load to the float through the bearing plates. The completed saddle assembly weighs 2,200 pounds.

b. There are six interior bearing plates (fig. 7④) and two end ones (fig. 7③). They are constructed of $\frac{5}{8}$ -inch plywood. Each plate can be carried by two men.

c. Each saddle beam (fig. 7②) consists of two 6-inch wide flange steel beams, weighing 15.5 pounds per linear foot, joined together at the center

of the float by engaging with a pin the female end of one section with the male end of another to form a hinged joint. The hinge action of the beam under load is limited by a butt joint on the upper part of the connection. Hinged to the outer end of each beam are two 3-inch channels which transmit the load through the end bearing plates to the upturned ends of the floats. When the saddle is assembled, a removable pin hinges the channels to the web of the wide-flange beams; when knocked down, the pin is removed and the channels are retracted to fit between the flanges on each side of the web.

d. The saddle beams are held in place on the saddle by a sliding clip (figs. 7② and 8). One section of the clip is attached rigidly to the bearing plate; the other section is movable. To assemble, the movable section of each clip is driven open, the saddle beam is set in place against the fixed section, all bearing plates are oriented alike, and the movable section of each clip is driven home with a hammer. To disassemble it, the movable sections are driven away from the beam.

e. Another method employed to hold the saddle beams in place is by a spring-actuated catch. The catches are located on the bearing plates approximately in the same place as the sliding clips. The catches are provided with a handle for manual operation. To assemble the complete saddle the catches are opened manually, the saddle beam is set in place between the spacer lugs, and the catch allowed to close under the compression of the spring. To dismantle, the catches are opened manually and the beams are removed.

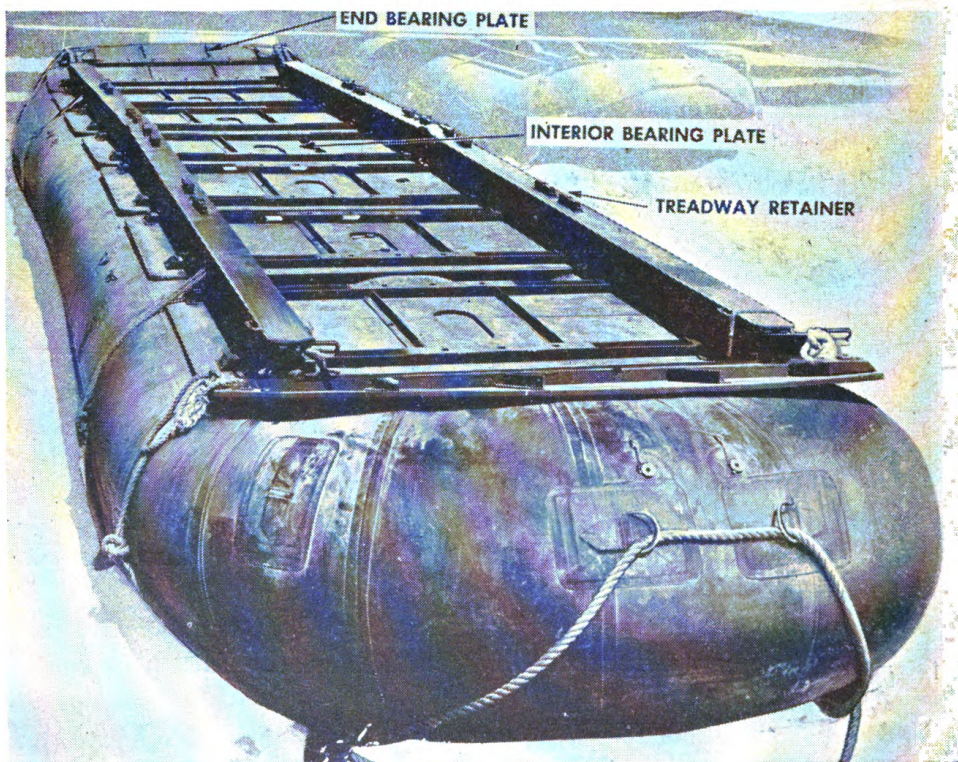

Figure 6. Saddle on pneumatic float.

f. On top of the saddle beams are treadway retainers (figs. 7② and 13) which hold the treadways in place. In assembly these retainers are driven over the lower flange of the treadway and pinned into place (fig. 8). There are four treadway retainers on each side of the middle of the saddle beam. To secure the treadways alternate treadway retainers are used beginning with the one on the downstream end of the saddle beam (fig. 10). The treadway retainers are placed so the treadways in position are offset 6 inches downstream on the pontoons. They are locked in place with a safety pin.

9. STEEL TREADWAY. a. The roadway of the bridge consists of parallel treadways. The narrowest vehicle the bridge will accommodate is the ¼-ton, 4 x 4 truck. The treadways will accommodate a vehicle 124 inches wide (outside clearance of tires or tracks), allowing 3 inches clearance at each curb.

b. The steel treadway (fig. 9) weighs 2,350 pounds and has an effective length of 12 feet and a clear track width of 45½ inches. It consists of two parallel steel channel beams tied together laterally by I-beams, channels, and pipe sleeves. It has a road surface of I-beam-lok flooring. At one end the main channels are blunt; at the other end, integral tapered engaging plates with hook ends provide an interlocking connection with the adjacent treadway. At the blunt end are two pipe sleeves running through holes in the webs of the treadway channels; at the hook end there is one hole and a notch in the engaging plates. Two treadway-connecting pins connect the blunt end of one treadway rigidly to the hook end of another treadway to form a continuous beam. Connection is made by inserting one treadway-connecting pin through the inner pipe sleeve in the blunt end of one treadway and the notches in the hook end of the other; the second pin is inserted through the outer pipe sleeve in the blunt end and the holes in the hook end.

c. A drill-rod curb (fig. 9) of 1¼-inch diameter steel is welded to the inner edges of the top flanges of the main channels to prevent tracked vehicles climbing out of the roadway. Three U-shaped eyes are welded to the outside of each main channel. The outer eyes are for the treadway-spacing hooks which space parallel treadways laterally; the middle eye is at the balance point and is used in handling the treadway when loading or unloading it from a truck. Directly above the middle eye a pear-shaped lifting hook hole is cut into the main channels. This accommodates the hook of the treadway-lifting chain of the treadway truck.

d. The treadways are so placed across the saddles on the floats (fig. 10) that their flanges are engaged by the treadway retainers on the saddle beams.

10. TREADWAY-CONNECTING PIN. Treadway-connecting pins are used to connect treadways longitudinally and to connect wedges at the ends of the bridge. The treadway-connecting pin (fig. 9) is 2⅜ inches in diameter, 4 feet 6½ inches long, and weighs 65 pounds. It has a handle at the blunt end and a hole at the tapered end to accommodate a safety pin (fig. 9).

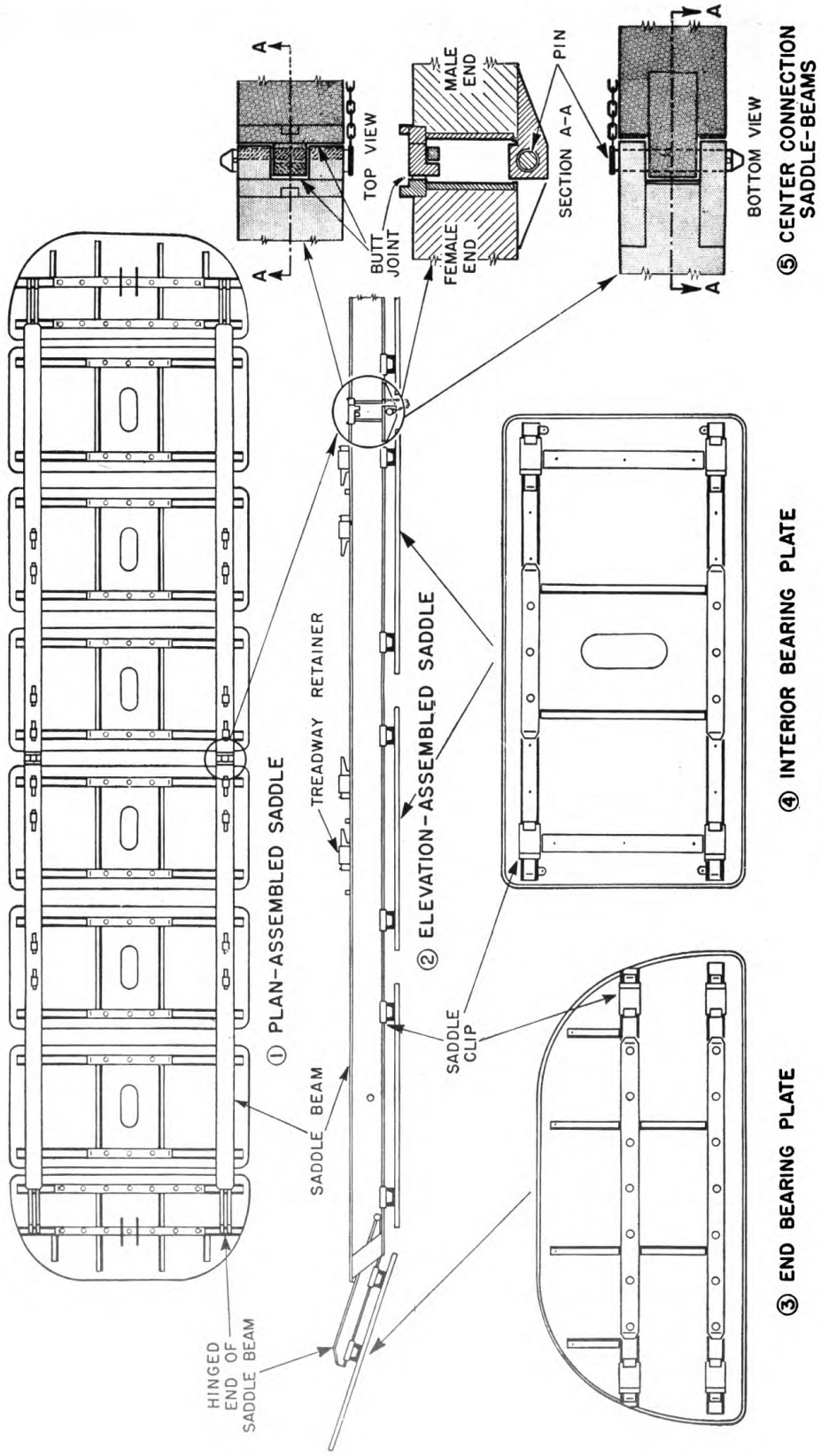

Figure 7. Knockdown saddle.

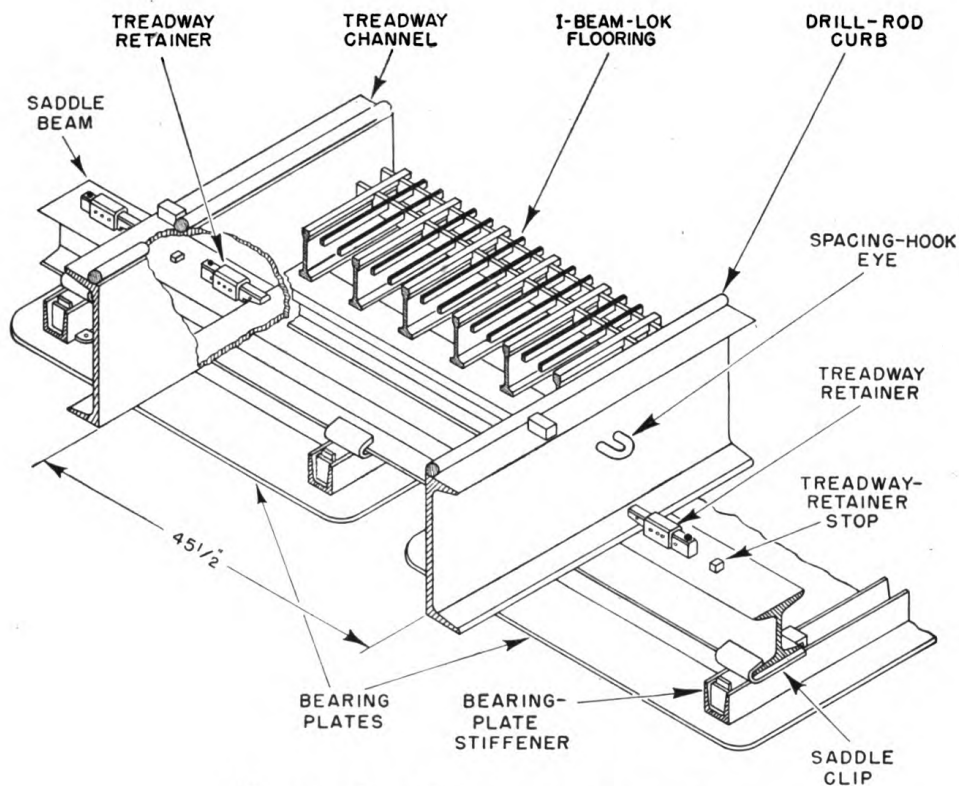

Figure 8. Assembly of treads on saddle.

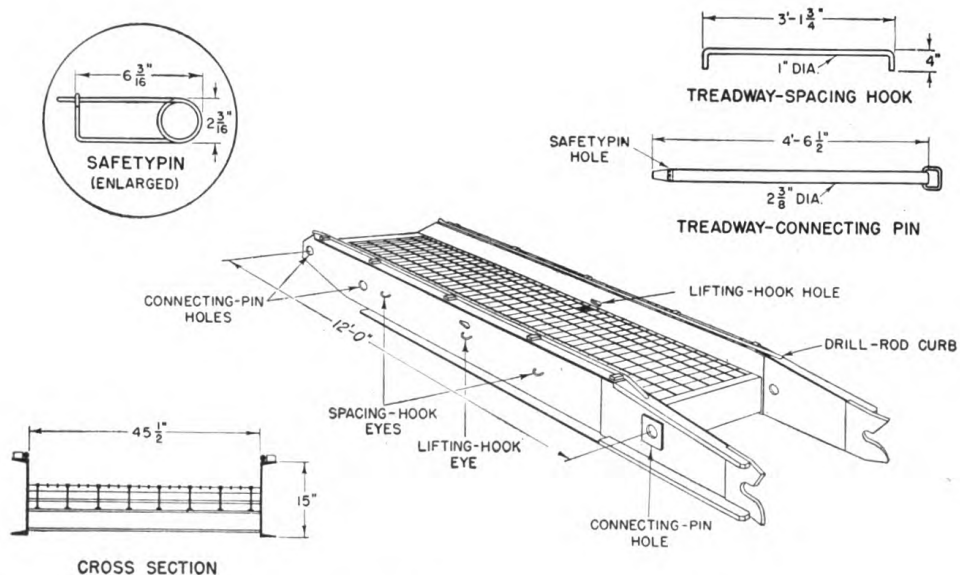

Figure 9. Steel treadway, with treadway-spacing hook, treadway-connecting pin, and safetypin.

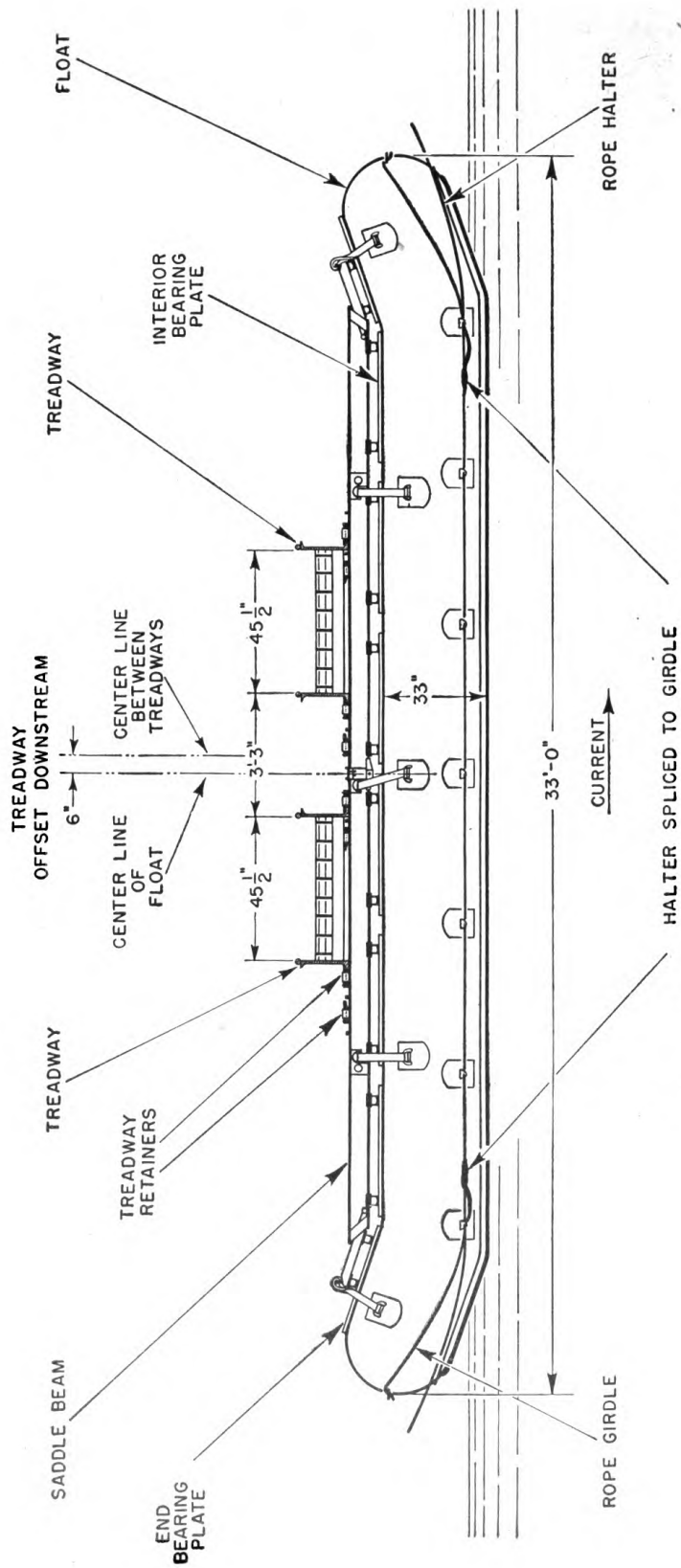
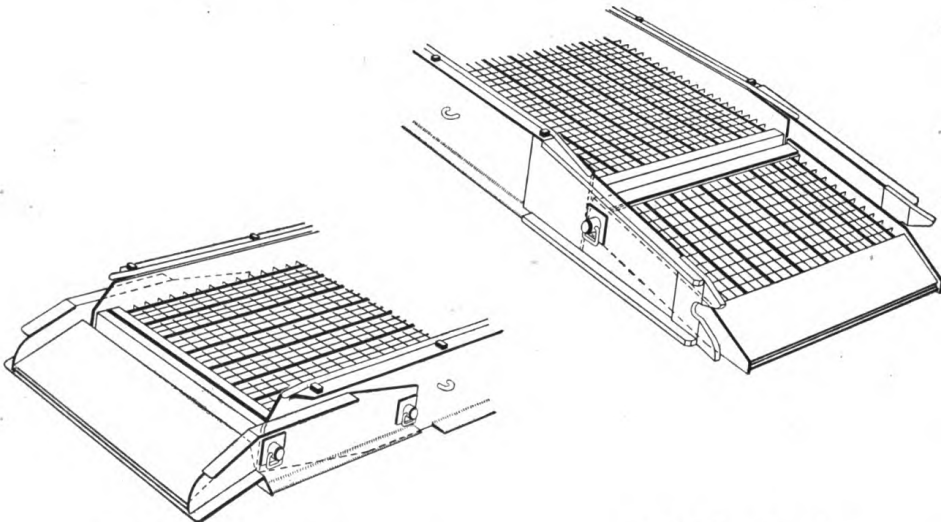

Figure 10. Steel treadways in position on pneumatic ponton.

11. TREADWAY-SPACING HOOK. The treadway-spacing hook (fig. 9) keeps treadways spaced parallel. It is a 1-inch diameter steel bar, 3 feet 1 $\frac{3}{4}$ inches long, with a 4-inch bend at each end, and it weighs 10 pounds. It is fitted into spacer eyes welded to the web of the treadway channel beam and when in place fixes the distance between the inside faces of the inner curbs at 3 feet 3 inches (fig. 10).

12. TREADWAY WEDGES. Treadway wedges are used on the ends of the steel-treadway bridge to facilitate the movement of vehicles on and off it. The wedges are of two types. Hook-end wedges (fig. 11②) are connected at the engaging-plate end of the treadway. This wedge has the same type of wearing surface as the treadway itself. Blunt-end wedges (fig. 11①) are connected at the blunt end of the treadway. This type wedge has a steel-plate deck. The hook-end wedge has one hole in its sides for one treadway-connecting pin and the blunt-end wedge has two holes for two pins.



① Blunt-end wedge.

② Hook-end wedge.

Figure 11. Treadway wedges.

13. ANCHORS. The bridge has 100-pound kedge anchors to secure it against currents and wind. Two hundred feet of 1-inch manila rope is provided for each anchor.

14. TRESTLE. The trestle of the steel-treadway bridge equipment (fig. 12) is the same as that of the heavy ponton bridge. It consists of a transom, two columns, and two trestle-column shoes.

a. Transom. The transom consists of a tubular-steel truss section. Each end of the transom is open so the trestle column can be inserted from the side. Two metal clamps hold together the jaws of this opening. At the ends of each transom are three sets of pinholes. Two pins on chains are at

tached to each end of the transom. The lower end of the ratchet chain hoist is attached to one pin inserted in the outermost set of pinholes. The second pin is inserted through one or the other of the remaining sets of holes and through one of the holes in the trestle column, securing the trestles to the column.

b. Columns. The column is a steel tube 5 inches in diameter with a vertical row of holes throughout its length. It has a chain-hoist supporting bracket to support the upper end of the chain hoist when the hoist is used to adjust the transom. The bracket can be attached to the column at any convenient height by an inserted pin attached to the bracket with a chain.

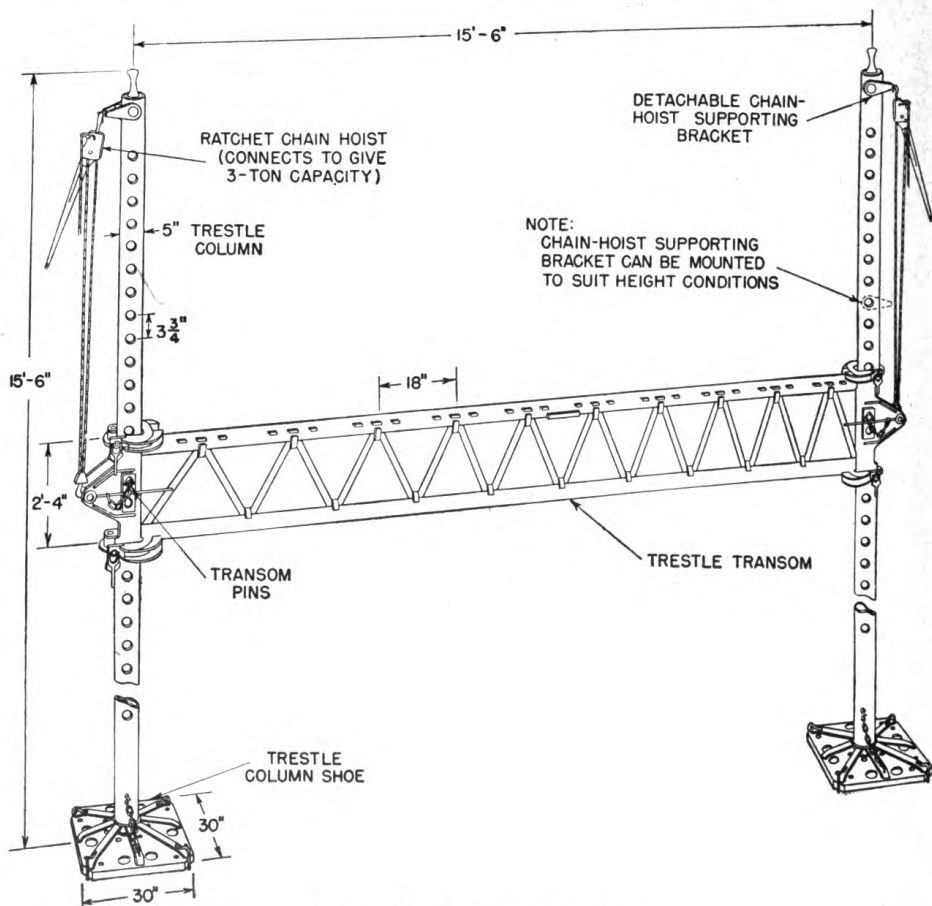

Figure 12. Assembled trestle.

c. Shoes. The trestle-column shoes, 30 inches square, are made of steel. The trestle column is fitted into a sleeve in the center.

d. Ratchet chain hoists. Two ratchet chain hoists of $1\frac{1}{2}$ - to 3-ton capacity are used to adjust the height of the transom. The hoist has a 12-foot chain which can be attached so only a single strand takes the load, giving a capacity of $1\frac{1}{2}$ tons; or, it can be doubled so that two strands take the load, giving the 3-ton capacity, required when treadways are in place.

15. TRESTLE-BRACING EQUIPMENT. Trestle bracing is used to

increase the stability of trestle spans subjected to heavy traffic. The trestle-bracing equipment is composed of the following parts:

- Bracing struts.
- Bracing-strut shoes.
- Bracing-strut shoe pins.
- Column-bracing clamps.

All of the above parts are described in C 1, TM 5-273.

16. TREADWAY ADAPTOR. There is a treadway adaptor (fig. 13) for each trestle. It consists of a 5-inch channel on which the treadways bear. The under surface of this channel has four semicircular bent plates with protruding lips which are bent around the tube of the trestle transom by a hammer to secure it in place. The upper surface has six treadway retainers similar to those on the saddles; however, they are spaced so they will accommodate either the 45½-inch or the old type 33-inch width steel treadways.

17. OUTBOARD MOTOR AND MOTOR BRACKET. a. The treadway bridge company has six 22-hp. outboard motors which can be used to propel either single pneumatic pontoons or pneumatic ponton rafts.

b. Each bridge set has eight stern attachment brackets (fig. 14) for mounting an outboard motor on the pneumatic ponton. The bracket is fastened to the saddle and can be lifted so the motor clears the water when not in use.

18. TOOLS AND ACCESSORIES. Each bridge set has the following tools and accessories:

a. Heavy-duty load binders and log chains to add stability to truck loads in transit.

b. Steel snatch blocks for miscellaneous rigging.

c. Wire-rope clips for wire rope.

d. Cable grips for handling wire rope.

e. Holdfasts to anchor light loads.

f. Manila rope, 1-inch for anchor lines, ¾-inch for bridle lines, and ½-inch for miscellaneous rigging. The 200-foot anchor lines and the 80-foot bridle lines with harness snap are made in the field.

g. Wire rope ½ and ⅝ inch in diameter for anchor cables and guy lines.

h. Treadway alining tools for alining treadways.

i. Adjustable crescent-type wrenches, sledges, and ball-pein hammers for miscellaneous use.

j. Paddles and boat hooks for handling pneumatic pontoons.

k. Lamps and lanterns for night construction.

19. PORTABLE AIR COMPRESSOR. Gasoline-engine-driven, port-

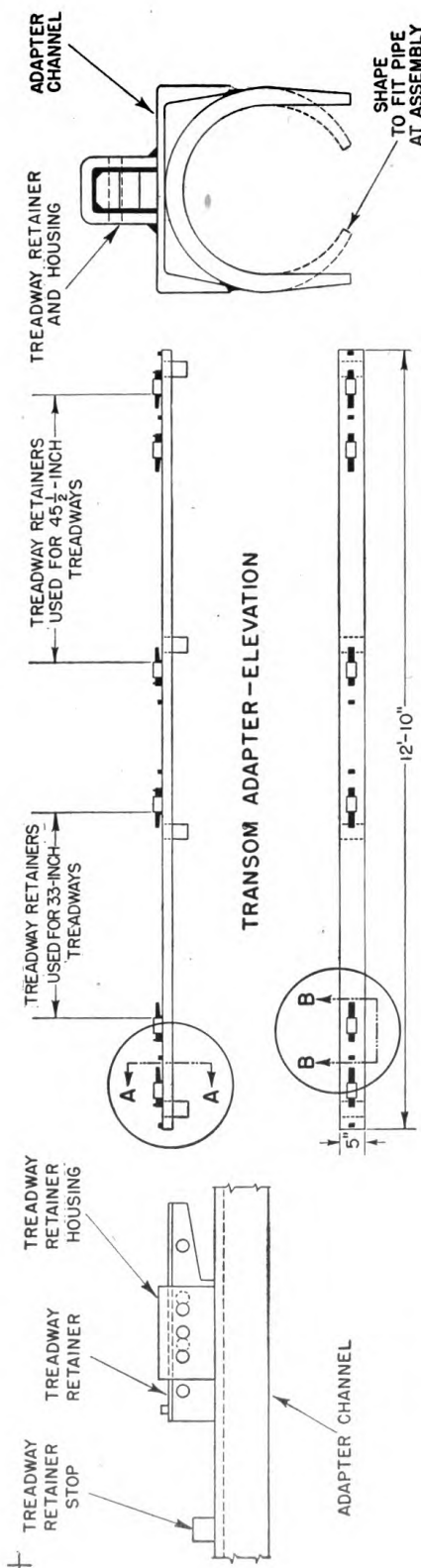

SECTION B-B (ENLARGED)

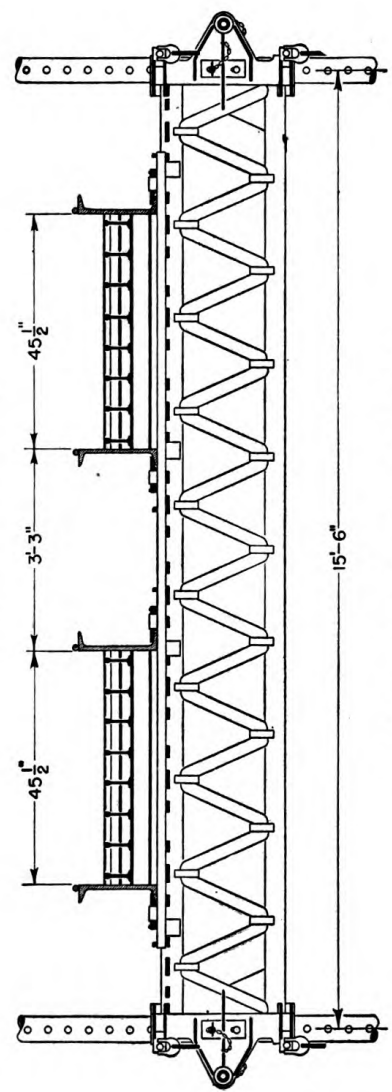

TREADWAYS IN PLACE ON TRESTLE
 Figure 13. Treadway adaptor.

able air compressors (fig. 15) of 16-cfm capacity are issued to the treadway bridge company for use in maintaining proper air pressure in the pneumatic floats in a bridge. In an emergency these compressors can be used to inflate the floats during construction. However, their limited capacity makes inflation relatively slow.

20. MOTORIZED AIR COMPRESSOR. Motorized air compressors (fig. 16) having a capacity of 105 cfm are issued to the treadway bridge company for inflating pneumatic pontons during the construction of a bridge. Using two four-hose manifolds this air compressor will inflate a float in about 5 minutes.

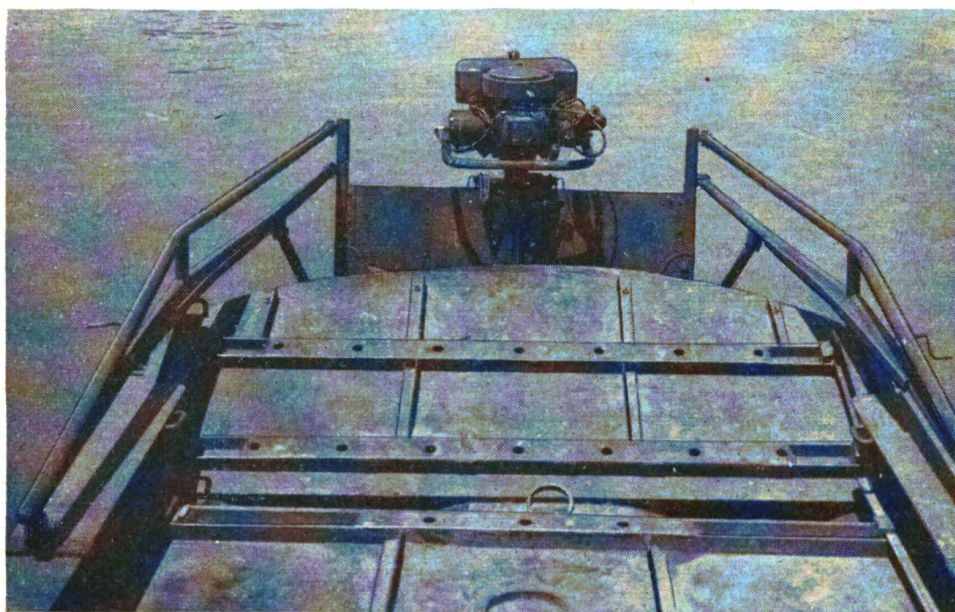

Figure 14. Outboard motor and bracket mounted on pneumatic ponton.

21. TRUCK CRANE. The truck crane (fig. 17) which is issued to the treadway bridge company is mounted on a 6 x 6 truck. This crane formerly was mounted on a 4 x 4 truck. Both a truck driver and a crane operator are essential, since one man cannot control both crane and truck. Treadways can be placed individually by the crane when necessary. However, the crane cannot handle the treadways in pairs as can the treadway truck (par. 27). The truck crane is useful when the bridge must be installed at a point where river banks are high and steep. Under such conditions pneumatic pontons are assembled on the bank and lowered into the water by crane.

22. POWER UTILITY BOAT. The power utility boat (fig. 18) issued to the treadway bridge company, is used to push bridge parts from assembly sites to the bridge site, to push rafts, and for general utility work during bridge construction.

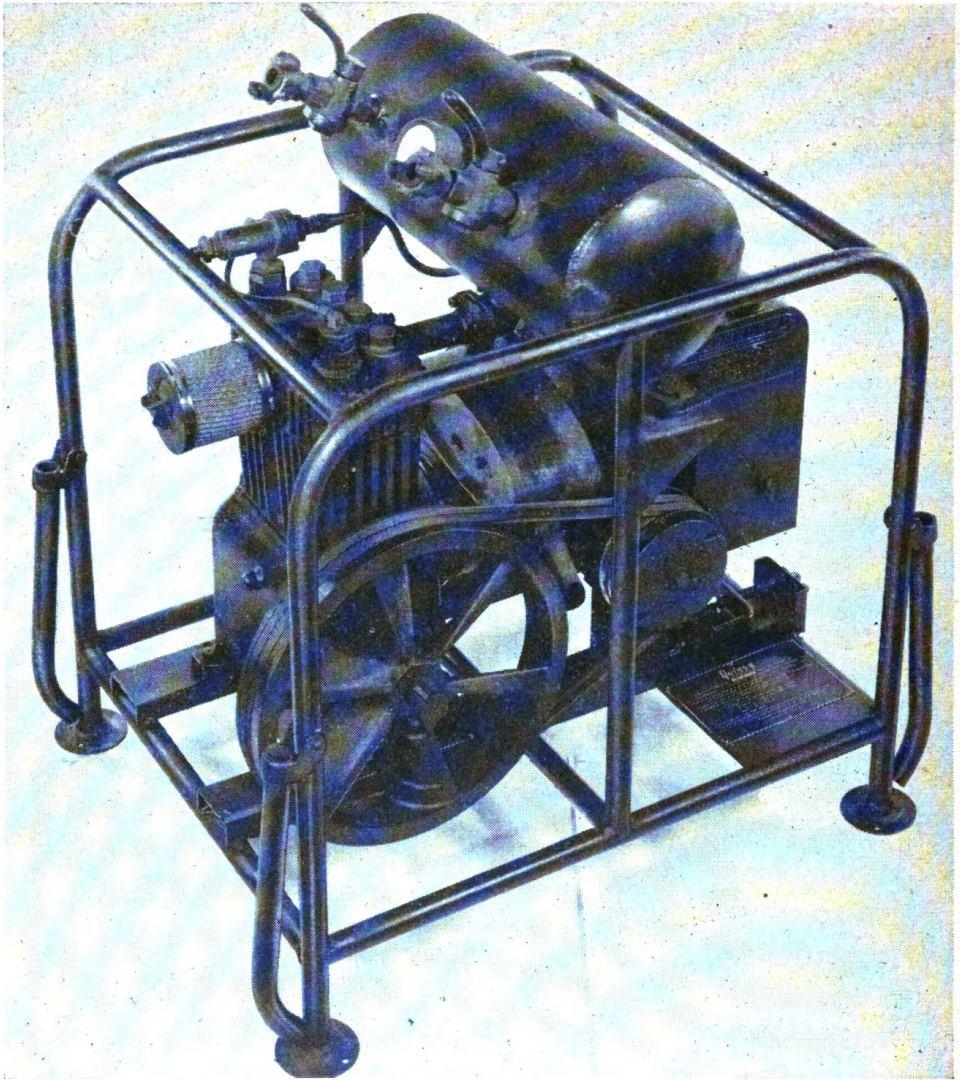

Figure 15. Portable air compressor.

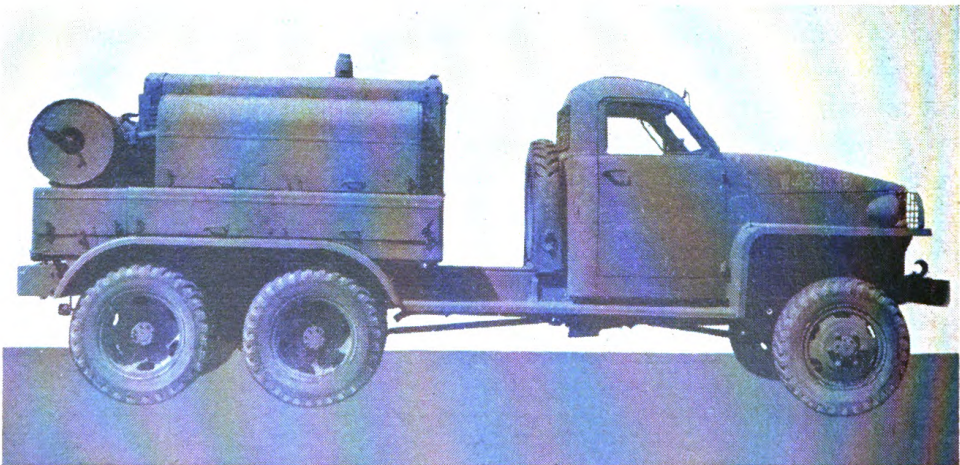

Figure 16. Motorized air compressor.

a. Boat. The hull is made of molded plywood which is strong and light and without seams. It has a rope fender and a carrying rail. Equipment includes towing bits, bow and stern lights, a mounted searchlight, a fire extinguisher, anchors, life preservers, spare parts, and tools. It has the following characteristics:

Length, over-all.....	18 feet.
Width, maximum.....	6 feet 9 inches.
Depth, maximum.....	2 feet 6 inches.
Weight, including engine and accessories.....	1,800 pounds.
Maximum allowable load.....	4,000 pounds.

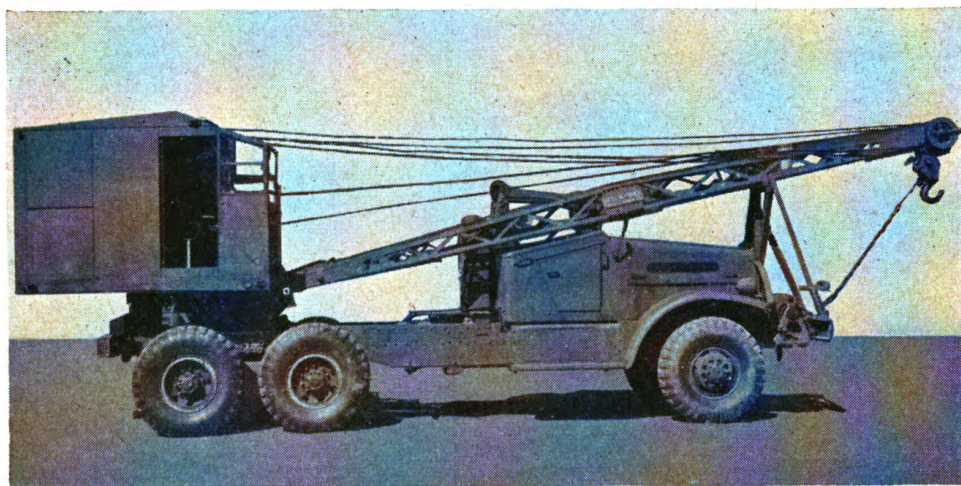

Figure 17. Truck crane.

b. Engine. The boat is powered with a 57-hp. marine engine equipped with a governor that keeps it operating at a safe and economical speed and allows it to develop its full power for towing or pushing. It has the standard marine type propeller drive with forward, neutral, and reverse gears.

c. Transportation. The boat is carried on a two-wheel pole type utility trailer, type IV, from which it can be launched directly into the water.

d. Precautions. The following precautions must be observed in using the powerboat:

- (1) Care must be exercised in launching to avoid damaging the hull.
- (2) Shallow places and snags should be approached at slow speeds.
- (3) Avoid crossing anchor and guy lines and heavily weeded water areas because the propeller becomes entangled easily.
- (4) When passing over a line disengage the clutch, stop the propeller, and allow the boat to drift over the line.

23. BLACKOUT MARKERS. Blackout markers are provided for delineating bridges during blackout. They may also be used advantageously for delineating location of stock piles and personnel. The following types are included in the bridge set:

a. **Radioactive luminous marker type II** (fig. 19①). This is circular, $1\frac{3}{4}$ inches in diameter. The front surface is luminous. The back surface has an integral bolt and nut for attachment.

b. **Interior-illuminated sign box** (fig. 19②). This is rectangular, with a 4- by 15-inch front face hinged so paper signs may be readily inserted. It is illuminated by a battery, controlled by a pull-push switch on the front of the box. A folding shield is attached to the box.

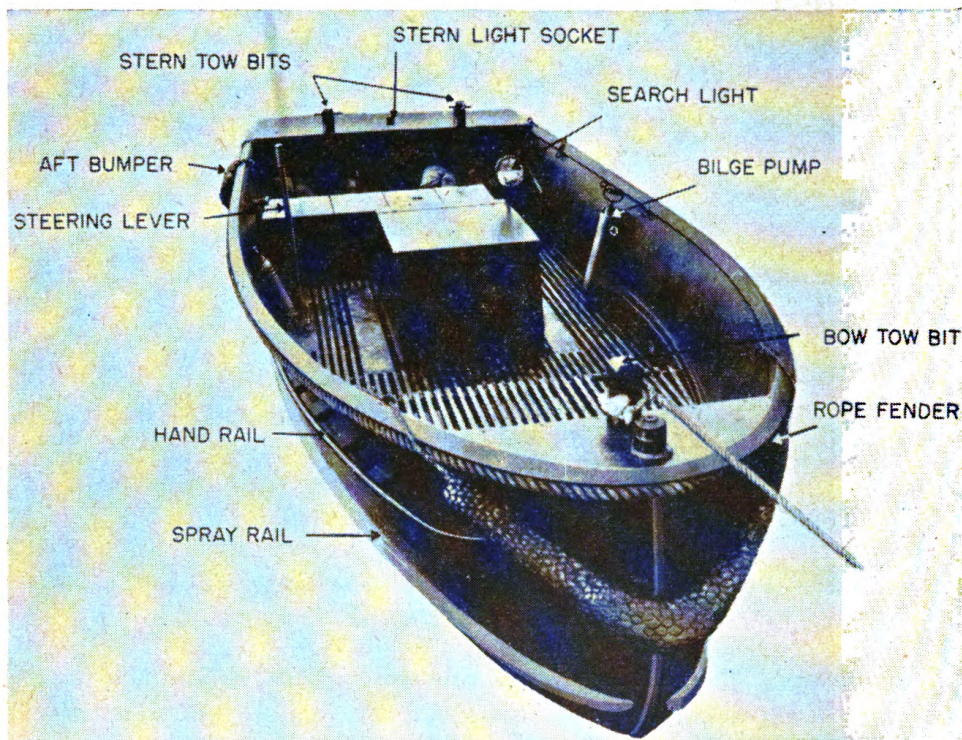

Figure 18. Power utility boat.



① *Radioactive luminous marker type II.*



② *Interior illuminated sign box.*

Figure 19. Blackout markers.

SECTION III

TRANSPORTATION

24. GENERAL. The steel-treadway bridge equipment is transported in 36 treadway trucks and 14 2½-ton cargo trucks. Each treadway truck carries sufficient equipment for 24 feet of floating bridge. Spare parts and trestle equipment are carried in the 2½-ton trucks.

25. TREADWAY TRUCK. a. Truck and crane. The treadway truck (fig. 20) is a special 6-ton, 6 x 6 cargo truck with a crane operated by four hydraulic cylinders powered by the truck engine. The crane is



Figure 20. Treadway truck.

operated from a platform at the front of the cargo body. Two long upper cylinders control the boom of the crane and two short lower cylinders act as boosters when the boom is extended. The maximum capacity of the crane with all four cylinders operating is 8,000 pounds. The unit has a fairlead and a snatchblock at the rear so treadways may be lowered beyond the reach of the boom. The snatchblock is attached to the boom, and the winch cable mounted on the front of the truck is threaded back through the fairlead and snatchblock.

b. Treadway-handling chains. Each truck has a set of treadway-handling chains (fig. 21) attached by stirrups to the boom of the hydraulic

crane. The two outer long chains are the sling chains. Each sling chain has a grab link and a grab hook, the use of which permits the chain to be adjusted to any desired length. Treadway slings, used to handle treadways except during loading or unloading from the truck, are linked to the grab link on each sling chain. A pair of treadway hooks is attached to the ends of the treadway slings. The treadway hooks fit over the flanges and the drill-rod curbs of treadways, or through the lifting holes in the sides of the treadways. A cross chain is linked between the sling chains. Suspended from the cross chain are two pairs of treadway hoisting hooks; the outside pair is on seven-link chains and the inside pair on one-link chains. The treadway-hoisting hooks are used in pairs, two outside and then two inside hooks, to load and unload two treadways at a time from the bridge truck.

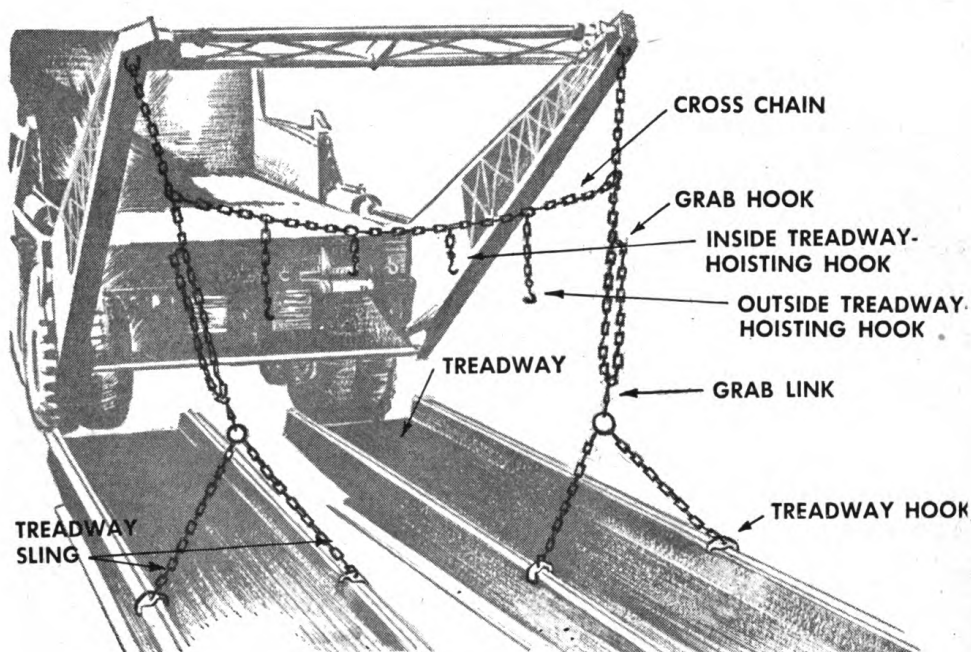

Figure 21. Treadway handling chains.

c. Air compressor. Each truck is equipped with a 24-cfm air compressor for emergency use.

26. CONTENTS OF TRUCK LOADS. **a. Treadway trucks.** For transportation, the treadways are placed on their sides in the bed of the truck. The parts of the saddles are placed as shown in figure 22. The floats are placed side by side on the truck bed, behind the treadways. Other equipment is placed where convenient. Each treadway truck contains the following equipment:

- 4 treadways.
- 2 knockdown saddles.

- 2 pneumatic floats.
- 4 treadway spacing hooks.
- 9 treadway connecting pins (1 spare).
- 2 anchors and anchor lines.
- 4 paddles.
- 4 75-foot guy lines.

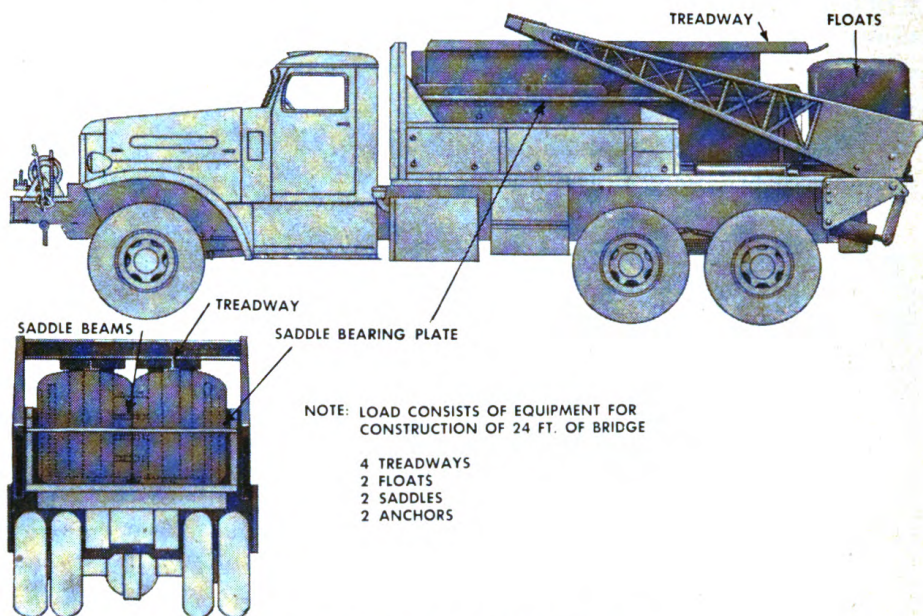

Figure 22. Loaded treadway truck.

b. 2½-ton trucks. The following equipment is carried in the 2½-ton trucks:

- Trestles.
- Trestle-bracing equipment.
- Extra pneumatic floats.
- Treadway adaptors.
- Blackout markers.
- Outboard motors and brackets.
- Boat hooks.
- Manila rope.
- Wire rope.
- Pneumatic float repair kits.
- Treadway wedges.
- Portable air compressors.
- Ratchet chain hoists.
- Tools and accessories.

27. OPERATION OF TREADWAY TRUCK. **a. Unloading.** The pneumatic floats are pushed off the end of the truck. Saddles, spacing hooks,

connecting pins, anchors and anchor lines, paddles, and guy lines are manhandled off the truck. The treadways are unloaded in pairs. Treadway-hoisting hooks are fastened into the lifting-hook eyes of the treadways. The inside hoisting hooks are attached to the inner treadways. The inner pair of treadways then are lifted out of the truck by the hydraulic crane (fig. 23①) and set upon the ground. The hooks are unfastened and the treadways are pushed over so that they lie horizontally with treads up. Treadway-spacing hooks then are placed in their appropriate places (see par. 11), sling chains are attached, and the treadways are ready to be placed on a float. The second outer pair of treadways is unloaded by using the outside pair of treadway-hoisting hooks. To avoid the outer treadways piling on each other, the sling chains are attached while the treadways are on edge, and the truck boom is used to put them in a horizontal position.

b. Loading. For loading, the sequence is reversed. The treadways on the ground are raised on their sides and the treadway-hoisting hooks are attached as in **a** above. The treadways are placed in the truck with their hook ends to the rear, the floorings of the inner pair face-to-face, and the floorings of the outer pair facing away from the center of the truck. The floats are loaded by fastening the sling chains to any convenient strap on the carrying case and lifting them into the truck with the hydraulic crane. All other parts are manhandled onto the truck.

c. Handling treadways in pairs. The treadway hooks of both treadway slings are fastened on the flanges or through the lifting hook holes of the treadway as shown in figure 23②. A treadway truck can handle only one pair of treadways at a time.

d. Handling treadways connected longitudinally. The treadway hooks of two treadway slings are fastened on the flanges of the treadways as shown in figure 23③. When this type of chain arrangement is used, both treadway slings are connected by the grab links to both main slings, rather than to a single main sling as when handling treadways in pairs. A treadway truck can handle two or three treadways connected longitudinally.

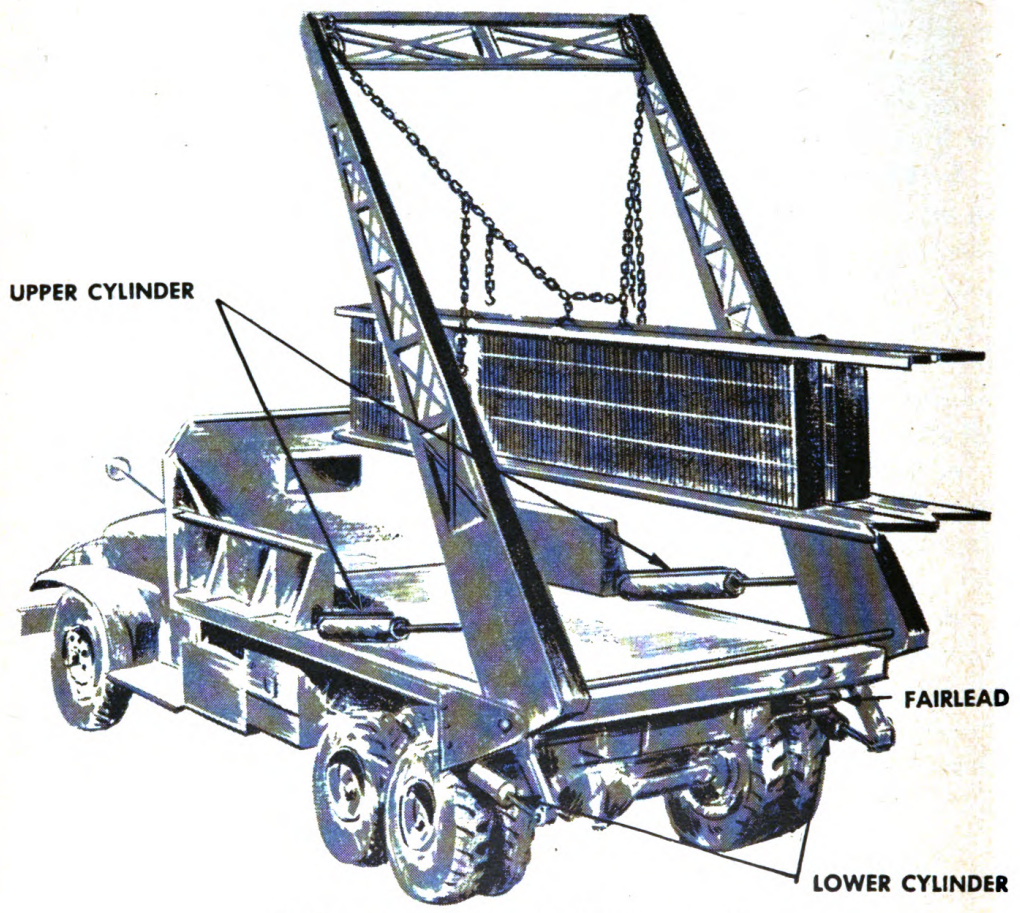

① Treadways being unloaded from truck.
Figure 23. Operation of treadway truck.

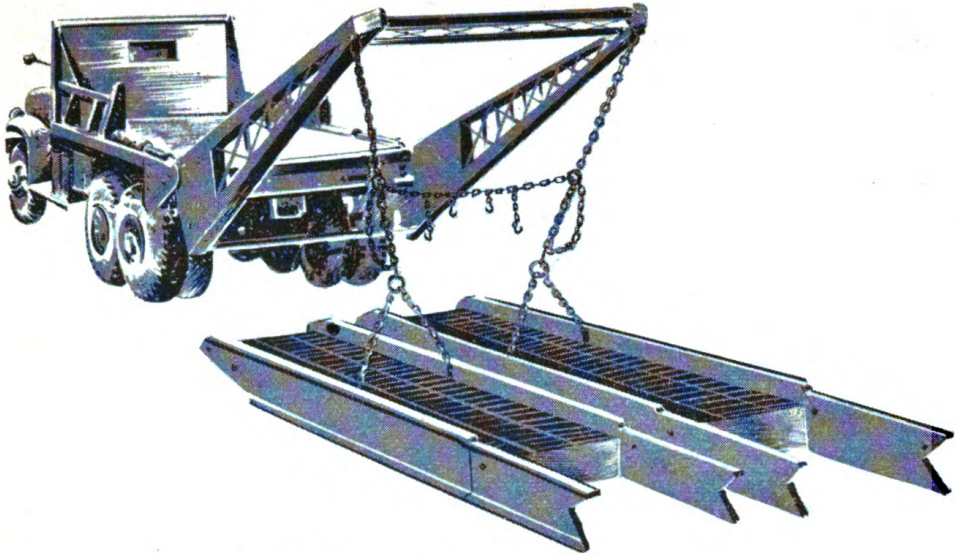

② *Handling treadways in pairs.*

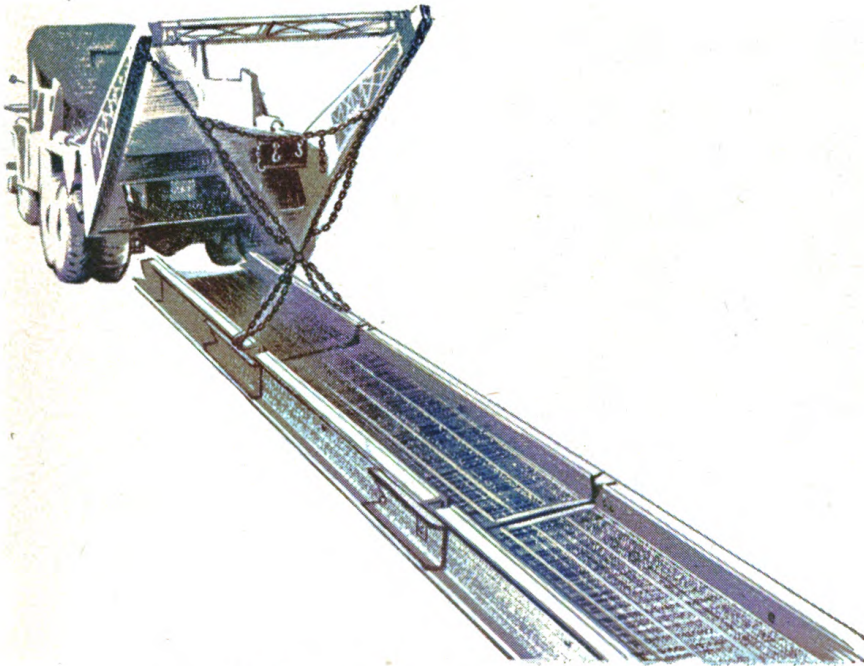

③ *Handling treadways connected longitudinally.*

Figure 23. Operation of treadway truck—Continued.

SECTION IV

SELECTION AND PREPARATION OF BRIDGE SITES

28. RECONNAISSANCE. a. The bridge site must be reconnoitered prior to construction so plans may be formulated and equipment operators instructed as to disposition of vehicles at assembly sites. The following technical data should be obtained:

- (1) Width, velocity, and depth of stream.
- (2) Character and shape of banks.
- (3) Rise and fall of stream.
- (4) Location of approaches to assembly sites.
- (5) Location and approach of tributary streams.
- (6) Location of main current.
- (7) Location of motor park for treadway trucks.

b. For detailed information on bridge reconnaissance, see FM 5-6 and FM 5-10.

29. SITE REQUIREMENTS. The following site requirements are desirable:

- a. Proximity to road net over which equipage can be moved.
- b. Approaches requiring little preparation.
- c. Current less than 10 feet per second.
- d. Banks less than 3 feet high and firm enough to support vehicles.
- e. Current parallel to banks.
- f. Stream bottom free of snags, sand bars, and large rocks.
- g. Stream bottom in which anchors will hold.

30. PREPARATION OF SITE. The amount of preparation required prior to erection depends upon the site. Brush and trees must be cleared from assembly sites. Approach roads must be cleared and made passable. A straight approach at least 30 yards long must be prepared for entrance onto the bridge. Whenever tactical conditions permit it is desirable to complete site preparation before bridge construction commences.

31. LAY-OUT OF SITE. A suggested site lay-out for bridges constructed by parts from far shore to near shore, using three assembly sites (see pars. 34 and 35), is shown in figure 24. Figures 25 and 26 give suggested site lay-outs for alternative methods of construction.

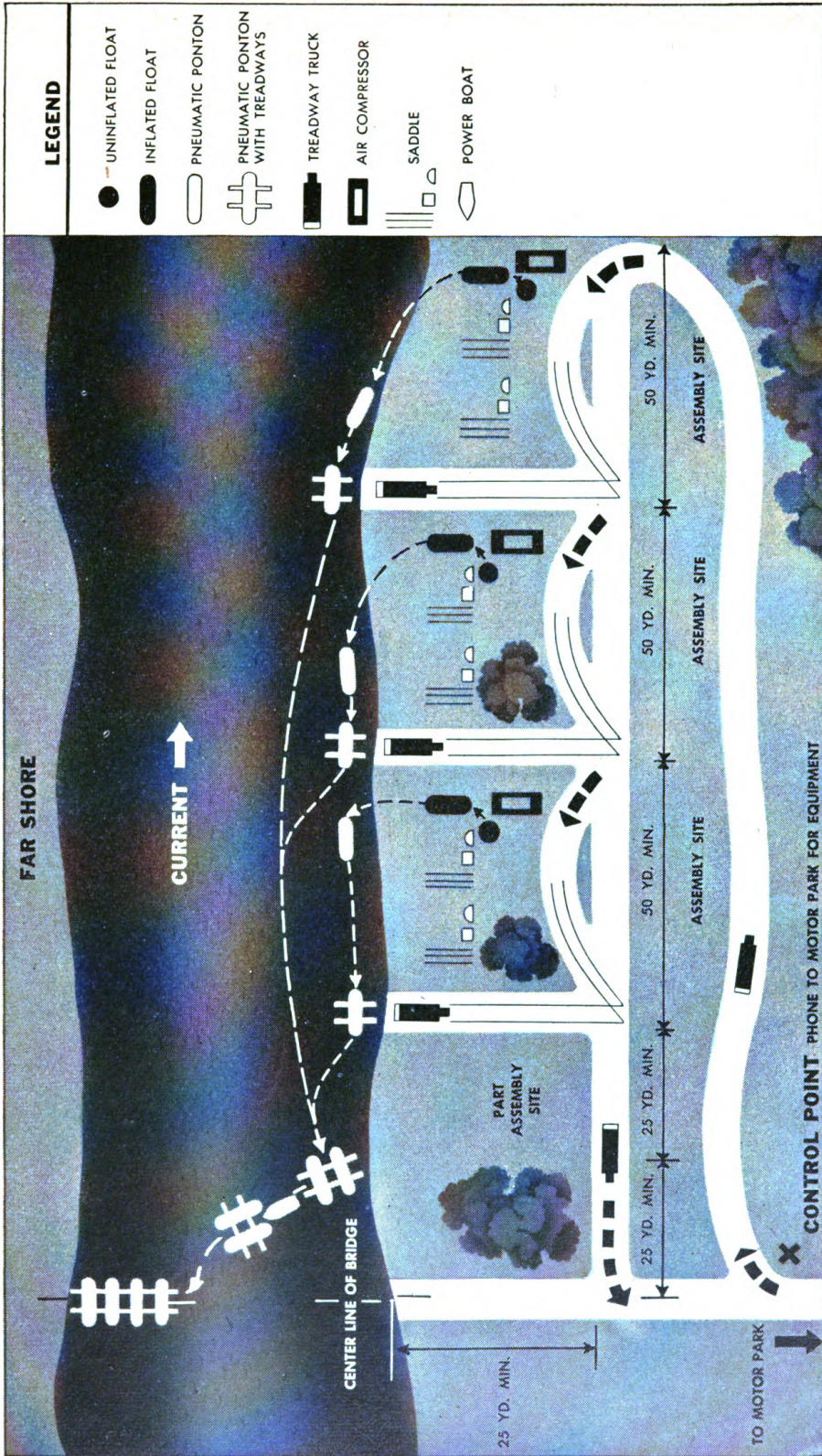

Figure 24. Site lay-out for bridge constructed by parts from far shore to near shore, using three assembly sites.

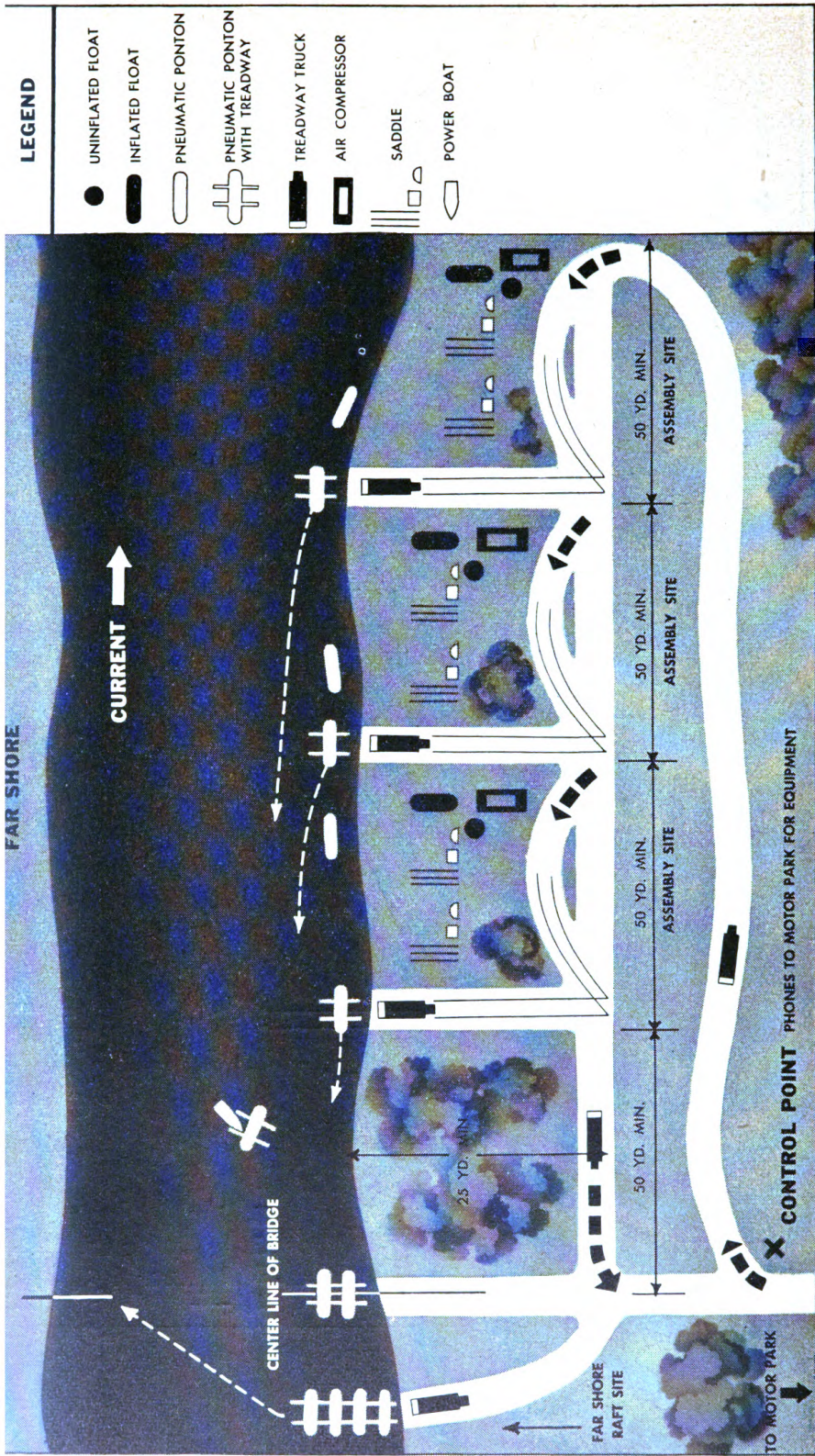

Figure 25. Site lay-out for bridge construction by individual pontoons from near shore to far shore, using three assembly sites.

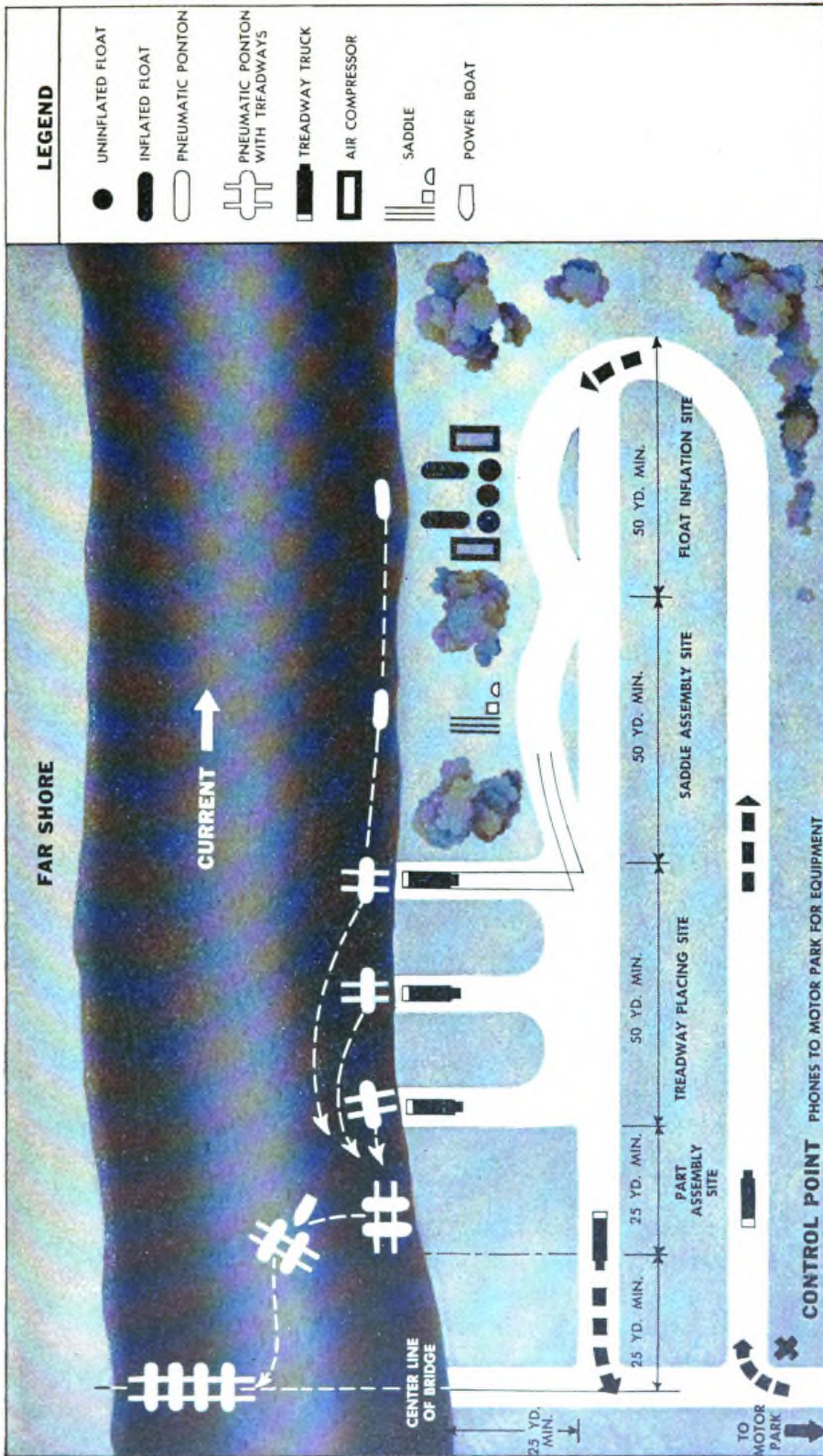

Figure 26. Site layout for bridge construction by parts from far shore to near shore, using one assembly site.

SECTION V

WORKING PARTY

32. ORGANIZATION OF WORKING PARTY. The working party is under the direction of the bridge officer who normally is from an armored engineer company. He is assisted as required by officers from both his company and the treadway bridge company supplying the equipment for the bridge. Personnel required for the construction normally is supplied by the constructing company assisted by noncommissioned officers, truck drivers, and assistant truck drivers of the treadway bridge company. Table IV gives a suggested organization of the working party for constructing bridges from three assembly sites, as shown in figure 24. When fewer or more assembly sites are used, the organization of the working party must be adjusted accordingly. Table IV does not include personnel for approach roads, security, and debris-control details, or for controlling the movement of treadway trucks from motor park to assembly sites and for operating field telephones.

33. DUTIES OF CONSTRUCTION DETAILS. The duties of the construction details are as follows:

a. Unloading detail (1 noncommissioned officer and 8 enlisted men). Two men climb on each truck as it approaches the float-inflation site and unload floats. The six men who remain on the ground roll floats to float-inflation site near the water, truck moves to saddle-assembly site, and men on truck pass saddle beams, bearing plates, treadway pins, anchors, anchor lines, float guy lines, and paddles to men on ground, who carry them as close to stream as possible. All equipment must be stacked in its proper stock pile.

b. Float-inflation detail (1 noncommissioned officer and 9 enlisted men). (1) The float-inflation detail includes the air compressor operator. Six additional men can be added to help carry the floats. The detail—

- (a) Unrolls and spreads out floats.
- (b) Inflates floats to a pressure of 2 psi (see par. 7c).
- (c) Launches floats *by carrying them* into the water.
- (d) Turns over floats to two-man crew of ponton-handling detail.
- (e) Stacks float carrying cases and emergency repair kits.

Table IV.—Organization of working party

Details	Equipment per detail	Personnel				Number of details	Total personnel	
		Bridge Company		Construction Company			Noncom-missioned officers	Enlisted men
		Noncom-missioned officers	Enlisted men	Noncom-missioned officers	Enlisted men			
Unloading.....	1 air compressor.....	1				3	24	
Float-inflation.....	{ 4 hammers.....	1	1		3	3	27	
Saddle-assembly.....	{ 4 treadway pins per float.....	1			3	3	24	
Treadway placing.....	2 sledge hammers.....	1			3	3	12	
Truck drivers and assistant drivers.....	12 bridge trucks.....		24		3	3	72	
Ponton-handling.....	{ 1 75-ft. rope and 1 paddle per man.....			1	1	1	20	
Bridge-assembly.....	{ 2 alining tools.....							
	{ 2 sledge hammers.....	1			1	1	6	
	{ 2 12-ft planks.....							
	{ 4 picks.....							
Near-shore-abutment*.....	{ 8 shovels.....							
	{ Logs for deadmen, cables, cable clips, and wrenches for guy lines.....			1	1	1	12	
Far-shore-abutment*.....do.....							
	1 powerboat.....		1		1	1	12	
Powerboat.....					2	2	6	

Total.....16 215
 Bridge company.....13 77
 Constructing company... 3 138

*A bulldozer with operator is attached to these details when required.

(2) When floats are launched from steep high banks, they are placed in the water by a truck crane (see par. 21). The saddle may be placed on the float (see e below) before launching, the assembled ponton being fitted with a rope sling so it can be readily handled by the truck crane. Treadways can be placed in the normal manner (see d below) with the unloading treadway truck held in place by a preventer line to a winch on another truck, by the truck crane, or by the winch cable of the treadway truck running through the fairlead and a snatch block (par. 25a) at the rear of the truck.

c. Saddle-assembly detail (1 noncommissioned officer and 8 enlisted men). (1) Two men carry and place each bearing plate on floats which are delivered by ponton-handling detail (e(2) below). Bearing plates are placed in the following order:

(a) First pair of interior bearing plates is placed over inflation valves of center tube.

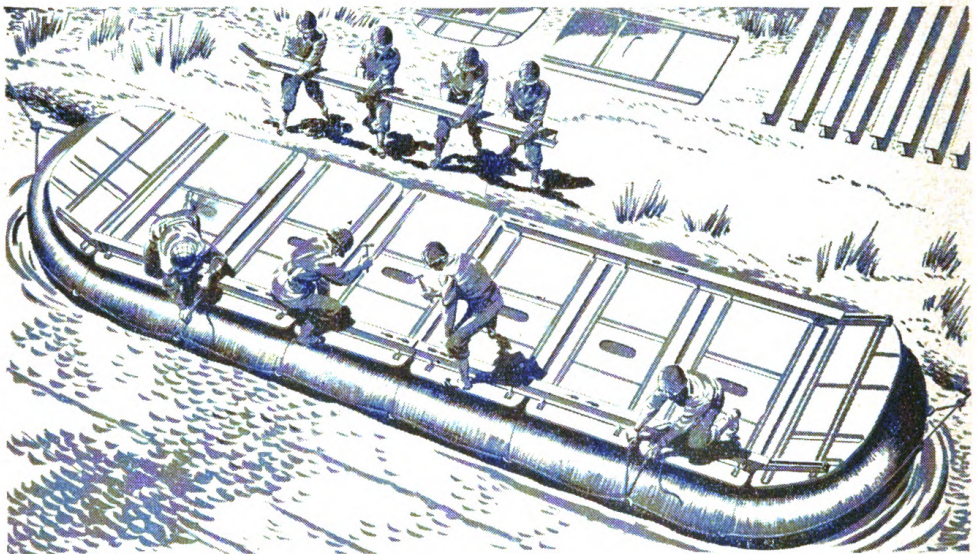

Figure 27. Saddle-assembly detail placing saddle on float.

(b) Second pair of interior plates is placed inside first pair.

(c) Third pair of interior plates is placed one on each flank of the first pair.

(d) Two end-bearing plates are placed.

(2) Four men carry and fit each saddle beam in place under stationary section of saddle-beam clip. Beams are placed in the following order:

(a) Riverward upstream beam (with female fittings).

(b) Shoreward upstream beam (with female fittings).

(c) Riverward downstream beam (with male fittings).

(d) Shoreward downstream beam (with male fittings).

(3) Four men drive movable section of saddle-beam clips into place with hammers; four men lash assembled saddle to float with the straps attached to D-rings of float (fig. 27).

(4) Four treadway pins are placed on the assembled pneumatic ponton which is turned over to two-man crew of ponton-handling detail. Two pins are inserted at treadway-placing site (d(6) below) and two at either part-assembly site (e(5) below) or bridge site (g(4) (a) 2 below).

d. Treadway-placing detail (1 noncommissioned officer and 4 enlisted men). (1) Treadway-placing detail—

(1) Directs placing of treadway truck in its proper place at treadway-placing site. Truck stops far enough back from edge of bank so treadways can be placed on ground between back of truck and edge of water.

(2) Connects treadway hooks (see par. 27e) to one pair of treadways and guides treadways as they are lifted from truck and placed on ground.

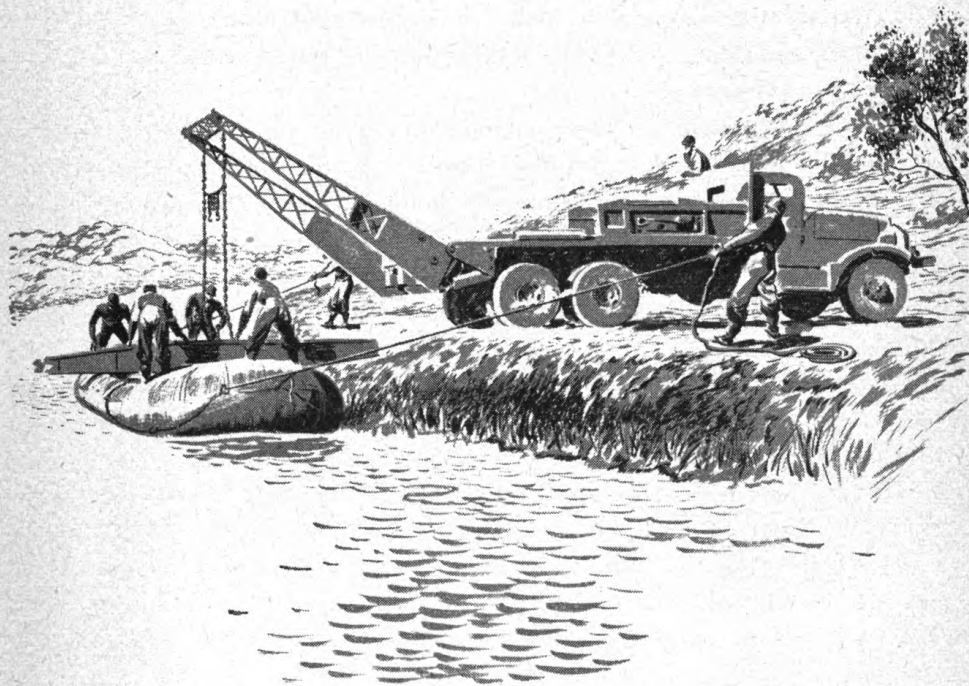

Figure 28. Treadway-placing detail guiding treadways onto pneumatic ponton.

(3) Disconnects treadway hooks and pushes inner treadways over so they fall flat. Uses treadway slings and truck boom to place outer treadways flat.

(4) Connects hooks of treadway slings through pear-shaped holes in sides of treadways and, as treadways are lifted off the ground, inserts treadway spacing hooks. Detail then guides treadways into position on pneumatic ponton (fig. 28). Treadways must be centered and balanced on pontons or assembly may overturn, and aligned longitudinally so they will fit in bridge.

(5) Drives treadway retainers on saddles into place over flanges of treadways (fig. 8) and inserts pins.

(6) Inserts a treadway pin through inner holes of blunt end of each treadway and turns over assembled part to two-man crew of ponton-handling detail.

e. Ponton-handling detail (1 noncommissioned officer and 20 enlisted men). Noncommissioned officer and 6 men remain at part-assembly site. Remaining 14 men are divided into two-man crews which are dispatched to float-inflation sites as required. Each crew secures a float as it is launched by float-inflation detail. Crew stays with float until it arrives at part-assembly site. Each two-man crew—

(1) Attaches guy lines to floats and picks up two paddles.

(2) Paddles or pulls float along shore to saddle-assembly site.

(3) Assists saddle-assembly detail as needed and, when saddle has been attached, places anchors as required on float and paddles or pulls it along shore to treadway-placing site.

(4) Assists treadway-placing detail as needed and, when treadways have been placed, paddles or pulls float along shore to part-assembly site. Powerboats are used if sites are far apart.

(5) Assists six-man crew at part-assembly site in connecting together two assembled pneumatic pontoons. Blunt ends of one pair of treadways are inserted between engaging plates of hook ends of other pair. Pins already in place in blunt ends (d(6) above) fit into notch of hook ends of second pair of treadways. A second pair of pins then is driven through holes of hook-end treadways and outer holes of blunt-end treadways to fasten treadway rigidly.

(6) Assisted by powerboat crew, joins crew of other pneumatic ponton in attaching powerboat to assembled part. One crew goes in powerboat and delivers part to bridge-assembly detail. It assists in incorporating part into bridge, and returns to float-inflation site in powerboat. Meanwhile other crew returns to float-inflation site, picks up float, and repeats procedure.

(7) When bridge is built by method of individual pontoons powerboat picks up assembled pontoons at treadway-placing site. Ponton-handling crews remain with ponton until it is assembled into bridge. This method eliminates work at part-assembly site.

f. Truck drivers and assistants (24 enlisted men per site). (1) Truck is moved as directed from motor park to assembly site where floats, saddles, and small parts are unloaded.

(2) Truck is moved to treadway-placing site as directed.

(3) Directed by treadway-placing detail, truck is backed into proper place (par. d(1) above) at treadway-placing site.

(4) Assistant driver operates truck boom, and driver moves truck while boom is operated as directed by noncommissioned officer of treadway-placing detail.

(5) Truck is returned to motor park.

g. Bridge-assembly detail (1 noncommissioned officer and 6 enlisted men). The bridge-assembly detail—

(1) Receives from ponton-handling crews first four assembled pneumatic pontoons constructed at part-assembly site. Connects pontoons into four-ponton raft as described in e(5) above.

(2) Receives a pair of overhanging treadways from a treadway truck and installs them at one end of raft.

(3) After raft is loaded with men and equipment of far-shore abutment detail, crosses stream on raft pushed by powerboat.

(4) (a) When bridge is built from far shore to near shore, remains on far-shore raft and receives parts delivered by powerboat. Parts must approach bridge with hook ends of treadways toward far shore (see par. 34d). Parts are incorporated into bridge as follows:

1. Four men of detail pull part into bridge proper by guy lines; other two men guide ends of treadways together (fig. 29).

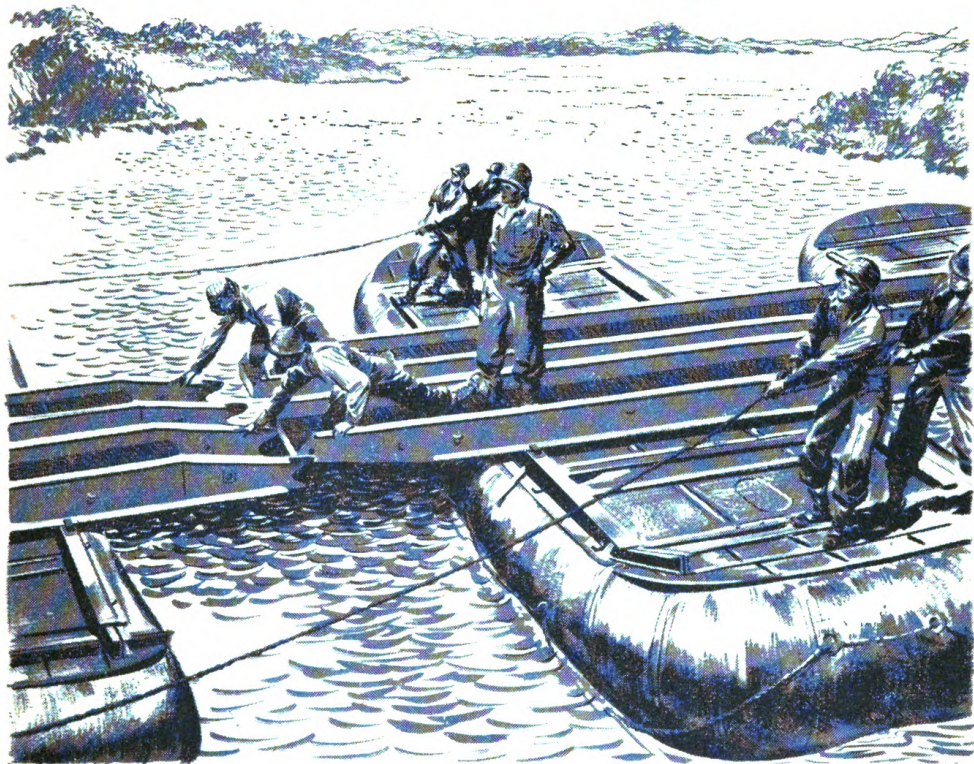

Figure 29. Part being incorporated into bridges.

2. Minor adjustments are made with treadway-alining tools, and treadway pins are inserted and driven through treadway holes with sledge hammers as described in e(5) above. Before connection is made, 3- by 12-inch planks about 12 feet long are laid parallel to and outside of treadways to provide a platform for men inserting treadway pins (fig. 30).

(b) When bridge is built from near shore to far shore, detail remains on near shore and receives parts from ponton-handling crews. It connects parts together in manner described in (a) above. A pair of overhanging treadways first must be connected to shoreward end of first ponton part received.

h. Near-shore abutment detail (1 noncommissioned officer and 12 enlisted men). The near-shore abutment detail—

(1) Prepares abutment as described in paragraph 37. Erects trestles, when used.

(2) Prepares holes for and places deadmen as required (see par. 36). When bridge is built from far shore to near shore, deadmen farthest from center line are prepared first; when bridge is built from near shore to far shore, deadmen nearest to center line are prepared first.

(3) Secures shore guy lines and anchor cables, when used, to deadmen and tightens them after bridge is in final position.

(4) Improves approaches as required.

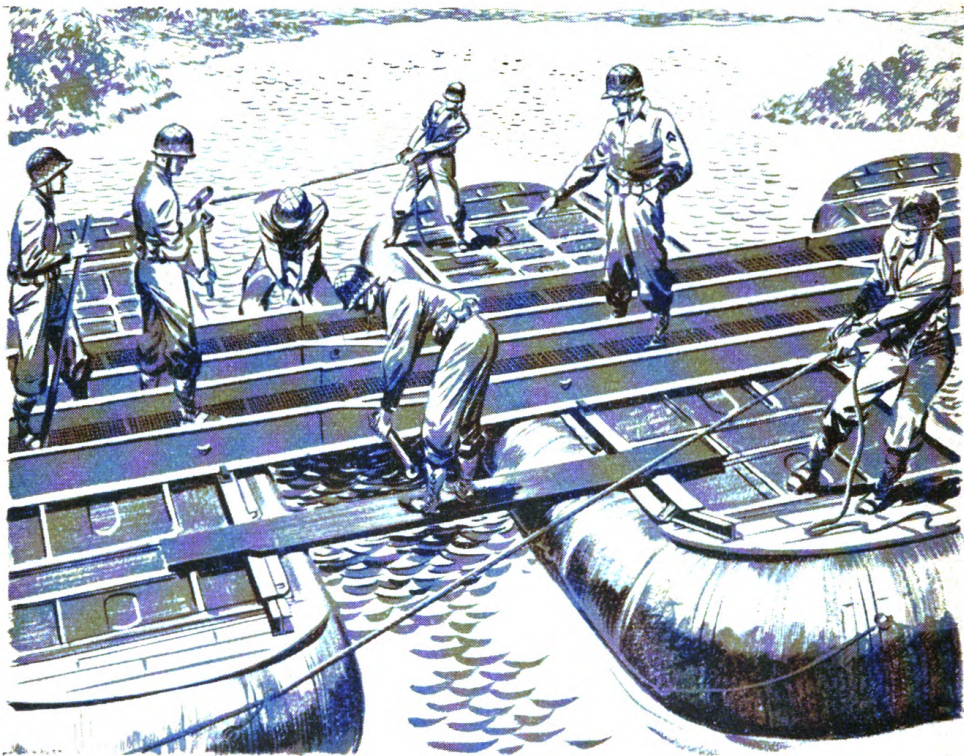

Figure 30. Treadway-connecting pins being inserted.

i. Far-shore abutment detail (1 noncommissioned officer and 12 enlisted men). The far-shore abutment detail—

(1) Crosses on far-shore raft and secures raft to shore.

(2) Prepares abutment; erects trestles, when used.

(3) Prepares holes for and places deadmen as required (see par. 36). When bridge is built from far shore to near shore, deadmen nearest to center line are prepared first; when bridge is built from near shore to far shore, deadmen farthest from center line are prepared first.

(4) Secures shore guy lines and anchor cables, when used, to deadmen and tightens them after bridge is in final position.

j. Powerboat detail (6 enlisted men). Powerboat detail is divided into two crews, each consisting of an operator and two men. It acts as follows:

- (1) Launches two powerboats directly from trailer (see par. 22c).
- (2) Strings upstream anchor cable, when used.
- (3) Uses boats to push far-shore raft from assembly site across stream.
- (4) Uses boats as required to push parts from part-assembly site to bridge, laying upstream anchors or attaching bridle lines to upstream anchor cable by pushing part upstream and then backing downstream to bridge. Downstream anchors or bridle lines and anchor cable are left off until bridge is completed.
- (4) Acts as rescue patrol as required during bridge construction.

SECTION VI

CONSTRUCTION

34. METHODS OF CONSTRUCTION. a. The steel-treadway bridge can be constructed by the following methods:

(1) *Direction of construction.* (a) From far to near shore.
(b) From near to far shore.
(c) From both shores.
(d) From neither shore; pontoons pinned together but not initially tied into either shore.

(2) *Method of assembly.* (a) By two-ponton parts.

(b) By individual pontoons.

b. The assembly sites may be downstream or upstream from the bridge site, or both. The location and number of the assembly sites depend upon the location and number of adequate cleared spaces with a road net leading to them, and on the number of troops available. Assembly sites downstream generally are better, for with powerboats it is easier to maneuver parts to the bridge against the current.

c. The method of bridge construction depends upon length of bridge, bank conditions, current, conditions of approach roads, and the number of troops available.

d. Regardless of whether the bridge is built from either shore or from both shores simultaneously, a far-shore raft consisting of four pneumatic pontoons with five pairs of treadways—one pair overhanging for connection to the shore—is always built first. The raft is connected to the far shore with the hook ends of the treadways shoreward. The raft serves as part of the bridge and also is used to cross the far-shore abutment detail with bulldozers, air compressors to operate pneumatic tools, and treadway trucks as needed in preparing the far-shore abutment and approach.

35. ADVANTAGES OF DIFFERENT METHODS OF CONSTRUCTION. The advantages of the different methods of construction are as follows:

a. **Direction of construction.** (1) *From far to near shore.* (a) Near-shore approach can be used as part-assembly site.

(b) Shore guy lines first placed lead to far shore and do not interfere with movement of pontoons to bridge.

(c) Any delay incident to preparation of near-shore approach is eliminated.

(d) Final adjustments and final pinning are completed at near shore where mechanical aids are more readily available.

(2) *From near to far shore.* (a) Parts can be towed along the shore into position at the bridge.

(b) Since all work except that on far-shore approach is done on near shore, supervision of erection is easier.

(c) Any delay incident to preparation of the far-shore approach is eliminated.

(3) *From both shores.* This method is advantageous only when a long bridge is built. Bridge-assembly details work from both shores. Final pinning is made by placing a treadway truck on near-shore section, attaching a tow chain from it to far-shore section, and pulling sections together. Both sections must be free to float from their respective banks during final pinning. This method should be used only when personnel are available for more than three assembly sites, for one bridge-assembly detail can pin parts together as fast as three sites can furnish them.

(4) *From neither shore.* This method is advantageous when approaches at both banks require considerable preparation. Parts are pinned together as in construction from near shore, except first ponton is anchored instead of being attached to shore. Successive parts are pinned to it. When one approach is ready, a part consisting of two or more pontoons is attached to shore and floating section previously pinned together is propelled to it. This method should not be used in currents over 3 feet per second, in the building of long bridges, or when winds make bridge alignment difficult.

b. Method of assembly. (1) *By two-ponton parts.* (a) Parts are more stable and safer to handle.

(b) Parts can be pinned together before either abutment is prepared.

(c) Powerboats have fewer parts to push into place.

(d) It is easier to attach powerboats to two-ponton parts.

(2) *By individual pontoons.* (a) All pinning is done at bridge, eliminating part-assembly site.

(b) Alignment of treadway-connecting-pin holes is easier.

(c) In streams having shoals, rocks, or other obstructions, individual pontoons are easier to propel to bridge.

36. ANCHORAGE OF BRIDGE. a. Methods. (1) The method of anchoring the steel-treadway bridge depends upon current, width of stream, and type of stream bottom. The following methods of anchorage can be used:

(a) Guy lines.

(b) Anchors.

(c) Anchors and guy lines.

(d) Anchor cable and bridle lines, and guy lines.

(2) Table V lists the positions of anchors, guy lines, and bridle lines for

the various methods. Regardless of the method used, short guy lines are used on both sides at each end of the bridge to prevent movement caused by starting or stopping of heavy vehicles.

b. Anchorage by guy lines. Guy lines are $\frac{1}{2}$ -inch wire ropes. They are attached on the shore to deadmen or natural holdfasts, and on the bridge to the lifting-hook eyes of the treadways. Both ends are secured by wire-

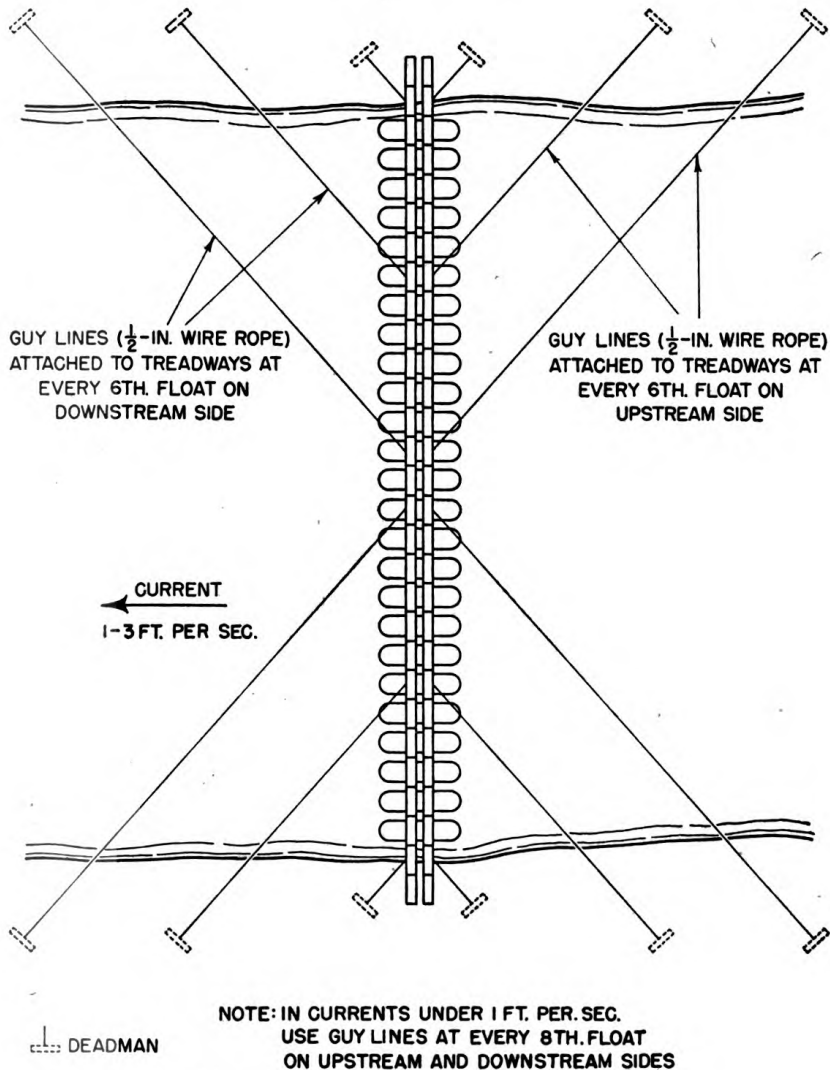

Figure 31. Bridge anchored by guy lines.

rope clips. The lines are tightened with ratchet chain hoists which are removed as soon as the lines are at the proper tension. Guy lines hold the bridge in place during construction as well as after completion. They can be used alone to anchor bridges in currents less than 3 feet per second, as shown in figure 31. In stronger currents, they are used in conjunction with anchor cables and bridle lines (e below) or anchors (d below).

c. Anchorage by anchors. Bridges may be anchored by anchors

alone as shown in figure 32. This method of anchorage should not be used in currents over 3 feet per second. Anchor lines can be attached to either of the following:

(1) *Rope halter of float.* A bowline on a bight is tied on the anchor line about 15 feet from the thimble of the rope halter and the line is threaded through the thimble and back through the bight. Then the free end is brought back to the treadway for lashing as shown in figure 35. The anchor

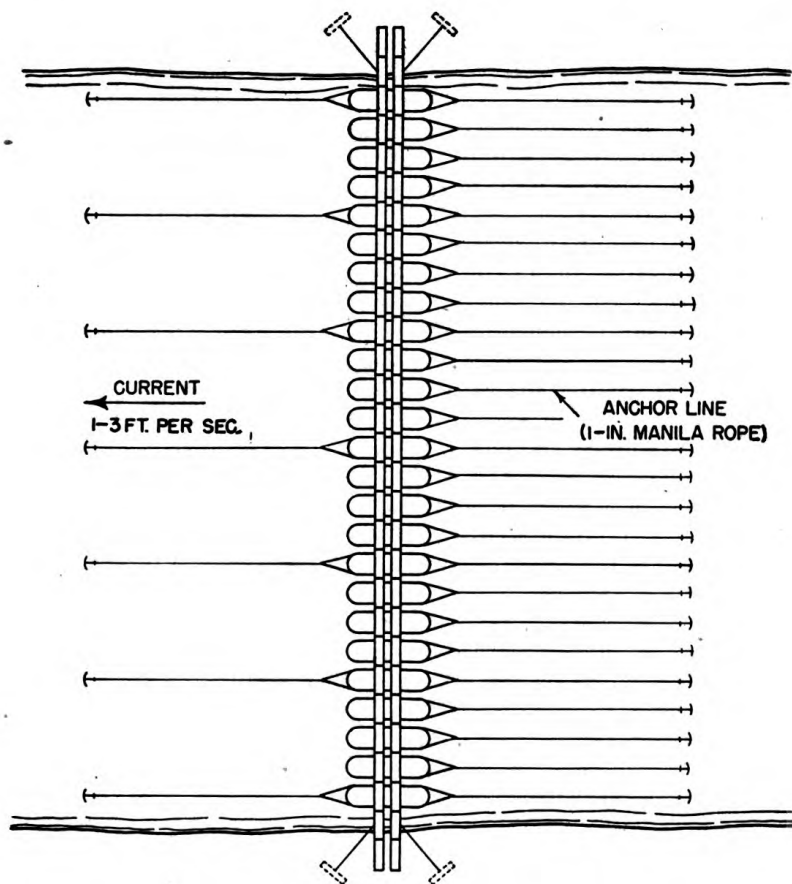

NOTE: IN CURRENTS UNDER 1 FT. PER SEC.
USE ANCHOR LINES ON EVERY OTHER
FLOAT ON UPSTREAM SIDE AND ON
EVERY 4TH. FLOAT ON DOWNSTREAM
SIDE

DEADMAN

Figure 32. Bridge anchored by anchors.

line must pay off from the top of the coil of rope as the anchor is dropped. Ropes must not be fastened to the saddle as a strong pull tends to submerge the float and pull the saddle apart.

(2) *Lifting-hook eye of treadway.* The anchor is placed so the rope will pass between two floats and hence not chafe the float or tend to submerge it. The anchor rope is passed under the upstream treadway through a hook

eye on the upstream side of the downstream treadway and tied to a hook eye on the downstream side of the upstream treadway as shown in figure 36.

d. Anchorage by anchors and guy lines. This method of anchorage is shown in figure 33. Anchors are attached as described in c (1) or (2) above, and guy lines as described in b above.

e. Anchorage by anchor cables, bridle lines, and guy lines. This method of anchorage is shown in figure 34. Anchor cables are $\frac{5}{8}$ -inch wire

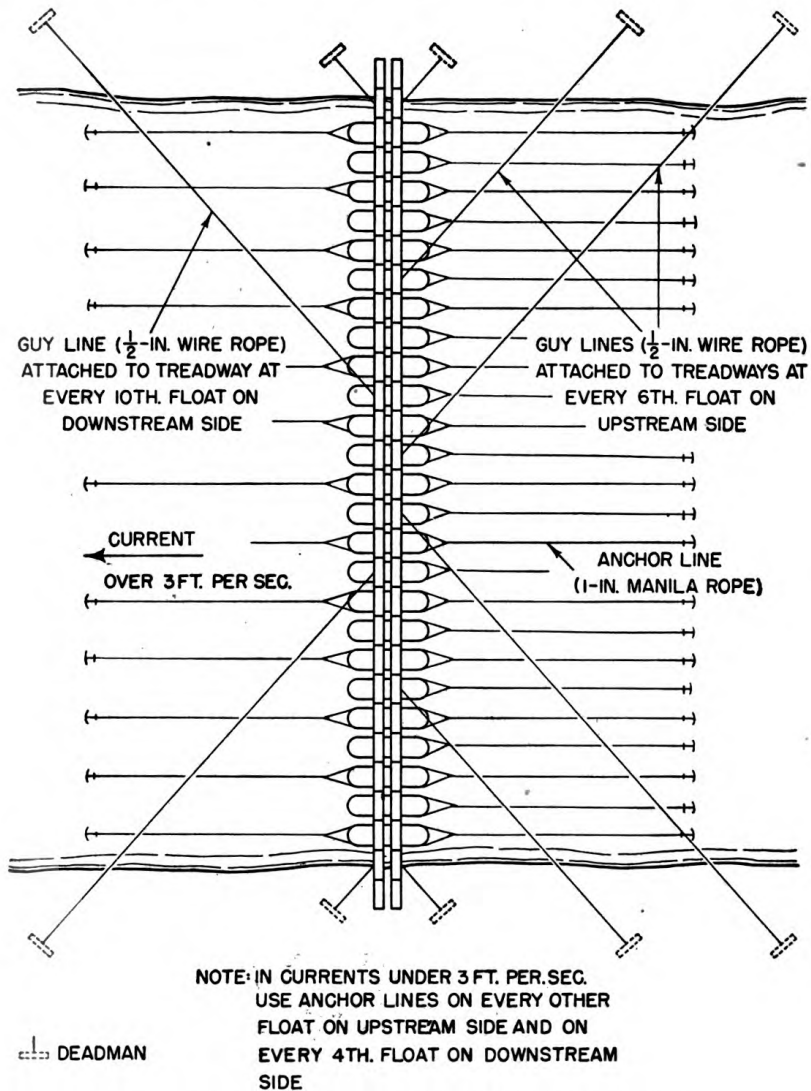

Figure 33. Bridge anchored by anchors and guy lines.

ropes extended from one shore to the other and fastened to deadmen or natural holdfasts 50 feet upstream and downstream from the center line of the bridge. Bridle lines are $\frac{3}{4}$ -inch manila rope 80 feet long with a harness snap at one end. The snap is fastened to the anchor cable and the other end of the line is tied to the rope halter of the floats. Guy lines are attached as described in b above,

37. SHORE CONNECTIONS. a. General. (1) The traffic capacity of a bridge cannot be greater than its approaches. Often it takes as long to build approaches as it does to build the bridge. Abutments must be solidly constructed to withstand the impact and weight of the heaviest vehicles, and erosion by rainfall or stream action. Abutment sills must be

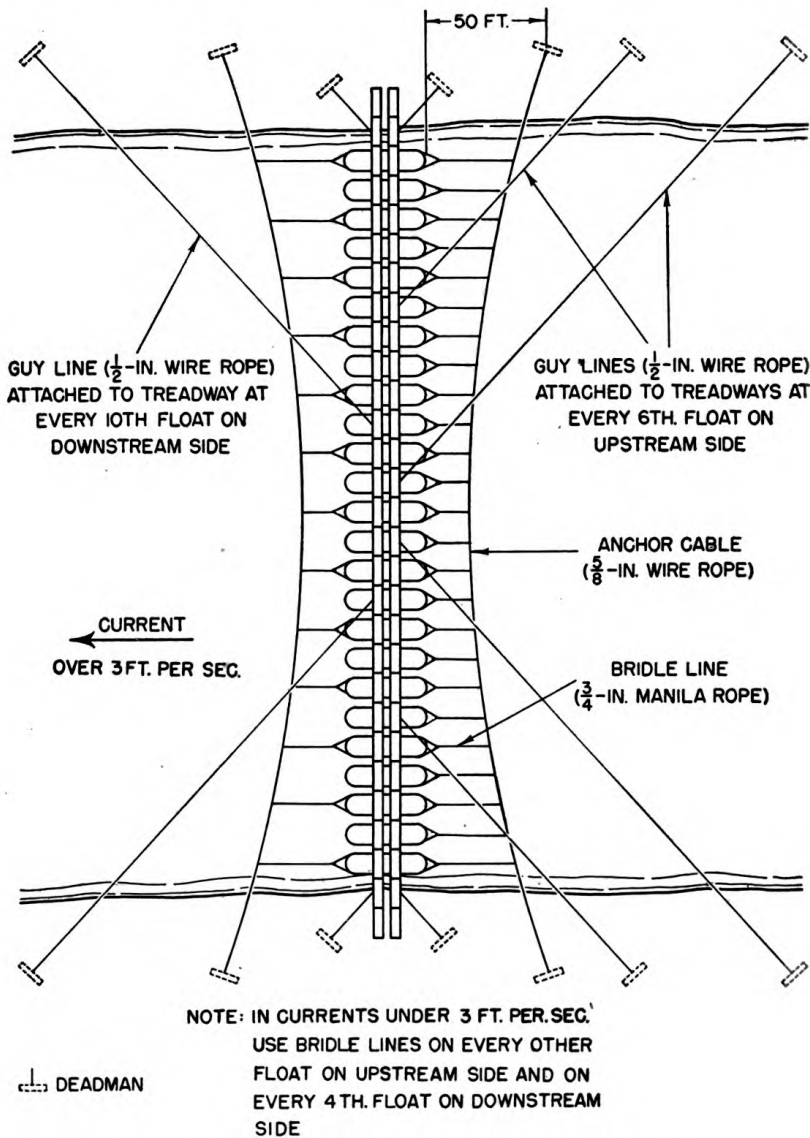

Figure 34. Bridge anchored by bridle lines and guy lines.

used at both ends of the bridge. Any available dressed lumber built up to a sufficient height, or rough lumber adzed on its upper surface, may be used. However, the sill must consist of at least 6- by 8-inch by 12-foot lumber, and it must support both treadways. Sills are firmly fastened by pickets and protected by riprap against the possibility of wave action wearing away the soil on the banks.

Table V. Methods of anchorage

Figure No.	Method	Current (fps)	Anchors		Guy lines		Bridle lines	
			Upstream	Downstream	Upstream	Downstream	Upstream	Downstream
31	Guy lines ¹	0-1 1-3	One every eighth float. One every sixth float.	One every eighth float. One every sixth float.
33	Anchors and guy lines	0-3 Over 3	One every second float. One every float.	One every fourth float. One every second float.		
							34	Bridle lines and guy lines.

¹ These methods are unsafe in currents over 3 feet per second.

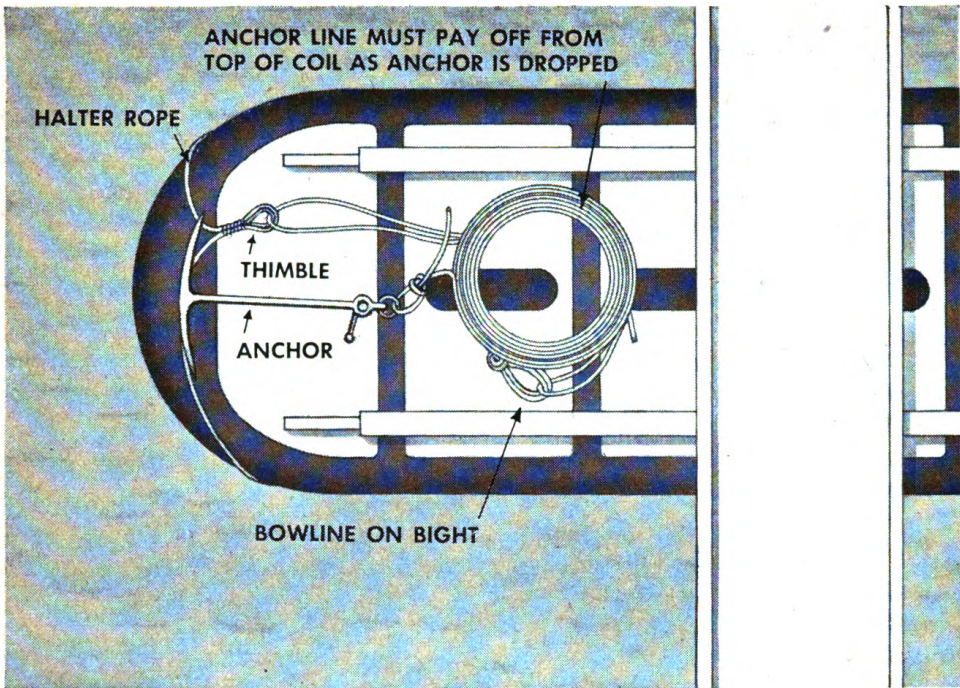

① Before casting.

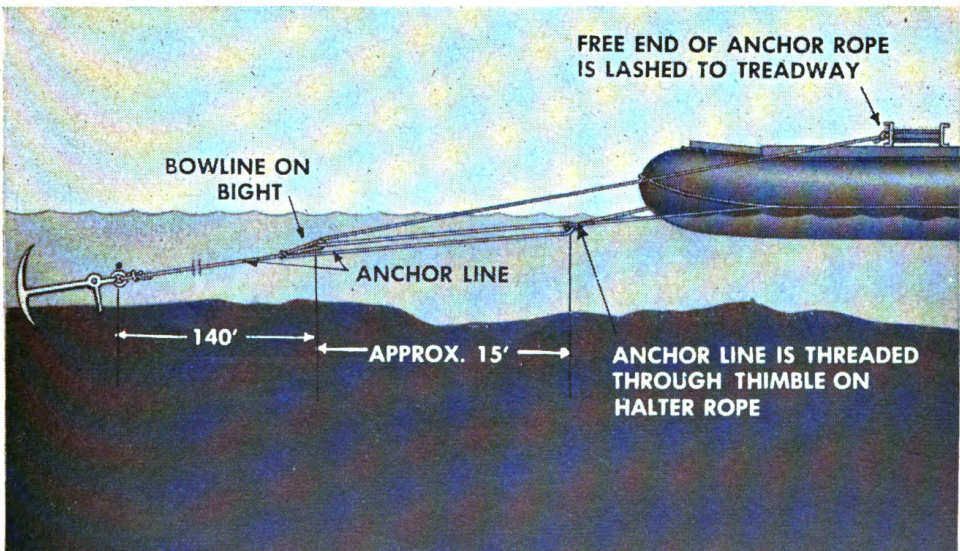

② After casting.

Figure 35. Anchor line tied to rope halter.

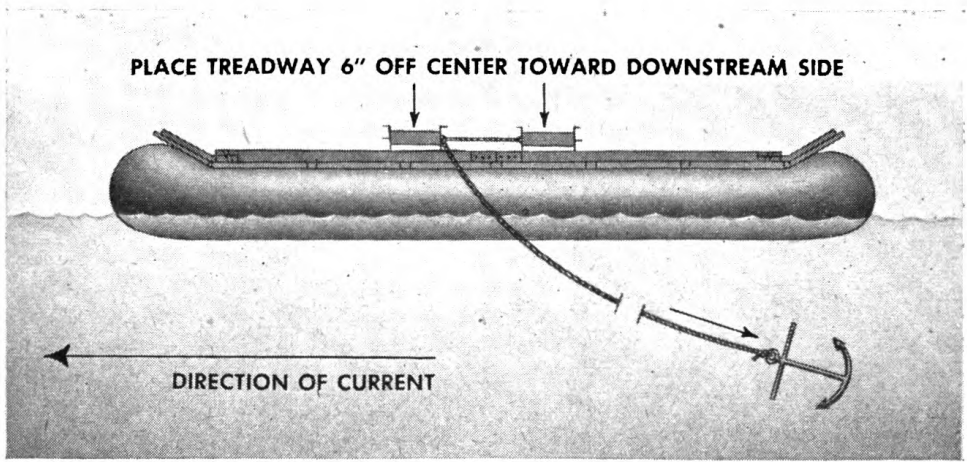

① Elevation.

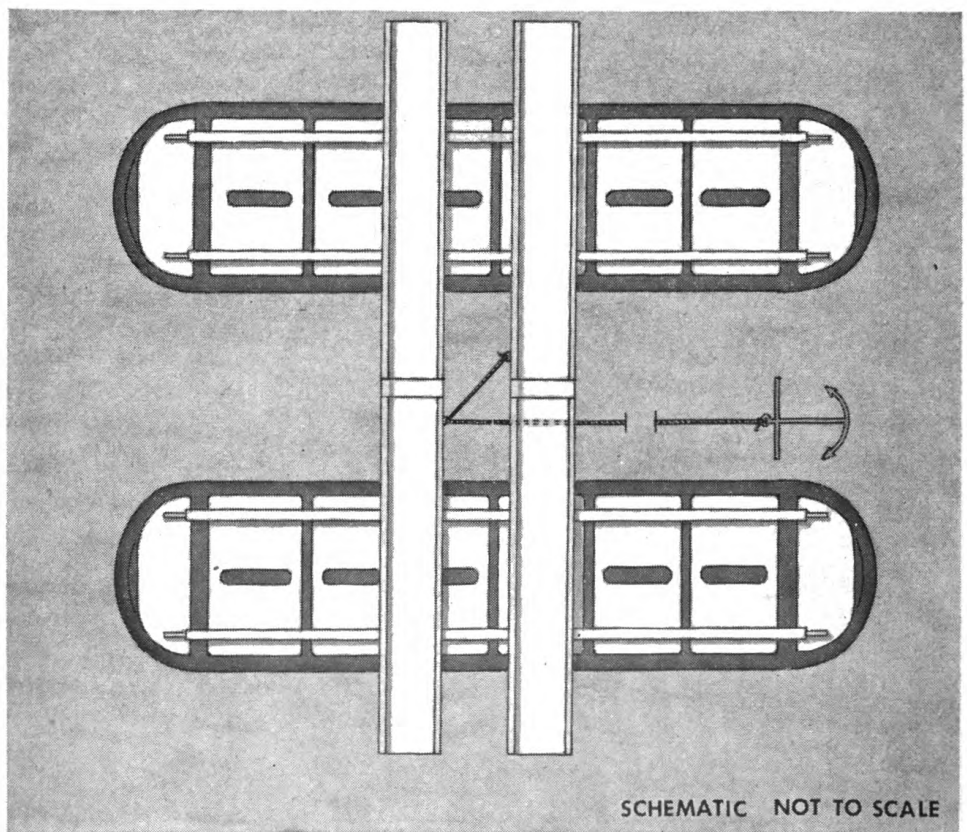

② Plan.

Figure 36. Anchor line tied to treadway.

(2) A straight level approach is desirable for all bridges. If the site offers no such approach usually one can be prepared with a dozer. One or two pairs of treadways pinned with hinge connections should be used on the ground at the ends of the bridges, particularly at the end of the bridge toward which traffic is moving. Pending the development of a steel traffic guide, a timber guide as shown in figure 45 should be used as an aid to vehicle drivers. It consists of lengths of large timber, 6- by 12-inch when available, on their sides, staked down, braced together, and partly buried in the ground.

(3) After approach treadways have been positioned treadway wedges are placed by hand and pinned to the end treadways. Blunt-end wedges are connected with two treadway-connecting pins, and hook-end wedges with one pin.

(4) To resist torque caused by vehicle wheels or treads not centered on the treadways, the following precautions must be taken at each end of the bridge:

(a) Place a timber or steel beam across and underneath both treadways at the midpoint of the unsupported treadway span. Securely lash or clamp both sides of each treadway to this cross beam.

(b) Place a timber sill on the ground across and underneath the ends of the approach treadways.

(5) Where bridges are built at sites subject to a falling water level one of the following must be done:

(a) If the depth of water at the bank is not prohibitive, the bridge must be built with trestles as shore connections. As the water level falls the heights of transoms are adjusted downward.

(b) If the depth of water at the bank is too deep for trestles the bridge must be built without them and when the water level drops, the shoreward floats must be removed and trestles substituted in their places.

(6) Where bridges are built at sites subject to a rise of water level one of the following must be done:

(a) If the rise is insufficient to cover the abutment sill, trestles should be used as shown in figure 38.

(b) If the rise is such that the abutment sill will be inundated, it must be moved back and additional floating spans placed between the old shoreward float and the new sill.

b. Without trestles. (1) Shore connections without trestles should be used whenever possible. The abutment sill is placed so its top is 18 inches above the water level. Approach treadways are laid on the bank and connected to the bridge. A hinge connection (one pin) is always used (fig. 37).

(2) The wave action caused by vehicles crossing the bridge tends to damage abutments and to ground floats. The following protective measures must be taken:

(a) To protect the abutment, place rocks, timbers, landing-mat panels, or sandbags between the abutment sill and the shoreward float.

(b) Wherever possible, avoid grounding of floats by removing them and substituting a ford or extending the approach road using timbers, earth, or sandbags.

(c) Where it is not practicable to remove grounded floats, they may be protected by double rows of piles across both ends of the riverward grounded float. Each double row of piles starts in the space between the first grounded float and the adjacent floating float, and extends diagonally outward and shoreward for approximately 15 feet. The piles should be 3- to 6-inch logs driven at 8- to 12-inch centers and tied together to prevent spreading. The

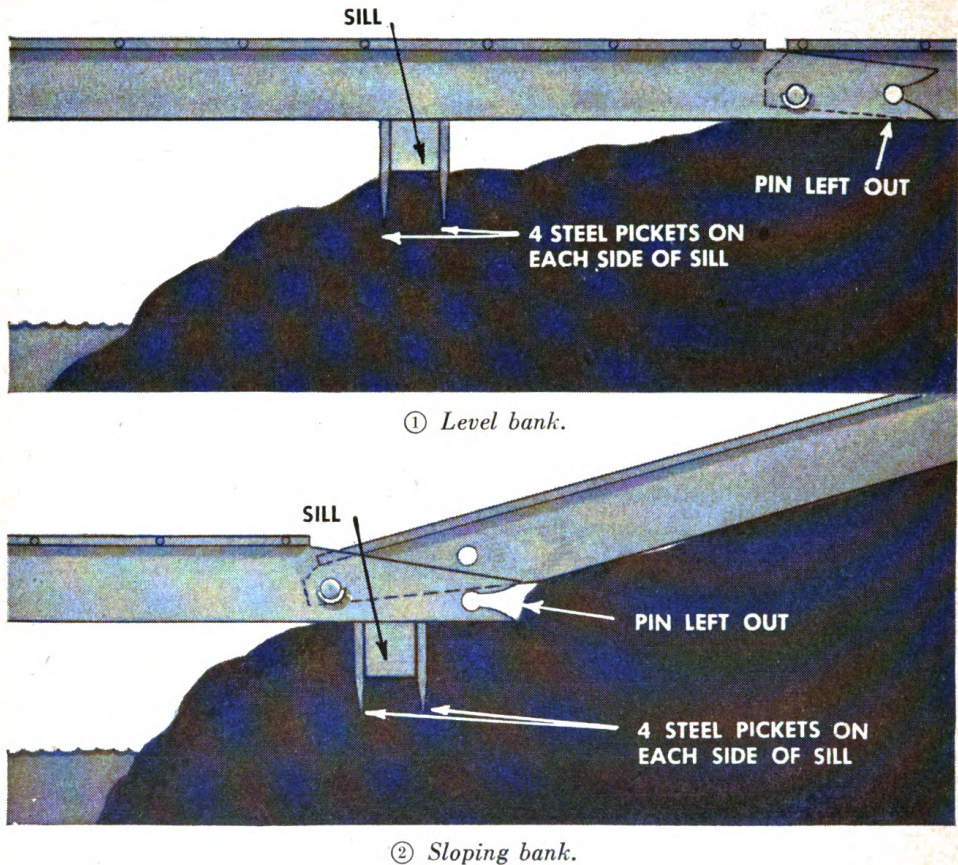

Figure 37. Shore connections without trestles.

space between rows is filled with brush or rocks. Shore guy lines are attached to the grounded floats to hold them in position.

c. With trestles. Any number of trestles, placed as described in paragraph 40, can be used at either end of the bridge as a shore connection (fig. 38). Treadway connections are made directly over transoms rather than between them. The connections always should be hinged because settling of trestles under load tends to overstress the treadways.

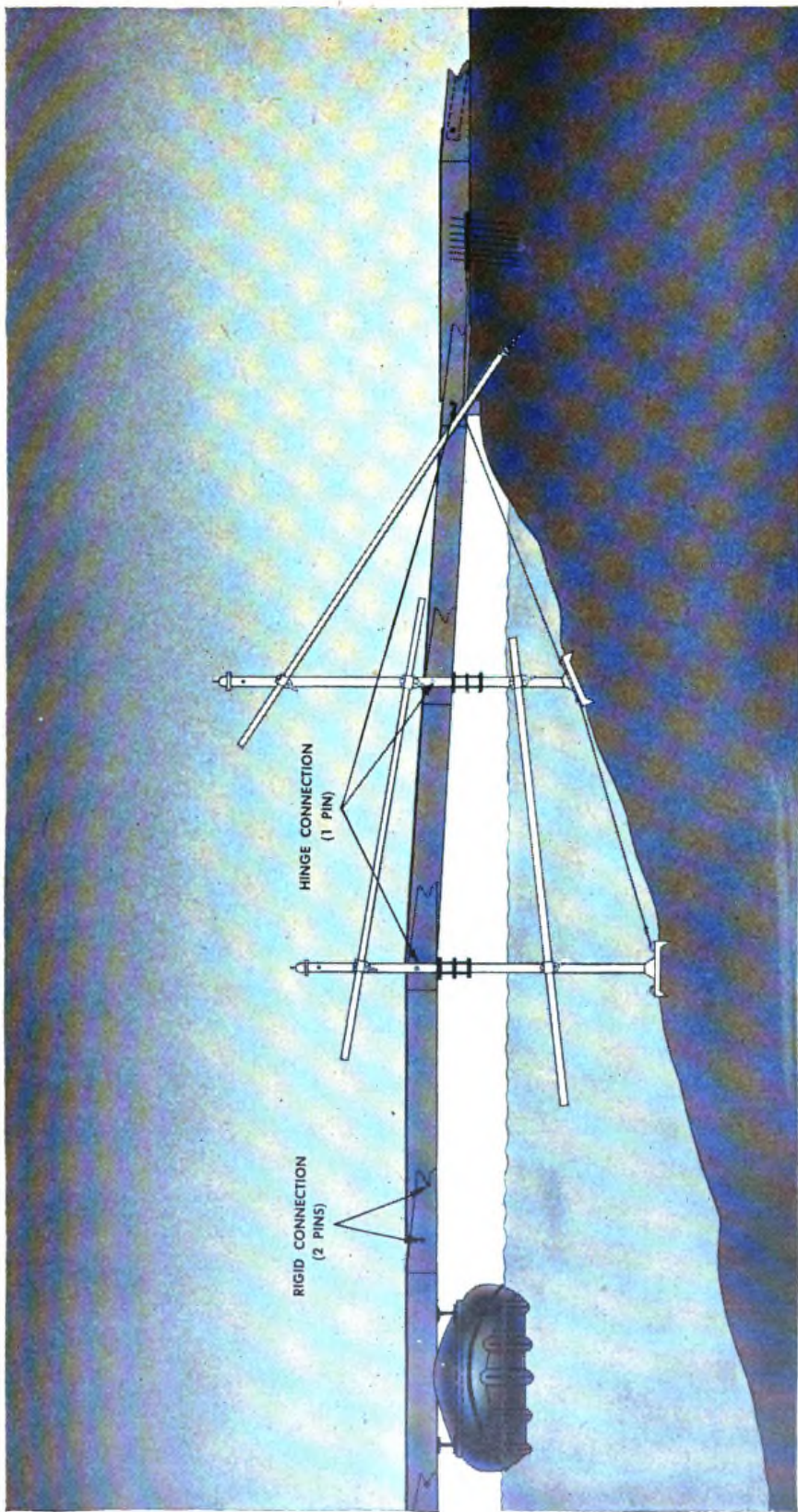

Figure 38. Shore connection with trestles.

38. ALINEMENT OF BRIDGE. A range pole or similar marker on each shore aids greatly in maintaining bridge alinement during construction. The officer in charge of construction should check the alinement at intervals during construction and see that it is maintained. Adjustments are made by shortening or lengthening guy and anchor lines. After construction is completed final adjustments are made and lines are tightened and secured.

39. DISMANTLING BRIDGE. a. The procedure for dismantling the bridge is the reverse of that for constructing it. Anchors are picked up and guy lines loosened but not untied until the part to which they are attached is removed from the bridge. Floating parts of size convenient to handle are moved to the part-assembly sites. The parts are disassembled into single pontoons and moved to the treadway-placing sites. Here the treadways are removed from the pontoons and loaded into the treadway trucks. The pontoons then are moved to the float-preparation and launching sites. The saddles are removed and either stacked or loaded directly on a treadway truck.

b. The floats are removed from the water, deflated, rolled, and packed into the carrying cases. The cases with the floats inside, treadway pins, spacing hooks, anchors, and anchor ropes then are loaded onto a treadway truck containing treadways and saddles.

40. USE OF TRESTLE EQUIPMENT. a. Trestles are used to bridge dry gaps or wet gaps where steep banks require excessive approach construction, or where the water is not deep enough to float pneumatic pontoons and the stream cannot be forded. They are also used to provide shore connections for a floating bridge where a change in water level is anticipated (see par. 58). For capacities of bridges built with trestles see table I. Shore connections are made as shown in figure 38.

b. (1) The trestles may be erected by hand or with the truck crane or treadway truck. Treadways are placed by the treadway truck. Treadway wedges are placed by hand as described in paragraph 37a (3).

(2) When the truck crane or treadway truck is used, the crane or truck is placed on the near-shore abutment. Then a trestle is erected and the gap between the abutment and the trestle bridged with treadways. Either one or two pairs of treadways may be used to bridge this gap or that between trestles. With the truck crane or treadway truck standing on the completed portion the bridge is extended until the far shore is reached.

c. To dismantle the bridge, the treadways are removed and the trestles picked up. Work can start from either shore.

41. EXPEDIENT USE OF EQUIPMENT. a. **General.** Steel treadways may be used in single pairs; or, pairs can be joined rigidly end to end to strengthen existing bridges, to bridge blown culverts, or to cross narrow streams or ditches. Table I gives the capacity of such bridges.

b. Strengthening existing bridges. Treadways can be placed directly upon the deck of an existing bridge (fig. 39) to strengthen it for the passage of a convoy. The treadways are removed from the truck and laid out on the ground. Then the spacing hooks are inserted and the treadway truck picks up the treadways in pairs (fig. 23②). Next the truck backs up to the bridge and lowers the treadways into position. Finally treadway wedges are placed at each end of the treadways. Traffic then may cross. If wedges are not available, earth is shoveled and tamped at the ends to form a temporary ramp. After all vehicles have passed, the treadway truck crosses, picks up and loads the treadways, and joins the convoy.

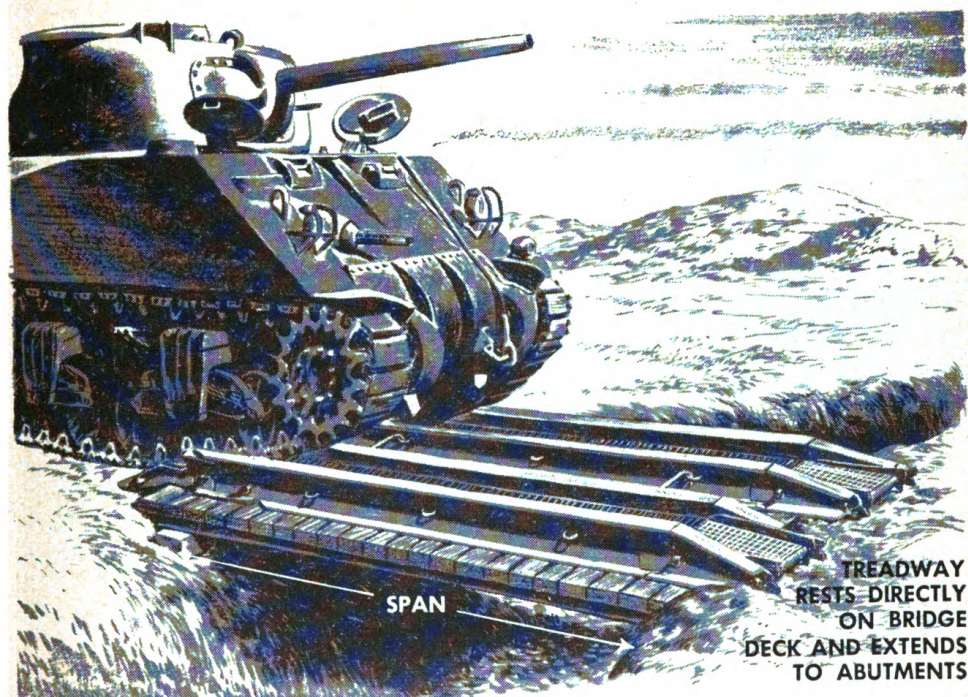

Figure 39. An existing bridge strengthened by treadways.

c. Narrow gaps. Either wet or dry narrow gaps can be bridged with one or two pairs of treadways (fig. 40). First the treadways are placed on the ground. If only one pair is used, they are lifted simultaneously and placed over the gap. If more are used, the treadways are connected rigidly together and then lifted and placed over the gap; the process is repeated for the other track.

d. Blown culverts. The convoy can cross demolished small culverts by bridging them with one or two pair of treadways connected together.

e. Ramps. Treadways also may be used as ramps for loading or unloading vehicles from flat cars. The treadways are spaced to accommodate the vehicle, chocked to prevent slipping, and the end of the flat car is blocked. The vehicles then are run directly down the treadways.

42. USE OF DRAWSPAN. To make an opening in the steel-treadway bridge for the passage of river traffic, a drawspan can be effected in the following manner: a single pneumatic ponton is disconnected and removed. A part of the bridge of the desired size of the drawspan then is disconnected. A vehicle is backed up on the part of the bridge that has the hook ends of the treadways toward the part which has been disconnected. The vehicle depresses the bridge, and men standing on the opposite end of the part can tilt it enough so it can be removed. Any additional section then comes loose easily. Four guy lines, one from each corner of the part, aid in guiding the part during its removal. To reassemble the bridge, the gap is closed until only one part remains to be added. The part then is installed by reversing the procedure described above.

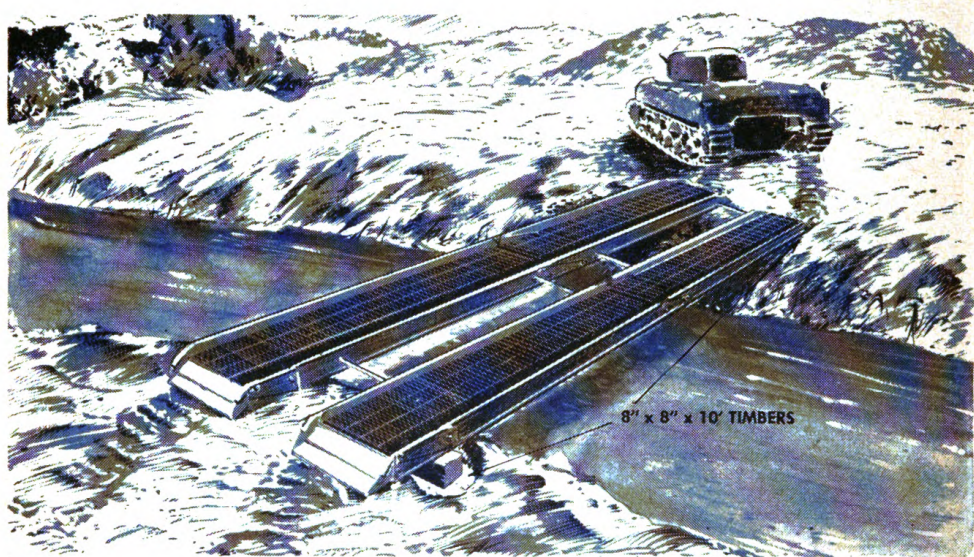

Figure 40. Narrow stream bridged by treadways.

SECTION VII

RAFTS

43. FERRY SET. a. General. The M2 treadway ferry set No. 2 is used to ferry medium tanks and other heavy vehicles when equipment of the steel-treadway bridge is not available. It is transported in three 6-ton treadway trucks. One set is issued to the headquarters company of the armored engineer battalion.

b. Composition. The ferry set includes six floats and saddles, twelve treadways, one bicycle traveler, two outboard-motor brackets, and tools and accessories. Outboard motors are issued separately. The composition of the set is given in table VI.

44. CONSTRUCTION OF RAFTS. a. Size. M2 steel-treadway rafts are constructed of four pneumatic pontoons and five pairs of steel treadways (fig. 41) with 3 feet between pontoons and with a 9-foot overhang of treadways at each end. If less than a 9-foot overhang is required, four pairs of treadways are used with lesser spacing of pontoons.

Table VI. M2 treadway ferry set No. 2

Item	Quantity
Anchor, kedge, 100-lb.	2
Ax, chopping, single-bit, handled, 4-lb.	2
Bag, canvas, paddle, 9-paddle-capacity	3
Block, snatch, steel-shell, iron-sheave, for 7/8-in. manila rope, 7-in.-shell	2
Bracket, stern-attachment, 22-hp. outboard motor, M1, pneu- matic-float, 18-ton	2
Chest, miscellaneous bridge parts	1
Clip, wire-rope, steel-galvanized, 1/2-in.	40
Fitting, alemite-zerk, elbow, 45°	6
Float, pneumatic, 18-ton, complete with emergency kit and carrying case	6
Grip, cable, 1/2-in. wire rope	3
Hoist, chain, ratchet, 1 1/2- to 3-ton, two hoists in chest with spare parts	2
Holdfast, complete with 9 pickets	4
Hook, spacing, treadway	12
Manifold, inflation and deflation, pneumatic float, complete with 4 lengths of 12-foot hose and spares	2

Table VI. M2 treadway ferry set No. 2—Continued

Item	Quantity
Paddle, boat, single-blade, 5 feet long, single	27
Pin, treadway, steel	3
Repair equipment, set No. 3, pneumatic-float, general	1
Rope, manila, 3-strand medium-laid, coils, $\frac{3}{4}$ -in. feet	600
Rope, manila, 1-in., 200-foot lengths	4
Rope, wire, steel-cast, galvanized, fiber-core, regular-lay, 6- x 19-stranding, $\frac{1}{2}$ -in. feet	600
Saddle, steel-treadway, knockdown, M1 (pneumatic-float 18-ton)	6
Sheaves, traveler, cable, steel-cast, $\frac{1}{2}$ -in., 8-in. dia	2
Sledge, blacksmith's, double-face, handled, 8-lb	2
Treadway, steel, complete with 2 pins, 1-beam-lok open type flooring, M1, 45 $\frac{1}{2}$ -in., 12-ft	12
Traveler, bicycle, complete	1
Wedge, treadway:	
Blunt-end	2
Hook-end	2
Wrench, adjustable, crescent type, single-end, 1 $\frac{1}{8}$ -in. opening, 10 inches long	3

b. Procedure. The raft is built as follows:

(1) Pneumatic pontoons are assembled as described in paragraph 33 **b, c,** and **d.**

(2) One ponton is positioned parallel to shore.

(3) Two pairs of treadways are connected longitudinally on shore and placed one track at a time on ponton by a treadway truck so riverward ends overhang 9 feet. Shoreward ends of treadways should be held steady to keep float balanced.

(4) Third pair of treadways, supported by treadway truck, is connected to shoreward ends of treadways already in place and raft is pushed riverward.

(5) Second ponton is inserted beneath shoreward ends of treadways, parallel to first ponton, and shoreward treadways are lowered upon it.

(6) Fourth pair of treadways is connected as in (4) above and raft is pushed riverward.

(7) A third ponton is inserted as in (5) above.

(8) Fifth pair of treadways is connected as in (4) above and raft is pushed riverward.

(9) Fourth ponton is inserted as in (5) above.

(10) Treadway wedges are placed with hinge connections. Lashings are tied to ends of wedges to allow them to be raised while raft is crossing stream and lowered as it approaches ferry site.

45. CAPACITY. The four-ponton five-treadway raft can carry a medium tank (fig. 41).



① Raft in midstream.
Figure 41. Medium tank on four-ponton steel-treadway raft.

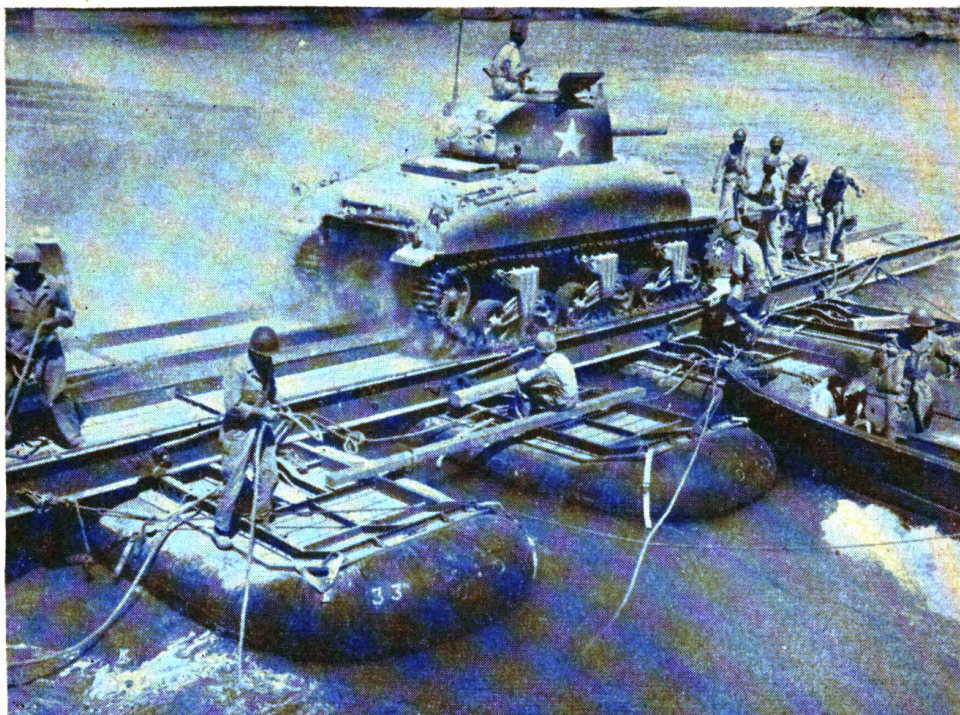

② Raft being loaded.

Figure 41. Medium tank on four-ponton steel-treadway raft—Continued

46. FERRY SITES. a. Ferry sites should have the following characteristics:

- (1) Easy access on both shores to roads over which vehicles may move to and away from raft.
- (2) Cover and concealment on near shore for vehicles waiting to be ferried.
- (3) Water close to bank deep enough to float a loaded raft with an overhanging deck without grounding. Lacking such a prepared site a shelf approach is prepared with a dozer. Site should permit at least 3 feet of the overhanging deck to rest on shore.
- (4) A site from 5 to 6 feet wider than raft deck.

b. To reduce ferrying time far- and near-shore sites should be opposite one another. If this is not possible the unloading site should be downstream from the loading site.

c. Generally only two rafts are used at one site where the river is less than 500 feet wide. On wider streams three rafts can be used effectively without interference.

47. FERRY PARTY. The most important considerations in ferrying are the proper preparation of loading and unloading sites and assignment of specific duties to personnel. The ferry party consists of 16 men under the direction of an officer or noncommissioned officer. Its organization is given in table VII.

Table VII. Organization of ferry party

Men	Duties
1	Officer or noncommissioned officer in charge.
4	One man per guy line. Men ride raft and, as raft lands, leap to shore and secure guy lines.
2	Place and remove chocks, which are used as a safety measure and expedite loading by marking limit for forward travel of vehicle.
2	Raise and lower treadway wedges.
2	Operate powerboat.
2	Shore crew—one on each shore to guide vehicles on and off raft.

48. RIGGING ARRANGEMENT. Figure 42 shows the arrangement of the powerboat and guy lines. This method has the advantages of—

- a. Eliminating possibility of fouling any lines.
- b. Speeding operations of raft by having one set of guy lines for each shore.

49. LOADING AND UNLOADING RAFTS. The following must be observed in loading and unloading:

- a. Guy ropes are secured firmly. Man handling guy line wraps it three times around holdfast and holds free end to prevent its slipping.
- b. Vehicles move on and off the raft at slow speed. Those having all-wheel drive use it.
- c. Rafts carry anchors, lashings, boathooks, and paddles for use in an emergency.
- d. On loaded raft sufficient space is left to allow vehicles to move forward at near shore and backward at far shore, thus permitting shoreward ends of treadways to lift and clear shore.

50. METHODS OF PROPULSION. Steel-treadway rafts can be propelled by any of the following methods:

- a. Powerboats (fig. 42).
- b. Outboard motors.
- c. Trail ferry with bicycle traveler (see TM 5-271) in combination with outboard motors (fig. 43) or powerboat.

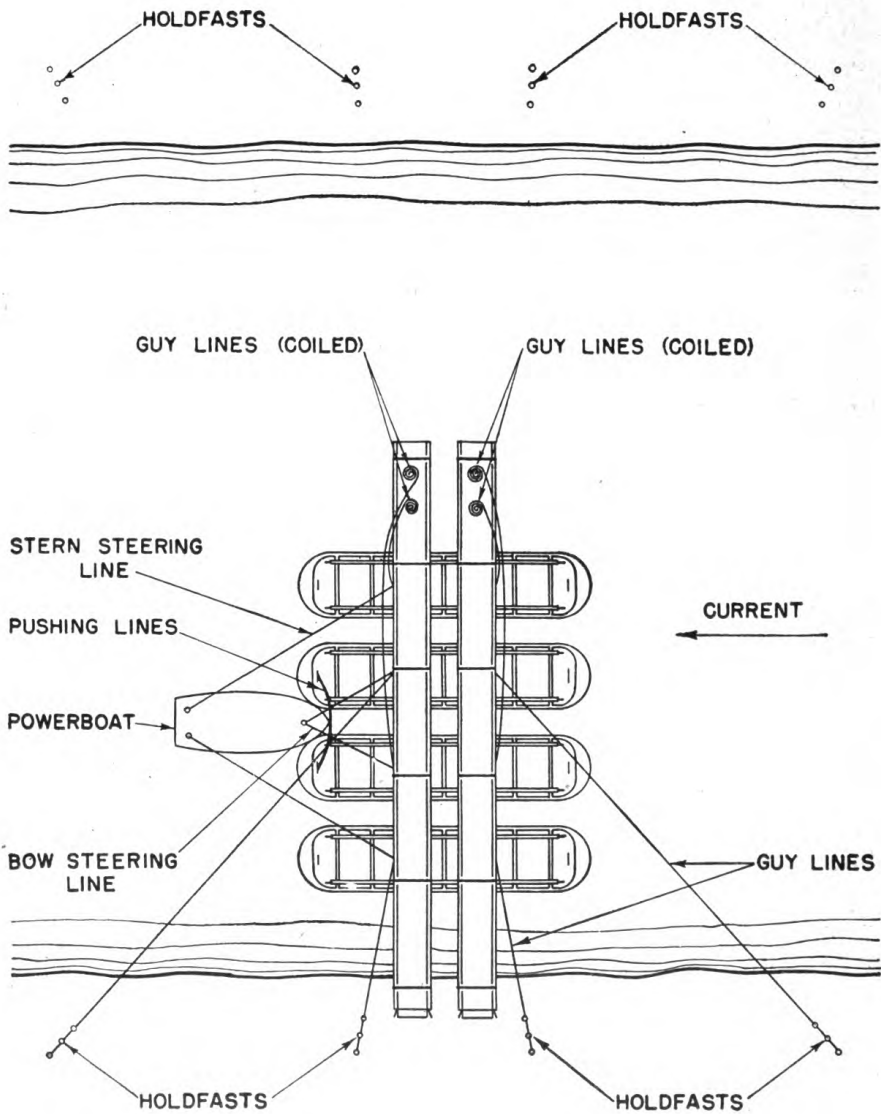

Figure 42. Arrangement of rigging for rafts.

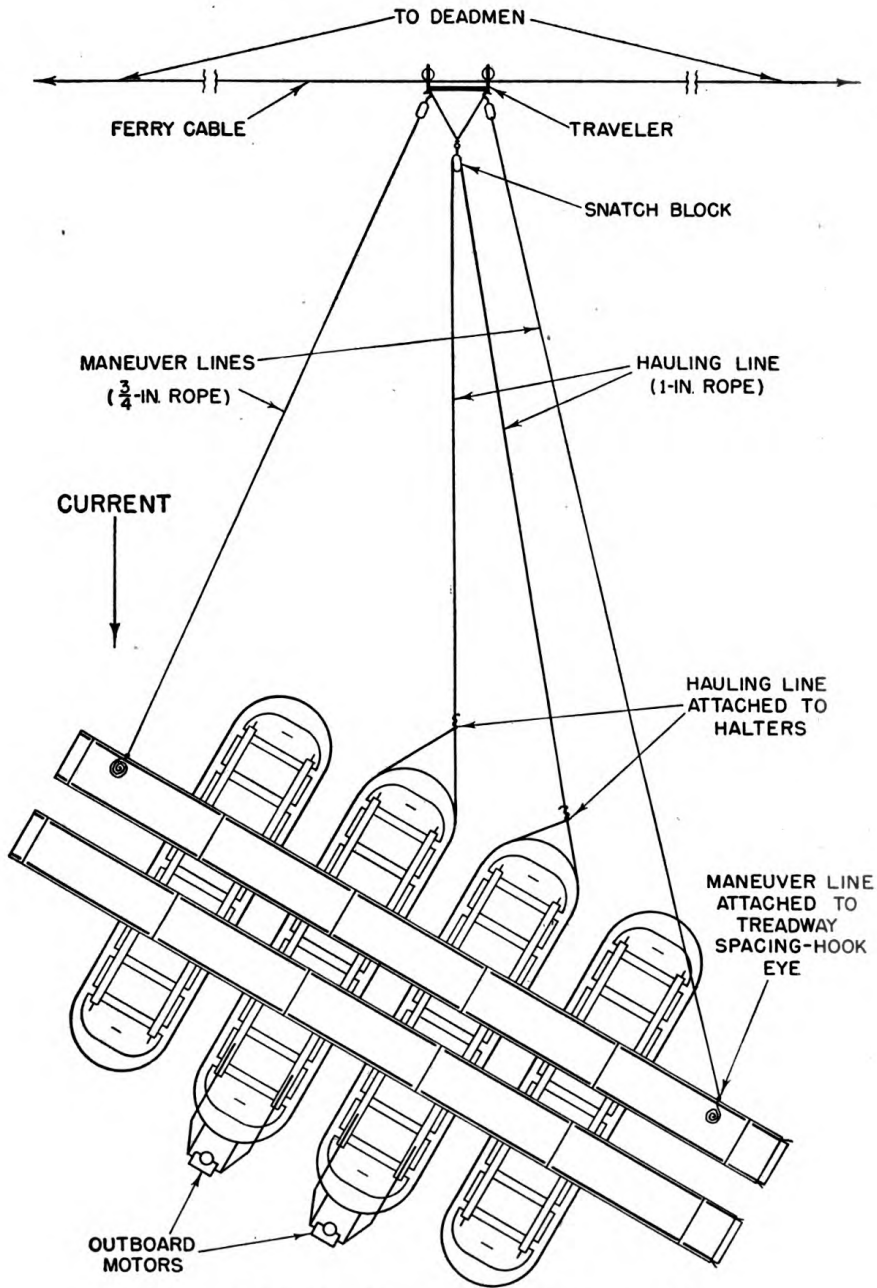

Figure 43. Steel-treadway raft rigged as a trail ferry.

SECTION VIII

TRAFFIC CONTROL AND MAINTENANCE OF BRIDGE

51. BRIDGE GUARD. A bridge guard must be stationed at the bridge at all times. Its size depends upon the length of the bridge and the amount of traffic crossing it. Its duties are to control traffic (par. 52) and maintain the bridge (par. 54).

52. TRAFFIC CONTROL. Rigid traffic control is essential at all times. Drivers must be instructed not to change gears while crossing the bridge. Vehicles, particularly medium tanks, should maintain a constant speed and cross at intervals of 30 yards. A vehicle halted on the bridge must be chocked immediately. Guards must be stationed at each end of the bridge, and at intervals on long bridges. The guards on the near shore regulate traffic so vehicles reach the bridge at the proper speed, are properly spaced, and do not close up on the bridge if one of them is stalled. The guards on the far shore keep vehicles from slowing down or stopping on leaving the bridge.

53. TRAFFIC CAPACITY. The traffic capacity of the bridge in vehicles per hour for uninterrupted flow in one direction is as follows:

<i>Drivers</i>	<i>Daylight</i>	<i>Blackout</i>
Experienced.....	350	150
Inexperienced	200	100

This traffic capacity is possible with *maximum* allowable speeds of vehicles as follows:

<i>Vehicles</i>	<i>Daylight</i>	<i>Blackout</i>
Medium tanks	8 mph	5 mph
Lighter vehicles	12 mph	5 mph

Unforeseen difficulties as in traffic tie-up on the approaches, particularly on the far shore, and in maintenance of the bridge may reduce this capacity.

54. MAINTENANCE OF BRIDGE. a. To maintain the bridge the guard must—

- (1) Pay particular attention to insuring that a pressure of 2 psi is maintained in the float.
- (2) Inspect treadway-connecting pins frequently to insure they do not work out of the bridge.

- (3) Inspect treadway retainers on saddles to insure they are in place.
 - (4) Inspect anchor cables, bridles, and anchor and guy lines to insure against their becoming loose.
 - (5) Catch debris before it hits the bridge; remove that which is not caught, to prevent punctured floats.
 - (6) Inspect abutments to see that excessive undercutting, by surging of water or shifting due to vehicle impact, does not occur.
 - (7) Place blackout markers properly.
- b. The following equipment should be available for the use of the bridge guard:

- Extra pneumatic pontoons.
- Portable air compressor with manifold.
- Hammers.
- Boards for abutments.
- Treadway truck.
- Crowbars.
- Double blocks.
- Pickets.
- Powerboat.
- Rope.
- Shovels.
- Sledge.

55. BLACKOUT DELINEATION. The blackout markers provided with the bridge set are not visible from the air; they should be used whenever the bridge is used during blackout. They are a visual aid to drivers of vehicles and permit traffic to move steadily. They may be arranged on the bridge and at the approaches in many different ways, their position varying with the type of approach, the length of the bridge, and the light in the sky. Figure 44 shows a suggested method of placing the radioactive luminous markers on the treadways. Figure 45 gives a suggested arrangement for delineating the approach to a bridge with blackout markers.

56. PROTECTION AGAINST AIR ATTACK. Pneumatic ponton bridges are extremely vulnerable to air attack and must be protected against strafing as well as possible. Smoke screens, barrage balloons, and anti-aircraft machine guns can be employed effectively for this purpose. The bridge is most vulnerable when strafed along its axis; hence, active defenses should be placed to command the possible approaches in this direction. Smoke screens should conceal the bridge effectively and yet not be so thick as to hinder traffic on it. When possible, completely assembled pneumatic pontoons should be concealed along the river banks to replace those damaged by strafing or bombing. In replacing a damaged pneumatic ponton first the damaged ponton is disconnected from the treadway. If necessary, air is al-

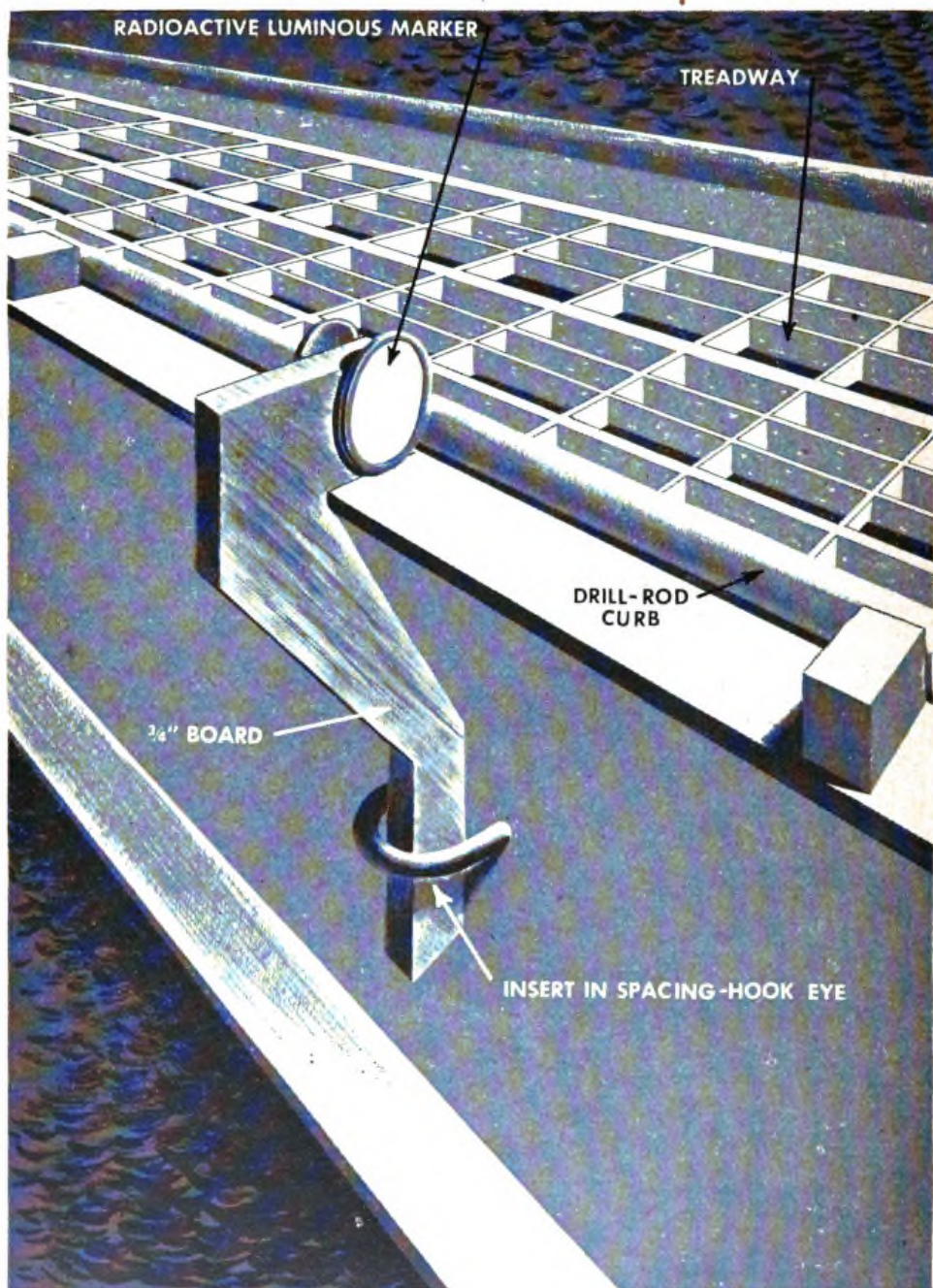

Figure 44. Method of attaching radioactive luminous marker on treadway.

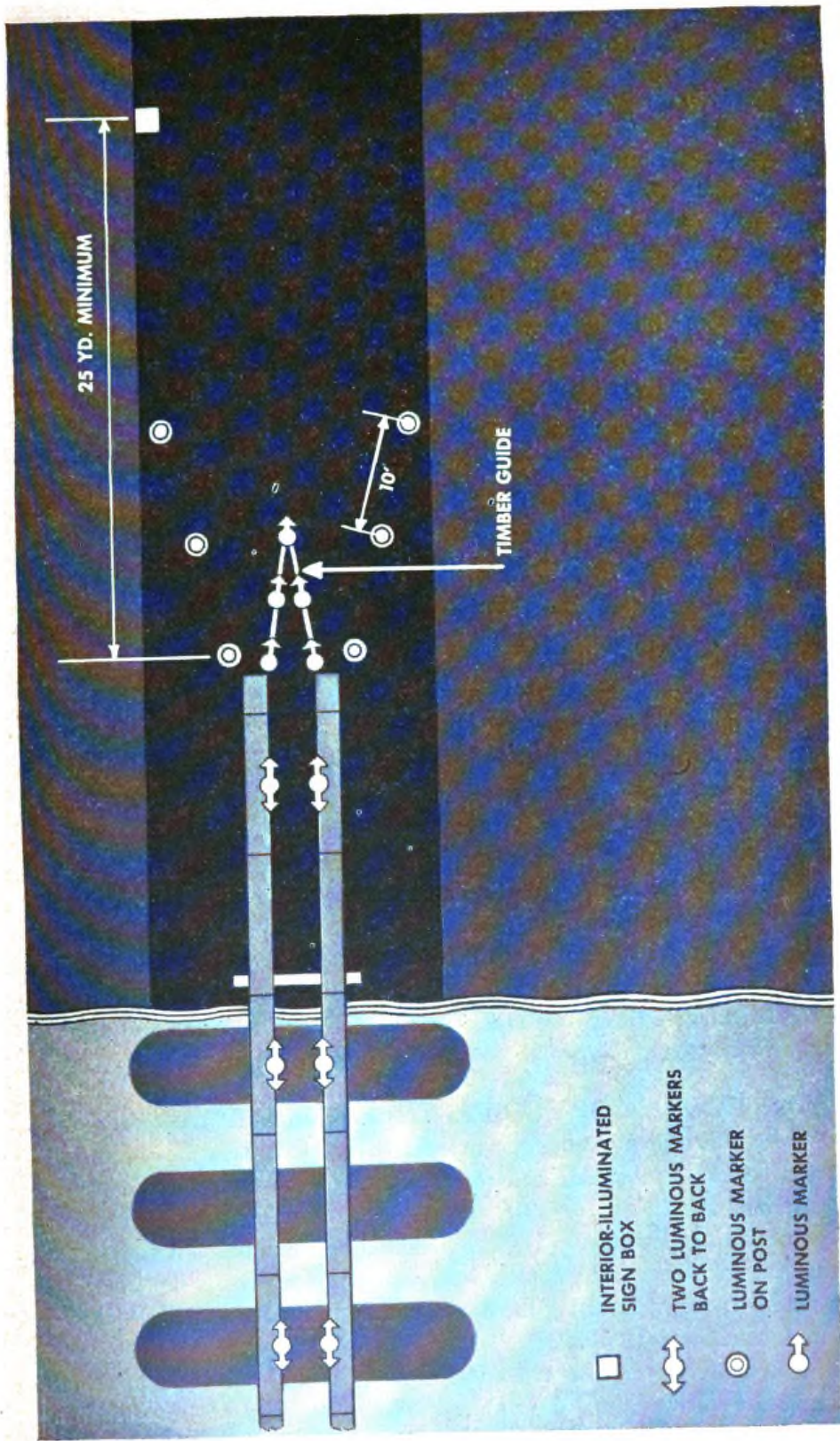

Figure 45. Arrangement for delineating approach to bridge with blackout markers.

lowed to escape and the ponton is moved out from the bridge. The new ponton is partially deflated, inserted under the treadway, and inflated in place.

57. PROTECTION AGAINST DEBRIS. When a bridge is menaced by floating debris, a boom consisting of logs, hurricane fence, or chain of assault boats placed upstream may be an effective block in low velocity currents. The boom should be securely anchored across the stream at an acute angle. Debris deflected to the shore should be removed as it accumulates. This may be done by men on the shore or in patrol boats. In fast flood currents where a boom is not practicable or is ineffective, debris must be passed beneath the bridge by working it between floats or, when necessary, by removing floats. Traffic must be restricted temporarily to pass such debris. Floating debris must not be allowed to accumulate against the bridge. The amount of debris in a stream usually increases with a rise in water level. In extreme floods, the debris menace usually necessitates opening a gap in the bridge or withdrawing it to avoid total destruction.

58. PRECAUTIONS DURING FLOODS. As a stream rises its velocity increases causing a decrease in the bridge load capacity, and an increase in the lateral forces tending to wash the bridge downstream. Vigilant inspection is necessary so that appropriate precautions may be taken and adjustments made as required. Periodic readings of a staff gauge should be recorded to show stream behavior. As a stream rises and its velocity increases, it is necessary to restrict loads permitted on the bridge, adjust the shore connections, strengthen holdfasts, and tighten guy lines and anchor cables. Anchor lines must be adjusted with ratchet chain hoists or block and tackle, not by hand. Where bridges are held only by anchors and the stream velocity becomes critical for them, supplementary guy lines, anchor cables and bridle lines, or both should be used. (See figs. 33 and 34.) In flood velocities where there is danger of losing the bridge, it should be closed to traffic, and in some cases individual floats removed to relieve pressure on the bridge. In extreme cases, one end of the bridge may be freed and allowed to swing downstream.

59. MAINTENANCE OF EQUIPAGE. **a. General.** All parts of the steel-treadway bridge equipment, particularly the pneumatic floats, must be inspected carefully, cleaned, and repaired before the equipment is stored after extended use.

b. Pneumatic floats. (1) The pneumatic-float repair kit contains all the materials required and complete instructions for repairing floats. Small leaks can be found by inflating the floats, coating the outside with thick soap suds, and watching for bubbles.

(2) Since rubber articles are affected by heat and sunlight, pneumatic floats must be stored in cool dark places. When necessary to store them on the beach for short periods the floats should be dried out as much as possible.

Since mildew will attack moist cotton duck readily, the floats should be supported by treadways or trestle parts. Pneumatic floats should be carried and stored in their carrying cases. They must never be rolled into the carrying case until they have dried out completely.

c. Steel parts. The steel parts of the bridge are rugged and strong but must be handled with care. Struts, shoes, hoists, holdfasts, and tools should be used only for the purposes intended. The protective paint covering must be maintained to prevent rust. Paint should be renewed whenever inspection indicates the need, and any exposure of steel by chipping, scaling, or disintegration of the paint should be corrected at once by applying a rust-preventive priming coat and a second coat of paint. Slight bends in trestles, treadway-engaging plates, grating, and ramp wedges may be straightened in the field. Repairs other than these generally require shop facilities.

d. Saddle straps. The saddle straps (par. 7b) and buckles of the pneumatic floats have a tendency to break and wear out. They should be replaced by lengths of $\frac{5}{8}$ -inch rope spliced to the D-rings on the sides of the floats. The ropes attached to the outside D-rings should be 5 feet long after splicing and those holding down the center tube 6 feet long. To obtain a strong splice each of the three ends of the rope is passed three times under the strands. The end of the rope is whipped with a strand about $1\frac{1}{2}$ feet long which has been unravelled from another rope. If $\frac{5}{8}$ -inch rope is not available use $\frac{1}{2}$ -inch rope.



