



Accessible bus stop design guidance

Bus Priority Team technical advice note BP1/06
January 2006

Accessible bus stop design guidance

Further information

For further details or advice on the design of accessible bus stops, contact:

Bus Priority Team

Transport for London
Windsor House, 42-50 Victoria Street
London, SW1H 0TL
Tel 0845 300 7000

Website: www.tfl.gov.uk

Contents

1. Introduction.....	2
2. Fully accessible bus services.....	4
3. Bus stop locations.....	9
4. Passenger waiting area.....	15
5. Bus stop area.....	23
6. Bus stop layouts.....	24
7. Bus boarders.....	31
8. Bus bays.....	39
9. Kerb profiles and heights.....	43
10. Implementing bus stop improvements.....	46
11. Longer term issues.....	49
12. Bibliography.....	50

List of figures

Figure 1: Features of the bus stop environment.....	3
Figure 2: Passenger groups benefiting from low floor buses.....	4
Figure 3: Bus stop layout objectives.....	6
Figure 4: Relationships between bus and kerb.....	7
Figure 5: Considerations for bus stop locations.....	9
Figure 6: Bus arrival patterns.....	11
Figure 7: Bus stop location in vicinity of traffic signals fitted with SVD.....	13
Figure 8: Boarding and alighting zones.....	17
Figure 9: Boarding and alighting zones – Alternative shelter arrangement.....	18
Figure 10: Passenger waiting area critical dimensions.....	19
Figure 11: Kerbside stop with parking on approach and exit.....	26
Figure 12: Exit side of pedestrian crossing.....	27
Figure 13: Exit side of junction.....	28
Figure 14: Full width boarder.....	32
Figure 15: Alternative full width boarder layouts.....	33
Figure 16: Multiple bus full width boarders.....	34
Figure 17: Half width boarder.....	37
Figure 18: Angled boarders.....	38
Figure 19: Bus bay arrangements.....	41
Figure 20: Amendment to existing bus bay.....	42
Figure 21: ‘Special’ kerbs.....	45
Figure 22: Flow chart of potential tasks for improving bus stops.....	47
Figure 23: Gantt chart of standard tasks for improving bus stops.....	48
Figure 24: Bus dimensions.....	52

Appendices

Appendix A: Bus measurements.....	51
Appendix B: Effects of introducing bus boarders.....	54
Appendix C: Effects of removing bus lay-bys.....	56
Appendix D: ‘Special’ kerbs.....	58
Appendix E: Worked examples.....	59

Accessible bus stop design guidance

1. Introduction

This guide updates the 'Bus Stop Layouts for Low Floor Bus Accessibility' published in June 2000 and its predecessor documents. It also incorporates advice developed for the introduction of articulated buses, published by Transport for London (TfL) in April 2002. These updated guidelines have been developed in the context of the Government's policies on integrated transport, the Mayor's Transport Strategy, and the Disability Discrimination Act 1995.

It is intended that this guide will assist highway authorities in the development of practical and affordable measures to improve accessibility at bus stops. The measures should be compatible with the particular characteristics of buses deployed on London's road network.



The introduction of low floor buses throughout London, fitted with ramps for wheelchair users, has led to a requirement for appropriate kerbside access at bus stops. Unless all stops along a bus route are equally accessible, passengers may be unable to board or alight a bus at their desired location and the potential benefits from low floor buses will be reduced. This hinders the development of an inclusive public transport system.

Bus stop design and location is recognised as a crucial element in the drive to improve the quality of bus services. The concept of 'Total Journey Quality' recognises that bus passengers are also pedestrians at each end of the bus trip and requires that all aspects of the journey are considered. The convenience and comfort of bus stops must not be overlooked.

It is important to view the bus stop as an interchange, rather than simply a location along a bus route where buses stop, comprising only a post with a flag, and a cage laid on the road surface.

The bus stop environment contains a number of features that need to be considered, as illustrated in Figure 1.

A fully accessible bus service is a critical element in delivering a fully inclusive society. Bus stops are a vital link in this vision. TfL wishes to highlight this, and part of the rationale in revising the bus stop design guidelines is to reiterate the wider issues relating to equality and inclusion. Furthermore, it should be remembered that kerbside controls and bus boarders are merely tools – the objective is to ensure that the bus stop is fully accessible.

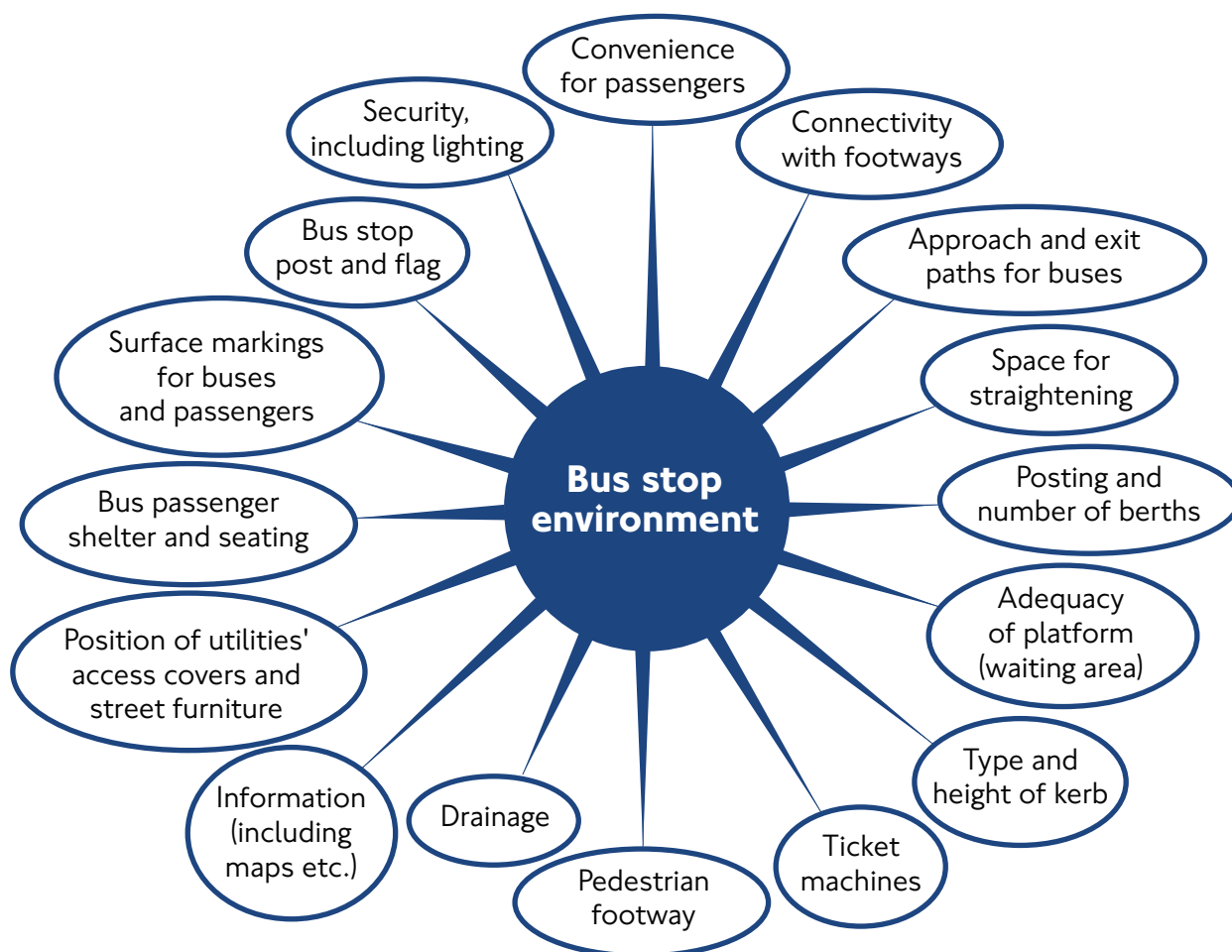

Figure 1: Features of the bus stop environment

Additionally, it is important to emphasise the need for:

- training for bus drivers on how to approach and correctly use the bus stop;
- planners and engineers to optimise the location, design and construction of bus stops; and
- motorists and enforcement authorities to recognise the necessity for bus stops to be kept clear of parked vehicles.

discussed within this guide. Whilst these guidelines provide assistance with the decision making process, it should be recognised that each site is a unique location, with different characteristics to be taken into account.

When reviewing individual bus stops, and their immediate environs, designers need to take account of the wide range of issues that are

2. Fully accessible bus services

Low floor bus users

Low floor buses reduce the height differential between the kerb and bus floor. Whilst they are generally seen as a means of improving accessibility for passengers with disabilities, including wheelchair users, all passengers benefit from low floor bus services, as illustrated in Figure 2.

Research conducted by Transport Research Laboratory (TRL Report 271) has shown that passengers with pushchairs benefit greatly from the introduction of low floor buses. Thus, when designing bus stops for low floor bus access, the needs of all passengers should be considered, not just wheelchair users.



Features of London's bus services

The entire TfL bus network is now operated using low floor vehicles, which have a single step entry, a low floor in the front part of the vehicle, and either a sloping gangway, or step towards the rear, over the drive axle. Generally, they have front doors for boarding passengers and centre doors for those alighting.



Figure 2: Passenger groups benefiting from low floor buses

Powered ramps are usually fitted at the centre door where wheelchair users may board and alight. Push buttons are provided for wheelchair users to alert the driver when the ramp needs to be deployed. Additionally, low floor buses are provided with the means of lowering, or 'kneeling' the bus suspension to reduce the step height at stops.

In London, there are a number of bus configurations in operation, which need to be considered. Flexibility should be provided in designs in recognition that bus types using a stop may change as a result of service changes. For example, articulated bus operation has been introduced on several high volume services and passengers are able to board and alight through all three sets of doors.



The images below show typical bus configurations currently operating on London's roads. Appendix A provides details and dimensions of the 'standard' rigid and articulated buses used to develop the layouts in this document.



Midi bus



Single deck bus



Double deck bus



Articulated bus

Accessible bus stop design guidance

Bus stop layout objectives

The ideal bus stop layout will achieve the objectives shown in Figure 3. The bus should stop parallel to, and as close to the kerb as possible to allow effective use of the bus' facilities. The critical dimensions (see Figure 4.1) to consider are the vertical gap, or step height, from the kerb to the bus floor and the horizontal gap from the kerb edge to the side of the bus. A well designed bus stop will provide features which co-ordinate with the facilities of the low floor bus and minimise these two distances.

The size of the vertical gap between the kerb and floor of the bus will affect the gradient of the ramp when it is deployed (see Figure 4.2). If this gradient is too severe, some wheelchair users may be unable to enter or exit safely from the bus. Regulations under the Disability Discrimination Act 1995 (DDA) require new buses to be capable of deploying a ramp, giving a 1:8 or 12 percent (7 degree gradient), onto a kerb of at least 125mm in height. This regulation, therefore, assumes a 'standard' kerb height of 125mm, which, although not the case universally, is the height that vehicle manufacturers are guided to apply in bus design.

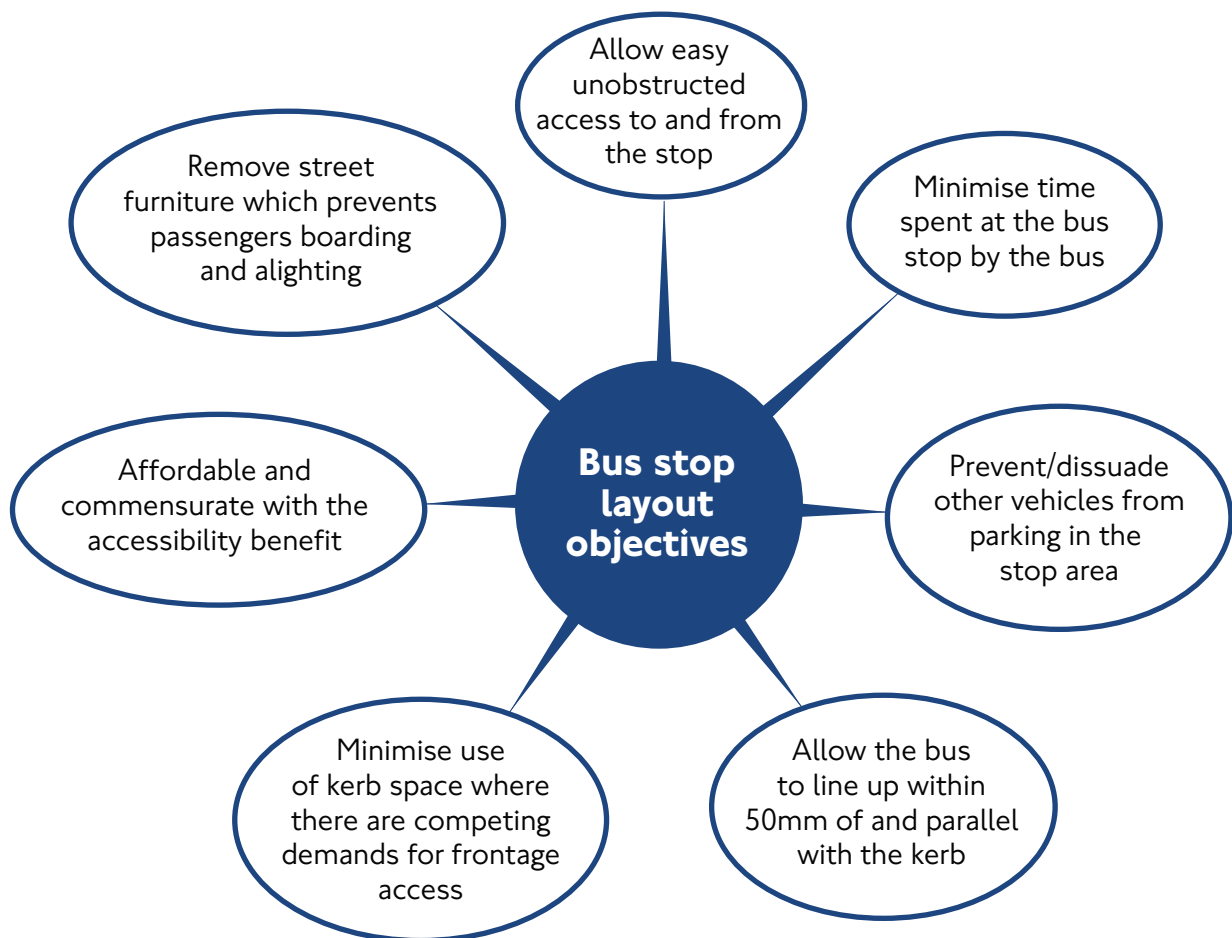

Figure 3: Bus stop layout objectives

Figure 4: Relationships between bus and kerb

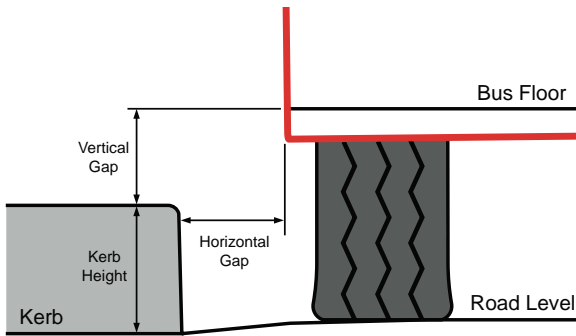

Figure 4.1: Critical dimensions

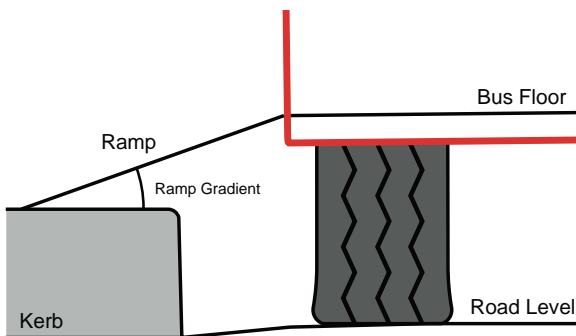

Figure 4.2: Ramp gradient

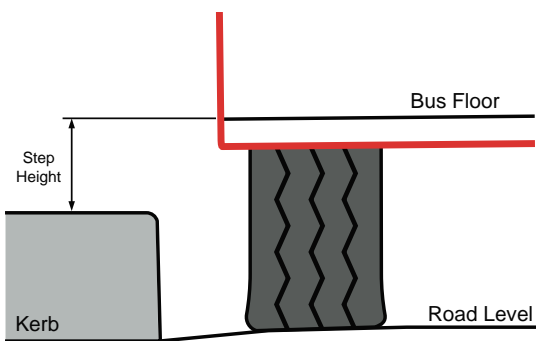

Figure 4.3: Normal step height

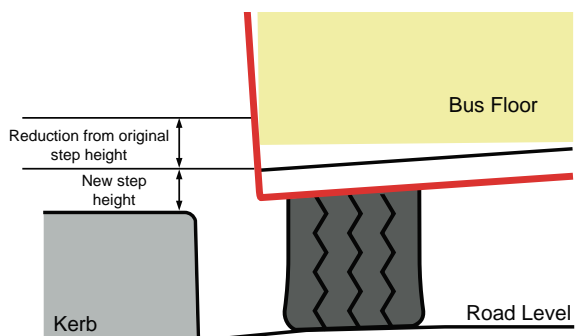

Figure 4.4: 'Kneeling' step height



It is important to recognise that, even when deployed on a 125mm high kerb, the gradient of the ramp may vary. The major determinants include:

- type of ramp;
- ramp length;
- carriageway and footway crossfalls;
- distance of the bus from the kerb;
- 'kneeling' height of the bus floor (see Figures 4.3 & 4.4); and
- whether the bus is laden.

The use of a 140mm maximum kerb height, or higher 'special' kerbs (see Chapter 9), are preferred as they result in lower ramp gradients.

Accessible bus stop design guidance

It should be noted that with the 'kneeling' systems in common use, the reduction in step height achieved is not necessarily uniform along the side of the bus. The front door will be lower than the centre door if the 'kneeling' system operates on the front axle alone. Alternative configurations include tilting of the nearside of the bus and lowering of the entire vehicle.

In the urban environment, there often exists a conflict between the demands for frontage servicing, short term parking and the need to protect a sufficient length of kerb space to allow buses to easily access a stop. As with previous guidelines, this document recognises the competing demands in London's busy street environment and, therefore, retains the previous target benchmark of the bus stopping within 200mm of the kerb.



3. Bus stop locations

Introduction

Bus stops must be located to allow passengers to board and alight safely and conveniently. Ideally, they should also be situated near places of particular need, such as local shops, libraries, clubs, health facilities and sheltered

housing. Stop locations are determined by London Buses in consultation with highway authorities and the police. Residents, local businesses and bus user groups may also need to be consulted by the highway authority and/or London Buses.

Key considerations for bus stop locations are shown in Figure 5.

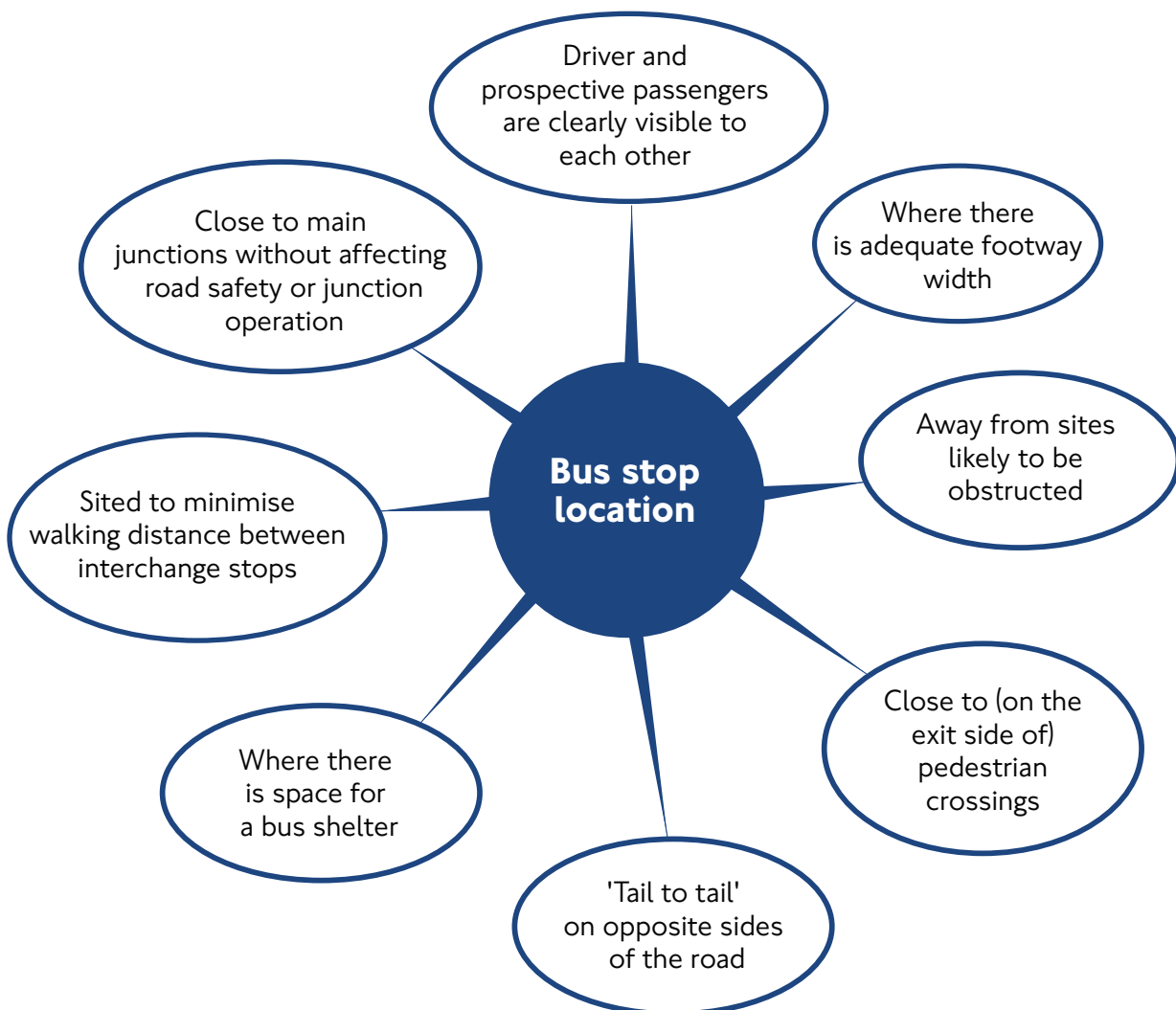

Figure 5: Considerations for bus stop locations

Accessible bus stop design guidance

Consideration should be given to the routes taken by passengers to and from the bus stop. Locating stops near pedestrian crossing facilities, and in particular at junctions, is convenient and helps passengers complete the rest of their journey safely. There is little point in making a bus stop accessible to wheelchairs (and pushchairs) without also considering the accessibility of routes to and from the bus stop.

It may also be necessary to provide additional dropped kerb crossings and/or crossing facilities in the vicinity of the stop as part of any bus stop improvements. Accessibility should be considered in terms of the whole journey.

Stop spacing

An ideal spacing for bus stops is approximately 400m, although a closer spacing in town centres and residential areas may be necessary to meet passenger requirements.

Consideration should be given to improving spacing, and reviewing locations, particularly where interchange is an issue. Bus journey times are affected by the number of stops on

a route and therefore a careful balance must be achieved. If it is proposed to relocate or remove a stop, an assessment of resulting benefits/impacts should be undertaken alongside consultation with stakeholders.

It is recommended that where locations are served by more than 25 buses per hour (bph), bus stops should be split. This enables buses on different routes to serve separate stops, thus reducing bus-on-bus delay and traffic congestion. However, bus routes with common destinations should share the same stop.

Stop capacity

Previous guidelines have highlighted the need to increase cage sizes, but omitted to stress the related impact of high bus frequencies at stops. For example, a 37m kerbside bus stop cage is normally sufficient for a frequency of 15 bph but inadequate for 45 bph, where space should be provided for more than one bus to access and serve the stop at the same time.



Bus stop on a high frequency corridor

The 'clock-face' diagram (see Figure 6) indicates how the frequency of services influences the amount of space required at a stop. Consideration also needs to be given to average boarding/alighting times.

Scenario C shows that, with just 26 buses per hour, the arrival pattern can result in a number of occasions when two or three buses serve the stop at the same time.

Figure 6: Bus arrival patterns

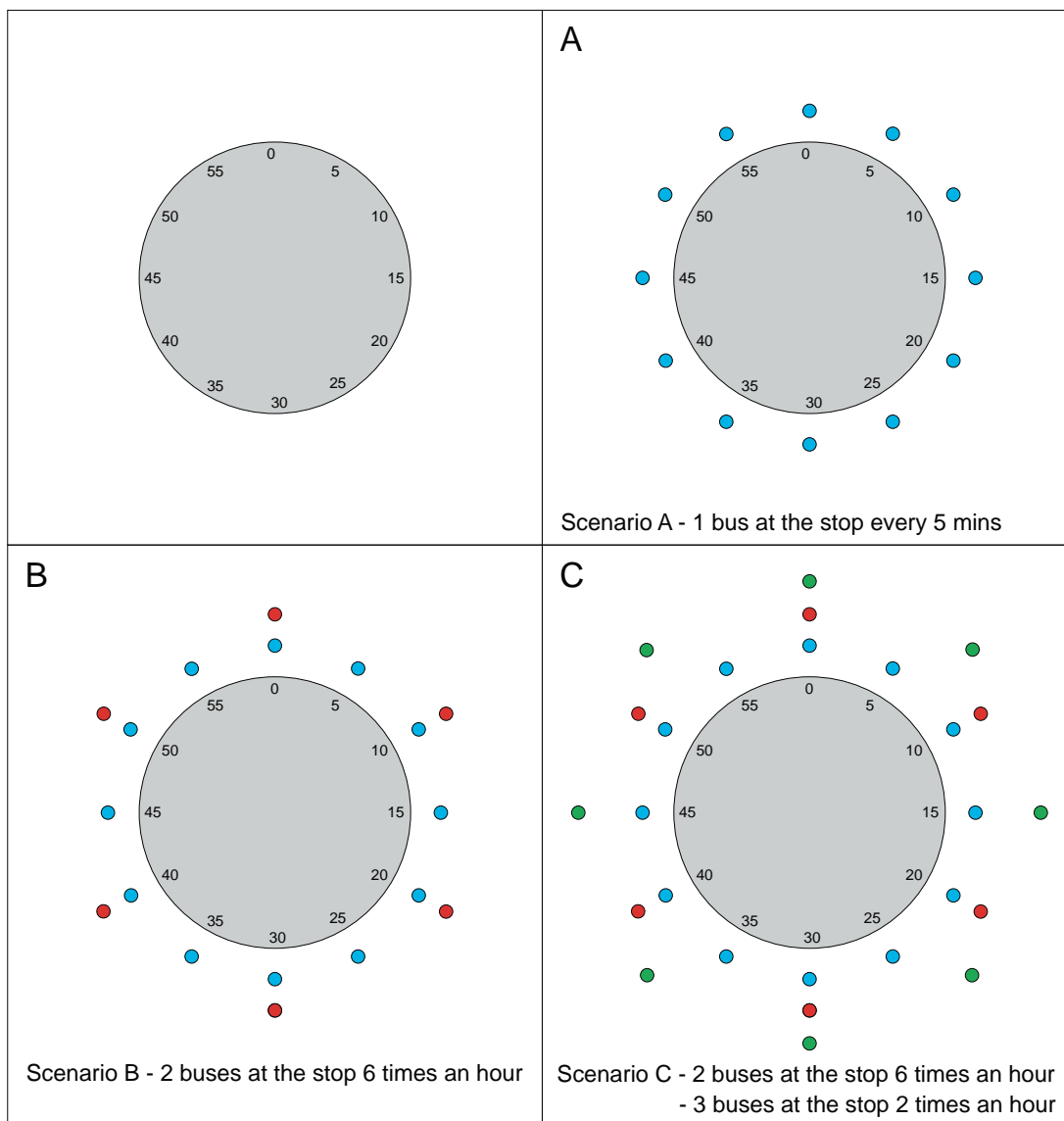

Assume start arrivals is at 12 o'clock

- Service 1 - Bus every 5 minutes (12 bph)
- Service 2 - Bus every 10 minutes (6 bph)
- Service 3 - Bus every 7.5 minutes (8 bph)

Total = 26 bph

Accessible bus stop design guidance

It is recognised that at certain locations the number and frequency of bus services may be particularly high and compromises may have to be made to the length of the cage. At present, approximately 7% of passengers purchase their tickets on bus, and this number is reducing as more people use Oyster pre-pay. The Mayor has indicated a wish to move towards total 'cashless' bus operation and consequently, it is expected that dwell times will reduce, bringing improvements to both bus services and operations.

Bus stops and traffic signals

Where bus stops are located on the approach to traffic signalled junctions, they should not be positioned between a bus priority detector and the stop line. This is to avoid the signal giving

priority to the bus while it is setting down / picking up passengers.

Bus priority detectors are typically placed approximately 80m (or 10-15 seconds bus journey time) in advance of the stop line, whilst passengers often prefer the bus stop to be as close to the junction as possible. Ideally, bus stops should be located on the exit side of junctions, where the effect on saturation flows is generally less than stops sited in advance of signals (see Figure 7).

If there are proposed changes in kerb alignment (e.g. bus boarders) or traffic lanes are to be realigned, existing loops (SCOOT, MOVA or X, Y and Z loops) on the approach to junctions may need to be re-cut or repositioned.



Selective Vehicle Detection (SVD) beacon

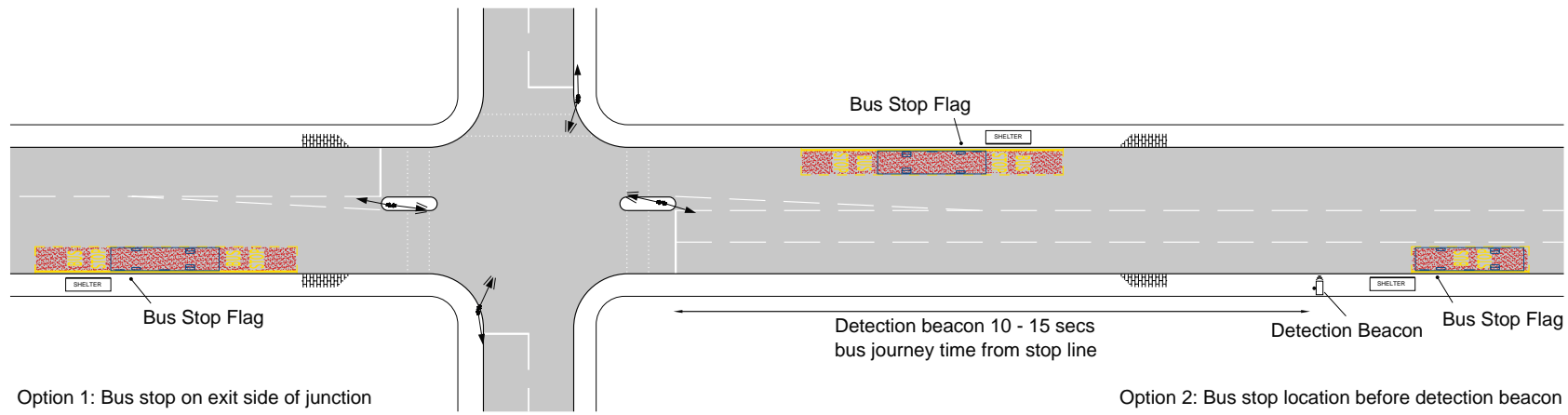

Option 1: Bus stop on exit side of junction

Option 2: Bus stop location before detection beacon

Figure 7: Bus stop location in vicinity of traffic signals fitted with SVD

Accessible bus stop design guidance

'Hail & Ride'

'Hail & Ride' has been in operation for many years and is often a feature of new routes and/or those serving residential areas. It can assist elderly and disabled people by reducing the walking distance to the boarding point. However, it is difficult to guarantee close kerbside access as the driver can stop at almost any safe location along a 'Hail & Ride' route.

Outlined below are options to improve accessibility of 'Hail & Ride' bus services.

Option 1 – Conversion to fixed stop

On some services there may be a strong case for conversion to fixed stops; for example, where services have grown in patronage and buses are making frequent stops, or where passenger demand is concentrated at identifiable points. Passenger surveys will assist in determining the appropriate solution.

Option 2 – Retention of 'Hail & Ride' sections of route

It may be appropriate to retain 'Hail & Ride' operation:

- on lightly used services;
- on routes where passenger demand is very scattered; or
- where local conditions make installation of bus stops difficult or sensitive.

Where 'Hail & Ride' is retained the following options should be considered to provide improved accessibility.

Option 2a - Provision of information for passengers where 'Hail & Ride' sections are already accessible

Information posts, which display a bus timetable and other information, can be provided at locations which offer good accessibility to and from buses. However, these posts are not fixed bus stops, they do not have a bus stop flag and buses can still stop at other safe points.

The benefits of information points are that they provide reassurance to passengers that buses serve the route and they offer a source of information, such as the destination of buses. The posts also encourage passengers to congregate, rather than waiting at short distances from each other and expecting the bus to make several stops. The advantage for disabled people is that the benefits of 'Hail & Ride' are retained.

Option 2b - Provision of accessible points along 'Hail & Ride' sections of route

It may be appropriate to install accessible boarding and alighting points at intervals along 'Hail & Ride' sections of route. Accessible points could, for example, consist of a simple (2m wide x 4m long) bus boarder to provide full accessibility whilst minimising the impact on the local environment. Parking restrictions for accessible points without bus stops would require a Traffic Regulation Order, as bus stop clearways cannot be installed without a bus stop flag.

Information posts could also be provided, where appropriate, to explain to passengers that a section of route is 'Hail & Ride'.

4. Passenger waiting area

Bus stop post and flag

When the features of the buses using a stop are known, consideration should be given to the passenger waiting area. Ideally the layout of the passenger waiting area should be based around the position of the bus stop flag.

The flag indicates to passengers where they should wait. It also serves as a marker to drivers to indicate where the bus should be positioned at the stop. These guidelines are based on the bus stopping with the rear of the front doors in line with the flag and passengers boarding from the downstream side of the flag, as shown below.



Correct stopping position relative to bus stop flag

In some circumstances it may be appropriate to mount the bus stop flag on a street lighting column, but this should be agreed between London Buses and the owner of the lighting column. This arrangement can cause difficulties in attaching timetable cases in such a way that they do not obstruct the column's access cover.

London Buses currently has a rolling programme to introduce solar powered illuminated bus stop flags and timetables in the Greater London boroughs. These solar powered installations are not compatible with bus stop flags mounted on lighting columns.



Solar powered illuminated bus stop flag

Accessible bus stop design guidance

Waiting area layout

Buses in London are usually configured with a powered ramp at the centre door. On shorter buses, without a centre door, the ramp is situated at the front door. Sufficient unobstructed space is required at the front and centre doors for the ramp to be deployed. Thus, on the footway where the stop is located, there are areas which must be kept clear of all obstructions such as litter bins, telephone boxes and sign posts. The length of clear footway required is defined by the width of the doors. The width of footway needed is defined by the space required for a wheelchair or pushchair to manoeuvre. The Department for Transport's Inclusive Mobility Guidelines state that a skilled manual wheelchair user should be able to complete a 360° turn in a space of 1500mm x 1500mm.



Undesirable street 'clutter' at bus stop

Figures 8 and 9 show suggested bus stop layouts with boarding/alighting zones, which must be kept free of all street furniture. However, for simplicity, it is recommended that, where possible, street furniture is not positioned throughout the length of footway where boarding and alighting is expected. Additionally, street furniture located in the waiting area can reduce the available waiting space close to the stop. It is recommended that the footway, between the flag and 20m upstream, is kept clear of unnecessary street furniture.

It is also important that the stepping height is minimised along the length of the stop. Dropped kerbs for driveways pose particular problems. Where there is a series of dropped kerbs it will be necessary to position the flag carefully between the dropped kerbs. By adopting a boarding/alighting zone, problems for ramp deployment and stepping to and from the bus can be minimised.

At stops to be used simultaneously by multiple vehicles the same boarding/alighting zone principle should be adopted. It is more difficult to recommend a standard design for a second bus because of the possible variations in stopping position and vehicle type. Consideration needs to be given to the distance between the rear of the first bus and the front of the second. To allow following buses sufficient space to exit a stop independently and so reduce potential delays, it is recommended that cage lengths allow a 9m (7m absolute minimum) gap between stopped vehicles, in addition to the approach, straightening and exit length for two vehicles.

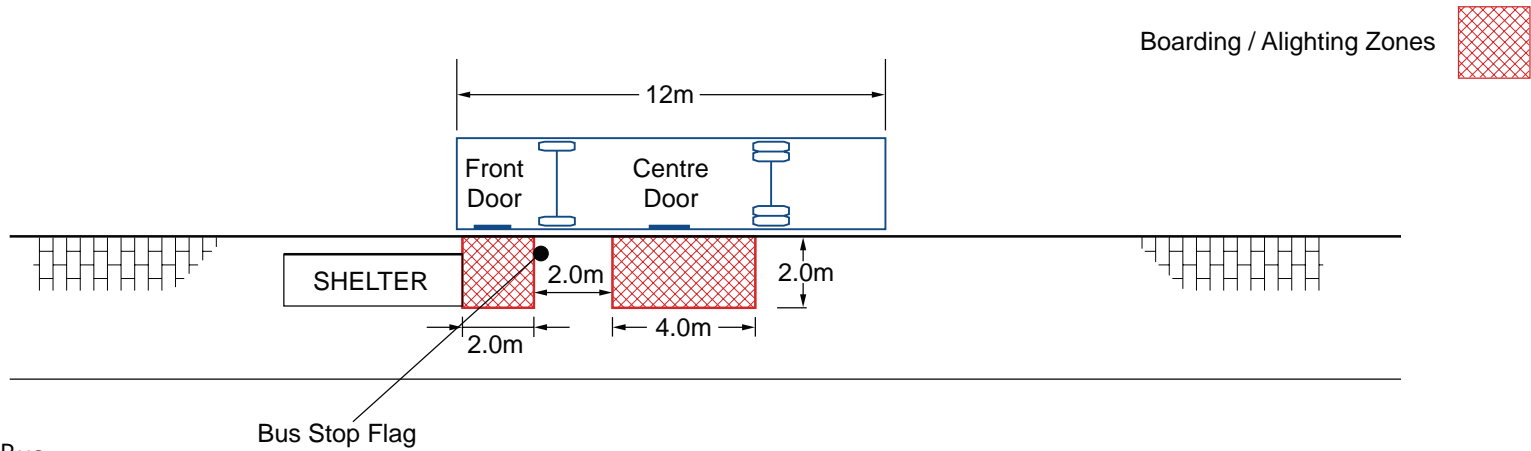

Figure 8.1 : Rigid Bus

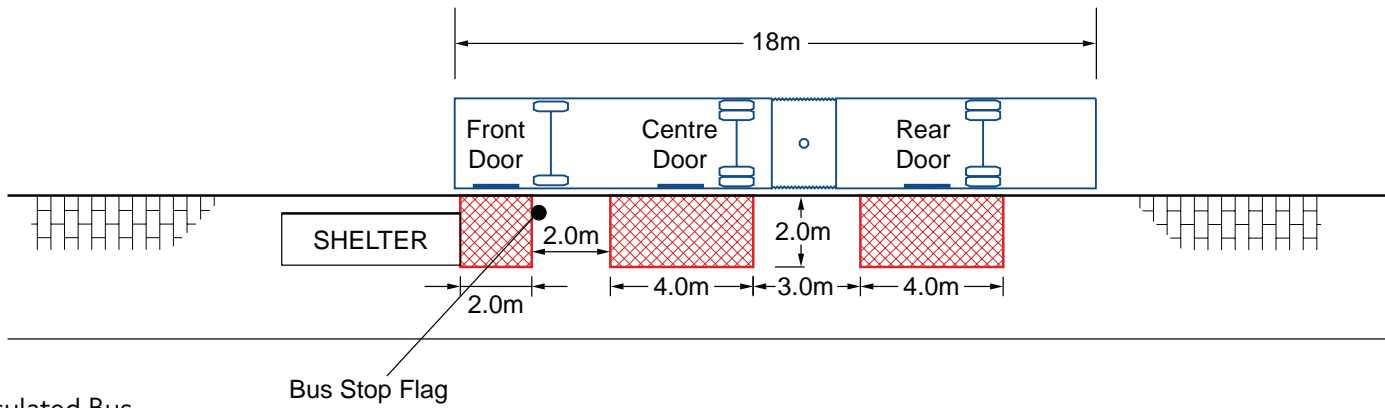

Figure 8.2 : Articulated Bus

Figure 8: Boarding and alighting zones

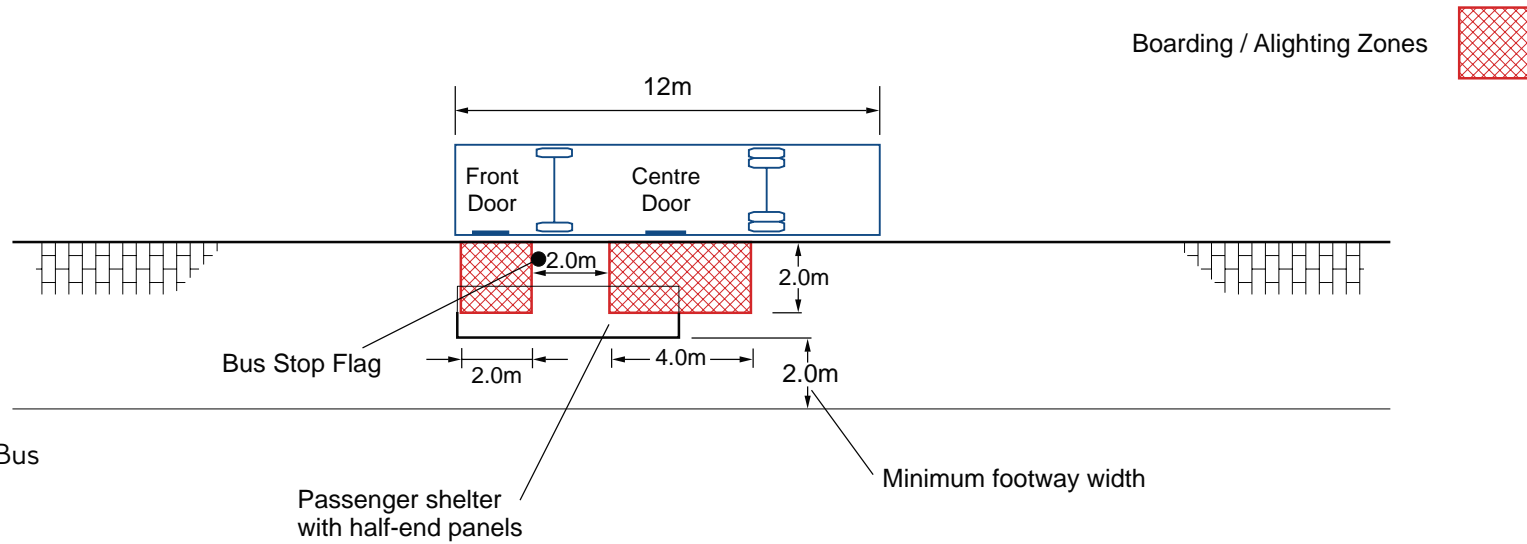

Figure 9.1 : Rigid Bus

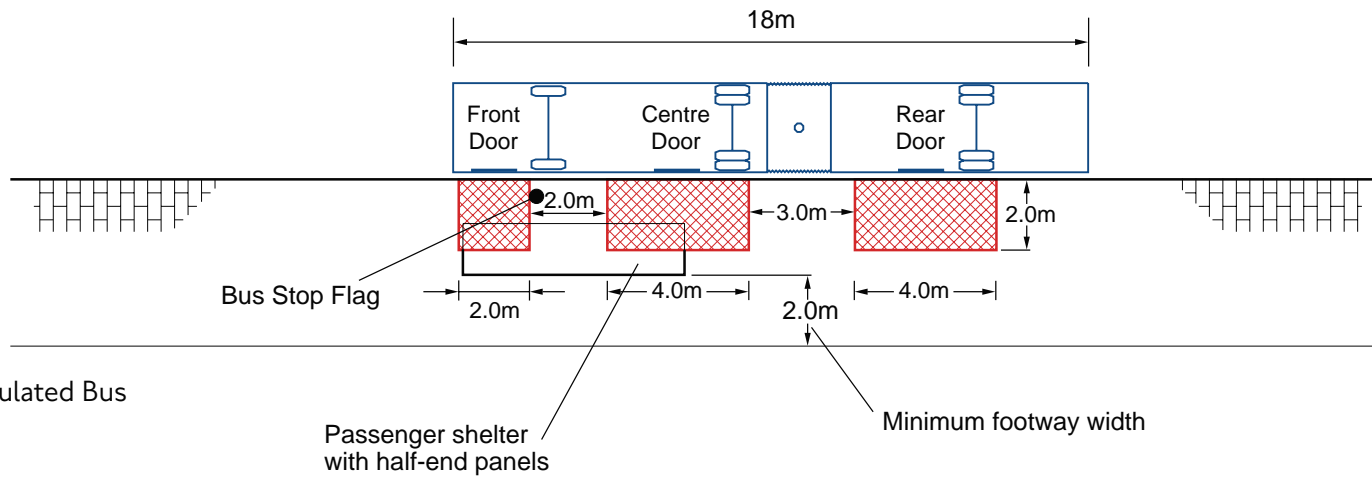

Figure 9.2 : Articulated Bus

Figure 9: Boarding and alighting zones – Alternative shelter arrangement

Bus passenger shelter

Figure 10 illustrates three general layouts for the bus passenger shelter. The 'centre of footway' layout (see Figure 10.1) enables passengers to shelter, see approaching buses, and then board with ease. In addition, this layout allows wheelchair users who may wish to wait by their boarding position at the centre doors to be protected from the weather. Where articulated buses operate a three door boarding configuration, this layout helps to spread boarders between the doors.



'Centre of footway' shelter layout

Other arrangements may be used where footways are narrow or other site constraints dictate. The 'back to kerb' layout (see Figure 10.2) can encourage passengers to stand upstream of the shelter so that they can see and board the bus more easily. The 'back of footway' option (see Figure 10.3) is only appropriate where access to adjoining buildings can be maintained.

All layouts position the bus stop flag 2m distant from one end of the bus shelter. This arrangement provides two points of reference for bus drivers pulling up to the kerb, and indicates to passengers where the front doors will open.

Figure 10: Passenger waiting area critical dimensions

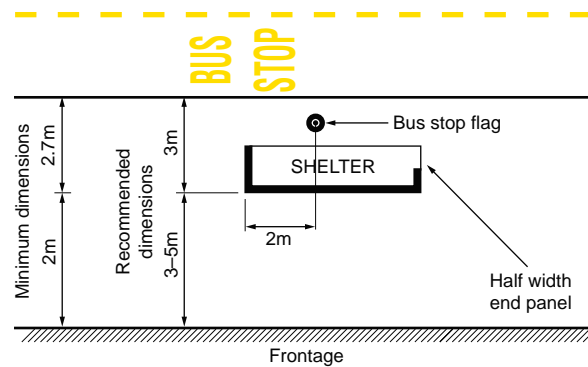
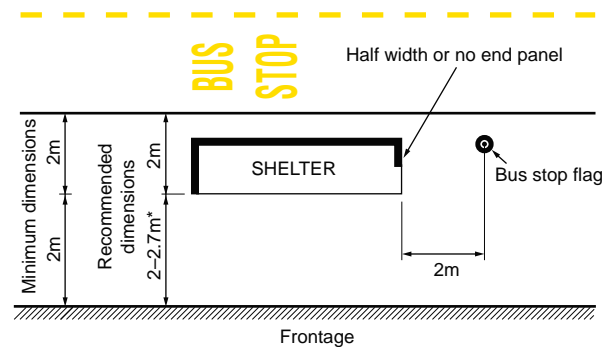

Figure 10.1: Centre of footway



*Above 2.7m, recommend 'centre of footway' solution

Figure 10.2: Back to kerb

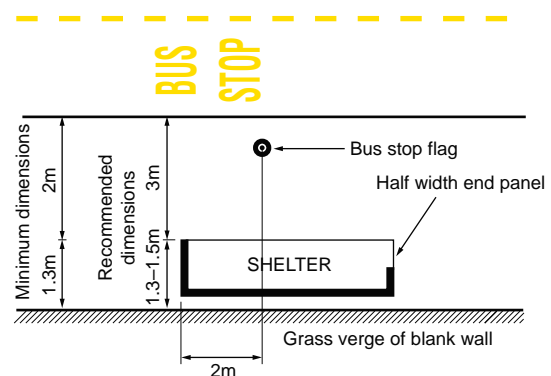

Figure 10.3: Back of footway

The design of the shelter may affect its positioning on the site. Shelters with a half width or no end panel on the bus approach side are recommended, because this improves visibility.

Accessible bus stop design guidance

Shelters generally consist of between 1 and 4 panels each of 1.3m in length, with end panels of either 1.3m (full width) or 0.65m (half width). Roof overhangs can affect overall shelter positioning, but narrower variants are also available and London Buses will advise on these issues. Lighting within the shelter can help to improve perception of personal safety. Other shelters, such as the 'Landmark' (see photo) are also provided at selected locations.



'Landmark' type shelter

Footway width and pedestrian flows

The passenger waiting area, or platform, where bus passengers board and alight needs to be designed to allow sufficient space for the stop infrastructure, such as shelters, as well as pedestrian through movements. Research has

shown that pedestrians will generally cope well with congested conditions, but some simple interventions can make the pedestrian environment more comfortable. At some locations it may be necessary to widen the footway and this can often be achieved through the provision of a bus boarder (see Chapter 7).

Figure 10.1 shows that the 'centre of footway' shelter layout should leave at least 2.7m (3m is preferred) between the kerb edge and the rear of the shelter for wheelchair users to manoeuvre. The gap between the shelter and the rear of the footway should allow for passengers' tendency to stand at the rear of the footway in congested conditions, as well as an unobstructed width of at least 2m. Therefore, a footway width of 3-5m is recommended (depending on pedestrian flows).

'Back to kerb' and 'back of footway' layouts also need to leave an unobstructed width of at least 2m for pedestrians. Larger unobstructed widths are recommended, but where unobstructed widths of over 3m can be achieved, a 'centre of footway' shelter solution should be considered instead. 'Back of footway' layouts with large footway widths will make it difficult to board the bus.

Footway widths are effectively reduced by street furniture such as telephone boxes, lamp columns, litter bins and ticket machines. At congested bus stops, queues can often reach 20m upstream of the bus stop flag, and therefore, unobstructed areas should be created within this entire zone where possible, by moving street furniture downstream of the bus stop, rationalising it or removing it altogether. This will help visibility of approaching buses as well as increasing

pedestrian space. A simple audit of features in and around bus stops should aim to:

- reduce street clutter;
- optimise bus stop location, including spacing;
- optimise shelter location; and
- consider other boundary effects, such as cash machines.

When designing accessible bus stops for a retail area, or other locations where pedestrian flows are high, pedestrian counts should be undertaken at peak times such as Saturday 10am to 5pm and/or 12pm to 2pm during the working week.

A yellow footway guidance line or edge marking, offset 450mm from the kerb edge and 100mm in width can be used in the bus stop area. This can aid drivers, as a reference point, on their approach to the stops, and can encourage pedestrians to stand away from the kerb edge.



Yellow footway guidance line

Ticket machines

Bus services in London are moving towards 'cashless' boarding. In Central London, and on articulated bus routes, tickets must be bought before boarding. This has led to the installation of ticket machines at all stops where 'cashless' boarding has been introduced. The positioning of a ticket machine at a stop depends upon the type and location of the shelter. However, it is important that ticket machines are treated the same as other street furniture and are not located in the boarding and alighting zones shown in Figure 9.



Conveniently located ticket machine

Whilst it is planned that all of London's bus services will become 'cashless', it is expected that there will only be a very limited number of new ticket machines required on street. The emphasis will be on bus passes and pre-paid Oyster cards.

Waiting area environment

Designers should consider other aspects of the passenger waiting area, not just those primarily related to access between the footway and bus. The environment of the passenger waiting area is an important component of passengers'

Accessible bus stop design guidance



perceptions of the quality of the bus service and safety. A number of issues should be considered:

- **Street lighting:** Poor, or inadequate, street lighting can contribute to issues of personal security. Good levels of illumination should be provided at bus stops.
- **Litter:** A clean passenger waiting area improves the passengers' environment. Litter bins should be provided but care needs to be taken in locating litter bins to reduce nuisance, such as smells and flies, and avoid obstruction to pedestrian and passenger movement. They should also be emptied regularly by the local authority.
- **Statutory undertakers' equipment:** Positioning of bus stop posts and passenger shelters can be affected by underground utilities. Service covers can also create long

term problems at the bus stop owing to access requirements to equipment. Consideration should be given to the boarding/alighting zone to avoid access difficulties during maintenance works.

- **Drainage:** Poor drainage, resulting in water 'ponding' on the footway around the passenger waiting area or at the carriageway kerbside, can affect the passenger environment. Ponding may result from poor drainage, defective carriageway repairs, rutting or blocked drains. In freezing conditions footway ponding can be particularly dangerous. Ponding at the kerbside can result in passengers being splashed by passing traffic (or the bus) and it is, therefore, important that good drainage is provided.

5. Bus stop area

Bus stop cage

The bus stop marking on the carriageway, often referred to as the bus 'cage', (Traffic Signs Regulations and General Directions (TSRGD) 2002 diagram 1025.1), is used to define the limits of the bus stop. The purpose of the bus stop cage should not merely be seen as identifying a stopping point. The bus stop cage has four distinct and important objectives – it defines an unobstructed area of the carriageway where the bus can:

- approach;
- straighten up;
- stop; and
- exit.

It is a key requirement that a bus stop cage marking is provided and the area defined by the cage is unobstructed to allow easy entry and exit for the bus and thus, improved ride quality for passengers. The aim is that buses can pull up to within a maximum of 200mm from the kerb. Layouts to achieve this are illustrated in Chapters 6 - 8. Other features that assist bus stop operations are parking/loading restrictions and coloured surfacing. The length of the bus stop cage will vary depending on the highway layout and number of buses per hour using the stop.

Bus stop cages are usually 3m wide, however, designers should be aware that the TSRGD 2002 does allow some variation in road markings (TSRGD 2002, Article 12 Table 2). The marking can be reduced/increased by up to 10%. This allows cage widths of 2.7m to be introduced. Experience has shown this can be useful where carriageway widths are reduced, and there is some evidence to suggest that narrower 2.7m wide cages encourage bus drivers to stop closer to the kerb.

Bus stop clearways

Within the cage area, stopping by vehicles other than buses is prohibited. On borough roads a clearway marking must be provided in accordance with TSRGD diagrams 974 and 1025.1. Traffic Regulation Orders are no longer required for these bus stop clearways, although highway authorities may still wish to undertake public consultation.

Bus stops located on the Transport for London Road Network (TLRN), are generally marked with double red lines. Department for Transport sign approval has recently been given for a wide red clearway line, which additionally prohibits taxis and Blue Badge Holders from stopping at bus stops on the TLRN. It is envisaged that this restriction will only be used at a number of strategic bus stops.



Clearway marking – Borough controlled road

Red coloured surfacing

Highlighting the bus stop cage to indicate to other road users that it is an area for use by buses is recommended. This can be achieved by providing a red coloured surface treatment within the cage, either through a coloured surface dressing or a coloured bituminous surface course. This has proved effective in deterring illegal parking and reducing enforcement problems.

6. Bus stop layouts

Introduction

Bus stops unobstructed by kerbside activity are rare and it is usually necessary to find a means to sufficiently encourage motorists to keep the bus stop clear. As discussed in Chapter 5, all bus stops should have a marked cage as per TSRGD 2002 diagram 1025.1 with stopping restrictions ideally operating 24 hours a day.

Figure 11 (see page 26) shows layouts for both 12m rigid buses and 18m articulated buses where the bus stop has parking bays on both the approach and exit sides of the stop. The clear kerbside space is required to allow convenient and efficient bus access to within 200mm of the kerbside. These lengths are often difficult to achieve, even for 12m buses, and reductions to 25m lengths have been used. Such short cage lengths do not work; an absolute minimum length is 33m, which itself imposes a constraint on the bus drivers' egress from the stop.

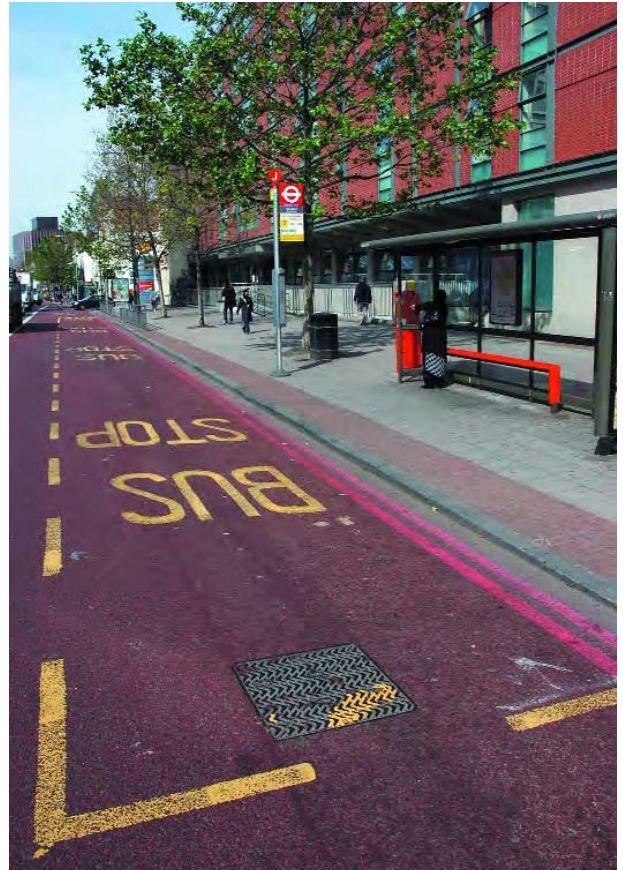

The cage length required will also depend on the width of parking/loading boxes on the approaches/exits. Where wider loading boxes are situated on the approach/exit then additional space is required because of the increased lateral movement.

There is a need for alternative layouts that reduce the length of cage required, whilst keeping the bus stop unobstructed. There are two convenient locations for bus stops where this can be achieved:

- the exit side of a pedestrian crossing (Figure 12 on page 27); and
- the exit side of a junction (Figure 13 on page 28).

These two layouts assist bus access whilst minimising the length of bus stop clearway. They also have the advantage of placing stops near to where passengers may wish to cross the road. Safety issues must always be considered when adopting such designs. It is important to plan the cage size for the frequency of buses, otherwise following buses could block the crossing or side road (see Chapter 3 for further information).

It should be noted that buses are permitted to stop on the exit side zig-zag markings at Pelican and Zebra crossings to pick up or drop off passengers. Whilst some authorities reduce the length of exit side zig-zag markings, this practice is not recommended.

Most junctions on bus routes have some kerbside controls. However, problems can occur as a result of vehicles stopping between the cage and junction, even with kerbside restrictions. In practice, marked bus cages with stopping restrictions are more effective at discouraging vehicles stopping in this area and are easier to implement. An extension to the cage to prohibit stopping on the approach is shown in Figure 13 (see page 28).

Any relocation of the stopping position of the bus closer to the junction should have regard to visibility for drivers of vehicles leaving the side road. While a bus using the stop is a temporary obstruction, the bus stop post/flag, passenger shelter and waiting passengers should not unduly obscure sight lines.



Exit side of pedestrian crossing



Exit side of junction

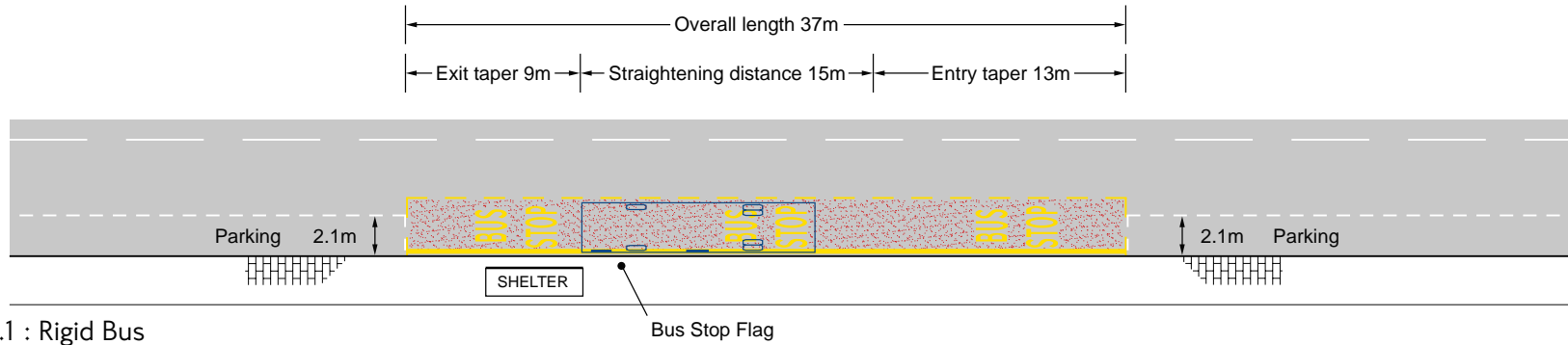

Figure 11.1 : Rigid Bus

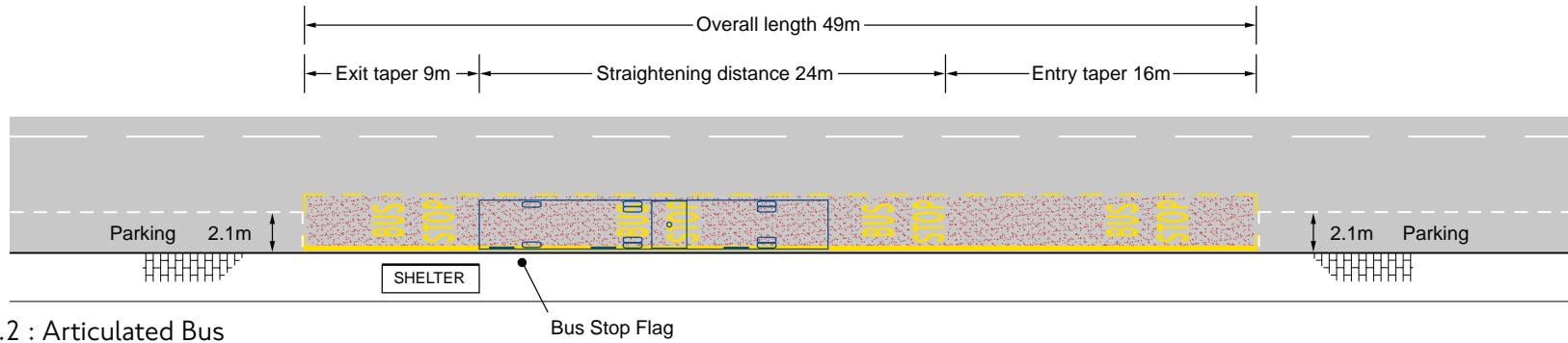

Figure 11.2 : Articulated Bus

Figure 11: Kerbside stop with parking on approach and exit

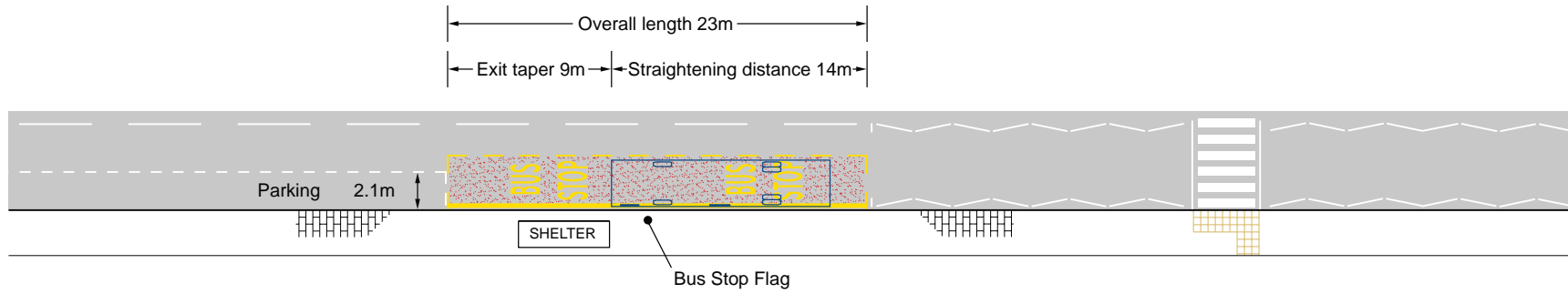

Figure 12.1 : Rigid Bus

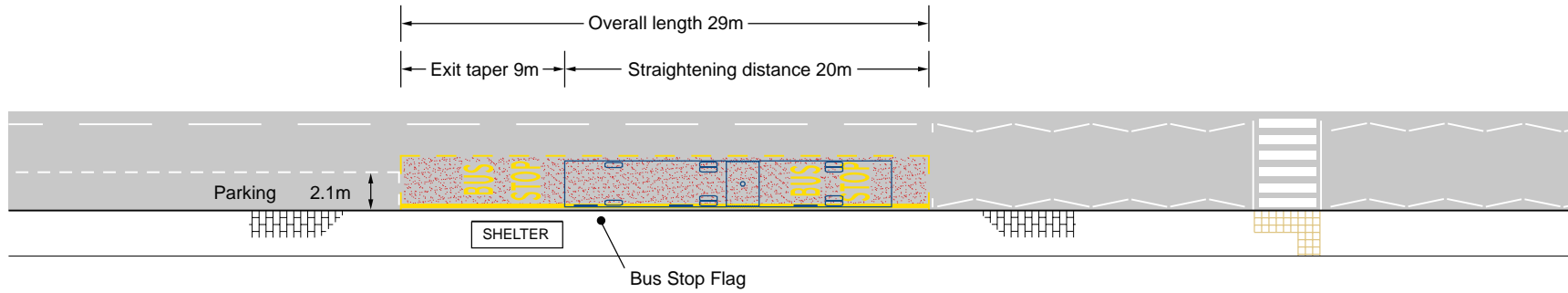

Figure 12.2 : Articulated Bus

Figure 12: Exit side of pedestrian crossing

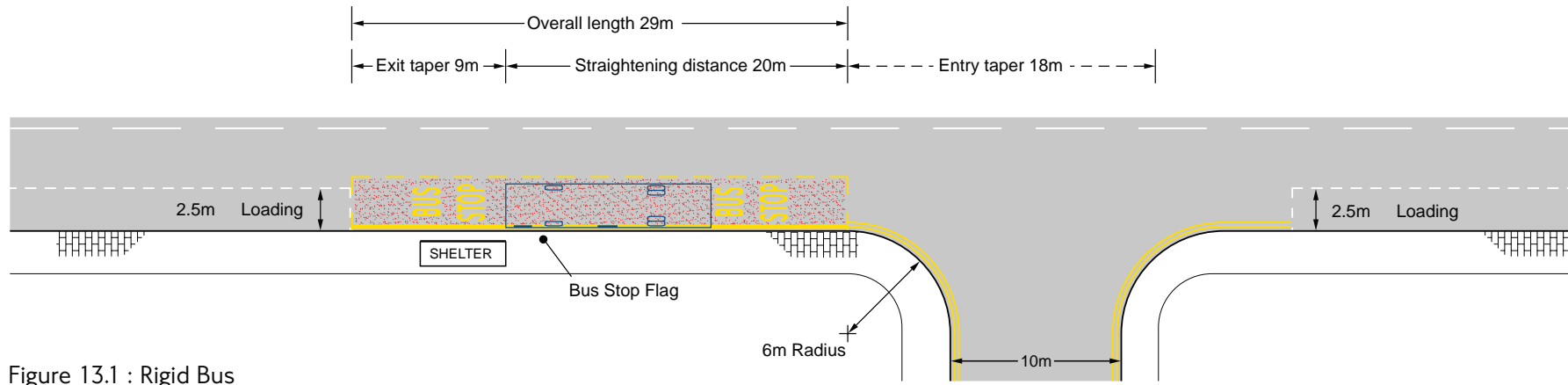

Figure 13.1 : Rigid Bus

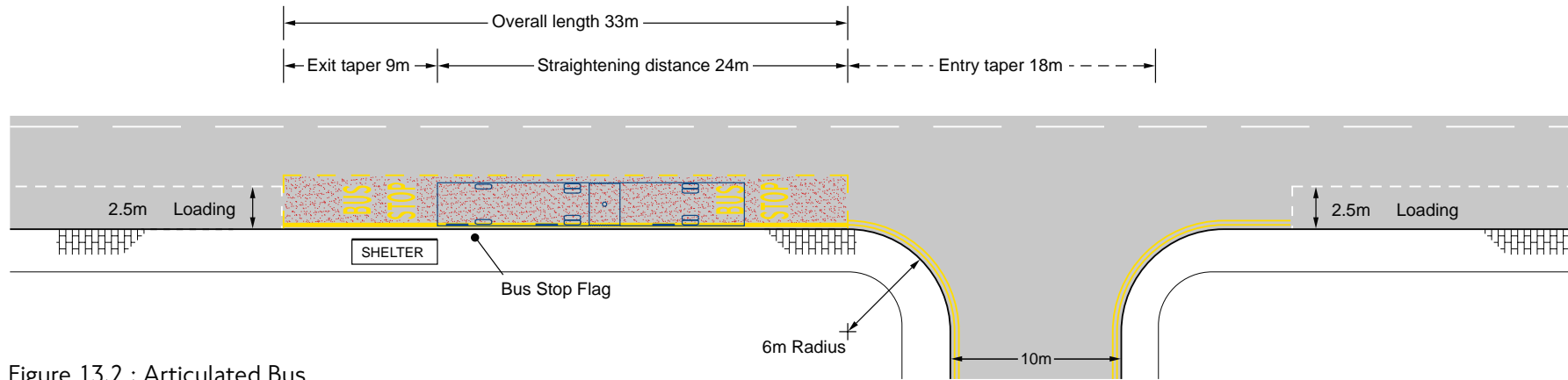

Figure 13.2 : Articulated Bus

Figure 13: Exit side of junction

Bus manoeuvres

At locations where buses often have to manoeuvre around parked vehicles to pull up to and away from the stop, designers need to understand the implications of reducing the cage dimensions illustrated in Figures 11 to 13.

A clear exit distance of 9m is the minimum necessary for buses to leave the stop and rejoin the general traffic lane without the rear of the vehicle overhanging the kerb in the vicinity of waiting passengers. Exceptionally, in a highly constrained situation, this dimension could be reduced to an absolute minimum of 7m.

Particular care is required when dealing with bus stops used by articulated buses, due to the way they behave as they articulate. If the bus stop exit distance is reduced to below 9m, it is possible for the body of the bus to overhang the footway at the articulation point and the rear of the bus. This effect, which could pose a conflict with pedestrians, is illustrated in the adjacent photographs.

The rear section of a rigid bus can also behave in the same way as the rear of an articulated bus.



Centre section of bus overhanging footway as it exits stop



Rear section of bus overhanging footway as it exits stop

Alternative solutions

There will be situations where none of the kerbside designs illustrated can be implemented without seriously affecting existing kerbside activity or general traffic operations. This problem often arises at busy stops, which require a very long length of kerb to be kept free from any other activity.

In many cases, stop accessibility will be hampered by legal or illegal loading or parking on the approach to the bus stop. In such cases, it may not be physically possible for the rear of the bus to manoeuvre close to the kerb. In other situations, site constraints prevent conventional layouts from being implemented. Situations that cause problems for the siting of conventional kerbside bus stops include:

- where there are loading or parking boxes which cannot be moved without causing undue inconvenience for frontage users; and
- where existing restrictions are neither observed nor effectively enforced.

In such cases a solution may be to alter the kerb line to assist bus access, for example by installing a bus boarder.

7. Bus boarders

Bus boarders

Bus boarders are generally built out from the existing kerb line and provide a convenient platform for boarding and alighting passengers. There are two conventional types of bus boarder, full width and half width. There are also variations on the bus boarder concept such as 500mm build-outs in the downstream section of bus bays (see Figure 19.1 on page 41).

The full width boarder offers by far the best solution for both bus and passenger access whilst minimising the kerb length required. Full width boarders also serve to upgrade the image of the bus by providing a platform that is separate from the adjacent pedestrian flow, and thus move towards the standards achieved by tram and light rail systems.

Full width boarders

A full width boarder should project far enough into the carriageway for the bus to avoid manoeuvring past parked vehicles. For cars this should be at least 2m and a minimum of 2.6m where goods vehicles/vans are stopping. The length of the boarder will depend on the vehicle types that serve the stop in addition to the bus frequency. Figure 14 shows typical full width boarders. The length of kerbside space required can be reduced by providing a shelter, open towards the kerb, on the existing footway (see Figure 15.1). Where smaller midi type buses serve the stop, and no passenger shelter is provided, it is possible to implement a boarder only 3m long (see Figure 15.2).

The benefits of a full width boarder are that it:

- minimises the kerbside space required;
- deters illegal parking;

- maintains the place of the bus in the traffic stream;
- allows the bus to line up parallel to the kerb, largely without manoeuvres;
- reduces boarding/alighting time;
- reduces overall time spent at the bus stop; and
- creates additional footway space for passengers to wait.

Further details of the benefits of bus boarders are provided in Appendix B, which summarises a study into the effects of bus boarders undertaken for Transport for London by TRL.

The ability of the bus to stop at a full width boarder largely without manoeuvre provides the opportunity for special kerbs to be installed with the aim to minimise the vertical and horizontal distances between the footway and the bus floor (see Chapter 9).

The full width boarder keeps the position of the bus in the traffic stream, simplifying access and improving bus reliability, as the bus is not delayed waiting to rejoin the traffic stream.



Full width boarder

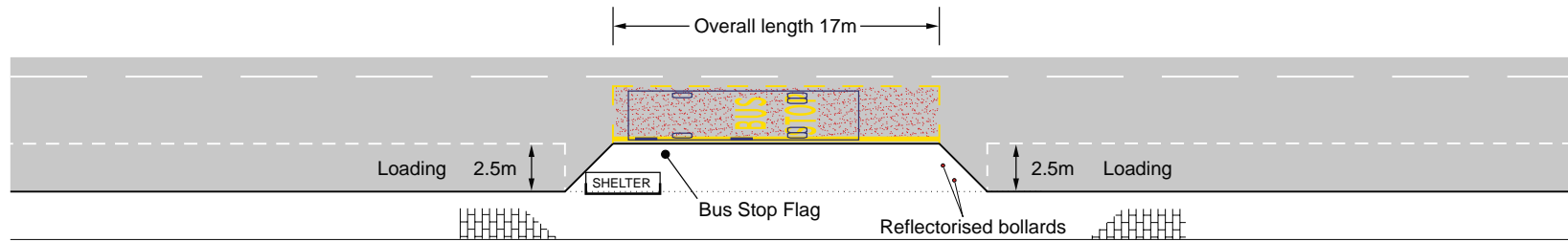

Figure 14.1 : Rigid Bus

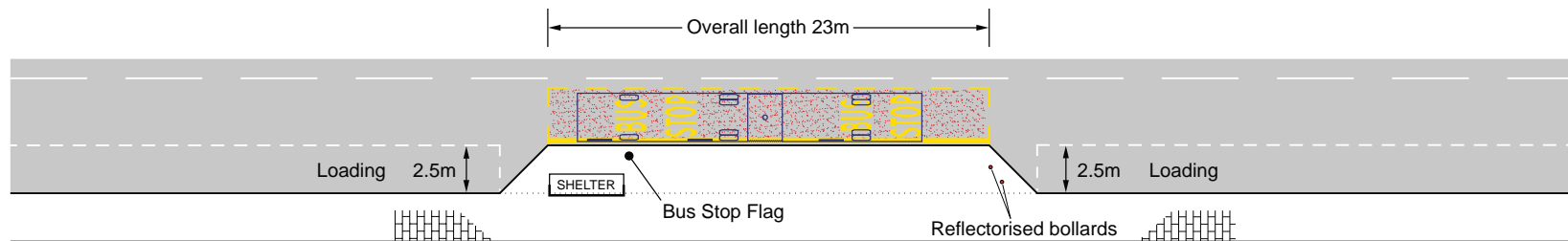

Figure 14.2 : Articulated Bus

Figure 14: Full width boarder

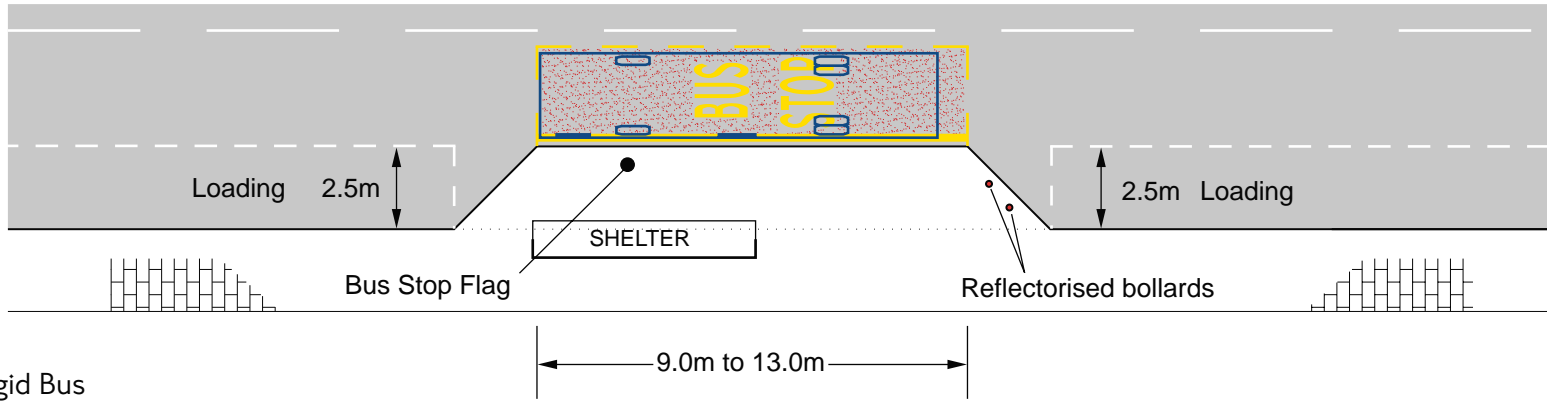

Figure 15.1 : Rigid Bus

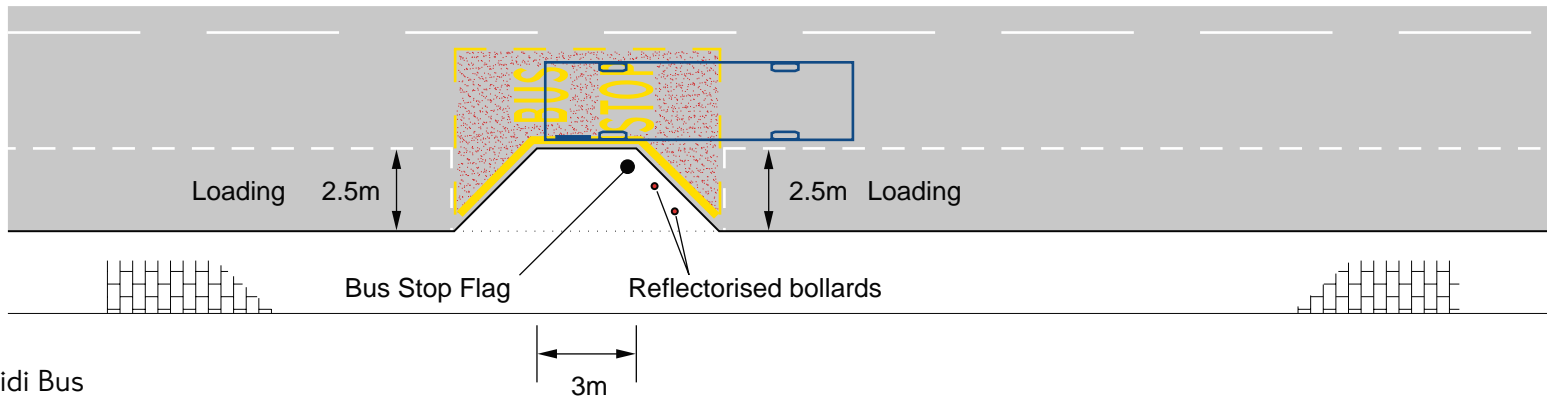

Figure 15.2 : Midi Bus

Figure 15: Alternative full width boarder layouts

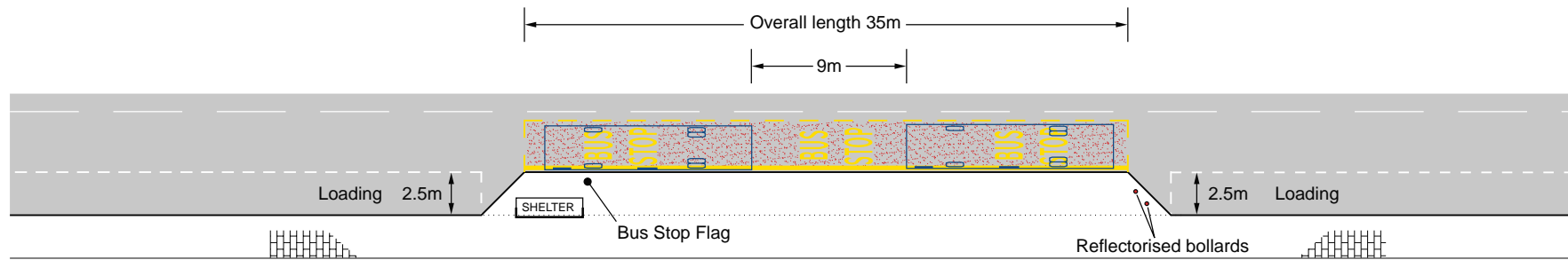

Figure 16.1 : Rigid Bus + Rigid Bus

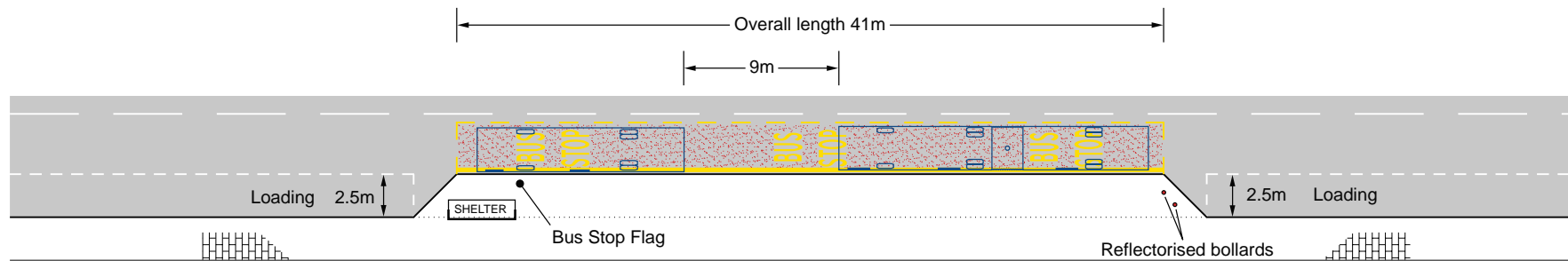

Figure 16.2 : Rigid Bus + Articulated Bus

Figure 16: Multiple bus full width borders

Full width boarders should not be used where the frequency of buses or their dwell times will cause delay to following buses. There may also be circumstances where, for safety reasons, it may not be appropriate to encourage an overtaking manoeuvre by other traffic, such as near the brow of a hill or an approach to a pedestrian refuge/island.

The design of bus boarders should provide increased opportunities for the provision of passenger shelters. It is also essential that boarders are properly designed and constructed, particularly in relation to carriageway and footway drainage. When making any changes to kerb lines, designers should consider the impact on cyclists, as abrupt deviations in alignment can create pinch-points for two wheelers with general traffic.

Layouts for bus boarders to cater for multiple vehicles stopping at a single stop are provided in Figure 16 opposite.

Half width boarders

The half width boarder design is often a useful compromise solution. The build-out from the kerb can range from 500mm up to the width of a full boarder, although they are commonly 1.0 - 1.5m wide. They should be used where frequent delays to other vehicles are to be avoided or where a full width boarder would place the bus in, or too close to, the opposing traffic stream. As half width boarders are a compromise design, they use more kerb space, as some manoeuvring of the bus is required (see Figure 17 on page 37). Half width boarders retain some of the advantages of full width boarders, as they still deter illegal parking close to or within the bus stop cage and the prospects of the bus stopping close to the kerb are improved.



Half width boarders

Accessible bus stop design guidance

In circumstances where a layout has to cater for more than one bus stopping at the same time, provision should be made for the second bus to pull out past the first bus and for all doors of each vehicle to have clear access, unobstructed by street furniture.

Angled boarders

Parked vehicles on the approach to the stop often result in buses stopping at an angle, with the front of the bus close to the kerb. Provision of a 'wedge' shaped or angled boarder can, in limited circumstances, improve access and enable the bus to stop adjacent to the kerb in these situations. They have been found to be particularly suitable at stops on the approach to junctions where the road naturally widens leading up to the junction stop line. However, this is unlikely to be suitable at stops where the bus has to turn right at the downstream junction.



Angled boarder

The design of the angled boarder is constrained by alignment, lane widths and approach and exit arrangements. Designs should be examined to check that vehicles overtaking a stationary bus do not encroach unduly into the opposing traffic lane and that buses at adjacent stops can be safely passed. It is important that designs are tailored to site specific circumstances. Some sample layouts are shown in Figure 18 (see page 38).

Safety concerns regarding these less conventional layouts have been addressed in formulating the designs. The following points are relevant when considering such a design:

- drivers often stop at an angle, and in a similar position to that proposed through necessity rather than choice - the angled boarder simply formalises this arrangement;
- the driver's blind spot is largely eliminated as drivers pull forward and gain visibility through their rear view mirrors before committing themselves to manoeuvring into the general traffic stream.

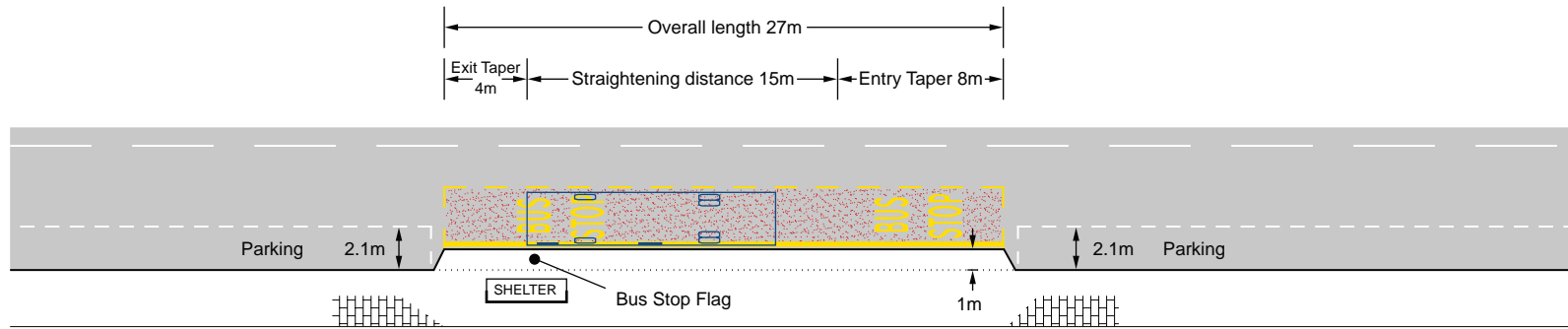

Figure 17.1 : Rigid Bus

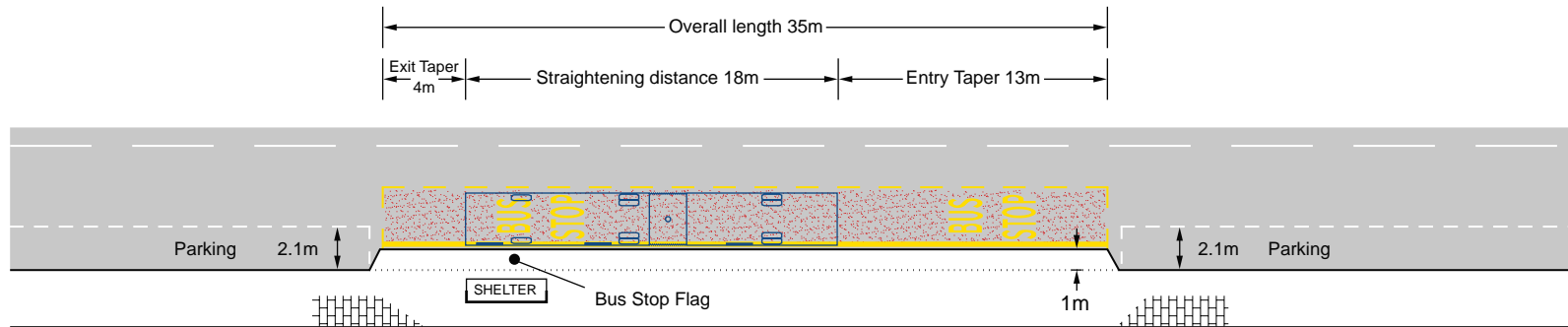

Figure 17.2 : Articulated Bus

Figure 17: Half width boarder

8. Bus bays

Bus bays (or lay-bys) present inherent operational problems for buses and they should not be used unless there are compelling safety or capacity reasons. The Mayor's Transport Strategy lends further weight to this view in that priority should be given, wherever possible, to efficient 'people-movers' such as buses. However, in circumstances where provision of a new bay is required the layout in Figure 19.1 is recommended. This design incorporates a build-out to allow buses to turn tightly into the bay. In circumstances where two or more buses may require access to the bay at one time, the stop area will require lengthening.



Partial build-out within bus bay

As discussed in Chapter 5, a bus cage with 24-hour stopping controls, to prevent parking or loading in the stop area, is recommended at all bus stops, (as shown in TSRGD diagram 1025.4). There may also be a need to prohibit parking or loading on the approach to, and exit from the bay, although if this is the case, the justification for a bus bay may be highly questionable.

There are many bus bays in use and the layout of most of them prevents buses from reaching the kerb effectively. The Bus Priority Partnership Steering Group (which includes representatives of London's highway authorities) has approved a policy of filling in bus lay-bys on roads where the speed limit is 30mph or less, unless there are compelling reasons for them to remain.

Research undertaken by TfL (see Appendix C) has shown that in-filling a lay-by and replacing it with a kerbside stop will:

- make it easier for the bus to stop adjacent to the kerb;
- make it easier and quicker for passengers to board/alight; and
- reduce delays to buses by between 2 and 4 seconds per bus.

Figure 20 (see page 42) shows modifications to bus bays that can improve bus access to the kerbside. Designers should note that with these layouts, the bus protrudes into the nearside lane and amendments to traffic lane widths might be required. An alternative solution is to fill-in the bus bay completely, providing additional footway space that can be tailored to the boarding and alighting characteristics required.

Accessible bus stop design guidance

At locations where there is persistent parking in the bay, another variant is to fully fill a section of the bay, enabling the bus to stop on the main carriageway, whilst retaining a shorter bay for loading activity (see Figure 19.2). As can be seen from a comparison of Figures 19 and 20 with Figures 14 to 18, bus bays inevitably sterilise a far greater kerb length than any type of bus boarder.



Fully filled bus bay

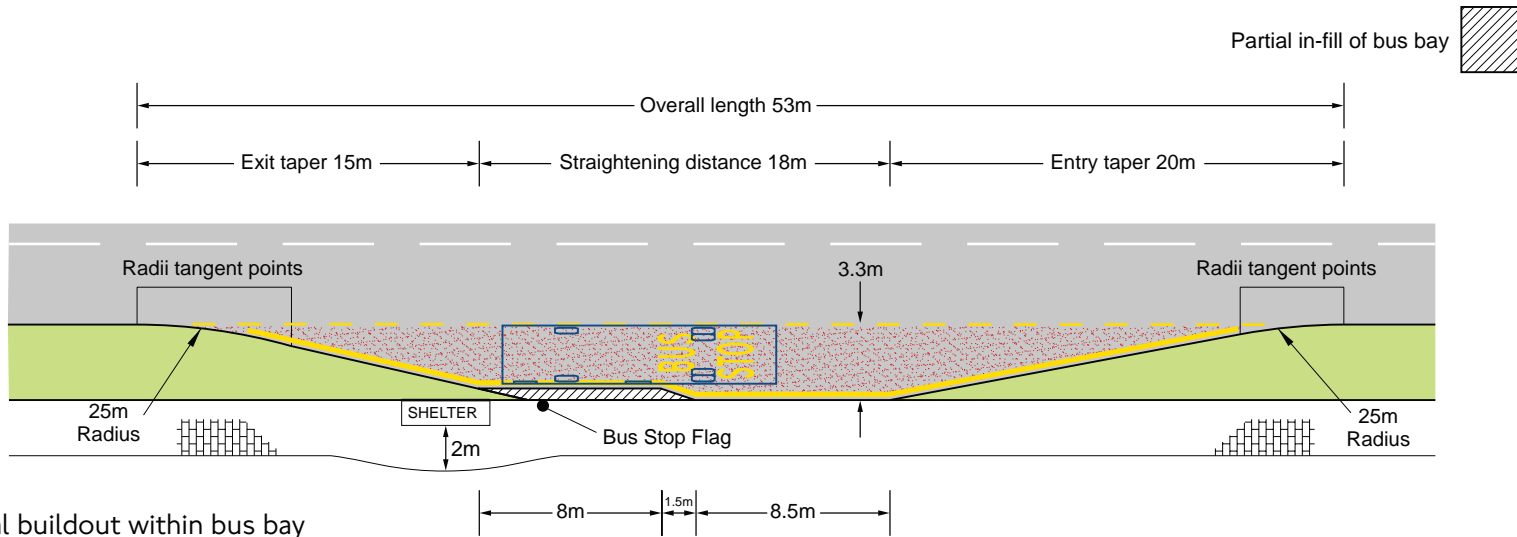

Figure 19.1 : Partial buildout within bus bay

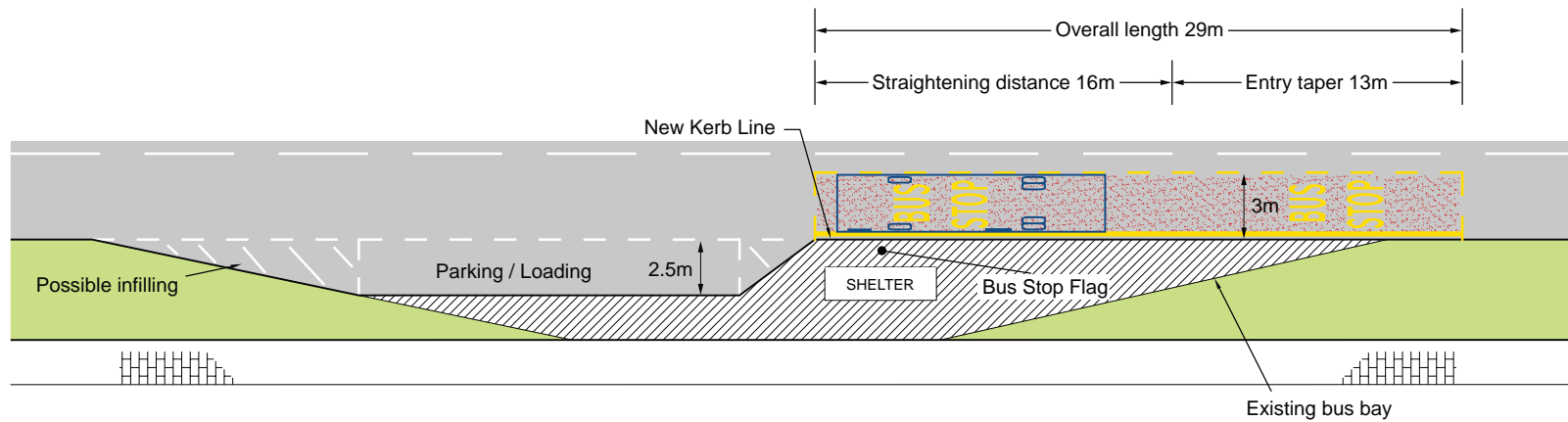

Figure 19.2 : Part filled bus bay with parking

Figure 19: Bus bay arrangements

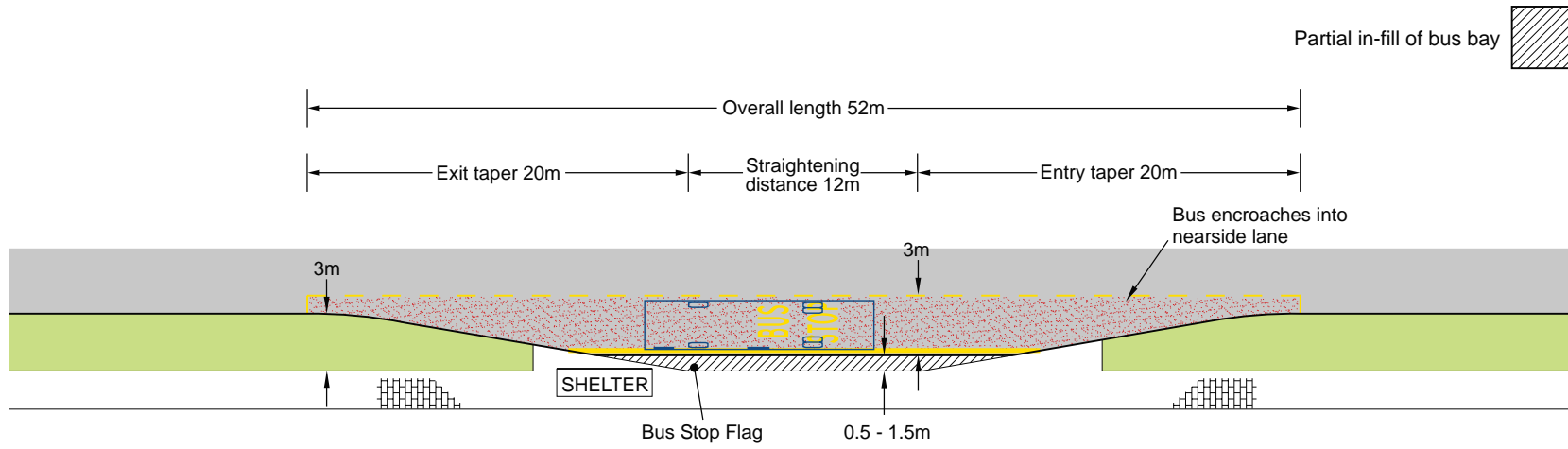

Figure 20.1 : Rigid Bus

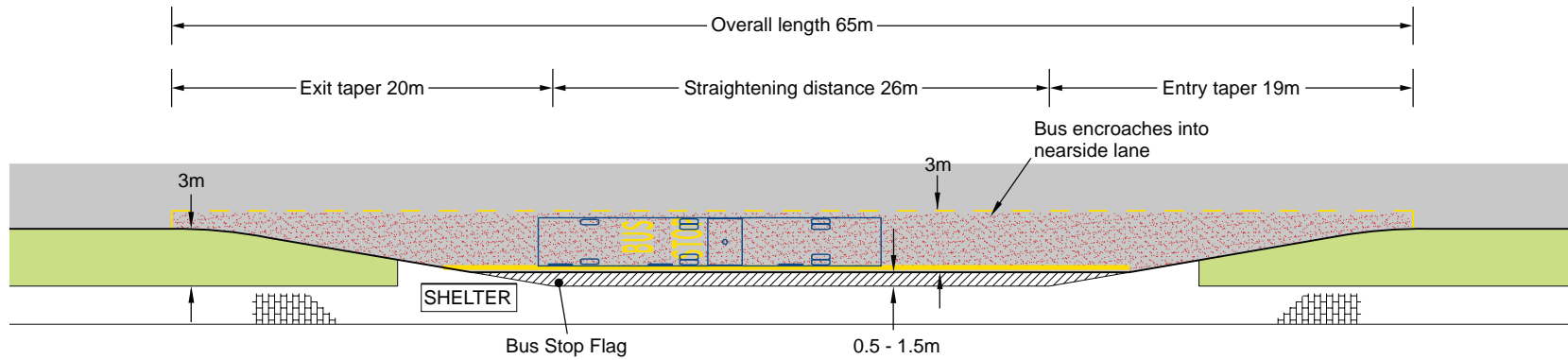

Figure 20.2 : Articulated Bus

Figure 20: Amendment to existing bus bay

9. Kerb profiles and heights

Kerb heights

The 'standard' kerb height at bus stops is 125mm, although designers need to check site conditions to obtain the correct gradient when a ramp is deployed. Allowance should be made for the slight height differences between empty and fully laden buses. A check should be made for any potholes or gullies below the road channel, which could affect bus operation.

It is recommended that kerb heights of less than 125mm should be increased to a maximum of 140mm. Kerbs that are raised to a 140mm height produce a lower ramp gradient and allow for resurfacing.

Kerb faces of between 125mm and 140mm high, are unlikely to require alteration. However, where kerbs are already being altered at bus stops e.g. to build a bus boarder, consideration should be given to the use of higher kerbs to reduce the step height, thereby improving access for all bus users including those with disabilities.

Where increased kerb heights are being considered to reduce step heights, the ground clearance of buses must be taken into account. Although bus stop layouts have been designed to avoid the need for buses to overhang the kerb on arrival or departure, this may occur at particular sites due, for example, to inconsiderate parking. Where there is a possibility of the bus body overhanging the kerb, the height of the kerb should be no higher than the minimum ground clearance. Kerb heights greater than the ground clearance of the bus should only be used at locations where

there is no likelihood of the bus overhanging the kerb. The use of high kerbs, standard kerbs, and the transition between them will need careful consideration at bus stops.



'Special' kerbs

The ideal kerb arrangement should provide close vertical and horizontal alignment between the bus floor and adjacent footway. However, it is sometimes difficult for bus drivers to position their vehicles close to kerbs of traditional design, as they are not easily seen from the drivers' cab position, and the driver will wish to avoid damage to the vehicle. 'Special' kerbs, such as 'Kassel' kerbs, provide the additional height required to reduce step height and have a profile to help guide the bus along the kerb edge and into a position with reduced horizontal gap between bus and footway. These kerbs are more durable and less likely to be damaged by contact with bus tyres. They are also made with materials that are better able to cope with bus tyre contact, without damage to the tyre. TfL are aware of three such kerbs that are currently available in the UK and these are shown in Figure 21.

The table overleaf gives the kerb heights available. Transition kerbs are used to link the standard kerb height to that of the 'special' kerb adjacent to the bus stop.

Accessible bus stop design guidance

'Special' bus stop kerb details

Type	Heights available	Transition heights	
Brett Landscaping 'Kassel' Kerb	180mm or 160mm	120mm to 160 or 180mm	
Camas (Charcon) Access Kerb	220mm or 160mm	125mm to 160mm and 160mm to 220mm	
The Marshalls Bus Stop Kerb is a two-piece system that allows for variable kerb height, up to 200mm.			

Appendix D provides contact details for the three products listed.

For kerb faces up to 140mm, standard kerbs (to tie in with existing kerbs, where possible) are recommended, since there appears to be no advantage in using special kerbs in such circumstances.

It is recommended that a 160mm high 'special' kerb (i.e. Kassel / Charcon/ Marshalls) should only be used where there is little or no lateral movement of the bus and very little risk of overriding the kerb to get to the stop.

This is due to:

- the different configurations of bus chassis/body combinations in use;
- highway conditions in terms of varying camber of roadway, fall of footway, trench reinstatement condition etc.; and

- fears for the safety of pedestrians where kerbs are set unduly high.

'Special' kerbs are ideal for stops where there is a full width bus boarder or no parking on the approach (such as on the exit side of zig-zag markings or junctions). It will be beneficial to the bus driver if, in the event that 'special' kerbs are used, there is only one type installed along any given route.

If 'special' kerbs are to be used, the following will need to be considered:

- footway drainage levels;
- gradient of footway;
- carriageway crossfall; and
- existing pedestrian activity.

Carriageway and footway crossfalls

Where kerb heights are changed, carriageway and footway crossfalls will need to be carefully considered. As a general rule, carriageway crossfalls in the region of 1 in 40, or 2.5%, should not present any additional difficulties for low floor buses. For carriageway crossfalls steeper than 2.5%, regrading of the carriageway should be considered.

Footway crossfalls are also important and a steep backfall from the kerb is undesirable. A gradient of no more than 1 in 25 or 4% is suggested. To achieve this designers may have to regrade lengths of footway to maintain adequate crossfalls or introduce complex drainage arrangements. A common problem with bus boarders is that works are only undertaken on the build-out, leading to steep crossfalls. Ideally, footways should be regraded to the back of the footway, but this can add considerably to the cost of works.

In all cases where levels are being altered, careful consideration must be given to adequate drainage of the site, particularly in relation to adjacent properties.

Brett Landscaping 'Kassel' Kerb

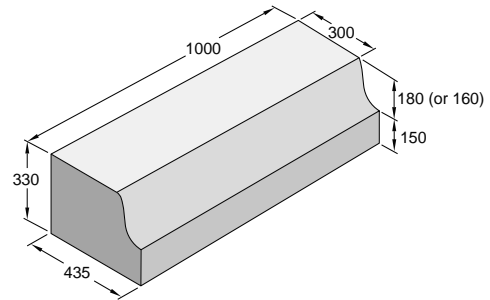

Camas (Charcon) Access Kerb

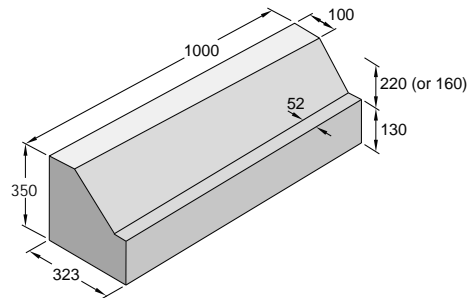

Marshalls Bus Stop Kerb

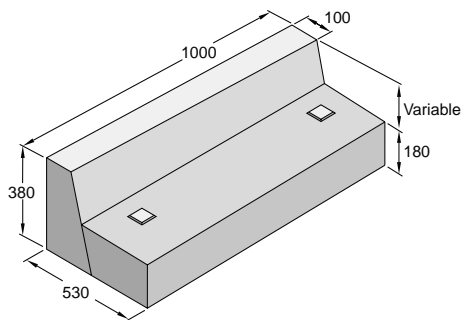

Figure 21: 'Special' kerbs

10. Implementing bus stop improvements

Introduction

Deciding on the location and layout for a bus stop is only the first step in the improvement process. As part of this process designers will need to consider various issues to enable the improvements to be undertaken. These may include:

- Carriageway works;
- Footway works;
- Relocation and position of street furniture e.g. lamp columns, and telephone boxes;
- Statutory undertakers equipment;
- Provision/relocation of bus stop flag, shelter, 'Countdown' display, and ticket machines;
- Traffic Regulation Orders (TROs);
- Planning permission or consents (for bus shelters with advertising and ticket machines);
- Consultation (statutory/public);
- Approval from highway authority and London Buses for works; and
- Power supply for shelter and/or ticket machine.

The amount of work involved in implementing bus stop improvements should not be underestimated. Co-ordinating the various issues identified above can prove difficult and time consuming, especially where multiple agencies are involved.

Timescales

In planning the implementation of improvements, designers will need to take into account the various timescales involved. Planning and co-ordination is vital. The flow chart and Gantt Chart (see Figures 22 and 23) on the following pages show standard tasks undertaken and typical timescales for the types of works normally associated with bus stop improvement works.

Benefits

A well designed bus stop can provide significant benefits. For example, at a stop served by 20 bph, a 2 second saving per bus provides a value of time saving of almost £6,000¹ per annum. At 5 seconds this increases to over £14,000.

Research undertaken by TfL has shown that implementing the types of layouts indicated in previous chapters can make significant time savings (see Appendices B and C) whilst making buses more accessible to all sectors of the population.

Worked examples

To assist designers in the use of these guidelines, some worked examples have been prepared (see Appendix E). These illustrate different types of issues and how the guidelines have been applied in the design solution.

¹ This is calculated using the Transport for London Bus Priority Team Economic Evaluation with 20 bph every day and changing from a 25 second to 23 second journey time.

Stage 1 - Review and Preliminary Design

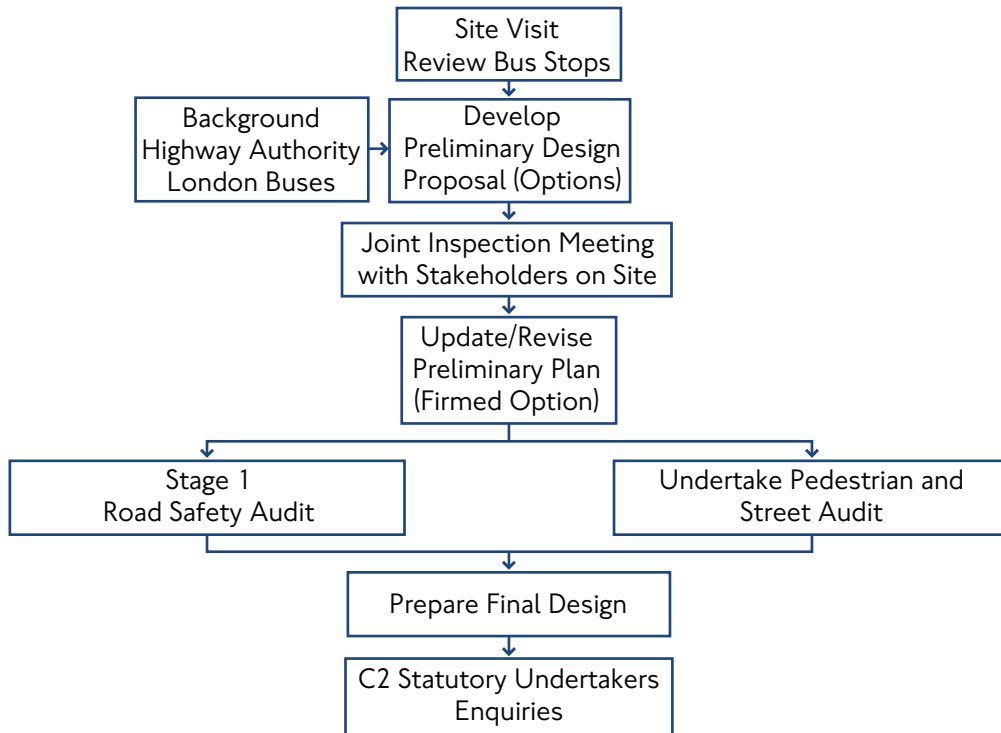

Stage 2 - Consultation and Detailed Design

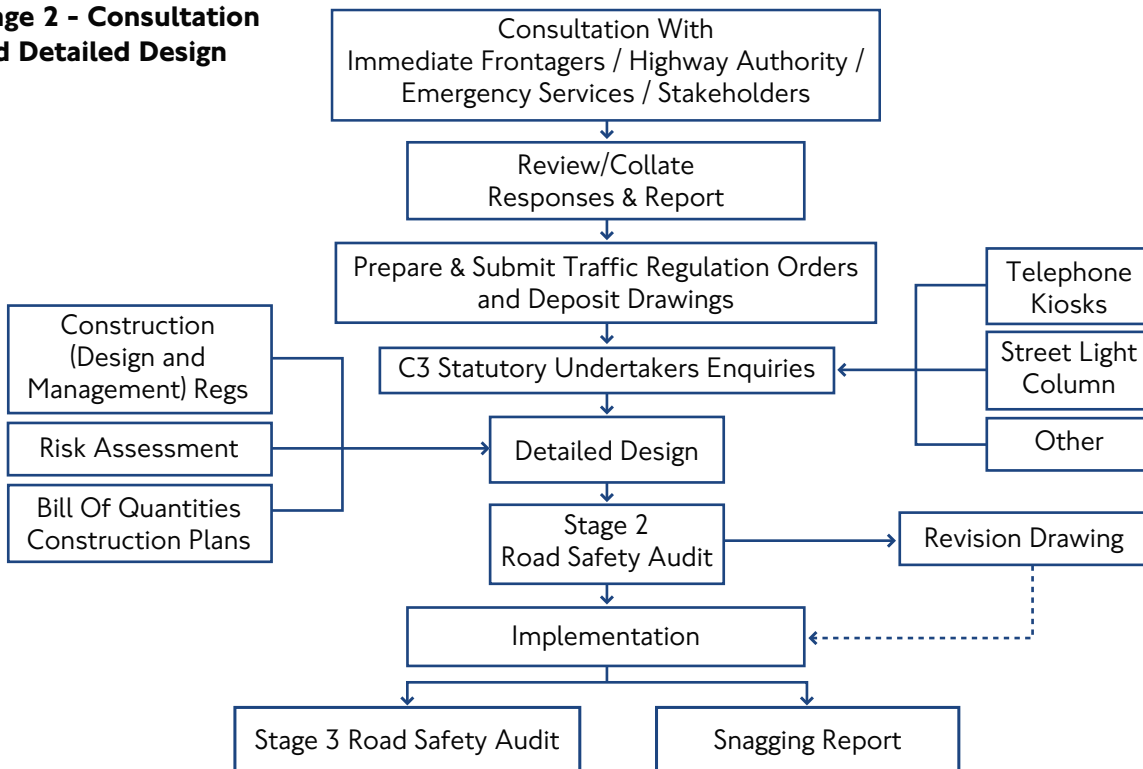

Figure 22: Flow Chart of potential tasks for improving bus stops

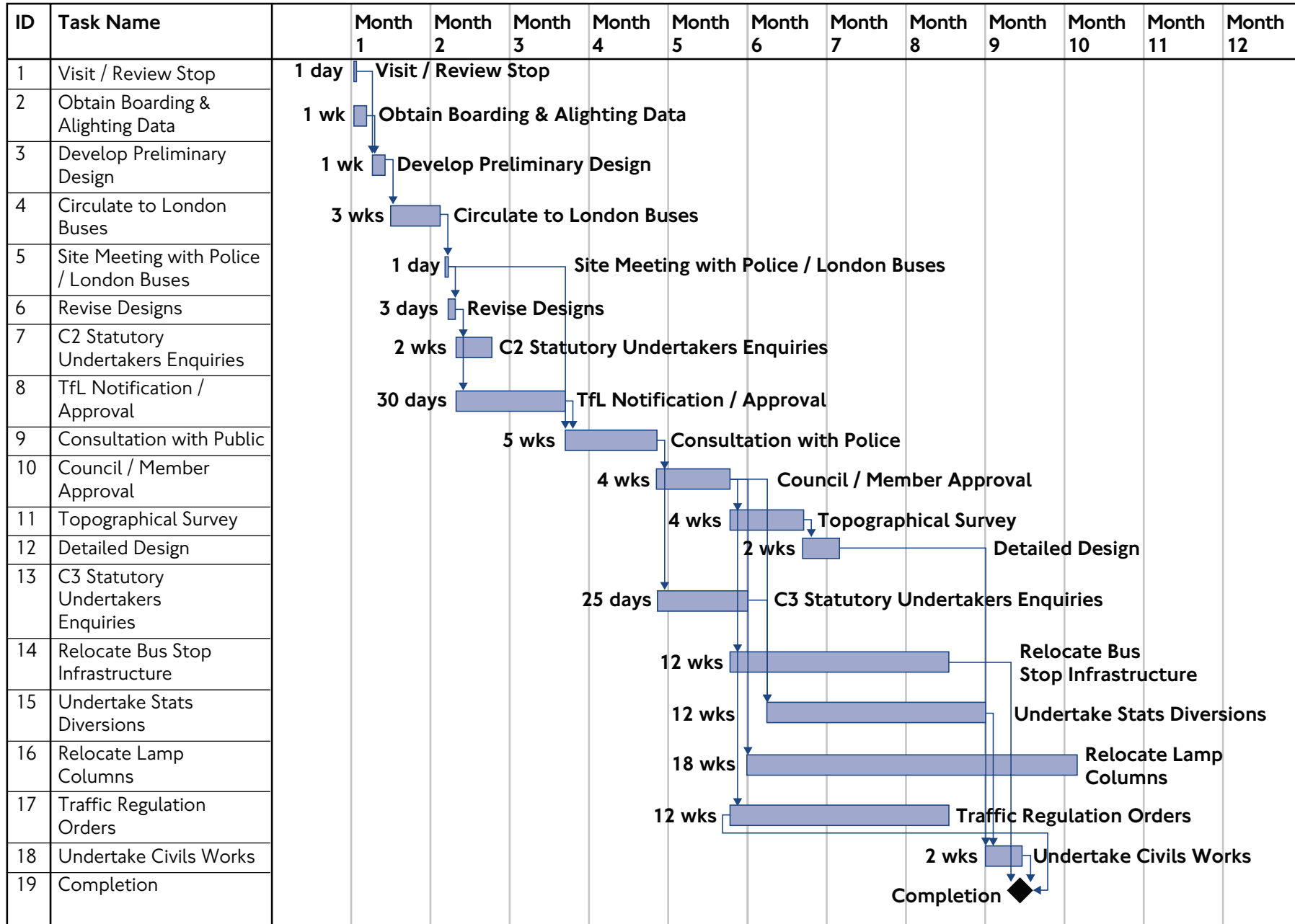

Figure 23: Gantt chart of standard tasks for improving bus stops

11. Longer term issues

Maintenance

Providing facilities for low floor buses is a key stage in delivering a fully accessible bus service. Whilst London Buses is responsible for the bus stop flags and the majority of bus passenger shelters, local highway authorities have responsibilities for maintenance of bus stop areas. This can include street cleaning, maintenance of the footway and carriageway surfaces in the vicinity of the bus stop, and winter maintenance.

The carriageway, and potentially the kerb, in the vicinity of the bus stop are subject to particular stresses from the repeated manoeuvres of buses. Materials used in these areas should be durable and any faults quickly remedied. TfL's Bus Priority Team is currently undertaking trials of new pavement design specifications to reduce carriageway deformation, particularly rutting, at bus stops.

In the course of normal maintenance routines, carriageways will be resurfaced using a variety of methods. During resurfacing it is crucial that the kerb height at bus stops is maintained or improved. It is common for the general level of the carriageway to rise with successive surface repairs. This not only increases stepping heights and ramp gradients, to the detriment of passengers, but also increases crossfalls, causing additional problems for buses.

Enforcement

There have been considerable changes since 2000, notably decriminalisation of Red Route restrictions and Traffic Regulation Orders are no longer required for bus stop clearways. Many boroughs now use CCTV to enforce bus

stop clearways and waiting/loading restrictions, and this can contribute to improved compliance.



Driver training

Whilst this document gives guidance on layouts to make bus stops fully accessible, it is equally important that buses are driven in a manner that fully utilises the facilities offered by the low floor bus and compatible provisions at the kerbside. TfL and operators have implemented extensive guidance and practical training for all drivers. This guidance is supplemented by route specific training to cater for the particular route characteristics.

12. Bibliography

- Barham P. et al. (1994). 'Accessible Public Transport Infrastructure - Guidelines for the Design of Interchanges, Terminals and Stops', Mobility Unit of the Dept. of Environment, Transport and the Regions and the Passenger Transport Executive Group
- Bus Priority Working Group (N.I.) (1997). 'Bus Stops - A Design Guide for Improved Quality', Translink and Dept. of the Environment for Northern Ireland
- Dejeammes M. (1997). 'Accessible Low Floor Bus - System Approach in France', Transportation Research Record 1604, pp 163-169
- Department for Transport (2002). 'The Traffic Signs Regulations and General Directions'
- DETR (1998). 'Guidance on the Use of Tactile Paving Surfaces'
- Disabled Persons Transport Advisory Committee (1997). 'Recommended Specification for Low Floor Buses'
- EC Directorate-General for Transport (1995). 'Low Floor Buses -The Low Floor Bus System Final Report of the Action', COST 322
- Fruin J J (1987). 'Pedestrian Planning and Design'
- Institution of Highways and Transportation (1997). 'Transport in the Urban Environment'
- Lavery I. and Davey S. (1996). 'The Pedestrian Environment - The Achilles' Heel of Travel by Low Floor Bus?', Proceedings of Seminar F, PTRC
- London Bus Priority Network (1996). 'Guidelines for the design of Bus Bays and Bus Stops to accommodate the European standard (12 metre) length bus'
- Oscar Faber (1998). 'Route 43 Quality Bus Service Project - Bus Stop Review - Executive Report'
- Traffic Director for London (1997). 'Implementation of Priority (Red) Routes Standard Construction Details'
- Transport for London (2002), Bus Priority Team. 'Stage 2 Economic Evaluation'
- Transport for London (2005). Streetscape Guidance, Version 1
- York I. and Balcombe R J (1998). 'Evaluation of Low Floor Bus Trials in London and North Tyneside', TRL Report 271

Appendix A - Bus measurements

Vehicle characteristics

The vehicle characteristics to be taken into account include:

- length of vehicle; type of bus i.e. midi, double deck or articulated bus;
- door locations and clear entry and exit widths;
- floor height at doors;
- ramp position and length;
- swept path;
- overhang between nearside of bus bodywork and front nearside tyrewall;
- external clearance height along nearside of bus; and
- ground clearance at points where the bus might potentially overhang the kerb.

The 'standard' bus

Within these guidelines, unless indicated otherwise, the layouts as provided are based upon a 12 metre bus with front and centre doors and a ramp at the centre door. This is to take into account a 'worst case' in the context of potential future operations. Layouts have also been provided for an 18m articulated bus. Figure 24 shows dimensions of a 'standard' rigid bus and an articulated bus.

It is recommended that bus stops are designed, as a minimum, to accommodate the 'standard' bus, with the following range of vehicle dimensions, such that wherever practical, designers can build appropriate dimensional tolerances.

'Standard' rigid bus dimensions

- Width: up to 2.55m
- Length: up to 12.00m

Door dimensions:

- Width: 1.1m
- Distance between doors: (between centre lines of doors) 4.8m to 6.0m
- Length of extended ramp: up to 1.0m

Heights between carriageway surface and bus floor (approximate):

- Front door: 325mm (normal)
240mm (kneeling)
- Centre door: 335mm (normal)
250mm (kneeling)

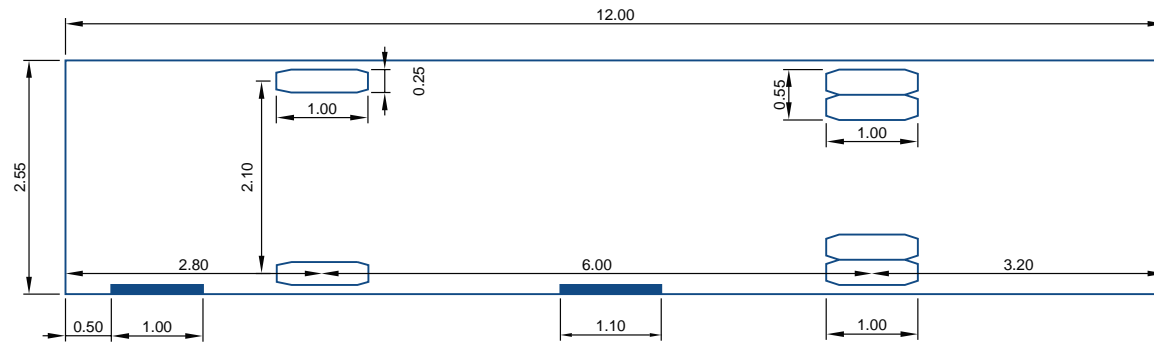

Figure 24.1 : Rigid Bus

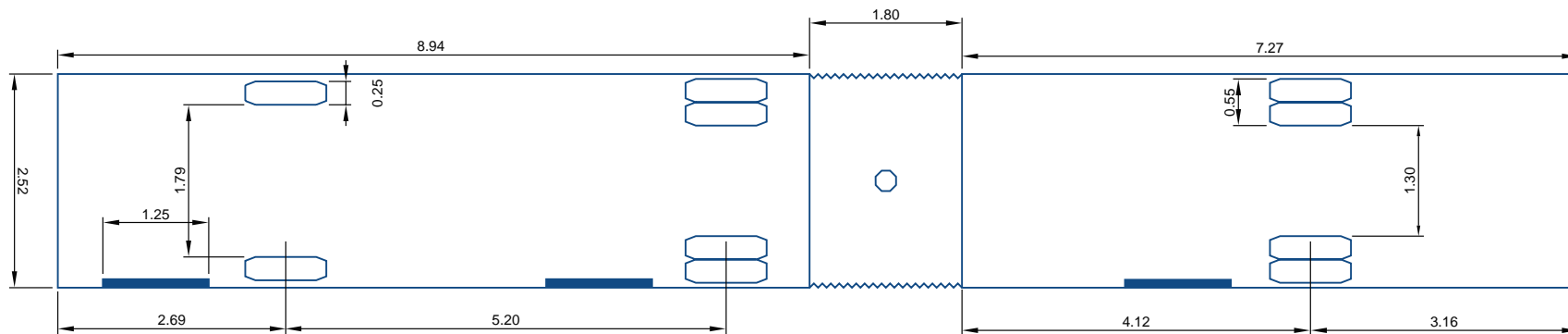

Figure 24.2 : Articulated Bus

All dimensions in metres

Figure 24: Bus dimensions

Chassis	Body	Type	Overall Length	Front Overhang	Wheelbase(s)	Rear Overhang	Overall Height	Floor Height		Approach Angle	Depart Angle	Overall Width	Body Turning Circle
								Laden	Kneeled				
Dennis Dart SLF	Plaxton Pointer 2	Midi bus	8830	2315	3900	2615	2856	325	245	8	8	2402	13140
Dennis Dart SLF	Plaxton Pointer 2	Single Deck	10735	2315	5805	2316	2856	325	245	8	8	2402	19036
Transbus	Enviro 300	Single Deck	12572	2630	6800	3142	2910	325	250	7	7	2550	N/A
Mercedes-Benz Citaro G	Mercedes-Benz	Articulated	17940	2705	5845 (Front) 5990 (Rear)	3400	3074	320	N/A	7	7	2550	22800
Mercedes-Benz Citaro	Mercedes-Benz	Single Deck	11950	2705	5845	3400	3076	320	N/A	7	7	2550	21542
Optare Solo	Optare	Minibus	8500	675	5525	675	2750	265	200	N/A	N/A	2500	N/A
Optare Solo	Optare	Minibus	9200	675	6225	675	2750	265	200	N/A	N/A	2500	N/A
Scania OmniCity	East Lancs	Single Deck	10630	6485	5300	2845	2970	320	N/A	N/A	N/A	2550	N/A
Scania	Omnidekka	Double Deck	10500	2365	5225	2910	4210	315	N/A	7.5	8	2540	20218
DAF DB250	Alexander ALX 400	Double Deck	9790	2375	5448	2375	4340	320	250	N/A	N/A	2550	15900
Volvo B7	Wright Eclipse Gemini	Double Deck	10679	2531	5700	2448	4407	320	250	7.14	7.14	2550	18000

Notes:

All measurements are in mm with the exception of Approach and Depart Angle which are in degrees

All vehicles above are rigid with the exception of the Mercedes-Benz Citaro G which is articulated

Table A1 – Vehicle dimensions for a variety of buses in service in London

Appendix B - Effects of introducing bus boarders

Bus boarders provide a convenient platform for boarding and alighting passengers, and are generally built out from the existing kerb line. They are designed to enable the bus to stop parallel with the kerb, avoiding parked vehicles, and to move off again with an established position in the traffic flow.

The Transport Research Laboratory (TRL) studied the effects of introducing bus boarders on buses, their passengers and other road users. The study comprised a series of 'before' and 'after' surveys, undertaken in May 2002 and May 2003 respectively, at four bus stops where boarders were being introduced:

1. Bryony Road, LB of Hammersmith & Fulham (Full width boarder);
2. South Croxted Road, LB of Southwark (Two half width boarders); and
3. Lupus Street, City of Westminster (Full width boarder).

Data collected during the surveys was analysed with the aim of investigating the following issues:

- Accessibility for passengers;
- The impact on bus journey times;
- The impact on other traffic; and
- The economic impact of the change on road users.

Additionally, Faber Maunsell consultants were commissioned to analyse historical accident data, both 'before' and 'after' the introduction of bus boarders. A total of 23 sites were

investigated, including six angled boarders, twelve half width boarders and five full width boarders.

Results

The study identified the following benefits of introducing a bus boarder:

1. The percentage of buses stopping close to the kerb increased at all four sites. The most pronounced increase occurred at Bryony Road, where initially no buses stopped close to the kerb, but this improved to 95% of buses with the boarder. These results were based on a subjective analysis of the position of the bus in relation to the kerb.
2. Significantly fewer passengers had to step into the road when boarding and alighting at boarder sites leading to improved access to buses, especially for mobility impaired passengers. At three of the sites at least 64% of passengers no longer had to step into the road with the boarder.
3. There was a slight reduction in boarding and alighting times of 0.1 seconds, possibly through improved stop accessibility.
4. Fewer buses (between 5% and 18%) were hemmed in by general traffic at the full width boarder sites.
5. Those buses affected by traffic when pulling away from a stop were delayed by between 0.5 and 2.5 seconds less at the bus boarder than with the original kerbside stop.
6. For all buses, the time taken to leave the bus stop and re-enter the main flow of traffic was 0.6 to 0.8 seconds less after the introduction of a bus boarder.
7. Overall bus delays were reduced by 1.3 seconds on a road operating at 50%

- capacity, and up to 1.8 seconds on a road operating at 70% capacity.
8. At the two sites with parking problems, the number of parked vehicles at the stop decreased significantly (at the 95% confidence level).
 9. There were fewer conflicts between pedestrians and other road users at boarders.

This research indicates that there is a range of benefits for buses and their passengers associated with introducing bus boarders. However, there is a very slight disadvantage to other traffic, which has greater difficulty passing a bus at the stop. This results in increased queuing behind the bus and additional delay to general traffic. On average the additional delay to other vehicles, caused by the bus boarder was between 0.07 seconds and 0.23 seconds per vehicle.

The full report contains an economic assessment which shows that on roads operating at below 50% of link capacity the cost benefit to bus passengers outweighs the disbenefits to other road users. On roads operating at above 50% link capacity an overall benefit may not be achieved. However, the social inclusion benefits offered by the considerable bus stop accessibility improvements have not been quantified and these should not be underestimated.

In examining the road safety impacts of introducing a bus boarder:

1. Overall, there was no statistically significant change in the number of recorded accidents occurring at bus stops at which bus boarders have been implemented.
2. There was a decrease in accidents involving public service vehicles (PSVs) in the vicinity of half-width and full width boarders.

3. In the vicinity of angled boarders an increase in accidents involving PSVs was recorded, although this did not appear to be linked to the introduction of the bus boarder.
4. 'Shunt' type accidents increased in the vicinity of angled boarders.

Conclusions

The introduction of bus boarders greatly improves accessibility for all passengers thereby helping to achieve objectives of social inclusion. Illegal parking is significantly reduced and buses are able to pull away from the stop much more easily, reducing delays.

There are no apparent road safety issues associated with the introduction of half-width and full-width boarders.

It is recommended that on TLRN and borough roads subject to a 30mph speed limit or less, the introduction of bus boarders should be considered at bus stops where:

1. Parked or loading vehicles cause operational problems for buses; or
2. Buses have difficulty rejoining the main traffic flow.

In considering the suitability of constructing a bus boarder, the following characteristics of each stop should be evaluated:

1. Carriageway width;
2. Average traffic flows;
3. Visibility lines;
4. Frequency of bus services; and
5. Presence of a bus lane.

Appendix C – Effects of removing bus lay-bys

Transport for London commissioned The Transport Research Laboratory to study the effects of filling in bus stop lay-bys upon buses, their passengers and other road users. The study comprised a series of 'before' and 'after' surveys, undertaken in May 2002 and May 2003 respectively, at three bus stop sites across London:

1. Albany Road, LB of Southwark
2. Edgware Road, LB of Brent
3. Wandsworth Road, LB of Lambeth

In each of these cases, a bus stop with a lay-by was monitored before works were carried out and after a suitable period to allow traffic patterns to settle. The site was revisited when the lay-by had been infilled to bring the bus stop kerb flush with the edge of the carriageway so that stopped buses remained in the nearside traffic lane. At one site, the stop was located at the nearside of a two lane carriageway, but at the others, there was only a single marked lane in each direction, although in one case this was relatively wide. The data collected during these surveys were analysed with the aim of investigating the following issues:

- The ways in which this affected accessibility for passengers;
- The effects upon bus journey times;
- The effects upon the delays and movements of other traffic;
- The safety implications of the change for all types of road user; and
- The economic impact of the change on road users and others.

The range of traffic flows observed ranged from approximately 38% to 56% of the link capacity. Filling in a bus lay-by and forming a kerbside bus stop was found to provide benefits to bus passengers and buses that varied according to the level of traffic flows on the link. However, stopping the bus in the inside lane reduced the capacity of the link and increased traffic delay, although this is the case at the vast majority of bus stops in London.

Results

The benefits found included the following:

1. Buses were able to stop close to the kerb at virtually all stopping events at two of the survey sites.
2. The improvement of being able to draw close into the kerb was accompanied by fewer passengers needing to step into the road when boarding and alighting, reducing the percentage from between 3% and 24% to, at most, 1%. This could lead to improved access to the buses, especially for passengers with disabilities.
3. Passengers were able to board the buses faster (by 0.5 to 1 seconds per passenger), possibly through this improvement in accessibility. This change represents a reduction of between 12% and 32% in the original boarding times of 2.6 to 3.8 seconds.
4. Fewer buses were hemmed in by traffic, which causes delays when leaving the bus stop. The percentage reduction of buses affected by traffic was between 3% and 13%.
5. Overall the reduction in bus delay at a stop ranged from 2 seconds on a road operating at 50% capacity to 4 seconds on a road operating at 70% capacity.

6. The variation in the stop time of buses was reduced, leading to 95% of buses being stationary in a time band 4 seconds narrower than with a lay-by. Such improvements to the variability in run times can assist in improving reliability of run times over the whole route.
7. Illegal parking at the bus stop was considerably reduced by between 69% and 83% at two of the study sites. At the other site the parking increased, but this was accompanied by a considerable change in traffic patterns.

This research indicates that there was a range of bus passenger benefits associated with filling in bus lay-bys. However, these are counteracted by possible disadvantages for other road users, including increased queuing behind the bus and extra delays. The full report contains an economic assessment which indicates that the cost benefit to bus passengers outweighs the disbenefits to other road users. The degree of the relative advantages and disadvantages will depend on traffic flows and road width at a given site.

Conclusions

Bus stop dwell times are considerably reduced by filling in bus lay-bys. Illegal parking and obstruction of the bus stop is almost eliminated and accessibility for all users is greatly increased, assisting in improving social inclusion.

Policy

- On TLRN roads, TfL will aim to fill in all bus stop lay-bys in the urban environment where the speed limit is 30mph or less, providing there are no prevailing safety issues. Alternatively, the bus stop could be relocated to an appropriate kerbside location.
- On Borough controlled roads, TfL will encourage the relevant highway authorities to follow the policy outlined above for the TLRN.

Appendix D – ‘Special’ kerbs

Contact/product details below:

Company	Product	Contact details
Brett Landscaping Ltd	Kassel Kerbs	Sileby Road Barrow upon Soar Loughborough Leicestershire LE12 8LX Tel: 01509 817187 Fax: 01509 817197 E-mail: landscapinginfo@brett.co.uk www.brett.co.uk/landscaping
Camas (Charcon)	Access Kerb	Hulland Ward Ashbourne, Derbyshire DE6 3ET Tel: 01335 372244 Fax: 01335 370074 www.charcon.com
Marshalls	Bus Stop Kerb	Landscape House Premier Way Lowfields Business Park Elland HX5 9HT Tel: 01422 312000 www.marshalls.co.uk

Appendix E – Worked examples

Bus Stop Name: AMHURST ROAD
Served by: 67, 76, 149, 243, N149, N243,
 40.5 buses per hour
Location: Stoke Newington Road
Direction: Southbound
Highway Authority: Transport for London



BEFORE



AFTER

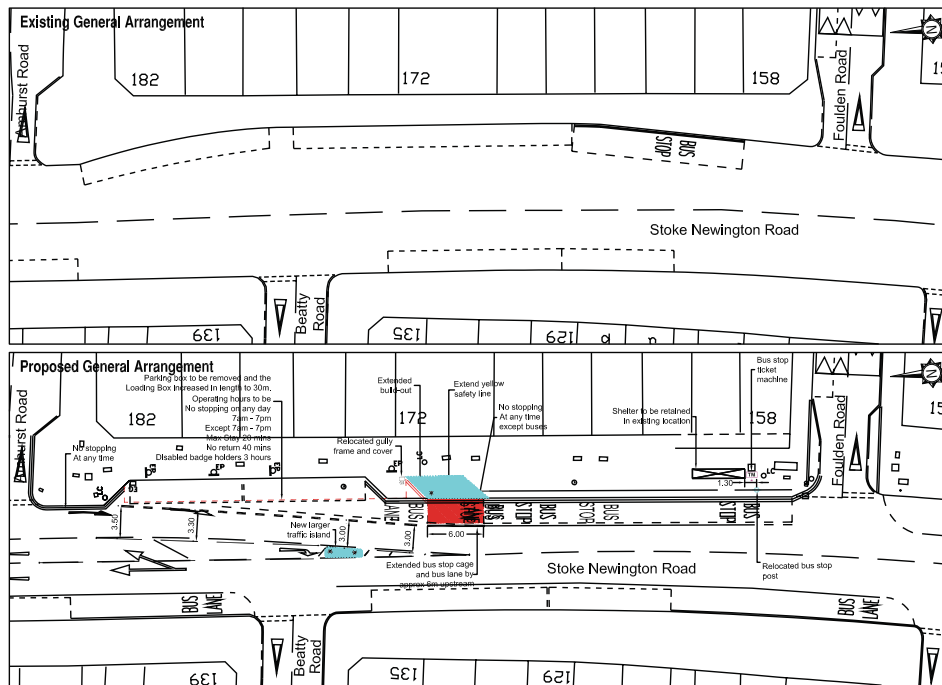

Site Description

- Two-way highway on TLRN
- Various retail frontages
- Bus stop at downstream end of existing lay-by
- Parking and loading bays at upstream end of lay-by

The Issues

- Access to kerbside at bus stop obstructed by parked vehicles
- Angle of kerblines prevents buses from stopping parallel to kerb
- Buses experience difficulty rejoining general traffic flow
- Bus stop clearway too short for frequency of services

The Improvements

- New layout enables more than one bus to serve the stop
- Buses stop in main carriageway and therefore are not delayed leaving the stop
- Part filled lay-by retains 30m parking and loading bay
- Increased footway width provides larger waiting area and allows 'centre of footway' shelter layout
- New 160mm high 'Special' kerbs allow buses to pull in closer to the kerb.
- Bus stop infrastructure renewed

Worked example 1

Bus Stop Name: WHITE HART LANE STATION
Served by: 149, 259, 279, N149, N279
 23.5 buses per hour
Location: High Road, Tottenham
Direction: Southbound
Highway Authority: LB of Haringey



BEFORE



AFTER



Site Description

- Two-way highway on borough road
- Various retail frontages
- Bus stop within existing bus bay

The Issues

- Bus bay attracts illegal parking, preventing access to stop
- Buses experience difficulty rejoining general traffic flow
- Poor layout of bus stop infrastructure prevents more than one bus serving the stop

The Improvements

- New layout enables more than one bus to serve the stop
- Buses stop in main carriageway and therefore are not delayed leaving the stop
- Part filled lay-by retains 15m loading bay
- Increased footway width provides larger waiting area
- Bus stop infrastructure renewed

Acknowledgements

The drafting and production of this document has involved the co-operation, input and consultation with a number of individuals and organisations. The main contributing organisations are identified below:

- Transport for London, Surface Transport, Bus Priority Team;
- Transport for London, Surface Transport, London Buses;
- Transport for London, Equality and Inclusion;
- London Bus Priority Network (LBPN);
- Faber Maunsell, St Albans.

Further information

For further details or advice on the design of accessible bus stops, contact:

Bus Priority Team

Transport for London

Windsor House, 42-50 Victoria Street

London, SW1H 0TL

Tel 0845 300 7000

Website: www.tfl.gov.uk