

A Practical Guide for Integrated Weed Management in Mid-Atlantic Grain Crops

A collaboration among:
Penn State, Rutgers University, University of Delaware
USDA-Beltsville, Virginia Tech, West Virginia University



More information on integrated weed management can be found at
growIWM.org

Editor

Mark VanGessel, University of Delaware

Authors and Contributors

Victoria Ackroyd, USDA-Beltsville

Thierry Besançon, Rutgers University

Jess Bunchek, Penn State

Charlie Cahoon, North Carolina State University (formerly Virginia Tech)

Rakesh Chandran, West Virginia University

William Curran, Penn State (retired)

Michael Flessner, Virginia Tech

Annie Klodd, University of Minnesota (formerly Penn State)

Dwight Lingenfelter, Penn State

Steven Mirsky, USDA-Beltsville

Matthew Ryan, Cornell University

David Sandy (formerly Penn State)

Mark VanGessel, University of Delaware

Kurt Vollmer, University of Delaware

Meredith Ward (formerly Penn State)

Technical Editor

Elise Brown, Root 61 Communications

Funding and Support

This publication was funded by the Northeastern IPM Center through Grant #2014-70006-22484 from the National Institute of Food and Agriculture, Crop Protection and Pest Management, Regional Coordination Program.



United States Department of Agriculture
National Institute of Food and Agriculture

Revised Sept. 2019

Table of Contents

Chapter 1: An Introduction to Integrated Weed Management.....	1
Chapter 2: Identification and Characteristics of Weeds.....	4
Chapter 3: Weed Emergence, Seedbank Dynamics, and Weed Communities.....	13
Chapter 4: Weed Scouting and Mapping.....	22
Chapter 5: Concept of Weed Thresholds.....	28
Chapter 6: Weed Prevention.....	34
Chapter 7: Chemical Control: Herbicide Management Issues.....	38
Chapter 8: Weed Resistance to Herbicides.....	52
Chapter 9: Biological Weed Control.....	63
Chapter 10: Cultural Control.....	72
Chapter 11: Thermal Weed Control.....	82
Chapter 12: Cover Crops for Weed Suppression.....	85
Chapter 13: Mechanical Weed Control: Pre-Plant.....	96
Chapter 14: Mechanical Weed Control: Post-Plant.....	107
Chapter 15: Harvest Weed Seed Control.....	119
Chapter 16: Coordinating Integrated Weed Management Tactics, A Scenario.....	128
Glossary.....	136
Appendix 1. Plant Descriptions.....	142
Appendix 2. Weed Identification Resources.....	143

Chapter 1: An Introduction to Integrated Weed Management

Annie Klodd and Mark VanGessel

Summary

Weed control includes tactics such as herbicides, cultivation, or flaming. Weed control is usually immediate and often does not require long-term planning. On the other hand, integrated weed management includes a wider range of tactics, many which do not cause immediate plant death. Instead, they place the weed at a competitive disadvantage. Integrated weed management uses multiple strategies, reducing the emphasis of any one tactic and providing more consistent results over a wider range of environmental conditions.

Introduction

W*eed control and weed management* are terms that are often used interchangeably, but they are actually two different approaches to prevent weed interference on crop production. Weed control involves killing weeds with tools or tactics that have an immediate impact. Weed management involves a longer time frame (the entire growing season or longer) and a combination of tactics to lessen or eliminate the effects of weeds on crop growth. The crop is managed in a manner that allows it to capture sunlight, moisture, or nutrients and improve the crop's competitiveness with weeds.

Integrated weed management (IWM) combines various methods to reduce or eliminate the effect of weeds on crop production over time, using a combination of practices that are most effective for solving specific weed issues. These weed management techniques form a "toolbox" in which "tools" can be integrated into a weed management plan catered to the particular farm and problem. The toolbox includes preventative, biological, chemical, cultural, and mechanical strategies. IWM also considers the weed species present and tailors strategies for these species.

There are many reasons for implementing IWM. Sometimes farmers do not want to use herbicides. Crops may have limited herbicide options, or the weeds that need managed have poor or no herbicide options (including herbicide-resistant biotypes). Reducing the reliance on herbicides for weed can also reduce the risk of selecting for herbicide-resistant weeds. Farmers need to determine their objectives when implementing IWM and use tactics that will help them meet those objectives.

In conventional crops, integrated weed management is not a replacement for herbicides. For many decades, herbicides have been the primary means of weed management in conventional crops due to their simplicity, effectiveness, and affordability. However, relying too much on a few herbicides has led to an increase of weed species that are not effectively controlled with the herbicide program or selecting for herbicide-resistant biotypes. IWM approaches go beyond relying merely on herbicide rotation and mixtures. IWM programs use all available methods that will best solve the problem. In many cases with conventional crops, herbicides are part of this solution.

IWM tactics span a wide range of types and complexity (Figure 1.1). IWM has the biggest impact when these tactics overlap and complement one another. Examples include equipment cleaning, timely scouting, altering herbicide tank-mixtures, rotating herbicides, using cover crops, changing tillage practices, using narrow row spacing, and hand-pulling weeds.

Some IWM practices are capable of actively controlling growing weeds, such as herbicides, cultivation, tillage, or biological agents. Others such as cover crops or cultural practices are passive in nature, with an indirect effect on the weeds. The tactics that have an indirect effect requires advanced planning and need to be implemented before the weeds germinate or emerge.

Agronomic practices that favor a quick crop canopy to shade the ground or weed seedlings are very important, including narrow row spacing, crop varieties with early-season vigor, and altering planting dates. Understanding how these practices fit together leads to well informed decisions and allows for small management adjustments that can significantly impact weed management.

IWM needs to have a longer view for weed management than simply a one year approach. IWM is not only concerned with weed control for the short term, but implementing management practices that will impact weed management over sequential seasons. In addition, a comprehensive IWM approach will also anticipate potential weed problems and changes will be made to prevent them from developing.

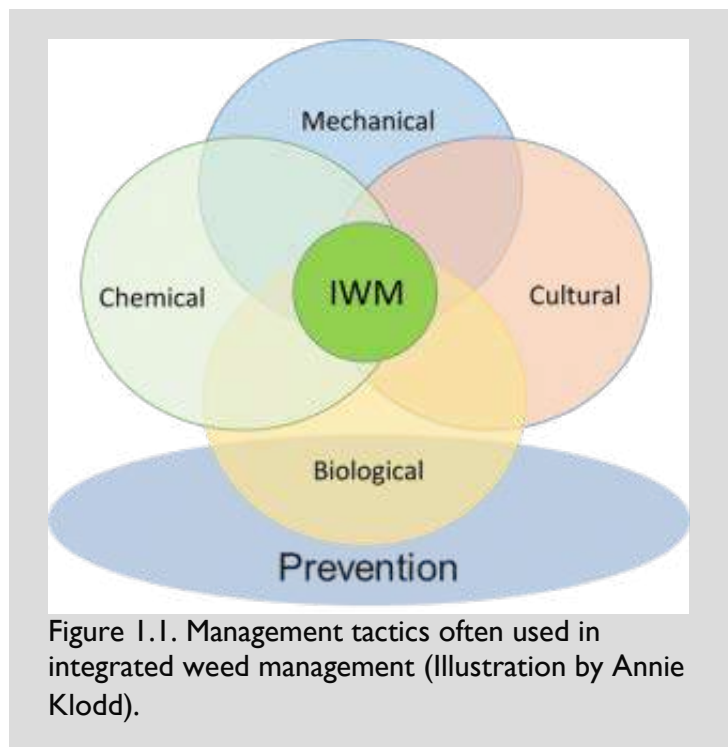

As the level of IWM increases, tactics tends to be more site specific compared weed programs that rely heavily on herbicides. Differences from field to field, as well as within fields, requires a better understanding of weed biology and the influence of cultural practices on crop and weed growth. Understanding these relationships will allow an expanded use of IWM and reduce the reliance upon herbicides and in turn, reduce selection pressure for herbicide resistance.

There is a continuum of intensity for IWM. Some farmers may focus on only a few IWM tactics and have a low level of IWM utilization. Understanding how tactics or practices can complement one another will maximize their effectiveness and increase the level of IWM utilization. High IWM utilization lessens the risk of weed seed production without relying on only one tactic. Relying on only one tactic often results in one (or a few) weed species producing seed and increasing in density. This phenomena is often referred to as *selection pressure* and *species shift*. Anticipating potential species shifts and taking steps to prevent them from occurring is important for the long-term IWM success.

Key Points

- Weed control involves tactics that cause immediate plant death and does not require long-term planning.
- Integrated weed management focuses on reducing the growth and vigor of weeds and allowing the crop to outcompete weeds.
- Agronomic practices that favor a quick crop canopy to shade the ground or weed seedlings are critical for successful IWM programs.
- Integrated weed management requires advance planning as well as a long-term view to anticipate weed management over sequential seasons.

Chapter 2: Identification and Characteristics of Weeds

Michael Flessner

Summary

Weed identification is essential for development of a successful management plan. Identification of all weeds present lends information on how to best manage individual weeds and the weed population as a whole. Similarly, knowledge of weed characteristics allow farmers to exploit weaknesses of a weed when making management decisions. It is important to have resources available to aid in weed identification efforts.

Introduction

The first step to planning a successful weed management program is weed identification. Weeds vary widely in their responses to individual management tactics. Without proper identification of all weeds present in the field, control measures are likely to fail (Ross and Lembi 1985). Correctly identified, characteristics of each weed can be used to better manage both individual weeds and the overall weed population. For example, a weed's life cycle (annual, biennial, or perennial) can drastically influence the effectiveness of a herbicide application. A weed's germination period can be used to change tillage operations in a stale seed bed approach or alter planting date to avoid weed competition.

Weed Identification Resources

In practice, weed identification can be very difficult. A weed's appearance can vary greatly among different growth stages and environments. There are a number of excellent resources available, many of which are available online free of charge. Local Extension educators, agricultural professionals, and neighbors also can be good resources. Weed identification is important to successfully implement crop scouting (see Chapter 4: *Weed Scouting and Mapping*). See Appendix 2 for a list of weed identification resources.

Weed control is most successful when weeds are in the seedling stage, but identifying plants at this stage can be challenging. Having a variety of weed identification resources is important. Some basic features used for identifying monocots (grasses and sedges) and dicot (broadleaves) are included in Appendix 1.

Characteristics of Weeds

Most plants are not weeds. A weed is simply an undesirable plant. One person's weed may be another person's flower. Therefore, designating a plant as a weed is somewhat arbitrary. Worldwide, only about 250 species (0.1% of all plants) are economically important weeds. A weed's appearance can vary greatly among different growth stages and environments.

Certain traits allow a plant to behave as a weed. Weeds possess one or more of the following characteristics:

Abundant seed production

Most weeds, especially annuals, are prolific seed producers (Table 2.1).

Rapid population establishment

Weeds can germinate and establish quickly, especially under favorable weather conditions. Left unchecked, weeds outcompete crops. Even under unfavorable environmental conditions, weeds can produce viable seed in as little as six weeks.

Adapted to a range of conditions

Weeds are capable of adapting to their environment and may develop differently in different environments. For instance, when grown in low light environment, plants often grow taller but thinner; emerging late in their life-cycle they enter reproduction phase soon after emergence. This phenomena is known as phenotypic plasticity.

Seed dormancy

Various mechanisms of seed dormancy ensure a weed does not germinate under unfavorable environmental conditions. Seed dormancy also ensures that not all of a weed population germinates at the same time, which results in weed emergence over a prolong period of time.

Long-term survival of buried seed

Most seeds live for less than three or four years due to germination, predation, decomposition, and other factors. However, there are some weed seeds that can remain viable for many years if left undisturbed (Figure 2.1 and Table 2.2).

Table 2.1. Seed production from various weed species. Adapted from Ross and Lembi 1985.

Weed	Approximate number of seeds per plant
Barnyardgrass	7,000
Giant foxtail	10,000
Common ragweed	15,000
Velvetleaf	17,000
Curly dock	40,000
Common lambsquarters	72,000
Redroot pigweed	117,000
Horseweed	200,000*
Palmer amaranth	600,000

*Bhowmik and Bekech, 1993

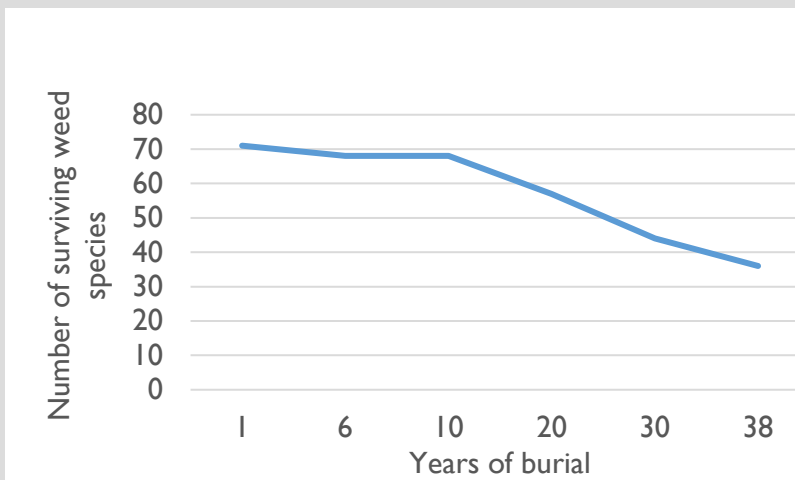

Figure 2.1. Long-term survival of buried weed seed. Data interpretation continues in Table 2.2. Adapted from Klingman et al. 1975.

Table 2.2. After 38 years of burial, the following weeds species germinated. Adapted from Klingman et al. 1975.

Weed species	% seed germinated
Jimsonweed	91
Common mullein	48
Velvetleaf	38
Evening primrose	17
Common lambsquarters	7
Green foxtail	1
Curly dock	1

Adaptation for spread

Weed seeds spread by natural forces, such as wind and water, or by clinging to animals (Photo 2.1). Weed seed also can be spread by passing through the gut of animals. For example, Palmer amaranth can remain viable after passing through deer and has been found in the guts of 11 different bird species including migratory birds (DeVlaming and Vernon 1968; Farmer et al. 2017; Proctor 1968).



Photo 2.1 Seed adaptations for spread. Left: curly dock seed floats allowing dispersal on water; Center: common milkweed seed is adapted for dispersal by the wind; and Right: common cocklebur seed adapted for spread by clinging to animal fur or clothing (Photo credit: Virginia Tech, Weed Science).

Weeds are also spread by farm equipment (Ross and Lembi 1985). Some weed species keep their seed attached to the plant through crop maturity making them more likely to be spread by harvest equipment. Mowers and tillage equipment also commonly spread weed seeds (See Chapter 6: *Prevention of Weeds*).

Vegetative reproductive structures

Unlike annual weeds, many perennial weeds possess special vegetative structures that allow them to reproduce without seed. These perennial structures contain food reserves and have numerous buds (meristem tissue) in which new plants can arise. Examples of these vegetative reproductive structures are shown in Photo 2.2.



Photo 2.2. Perennial reproductive structures. Top left: stolons are aboveground horizontal stems that root at the buds (bermudagrass); top center: rhizomes are below ground thickened stems that grow horizontally near the soil surface (quackgrass); top right: tubers are starch storage structure at or below the soil surface that produce new shoots (yellow nutsedge); bottom left: thickened root adapted to spread and produce new stems (hemp dogbane); and bottom right: bulbs are modified leaf tissue located at the base of the stem and produce new shoots (grape hyacinth) (Yellow nutsedge photo credit: R. Prostak, Univ of Mass; all other photos Virginia Tech, Weed Science).

In addition to these vegetative reproductive structures, many perennials reproduce by seed. Some depend heavily on reproduction by seed (e.g. dandelion), while for others it is less important (e.g. yellow nutsedge).

Classification of Weeds by Life Cycle

While weeds can be classified in many ways, a weed's life cycle is the most prominent factor guiding an effective weed management program, as a weed's susceptibility to a management tactic varies by life cycle and time of year. All life cycles include both monocots (grasses and sedges) and dicots (broadleaves) (Photo 2.3).

Annual

Annual weeds germinate, produce seed, and die in less than one year (Photo 2.3; Table 2.3). Annuals are competitive in disturbed sites common in annual cropping systems, such as tilled fields or those treated with a non-selective herbicide. Annuals also are competitive in perennial cropping systems during the crop's dormant period, such as the winter for alfalfa. Annual species seldom germinate at one time; they often germinate over extended time period as separate "flushes" or cohorts.



Photo 2.3. Examples of annual weed growth stages (Photo credits: Virginia Tech, Weed Science).

Winter annual weeds typically germinate from late summer or fall to early spring, but they complete their life cycle within a year. Some winter annual weeds, such as horseweed (also known as marestail), can germinate in the fall and early summer.

Summer annual weeds germinate in late spring or summer. Summer annuals that germinate in the mid to late summer will produce flowers in a very short timeframe. It is not uncommon for weeds emerging in August to produce a flower within four weeks of emergence.

Biennial

A biennial weed completes its life cycle in two years (Table 2.3). Germination and establishment occur in the first year and results in a rosette growth stage (Photo 2.4), which is the most effective time for most weed control tactics. In the second year, the weed flowers, produces seed, and dies. Biennials start each life cycle from seed and are most competitive in areas of infrequent management such as roadsides, pastures, or hayfields.



Seedling

Rosette

Mature

Photo 2.4. Common burdock, a biennial weed, at various growth stages (Photo credit: Virginia Tech, Weed Science).

Perennial

Perennial weeds live for longer than two years and may live indefinitely. Some species are classified as perennials, but seldom live longer than one year and are often referred to as short-lived perennials. Perennials have various structures (often underground structures) that the plant can use to regenerate each year (see Photo 2.2). The spread of some species is not as dependent upon seed, as annuals or biennials. Perennial weeds often more common in perennial crops such as alfalfa and grass forages due to a less disturbed environment. Once established in no-till or perennial systems common in the Mid-Atlantic, perennial weeds can be difficult to control; successful control requires killing both underground structures and aboveground vegetation.

Perennial weeds can be divided into two groups: simple and creeping. Simple perennials form a deep taproot and spread primarily by seed dispersal. Creeping perennials may be either herbaceous or woody and can spread by both seed and vegetative structures, such as rhizomes or stolons (Photo 2.2).

Perennial species emerging from seeds can quickly develop their perennial vegetative and reproductive structures. Some species begin to develop their structures as soon as four weeks after emergence (Bhowmik 1994; Donald 1994).

Table 2.3. Examples of common weeds classified by life cycle.

Annuals		Biennials	Simple	Perennials	
Winter	Summer			Herbaceous	Creeping Woody
<i>Grasses</i>					
annual bluegrass	crabgrass	common burdock	chicory	Canada thistle	brambles
annual ryegrass	foxtails	poison hemlock	common pokeweed	common milkweed	multiflora rose
cheat	barnyardgrass	teasel	curly dock	horsenettle	ground ivy
downy brome	goosegrass	bull thistle	dandelion	hemp dogbane	Japanese knotweed
	fall panicum	wild carrot	plantain	johnsongrass	bamboo
<i>Broadleaves</i>					
common chickweed	common cocklebur			quackgrass	poison ivy
henbit	common lambsquarters			yellow nutsedge	Virginia creeper
horseweed or maretail	common ragweed				
mustards	pigweeds				

Most Effective Weed Control Timings and Methods Based on Life Cycle

The effectiveness of a weed control practice depends on the life cycle of the weed and the growth stage targeted. Annual weeds, as well as biennials and perennials reproducing from seed, are most effectively controlled when the weed is young and actively growing. At this time, it is generally susceptible to many control tactics, including tillage, herbicides, flaming, and others. Once an annual weed flowers, it is much harder control and it is difficult to stop viable seed production.

Biennial weeds are most susceptible when young and actively growing or in the rosette stage (Photo 2.4).

Established perennial weeds are generally most susceptible to herbicides once energy reserves in their underground structures have been depleted. Herbicide should be applied to most established perennials during the early-budding (just prior to flowering) to flowering stage. Alternatively, autumn applications take advantage of the plant's carbohydrate movement from foliage to underground storage structures. Mowing established perennials requires multiple and consistent cuttings to effectively starve the plant (see Chapter 13: *Pre- and Post-Plant Mechanical Weed Control*).

Key Points

- Weed identification is essential for development of a successful management plan.
- Weeds have many characteristics that make them successful in our cropping systems.
- The life cycle and growth stage of a weed largely determines optimum timing of control strategies.
- Weeds emerging from seed are most susceptible to control tactics while young and actively growing.
- Established perennial weeds are difficult to control and generally require multiple, sequential, and well-timed control tactics.
- Successful control of established perennial weeds requires depleting food reserves in underground vegetative structures.

References

- Bhowmik PC (1994) Biology and control of common milkweed (*Asclepias syriaca*). Rev Weed Sci 6:227-250
- Bhowmik PC, Bekech MM (1993) Horseweed (*Conyza canadensis*) seed production, emergence, and distribution in no-tillage and conventional-tillage corn (*Zea mays*). Agron Trends Agric Sci 1:67-71
- DeVlaming V, Vernon WP (1968) Dispersal of aquatic organisms: viability of seeds recovered from other droppings of captive killdeer and mallard ducks. Am J Bot 55:20-26
- Donald WW (1994) The biology of Canada thistle (*Cirsium arvense*). Rev Weed Sci 6:77-101
- Farmer JA, Webb EB, Pierce RA, Bradley KW (2017) Evaluating the potential for weed seed dispersal based on waterfowl consumption and seed viability. Pest Manag Sci 73:2592:2603 doi:10.1002/ps.4710
- Klingman GC, Ashton FM (1975) Weed Science: Principles and Practices. New York: John Wiley & Sons, Inc. Pp 41
- Proctor VW (1968) Long-distance dispersal of seeds by retention in digestive tract of birds. Science 160:321-322

Ross MA, Lembi CA (1985) Applied Weed Science. Minneapolis, MN: Burgess Publishing Company. Pp 6, 215, 222

Chapter 3: Weed Emergence, Seedbank Dynamics, and Weed Communities

Mark VanGessel

Summary

“Soil seedbank” is a term used for weed seeds present in the soil. The soil seedbank is in constant change in response to influences such as weed seed germination, seed decay, cropping practices, weed management, and weed seed production. Timing of weed emergence greatly impacts weed growth, weed competition, and crop production. Farmers have little control over when weeds emerge in their fields; however through understanding weed emergence timing and seedbank dynamics, they can make weed control decisions based on weed biology.

Introduction

When weeds emerge from the soil, they remain in the same field, and deposit most of their seeds back into the soil. The propagules (seeds or vegetative reproductive structures) can be spread from field to field, but the weed’s life cycle starts in the soil. Weed seed germination is the sprouting of the seed followed by the seedling emergence from the soil. Emergence occurs when the seedling emerges from the soil with the hypocotyl (stem below the first leaves) and cotyledons (the first leaves to develop, often different shapes than later developing leaves). Seedlings grow and develop by producing new leaves and stems and expanding their root systems. A mature plant produces flowers, forms seeds, and eventually dies (or senesces).

Environmental cues and ecological factors affect weed emergence, which does not occur uniformly over a field, nor is the process the same for all weed species. Weed seed germination and emergence depend on many complex, interrelated processes. These processes include depth of the seeds in the soil, seed dormancy, soil temperature, moisture level, exposure to light, tillage intensity and timing, and crop residue or vegetation cover.

Soil Seedbank

The number of weed seeds in the soil fluctuates over time. Weed seeds are deposited into the soil from a variety of sources. Not all seeds in the soil will germinate

and develop into mature plants that produce more seeds. Seeds are lost through many ecological processes (Figure 3.1). This process of deposition and withdrawal (or loss) from the soil is referred to as the “weed seedbank” or “soil seedbank.”

Studies have been done to estimate number of seeds in the seedbank. A survey examining weed seed density in agricultural fields ranged from 2.5 million to 645 million seeds per acre at eight sites in the northcentral region of the USA (Forcella et al. 1992). It should be noted that 100 million seeds per acre was the second highest density. A sample of 58 fields throughout England, mostly used for vegetable production, had a range of 6.5 million to 348 million seeds per acre (Roberts and Stokes 1966), with half of the fields having a density of 25 to 90 million seeds per acre. Roberts (1983) summarized six additional studies from Europe, representing 310 fields, averaging 91 million seeds per acre. The extremes were 2 million to 2 billion seeds per acre. It should be noted that 90 million seeds per acre is approximately 2000 seeds per ft².

Seeds are deposited from a wide range of sources. “Seed rain” describes the process of seeds falling from weeds and entering the seedbank. New weed species are introduced into a field through many different mechanisms such as wind, runoff water, wildlife, or as a contaminant (see Chapter 6: *Prevention of Weeds*).

The primary source of seeds entering the soil seedbank is uncontrolled plants in the field. The number of seeds introduced into a field from outside sources can vary from a few seeds that are deposited from equipment or wildlife to millions of wind-blown seeds moving into a field from an adjacent field. For example, a single horseweed (or marestail) plant can produce 200,000 wind-blown seeds that can move long distances with a slight breeze (Table 2.1) (Dauer et al. 2008)

Age of weed seeds in the seedbanks will vary greatly. It is estimated that less than 10% of the viable seeds in the seedbank will germinate in a given year; however, many of the seeds that do germinate were deposited the previous year. Some seeds were deposited many years previously and have remained dormant in the soil.

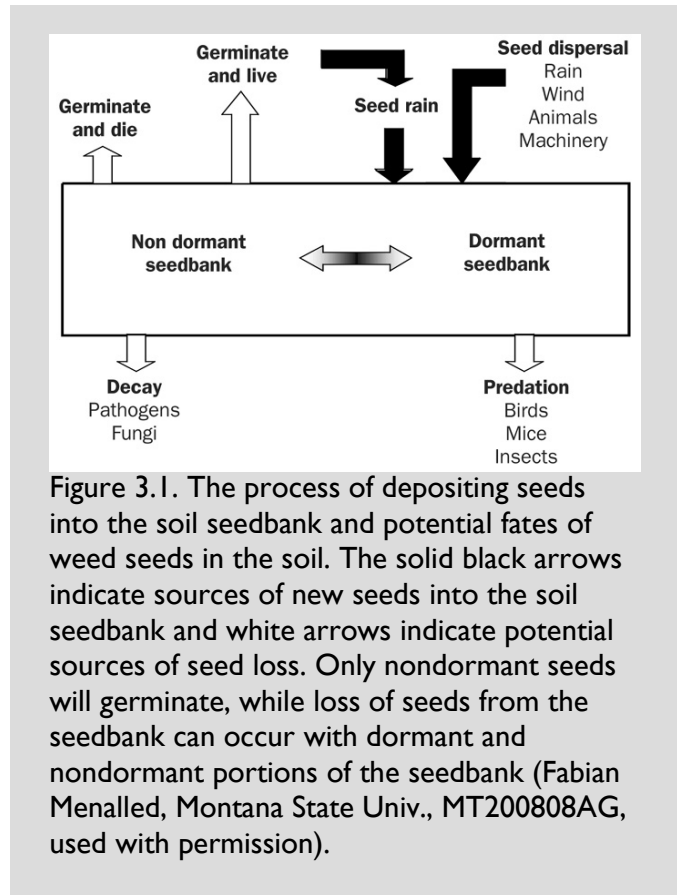

Reducing the number of seeds deposited into the soil is one mechanism for reducing the size of the weed seedbank, which then reduce the number of weeds that emerge.

Dramatically reducing weed seed rain for one year can decrease weed densities the following year. Research which has eliminated the seed production of common lambsquarters and smooth pigweed in a single year significantly reduced the number of weed seedlings that emerge the following year (Teasdale et al. 2004). Sustained efforts to achieve excellent weed control over a six-year period have resulted in reducing redroot pigweed and common lambsquarters seeds in the soil by over 95% (Schweizer and Zimdahl 1983, 1984). Excellent weed control with chemical, mechanical, and cultural tactics will result in few to no weed seeds deposited in the soil. However, for situations where weed control is poor and weeds are present late in the season, researchers are investigating the feasibility of killing weed seeds at harvest as a method of reducing the number of seeds that enter the seedbank (see Chapter 14: *Harvest Weed Seed Control*).

Dormancy

Dormancy is an evolutionary trait that increases the likelihood of a species to continue its existence in a field. Seeds are able to survive for more than one year in the weed seedbank through dormancy. Dormancy is a complex mechanism that prevents a weed seed from germinating under conditions normally favorable for seedling growth. Chemical, physical, and environmental cues influence dormancy. Weeds can remain dormant in the soil seedbank for 2 to over 25 years, depending on the species.

Seed loss from seedbank

Seeds are withdrawn (or lost) from the soil seedbank through a number of processes (Figure 3.1), including seed germination and seedling establishment, fatal seed germination (seeds germinate but are unable to emerge from the soil), seed decay, ingestion by vertebrates and invertebrates, soil erosion or water runoff. The number of weed seeds in the seedbank declines more rapidly when the fields are tilled than in fields with no soil disturbance. This is presumably due to a higher percentage of seeds germinating as a result of tillage (Roberts and Dawkins, 1967; Roberts and Feast, 1973). The tillage operation allows for greater exchange of gases, seed coat abrasion or scarification, exposure to light, improved seed to soil contact, and soil warming, all factors that can stimulate seed germination.

Weed Seedling Emergence

While weed species are classified by their life cycles and season of emergence (for instance, summer annual or winter annual) there are variations in emergence timing (See Chapter 2: *Identification and Characteristics of Weeds*). Soil temperature appears to play the major role in determining weed emergence timing. The soil

temperature around the seed can be influenced by a number of factors, including sunlight, soil texture, soil cover, soil density, soil moisture, and depth within the soil. There is a minimum temperature at which seeds start biological and chemical activity (often referred to as base temperature) and a higher temperature that at which these activities stop. These threshold temperatures vary by species. Temperature fluctuations from daytime to nighttime can also play a role in breaking dormancy, leading to seed germination and emergence. The environmental conditions during seed development also influence germination, as they can impact weed seed coat hardness, which in turn influences the ability of seeds to absorb moisture and resist seed coat abrasions.

Even if germination occurs, seedlings will only emerge if the seed is at the right depth in the soil. Generally, species with small seeds will only emerge from a soil depth of less than one inch. For instance, horseweed seeds are very small and need to be right at the soil surface to emerge. Species with large seeds, such as ivyleaf morningglory or Texas panicum, can emerge from depths greater than two inches. While a deep burial of weed seeds can prevent seedlings from emerging, it also can lengthen the time seeds remain viable because they are not exposed to predation or fluctuation in soil temperature and moisture.

Tillage systems greatly influence the depth at which weed seeds are buried (Figure 3.2). In no-till systems, seeds remain at or near the soil surface. With chisel plowed systems, weed seeds are concentrated in the top two inches while moldboard plowing buries weed seeds deeper than four inches. However, repeated moldboard plowing will result in fairly uniform seed distribution throughout the plow layer. Weed communities can change rapidly in response to tillage systems. For example, common lambsquarters density increased rapidly in no-till systems compared to moldboard plowed systems (Teasdale et al. 1991) (see Chapter 13: *Pre- and Post-Plant Mechanical Weed Control*). Likewise, moldboard plowing has the potential to bury the majority of seeds and dramatically reduce the number of weed seeds at the soil surface (Farmer et al. 2017).

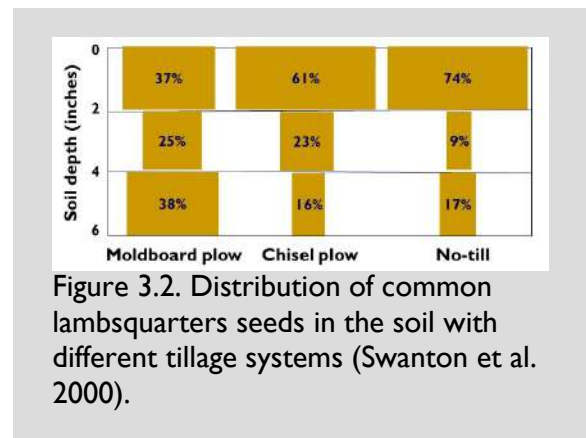

For example of how to use weed emergence patterns in IWM, consider a field with common ragweed and giant foxtail (Figure 3.3). Delaying planting until late May after common ragweed emergence has peaked will result in a lower plant density. On the other hand, giant foxtail emerges throughout the summer and delayed planting will not be an effective strategy.

Weeds that emerge within the same time period are called a cohort or flush of weeds. As shown in Figure 3.3 the plants emerging in early May form one cohort. Large crabgrass, giant foxtail, redroot pigweed and common lambsquarters often emerges in July forming another cohort.

As a group, winter annuals emerge over a longer time period than summer annuals, because the winter annuals emerge in the fall and/or early spring. For example, henbit, field pansy (Johnny jumpup), and downy brome primarily emerge in the fall, while other winter annuals such as shepherd's-purse, horseweed, purslane speedwell and field pennycress emerge during both the fall and spring (Werle et al. 2014).

Predicting the number of weeds that will emerge over a season is difficult. Knowing the number of seeds in the soil at any one time also is challenging, and predicting the percent of seeds to germinate and successfully establish is currently beyond our predictability. As a result, research has focused on predicting weed emergence timing. Knowing when weeds emerge improves overall weed management. For instance, stale or false seedbed approaches are more effective for weed species that germinate over a period of three to four weeks, than for species that emerge throughout the growing season (Figure 3.3) (see Chapter 13: *Pre- and Post-Plant Mechanical Weed Control*). In addition, understanding weed emergence patterns improves residual herbicide use and weed scouting.

One way to predict weed emergence timing is understanding cumulative emergence, which predicts the length of time over which the weed emergence occur. Most cumulative emergence curves have a general sigmoidal shape. Emergence begins slowly, then increases sharply before reaching a plateau (Figure 3.4). In this example, 50% of the species with a short emergence period has emerged within four weeks, and 100% of the plants have emerged by seven weeks. The species with a long emergence period does not reach 50% emergence until nine weeks. Common ragweed one species

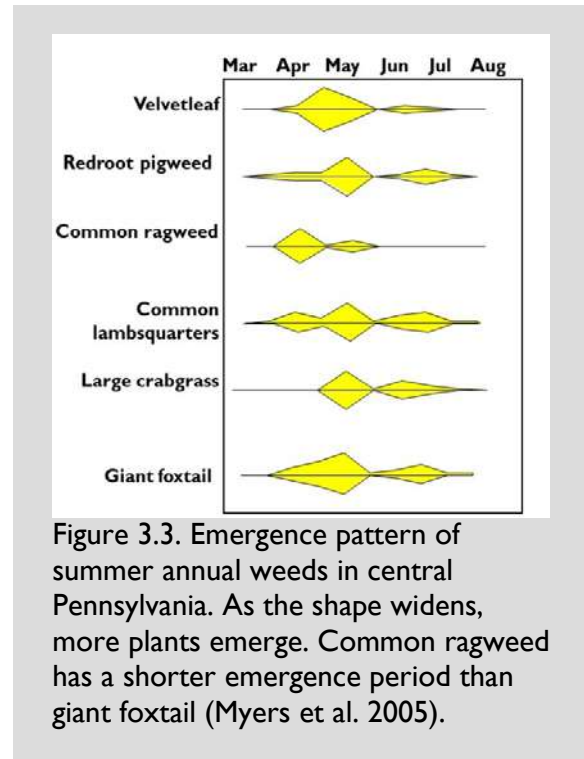
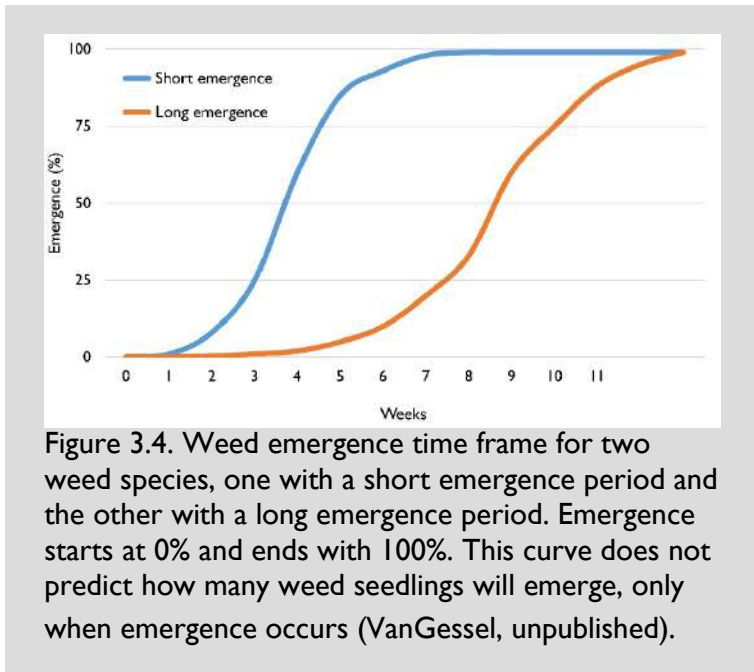

Figure 3.3. Emergence pattern of summer annual weeds in central Pennsylvania. As the shape widens, more plants emerge. Common ragweed has a shorter emergence period than giant foxtail (Myers et al. 2005).

with a short emergence span, while Palmer amaranth and horseweed are species that germinate over a long period of time.

A majority of plants with a short emergence period can likely be controlled by stale seedbeds or residual herbicides at planting. Species with a long emergence period typically require more IWM to account for the cohorts that emerge later in the season. Such tactics include maximizing crop shading, using herbicides with long residual control, or using cover crops that produce tissue that breaks down slowly.



Seed Production

All annual and biennial species produce must produce seeds for the next generation; and most perennial weeds in our region also produce seeds. After a period of vegetative growth, plants enter the reproductive stage, followed shortly by the appearance of flowers, and then seeds are formed. Unlike crops and many ornamental plants, many weeds have an extended period of time for flower emergence and seed production. Emergence timing has an impact on number of seeds produced with later emerging plants producing fewer seeds (Figure 3.5).

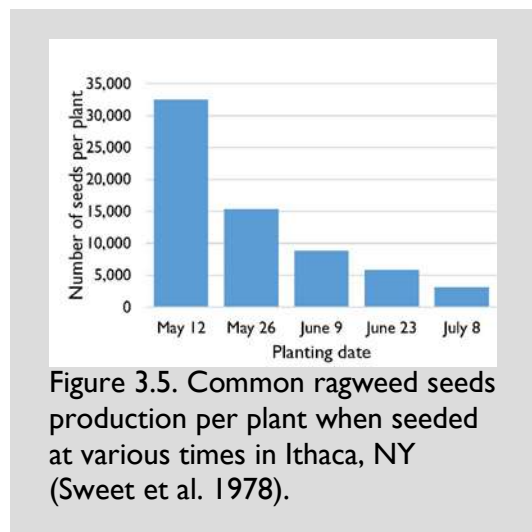

Viable seed production can occur within 1 to 2 weeks of flowering (Hill et al. 2015). In a multi-site study, the time of viable seed formation varied based on species and site-year, ranging from flower initiation to 57 days after flowering. The percentage of viable seeds increased when plants were allowed to reach full maturity, but all species produced viable seed when plants were terminated at the immature seed stage or later. Terminating common lambsquarters, common ragweed, and giant foxtail prior to flowering was the only effective way to eliminate weed seed production.

Weed Communities

Fields have many weed species present, but only a few species will dominate. In a study in Ohio, researchers identified over thirty weed species in one field (Cardina et al. 2002). As the diversity of species increases the need for a higher level of IWM utilization also increases.

Soil seedbanks in a given field will contain summer and winter annuals, and in many situations biennials and perennials may also be present. Figure 3.6 is an organizational framework grouping plants within a field. All of the plants of one species are called a population.

All of the populations of different species are called the community, and how the community interacts with the environment and agricultural production practices is called the ecosystem. Biotypes are plants within a species that are genetically distinct, such as herbicide-resistant plants. Weed management generally occurs at the plant community level. However, successful IWM programs need to recognize the ecosystem level and consider how weed and crop management influences one another.

The ability of the species to produce seeds (or perennials to produce vegetative reproductive structure) is critical for them to remain part of the field's plant community.

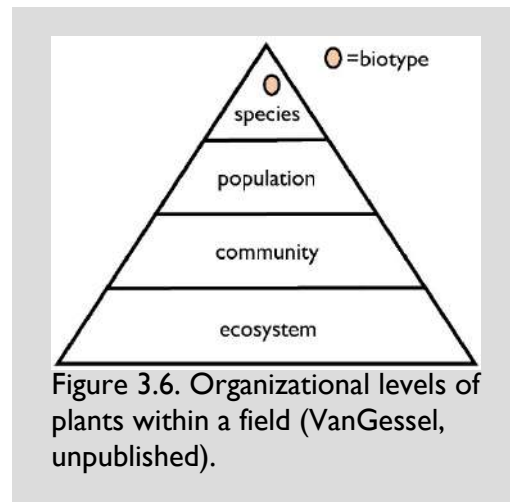

Figure 3.6. Organizational levels of plants within a field (VanGessel, unpublished).

Key Points

- Number of weed seeds in the soil is in constant change as seeds decay, seeds germinate, and new seeds are added.
- Emergence periods differ by weed species and can be as short as four- to five-weeks for some species, while others will continue to emerge over three- to four-months.
- Soil temperature is the primary environmental cue to stimulate seed germination; and tillage, plant residues, and crop canopy can influence soil temperatures.
- Knowing the germination period for a weed species can allow farmers to target management practices to increase the likelihood of controlling weed seedlings.

References

- Cardina J, Herms CP, Doohan DJ (2002) Crop rotation and tillage system effects on weed seedbanks. *Weed Sci* 50:448-460
- Dauer JJ, Mortensen DA, Luschei EC, Isard SA, Shields E, VanGessel MJ (2008) *Conyza canadensis* seed ascent in the lower atmosphere. *Agric Meteorol* 149:526-534
- Famer JA, Bradley KW, Young BG, Steckel LE, Johnson WG, Norsworthy JK, Davis VM, Loux MM (2017) Influence of tillage method on management of *Amaranthus* species in soybean. *Weed Technol* 31:10-20
- Forcella F, Wilson RG, Renner KA, Dekker J, Harvey RG, Alm DA, Buhler DD, Cardina J (1992) Weed seedbanks of the U.S. corn belt: magnitude, variation, emergence, and application. *Weed Sci* 40:636-644
- Hill EC, Renner KA, VanGessel MJ, Bellinder RR, Scott BA (2015) Late-season weed management to stop viable weed seed production. *Weed Sci* 64:12-118
- Menalled F (2008) Weed seedbank dynamics and integrated management of agricultural weeds. Montana State University, Ext Bull MT200808AG 4pp
- Myers MW, Curran WS, VanGessel MJ, Majek BA, Calvin DD, Mortensen DA, Karsten HD, Roth GW (2005) Effect of spring disturbance on annual weed emergence in the northeastern United States. *Weed Technol* 19:274-282
- Roberts HA (1983) Weed seeds in horticultural soils. *Sci Hort* 34:1-11
- Roberts HA, Dawkins PA (1967) Effect of cultivation on the numbers of viable weed seeds in soil. *Weed Res* 7:290-301
- Roberts HA, Feast RM (1973) Emergence and longevity of seeds of annual weeds in cultivated and undisturbed soil. *J of Appl Ecology* 10:133-143
- Roberts HA, Stokes FG (1966) Studies on the weeds of vegetable crops, VI. seed populations of soil under commercial cropping. *J Appl Ecol* 3:181-190
- Schweizer EE, Zimdahl RL (1983) Weed seed decline in irrigated soil after six years of continuous corn (*Zea mays*) and herbicides. *Weed Sci* 32:76-83
- Schweizer EE, Zimdahl RL (1984) Weed seed decline in irrigated soil after rotation of crops and herbicides. *Weed Sci* 32:84-89
- Swanton CJ, Shrestha A, Knezevic SZ, Roy RC, Ball-Coehlo B (2000) Influence of tillage type on vertical weed seedbank distribution in a sandy soil. *Can J Plant Sci* 80:455-457

- Sweet RD, Veatch C, Dunn S (1978) Life history studies as related to weed control in the northeast 8. common ragweed. Northeastern Regional Weed Control Technical Committee (NE-42), Bull. 1033 28pp
- Teasdale JR, Beste CE, Potts WE (1991) Response of weeds to tillage and cover crop residue. *Weed Sci* 39:195-199
- Teasdale JR, Mangum RW, Radhakrishnan J, Cavigelli MA (2004) Weed seedbank dynamics in three organic farming crop rotations. *Agron J* 96:1429-1435
- Werle R, Bernards ML, Arkebauer TJ, Lindquist JL (2014) Environmental triggers of winter annual weed emergence in the Midwestern United States. *Weed Sci* 62:83-96

Chapter 4: Weed Scouting and Mapping

Annie Klodd

Summary

Scouting is central to understanding what weed populations are present in a field, leading to targeted and efficient management. This chapter discusses the benefits of scouting, conventional procedures for scouting and mapping weeds, and emerging technologies to improve weed scouting.

Introduction

Scouting for weeds was once a commonplace practice, but its habitual use has decreased in modern agronomic production. Simpler weed management, aided by effective herbicides and herbicide-resistant crops, may have led to this decrease. However, scouting is the only way to identify the weed species present, growth stage, and infestation severity. The overall goal of an effective weed scouting program is to detect weeds present in a field and to understand how the weed community can affect the crop. This information is important for several reasons:

- Many weed species are only effectively controlled when they are small. Timely scouting finds small, susceptible weed seedlings present in a field.
- Weed species present determines the specific herbicide(s) that should be used. For instance, glyphosate is effective for a wide range of species, while other herbicides, such as carfentrazone (Aim®), are effective for only a few species.
- Scouting allows for early identification of new species, providing opportunity to control them before they move within the field or to other fields.
- Injury from herbicide applications, weed shifts, and herbicide-resistant species can be monitored to protect crop yield, and build an effective weed management program.
- Allows to evaluate if weed control tactic was successful or if an additional treatment is needed.

Weed Scouting Tools

Several tools and equipment are used to scout weeds. These tools include a clipboard, scouting forms, field maps, field history information, a hand lens, weed identification references, camera, trowel, knife, bags for samples, tape measure, pencils, and markers. Some farms and agricultural companies are use scouting software and

phone apps. Global Positioning System (GPS) units can mark weed infestation locations, and monitor them over time to determine the effectiveness of weed management programs. In the near future, the use of drones (or Unmanned Aerial Vehicles) may become typical, both for scouting and other means of collecting field information.

Scouting Procedure

Data collected through scouting includes the weed species present, life cycles, growth stage and size, and distribution throughout the field. For a thorough scouting, choose several sample areas. Each sample area should represent no more than five acres; this allows for an accurate count of the various weeds present in the whole field. For example, in a 50-acre field, select 10 sampling areas that are distributed throughout the field. They could be randomly selected, or they could be distributed a certain distance apart in order to ensure that all sections of the field are covered.

At each sampling area, walk 100 feet and record weed species present, growth stage and height. Next, record the severity of the infestation. If a large infestation is encountered within that transect, count the number of weeds found in 10 feet of row. For small infestations, count the number over 100 feet of row.

In many cases, weed infestations cluster in a certain area of the field. In these cases, it is possible that crop scouts walking random transects could miss an important weed population. Various scouting patterns (e.g. zig-zag, "M"- or "U"-shapes, and grid) could be used during the season in order to accurately sample weed populations and to verify if they are increasing or decreasing, if there is a future risk from problem weeds left uncontrolled, and if new species are invading. Walking different patterns in the field with each visit will help increase the likelihood of spotting localized infestations. Walking a higher number of areas per field also improves precision. UAV technology is also being tested for its ability to identify weed clusters remotely (see Aerial Weed Scouting, below).

When to Scout for Weeds

Scouting early and often allows identification of small weeds and allows time to consider a wider range of tactics. Continue scouting after the crop is harvested, until the killing frost. In most cases, three or four times per season is adequate. Specific times vary among crops, but scouting in a timely fashion allows effective control options and assessment (Figure 4.1). Observe later emerging weeds whenever scouting for other reasons (for instance, insects, diseases, fertility)

Crops	Dec-Mar	April	May	June	July	August	Sept	Oct	Nov
Corn or Soybeans		Weed survey 1-2 WBP (esp. no-till)		Weed survey 3-5 WAP	Evaluate treatments		Weed survey (before frost)		
Fall-seeded small grains	Weed survey			Final weed survey (before harvest)			Weed survey 1-2 WBP (esp. no-till)		Weed survey 3-6 WAP
Fall-seeded forages	Weed survey					Weed survey 1-2 WBP (esp. no-till)		Weed survey 3-6 WAP	
Spring-seeded forages	Weed survey 1-2 WBP (esp. no-till)		Weed survey 3-6 WAP			Weed survey			
Established forages	Weed survey		Between cuttings				Weed survey		

Figure 4.1. Suggested scouting periods for corn, soybean, small grain, and forage. WBP = weeks before planting; WAP = weeks after planting (Adapted from Penn State Extension by Klodd, VanGessel, and Lingenfelter, 2017).

For many weed species, control at the seedling stage is critical - many herbicides are most effective on seedlings and lose efficacy as the plants mature. The same is true for mechanical weed control. Regular scouting throughout the season helps identify weed cohorts (or flushes) as they emerge. Appropriate action can then be taken to prevent severe infestations.

Preplant and early postemergence

Through early scouting farmers can evaluate the effectiveness of preplant herbicides or tillage used to control weeds and cover crops prior to planting, and take action before the crop is planted if needed. This is important particularly in no-till fields requiring an early preplant herbicide to control (“burndown”) winter annual weeds. Scouting no-till fields early also allows an applicator to customize the herbicide application for specific weed populations, spraying while weeds are at a susceptible stage, and before winter annual weeds flower and produce seeds. Scouting shortly after

planting also helps the farmer to evaluate the preemergence herbicide's efficacy and take action while escaped weeds are small.

Postemergence herbicides and post-plant cultivation are usually most effective when weeds are young and actively growing. Many postemergence herbicides work best on weeds less than four inches tall. To select the best possible herbicide and apply it at the optimum time to maximize control, the farmer should identify weed seedlings when they are small. For more information on weed emergence Chapter 3: *Weed Emergence, Seedbank Dynamics, and Weed Communities*.

Mid-season weed and crop survey

Effective scouting following crop emergence determines whether further management is needed and which tactics will be effective based on weed size. Scouting shortly after crop emergence also helps farmers maintain the critical weed-free period of crop growth (See Chapter 5: *Concept of Weed Thresholds*).

Following all weed control treatments

Throughout the season, scouting should be done seven to ten days after any type of weed control treatment, whether herbicide application, tillage, or cultivation. Scout to check treatment success, record any new weeds that have emerged, and record any crop injury that may have occurred. At this time, resistant weeds and weed species shifts will start to show if they are not controlled by the herbicides.

Late or final weed survey

Harvest time weed scouting is important for several reasons. If a problematic weed species is located prior to harvesting and is too dense to be removed manually, a farmer can avoid harvesting those plants, preventing harvest delays and additional spread of weed seeds. Scouting before harvest helps

Scouting Innovations in the Smartphone Age

Many smart phone and tablet applications are available to aid in crop scouting, in-field record keeping, and data sharing. Some of these applications include features that aid specifically in weed identification, weed scouting, and management.

These apps can be used while walking the field to record specific locations of weeds, write notes about the weeds, identify weeds based on photos, and to submit images and herbicide recommendations to coworkers.

Some common features of these apps include:

- Geographically plotting weeds
- Drawing polygons around infestations
- Weed ID
- Recording notes on weed size, growth patterns, and field conditions
- Storing field-specific information
- Uploading photos
- Sending notes, recommendations, and images to coworkers

Some examples of these applications are: ScoutPro, FarmLogs, eCropScout, Connected Farm, and AGRiplot.

determine if a herbicide is needed as a harvest aid. Harvest time scouting can allow for assessment of yearly weed management strategies as well as anticipate which weeds may be present the following season.

Scouting for Herbicide-Resistant Weeds

To find weeds resistant to certain herbicide sites of action, look for species with herbicide-resistant populations in the region or surrounding counties. However, keep in mind that the failure of a herbicide treatment does not mean that the plant is a herbicide-resistant weed. Other factors that must be considered include the following:

- A single weed species is spreading and increasing in density over time
- The survival of some individuals within a species after application of an effective herbicide site of action, while some plants did not survive. This could indicate that some plants of that species in the field are resistant, while others are not.

Detailed criteria for determining herbicide resistance can be found at Herbicide Resistance Action Committee website (www.hracglobal.com/herbicide-resistance/confirming-resistance). The International Survey of Herbicide Resistant Weeds website (www.weedscience.org) provides thorough up-to-date information about resistant weeds in each state.

Aerial Weed Scouting with Unmanned Aerial Vehicles

Aerial remote sensing of weeds via drones (or UAVs) and satellite imagery has gained increased interest among field scouts. The goal of aerial weed scouting is to remotely identify weeds and within a short period of time, develop a precise weed map to direct scouting efforts. Detailed aerial weed maps may help applicators to direct herbicide applications to specific areas, potentially saving time and money (Pena et al. 2015). Drone and imaging technology are still in development, and there is still much to learn about accurate weed identification and weed scouting with drones before these methods are widely marketed to the public. UAVs use multispectral cameras to capture differences in field vegetation. As the UAV flies over the field, the camera creates an image of the colors emitted from the plants in the field. Computer software then distinguishes weeds from crops based on subtle differences in pigmentation and growth patterns

Researchers are currently working to improve UAV technology and software for use in weed management (Pena et al. 2015). It can direct scouting efforts to problems in the field, and provide a relative estimate of weed severity throughout the field.

However, the technology should not replace walking the field. Physically walking fields and observing the status of the weeds and crop is still necessary.

Key Points

- Fields should be scouted for weeds before planting, after herbicide applications, and at or after harvest time.
- When scouting, identify and record all weeds found.
- When scouting, look for trends or new species and infestations; including suspected herbicide resistance.

References

Pena JM, Torres-Sanchez J, Serrano-Perez A, de Castro AI, Lopez-Granados F (2015) Quantifying efficacy and limits of unmanned aerial vehicle (UAV) technology for weed seedling detection as affected by sensor resolution. *Sensors* 15: 5609-5626

Chapter 5: Concept of Weed Thresholds

Mark VanGessel

Summary

Preventing crop yield loss requires knowing when weed density is great enough that crop yield, quality, or harvest efficiency is reduced. Weed biomass is a combination of number of weeds and emergence timing; earlier emerging weeds have more biomass. Not all weeds need to be controlled for maximum yield, but weed biomass must be low enough to not reduce yield or interfere with harvest. To help manage herbicide-resistant weeds, the concept of thresholds have shifted from eliminating the effect of weeds on crop yield to eliminating weed seed production.

Introduction

Weeds reduce crop yields either directly by competing for moisture, nutrients, light, and carbon dioxide (CO₂) or indirectly by harboring other pests, interfering with harvest, contributing to foreign matter in the harvested crop, or slowing crop drydown. Farmers spend time and money trying to control weeds, often spending more than necessary. It is seldom necessary to control all the weeds in a field to achieve maximum crop yields. The goal is to keep weed density and weed biomass at a level that maintains maximum yield. Methods such as cover crops, mechanical weed control, herbicides, or a combination are used early in the season until the crop is established and able to outcompete the weeds. A healthy, vigorous crop canopy is a farmers' best tool for controlling weeds until crop maturity.

Many factors influence the severity of weed competition including weed species, density, emergence timing, crop management (e.g. row spacing, varietal differences), environmental conditions, fertility, and soil moisture levels. For example, common cocklebur had a greater effect on soybean yield when moisture levels were high compared to moisture-stressed conditions (Mortensen and Coble 1989) (Figure 5.1). Based on trials conducted under long-term organic systems, organic cropping systems may be able to tolerate a greater abundance of weeds than conventional systems (Ryan et al. 2009). Specific factors causing differences in these two systems have not yet been investigated.

Weed Density Threshold

Determining when weed management strategies should be implemented to control emerged weeds is based on two concepts: weed density and critical weed-free period. Weed density is based on the principle that weeds below a certain density or biomass level will not reduce crop yields while weeds above this threshold will reduce yield. Weed species and density are used to calculate weed density thresholds. The expected crop yield loss can then be calculated. Models determine the yield loss potential, cost of management, and expected economic return to help a farmer or crop advisor select the best management options. Weed density thresholds have been studied extensively, but results can be difficult to interpret because of the complex interactions involved. For example, the expected yield loss from various weed

species differs between two extension publications (Table 5.1). In Maryland, only 20 common lambsquarters in 100 ft² can cause a 10% corn yield reduction, while 60 plants are required for a similar yield loss in Illinois. A number of factors result in these differences, including soils, climate, and production practices.

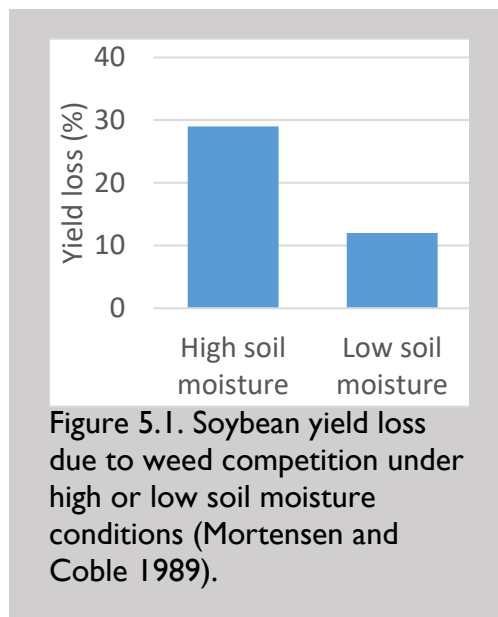

Figure 5.1. Soybean yield loss due to weed competition under high or low soil moisture conditions (Mortensen and Coble 1989).

Table 5.1. Number of weeds per 40 feet of row* expected to cause 10% yield in corn**.

Weed	Maryland	Illinois
Annual grasses	80	80
Common cocklebur	8	16
Common lambsquarters	20	60
Jimsonweed	12	32
Morningglory	20	40
Pigweed	20	60
Smartweed	20	32
Velvetleaf	12	40

*40 feet of row between to corn rows (30-inch rows) is 100 ft²

**Data based on information from Maryland Cooperative Extension values and Illinois Cooperative Extension values (Undated extension publications).

Critical Weed-Free Period

The critical weed-free period means maintaining the crop weed free while the crop's leaf canopy develops and is able to outcompete or shade out weeds that emerge later in the season (Figure 5.2). During a few weeks early in the season weeds can compete with the crop without impacting final yield. Likewise, weeds emerging later in the season

will not cause a yield reduction because by this time the crop has developed a dense crop canopy to suppress or outcompete any weeds.

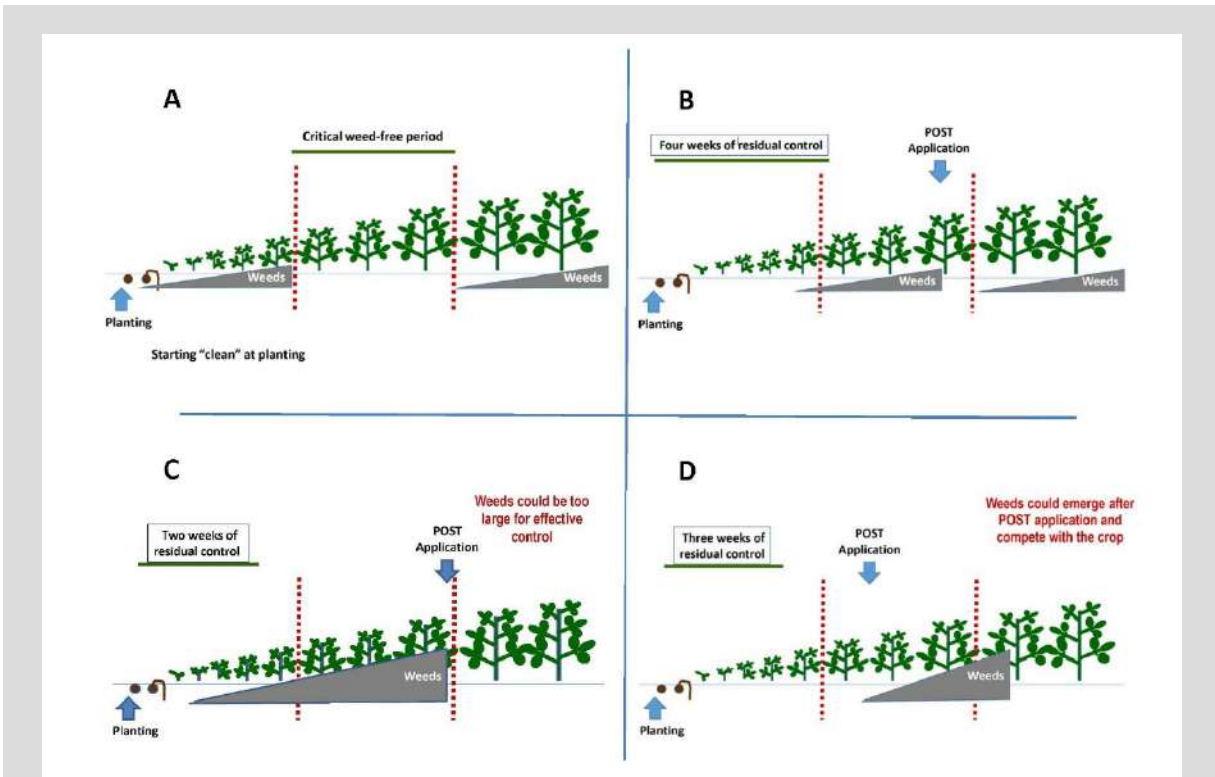

Figure 5.2. Timing of weed control practices on critical weed-free periods. A. The period of time that a crop should be weed free to achieve maximum yields. B. A common situation of early-season weed control with a preemergence herbicide, cover crop, or stale seedbed; followed by a postemergence herbicide or cultivation. C. Poor early-season weed control with weeds becoming too large for effective control. D. Cultivation or postemergence herbicide applied too early, with crop canopy unable to suppress later emerging weeds (VanGessel, unpublished).

Critical weed-free period is also based on the assumption that there are no weeds present at time of planting, whether the field was tilled or a herbicide was used to eliminate emerged weeds. A number of factors determine the length of the weed-free period; many are the same factors that influence weed thresholds (soils, climate, production practices) (Table 5.1 and Figure 5.3).

To use critical weed-free periods to their full advantage, farmers may:

- use a cover crop or soil-applied herbicide to provide early-season weed suppression and then use a postemergence weed control tactic such as cultivation or a postemergence herbicide;
- apply an early-postemergence herbicide that provides residual control; or
- include two to three cultivations with the final cultivation late enough in the season that later emerging weeds do not reduce crop yield.

Critical weed-free period is based on the principle that 100% weed control is not necessary to protect the crop yield. However, most of the research on critical weed-free period has examined yield loss and may not have accounted for foreign matter in the harvested crop, ease of harvest, or the impact of late emerging weeds on weed seed production.

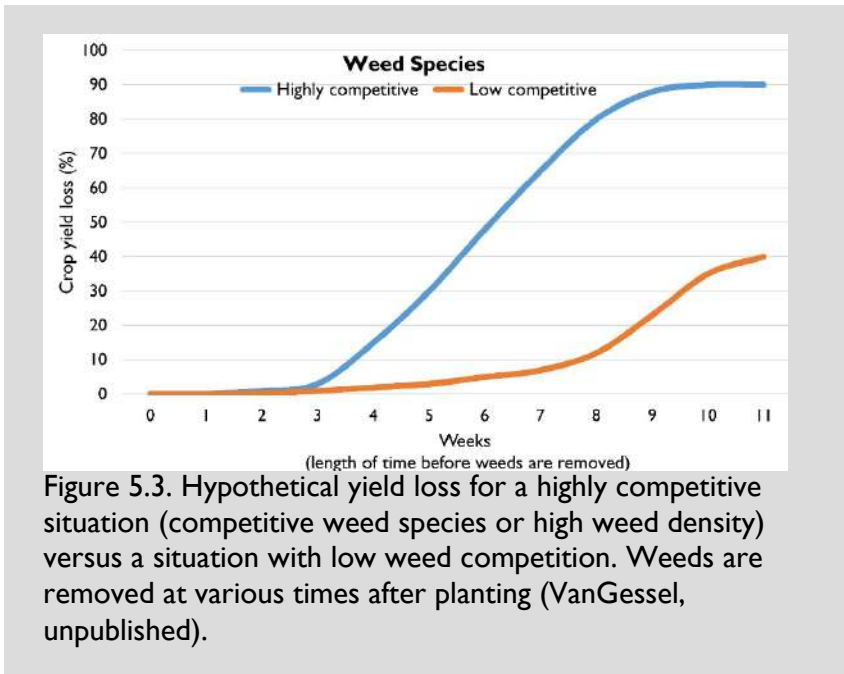

Figure 5.3. Hypothetical yield loss for a highly competitive situation (competitive weed species or high weed density) versus a situation with low weed competition. Weeds are removed at various times after planting (VanGessel, unpublished).

Spraying Postemergence Herbicides by the Calendar

Crop fields need to be scouted and treated not only before weed density or biomass are at a level to reduce yield, but also when weeds are small and susceptible. Research conducted in the Mid-Atlantic region has demonstrated that a postemergence herbicide applied on soybean at the V-4 stage provided excellent weed control and allowed the soybean canopy to outcompete later-emerging weed species. The results were similar for both full-season no-till and chisel plowed soybean. The timing for double-cropped soybean (following winter wheat) was less consistent, but in most years, a herbicide application at the V-5 stage did not reduce yields (VanGessel et al. 2000a, 2000b, 2001).

In corn, yield generally is not reduced if weeds are removed at the V-4 stage. This removal timing coincides with weed that are small enough for effective control and the corn leaves begin to develop a canopy that can outcompete most later emerging weeds (Gower et al. 2002, 2003; Myers et al. 2005).

In addition, many trials conducted by universities in the Mid-Atlantic region have discovered that a postemergence herbicide application at four weeks after planting (which coincides with the V-4 stage for corn and soybean) has provided the most consistent weed control while maintaining optimum yields. For example, Palmer amaranth and waterhemp are two weed species that are very competitive, grow very rapidly, and will germinate throughout the summer. As a result, these two species often require postemergence treatment to include an effective residual herbicide to lengthen the weed-free period to eliminate the need for additional treatment needed.

Preliminary data at the University of Delaware and Virginia Tech have shown the importance of application timing in small grain as well. Herbicides applied in the fall when wheat has two to three tillers prevented yield loss. However, delaying the small grain herbicides until late spring resulted in yield reductions. Winter wheat is a competitive crop that needs a relatively short weed-free period to prevent yield reduction.

If weeds emerge after corn is established, they do not compete as well or produce as many seeds. Ten barnyardgrass seedlings emerging from planting up to the 3-leaf corn stage produced 1,350 to 3,210 seeds ft² while seedlings emerging after the 4-leaf corn stage produced 110 to 260 seeds ft² (Bosnic and Swanton 1997).

Surviving Weeds May Contribute To The Seedbank

While weeds emerging after the critical weed-free period do not affect yields, they still can mature and produce seeds. However, the seed number will be much lower than plants that emerge shortly after planting the crop. If zero seed production is desired, a longer critical weed-free period is needed so that later emerging weeds are prevented from producing viable seeds. Currently, there is no regional research that provides guidance on how much longer the critical weed-free period needs to be extended to prevent the production of viable weed seeds (see Chapter 14: *Harvest Weed Seed Control*).

In the southern regions of the United States, the first killing frost is late enough to allow weeds that have not begun to flower at harvest to resume growing and produce a significant number of seeds. In some situations, farmers are advised to control these weeds with tillage or herbicides to prevent seed production. In the Mid-Atlantic region, weed control after crop harvest may be needed for early-harvested corn or silage corn.

Key Points

- Not all weed species have the same effect on yield loss.
- The climate, soils, and production practices have a large impact on the outcome of weed competition.
- Achieving a critical weed-free period requires:
 - effective early-season weed control
 - the ability to achieve a high level of weed control once weeds have emerged
 - possibly more than one weed control operation once weeds have emerged
- A vigorous crop canopy is an important component of late-season weed management.

References

- Bosnic AC, Swanton CJ (1997) Influence of barnyardgrass (*Echinochloa crus-galli*) time of emergence and density on corn (*Zea mays*). *Weed Sci* 45:276-282
- Gower SA, Loux MM, Cardina J, Harrison SK, Sprankle PL, Probst NJ, Bauman TT, Bugg W, Curran WS, Currie FS, Harvey RG, Johnson WG, Kells JJ, Owen MDK, Regehr DL, Slack CH, Spaur M, Sprague CL, VanGessel M, Young BG (2003) Effect of postemergence glyphosate application timing on weed control and grain yield in glyphosate-resistant corn: results of a 2-yr multistate study. *Weed Technol* 17:821-828
- Gower SA, Loux MM, Cardina J, Harrison SK (2002) Effect of planting date, residual herbicide, and postemergence application timing on weed control and grain yield in glyphosate-tolerant corn (*Zea mays*). *Weed Technol* 16:488-494
- Mortensen DA, Coble HD (1989) The influence of soil water content on common cocklebur (*Xanthium strumarium*) interference in soybean (*Glycine max*). *Weed Sci* 37:76-83
- Myers MW, Curran WS, VanGessel MJ, Majek BA, Scott BA, Mortensen DA, Calvin DD, Karsten HD, Roth GW (2005) The effect of weed density and application timing on weed control and corn (*Zea mays*) grain yield. *Weed Technol* 19:102-107
- Ryan, MR, Mortensen DA, Bastiaans L, Teasdale JR, Mirsky SB, Curran WS, Seidel R, Wilson DO, Hepperly, PR (2009) Elucidating the apparent maize tolerance to weed competition in long-term organically management systems. *Weed Res* 50:25-36
- VanGessel MJ, Ayeni AO, Majek B (2001a) Glyphosate in full-season no-till glyphosate-resistant soybean: role of preplant applications and residual herbicides. *Weed Technol* 15:714-724
- VanGessel MJ, Ayeni AO, Majek B (2001b) Glyphosate in double-crop no-till glyphosate-resistant soybean: role of preplant applications and residual herbicides. *Weed Technol* 15:703-713
- VanGessel MJ, Ayeni AO, Majek BA (2000) Optimum glyphosate timing with or without residual herbicides in glyphosate-tolerant soybean (*Glycine max*) under full-season conventional tillage. *Weed Technol* 14:140-149
- Werner EL, Curran WS, Harper JK, Roth GW, Knievel DP (2004) Velvetleaf (*Abutilon theophrasti*) interference and seed production in corn silage and grain. *Weed Technol* 18: 779-783

Chapter 6: Weed Prevention

Michael Flessner

Summary

Preventing weeds from entering or spreading within a field is critical to successful integrated weed management. Some of the tactics for weed prevention include cleaning equipment, planting weed-free seed, and controlling weeds prior to seed production.

Introduction

Preventing weeds from entering or spreading within a field is critical to successful integrated weed management. However, prevention can be difficult because weeds are well adapted for spread.

“An ounce of prevention is worth a pound of cure.”

Faithful prevention practices will reduce the weed population over time, making all management tactics easier and cheaper. If prevention is neglected, farmers are forced to battle weeds after infestations, treating symptoms rather than underlying problems.

Managing weeds both in-crop and between crops is key to successful prevention. Weeds can spread by seed and vegetative propagules (plant parts capable of becoming a new plant such as rhizomes or stolons). Because the spread of weeds by processes such as wind and movement by birds or animals is difficult to manage, this chapter will focus on seed dispersal by human activities and how to manage such spread.

Weed Prevention Practices

At planting

Plant certified, weed-free crop seed. Planting “bin-run” or saved crop seed contaminated with weed seeds places weed seeds directly in the crop row, spreads weeds within and between fields, and may increase establishment by increased seed-to-soil contact. All of these increase competition with the crop.

During the season

Do not let weeds go to seed, especially weeds with high seed production that are capable of rapid infestation, such as Palmer amaranth. Eliminating seed production of Palmer amaranth for one season reduced the number of weeds by over 300% in the following season (Flessner et al. 2018).

Up to 80% of this year's weeds are a result of the previous year's weed seed production.

Also, ensure weed-free irrigation and drainage waters. When surface irrigating, water can easily spread and introduce weed seeds and other plant parts capable of infestation (Walker 1995).

Harvest time

Clean harvest and grain transporting equipment. Remove weed seed and other weedy plant parts from all equipment before moving to the next field (Photo 6.1). In particular, harvesters can move weed seeds more than 450 feet from the mother plant resulting in weed spread within and between fields (Shirtliffe and Entz 2005). Models have calculated crop yield losses of more than one third in the area directly behind the harvester, the area with the highest density of weed disbursement (Maxwell and Ghersa 1992).



Photo 6.1: Cleaned brush mower (left) versus a brush mower covered in dandelion seed (right) (Photo credit: M. Flessner).

Post-harvest

Weeds that emerge while a crop is drying down or after harvest may produce viable seed ahead of a killing frost in certain parts of the Mid-Atlantic region. Preventing seed production reduces weed pressure faced in the following season (see Chapter 14: *Harvest Weed Seed Control*).

Weed prevention practices throughout the year

There are a number of ways weed seeds can enter a particular field. The following are practices and considerations to keep in mind.

- Do not spread weed-infested hay, straw, manure, or soil into fields.
 - Composting will reduce the number of viable weed seeds. However, weed seeds on the edges of compost piles may survive as they are not subjected to the heat required to kill them. When purchasing compost ensure the source of material does not contain weed seeds.
- Livestock can spread weed seed.
 - Many weed seeds remain viable after passing through the gut of cattle and poultry. If these animals are fed anything that contains viable weed seed or are allowed to graze a weedy field, quarantine the animals for three to seven days (until the seeds completely pass through their digestive systems) before moving them to clean fields.
 - Ensiling will greatly reduce viability of most weed seeds, although viability may not be completely eliminated.
- Control weeds around the farm in areas such as ditches, roadsides, the exterior of structures, and fence lines. Weeds growing in these areas will be a continuous source of field infestation.

Other weed prevention considerations

Beyond the practices mentioned above, other practices are critical to successfully preventing weeds.

- Crop rotation prevents build-up and domination of weeds common to a particular crop (Walker 1995). A diverse crop rotation increases the number of environmental and management obstacles for weeds (See Chapter 10: *Cultural Control*).
- Fallow periods in a crop rotation allow weeds to grow without competition and produce weed seed, which can replenish weed seedbanks and cause increased problems for years to come. For example, common lambsquarters has been reported to increase its weed seedbank size 14 times in a single fallow period (Leguizamon and Roberts 1982).
- Tillage can increase infestations of perennial weeds, by cutting and spreading propagules, such as johnsongrass rhizomes.
- Cover crops or smother crops may be used to prevent weed population build-up between cash crops. Care must be taken so that the cover crop does not become a weed itself (Walker 1995) (See Chapter 12: *Cover Crops for Weed Suppression*).
- Weeds that produce wind-borne seeds, such as thistles or horseweed, should be managed prior to seed production wherever they occur.

Key Points

- Plant certified, weed-free crop seed.
- Do not let weeds set seed.
- Avoid introducing sources of new weed infestation, such as hay, manure, and compost.
- Clean equipment to prevent weed seed and propagule spread, particularly harvest and tillage equipment.
- Rotate crops and avoid fallow periods.
- Control weeds around the farm in areas such as ditches, roadsides, and fence lines.

References

- Flessner ML, Haring SC, Beam SC, Bamber K (2018) Assessing zero Palmer amaranth seed return in a grain sorghum-soybean rotation versus continuous soybean. Page 59 in Proceedings of the Northeastern Plant, Pest, and Soils Conference. Philadelphia, PA: Northeastern Weed Science Society
- Leguizamon ES, Roberts HA (1982) Seed production by an arable weed community. *Weed Res* 22:35–39
- Maxwell BD, Ghera C (1992) The influence of weed seed dispersion versus the effect of competition on crop yield. *Weed Technol* 6:196–204
- Shirtliffe SJ, Entz MH (2005) Chaff collection reduces seed dispersal of wild oat (*Avena fatua*) by a combine harvester. *Weed Sci* 53:465–470
- Walker RH (1995) Preventative Weed Management. Pages 35-50 in Smith AE ed. *Handbook of Weed Management Systems* New York, NY: Marcel Dekker, Inc.

Chapter 7: Chemical Control: Herbicide Management Issues

Dwight Lingenfelter

Summary

Herbicides are crop-protecting chemicals used to kill weedy plants or interrupt normal plant growth, and can provide a convenient, economical, and effective way manage weeds. In most cases, they can be the backbone of many weed management programs. However, they should not be used alone but integrated with effective nonchemical tactics such as tillage, crop rotation, proper soil fertility, or other appropriate management options. Herbicides may not be necessary on some farms or landscapes. If chemical weed control is not utilized, mechanical and cultural control methods then become the priority.

Introduction

Over the past 60 years, synthetic herbicides have been widely adopted as a means to control weeds. Many herbicides control weeds in different types of crops with no or negligible injury to the crop. Furthermore, herbicides allow reduced tillage at planting, earlier seeding dates, and provide additional time for farm tasks and personal life. Due to reduced tillage, soil erosion has been reduced from about 3.5 billion tons in 1938 to 0.96 billion tons in 2012 (USDA NRI Report 2015), thus decreasing the amount of soil entering waterways and improving the nation's surface water quality. Without herbicide use, no-till agriculture becomes impossible.

However, herbicide use also carries environmental, ecological, and human health risks. It is important to understand the benefits and disadvantages associated with chemical weed control prior to use. Companies spend hundreds of millions of dollars to develop and test herbicides to meet stringent standards set by the U.S. government. The herbicide label is a result of this process and is a legal document designed to maximize weed control and minimize crop injury, environmental damage, and personal injury of those applying the product, as well as any incidental contact of others near the application area.

This chapter will address issues associated with herbicide use. For specific information on herbicide effectiveness for specific weeds and specific crops see the *Mid-Atlantic Field Crop Weed Management Guide* (AGRS-136).

Herbicide Classification

Herbicides can be categorized in different ways and by certain characteristics. In this publication, herbicides are classified according to: a) mode and site of action; b) application timings and methods; c) weed control spectrum and selectivity; and d) herbicide movement in the weed. Each of these is discussed below.

Herbicide mode and site of action

The term “mode of action” refers to the sequence of events from absorption into plants to plant death, or, in other words, how a herbicide works to injure or kill the plant. The specific location the herbicide affects is called the site or mechanism of action. To be effective, herbicides must (1) adequately contact plants, (2) be absorbed by plants, (3) move within the plants to the site of action without being deactivated, and (4) reach toxic levels at the site of action. Understanding herbicide mode of action is helpful in knowing what groups of weeds are controlled, specifying application techniques, diagnosing herbicide injury problems, and preventing herbicide-resistant weeds.

A common method of grouping herbicides is by their modes of action. Although a large number of herbicides are available in the marketplace, several have similar chemical properties and the way they control the weed. Two or more families may have the same site of action and will be listed under the same group number. Table 7.1 is a simplified list of the common herbicide sites of action groups and example herbicides. For a more extensive list and utility of each refer to the *Mid-Atlantic Field Crop Weed Management Guide*.

Table 7.1. Common herbicide mode of action classes and examples.

Mode of action (effect on plant growth)	Site of action	Herbicide group #	Active ingredient	Trade name(s)
Lipid (fatty acid) inhibitor (meristem)	ACCase enzyme	1	clethodim quizalofop	Select® Assure II®
Amino acid biosynthesis inhibitor	ALS enzyme	2	chlorimuron cloransulam imazethapyr rimsulfuron	Classic® FirstRate® Pursuit® Resolve®
Seedling growth inhibitor – root & shoot	Microtubule	3	pendimethalin	Prowl®
Plant growth regulator	TIRI	4	2,4-D dicamba	2,4-D Clarity®
Photosynthesis inhibitor – mobile	Photosystem II	5	atrazine metribuzin	atrazine TriCor®
Amino acid biosynthesis inhibitor	EPSP enzyme	9	glyphosate	Roundup®
N-metabolism disrupter (contact)	GS enzyme	10	glufosinate	Liberty®
Cell membrane disrupter (contact)	PPO enzyme	14	flumioxazin fomesafen saflufenacil	Valor® Reflex® Sharpen®
Seedling growth inhibitor – shoot	Long-chain fatty acids	15	acetochlor dimethenamid s-metolachlor	Harness® Outlook® Dual®
Pigment inhibitor (bleaching)	HPPD enzyme	27	isoxaflutole mesotrione	Balance® Callisto®

Herbicide application timings and methods

Application timings. In general, there are two times when herbicides are applied, preemergence or postemergence. Preemergence, or “soil-applied herbicides,” control weeds from the seed germination stage to emergence from the soil (Figure 7.1). Herbicides such as s-metolachlor (Dual Magnum®) and pendimethalin (Prowl®) must be applied before weeds germinate, otherwise they are ineffective. Soil-applied herbicides have residual activity and in general, provide weed control for about four to six weeks after application. Major factors that influence residual activity include soil moisture, soil pH, temperature, microbial activity, chemical decomposition, adsorption to soil structures, and plant uptake. As residual herbicide activity lessens, weeds begin to emerge during the season. At this point a postemergence herbicide may be necessary to provide adequate control for the remainder of the season.

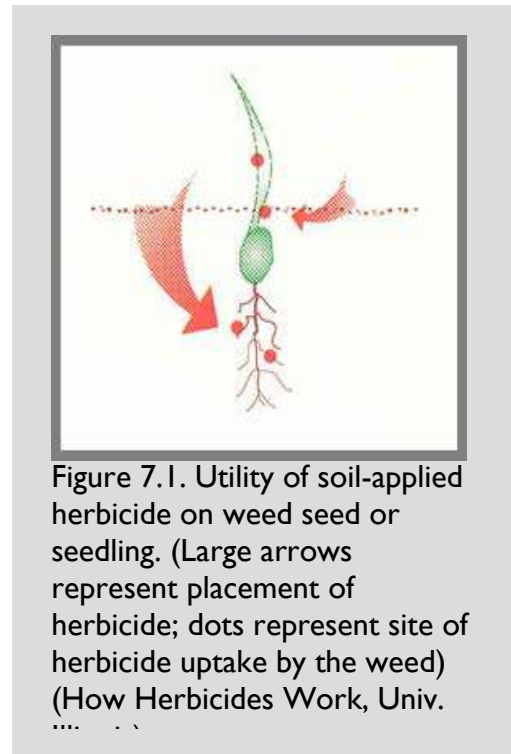

Figure 7.1. Utility of soil-applied herbicide on weed seed or seedling. (Large arrows represent placement of herbicide; dots represent site of herbicide uptake by the weed) (How Herbicides Work, Univ. ...)

Postemergence, or “foliar herbicides,” control existing weeds (Figure 7.2). Factors that influence their effectiveness include weed size, drought, temperature, rainfall, herbicide rate, spray volume, spray additives (adjuvants), and others. Certain herbicides provide both foliar and residual control (e.g., Callisto®, Classic®, atrazine, Reflex®) and are typically applied postemergence to control existing weeds and provide control of germinating seedlings. Other herbicides provide only foliar control (e.g., Roundup®, Gramoxone®, and Aim®). Combinations of preemergence and postemergence herbicides may be necessary to control various types of weeds in a field.

Soil-applied and foliar-applied herbicides can be further defined by certain factors that occur when they are sprayed. Below are some common terms used to describe these use patterns:

Preplant: applied to soil and/or existing vegetation before the crop is planted.

- Used in situations where herbicides are sprayed to control weeds present at the time of crop planting (typically for no-till). This timing is often referred to as burndown or knockdown applications
- Non-selective herbicide can be included to terminate cover crops

- Residual herbicides are often included to control weeds emerging after application
- Used in situations where residual herbicides need to be applied prior to planting to reduce the risk of crop injury
- Early preplant often refers to applications made 2 to 4 weeks before planting

Preplant incorporated (PPI): applied to soil and mechanically incorporated into the top two to three inches of soil before the crop is planted.

- Used with certain herbicides that are only effective when incorporated into the soil
- This technique is not conducive to no-till situations
- Incorporate herbicides into the top 1 to 2 inches of soil; incorporating herbicides deeper can dilute the herbicide and reduce its effectiveness

Preemergence (PRE): usually applied after the crop is planted but before the crop and weeds emerge.

- Rainfall or irrigation are typically required to move the herbicides into the soil (referred to as “activation”)
- Application should be delayed until after crop planting to prevent herbicide-treated soil from being disrupted and untreated soil exposed by the planter, row cleaners, or other operations

Postemergence (POST): applied after crop and weeds have emerged.

- Most postemergence herbicides need to be applied before the weeds are three inches tall and not intercepted by crop canopy to be most effective
- Postemergence applications can be further distinguished into other stages and time frames:
 - Early POST: weeds – ≤ 3 inches; corn – ≤ 6 inches; soybean – one unifoliate to trifoliate stage
 - Mid POST: weeds – 2 to 6 inches; corn – ≤ 12 inches; soybean – one to three trifoliates
 - Late POST: weeds – < 8 inches tall or as part of a split-application;

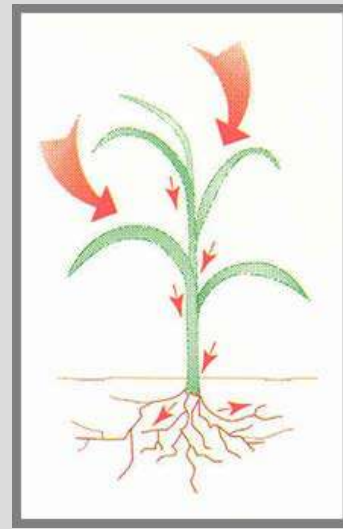

Figure 7.2. Utility of foliar-applied herbicide on weed. (Large arrows represent placement of herbicide; small arrows represent herbicide translocation or movement from site of uptake) (How Herbicides Work, Univ. Illinois).

corn – 12 to 20 inches; soybean - >3 trifoliates but before flowering stage

- Rescue treatment: when weather prevents earlier treatment or initial treatment was not successful; weeds >12 inches; effectiveness is generally poor

- An adjuvant (i.e. nonionic surfactant, crop oil concentrate) is typically included to improve postemergence herbicide effectiveness

Herbicide applications to weeds that have flowered may not stop viable seeds from being formed. Viable seeds are formed within 1 to 2 weeks of flowering.

Application methods. Herbicides can be applied differently depending on the situation. The following terms refer to the ways herbicides can be sprayed.

Broadcast: applied over the entire field typically with a boom sprayer (Figures 7.3 and 7.4).

- Refers to all application timings mentioned above

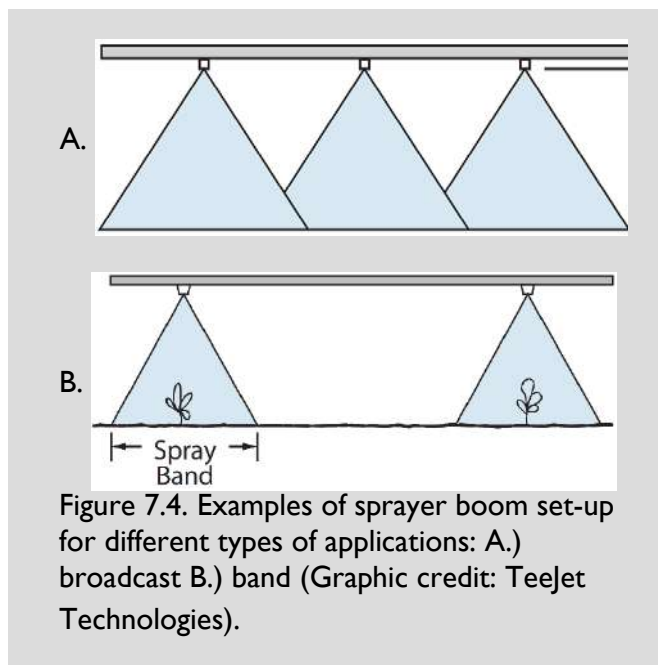
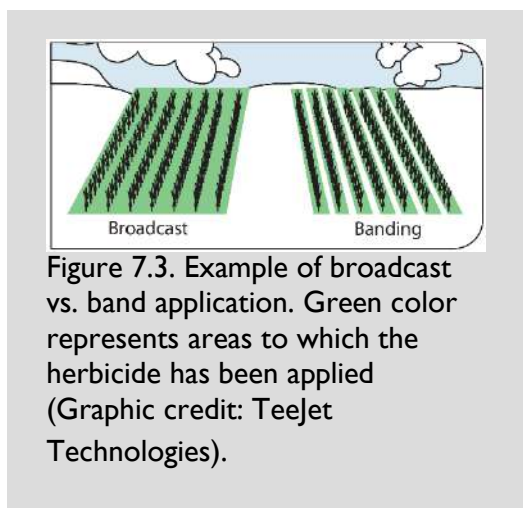

Band: applied as a narrow strip (ten to 12 inches) over the crop row (Figures 7.3 and 7.4).

- Typically refers to a preemergence herbicide applied after planting with spray nozzles attached to the planter
- Unlike a broadcast application, this allows for the herbicide to be applied only on a fraction of the field (i.e., width of spray pattern)

- Ensures herbicide-treated soil is not disturbed by planting operation (as often occurs with row cleaners)
- Used in areas not treated with a herbicide, cultivation, plastic mulch, or other means of weed control is utilized

Directed: applied between the rows of crop plants with little or no herbicide applied to the crop foliage.

- Nozzles are placed below the top of the crop canopy with drop-tubes that extend from sprayer boom
- Crop safety and/or coverage of weeds can be improved when the herbicide is directed below the crop canopy

Spot treatment: applied only to small or limited weed-infested areas within a field.

- Often used in areas prone to high weed pressure, such as pastures, roadsides, or field edges

Wiper application: uses a roller that contains herbicide at a high concentration or rope wick that applies the herbicide directly to the weeds.

- Herbicide(s) being applied with a wiper will damage the crop plant so the wiper must not come in contact with the crop
- Weeds must be taller than the crop so there is enough tissue to be treated with the herbicide
- Used as a rescue treatment or to aid in crop harvest

Weed Control Spectrum and Selectivity

Herbicide activity can be either selective or nonselective. Selective herbicides control certain weed species but do little or no damage to others including desirable plants or crops. However, not all crops are tolerant to all herbicides; similarly, not all weeds are controlled by all herbicides. Certain herbicides only control broadleaf plants, while others only control grasses. Many herbicides have activity on various broadleaf, grassy, and sedge weed species. Each herbicide has its strengths and weaknesses and for this reason, many of them are used in combinations to help complement their deficiencies.

Non-selective herbicides kill or injure almost all plants, including crops. Herbicide manufactures spend millions of dollars to test and develop many different chemicals in hopes of finding those that control a wide spectrum of weeds but are safe on a number of crops. Herbicide selectivity provides great value to the user in the fact that weeds can be discriminately and effectively controlled preemergence and/or postemergence without injuring the crop.

Selectivity is accomplished primarily by two methods: selectivity by placement and true selectivity. Selectivity by placement avoids or minimizes contact between the herbicide and the desired crop. An example is wiping or directing a herbicide, such as

glyphosate, on a weed without exposing the crop. Another way to direct a herbicide is the use of specialized shields or drop nozzles to focus the spray onto weeds without affecting crops. Applying a herbicide that does not readily leach beyond the soil surface for control of shallow-rooted weeds also is selectivity by placement – the herbicide does not leach into the root zone of a deeply rooted crop such as fruit trees or established alfalfa.

True selectivity is crop tolerance to certain herbicides as a result of some morphological, physiological, or biochemical process in the plant. The herbicide can be applied to the crop foliage or to the soil in which the crop is growing without danger of injury yet weeds that are susceptible to that herbicide will be controlled. In essence, the crop detoxifies the herbicide and is not injured. Although true tolerance may be better than selectivity by placement, since it is essentially unaffected by the herbicide, it is not perfect. Sometimes true selectivity may not adequately prevent some crop injury under unfavorable growing conditions that make the crop more sensitive or stressed.

Herbicide Movement in the Weed: Contact or Translocated

Contact herbicides kill or injure only the part of the plant with which the spray droplets come into contact, so adequate spray coverage is very important (Figure 7.5). Annual weeds may be controlled, but regrowth of perennial weeds from belowground parts usually occurs following application of a contact herbicide (Table 7.2). Translocated (or systemic) herbicides are absorbed by the leaves or roots of the plants and move within the plant through the xylem or phloem tissue (Figure 7.5).

Translocated herbicides are needed to kill underground parts of perennial weeds.

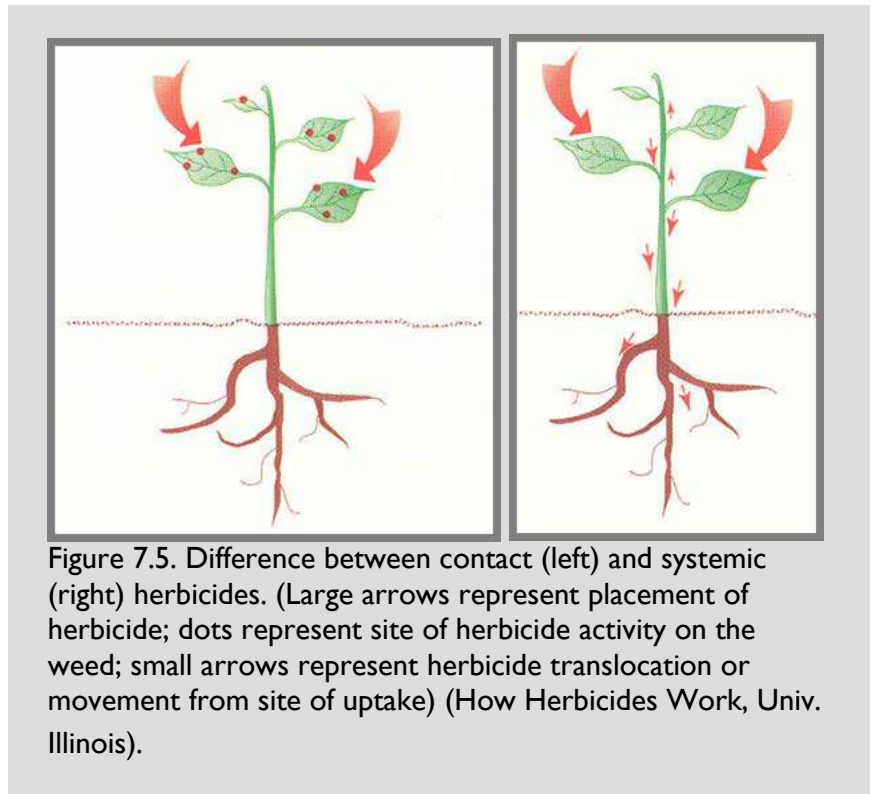

Figure 7.5. Difference between contact (left) and systemic (right) herbicides. (Large arrows represent placement of herbicide; dots represent site of herbicide activity on the weed; small arrows represent herbicide translocation or movement from site of uptake) (How Herbicides Work, Univ. Illinois).

Table 7.2. Effect of herbicide type on weeds with different life cycles. (Ross and Lembi. 1985. Applied Weed Science. Page 215) G= good; F= fair; P= poor

Herbicide type	Annual			Simple perennial	Creeping Perennials	
	Grasses	Broadleaves	Biennial		Seedling	Established
Contact	F to G	G	P to G	P to G	G	P
Limited translocated	G	G	G	G	G	P - F
Well-translocated	G	G	G	G	G	F - G
Residual soil-applied	G	G	P - G	P - G	G	P - G
Long residual soil-applied	G	G	G	G	G	G

Herbicides Use – What To Consider

There are many kinds of herbicides from which to choose. Many factors determine when, where, and how a particular herbicide can be used most effectively. Understanding some of these factors enables you to use herbicides to their maximum advantage. Below are some fundamental issues about herbicides and their use. For additional and specific information on herbicide use in field crops refer to the *Mid-Atlantic Field Crop Weed Management Guide*.

As previously mentioned, the perfect herbicide does not exist. No single herbicide is capable of controlling all weeds that can develop in a field without injuring the crop. Since every herbicide has advantages and disadvantages, selecting the correct herbicide or herbicide combination is crucial. Before choosing or applying a herbicide, the following should be considered:

- **Is it registered for use on the crop or area to be treated?** If so, read and follow label directions for use and rate of application. Recommended rates for soil-applied herbicides may vary according to soil texture and the amount of organic matter in the soil. Labels typically provide a range of rates to accommodate the effect that different soil types have on herbicide activity. Application rates for postemergence treatments may vary with weed size and climate. Weeds growing under dry conditions or during prolonged cool weather will not actively translocate a systemic herbicide. A higher herbicide rate may be needed for dry conditions as compared to the rate needed when weeds are actively growing under ideal conditions.
- **Will the herbicide control the most troublesome weeds and does it include methods for managing herbicide resistance?** Many herbicides applications fail because the chosen herbicide will not control weeds that are present (see Chapter

8: *Weed Resistance to Herbicides*).

- **Can the herbicide be used effectively at the current stage of crop or weed growth?** Very few herbicides can be applied at all stages of plant growth. Pendimethalin (Prowl®) and s-metolachlor (Dual Magnum®) are good examples of how growth stage affects herbicide performance. They are excellent herbicides for annual grasses when applied before weed emergence. However, they are useless if applied after the weeds have emerged. Postemergence herbicides tend to be most effective when applied to small weeds (i.e., less than four inches tall). Aside from weed size, the size of the crop can also affect postemergence herbicide applications. If crops are too large (as defined on the herbicide label), the herbicides may cause reduced crop vigor, interfere with reproductive processes, and ultimately reduce yield. Also as a crop gets larger, its leaves can intercept the herbicide before it reaches its intended weed target and result in poor weed control.
- **Can the soil-applied herbicide be used effectively and safely under the current conditions?** Soil-applied herbicides must be absorbed by roots and shoots of weed seedlings. Rainfall is usually needed to incorporate soil-applied herbicides, and without rainfall, weed control may be poor. The effectiveness of soil-applied herbicides also can be reduced if the herbicide is not applied at a high enough rate or is intercepted by crop residue, existing vegetation, a prior application of livestock manure, or other barrier. Reduced-tillage cropping systems may require higher application rates of soil-applied herbicides than tilled systems with no residue, depending on the amount of crop residue. Herbicides also can be lost to runoff, leaching, or volatilization/vaporization.
- **How does the herbicide or herbicide combination interact with other pesticides, fertilizers, or other inputs being used on the crop?** Certain combinations may cause undesirable results if mixed together in the same spray solution resulting in injury or death to desirable plants or disabling equipment. For example, some organophosphate (OP) insecticides interact negatively in the crop with ALS-inhibitor (Group 2) herbicides. Water mixes well with 2,4-D amine in the spray tank but if liquid nitrogen solution is used in place of water (e.g., in a “weed and feed” application), a gelatinous precipitate results and cannot be sprayed; furthermore, the sprayer is rendered useless until a very difficult clean out procedure is accomplished.
- **How does herbicide utility interact with other integrated weed management (IWM) strategies?** The use of herbicides must complement other weed control tactics to be effective. For example, herbicides can be an important tool to terminate cover crops prior to planting the cash crop. If the herbicide is also intended to control weeds near ground level, the cover crop may intercept most of the herbicide, resulting in poor weed control. Another IWM approach, for

example, combines mechanical and chemical tactics to control weeds. A field could be tilled in order to stimulate weed seed germination. Once the weed flush appears, a herbicide can be applied to control the newly emerged weeds.

- **Does the crop require the use of a “safener”?** Herbicide safeners, also called antidotes or protectants, are chemicals that help prevent injury to crops without reducing weed control. Some safeners are included in the herbicide formulation while others need to be applied to the seed prior to planting. Herbicides such as Dual II Magnum® and Resolve Q® include safeners. Grain sorghum seed is usually treated with a safener to reduce the risk of injury from Dual II Magnum®.
- **Is the herbicide being applied to a “conventional” (i.e., non-GMO) or genetically modified (GMO) crop?** Since genetically modified crops look similar to conventional crops, misapplication can occur and the crop can be unintentionally injured or killed. Make sure to record the type of crop planted in each field.
- **Will herbicide residues carryover to the next crop or cover crop and result in injury?** Herbicide carryover is a problem with herbicides that persist in sufficient quantity to injure successive plantings (often referred to as “rotational crops”). Herbicides prone to carryover include triazines (atrazine and simazine), dinitroanilines (Treflan®, Curbit®, Prowl®), ALS inhibitors (Classic®, FirstRate®, Pursuit®), and pigment inhibitors (Command®, Balance®, Callisto®). These herbicides can provide season-long control of certain weeds. However, if an excessive rate is applied, soil pH is above 7.0, or weather during the growing season is cool and dry, natural breakdown of the herbicides may not occur, leading to carryover. Read labels carefully for warnings about carryover and crop rotation concerns.
- **What factors are necessary for a successful application?** What is the appropriate method of application (i.e., broadcast, band, directed, spot)? Is it convenient to use in such a form as a ready-to-use (RTU) product, or does it require special equipment? Should it be mixed with water before application? Are there other characteristics, such as compatibility with other pesticides when tank-mixing or staining, that make it difficult to use?
- **Does the herbicide label recommend that a surfactant, crop oil, or other additive (adjuvant) be used?** Many postemergence herbicides require the use of an adjuvant in the mixture. These are special products that are added to the spray mixture to improve herbicide activity or optimize application characteristics.
- **Can this herbicide be used safely?** What is required during and after use to safely handle, mix, and apply the herbicide? Is it a restricted-use pesticide (RUP)? When using an RUP, the handler and applicator must have a special license (obtained through the state’s Department of Agriculture) to work with

such herbicides.

- **Can the herbicide injure non-target plants in adjacent areas?** Exercise caution to avoid drift, runoff, leaching to groundwater, and cross-contamination of other materials. Be especially aware of herbicide residues in sprayers when spraying a different crop.
- **Does the herbicide require specific tank cleaning procedures?** Even low amounts of some herbicides can cause severe injury to susceptible crops; thus tank cleaning can be very important. Some herbicides have specific tank clean out procedures, including using recommended tank-cleaning agents.

Herbicide Resistance

A number of weed species that were once susceptible to and effectively managed by certain herbicides have developed resistance to those herbicides and are no longer controlled by them. Certain precautions, such as tank-mixing multiple and effective herbicides, crop rotations, and a combination of weed management tactics, must be taken to prevent resistance. However, some cases of suspected herbicide resistance may actually be due to improper herbicide application (e.g., weeds too large, dry weather, or improper herbicide used) and not actual resistance to a herbicide (see Chapter 8: *Weed Resistance to Herbicides*).

Farmers, consultants, and herbicide applicators should know which herbicides are best suited to combat specific resistant weeds. The Weed Science Society of America (WSSA) developed a grouping system to help with this process. Herbicides that are classified as the same WSSA group number use the same site of action to control weeds. WSSA group numbers can be found on many herbicide labels. They can be used as a tool to choose herbicides with different sites of action so mixtures or rotations of active ingredients can be planned to better manage weeds and reduce the potential for resistant species.

Drift

Drift is the movement of any pesticide through the air to areas not intended for treatment. During application, physical drift occurs as spray droplets or dust particles are carried by air movement from the application area to other places. Vapor drift takes place after application as herbicides evaporate (volatilize) and the vapors (gases) are carried on wind currents and deposited on soils or plants in untreated areas. In general, physical drift of spray droplets occurs before the droplets reach their intended target whereas, vapor drift occurs after the herbicide reaches its target and changes to gas and then moves.

Drift may injure sensitive crops, ornamentals, gardens, livestock, wildlife, or people and may contaminate streams, lakes, or buildings. It may contaminate crops and cause illegal or excess residues. Excessive drift may mean poor performance in the

target spray area because the actual amount of herbicide working in the area is lower than expected.

Drift control should be considered with each pesticide application. Risk of severe drift problems can be minimized by using:

- Sprayer nozzles designed for drift reduction
- Low volatile or nonvolatile formulations
- Low spray-delivery pressures (15–40 psi) and nozzles with a larger orifice (hole)
- Drift-inhibiting adjuvants in the spray mixture when spraying under less-than-ideal conditions
- Nozzles that allow for lowered boom height

Drift problems can also be prevented through the following practices:

- Avoiding application of volatile herbicides during hot weather (>85°F)
- Spraying when wind speeds are low (<10 mph) or when the wind is blowing away from areas that should not be contaminated
- Spraying during the early morning or evening hours when there is usually less wind
- Avoiding application when conditions are favorable for temperature inversions (very still air, usually early evening into early morning hours)
- Leaving field borders unsprayed if they are near sensitive crops

Herbicides in Organic Cropping Systems

Using synthetic herbicides is generally not allowed in organic crop production systems. The USDA National Organic Program (NOP) does allow certain nonsynthetic soap-based herbicides or plant-based oil herbicides for use in farmstead maintenance (roadways, ditches, right of ways, building perimeters) and ornamental crops. In addition, several products that contain natural or nonsynthetic ingredients (e.g., vinegar, clove oil, cinnamon oil, citrus oil, or lemon grass oil) are classified as approved by the Organic Materials Review Institute (OMRI). Currently these herbicides are non-selective and can cause severe injury if sprayed on the crop. The OMRI listing does not imply product approval by any federal or state government agency. It is the user's responsibility to determine the compliance of a particular product. Allowable materials can change frequently. Because the classification of a material as allowable for organic production is subject to change, it is strongly recommended that organic farmers confer with their certifiers before purchasing or applying any pest management substance to avoid loss of organic certification. Additional information about "organic herbicides" or "bio-herbicides" and their utility can be found in the *Penn State Organic Crop Production Guide*. As with all pesticides, read and follow the label of OMRI-approved herbicides.

Key Points

- Herbicides can be defined as crop-protecting chemicals used to kill weedy plants or interrupt normal plant growth.
- Herbicides provide a convenient, economical, and effective way to help manage weeds.
- In most cases, they can be the backbone of many weed management programs. However, they should not be used alone but integrated with effective nonchemical tactics.
- The perfect herbicide does not exist. No single herbicide is capable of controlling all weeds that can develop in a crop or planting. Since every herbicide has advantages and disadvantages, selecting the correct herbicide(s) is crucial.
- Most herbicides are typically applied to the soil (preemergence) before weeds germinate or after weeds are growing (postemergence).
- Herbicides can be categorized in different ways and by certain characteristics, including: a) mode and site of action; b) application timings and methods; c) weed control spectrum and selectivity; and d) herbicide movement in the weed.

References

- 2012 National Resources Inventory Summary Report, August 2015
(https://www.nrcs.usda.gov/Internet/FSE_DOCUMENTS/nrcseprd396218.pdf)
- How Herbicides Work – A Short Course on How Herbicides Kill Weeds and Injury Crops, Univ. of Illinois (<http://www.chainsawjournal.com/wp-content/uploads/2015/04/How-Herbicides-Work-weed-killers.pdf>)
- Mid-Atlantic Field Crop Weed Management Guide (<https://extension.psu.edu/mid-atlantic-field-crop-weed-management-guide>)
- TeeJet Technologies, a subsidiary of Spraying Systems Co. (<http://www.teejet.com>)
- Textbook: Ross and Lembi. 1985. Applied Weed Science.
- National Organic Program Handbook (<https://www.ams.usda.gov/rules-regulations/organic/handbook>)
- Organic Materials Review Institute (<https://www.omri.org>)
- Penn State Organic Crop Production Guide (<https://extension.psu.edu/penn-state-organic-crop-production-guide>)

Chapter 8: Weed Resistance to Herbicides

Thierry Besançon

Summary

Herbicide-resistant weed populations are evolving rapidly worldwide and are the greatest challenge to current weed management strategies. By exerting intense selection pressure on weed populations, repeated overuse of certain herbicides has allowed for herbicide-resistant plants to survive and their densities to increase over time. Understanding the mechanisms of herbicide resistance development and spread gives farmers the tools to detect the early warning signs of resistance, take appropriate actions to control suspected resistant plants, and implement strategies to avoid or delay herbicide resistance.

Introduction

Repeatedly using herbicides that target the same plant physiological processes has led to the selection of plants that can naturally survive applications of these herbicides (Vencill et al. 2012).

Herbicides place tremendous selection pressure on weeds by killing susceptible individuals, but allowing naturally resistant individuals to survive and reproduce. The greatest number of herbicide-resistant weed species is reported for the acetolactate synthase (ALS) inhibitor, triazine, and acetyl CoA carboxylase (ACCase) inhibitor herbicides (Figure 8.1). Currently, 252 species of weeds present in 92 different crops and 69 countries have developed resistance to herbicides. Overall, weeds have evolved resistance to 23 of the 26 known herbicide sites of action, totaling 163 different herbicides (Heap 2018). Continual development and spread of resistant plants within some weed species poses a direct threat to the sustainability and the long-term survival of current cropping systems. The presence of herbicide-resistant weeds requires substantial changes in weed and crop management practices, increases the cost of weed control, and reduces the number of viable herbicide options. Understanding the origin and underlying causes of herbicide resistance gives farmers keys to avoid herbicide resistance development in weeds and maintains effective management tools.

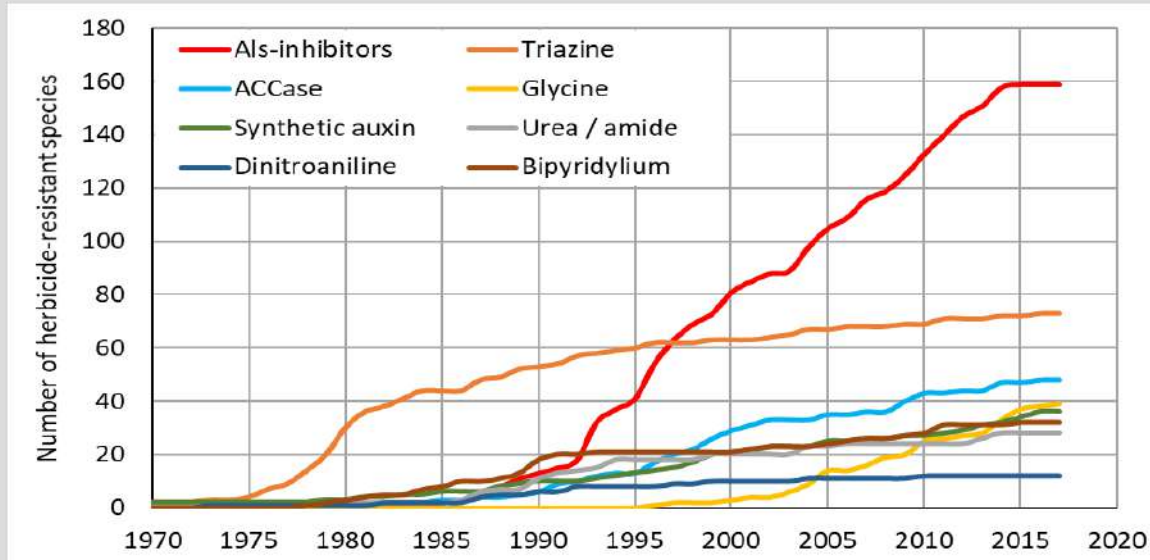

Figure 8.1. Chronological increase in resistant weeds for the most common herbicide families (Heap, 2017).

How Does Herbicide Resistance Develop?

Herbicide resistance is the inherited ability of a plant to survive and reproduce following exposure to a dose of herbicide normally lethal to the wild type (WSSA 1998). In simple terms, the herbicide no longer controls a weed population as it once did. While susceptible plants within a weed population will be killed, plants that naturally developed a genetic resistance to a specific herbicide will escape and reproduce. This is known as selection pressure: by killing all susceptible plants, the herbicide selects those that can survive an application of this herbicide. If this process continues for several weed generations, the populations of the herbicide-resistant weed will gradually increase until a noticeable portion of the population is no longer controlled by the herbicide. That is usually when farmers realize that herbicides once effective at controlling certain weeds no longer provide the expected level of control.

Mechanisms of Herbicide Resistance

Herbicide resistance mechanisms can be categorized as target-site or non-target site resistance. In target-site resistance, the molecular structure of the target site (the location within a plant where a herbicide acts to disrupt a plant process or function) is altered. The herbicide can no longer bind to its site of action (usually an enzyme) and interfere with plant physiological processes. This mechanism is considered the primary mechanism of resistance for herbicides that

are inhibiting the enzymatic activity of acetolactate synthase (ALS inhibitors), acetyl CoA carboxylase (ACCase inhibitors), and protoporphyrinogen oxidase (PPO inhibitors) (Powles and Preston 2006). This is also the mechanism involved with resistance to herbicides inhibiting cell mitosis (dinitroanilines) or photosynthesis (triazines) (Table 8.1).

Target-site resistance also can be caused by increased production of the targeted enzyme in resistant plants. According to research analyzing glyphosate-resistant Palmer amaranth, resistant plants produce more copies of the EPSP synthase enzyme targeted by glyphosate than susceptible plants. A higher

number of enzyme copies means a labeled rate of glyphosate will not be sufficient for inhibiting enzymatic activity. By increasing its number of EPSP synthase copies, the plant survives a glyphosate rate that would otherwise be lethal to susceptible plants.

Non-target-site resistance is another mechanism through which plants can develop resistance to herbicides. As suggested by its name, this mechanism does not involve the herbicide active site. For example, the weed can increase its metabolic activity and eliminates the herbicide before it affects plant physiological processes. Weeds also can reduce the absorption of the herbicide active ingredient or limit the number of herbicide molecules that will actually reach the site of action by sequestering them within an inactive cellular site. The actions involved in non-target-site resistance may be expression of natural, enhanced tolerance to environmental stresses. Non-target-site resistance is often governed by many genes (polygenic) and may confer resistance to herbicides with different sites of action (Délye et al. 2013).

Selection Processes Leading to Herbicide Resistance

Although various environmental, biological, and human factors affect the timing of herbicide resistance onset and the speed of its spread, the way herbicides are used for controlling weeds is the most important factor leading to the evolution of herbicide resistance (Norsworthy et al. 2012). Repetitive use of a single herbicide or a group of herbicides with the same site of action favors the survival and development of plants naturally resistant to this site over those that are susceptible. Initially, a low number of individual plants with genetic adaptations giving them the ability to withstand a specific herbicide are present within a weed population. When this herbicide is applied,

Table 8.1. Number of target-site herbicide resistant weed species worldwide in 2018 for major herbicide sites of action (Adapted from Heap 2018).

Herbicide Site of Action	HRAC Group	Monocots	Dicots
ALS inhibitors	B	62	98
Photosystem II inhibitors	CI	23	51
ACCase inhibitors	A	48	0
EPSP synthase inhibitors	G	20	22
Cell mitosis inhibitors	KI	10	2
PPO inhibitors	E	3	10

susceptible plants are controlled, but resistant plants survive, grow, and produce seeds that contribute to the spread of herbicide resistance. This selection process continues with repeated applications of herbicides with the same site of action. The number of resistant individuals gradually increases, until the majority of the plants within a weed population are herbicide-resistant.

Reduced herbicide rates also can be a contributing factor to the evolution of herbicide-resistant weeds. Herbicide susceptibility varies among individuals within a weed population, allowing some plants to survive when exposed to a herbicide application. Reduced herbicide rates may allow plants with low or intermediate levels of resistance to survive. For instance, diclofop (Hoelon®) applied below the labeled rate was a major factor to the development of diclofop-resistant rigid ryegrass in Australia (Manalil et al. 2011). Genes that individually have a minor effect on the development of herbicide resistance can accumulate over time when herbicides are consistently sprayed at reduced rate. Cross-pollination recombines these genes, resulting in plants with higher levels of herbicide resistance than the previous generations (Délye 2013). Reduced rates may be the result of a weed management strategy or herbicide chemistry or formulation. For example, herbicide volatilization or slow degradation in the soil can expose weeds to sub-lethal herbicide rates. Reduced rates also can result from herbicide applied on plants larger or at a more advanced growth stage than recommended by the label. Crops with large canopy cover, inappropriate herbicide mixing, or inaccurate spray calibration result in insufficient spray coverage and reduced effective rates of weed control. Using the herbicide rate as indicated on the label and applying herbicides to weeds at the correct size are key to preventing herbicide resistance evolution and should be accompanied with proper weed scouting and sprayer calibration (see Chapter 4: *Weed Scouting and Mapping*).

Factors Affecting Resistance Development

Herbicide chemistry and its behavior in the soil or plant play an important role in the development of herbicide resistance. Herbicides that provide a high level of weed control eliminate a great portion of herbicide-susceptible weeds. Since only herbicide-resistant plants will survive and reproduce, resistance is more likely to develop in weeds that are highly susceptible to a specific herbicide because susceptible plants will be rapidly eliminated.

Herbicides that degrade slowly will place a greater selection pressure for resistance development because weeds are exposed to the herbicide for a longer period of time. Susceptible seedlings that emerge after the use of herbicide with no or short residual activity will survive, reproduce, and replenish the soil seedbank with herbicide-susceptible seeds. However, susceptible seedlings that emerge after the use of a long-residual herbicide will still be exposed to that herbicide, and only resistant biotypes will survive and reproduce.

Herbicides that target a single site of action will more likely favor the emergence and spread of herbicide-resistant weeds than those that interfere with multiple processes in the plant. For example, ALS-inhibitor herbicides (Group 2) specifically target the acetolactate synthase. Any structural change to this enzyme can confer resistance to the different herbicide families of ALS inhibitors. On the other hand, chloroacetamide herbicides (Group 15) interact with several enzymes involved in the biosynthesis of long-chain fatty acids. Targeting multiple sites of action may explain why resistance to chloroacetamide herbicides is relatively rare with only five known cases of resistant weeds. However, resistance to ALS inhibitors has been confirmed for 160 species worldwide.

Biology and genetics also are important factors in herbicide resistance development. The frequency of resistance in a weed population prior to herbicide application determines how long it takes for herbicide resistance to evolve. Resistance will spread faster with higher resistance frequencies. A 1:100,000 ratio of resistant weeds to total weeds will cause faster spread than a 1:10,000,000 ratio. Also, weeds with greater genetic diversity have greater chance of harboring resistance genes to a specific herbicide. For example, weeds belonging to the *Amaranthus* genus (or pigweeds) have considerable genetic diversity and some species have developed resistance to six herbicide sites of action (Heap 2018). Cross pollination and large seed production increase the risk of herbicide resistance dispersion. For example, Palmer amaranth male and female flowers are on separate plants, making cross pollination necessary for the production of seeds. Even plants that are 1,000 feet apart can transfer resistance to glyphosate from one to the other through pollen dissemination (Sosnoskie et al. 2012). Palmer amaranth averages 500,000 seeds produced per plant when there is no competition, allowing quick spread of glyphosate resistance.

What are Herbicide Groups?

Herbicide Resistance Action Committee (HRAC) and Weed Science Society of America (WSSA) have classified commercially available herbicides according to their sites of action, symptoms similarity, or chemical classes. HRAC uses letters and WSSA numbers to identify the various herbicide groups. For example, herbicides inhibiting photosynthesis at photosystem II are classified under group C by HRAC. Subclasses C1, C2 and C3 indicate different binding herbicide binding sites. These subclasses correspond to WSSA groups 5, 7, and 6, respectively.

Weed population size also contributes to the onset of herbicide resistance. The greater the number of plants exposed to a herbicide, the higher the risk of increased resistance genes frequency and resistance development (Gressel and Levy 2006). Preventing large weed populations and weed seedbank replenishment is a key component in herbicide-resistance management.

Types of Herbicide Resistance

Cross resistance occurs when a weed develops resistance to two or more herbicides that target the same site of action (Vencill et al. 2012). These herbicides can belong to the same or different herbicide families. For example, a single point mutation in the enzyme acetolactate synthase (ALS) of common ragweed may provide resistance to chlorimuron (Classic®) and cloransulam (FirstRate®). These herbicides belong to two different herbicide families, but have the same site of action (Figure 8.2).

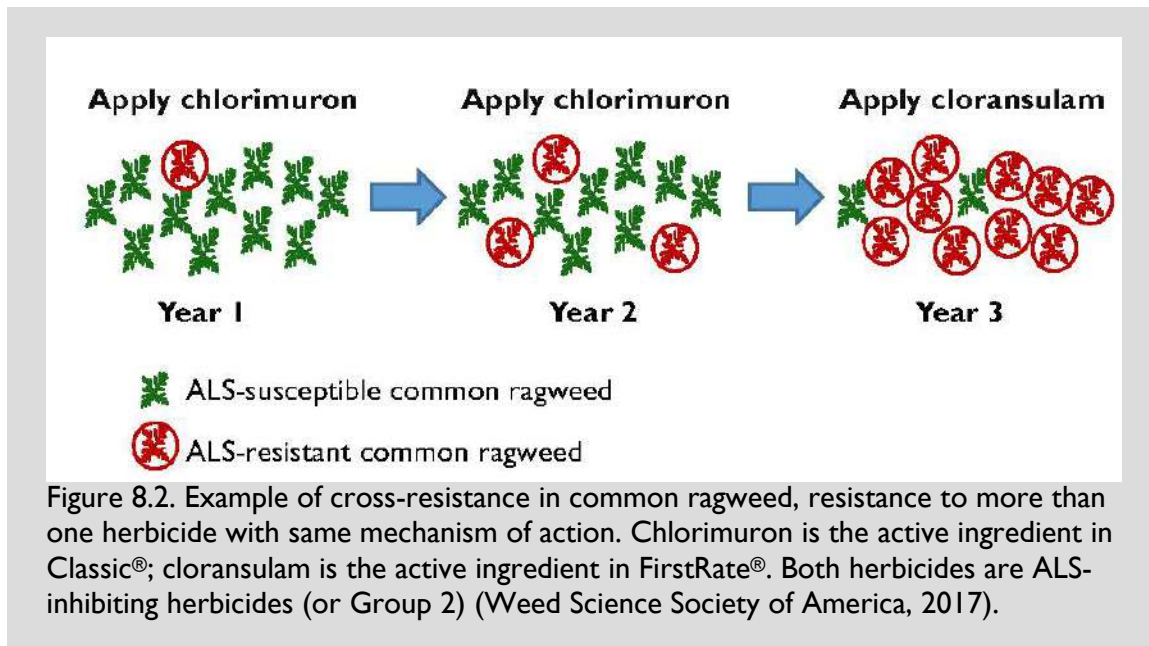
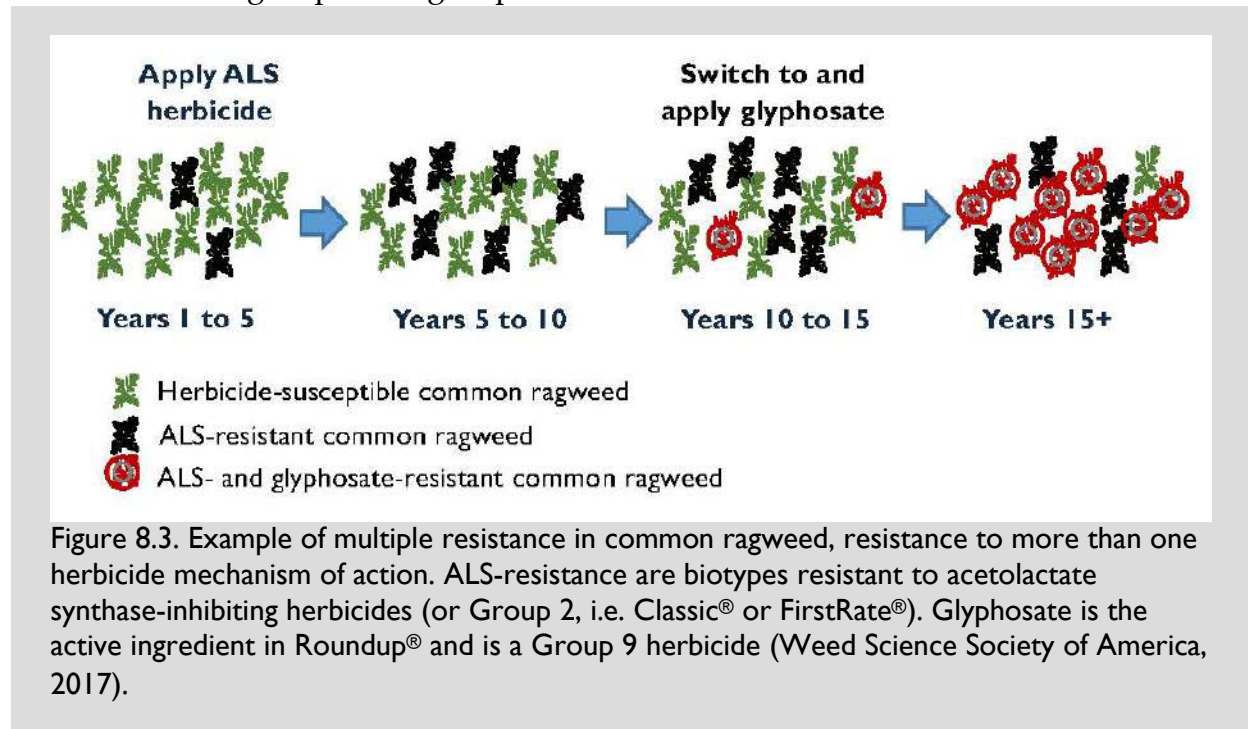

Figure 8.2. Example of cross-resistance in common ragweed, resistance to more than one herbicide with same mechanism of action. Chlorimuron is the active ingredient in Classic®; cloransulam is the active ingredient in FirstRate®. Both herbicides are ALS-inhibiting herbicides (or Group 2) (Weed Science Society of America, 2017).

Multiple resistance means that a weed is resistant to several herbicides with different sites of action (Powles and Preston 1995). For example, imagine that a farmer applies FirstRate®, an ALS-inhibitor herbicide (group 2), to control common ragweed (Figure 8.3). The repeated use of FirstRate® unintentionally selects for an ALS-resistant biotype (shown in black), which will dominate the common ragweed population and prevent effective ragweed control. The farmer then switches to Roundup®, a 5-enolpyruvylshikimate-3-phosphate (EPSP) synthase inhibitor (group 9), and uses it continuously for several years. Continued Roundup® use selects for plants resistant to group 9 herbicides within

a population that is already resistant to group 2. Ultimately, the common ragweed population has developed multiple herbicide resistance with individuals that are resistant to both group 2 and group 9 herbicides.



Weed Species Shifts and Weed Resistance

A weed species shift is a change over time in the relative abundance of the weed species that form a weed communities. These species are not equally affected when a specific herbicide is applied. Some species can be completely controlled while others are only partially controlled or not affected at all. Recurrent use of the same herbicide causes shifts toward species that are not vulnerable to this herbicide. For example, the continued use of broadleaf herbicide 2,4-D in cereal grain crops eventually leads to the elimination of susceptible broadleaf weeds. Grassy weeds that are tolerant to 2,4-D will survive, multiply, and dominate the weed communities over time. In this scenario, 2,4-D selectivity is caused by differential physiological sensitivity between grassy and broadleaf weeds, not because of resistance to 2,4-D (Figure 8.4). Weed species shifts are not only driven by herbicide use; they also may be the result of other agronomic practices such as tillage, crop rotation, or nonchemical weed control tactics.

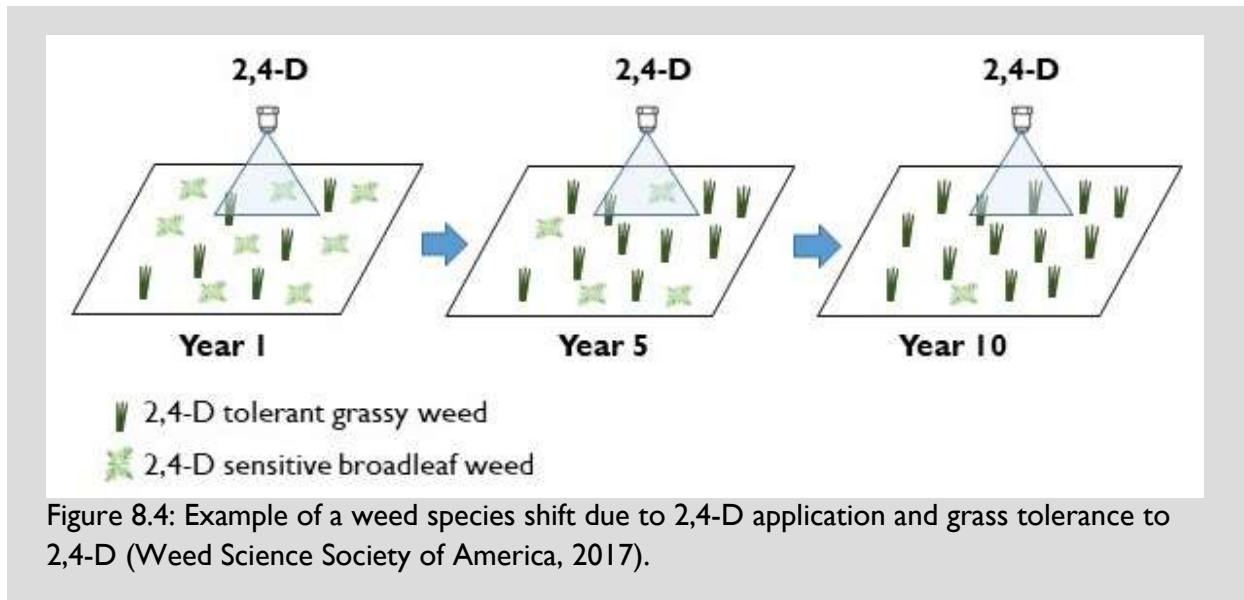

Figure 8.4: Example of a weed species shift due to 2,4-D application and grass tolerance to 2,4-D (Weed Science Society of America, 2017).

Spread of Herbicide Resistance

Once established, herbicide-resistant weeds can easily spread through the dispersal of pollen, seeds or plant parts that can easily re-root.

The movement of pollen from herbicide-resistant plants to susceptible plants as cross-pollination results in seeds that may carry the resistance gene(s). If these seeds ripen and replenish the soil seedbank, the resulting plants could survive herbicide application and further disseminate resistance through seed production. The risk of resistance spreading is higher for cross-pollinating weeds, such as pigweed, than for self-pollinating species, such as grasses. The distance that pollen can travel is determined by pollen grain size, wind velocity, the weeds ability to attract pollinators, the amount of pollen available for dispersal, and the length of time that pollen is viable for pollination. The only way farmers can prevent the spread of herbicide resistance through pollen is to eliminate suspected resistant weed species from fields and surrounding areas prior to weed bloom time.

Spread of seeds from herbicide-resistant populations is similar to herbicide-susceptible populations. See Chapter 2: *Identification and Characteristics of Weeds* and Chapter 6: *Prevention of Weeds* for information on weed seed spread and how to prevent it.

Resistance Avoidance Strategies

Herbicide resistance will evolve in a weed population if two conditions are satisfied:

1. Plants with a naturally occurring mutation that confers resistance to a specific herbicide group are already present in the weed population, and
2. This herbicide group is used extensively on these plants without use of another effective weed control tactic.

Resistance mutations within the plants are impossible to see until inadequate weed control is noticed because resistance traits are not visible on the plant. Preventing resistance issues requires reducing opportunities for resistant individuals to survive and reproduce.

Applying and rotating herbicides wisely will prevent the selection of herbicide-resistant plants. The best method is to rotate effective herbicide sites of action, either by applying multiple effective sites of action within a given crop or by alternating crops with different labeled herbicides, such as corn and soybean, between cropping seasons. Combining sites of action, either by mixing effective herbicides or applying them sequentially, can control weeds resistant to a given site of action, or delay the onset of herbicide resistance. Using labeled herbicide rates prevents the proliferation of plants that would survive at a sub-lethal rate. Also, following label recommendations about the size of the weeds when applying a postemergence herbicide is critical. Spraying plants taller than the maximum recommended size reduces the amount of herbicide that reaches the plant and results in a sub-lethal rate being applied. Non-uniform spray distribution, which can be caused by improper sprayer calibration or excessive weed density, may also decrease herbicide effectiveness and select plants that can survive a sub-lethal dose.

Herbicide-resistant management requires using two **effective** sites of action, applied at the full rate, and applied at the right timing. Tank mixing effective sites of action is more beneficial than applying the herbicides in sequence.

The rapid detection of weed resistance is crucial and relies on efficient weed scouting techniques (see Chapter 4: *Weed Scouting and Mapping*). Signs that a weed population in a field may be herbicide-resistant include the following:

- Poor herbicide performance on one weed species but not others, even though the herbicide is known to control this species.
- Patchy distribution of weeds that survived the application of herbicide that otherwise should have controlled them.
- A majority of individuals within a weed species have been controlled with an efficient herbicide while others have escaped control.

All possible actions to prevent herbicide resistant suspected plants from producing seeds should be considered. Options include hand weeding, use of an

efficient herbicide, or mechanical elimination of all surviving weeds within the affected areas which also may include crop destruction.

Key Points

- Overuse of a single herbicide mode of action may lead to the proliferation of individual weeds that can survive its labelled rate which otherwise is lethal on susceptible plants.
- Resistance can be caused by structural modification of the herbicide target within the plant (target-site) or by other metabolic or exclusion mechanisms (non-target-site).
- Resistance can result in the dominance of one weed species and the exclusion of other species.
- Environmental factors and human-related activities can contribute to herbicide-resistant weeds spreading over large distances.
- Wise use of herbicides, weed management diversification, and early detection of resistant weeds are key strategies in preventing the development and spread of herbicide resistance.

References

- Bagavathiannan MV, Norsworthy JK, Scott RC, Barber TL (2014) The spread of herbicide-resistant weeds: what should growers know? <https://www.uaex.edu/publications/PDF/FSA-2171.pdf>. Accessed: November 28, 2017
- Délye C (2013) Unravelling the genetic bases of non-target-site-based resistance (NTSR) to herbicides: a major challenge for weed science in the forthcoming decade. *Pest Manage Sci* 69:176-187
- Délye C, Jasieniuk M, Le Corre V (2013) Deciphering the evolution of herbicide resistance in weeds. *Trends Genet* 29:649-658
- Gressel J, Levy AA (2006) Agriculture: the selector of improbable mutations. *Proc Natl Acad Sci USA* 103:12215–12216
- Heap I (2018) The International Survey of Herbicide-resistant Weeds. <http://www.weedscience.org>. Accessed: September 12, 2018
- Manalil S, Busi R, Benton M, Powles S (2011) Rapid evolution of herbicide resistance by low herbicides dosages. *Weed Sci* 59:210-217

- Norsworthy JK, Ward SM, Shaw DR, Llewellyn RS, Nichols RL, Webster TM, Bradley KW, Frisvold G, Powles SB, Burgos NR, Witt WW, Barrett M (2012) Reducing the risks of herbicide resistance: best management practices and recommendations. *Weed Sci* 60 (Special issue 1):31–62
- Powles SB, Preston C (1995) Herbicide cross resistance and multiple resistance in plants. <http://www.hracglobal.com/files/Herbicide-Cross-Resistance-and-Multiple-Resistance-in-Plants.pdf>. Accessed: November 27, 2017
- Powles SB, Preston C (2006) Evolved glyphosate resistance in plants: biochemical and genetic basis of resistance. *Weed Technol* 20:282-289
- Sosnoskie LM, Webster TM, McRae AW, Grey TL, Culpepper AS (2012) Pollen-mediated dispersal of glyphosate-resistance in Palmer amaranth under field conditions. *Weed Sci* 60:366-373
- Vencill WK, Nichols RL, Webster TM, Soteres JK, Mallory-Smith C, Burgos NR, Johnson WG, McClelland MR (2012) Herbicide resistance: toward and understanding of resistance development and the impact of herbicide-resistant crops. *Weed Sci* 60 (Special issue 1):2-30
- [WSSA] Weed Science Society of America (1998) Resistance and tolerance definitions. *Weed Technol* 12:789

Chapter 9: Biological Weed Control

William Curran, Meredith Ward, and Matthew Ryan

Summary

Biological control (biocontrol) tools for weeds include insects, mites, nematodes, pathogens, and grazing animals. Grazing animals and insects can directly impact weeds and reduce their growth and competitiveness. Other biocontrol organisms will feed on weed seeds and reduce seed return to the soil seedbank.

Introduction

Biological weed control is the deliberate use of a weed's natural enemies to decrease weed density. This method does not eradicate the target weed but exerts enough pressure on it to reduce its dominance to a more acceptable level. Biological control can be cost effective, environmentally safe, self-perpetuating, and well suited to an integrated weed management program. However, it is a long-term undertaking, the effects are not always adequate to prevent weed competition with the cash crop, and it only works with certain weeds.

There are four methods of biological weed control:

- 1) Classical – using a non-native organism (usually an insect) that is released in areas infested with the targeted weed and the biocontrol organism feeds on the weed and reduces the weed population over time;
- 2) Inundative – rearing an organism in a controlled setting then releasing it at high numbers to control native or invasive weeds;
- 3) Conservation – manipulating a cropping system to increase the populations of natural weed suppressing organisms; and
- 4) Grazing – using large herbivores such as cattle or sheep to reduce weed populations.

Classic and Inundative Biocontrol

In the Northeast, classical and inundative biocontrol tactics are used on several invasive weeds, such as bull and musk thistle, Canada thistle, purple loosestrife, mile-a-minute, and garlic mustard. Along with several promising insect biocontrol tools, some rust fungi and bacteria are being evaluated for managing several weeds, including the knapweeds and the thistles. Classical biocontrol is the identification and

release of a weed predator to control an invasive weed species. Invasive weeds often establish in new areas before the arrival of predators from their home range, so introducing predators from their home range can help suppress the invasive weed. Inundative biocontrol is the use of a weed predator but rather than allow the biocontrol agent to naturally increase in numbers, the predator is bred in a controlled environment and then a large number can be released in a small area to suppress weeds. Most of the potential for classical and inundative tactics is focused in perennial systems with low annual disturbance. Frequent disturbance, such as tillage, mowing, or natural phenomena (e.g. fires or floods) greatly affects the survival of biocontrol organisms. Over the long term, these biological weed control tactics may have a major impact on managing problem weeds in rangeland, pasture systems, and natural areas. However, research is ongoing, and the true impacts remain to be seen.

Classical and inundative biocontrol tactics are not currently available in agronomic crops where disturbance is common (through tillage, mowing, or other methods). However, conservation tactics and grazing animal management have the greatest potential to reduce weed populations. Both of these tactics provide broad spectrum weed control and can be successfully used today.

Conservation Biocontrol

Conservation biocontrol relies on understanding the biology and habitat suitability of the beneficial insects or rodents that feed on weeds or weed seeds. In order for a beneficial insect or rodent to contribute to weed control, the habitat (i.e. field) must meet its needs (i.e. for adequate food and shelter). With this knowledge, management practices are adjusted so that these organisms are promoted or encouraged. Establishing a winter cover crop using no-till is a conservation biocontrol practice because it protects invertebrates in the cropping system, such as ground beetles, which consume weed seeds on the soil surface. Establishing windrows that provide habitat for rodents such as field mice is another conservation biocontrol practice. Both insects and rodents readily feed on weed seeds, potentially reducing the number of weeds that emerge the next year. Decreasing soil disturbance and providing ground cover or refuge from predators is one of the key ways to conserve these naturally occurring biocontrol organisms.

This approach creates favorable habitats for the insects and rodents already present in an area. These organisms are then active when weeds are vulnerable. Organisms that feed on weed seeds (weed seed predators) are active when weed seeds are maturing (predispersal) and after they are dispersed (postdispersal). Sole use of this method of biological control will not completely suppress weeds and limit crop yield loss. However, the combination of conservation biocontrol with other cultural, mechanical or chemical management tactics could have a greater positive impact.

Numerous organisms are weed seed predators. Some of the most common (and

promising) are rodents, ants, crickets, and ground beetles. The amount of seeds consumed will vary depending on predator populations, weed seed availability, and field management. Reducing tillage, providing residue cover, and limiting insecticide use are key field management requirements. In an Iowa study, seed predation rates from May to November ranged from 7 to 22% of available weed seeds consumed or removed per day depending on crop type (Figure 9.1) (Westerman et al. 2005). Higher predation rates were observed in small grain and alfalfa as compared to corn and soybean.

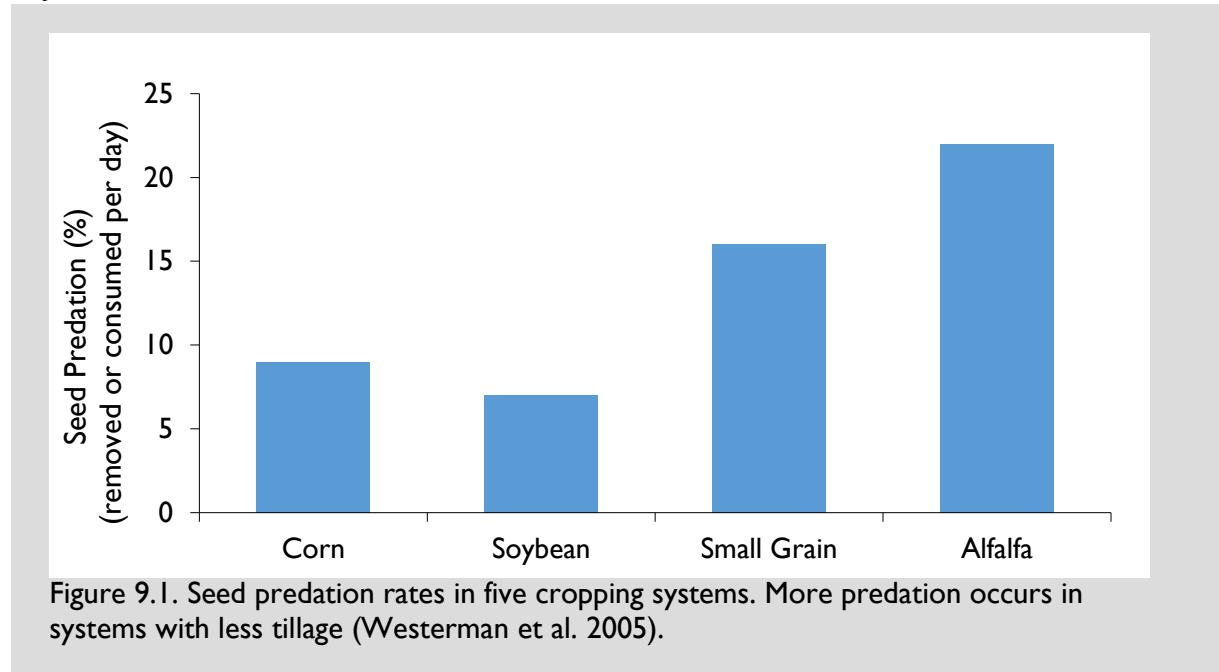

The rate of seed predation also increases as the crop canopy develops; spring-planted corn and soybean crops provide little protection for seed predators early in the growing season. In a Pennsylvania study (Ward et al. 2011), 38 to 61% of the giant foxtail seeds were removed (eaten) during two-week sampling periods in sweet corn. Peak predation occurred in late July and early August when the corn canopy was well developed (Figure 9.2). In another Iowa study, predation of giant foxtail seeds in wheat increased when red clover was planted into wheat in the spring (Davis and Liebman 2003). Seed predators likely seek habitats that provide enough cover to protect them and provide a plentiful food source.

Key seed predators have not been identified for most weeds. Best management practices to encourage weed seed predators are likewise not well-studied. However, typical farm management practices such as tillage and crop rotation can be slightly changed to incorporate practices that increase weed seed predator populations. For example, integrating a legume cover crop after small grain in a rotation can enhance predation because the plants provide protection for seed predators. Planting refuge

strips of perennial grasses around the crop field boundaries and in waterways can create favorable habitat for ground beetles, fungi, and nematodes. Increasing plant residue and decreasing tillage, especially in the fall, also can cause certain seed predator populations to flourish. Conservation biocontrol may improve our ability to manage weeds using less herbicide.

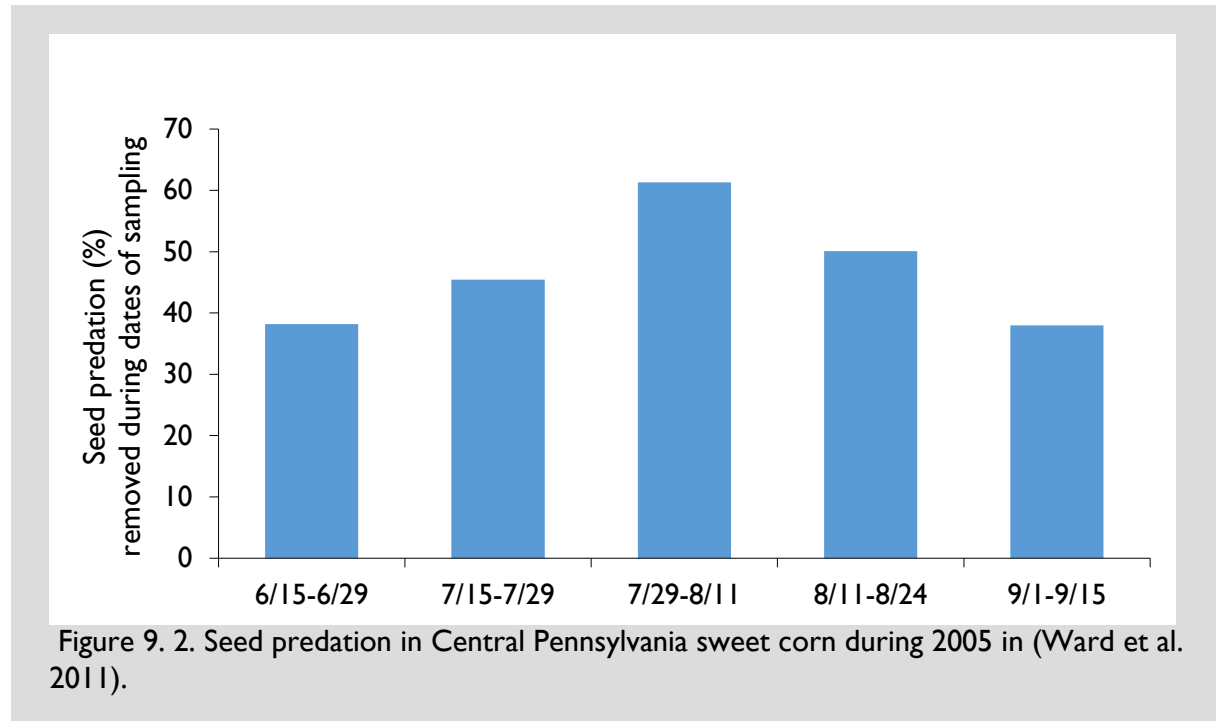

Figure 9. 2. Seed predation in Central Pennsylvania sweet corn during 2005 in (Ward et al. 2011).

Potential beneficial seed predators

Mice. Mice are opportunistic feeders, consuming high-density food sources that are easily available. As a result, seeds are their primary food source (Zhang et al. 1997). Mice can consume 90 to 100% of an area’s weed seeds in a 12-hour period (Abramsky 1983).

Rodents locate seeds using their olfactory senses and can even find seeds buried under the soil surface (Table 9.1) (Abramsky 1983). Rodents feed first on the large seeds and when bigger seeds have been consumed or removed, they then shift to smaller seeds. Mice also are one of the few weed seed predators that consistently eat hard shelled seeds (Brust and House 1988). Unfortunately, mice can be problematic in some cropping systems by feeding on crop seeds. They also may disrupt irrigation equipment, plastic mulch, and other agricultural tools. Encouraging

Table 9.1. Efficiency of buried barley seed removal by rodents (Abramsky 1983).

Depth (in)	Amount of seeds removed	
	removed (g)	% removed
0.4	102	79
1.2	104	80
2.0	70	70
6.0	47	47

vertebrate predators like mice may be best suited to large scale annual row crop production where the risk of crop or equipment damage is minimal.

Ants. Most of the research looking at ants as weed seed predators has been conducted in Europe and Australia with little information from the United States. Ants are diurnal insects that spend the day actively foraging and feeding and remain in their nests at night. Ants feed on weed species with small seeds (Brust and House 1988), such as common ragweed, redroot pigweed, and common lambsquarters. In pastures, these insects can remove 2 to 30% of Italian ryegrass seeds within 24 hours and up to 43% of small-seeded weed seeds over a 20-day interval (Jacob et al. 2006). Feeding preference studies have shown that the amount of each seed type removed by ants was strongly influenced by the amount and kinds of other seeds in the immediate area (Zhang et al. 1997). This suggests that certain weed seeds are more readily consumed than others. Ants also tend to colonize agricultural fields in high numbers. However, their activity can be reduced by tillage and high levels of crop residue or stubble (Jacob et al. 2006). This suggests that ants could be important seed predators in row crops after inter-row cultivation has ceased.

Crickets. When crickets gather in large numbers in new seedings of no-till alfalfa and clover, they are considered a pest. However, they also can be important weed seed predators. Crickets are nocturnal omnivores that consume dead and living insects, broadleaf plants, grasses, and seeds. They emerge in early August with peak activity in the middle of September and populations decreasing in October (Carmona and Landis 1999). Field observations and laboratory studies showed crickets consume common agricultural weed seeds such as velvetleaf, common lambsquarters, redroot pigweed, waterhemp, large crabgrass, common ragweed, and giant foxtail. Cricket populations tend to peak in late summer about the same time that summer annual weeds produce and shed seeds. Crickets can remove more than 76% of weed seeds in 24 hours in a m² (Figure 9.3), and a single female northern field cricket can consume over 200 redroot pigweed seeds in a single day (Carmona and Landis 1999).

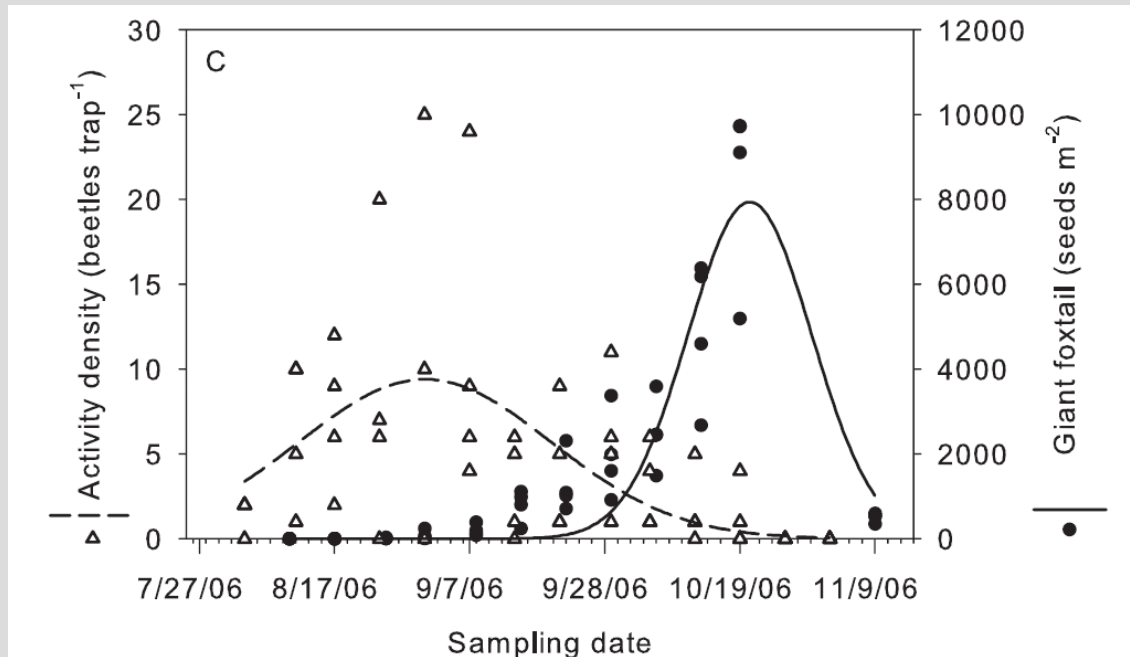

Figure 9.3. Ground beetle (*Harpalus pensylvanicus*) activity (left) and giant foxtail seed rain (right) over time in 2006 in Pennsylvania. Activity density numbers represent how many beetles are active and captured over a 72-hour period. Although the presence of the beetle overlapped with giant foxtail seed rain, beetle activity was greater in August and early September, while foxtail seeds were not dispersed until later in the fall (Ward et al. 2014)

Carabid beetles. Ground beetles, otherwise known as carabid beetles, are common throughout the Mid-Atlantic region in agricultural landscapes (Photo 9.1). *Harpalus pensylvanicus*, a common carabid found in Pennsylvania and a known seed predator, emerges from hibernation in the spring, and is most active from July through September in the Mid-Atlantic region. Adults consume plant tissue, pollen, fungi, insects and seeds, preferring small broadleaf and grass seeds (Best and Beegle 1977). Ground beetles can be responsible for up to 90% of weed seed predation in some agroecosystems. A single ground beetle can consume up to 11 seeds daily, and an active population can remove as many as 120 to 130 seeds per square foot per day (Honek et al. 2003). However, ground beetle activity does not always coincide when weeds seeds are shed from the plant (Figure 9.3) (Ward et al. 2014).

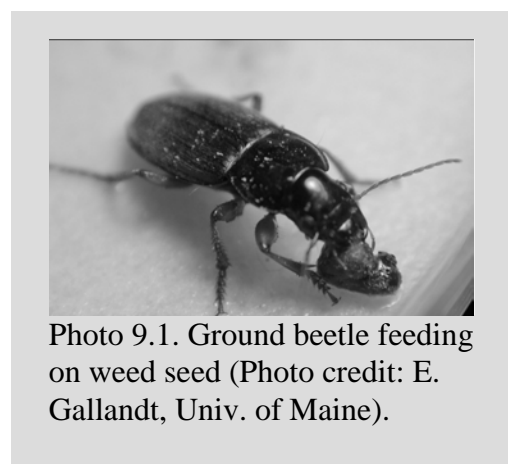

Photo 9.1. Ground beetle feeding on weed seed (Photo credit: E. Gallandt, Univ. of Maine).

Unlike rodents, ground beetles do not survive intense disturbances, such as fall or spring plowing. Fortunately, many of these insects are fairly mobile and can abandon fields in autumn to overwinter in fence rows, field edges, and water ways. They do not necessarily prefer one crop over another but may prefer different crop types throughout the growing season. Decreasing or eliminating soil disturbance, especially in the late summer when beetles are feeding, mating, and laying eggs, can increase ground beetle activity.

Although conservation biocontrol could be an important part of a weed management program, additional research is needed to completely understand this tactic. Individual farmers can incorporate practices that encourage weed seed predation and monitor how these practices affect their weed management program. Integrating conservation biocontrol is only one tool in a suite of practices that complement each other to reduce the annual return of weed seeds to the seedbank.

Grazing Animals

Grazing management can minimize the spread of certain weeds and control large weed infestations. However, in most cases, grazing does not eradicate a mature infestation of weeds. For grazing animals to be useful for weed control, fencing maybe required to adjust grazing pressure. Increasing grazing pressure by increasing animal numbers and grazing duration at key times during the growing season prevents livestock from grazing selectively (eating some plants and not others). They then must consume more undesirable species. The key to this method of weed control is to concentrate stock on weed infestations at key stages of weed growth and keep them off pasture or weeds at other times (Popay and Field, 1996). Grazing animals for weed control is limited to time periods between crops or shortly after the crop is established when grazing can be tolerated and the crop is able to recover quickly.

Key Points

- Biological control tools for weeds include insects, mites, nematodes, pathogens, and grazing animals.
- Biological control can be cost effective, environmentally safe, self-perpetuating, and well suited to an integrated weed management program.
- Biological control is a long-term undertaking: it is not immediate or always adequate, only certain weeds are potential candidates, and the rate of failure can be high.
- Seed predation can be responsible for up to 90% of seed loss in agroecosystems.
- Some of the most promising seed predators are rodents, ants, crickets, and ground beetles.
- Reduced tillage can increase predation because weed seed predation occurs mostly on the soil surface.
- Cover crops create better habitats for seed predators.
- Promote and maintain diverse fencerows, filter strips, and refuge habitats that allow overwintering and protection for ground beetles, rodents, crickets and other seed predators.

References

- Abramsky Z (1983) Experiments on seed predation by rodents and ants in the Israeli desert. *Oecologia* 57:328-332
- Best RL, Beegle CC (1977) Food preference of five species of carabids commonly found in Iowa corn fields. *Environ Entomol* 6:9-12
- Brust GE, House GJ (1988) Weed seed destruction by arthropods and rodents in low-input soybean agroecosystems. *Am J Alt Agric* 3:19-25
- Carmona DM, Landis DA (1999) Influence of refuge habitats and cover crops on seasonal activity-density of ground beetle (Coleoptera: Carabidae) in field crops. *Environ Entomol* 28:1145-1153
- Davis AS, Liebman M (2003) Cropping system effects on giant foxtail (*Setaria faberii*) demography: I. Green manure and tillage timing. *Weed Sci* 51:919-929
- Honek A, Martinkova Z, Jarosik V (2003) Ground beetles (Carabidae) as seed predators. *Eur J Entomol* 100:531-544

- Jacob HS, Minkey DM, Gallagher RS, Borger CP (2006) Variation in postdispersal weed seed predation in a crop field. *Weed Sci* 54:148-155
- Popay I, Field R (1996) Grazing animals as weed control agents. *Weed Technol* 10:217-231
- Ward MJ, Ryan MR, Curran WS, Law J (2014) Giant foxtail seed predation by *Harpalus pennsylvanicus* (Coleoptera: Carabidae). *Weed Sci* 62:555-562
- Ward MJ, Ryan MR, Curran WS, Barbercheck ME, Mortensen DA (2011) Cover crops and disturbance influence activity-density of weed seed predators. *Weed Sci* 59:76-81
- Westerman PR, Wes JS, Kroff MJ, Van Der Werf W (2003) Annual losses of weed seeds due to predation in organic cereal fields. *J Ecol* 40:824-836
- Zhang J, Drummond F, Liebman M, Hartke A (1997) Insect Predation Of Seeds and Plant Population Dynamics.
https://digitalcommons.library.umaine.edu/aes_techbulletin/39/. Accessed December 16, 2017

Chapter 10: Cultural Control

Charlie Cahoon

Summary

Cultural weed control consists of crop rotation, variety selection, soil fertility, planting date, seeding rate, row spacing, leaf architecture, and disease and insect management (in other words, good agronomic practices). These methods are used to produce a healthy crop that can efficiently compete with weeds. Achieving rapid crop canopy closure and maintaining a dense crop canopy is the cornerstone of integrated weed management.

Introduction

Crops and weeds continually compete for valuable resources, including light, nutrients, water, and space. Cultural weed control encompasses any tactic that creates a competitive advantage for a crop. A competitive and healthy crop better suppresses weed growth. Ultimately, this comes down to a “survival of the fittest” contest between crops and weeds.

Many cultural tactics for weed management have been employed since the beginning of cultivated agriculture, but their contributions to weed control are often overlooked. Examples of these tactics are selecting varieties adapted to the area; manipulating seeding rates, row spacing, and planting dates; maintaining soil fertility; scouting for and controlling insects and diseases; and rotating crops. To boost crop yield, quality, and economic return, farmers frequently employ all of these tactics. Many of these tactics establish a crop canopy quickly and maximize the amount of sunlight captured by the crop. The amount of light available to weeds then decreases. The following sections will discuss specific cultural weed management tactics more in depth.

Crop Rotation for Weed Management

Crop rotation often increases crop yield by improving soil fertility and suppressing insects and disease. Strategic crop rotation also increases the crop’s ability to suppress weed growth.

Planting crops with varying growth habits, growing seasons, and characteristics disrupts weed life cycles. Each crop has different optimum planting dates and weed management schedules. Farmers can use these varying schedules to manipulate their

cropping systems and prevent the dominance of a weed species. For example, Italian ryegrass is a troublesome winter annual weed that infests winter small grain. To avoid Italian ryegrass, farmers can plant summer annual crops and work to control Italian ryegrass before the summer cash crop is planted and before it produces seeds. After ensuring Italian ryegrass does not reproduce for a few seasons, the farmer can return to growing winter small grain. Then Italian ryegrass will be less of a problem.

Using a more competitive crop to suppress certain weeds prior to planting a less competitive crop also can be helpful. A more competitive crop will rapidly establish its canopy or maintain its canopy longer, while a less competitive crop is slow to develop a canopy or may have a short-lived canopy. For example, in a Maryland study, researchers observed that corn planted after hay had fewer smooth pigweed and common lambsquarters than corn planted after soybean (Teasdale et al. 2004b). Smooth pigweed and common lambsquarters, which are more competitive with soybean than a densely planted hay crop, produced more seed in soybean than hay. In addition, the hay crop was periodically mowed, which reduced seed production of smooth pigweed and common lambsquarters. This resulted in a greater weed problem in corn planted after soybean compared to corn planted after hay. The opposite was true for grass species, grasses are difficult to control in hay. Annual grasses were denser in corn planted after hay than in corn planted after soybean.

Crop rotation also is important when planning herbicide programs. Herbicide use varies by crop, and rotating crops means farmers can alternate herbicide sites of action (see Chapter 7: *Chemical Control*), which is essential in avoiding herbicide resistance. Additionally, the ease of controlling a certain weed in a rotational crop often depends on what herbicides are available for use in that crop. For example, in the Mid-Atlantic region, common lambsquarters was found to be more easily controlled in a corn-soybean and corn-tomato-soybean rotation than in a continuous soybean system (Manley et al. 2001) (Figure 10.1). In this study, each crop received a different combination of herbicides. Soybean plots received a mixture of fomesafen (Reflex®) and fluazifop plus fenoxaprop (Fusion®); corn plots received a mixture of atrazine and butylate (Sutan +); and tomato plots received a mixture of metribuzin and trifluralin (Treflan®). Because the mixture of fomesafen and fluazifop plus fenoxaprop did not effectively control common lambsquarters, the weed could reproduce in years when soybean were grown.

In contrast, herbicides used for corn and tomato plots controlled common lambsquarters well, so common lambsquarters density decreased when these crops were incorporated into the rotation. Although Figure 10.1 indicates that common

lambsquarters control was best in the continuous corn (C-C-C-C) treatment, diverse crop rotations are necessary to decrease herbicide resistance development.

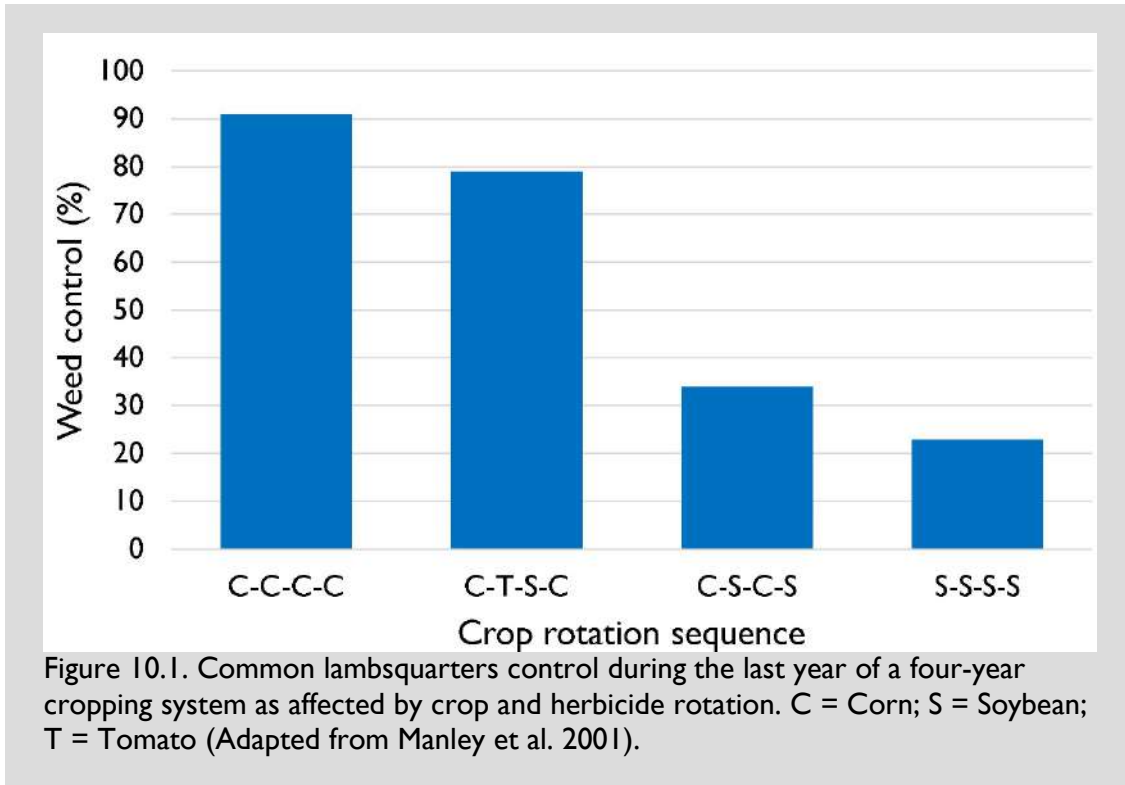

Crop Variety Selection

Selecting vigorous crop varieties limits competition from weeds and reduces weed seed production. Farmers should plant crop cultivars most adapted to local planting date and growing conditions. Varieties that quickly form a dense canopy are often more competitive than slower growing cultivars. In addition, full-season varieties may be more competitive compared to earlier-maturing varieties because their canopy stays fuller longer, shading out weeds. In one study, North Carolina researchers reported seeing more late-season weeds in an early-maturity soybean cultivar than in a full-season variety after a postemergence spray (Yelverton and Coble 1991). A crop's early leaf shed allows more light to penetrate the canopy, allowing weed development late in the season. Canopies of later-maturing varieties impeded light for a longer duration than early-maturing varieties. Likewise, another North Carolina study reported three winter wheat varieties differed in their abilities to suppress Italian ryegrass (Worthington et al. 2013). In this study, tall cultivars were more competitive than short cultivars with Italian ryegrass by decreasing light penetration through the canopy compared to shorter cultivars. Farmers also should consider disease and insect tolerance in variety selection, since varieties affected by disease or insects are not as effective in developing a dense canopy.

Soil Fertility

Farmers often apply soil amendments, such as fertilizers and lime, to achieve higher crop yields. However, these amendments also jumpstart crop growth, establishing a competitive advantage over weeds. For example, wheat is more responsive to nitrogen than the weed Persian darnel (Blackshaw and Brandt 2008). Persian darnel growth is favored when the soil is low in nitrogen. Therefore, wheat can better compete with Persian darnel with sufficient nitrogen. A similar phenomenon is seen with phosphorus: wheat is more competitive with downy brome, henbit, and wild oats under low phosphorus conditions because wheat is less responsive to phosphorus than the weeds (Blackshaw and Brandt 2004). Soybean are capable of creating their own nitrogen with nitrogen-fixing bacteria. Limiting external nitrogen while producing soybean prevents weeds from obtaining of an essential nutrient without penalty to the crop.

Soil pH also can favor one species over another. Most plants grow best at slightly acidic to near neutral soil pH. However, some plants require more acidic or alkaline conditions. Buchanan et al. (1975) reported large crabgrass could tolerate soil pH as low as 4.8, whereas redroot pigweed was less vigorous at pH 5.3 or below. This means that under acidic conditions, when most plants suffer, some weeds gain the upper hand.

Maintaining a competitive crop means paying close attention to soil fertility and supplying soil amendments, such as nitrogen, phosphorus, potassium, other nutrients, or lime, in a timely manner. Consider the 4 Rs of nutrient stewardship: right source, right rate, right time, and right place when fertilizing crops to ensure the crop is healthy and can compete with weeds to the best of its ability (Figure 10.2) (TFI 2017). Right source means choosing a fertilizer that best matches your crop's nutrient needs. The right rate is achieved by matching fertilizer rates with crop nutrient demand. Fertilizer applications should focus on feeding the crop. Supplying only what the crop needs limits surplus nutrients that otherwise would be used to improve weed growth. Coordinating fertilizer applications when the crop needs nutrients corresponds to the right time. And right place means placing nutrients where the crop can best utilize them. A nutrient's close proximity to a crop allows roots to readily access nutrients that weeds may not access. Following the 4Rs prevents the waste of money spent on excess fertilizer.

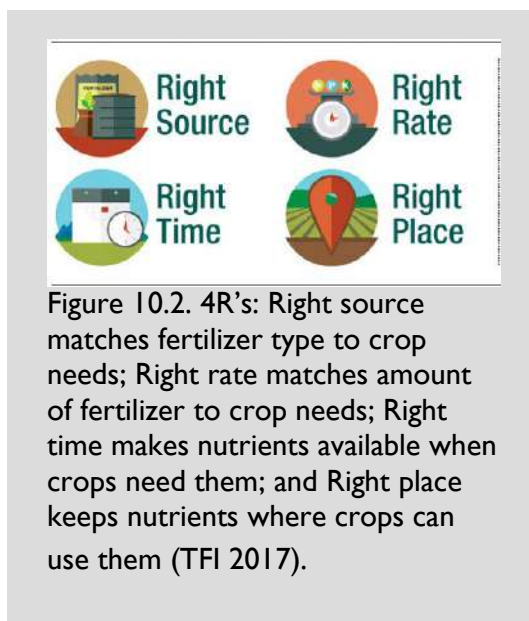

Planting Date

Planting date can be strategically planned to give crops or cover crops a competitive edge. If planned strategically, planting date can give crops a competitive edge. Farmers should choose planting dates that encourage a crop's rapid emergence (warm seedbed, warm air temperatures, and adequate soil moisture), early-season growth, and formation of a dense canopy. The goal is to rapidly form a dense crop canopy that efficiently gathers sunlight and shades out weeds.

Planting crops when conditions are not favorable for weed germination and development is also important. A Maryland experiment studied the effect of a planting delay in corn on plant weight of several weed species (Teasdale and Mirsky 2015). In this study, common ragweed, giant foxtail, and corn weight changed little over planting dates ranging from May 7 to June 30. However, smooth pigweed weight increased 10.5 grams from the earliest to latest planting date. This means that early planted corn was more competitive with smooth pigweed than the later planted crop.

Knowing when weeds emerge can be useful in determining planting dates that give crops a competitive advantage over weeds. While the start of the weed seed germination period varies each year, the emergence sequence of weed species is fairly consistent (see Chapter 3: *Weed Emergence, Seedbank Dynamics, and Weed Communities*, see Figure 3.2). For example, common ragweed is one of the first summer annual broadleaf weeds to emerge during the spring. Pigweed species normally germinate later than common ragweed. When planting corn, early-emerging weed species, such as common ragweed or common lambsquarters pose more of a threat than late-emerging weeds like pigweed species. Early-emerging weeds may germinate before or shortly after corn emerges, giving them the opportunity to use light, moisture, nutrients, and space that would otherwise be available to the corn. However, late-emerging species may not germinate until after a dense corn leaf canopy has been established.

Germination of early-emerging weeds would be near completion when soybean are planted. These weeds can be removed by mechanical or chemical methods prior to planting soybean with less chance of more weeds emerging after planting. Late-emerging weeds will be a bigger issue in soybean planting than in corn. With this knowledge, farmers can adjust planting dates such that crop and weed emergence do not occur simultaneously (Myers et al. 2004).

Planting date also plays an important role in cover crop biomass accumulation and subsequent weed control by the cover crop. Nord et al. (2012) reported cereal rye sown in September accumulated more biomass and suppressed weeds better than cereal rye sown in October. Likewise, hairy vetch (Teasdale et al. 2004a) and mixtures of rye and hairy vetch (Mirsky et al. 2011) biomass declines as planting is delayed and subsequent weed control is reduced. Because cover crops planted early in the fall accumulate more biomass, they may better suppress weeds the following spring (see Chapter 12: *Cover Crops for Weed Suppression*)

Seeding Rate, Row Spacing, and Leaf Architecture

Achieving rapid crop canopy closure is critical to establishing a competitive advantage over weeds and is key to cultural weed management. Crop canopy closure interrupts a weed's ability to intercept light, suppressing weed growth and development (Yelverton and Coble 1991). Seeding rate and row spacing adjustments are cost effective ways to enhance canopy closure. Crops planted at high seeding rates can reach canopy closure sooner than crops planted at low seeding rates. Many studies from the Mid-Atlantic region have demonstrated that increased seeding rates and narrow row spacing provide weed control benefits. In an organic soybean production system, redroot pigweed density decreased from approximately 32,000 plants per acre to 12,000 plants per acre as soybean seeding rate increased from 75,000 seeds per acre to 225,000 seeds per acre (Place et al. 2009). In general, soybean seeding rates less than 80,000 seeds per acre experienced higher weed density or less weed control (Bell et al. 2015; Jha et al. 2017). Similarly, increasing spring wheat seeding rate by 50% (1.6 to 2.4 million seeds per acre) reduced mustard density by 36%, biomass by 37%, and seed production by 42% (Kolb et al. 2012). In North Carolina, increasing sorghum seeding rate from 80,000 seeds to 120,000 seeds per acre, improved weed control (Besançon, et al. 2017). The effectiveness of increasing seeding rates is generally reduced when preemergence herbicides are used.

Using narrow row spacing has a similar effect on weed density. Narrow rows allow for quicker canopy establishment. North Carolina researchers studied the effects of row spacing on late-season weed resurgence in soybean (Yelverton and Coble 1991). Compared to soybean grown in 36-inch rows, late-season weed resurgence was reduced 43 to 86% by growing soybean in 18-inch rows. Growing soybean in 9-inch rows reduced weed resurgence even more (Figure 10.2). In a Maryland study, researchers reported the canopy of corn grown in 15-inch rows closed one week earlier and was more competitive with weeds than corn grown in 30-inch rows (Teasdale 1995). But in general, narrow row soybean are more likely to impact weed competition than narrow row corn (Bradley 2006).

Leaf architecture of a crop also affects the ability of a crop canopy to intercept sunlight. Horizontally-oriented leaves capture more light than vertically-oriented leaves, reducing weed density, weed biomass, and weed seed production (Sankula et al. 2004). Farmers should use these strategies to produce a crop that efficiently captures sunlight, while at the same time limiting light available to weeds.

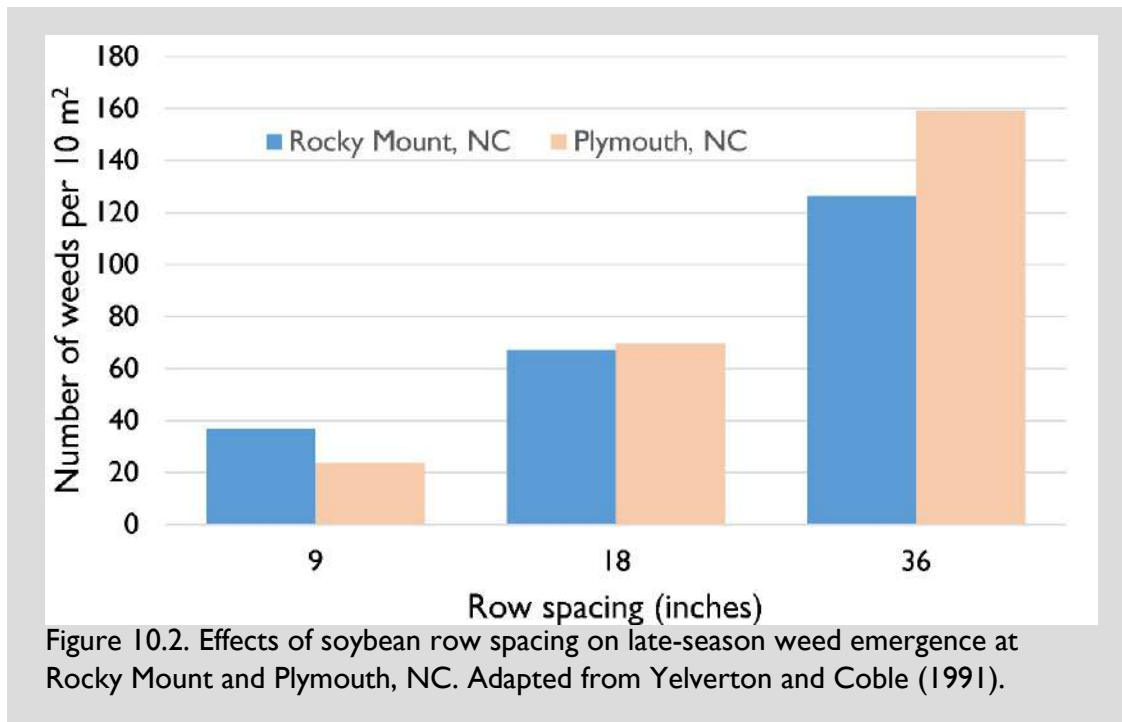

Disease and Insect Control

Although diseases, insects, and weeds are often separated into different pest categories, controlling one can influence another. Many diseases and insects can defoliate crops. Premature crop defoliation increases light available to weeds. For example, many insects feed on soybean leaves. Holes created in leaves or leaf drop caused by intense feeding allow more sunlight to penetrate the soybean canopy, which is then available to suppress weed growth. Because of this, farmers may need to control weeds for a longer period of time in a crop defoliated by insect pests than in a non-defoliated crop. For example, Nebraska researchers reported that a soybean crop defoliated by 60% required weed control for an additional 14 days (Gustafson et al. 2006).

Farmers will see similar trends when encountering diseases that cause defoliation. Severe infections of bacterial blight, downy mildew, and soybean rust are some of the diseases that can defoliate soybean (Faske et al. 2014).

From an Integrated Weed Management standpoint, farmers should routinely scout for disease and insects and control these pests when necessary (see Chapter 4: *Weed Scouting and Mapping*). It is important to remember that a healthy crop, free of disease and insects, maintains its competitive advantage over weeds.

Key Points

- Any tactic that improves the ability of a crop to compete with weeds is considered a cultural method of weed control.
- Some weeds are easier to control in certain crops; making crop rotation a good strategy for reducing weed populations.
- A healthy crop competes better with weeds.
 - Be sure the fertility demands of your crop are met,
 - Ensure your crop is free of disease and insects.
- Rapid germination and early-season growth is key to choosing varieties that can better compete with weeds.
- Plant crops and cover crops when conditions favor crop development and less favorable for weed growth.
- Time of weed emergence varies by species; choose a planting date that gives your crop an advantage.
- Quickly forming a dense crop canopy is critical to disrupting weed germination and growth. This can be achieved by the following:
 - Selecting vigorous varieties adapted to local conditions;
 - Increasing seeding rates;
 - Planting the crop on narrow row spacing;
 - Choosing varieties or a crop with leaf orientation that limits light penetration.

References

- Bell, HD, Norsworthy JK, Scott RC, Popp M (2015) Effect of row spacing, seeding rate, and herbicide program in glufosinate-resistant soybean on Palmer amaranth management. *Weed Technol* 29:390-404
- Besançon T, Heiniger R, Weisz R, Everman W (2017) Weed response to agronomic practices and herbicide strategies in grain sorghum. *Agron J* 109:1642-1650
- Blackshaw RE, Brandt RN (2008) Nitrogen fertilizer rate effects on weed competitiveness is species dependent. *Weed Sci* 56:743-747
- Blackshaw RE, Brandt RN, Janzen HH, Entz T (2004) Weed species response to phosphorus fertilization. *Weed Sci* 52:406-412
- Bradley KW (2006) A review of the effects of row spacing on weed management in corn and soybean. *Crop Manag Online* at doi:10.1094/CM-2006-0227-02-RV

- Buchanan GA, Hoveland CS, Harris MC (1975) Response of weeds to soil pH. *Weed Sci* 23:473-477
- Faske T, Kirkpatrick T, Zhou J, Tzanetakis L (2014) Soybean Diseases *in* Arkansas Soybean Production Handbook: Chapter 11. Accessed March 30th, 2018 at <https://www.uaex.edu/publications/pdf/mp197/chapter11.pdf>
- Gustafson TC, Knezevic SZ, Hunt TE, Lindquist JL (2006) Early-season insect defoliation influences the critical time for weed removal in soybean. *Weed Sci* 54:509-515
- Jha P, Kumar V, Godara RK, Chauhan BS (2016) Weed management using crop competition in the United States: A review. *Crop Protect* 95:31-37
- Kolb LN, Gallandt ER, Mallory EB (2012) Impact of spring wheat planting density, row spacing, and mechanical weed control on yield, grain protein, and economic return in Maine. *Weed Sci* 60:244-253
- Manley BS, Wilson HP, Hines TE (2001) Weed management and crop rotations influence populations of several broadleaf weeds. *Weed Sci* 49:106-122
- Mirsky SB, Curran WS, Mortensen DM, Ryan MR, Shumway DL (2011) Timing of cover-crop management effects on weed suppression in no-till planted soybean using a roller-crimper. *Weed Sci* 59:380-389
- Myers MW, Curran WS, VanGessel MJ, Calvin DD, Mortensen DA, Majek BA, Karsten HD, Roth GW (2004) Predicting weed emergence for eight annual species in the northeastern United States. *Weed Sci* 52:913-919
- Nord EA, Ryan MR, Curran WS, Mortensen DA, Mirsky SB (2012) Effects of management type and timing on weed suppression in soybean no-till planted into rolled-crimped cereal rye. *Weed Sci* 60:624-633
- Place GT, Reberg-Horton SC, Dunphy JE, Smith AN (2009) Seeding rate effects on weed control and yield for organic soybean production. *Weed Technol* 23:497-502
- Sankula S, VanGessel MJ, Mulford R (2004) Corn leaf architecture as a tool for weed management in two corn production systems. *Weed Sci* 52:1026-1033
- Teasdale JR (1995) Influence of narrow row/high population corn (*Zea mays*) on weed control and light transmittance. *Weed Technol* 9:113-118
- Teasdale JR, Devine TE, Mosjidis JA, Bellinder RR, Beste CE (2004a) Growth and development of hairy vetch cultivars in the northeastern United States as influenced by planting and harvesting date. *Agron J* 96:1266-1271
- Teasdale JR, Mangum RW, Radhakrishnan J, Cavigelli MA (2004b) Weed seedbank dynamics in three organic farming crop rotations. *Agron J* 96:1429-1435

- Teasdale JR, Mirsky SB (2015) Tillage and planting date effects on weed dormancy, emergence, and early growth in organic corn. *Weed Sci* 63:477-490
- The Fertilizer Institute (2017) The Nutrient Stewardship: 4R Pocket Guide.
<http://www.nutrientstewardship.com/4r-pocket-guide> Accessed: March 19, 2019
- Worthington ML, Reberg-Horton SC, Jordan D, Murphy JP (2013) Comparison of methods for evaluating the suppressive ability of winter wheat cultivars against Italian ryegrass (*Lolium perenne*). *Weed Sci* 61:491-499
- Yelverton FH, Coble HD (1991) Row spacing and canopy formation reduces weed resurgence in soybean (*Glycine max*). *Weed Technol* 5:169-174

Chapter 11: Thermal Weed Control

Mark VanGessel

Summary

Thermal weed control relies on intense temperatures to rupture plant cells and rapidly kill plant tissue. This technique is more effective on small broadleaf weeds with an exposed growing point than on large weeds or grasses. While thermal weed control is not a common practice for grain farmers in the Mid-Atlantic region, it has been used effectively in other regions of the U.S.

Introduction

Thermal weed control is the suppression of weeds using heat applied in the form of either open flame (torch type) or infrared radiation, has been trialed and adopted by some farmers. Commercial tractor-mounted flaming units are available, but thermal weed control is not widely used in the Mid-Atlantic region. Thermal weed control units produce up to 2000° F, directed at weeds that instantaneously ruptures plant cells and cause rapid desiccation of the exposed tissue.

Equipment

Flame weeding uses torches with nozzles that dispense a narrow stream of propane that is ignited and generates heat (Photo 11.1). Several torches are mounted along a tool bar behind a tractor. Torches are adjustable with the ability to alter height, angle, and direction. Shields can be added to confine the heat and target weeds and protect the crop (Photo 11.2). Flame weeders can be used before as well as after planting to control weed seedling. They also



Photo 11.1. Flame weeder with torches directing flames on both sides of the crop. The height, direction, and angle of the torches are adjustable (Photo credit: Michigan State Univ. Extension Bulletin E-3038).

can be used after the crop has grown enough to have a height difference between the taller crop and shorter weeds.

Calibrating a flamer depends on factors such as propane pressure, operating speed, and arrangement of flame torches.

Tractor speed with a flamer falls in the range of three to six mph and typical propane pressure range is 25 to 65 pounds per square inch (psi). A “finger print test” can be used immediately after flaming to

determine the method’s effectiveness. The finger print test is simply placing a leaf between the thumb and index finger and pressing firmly. If a darkened fingerprint is visible, plant cells have ruptured and cell death will occur, rapidly followed by brown dead leaves and stems (Datta and Knezevic 2013).

Infrared weeders also are available. These are ceramic surfaces heated with gas that contact weed leaves and stems. Plant injury and death from infrared units is to propane torches. Infrared weeders are used for targeted areas (close proximity to the crop row) rather than the broad applications of flamers.

Heat from microwave units has been researched for weed control, but this technology has not yet been commercialized. Hot water and hot steam also have been used on a small scale, but they are not as effective as flamers.

Techniques

Thermal weed control relies on intense temperatures to rupture plant cells, denature plant proteins, and rapidly kill plant tissue. Weed species and growth stage affect the results of the method. As a general rule, the method will be most effective when weeds have less than four true leaves. It can kill the aboveground portion of perennial plants, but will not impact underground vegetative structures or weed seeds in the soil because heat is not transferred into the soil.

Leaf wetness can affect the effectiveness of thermal weed control. Dry leaf surfaces are more likely to be damaged and killed than moist or wet leaves. Avoid flaming in fields with high levels of cover crop residue, dry leaves and stems could ignite. Flaming could be combined with row-crop cultivation: weeds close to the crop row are flamed and weeds between the rows are controlled by a cultivator. Flamers do not disturb the soil, which reduces the likelihood of causing additional weed emergence.



Photo 11.2. Flame weeder with torches under hoods to improve safety of the crop and prevent heat from dissipating too quickly (Photo credit: Agricultural Flaming Innovations).

However, not all crops tolerate thermal weeding in the same way. Some crops have a thick cuticle that may provide some protection; some plants have growing points that are protected from heat damage; and some plants have stem tissue that is able to tolerate heat.

Some crops can be flamed only at certain stages. Flame weeding can be used in corn when the plant is less than one inch tall because at this time, corn's growing point is underground and surrounded by developing leaves. Corn tolerates flaming from emergence until the three-leaf stage; corn flamed during this period can result in reduced leaf tissue, but final yield is rarely reduced. If flaming is done after the five-leaf stage, heat should be kept below the crop canopy. Lower leaves may show heat damage, but the effect does not impact yield (Datta and Knezevic 2013).

soybean are not as tolerant of flame weeding as corn since soybean's growing point is at the top of the plant where it is exposed to the high temperatures. Flame weeding from the unifoliate to third trifoliate stages is not recommended because soybean are short, which makes it difficult to safely direct the heat beneath the crop's canopy (Knezevic et al. 2014).

Key Points

- Thermal weed control requires intense heat and is highly dependent on fossil fuels.
- Crop safety is species dependent; corn is more tolerant to flaming than soybean.
- Selective placement of the flame or heat source prevents contact with, and damage to, the crop.

References

- Datta A, Knezevic SZ (2013) Flaming as an alternative weed control method for conventional and organic agronomic crop production systems: A review. *Adv Agron* 118:399-428
- Knezevic SZ, Datta A, Bruening C, Gogos G (2014) Propane-fueled flame weeding in corn, soybean, and sunflower. University of Nebraska and Propane Education and Research Council, 40 p
- Mutch DR, Thalmann SA, Martin TE, Baas DG (2008) Flaming as a method of weed control in organic farming systems. Michigan State University Ext. Bull. E-3038, 4 p

Chapter 12: Cover Crops for Weed Suppression

Jess Bunchek, Steven Mirsky, Victoria Ackroyd, and William Curran

Summary

Cover crops play a significant role in a multi-tactic approach to weed management. As herbicide-resistant weeds have become more prominent, interest in the use of cover crops for weed suppression has increased. In the Northeast, growing interest in organic products also has increased interest in cover crops for their role in weed suppression. Cover crops suppress weeds most effectively when actively growing, outcompeting weeds for essential resources (light, nutrients, water, and space). Cover crops affect weed germination and emergence by reducing the amount of light that reaches the soil surface, lowering soil temperatures, and providing a physical mulch or barrier after plants have been terminated. Cereal cover crops can also tie-up (immobilize) nitrogen, making it less available for weeds. Furthermore, cover crops can release phytotoxic compounds that affect small-seeded weeds. Species selection and management of cover crops determine the effectiveness in weed suppression.

Introduction

A cover crop is a plant that is grown in a cash crop field at times when a field would otherwise be fallow. Cover crops are multifunctional tools that provide a variety of agroecosystem services beyond weed suppression (Hartwig and Ammon 2002). They support crop productivity and farm profitability by providing better erosion control, tighter nutrient cycling, and greater water infiltration than bare ground. They also can increase organic matter and biodiversity in the soil when compared to bare ground. The recent interest in cover crops for weed management is the result of the time and cost of weed management in all cropping systems, the challenges associated with controlling weeds in organic systems, and the development and spread of herbicide-resistant weeds.

In the Northeast, some common winter annual cereal cover crop species include cereal rye, wheat, and triticale. Common winter annual and perennial legumes include hairy vetch, crimson clover, and medium red clover. All of these plants are winter annuals that are established in the fall after corn or soybean harvest. Medium red clover, a perennial, also can be frost-seeded into wheat. Brassica species such as forage

radish or canola/rapeseed are often planted in the fall, although radish usually does survive the winter. Other cover crops, such as sorghum-sudangrass and millet, can be sown in the early spring prior to planting summer vegetables.

Cover crop implementation and management directly and indirectly suppresses weeds at multiple weed life stages (Figure 12.1). Live cover crops suppress weeds by competing with them for space, nutrients, water, and light.

Weeds also are directly suppressed at the time of cover crop termination. Weed suppression, particularly for summer annual weeds, is proportional to cover crop biomass levels: as cover crop biomass increases, weed biomass decreases (Mohler and Teasdale 1993). Good

ground cover early in the spring reduces weed germination and emergence by reducing light at the soil surface and lowering soil surface temperatures (Figure 12.2).

Management strategies that influence a cover crop's ability to suppress weeds include cover crop species and mixture combination selection, seeding rate, planting and termination timing and method, and application timing, type, and rate of nutrients. Cover crop management decisions also should weigh the specific weed problem. For example, perennial weeds are less affected than annual weeds by cover crop residues (also called mulch) (Mirsky et al. 2011; Mirsky et al. 2012). However, implementing cover crops in conjunction with other cultural practices, such as narrow cash crop row spacing, can have synergistic effects on perennial weed management. Carefully managing cover crops in combination with other cultural practices can manage existing weed populations, slow the development of new weeds, and provide other ecological services (see Chapter 10: *Cultural Control*) (Gallagher et al. 2003).

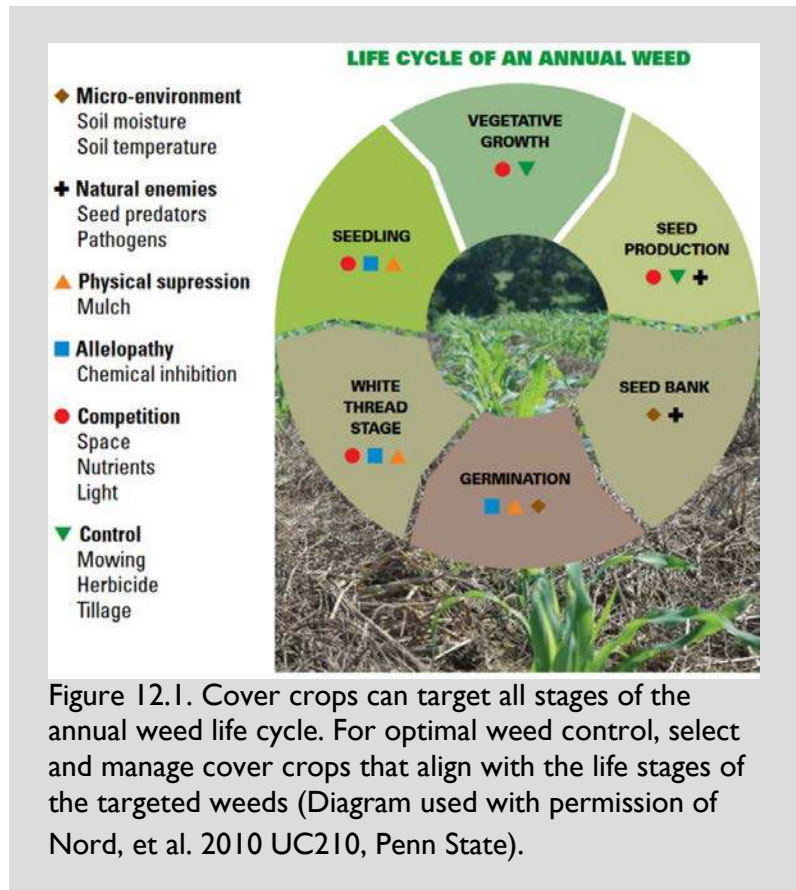
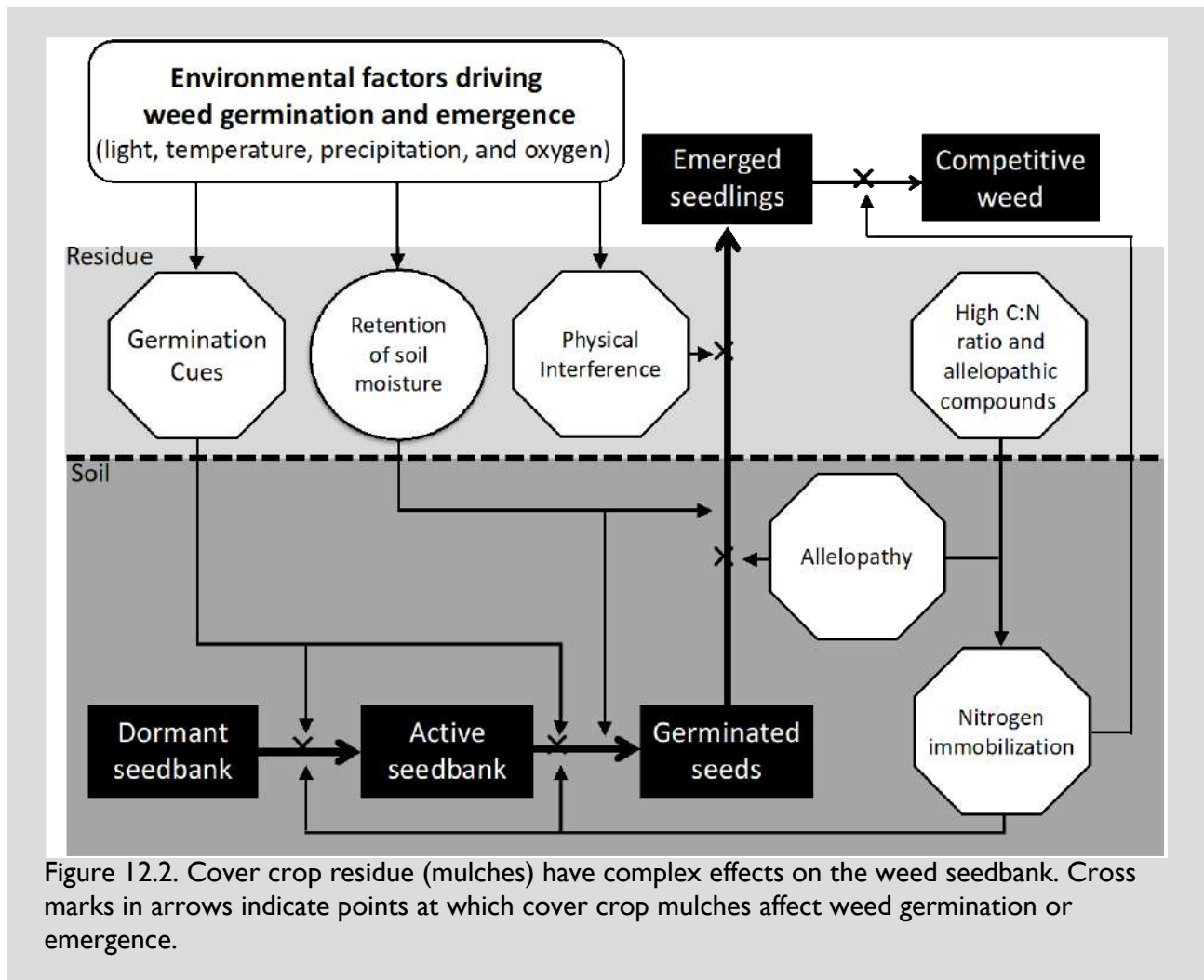

Figure 12.1. Cover crops can target all stages of the annual weed life cycle. For optimal weed control, select and manage cover crops that align with the life stages of the targeted weeds (Diagram used with permission of Nord, et al. 2010 UC210, Penn State).



Crop Rotations and Cover Crop Integration

Cover crop species are categorized as

- fall planted that survive the winter (overwinter),
- fall planted that winter kill,
- biennial and perennial, and
- summer planted with winter kill.

Fall-planted winter-kill cover crops like spring oats and forage radish quickly establish dense ground cover and can control fall-emerging weeds like horseweed (or maretail) and chickweed better than winter-hardy cover crop species that establish more slowly. Fall-planted winter-hardy cover crops like cereal rye and red clover produce most of their biomass between spring green-up (when the plants break dormancy and begin growing again) and termination. This spring growth is crucial to

control spring-emerging winter annual weeds and early-emerging summer annual weeds. Delaying cover crop termination typically increases biomass for ground cover and smothers competing weeds. Cereal grains are typically planted at one to two bushels per acre, and legumes like hairy vetch and clovers should be planted at about 20 pounds per acre. Seeding rates will vary, depending on climate and soil (Mirsky et al. 2017).

Cover crops can be successfully established throughout the fall. Species selection varies by planting schedule and targeted weeds (Figure 12.3). Winter-kill cover crops like spring oats can produce prolific biomass to control winter annual weeds if the cover crops are planted early in the fall after small grain harvest. Winter-hardy cover crops, such as

cereal rye or triticale, better target spring-emerging winter annuals and produce enough residual mulch to help suppress summer annual weeds. If herbicides are an option, the field should be sprayed with a preplant (“burndown”) herbicide before planting late summer or early fall cover crops to better manage

winter annual weeds and volunteers from the previous cash crop.

Grazing cover crops or harvesting them for forage has several weed suppression benefits. Annual, biennial, and perennial forages or hay crops can serve as both a cover crop and forage. These plants suppress summer annual weeds, particularly broadleaf species – frequent grazing, mowing, and harvesting prevents weed seed production and exhausts the root reserves of problematic perennial weeds.

Combining intensive cover cropping with tillage also can greatly impact weeds. In Pennsylvania, Mirsky et al. (2010) demonstrated that combining tillage with cover

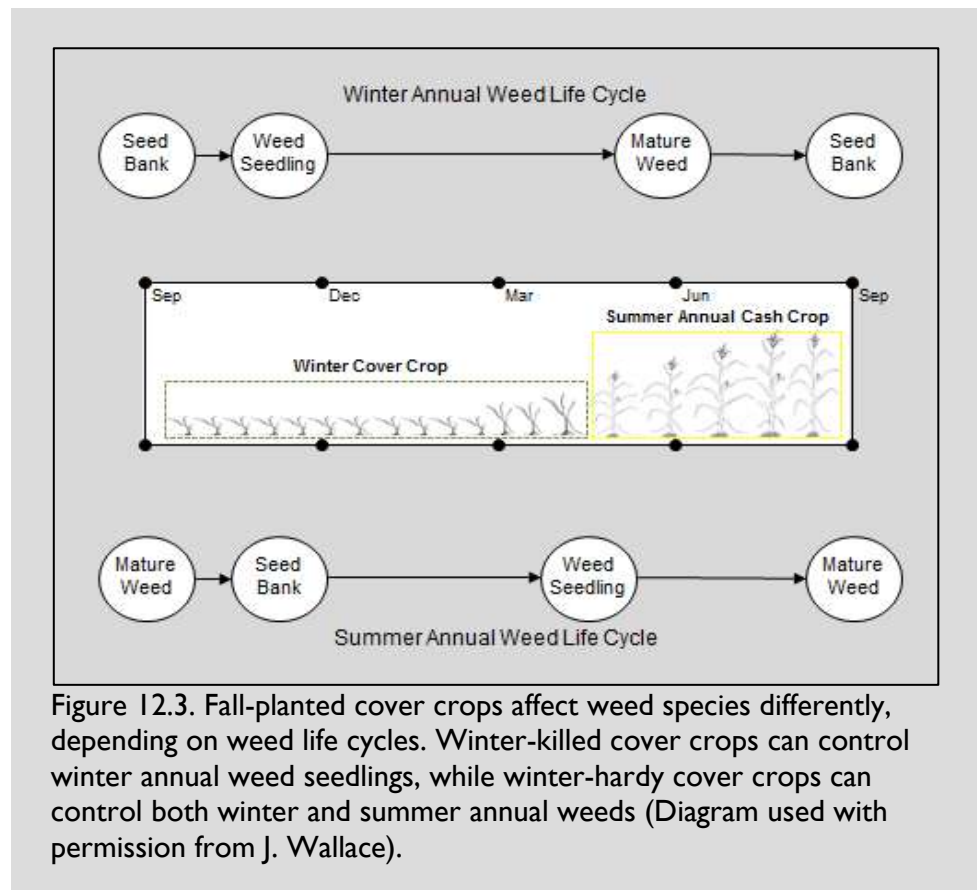

Figure 12.3. Fall-planted cover crops affect weed species differently, depending on weed life cycles. Winter-killed cover crops can control winter annual weed seedlings, while winter-hardy cover crops can control both winter and summer annual weeds (Diagram used with permission from J. Wallace).

cropping during a summer fallow can result in 98%, 85%, and 80% reductions of germinable seedbank for foxtail (giant and yellow), common lambsquarters, and velvetleaf, respectively. Cover cropping strategies that stimulate weed seed germination as well as suppress weed growth and limit seed production results in the greatest weed seedbank declines.

Although they are less common in the Northeast, summer annual cover crops like sorghum-sudangrass and millet can be used as part of an intensive weed management strategy. Research in Illinois reported that Canada thistle shoot density and biomass were greatly reduced over the course of two growing seasons by using either sorghum-sudangrass or a mixture of sorghum-sudangrass and cowpea (Bicksler and Masiunas 2009).

Cover Crop Mixtures for Weed Control

The goal for selecting and managing a cover crop mixture for weed control is to optimize the mixture for high biomass, ground cover, and duration of living cover crop in the field. Plant the mixtures at recommended times with a seeding method that ensures good seed-to-soil contact and stand establishment, such as drilling. High fertility sites with a history of manure use, excess nitrogen from preceding cash crop, and high soil organic matter will support grass or broadleaf cover crop growth to the possible detriment of legumes, which are less competitive in a high nitrogen environment. On sites with low nitrogen levels, legumes compete more readily with other species in the mixture. Regardless, weed suppression increases with greater cover crop biomass levels.

Cover crop biomass quality (i.e. carbon to nitrogen ratio) impacts both weed suppression and the performance of the subsequent cash crop. Using cover crop mixtures provides multiple benefits. For example, cereal cover crops high in carbon can scavenge residual soil nitrogen and further immobilize nitrogen when terminated. A mulch that limits nitrogen availability is good for weed suppression in legumes like soybean but is problematic in crops like corn that need a lot of nitrogen. Legume cover crops are a good source of nitrogen for the following cash crop but provide limited weed suppression. In fact, legume cover crops may even stimulate weed emergence and performance (Figure 12.4). Combining grass and legume cover crops can result in higher biomass levels and weed suppression while continuing to provide nitrogen for the subsequent corn crop. Work completed in Maryland demonstrated that even mixing low levels of cereal rye (~20%) with hairy vetch can maximize weed suppression (Finney et al. 2016). Cereal rye provides a trellis for hairy vetch to climb, which keeps vetch off of the soil surface. This relationship delays the start of hairy vetch decomposition, increases the overall carbon to nitrogen ratio, and keeps the soil surface drier than a pure hairy vetch cover crop. Because water and nitrogen stimulate weed emergence, manipulating these factors with cover crops can delay and reduce weed

emergence. Cover crop mixtures provide farmers the opportunity to maximize the nitrogen content in a cover crop mixture while not impacting its ability to suppress weeds as a mulch (Figure 12.4). If a farmer has multiple cover crop goals, selecting a mixture of two or more species may be the best choice.

Cover Crop Termination for Weed Control

Cover crop termination represents another disturbance throughout a crop rotation. Which cover crop termination methods are used depends on the goals and constraints of the cropping system. There are “natural” methods (e.g. winter weather kills a non-hardy cover crop such as forage radish and oats), chemical methods (e.g. herbicide application), and mechanical methods (e.g. tillage, mowing, or roller crimping).

Not all cover crop termination methods will kill weeds present in the field at the time of termination. Tillage and herbicide applications are the most effective means of cover crop termination and have the most impact on emerged weeds. Mowing and roller crimping for cover crop termination are less effective at controlling emerged weeds than herbicides and tillage. Their effectiveness depends both on cover crop species and termination timing (Mirsky et al. 2009; Mirsky et al. 2011; Mirsky et al. 2017, Mischler et al. 2010).

Prevent Cover Crops from Becoming Weeds

Cover crops add diversity to cropping systems and can be used in combination with other cultural practices to control and slow the development of herbicide-resistant weeds. However, some cover crops like buckwheat, annual ryegrass, and hairy vetch are notorious for becoming weeds themselves if they are not effectively terminated before seeds are formed (Curran et al. 1994; Hoffman et al. 1993). Such cover crops should be terminated at the appropriate time (according to local recommendations) to prevent seed production.

However, herbicide-resistant cover crops complicate termination and become an ongoing weed problem if allowed to go to seed. Jasieniuk et al. (2008) reported

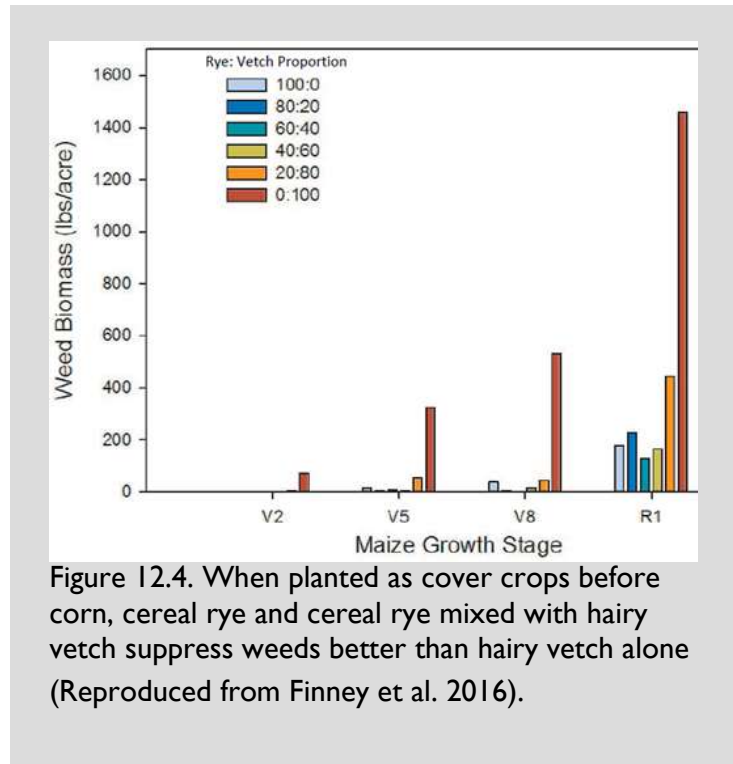

Figure 12.4. When planted as cover crops before corn, cereal rye and cereal rye mixed with hairy vetch suppress weeds better than hairy vetch alone (Reproduced from Finney et al. 2016).

herbicide resistance in annual ryegrass. To prevent cover crops from developing into weed problems, use high quality certified cover crop seed and known crop varieties. Seeds listed as variety not stated (or VNS), variety mixtures, bin-run seed, and lower quality seed can potentially introduce a weed problem. Be sure your seed source is free of weeds seeds.

Take care to ensure complete control and prevent cover crop seed production of potentially problematic species. Tillage can completely terminate a cover crop when herbicides are not sufficient. Crop rotations that allow for multiple possible control methods also can help with long-term management of hard-seeded cover crops. For example, planting a small grain like winter wheat, in which broadleaf herbicides can be used, provides additional opportunity to control hairy vetch.

Cover Crop Mulch for Weed Control

Increasing levels of cover crop mulch generally results in better weed suppression. Cereal rye cover crop should produce a minimum biomass of 5,000 to 7,500 pounds per acre to decrease summer annual weed emergence by 75% in the Northeast (Mirsky et al. 2011; Ryan et al. 2011b). Unfortunately, cover crops in the northern portion of the Mid-Atlantic do not consistently produce these high biomass levels; 4,000 to 6,000 pounds per acre are more typical rates. Providing livestock manure or fertilizer can enhance cover crop growth, especially when the plants follow a productive cash crop that requires heavy nitrogen application, such as corn. For example, applying nitrogen (20 to 40 pounds nitrogen per acre) to a cereal rye cover crop in the early spring to increase biomass production can improve weed suppression.

Delaying cover crop termination is another strategy to increase cover crop biomass. As cover crops reach their late-vegetative stages, they are rapidly accumulating biomass. Delaying by 2 to 3 weeks until early reproductive stages of the cover crop often allows maximum biomass production (Mischler et al., 2010b; Teasdale et al., 2004). Delaying cover crop termination not only allows more biomass production, but the tissue is more resistant to breakdown/decay. Cereal crops provide much more tissue that contains lignin that persist on the soil surface.

A Multifaceted Approach

Combining cover crops with cultural or mechanical weed control tactics is an important step toward implementing integrated weed management (Mirsky et al. 2013; Teasdale et al. 1991). A cover crop mulch in combination with high in-row crop population densities (e.g. soybean at 200,000 seeds per acre) and/or narrow-row cash crop planting (e.g. soybean row spacing decreased from 30 to 15 or 7.5 inches), herbicides, or tillage can effectively suppress weeds. Ryan et al. (2011a) found that increased soybean seeding rates compensated for low cereal rye biomass, ensuring acceptable suppression of summer annual weeds (Figure 12.5). The cereal rye mulch

hindered early-season weed growth, giving the high-density soybean planting enough time to close its canopy, hindering weed growth in the middle and late season. In a greenhouse study, the combination of metolachlor (Dual®) and hairy vetch residue enhanced the control of smooth pigweed (Teasdale et al. 2005). Nord et al. (2011) found that a postemergence herbicide application more effectively decreased weed biomass than cultivation in soybean planted into a cereal rye mulch.

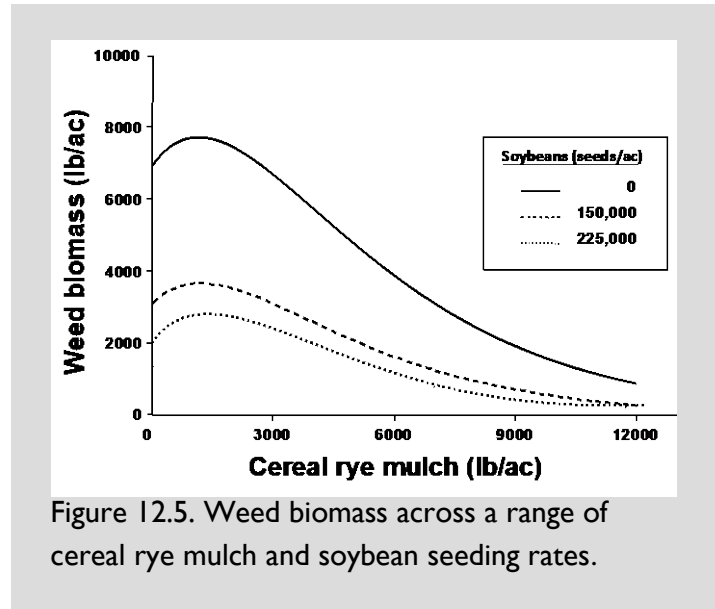

Figure 12.5. Weed biomass across a range of cereal rye mulch and soybean seeding rates.

Mechanical control tactics also can be used in combination with cover crops (Teasdale et al. 1991). In reduced tillage systems, technological limitations make cultivation difficult. However, cultivation is now possible in these systems by using high-residue cultivators that neither invert the soil nor drag residue through the field. High-residue cultivators, when used in combination with cover crop mulches, can control weeds in fields with large weed seedbanks.

Cover crops are plants that are typically grown when the ground would otherwise be bare. Cover crops compete with weeds for nutrient, space, and light when alive. After termination, cover crop mulch reduces weed seed germination and smothers weed seedlings. Cover crop mixtures can be particularly effective for weed control. Methods for cover crop termination include “natural” (i.e. cold weather), mechanical (i.e. mowing or tilling), and chemical (i.e. herbicides). Cover crops must be terminated completely in order to prevent them from becoming weeds themselves. Ultimately cover crops are one tool among many for weed suppression.

Key Points

- Living cover crops outcompete weeds for space, light, water, and nutrients.
- The effect of cover crops on weeds varies by cover crop species, weed species, and time of establishment.
- Perennial weeds are less affected than annual weeds by cover crops.
- Maximize weed suppression by maximizing cover crop biomass.
 - Establish a dense cover crop stand
 - Delay cover crop termination to increase weed suppression.
- Implementing cover crop mixtures can achieve multiple farmer goals, such as nitrogen and weed management.
- Both the cover crop termination process and the remaining residue control weeds often are not a “stand-alone” tactics, rather they complement other weed management strategies.

References

- Bicksler AJ, Masiunas JB (2009) Canada thistle (*Cirsium arvense*) suppression with buckwheat or sudangrass cover crops and mowing. *Weed Technol* 23:556-563
- Curran WS, Hoffman LD, Werner EL (1994) The influence of a hairy vetch (*Vicia villosa*) cover crop on weed control in corn (*Zea mays*). *Weed Technol* 8:777-784
- Finney DM, Mirsky SB, Ackroyd VJ (2016) Cover crop mixture selection and management. Southern Cover Crops 2016 Conference Fact Sheet. Available at: <http://www.southernsare.org/Events/Southern-Cover-Crop-Conference/Southern-Cover-Crop-Conference-Fact-Sheets#selection>
- Gallagher RS, Cardina J, Loux M (2003) Integration of cover crops with postemergence herbicides in no-till corn and soybean. *Weed Sci* 51:995-1001
- Hartwig NL, Ammon HU (2002) Cover crops and living mulches. *Weed Sci* 50:688-699
- Hoffman ML, Regnier EE, Cardina J (1993) Weed and corn (*Zea Mays*) responses to hairy vetch (*Vicia villosa*) cover crop. *Weed Technol* 7:594-599
- Jasieniuk M, Ahmad R, Sherwood AM, Firestone JL, Perez-Jones A, Lanini WT, Mallory-Smith C, Stednick Z (2008) Glyphosate-resistant Italian ryegrass (*Lolium multiflorum*) in California: Distribution, response to glyphosate, and molecular evidence for an altered target enzyme. *Weed Sci* 56:496-502
- Mirsky SB, Ackroyd VJ, Cordeau S, Curran WS, Hashemi M, Reberg-Horton SC, Ryan MR, Spargo JT (2017) Hairy vetch biomass across the eastern United States: Effects of latitude, seeding rate and date, and termination timing. *Agron J* 109:1510-1519

- Mirsky SB, Ryan MR, Teasdale JR, Curran WS, Reberg-Horton CS, Spargo JT, Wells MS, Keene CL, Moyer JW (2013) Overcoming weed management challenges in cover crop-based organic rotational no-till soybean production in the eastern United States. *Weed Technol* 27:193-203
- Mirsky SB, Ryan MR, Curran WS, Teasdale JR, Maul J, Spargo JT, Moyer J, Grantham AM, Weber D, Way T (2012) Tillage issues: cover crop-based organic rotational no-till grain production in the Mid-Atlantic region. *Renewable Agric and Food Sys* 27:31-40
- Mirsky SB, Gallandt ER, Mortensen DA, Curran WS, Shumway DL (2010) Reducing the germinable weed seedbank with soil disturbance and cover crops. *Weed Res* 50:341-352
- Mirsky SB, Curran WS, Mortensen DA, Ryan MR, Shumway DL (2009) Control of cereal rye with a roller/crimper as influenced by cover crop phenology. *Agron J* 101:1589-1596
- Mirsky SB, Curran WS, Mortensen DM, Shumway DL, Ryan MR (2011) Timing of cover crop management effects on weed suppression in no-till planted soybean using a roller crimper. *Weed Sci* 59:380-389
- Mischler RA, Duiker SW, Curran WS, Wilson D (2010a) Hairy vetch management for no-till organic corn production. *Agron J* 102:355-362
- Mischler RA, Curran WS, Duiker SW, Hyde J (2010b) Rolling a rye cover crop for weed suppression in no-till soybean. *Weed Technol* 24:253-261
- Mohler CL, Teasdale JR (1993) Response of weed emergence to rate of *Vicia villosa* and *Secale cereal* residue. *Weed Res* 33:487-499
- Nord EA, Curran WS, Mortensen DA, Mirsky SB, Jones BP (2011) Integrating multiple tactics for managing weeds in high residue no-till soybean. *Agron J* 3:1542-1551
- Nord EA, Smith RG, Curran WS, and Ryan MR (2010) Suppressing weeds using cover crops in Pennsylvania. *Penn State Ext. Bul. UC210*
<https://extension.psu.edu/suppressing-weeds-using-cover-crops-in-pennsylvania>
 accessed May 3, 2019
- Ryan MR, Mirsky SB, Mortensen DA, Teasdale JR, Curran WS (2011a) Potential synergistic effects of cereal rye biomass and soybean planting density on weed suppression. *Weed Sci* 59:238-246
- Ryan MR, Curran WS, Grantham AM, Hunsberger LK, Mirsky SB, Mortensen DA, Nord EA, Wilson DO (2011b) Effects of seeding rate and poultry litter on weed suppression from a rolled cereal rye cover crop. *Weed Sci* 59:438-444

- Teasdale JR, Beste CE, Potts WE (1991) Response of weeds to tillage and cover crop residue. *Weed Sci* 39:195-199
- Teasdale JR, Devine TE, Mosjidis JA, Bellinder RR, Beste CE (2004) Growth and development of hairy vetch cultivars in the Northeastern United States as influenced by planting and harvesting date. *Agron J* 96:1266-1271
- Teasdale JR, Mohler CL (2000) The quantitative relationship between weed emergence and the physical properties of mulches. *Weed Sci* 48:385–392
- Teasdale JR, Pillai P, Collins RT (2005) Synergism between cover crop residue and herbicide activity on emergence and early growth of weeds. *Weed Sci* 53:521-527
- Wallace J, Williams A, Liebert J, Ackroyd VJ, Vann R, Curran WS, Keene C, VanGessel M, Ryan MR, Mirsky SB (2017) Cover crop-based, organic rotational no-till corn and soybean production systems in the mid-Atlantic United States. *Agriculture*. doi:10.3390/agriculture7040034
- Yenish JP, Worsham AC, York AC (1996) Cover crops for herbicide replacement in no-tillage corn (*Zea mays*). *Weed Technol* 10:815-821

Chapter 13: Mechanical Weed Control: Pre-Plant

Charlie Cahoon, William Curran, and David Sandy

Summary

Tillage, or mechanical weed control, is an important component of integrated weed management. While most primary tillage is used for seedbed preparation, tillage can kill weed seedlings and bury weed seeds. However, it also can stimulate weed seed germination or bring weed seeds closer to the soil surface where they may be more likely to emerge. No-tillage production uses herbicides to replace primary and secondary tillage for controlling emerged weeds prior to cash crop planting. The goal is to incorporate mechanical weed control tactics that diversify the cropping system and reduce the potential for herbicide resistance while keeping soil conservation and productivity at the forefront.

Introduction

Mechanical weed control generally uses some type of machine pulled by a tractor to physically slice, chop, or uproot small weeds. Hand hoeing or hand removal is also considered mechanical weed control, but this chapter will only focus on mechanized tactics before crop planting.

Mechanical weed control is an important component to an integrated weed management system. Before herbicides were commercialized, preplant tillage and inter-row cultivation were the primary methods of weed control. These methods are still used in many organic systems. However, it is difficult to use mechanical cultivation tools and maintain conservation compliance in continuous no-till systems.

Preplant tillage for weed control includes plowing, disking, and field cultivating. These primary and secondary types of tillage can kill emerged weed seedlings and bury weed seeds below the depth of successful germination and emergence and help reduce the rate and spread of some perennial weeds. Inversion tillage, which generally means using a moldboard plow, can bury weeds deeper into the soil profile, but also can bring weed seeds to the surface where they can germinate. Preplant tillage also can spread vegetative structures of some perennial weed species.

Preplant tillage can be divided into two categories: primary and secondary. Primary tillage occurs between harvest of one crop and planting of a second crop. Often this method is intense because it breaks open compacted soils, loosens the top soil layer

in preparation for secondary tillage, and chops and incorporates crop residue. Examples of primary tillage implements are moldboard plow and chisel plow.

Secondary tillage occurs after primary tillage. It is shallower and less aggressive than primary tillage. This method is used to crush soil clods left by primary tillage, incorporate fertilizer, create a homogenous seedbed, or firm the soil in preparation for planting. Field cultivators, finishing disks, harrows, and cultipackers are examples of secondary tillage implements. Secondary tillage implements can be used mechanically incorporate herbicides into the top 1 to 2 inches of soil. Incorporating herbicides need to be done with care to prevent moving the herbicides too deep in the soil where its effectiveness will be reduced. Field cultivators and finishing disks should be set for a 3 to 4 inch depth; generally herbicides will be incorporated half the depth that the cultivator is operated.

Tillage Implements

Preplant tillage implements vary in their roles in preparing fields for planting and in weed control methods. Many implements have been developed to control weeds, manage residue, and prepare a seedbed. Below are descriptions of a few tillage implements as defined by *Steel in the Field: A Farmer's Guide to Weed Management Tools* (SARE 2002):

- *Moldboard plow*. Considered the primary tool for inverting the soil, the moldboard plow (Figure 13.1) consists of a large contoured shank (plow bottom) that cuts the furrow bottom and wall, flips the furrow slice, and inverts the soil surface (Walters 2017). This plow was developed to bury plant residue and is great for either uprooting small and large weeds or completely burying seedlings and seed.

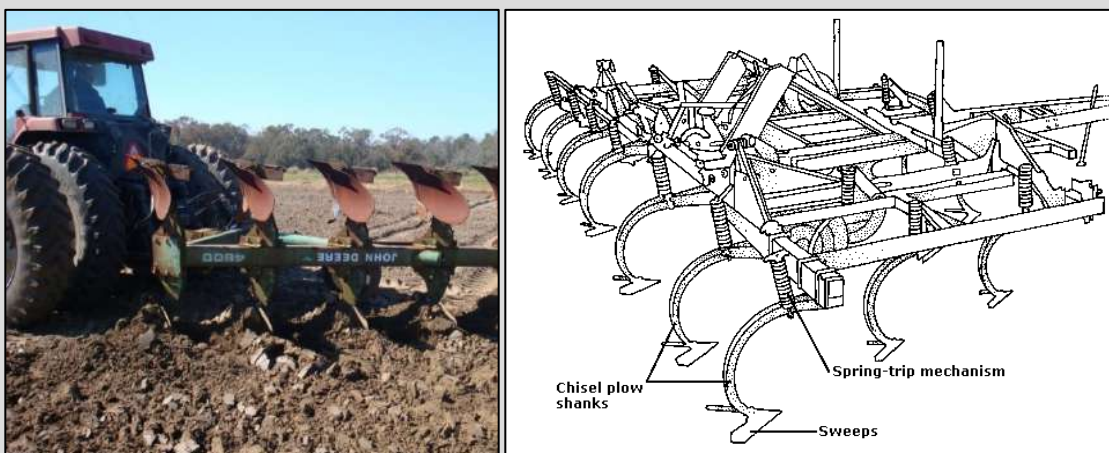

Figure 13.1. Primary tillage implements include moldboard plow (Photo credit: S. Culpepper, Univ. Georgia), left and chisel plow with sweeps (SARE 2002).

- *Chisel plow*. The chisel plow (Figure 13.1) consists of a series of C-shaped shanks spaced 12 inches apart with chisel points or sweeps. The addition of sweeps improves weed control. Chisel plows can shatter hardpan soils and improve water infiltration. The addition of 12- to 18-inch wide sweeps improves weed control, but the chisel plow is not as effective as other implements for controlling weeds.
- *Disk harrow*. Concave blades (known as a disk harrow gang) cut, mix, and incorporate crop residue. A disk harrow's cutting and mixing action varies with diameter, weight, concavity, blade angle, and speed at which the implement is pulled. Harrows can chop weeds or uproot small weed seedlings. Plant residues can prevent disk harrows from creating a smooth seedbed. They can be used to control small weeds on the soil surface prior to planting if there is little plant residue present (Figure 13.2).

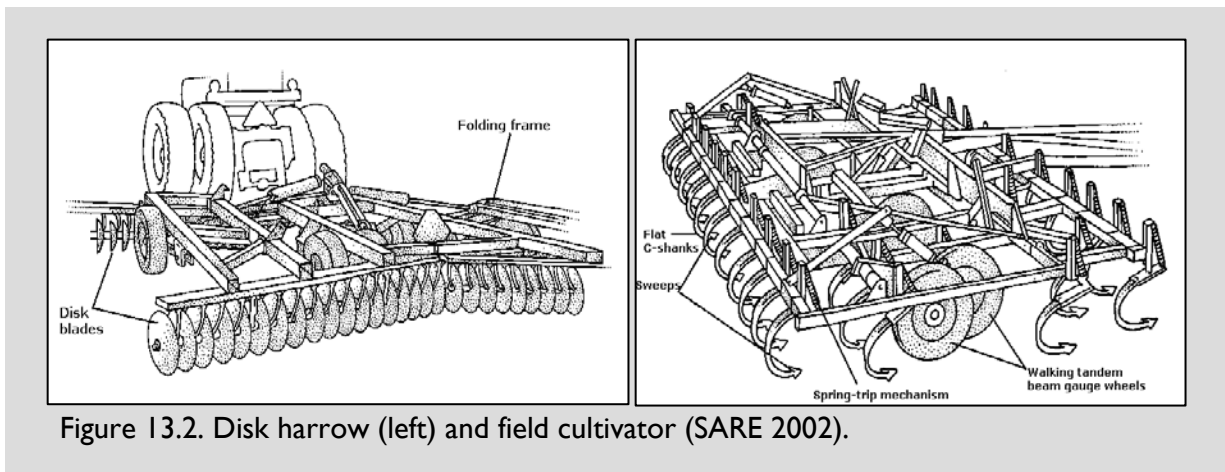

Figure 13.2. Disk harrow (left) and field cultivator (SARE 2002).

- *Field cultivator*. Like the chisel plow, a field cultivator (Figure 13.2) consists of C-shaped shanks, which are less rigid than those of a chisel plow. The shanks work along the full width of the implement, as well as two to five inches deep, to open up soil or incorporate plant residue. Weeds are uprooted and weed seedlings are killed. The addition of sweeps facilitates weed control and shovels are used more often for field prep.

Effect of Tillage on Weeds

Primary tillage buries weed seeds and vegetative parts and chops weeds into small pieces unable to regrow. Small annual weeds, small-seeded species, and simple perennials are more susceptible to tillage than perennials with stolons, rhizomes, or tubers (Klingman 1961). Dry soil conditions and higher air temperatures create the best conditions for weed control. Weeds sliced or uprooted by tillage during these

environmental conditions are less likely to recover from tillage operations than weeds tilled when soils are wet and temperatures are moderate.

Secondary tillage disturbs weed roots by loosening or cutting the root system, causing the plants to desiccate, or dry out, before roots can re-establish (Klingman 1961). Because this process involves desiccation, it is most effective when soils are dry and temperatures are high. Similar to primary tillage, small annual weeds and simple perennial weeds are more easily controlled than creeping perennials by secondary tillage. Disking or chopping rhizomes, stolons, and tubers without adding other weed control methods may worsen creeping perennial infestations.

Farmers should know the weed control limitations of each tillage operation and implement. See Table 13.1 for the relative effectiveness of various tillage implements for control of different types of weeds and weed seed burial. The key to effective weed control with tillage starts with selecting the right tool for the job.

Table 13.1. Tillage implement effectiveness for control of various weed types. Based on authors' experiences. (For weed type definitions, see Chapter 2: *Identification and Characteristics of Weeds*)

Tillage implement	Control of existing weeds				Burying annual weed seed
	Seedlings	Established annuals or biennials	Simple perennials	Creeping perennials	
Moldboard	Good	Good	Good	Fair	Good
Chisel	Good	Fair	Fair	Poor	Fair
Disk harrow	Good	Good	Good	Poor	Poor
Field cultivator	Good	Poor	Poor	Poor	Poor

Effect of Tillage on Weed Seeds

Tillage is the primary cause for weed seed movement throughout the soil profile, including vertical distribution (Buhler et al. 1997). This movement can affect germination and establishment. Some tillage implements can bury weed seed to a depth not conducive to germination (Table 13.1), while at the same time bringing buried seeds to the soil surface. There, the soil environment is more conducive to germination. A single pass of a moldboard plow buries surface weed seeds to the depth of the tillage implement (greater than 6 inches) and is very effective at reducing seedling density. However, tillage systems used over multiple seasons also can influence the distribution of weed seeds in the soil profile. As seen in Figure 13.3, Wisconsin researchers observed a more even vertical distribution of weed seed after multiple years of moldboard plowing than after multiple years of chisel plowing and no-tillage, with weed seeds more concentrated at the top of the soil profile in both systems (Yenish et al. 1992). It should be noted that burying weed seeds to a depth of six inches or more may prolonged the time for seed decay due to a less disturbed environment.

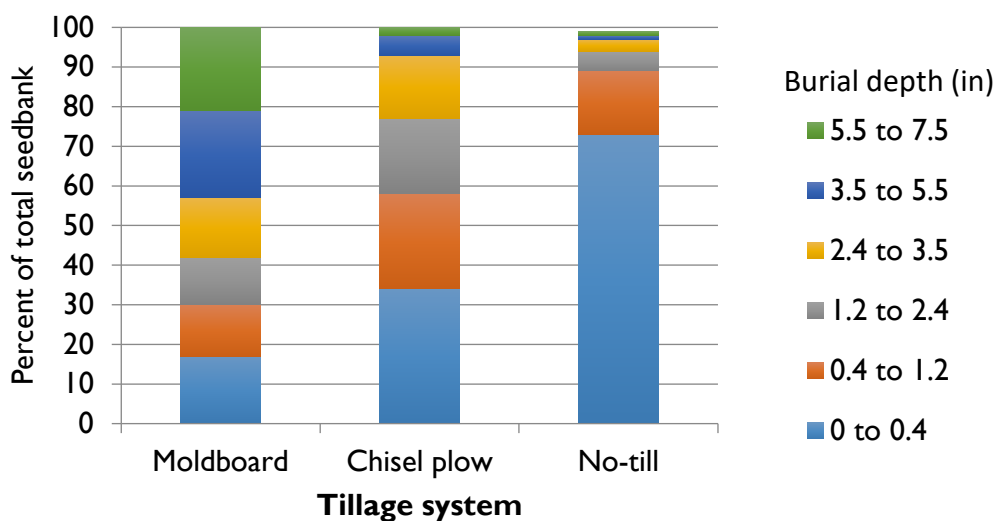

Figure 13.3. Vertical distribution of weed seed as affected by tillage system in a silt loam soil (Adapted from Yenish et al. 1992).

Seed size determines the depth from which seedlings can emerge. This depth varies by species. Smaller seeds do not have enough energy reserves to emerge from deep within the soil. For example, the greatest germination rates for the small seeds such as Palmer amaranth and slender amaranth, were at depths less than one inch (Keeley et al. 1987; Thomas et al. 2006). Sicklepod seed, much larger than slender amaranth, can germinate from deeper than one inch. In a sandy loam soil, Arkansas researchers observed 50% sicklepod germination at a depth of 1.8 inches, and 6% at a depth of 4 inches (Norsworthy and Oliveira 2006). Likewise, pitted morningglory, which also has large seeds, germinated from as deep as 4 inches (Oliveira and Norsworthy 2006) (See Table 13.2 for optimum emergence depth for several weed species). Generally large seeds, such as common cocklebur and pitted morningglory, had higher emergence if seeds were buried compared to on or near the soil surface (Bararpour and Oliver 1998; Lovelace and Oliver 2000).

Table 13.2. Emergence depth for several common weed species.

Weed species	Emergence depth (in)	Reference
Broadleaf signalgrass	0 to 0.4	Burke et al. 2003a
Common ragweed	0 to 1.6	Guillemin and Chauvel 2011
Horseweed (or marestail)	0 to 0.2	Nandula et al. 2006
Palmer amaranth	0 to 0.5	Keeley et al. 1987
Pitted morningglory	0 to 4.0	Oliveira and Norsworthy 2006
Slender amaranth	0.2 to 0.8	Thomas et al. 2006

Tillage affects soil temperature, soil moisture, oxygen levels, and light, environmental conditions that are cues for weed seed germination. Tillage reduce seed germination by placing the seed deeper in the soil profile. There, temperatures are cooler, less temperature fluctuation, less oxygen is available and no light penetration. However, tillage can stimulate weed seeds to germinate if the seeds are exposed to light, higher oxygen levels, and warmer soil temperatures (see Chapter 3: *Weed Emergence, Seedbank Dynamics, and Weed Communities*). Farmers should consider the effects of tillage germination cues for various weed species when considering tillage.

Effect of Tillage Systems on Problem Weed Species

Tillage systems often are classified by the amount of plant residue left on the soil surface and are defined as follows:

- *Conventional tillage.* A conventional-till system disturbs the soil surface across the entire width of the implements used and leaves less than 15% residue on the soil surface. Conventional tillage includes multiple operations (often primary tillage followed by secondary tillage). An example is a three-pass system using a moldboard plow for primary tillage and then a finishing disc harrow and field cultivator for secondary tillage.
- *Reduced till.* Similar to conventional till, reduced-till systems disturb the soil across the full width of the implement. However, 15 to 30% surface residue remains after tillage. Chisel plowing without sweeps, leaves much of the soil surface undisturbed and is considered reduced tillage.
- *Mulch-till.* As in conventional- and reduced-till systems, the entire soil surface is tilled, but mulch-till is less aggressive, leaving more than 30% residue on the soil surface.
- *Ridge-till.* In the ridge-till system, the cash crop is planted on established ridges that are formed by between-row cultivation. These ridges help drain and warm the soil for better crop emergence. Between-row cultivation also can control weeds.
- *Strip-till.* In strip-till systems, the majority of the soil surface is left undisturbed. Strip-till equipment often includes no-till coulters mounted in front of the planter unit to create a narrow tilled zone where the seed is to be planted. This tilled zone helps warm the soil and provides better seed placement. Strip-till often includes a shank in the tilled zone to alleviate soil compaction and place fertilizers deeper in the soil profile.
- *Vertical till.* This is generally shallow tillage used to chop residue from a previous crop into smaller pieces and distribute it more evenly over the soil surface. Chopping and mixing residue facilitates decomposition, allowing the subsequent cash crop to be planted into more easily. Vertical tillage also can alleviate surface

compaction and soil crusting. Vertical tillage implements do not generally control emerged weeds.

- *No-till*. Soil disturbance is minimized in no-till systems. Residue covers 70% of the soil surface. Row cleaners, coulters, and seed-furrow openers create slots for planting seeds in this heavy residue.

The tillage system often dictates what type of weeds can be problematic. In general, reduced and no-till systems may have more problems with perennial weeds and some small-seeded annuals while they have fewer problems with large-seeded annual weeds. Many perennial weeds thrive in no-till systems because their roots are left undisturbed (Glenn and Anderson 1993; Glenn and Heimer 1994). The spread of rhizomes, stolons, and tubers of creeping perennials in a no-tillage system often increases the infestation. In no-till or reduced-till systems, herbicides are usually needed to effectively control perennial weeds. In a Maryland study with no-till corn, herbicides were needed to adequately control Canada thistle (Glenn and Anderson 1993). Hemp dogbane and wild blackberry also were difficult to control in no-till corn and required herbicides for effective control (Glenn and Heimer 1994). In Pennsylvania, researchers reported quackgrass was more difficult to control in no-till than reduced-till corn (Curran et al. 1994). Using tillage in combination with herbicides or other weed control methods is often necessary to deplete the energy reserves of perennial species.

Of the many ways tillage influences the weed seedbank, seed depth in the soil may be most important (Buhler et al. 1997). Weed species that can germinate from the soil surface or shallow depths will flourish in no- or reduced-tillage systems. Farmers in Indiana reported horseweed (or marestail), a small-seeded annual, was present in 61% of no-till fields compared to 24% of reduced-till fields and 8% of conventionally tilled fields (Loux et al. 2006). In contrast, large-seeded species at or near the soil surface in no-tillage systems are less successful (Buhler et al. 1997). A Maryland study reported 72% smooth pigweed control in a moldboard plow system compared to 63 to 64% in reduced till and 44% in no-till (Ritter et al. 1985), demonstrating the short-term benefits of tillage for small-seeded species (Figure 13.4). For a large-seeded species like common cocklebur or burcucumber, no-till can reduce overall emergence compared to tillage. Norsworthy and Oliveira (2007) reported a decrease in common cocklebur density under no-tillage by 59 to 69% compared with tillage and Esbenshade et al. (2001) reported similar trends with burcucumber (2001).

Effect of the tillage system on weed emergence are trends and may not produce consistent results (Messersmith et al. 2000). At the end of a nine-year study, Swanton et al. (1999) found common lambsquarters and redroot pigweed were more prevalent in conventionally tilled plots than in no-till, while large crabgrass was more common in the no-tillage system. Farmers should identify the effects of their tillage systems on the

presence of certain weed species and the potential alternative weed management practices needed once species shift.

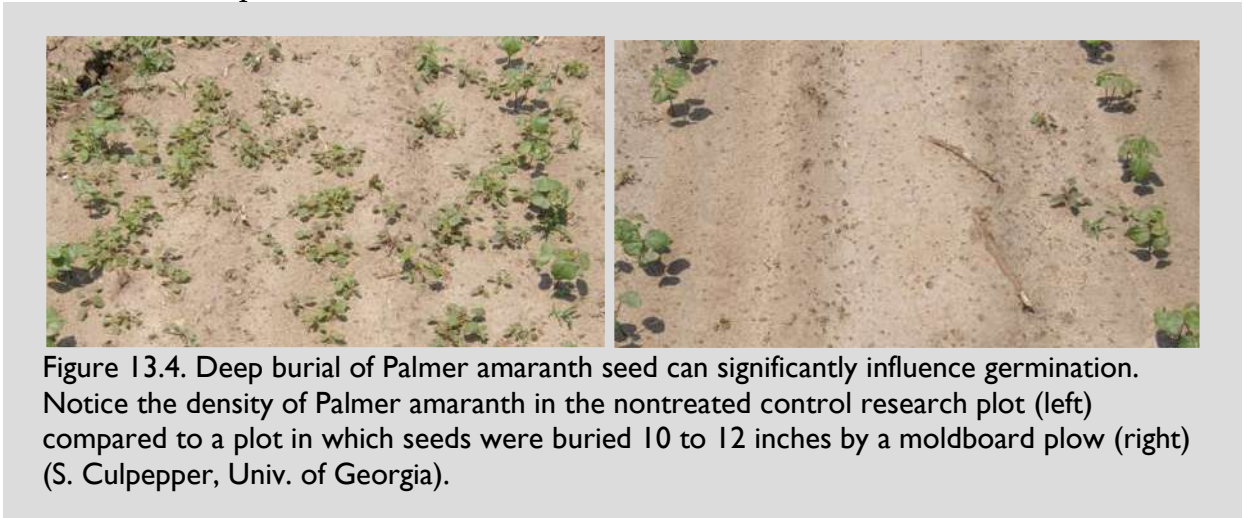

Tillage and the Weed Seedbank

Stale seedbed systems have long been used for weed control and involve early seedbed preparation using tillage approximately 30 days prior to planting. Tilling the seedbed early stimulates nondormant weeds in the germination zone to emerge, providing the opportunity to control these prior to crop planting (Boyd et al. 2006). These weeds can be controlled by light tillage, herbicides, or flaming.

In a stale seedbed system, light tillage has not been as effective as flaming or herbicides because it often stimulates additional weed germination. In a New York study, glyphosate and flaming in a stale seedbed system reduced weed biomass 46 to 91% compared to the untreated control (Caldwell and Mohler 2001). In the same study, the rotary tiller, tine weeder, and spring tooth harrow treatments either increased or had no effect on weed biomass when compared to the untreated control.

Stale seedbed systems are useful for reducing weed seedbanks. However, the success of this system depends on the control of newly emerged weeds. Tillage, herbicides, or other methods must be used to ensure the weed seedbank is not replenished by a few escaped weeds (see Chapter 6: *Prevention of Weeds*).

Tillage remains an effective tactic for controlling weeds and an important component of IWM. However, farmers should consider the effects of each tillage operation on individual weeds, weed seeds, and weed species dynamics. They also should factor in the environmental impacts of tillage and whether the advantages of tillage outweigh the disadvantages before using tillage equipment in their fields.

Key Points

- Tillage was the primary method of weed control prior to herbicides.
- Primary and secondary tillage can be used to control existing weeds.
 - Primary tillage buries weeds or chops weeds into small pieces
 - Secondary tillage disturbs weed roots and leads to plant desiccation
 - Annual weeds, simple perennial weeds, and small weeds are more susceptible to tillage than are creeping perennials and large weeds
- Weed seed germination and longevity also are affected by tillage.
 - Tillage influences soil temperature, soil moisture, oxygen, and light, all of which are germination cues for weed seeds.
 - Tillage affects weed seed distribution in the soil profile.
- Weed species and soil weed seedbanks can shift in response to tillage systems employed over multiple seasons.
 - Horseweed and many perennial weeds prefer long-term no-till systems.
 - Tillage can spread rhizomes, stolons, and tubers of creeping perennial weeds and worsen infestations.
- Soil weed seedbanks can be reduced via mechanical manipulation of a stale seedbed.

References

- Bararpour MT, Oliver LR (1998) Effect of tillage and interference on common cocklebur (*Xanthium strumarium*) and sicklepod (*Senna obtusifolia*) population, seed production, and seedbank. *Weed Sci* 46:424–431
- Boyd NS, Brennan EB, Fennimore SA (2006) Stale seedbed techniques for organic vegetable production. *Weed Technol* 20:1052-1057
- Buhler DD, Hartzler RG, Forcella F (1997) Implications of weed seedbank dynamics to weed management. *Weed Sci* 45:329-336
- Caldwell B, Mohler CL (2001) Stale seedbed practices for vegetable production. *HortSci* 36:703-705.
- Curran WS, Werner EL, Hartwig NL (1994) Effectiveness of herbicides and tillage on quackgrass (*Elytrigia repens*) control in corn (*Zea mays*). *Weed Technol* 8:324-330

- Esbenshade WR, Curran WS, Roth GW, Hartwig NL, Orzolek MD (2001) Effect of tillage, row spacing, and herbicide on the emergence and control of burcucumber (*Sicyos angulatus*) in soybean (*Glycine max*). *Weed Technol* 15:229-235
- Glenn S, Anderson NG (1993) Hemp dogbane (*Apocynum cannabinum*) and wild blackberry (*Rubus allegheniensis*) control in no-tillage corn (*Zea mays*). *Weed Technol* 7:47-51
- Glenn S, Heimer LK (1994) Canada thistle (*Cirsium arvense*) control in no-tillage corn (*Zea mays*). *Weed Technol* 8:134-138
- Guillemin JP, Chauvel, B (2011) Effects of the seed weight and burial depth on the seed behavior of common ragweed (*Ambrosia artemisiifolia*). *Weed Bio and Manag* 11:217-223
- Keeley PE, Carter CH, Thullen RJ (1987) Influence of planting date on growth of Palmer amaranth (*Amaranthus palmeri*). *Weed Sci* 35:199-204
- Klingman GC (1961) Introduction: Methods of weed control. P 13-25 in Klingman GC, Noordhoff LG ed *Weed Control: As a Science*. New York, NY: John Wiley & Sons
- Loux M, Stachler J, Johnson B, Nice G, Davis V, Nordby D (2006) Biology and management of horseweed. GWC-9 in *The Glyphosate, Weeds, and Crop Series*. Available online at <https://www.extension.purdue.edu/extmedia/gwc/gwc-9-w.pdf>
- Lovelace ML, Oliver RL (2000) Effects of interference and tillage on hemp sesbania and pitted morningglory emergence, growth, and seed production. *Proc South Weed Sci Soc* 53:202
- Messersmith DT, Curran WS, Hartwig NL, Orzolek MD, Roth GW (2000) Tillage and herbicides affect burcucumber (*Sicyos angulatus*) management in corn. *Agron J* 92:181-185
- Norsworthy JK, Oliveira MJ (2006) Sicklepod (*Senna obtusifolia*) germination and emergence as affected by environmental factors and seeding depth. *Weed Sci* 54:903-909
- Norsworthy JK, Oliveira MJ (2007) Tillage and soybean canopy effects on common cocklebur (*Xanthium strumarium*) emergence. *Weed Sci* 55:474-4809
- Oliveira MJ, Norsworthy JK (2006) Pitted morningglory (*Ipomoea lacunosa*) germination and emergence as affected by environmental factors and seeding depth. *Weed Sci* 54:910-916
- Ritter RL, Harris TC, Varano WJ (1985) Influence of herbicides and tillage on the control of triazine-resistant smooth pigweed (*Amaranthus hybridus*) in corn (*Zea mays*) and soybeans (*Glycine max*). *Weed Sci* 3:400-404

- SARE (2002) Steel in the field. Available at <https://www.sare.org/Learning-Center/Books/Steel-in-the-Field> Accessed May 3, 2019
- Swanton CJ, Shrestha A, Roy RC, Ball-Coelho BR, Knezevic SZ (1999) Effect of tillage systems, N, and cover crop on the composition of weed flora. *Weed Sci* 47:454-461
- Thomas WE, Burke IC, Spears JF, Wilcut JW (2006) Influence of environmental factors on slender amaranth (*Amaranthus viridis*) germination. *Weed Sci* 54:316-320
- Walters, R (2017) Dirt hog's companion: Technical note 20. The moldboard plow. Available at <http://open-furrow-agrosphere.net/Documents/DHC/The%20Moldboard%20Plow.pdf> Accessed May 3, 2019.
- Yenish JP, Doll JD, Buhler DD (1992) Effects of tillage on vertical distribution and viability of weed seed in soil. *Weed Sci* 40: 429-433

Chapter 14: Mechanical Weed Control: Post-Plant

William Curran, Charlie Cahoon, and David Sandy

Summary

Mechanical weed control used after the cash crop is a common practice to control germinated weed seeds or weeds that have already emerged. The types of tools employed generally kill weed seedlings or small weeds before they are well established and competitive with the crop. Like most other forms of weed control, effectiveness of mechanical weed control is higher when performed at the optimum timing. Blind weed control tactics need to be performed after the seed have germinated but before the roots have become established. Likewise, between-row cultivation is most effect on weeds up to three inches. Dry soil conditions and higher air temperatures that enhances weed desiccation create the best conditions for post-plant mechanical weed control.

Introduction

Cultivation practices used to control weeds after a crop has been planted is known as post-plant tillage. There are two types of post-plant tillage intended for weed control: blind cultivation and between-row (also known as inter-row) cultivation. Both tactics are more suited for tilled seedbeds, although some post-plant tillage equipment is available for no-till or high-residue cover crop systems. Other reasons for using blind cultivation are to break up soil crust for aeration and to promote faster drying, and incorporating wheat and other small crop seeds that have been broadcast on the soil surface.

Successful post-plant tillage requires diligent monitoring of field conditions and the weather, which are both important for effective mechanical cultivation. In addition to suitable soil and weather conditions, weed size or growth stage is critical for successful control of the weeds. The need to monitor the weather and soil conditions is critical because there may only be a small window that is ideal or appropriate to cultivate. For grain crops such as corn and soybean in the Mid-Atlantic region, the months of May and June are when most post-plant tillage takes place prior to crop canopy development. Like pre-plant mechanical weed control, Dry soil conditions and higher air temperatures that enhances weed desiccation create the best conditions for post-plant mechanical weed control.

The success of post-plant tillage requires the use of proper equipment. Many different tools have been developed to control weeds after crop planting. Choosing the right equipment and having it properly adjusted will help farmers take advantage of those ideal times to get into the field and achieve good weed control. Relying on mechanical weed control requires thoughtful consideration about time, labor, tractor horsepower needs, and implement size. The size of the tractor and implement must match to optimize implement performance as well as energy use. Larger sized implements can save time, but also require a larger tractor with more horsepower. Having multiple tractors available can allow for the use of more than one rotary hoe, tine weeder, and cultivator to cover all of the ground in a timely fashion. The right piece of equipment will pay for itself by improved weed control when only a narrow window is available to perform the operation. In addition, having skilled tractor operators who knows when crop, weed, and environmental conditions are optimum to achieve effective mechanical weed control is critical.

Considerations for Blind Cultivation

Blind cultivation controls weed seedlings germinating near the soil surface. Their roots are above those of the crop. An implement is “blindly” (not worried about driving on the crop rows) pulled through the soil, dislodging small weed seedlings both in the crop row and the area between the crop rows. The initial blind cultivation takes place at the same time as cash crop germination and root development but before crop emergence. Subsequent blind cultivation events may continue after the crop has emerged every five to seven days (or as weather allows) for a period of two to four weeks. Use of blind tillage to control early weed flushes can be successful if done at the proper time and with precision. In an organic soybean system, North Carolina researchers reported that two passes of a rotary hoe reduced the density of redroot pigweed by 56% and broadleaf signalgrass by 65% (Place et al. 2009). Inaccurate operation can result in damage or removal of young cash crop plants, reducing populations and, potentially, yield (Martens and Martens 2005). Some research has reported up to a 14% reduction in corn population from the use of a rotary hoe in tilled systems (Mulder and Doll 1993; VanGessel et al. 1995; Cox et al. 1999; Mohler et al. 1997). Bates et al. (2012) observed an 8% reduction in corn population from a combination of rotary hoe plus high residue cultivation. The conditions of the soil as well as crop growth stage dictate whether crop injury will be a concern. Increasing the cash crop seeding rate may help overcome some stand loss. This is especially true for crops such as corn, where adequate plant population is critical to maintain yield.

Once the crop reaches a certain size, blind cultivation can cause crop damage. Emerged weeds also become established and too big to control. In general, blind cultivation can be used from planting time to 8-inch tall corn and 4-inch tall soybean as long as weeds are in the cotyledon stage or earlier. Farmers should make sure that they

do not cultivate any bean crop from cracking through the crook stage (Figure 14.1). At this stage, cultivation can snap the stem of the bean and kill the plant.

Some crops are better candidates than others for blind cultivation. In general, crops that quickly develop large taproots after germination, including corn and soybean, and crop seeds that are planted at a depth of one inch or more will tolerate blind cultivation. It is not used with small-seeded crops that are planted at shallow depths such as alfalfa, clover, and canola because it can reduce the crop population. Blind cultivation is especially effective in controlling small-seeded annuals such as pigweed species and common lambsquarters. It is less effective on large-seeded annuals such as velvetleaf, common and giant ragweed, and annual morningglories because these seedlings often root more than an inch deep in the soil. Blind cultivation is not effective on perennial weeds with well-established roots.

The growth stage of the weed and crop are important factors in determining timing of blind cultivation. The *white thread* stage when a small uprooted seedling resembles a white thread is the ideal time for weed control (Figure 14.2). In this stage, the weed seed has germinated but has not yet emerged from the soil or developed its first true leaves. Weeds that have emerged are not as easily killed by blind cultivation. The typical window for blind cultivation is 5 to 14 days after the previous tillage operation. Careful field scouting will determine optimal timing. Scout for the weeds' growth stage by gently digging through the soil with a knife and checking for weed seed germination and white thread stage seedlings (a general rule of thumb is that if the weeds are visible from the seat of the tractor, a rotary hoe will not be effective).



Figure 14.1. Soybean in the emergence through crook stages are susceptible to injury from blind cultivation (Photo credit: W. Curran, Penn State).

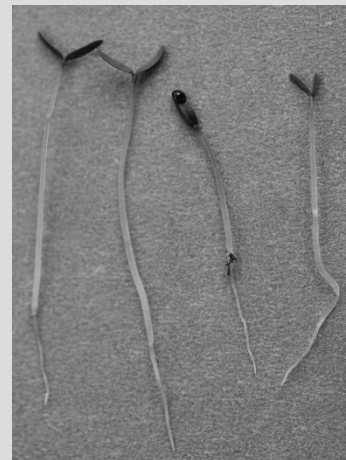

Figure 14.2. White thread stage of a pigweed (Photo credit: W. Curran, Penn State).

Weather and soil conditions play an important role in the success of blind cultivation. Ideal conditions for cultivation are when the soil is friable (dry to slightly

moist but not wet), the weather is sunny and breezy, and no rain is forecast for the next two days. In dry soil, the cultivator will uproot weeds without creating clods (also known as root balls). If the soil is too wet, the weed may be uprooted with a root ball, which will allow the weed to survive. Sunny and breezy weather helps desiccate and kill the weed seedling. Rain soon after cultivation may allow weeds to resprout and survive, but even if conditions are less than ideal, cultivate if possible -- some weed removal is better than no weed control at all.

Cultivation frequency may also be determined by soil and weather conditions. Rainfall can prevent timely cultivation. The ideal schedule is to cultivate once a week as soon as the crop germinates. Typical pattern of cultivation when relying extensively on mechanical weed control is are two to three blind cultivations followed by two to three between-row cultivations.

Tools for Blind Cultivation

The two primary tools used for blind cultivation in field crops are the flex-tine weeder and the rotary hoe. Both are available in a range of sizes from 10 to 40 feet and are typically operated at a speed of 5 to 15 mph.

Flex-tine weeder

The flex-tine weeder (also called tine weeder) is designed to remove weeds in and outside the crop row (Figure 14.3). It has a series of flexible metal tines that are pulled through the soil to uproot newly germinated weeds in the white thread stage. Dry soil conditions are best. Tines can be added or removed and the pressure of each tine increased or decreased based on the settings needed for each implement, crop, and targeted weeds (Figure 14.3). The adjustments allow for aggressive cultivation behind the tire pass and light cultivation through the crop row. Effective weed control is

determined by the downward pressure on the tines, soil moisture, and tractor speed. Faster tractor speeds increase the vibration of the tines as they are pulled through the soil. The vibrating tines uproot small

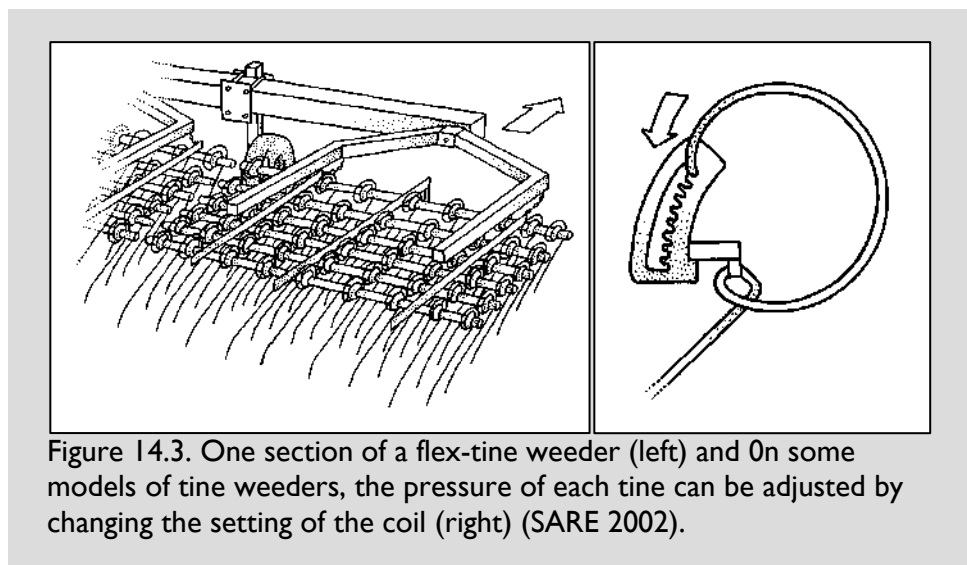

Figure 14.3. One section of a flex-tine weeder (left) and on some models of tine weeders, the pressure of each tine can be adjusted by changing the setting of the coil (right) (SARE 2002).

plants and shake soil loose from newly germinated weeds, bringing them to the soil surface to desiccate and die. Tine weeders perform best in clean-tilled seedbeds (i.e. seedbeds free of plant residue). Plant residue can get caught in the tines and result in damage to the young crops and ineffective weed control. The tine weeder can be used on a number of crops including barley, wheat, oats, corn, soybean, sorghum, and sugar beets. In general, tine weeders are less aggressive than rotary hoes.

Rotary hoe

The rotary hoe (Figure 14.4) is a ground-driven implement that uses a series of wheels with metal spoons radiating out (Figure 14.4). The spoons are oriented on the wheel so that they enter straight into the soil and then emerge at a slight angle. As ground speed increases, the tips of the spoons penetrate the soil and kick out newly germinated weed seedlings. Like the flex-tine weeder, the rotary hoe also is most effective during the white thread stage of weed development. Avoid using a rotary hoe in soybean during the plant's crook stage. Blind cultivation can be resumed in soybean once cotyledons are completely unfolded and is best during the afternoon as the plants tend to be slightly flexible and limber during the hotter part of the day. This will lower the risk of stems snapping. Cultivate a small

section of the field initially to monitor the crop and ensure that it is not being damaged. Like flex-tine weeders, rotary hoes generally perform best under dry soil conditions and with little residue. However, there are various types of rotary hoes that can work in high-residue environments. With the high-residue rotary hoe, the distance between the gangs of hoe wheels is greater to avoid the wheels becoming plugged by crop residue. Place et al. (2009) reported four passes of a rotary hoe on a stale seedbed reduced weed cover by 57%.

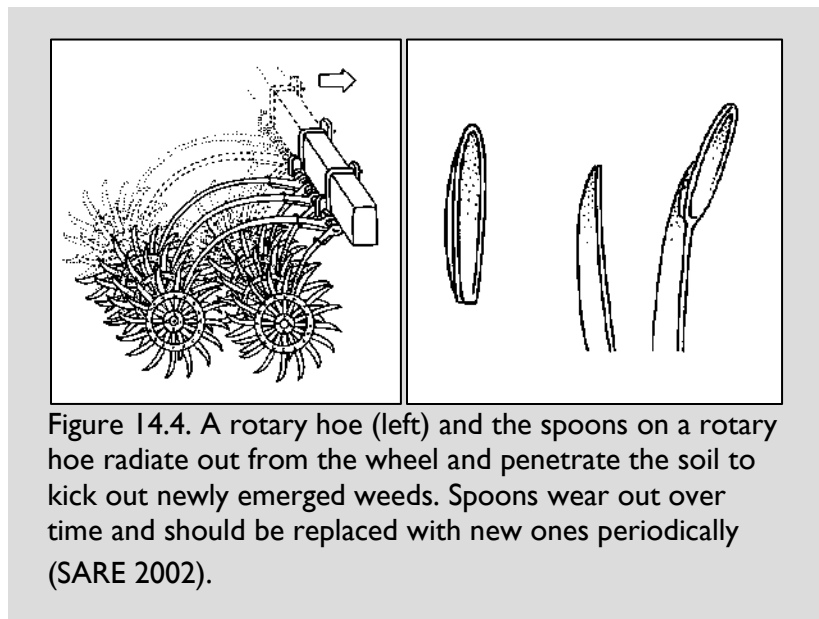

Figure 14.4. A rotary hoe (left) and the spoons on a rotary hoe radiate out from the wheel and penetrate the soil to kick out newly emerged weeds. Spoons wear out over time and should be replaced with new ones periodically (SARE 2002).

Cultivate a small section of the field initially to monitor the crop and ensure that it is not being damaged. Like flex-tine weeders, rotary hoes generally perform best under dry soil conditions and with little residue. However, there are various types of rotary hoes that can work in high-residue environments. With the high-residue rotary hoe, the distance between the gangs of hoe wheels is greater to avoid the wheels becoming plugged by crop residue. Place et al. (2009) reported four passes of a rotary hoe on a stale seedbed reduced weed cover by 57%.

Considerations for Inter-Row Cultivation

Tilling the soil between crop rows to control emerged weeds is known as inter-row cultivation. Only the area between the crop rows is disturbed. Spacing between the crop rows determines the feasibility of using these tools. Adding guidance systems

provides greater precision, increased operation speed, and reduced potential for crop damage. Inter-row cultivation is less effective in controlling larger, well established weeds. In addition, larger weeds can become entangled in the equipment and result in crop damage and reduced weed control.

A conventional cultivator is designed for low-residue environments. The shanks are spaced less than six inches apart. These cultivators are designed for conventionally tilled fields with loose soil and little to no plant residue. The typical operating depth for these units is one to two inches, which allows for adequate control of weeds up to three inches tall and that are rooted shallowly. This method avoids bringing up weed seeds from deeper in the soil profile that could subsequently germinate and become established. Typical tractor speed for this type of cultivator is 2-8 mph. Slower operating speeds may be necessary for smaller crops. Faster operating speeds may be acceptable for larger crops that can tolerate contact with the cultivator sweep.

Cultivators are equipped with sweeps (or shovels) attached to the end of the shank on the cultivator unit. The aggressiveness of the between-row weed control is determined by the orientation of the shanks on the toolbar and the type of sweep selected. In addition to the sweeps, some cultivators are equipped with weeding disks to control weeds close to the crop rows. Other disks are sometimes added to the cultivator to form furrows for irrigation, ridges, or beds (disk-hillers).

Increasing tractor speed increases aggressiveness of the cultivators as a result of more vibrations and more soil disturbance. Attachments can be added to most cultivators to prevent or limit the amount of soil moved into the crop row when the crop stems cannot withstand the soil movement. Moving soil into the row to bury small weed seedlings is a common practice once the crop is well established. Moving soil and burying weed seedlings is best with dry, friable soil.

Cultivation can disrupt the layer of herbicide treated soil and allow for additional weed emergence (see Chapter Chapter 3: *Weed Emergence, Seedbank Dynamics, and Weed Communities*). Adjusting cultivators so they do not dilute herbicides or bring untreated soil to the surface will help to maintain herbicide's residual control.

Weeds with fibrous root systems are more tolerant to cultivation than weeds with taproot. It is more challenging to dislodge fibrous root systems from the soil than taproots. Furthermore, taproots are easier to separate from aboveground tissue than fibrous roots.

There is generally more time and flexibility for inter-row cultivation than for blind cultivation because these tools can control larger weeds than flex-tine harrows and rotary hoes. There are a number of different shanks and sweeps that are available for between-row cultivation. Shanks connect the sweeps to the body of the cultivator and are designed in various styles. The shanks can be rigid or flexible, allowing the sweep to remain stable or to vibrate through the soil. The type of weed control needed determines what type of shank should be used.

Common shanks and sweeps include the following:

- The Danish S-tine shank cultivates loose and residue-free soil (Figure 14.5). The shank, in combination with a moderate profile crown (middle area of the sweep), will vibrate and mix the soil, uprooting weeds and shaking soil loose from their root systems. This shank controls small seedlings and weeds with shallow root systems.
- The C-shank is more rigid and vibrates less than the S-tine shank, but it can still flex around rocks and other obstructions (Figure 14.5). It is designed for harder soil or fields with greater amounts of plant residue. The C-shank resists flexing and holds the sweep flat to slice through the soil, cutting the weeds.

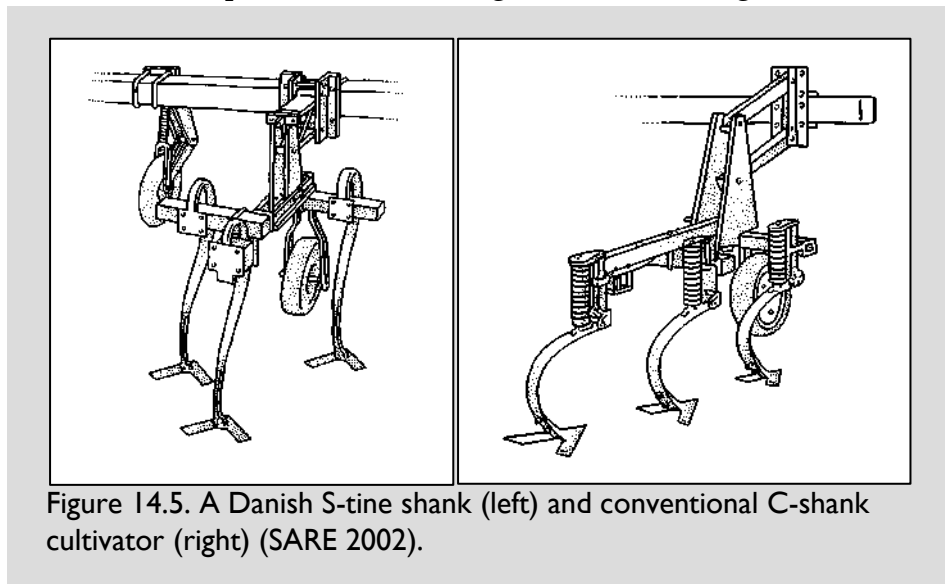

Figure 14.5. A Danish S-tine shank (left) and conventional C-shank cultivator (right) (SARE 2002).

- The V-shaped row crop sweep (Figure 14.6) can be used on C, S-tine, and straight shanks. Widths available range from 6 to 28 inches. The row crop sweeps slice through the soil, uprooting smaller weeds and cutting root systems of larger weeds. The sweep is designed with a flattened crown, and the angle of the V-shaped wings in relation to the crown is low. As a result, the sweep cuts more than it mixes the soil, which causes less soil disturbance.
- The Danish tine sweep is used in cultivation (Figure 14.6). It was developed for use with the Danish S-tine shank and is available in widths from one to nine inches wide. The sweeps are designed with either a low or moderate profile crown. With the lower crowned sweep, soil mixing and weed control is similar to that of the V-shaped row crop sweep. The moderate crowned sweep offers greater soil mixing and better soil penetration than the wider flatter sweeps.
- A variation of the Danish sweep is the duckfoot, or goosefoot, sweep (Figure 14.6). This type of sweep also was designed for the Danish S-tine and comes in widths from two to seven inches wide. Because of its moderately sloped crown,

the duckfoot sweep offers better soil penetration, especially in hard soil. It also is better at uprooting rather than slicing or cutting weeds. The sweep mixes the soil. The shape of the S-tine allows it to vigorously

vibrate, knocking soil from the weed roots and leaving them exposed to desiccate on the surface of the soil.

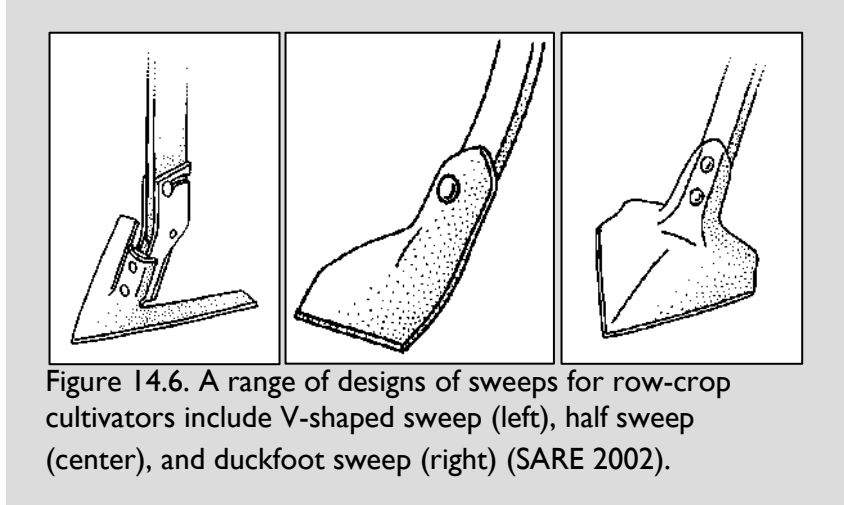

Figure 14.6. A range of designs of sweeps for row-crop cultivators include V-shaped sweep (left), half sweep (center), and duckfoot sweep (right) (SARE 2002).

High Residue Cultivation

Cultivators designed for use in high plant residue environments have been on the market for more than 30 years. These cultivators work in no-till, ridge-till, or tilled fields with a large amount of plant residue. Initially, they were more commonly used in ridge-till systems and designed with a moderate crown and V-shaped wings to throw soil, forming a “ridge”. The no-till sweeps on the cultivator were more recently redesigned with a flat crown for less soil disturbance. These types of cultivators typically have one large sweep between two crop rows compared to three or more shanks between crop rows with conventional cultivators. The action of the high residue cultivators is based on slicing through the weeds and separating the root system from the above ground tissue. As a result, high residue cultivators use typically used on slightly larger weeds than standard row-crop cultivators.

The three-piece sweep, or high residue sweep, is designed with low disturbance straight shanks (Figure 14.7). As the name implies, the sweep is made up of three components: a replaceable point and two double-edged reversible shares. The point penetrates the soil, while the shares lie flat just below the soil surface and slice weeds, leaving the surface residue somewhat in place. The shares come in widths ranging from 14 to 28 inches, which determine how close shares travel next to the crop row. These types of sweeps are mounted on either a curved or straight rigid shank.

In no-till cultivation, dual gauge wheels in front of the cultivator unit keep the plant residue in place, while a coulter cuts through the residue allowing the sweep to penetrate the soil (Figure 14.7).

Each additional pass with the cultivator will reduce the amount or redistribute any surface plant residue. For ridge-till farmers, an extended wing can be attached to the sweep to create an elevated ridge in the crop row. Ridging wings are usually used

during the last pass with the cultivator when the crops are well established and can withstand soil being thrown into the crop row to form the ridges.

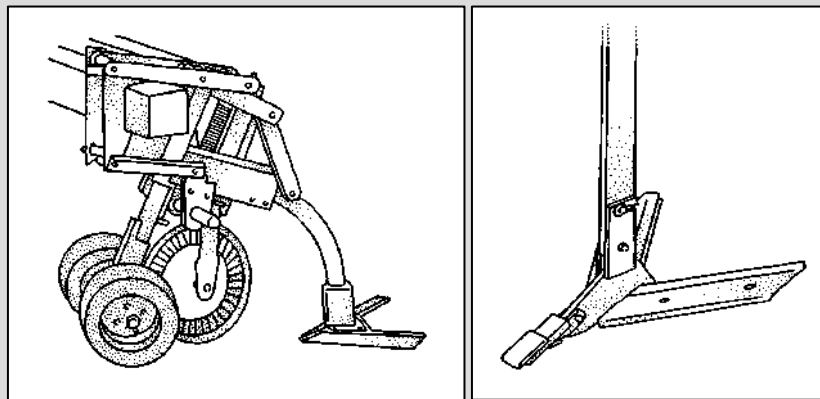

Figure 14.7. A high residue cultivator (left) with gauge wheels, couler, and sweep; and a three-piece sweep (right) typically used for high residue cultivators (SARE 2002).

Specialized Cultivator Technology

Several mechanical weed control tools have been developed for higher valued horticultural products. These tools are designed to control small in-row weeds or weeds right next to the crop row in tilled seedbeds. Spyder, torsion, finger, and spring hoe weeders are examples of tools often used in high value crops where effective herbicides are not registered for use or in organic production. These tools require precision, which may mean using smaller equipment or slower operational speeds. These specialized tools are much less common in agronomic crops.

Various guidance systems also are available to ensure accuracy in the operation and allow faster operating speeds. Technology that can allow precision guidance with numerous field operations (including cultivation) is developing quickly. Faster operating speeds reduce operation costs (Paarlberg et al. 1998; Hanna et al. 2000). According to Bates et al. (2012), a six-row high residue cultivator equipped with a hydraulic guidance system operated at 7 mph greatly reduced the amount of necessary time and labor when compared with operating the same equipment at 3 to 4 mph. More effective weed control and less crop injury from cultivation or other operations can also be reduced with sensory guidance systems (Liebman et al. 2001).

Integrated Systems

Combining inter-row cultivation with herbicides and cultural weed control tactics diversifies a weed management program and prevents herbicide-resistant weed evolution. Nord et al. (2011) compared high residue cultivation in an organically managed soybean crop with 30-inch rows to soybean planted in narrow rows (7.5

inches) with no cultivation. In the study, soybean were no-till planted into a rolled rye cover crop. Weed biomass generally declined when cereal rye biomass increased. Added cultivation was necessary when weed density was high, reducing weed biomass by 38 to 62%.

Banding herbicides is one method of applying less total active ingredient per acre (see Chapter 7: *Chemical Control*) and it has been used mainly with conventionally tilled systems. But studies have found favorable results with no tillage and use of high residue cultivators (Snyder et al. 2016). Keene et al. (2016) compared high residue cultivation in both no-till corn and soybean planted into cover crop residue. Two passes with a high residue cultivator in combination with banded herbicide achieved similar cash crop yield as a postemergence herbicide application.

Mowing as a Method to Suppress Weeds

Mowing is a mechanical tactic that can play a critical role in managing weeds in forage crops or noncrop areas. Repeated mowing reduces the weed's competitive ability, depletes carbohydrate reserves in the roots, and can prevent seed production. The success of mowing for weed control depends on the target weed species, timing, and frequency. Mowing is more effective on annuals and biennials that are beginning to flower than on plants in the vegetative stages. When weeds are mowed in the vegetative stages, they are more likely to recover and regrow.

Mowing also tends to be more effective on dicots (broadleaves) than on monocots (grasses and sedges), which tend to be more adapted to cutting. A number of creeping perennials and dicots also can be suppressed with mowing. Successful control of these weeds depends on mowing frequency to prevent regrowth and flowering and seed production. One goal when mowing perennials is to deplete carbohydrate reserves in the vegetative portions of the plant by frequent mowing (every 30 days). Another goal is to prevent seed production. Simple perennials such as dandelion and the plantains are less susceptible to control by mowing, as they tend to be adapted to low and more frequent cutting.

Several different types of tools are available for mowing:

- *Rotary mowers* are the most common and range in size from a common push or self-propelled lawn mower to large disk mowers that are used to mow hay. These mowers all have rapidly rotating blade(s) that cut plant material a few inches or more off the ground. The sharper the blades, the better the cut. These mowers typically cut plant material into medium sized pieces and propel them back to the ground, to the side, or out the back of the machine.
- *Flail mowers* have small blades on the end of chains attached to a horizontal axis. They are available in various sizes, ranging from a few feet wide to 20 feet. These types of mowers are excellent at cutting large material and pulverizing it into small pieces. These mowers typically propel the cut material toward the ground

to the rear of the mower. Some of the larger models are called “stalk choppers” and are used to mow crop residue after harvest.

Key Points

- Post-plant cultivation involves blind tillage shortly after cash crop planting and inter-row cultivation after the weeds and crop have emerged.
- Blind cultivation is used shortly after the cash crop is planted to control germinated weed seeds and small weed seedlings. Blind cultivation should be repeated every five days or more or until the weeds have mostly emerged.
- Inter-row cultivation is used after the cash crop and seedling weeds have emerged and is repeated once a week until the critical period for weed control in the cash crop has passed.
- High residue cultivators can control weeds with shallow soil disturbance in reduced till environments.
- Integrated approaches combine mechanical weed control tactics with cultural and chemical approaches to diversify the weed management program.
- Mowing is most effective on annuals and biennials that are beginning to flower.
- Mowing is more effective on annual broadleaf weeds than on grassy weeds.
- Mow perennials to deplete carbohydrate reserves in the vegetative portions of the plant by frequent mowing and to prevent seed production

References

- Bates RT, Gallagher RS, Curran WS, Harper JK (2012) Integrating mechanical and reduced chemical weed control in conservation tillage corn. *Agron J* 104:507-517
- Cox WJ, Singer JS, Shields EJ, Waldron JK, Bergstrom GC (1999) Agronomics and economics of different weed management systems in corn and soybean. *Agron J* 91:585-591
- Hanna HM, Hartzler RG, Erbach DC (2000) High-speed cultivation and banding for weed management in no-till corn. *Appl Eng In Ag* 16:359-365.
- Keene CL, Curran WS (2016) Optimizing high-residue cultivation timing and frequency in reduced-tillage soybean and corn. *Agron J* 108:1987-1906

- Liebman M, Mohler CL, Staver CP (2001) Ecological Management of Agricultural Weeds. 1st ed. Cambridge, UK: Cambridge University Press. 532 p
- Martens K, Martens MH (2005) In-row cultivation. Rodale Institute. Available online at <http://www.newfarm.org/features/2005/0305/earlyweeds/index3.shtml> Accessed May 3, 2019.
- Mohler CL, Frisch JC, Pleasant JM (1997) Evaluation of mechanical weed management programs for corn (*Zea mays*). Weed Technol 11:123–131
- Mulder TA, Doll JD (1993) Integrating reduced herbicide use with mechanical weeding in corn (*Zea mays*). Weed Technol 7:382–389
- Nandula VK, Eubank TW, Poston DH, Koger CH, Reddy KN (2006) Factors affecting germination of horseweed (*Conyza canadensis*). Weed Sci 54:898-902
- Nord EA, Curran WS, Mortensen DA, Mirsky SB, Jones BP (2011) Integrating multiple tactics for managing weeds in high residue no-till soybean. Agron J 103:1542-1551
- Paarlberg PL, Hanna HM, Erback DC, Hartzler RG (1998) Cultivator design for inter-row weed control in no-till corn. Appl Eng In Ag 14:353–361
- Place GT, Reberg-Horton SC, Burton MG (2009) Effects of preplant and postplant rotary hoe use on weed control, soybean pod position, and soybean yield. Weed Sci 57:290-295
- Snyder EM, Curran WS, Karsten HD, Malcolm GM, Duiker SW, Hyde JA (2016) Assessment of an integrated weed management system in no-till soybean and corn. Weed Sci 64:712-726
- SARE (2002) Steel in the field. Available at <https://www.sare.org/Learning-Center/Books/Steel-in-the-Field> Accessed May 3, 2019
- VanGessel MJ, Schweizer EE, Lybecker DW, Westra, P (1995) Compatibility and efficiency of in-row cultivation for weed management in corn (*Zea mays*). Weed Technol 9:754–760

Chapter 15: Harvest Weed Seed Control

Annie Klodd

Summary

Weeds that escape in-season control will mature and return seeds to the soil in the fall, unless they are managed prior to seed shed. Harvest weed seed control (HWSC) recently emerged from Australia as a way to address weed seeds retained on standing weeds at the time of harvest by either killing or removing escaped weed seeds during crop harvest. There are several HWSC methods, including the use of narrow windrow burning, chaff carts, and seed destruction. Ongoing research will reveal the level of effectiveness of these techniques on problem weeds in the U.S.

Introduction

Weeds that escape in-season control will mature and return seeds to the soil in the fall, unless they are managed prior to flowering. Harvest weed seed control (HWSC) recently emerged from Australia as a way to address weed seeds retained on standing weeds at the time of harvest by either killing or removing escaped weed seeds during crop harvest. There are several HWSC methods, three of which are currently being tested in the United States. Ongoing research will reveal how effective these tactics are on problem weeds in the U.S.

How Escaped Weeds Occur

Whether in conventional or organic crops, weeds often survive in-season control and continue to mature through the end of the season. These weed escapes can occur for several reasons. For instance, if herbicides with low efficacy for the weed species present are applied, or if the herbicides are applied when the weeds are too large, weeds will likely survive and produce seed. Escapes also occur if tillage and cultivation efforts do not control weeds. The rapid rise in herbicide-resistant weeds also increases the likelihood of weeds that may escape in-season control methods.

When weeds escape, there is a high likelihood they will mature and produce seed, adding to the soil weed seedbank. These seeds can last many years and impact crop production for years to come (Walsh and Powles 2014), with major weed management challenges and reduced yield for several years (or, in the case of some

species, decades). Some prolific weed species, such as Palmer amaranth, produce large numbers of seeds and can develop significant seedbanks from just a few plants.

Herbicide resistance and escaped weeds.

The spread of herbicide-resistant weeds has raised concern over escapes in many agronomic regions, including the Mid-Atlantic (see Chapter 8: *Weed Resistance to Herbicides*). Resistance to herbicide sites of action limits effective control options, raising the probability of weeds surviving commonly used herbicides. Throughout the U.S., farmers concerned about seed production have resorted to hand removal of escaped weeds. In Australia, the widespread challenge of herbicide resistance in several problem weeds has resulted in the development of innovative mechanical methods to control them and their seeds during harvest.

Harvest Weed Seed Control

Australian farmers and weed scientists facing overwhelming herbicide-resistance developed innovative methods of harvest weed seed control (HWSC). HWSC includes several mechanical and thermal methods that kill or remove weed seeds from plants still standing during harvest operations.

If weeds survive pre-season or in-season control and are mature at harvest-time, farmers may employ HWSC methods to prevent these weeds from dropping seed. If farmers can stop new weed seeds from entering the field's soil seedbank each year, the weed seedbank can be reduced, and improving weed control over time (Newman 2014). HWSC helps prevent the spread of weeds within a field and to other fields.

HWSC is not intended to replace other weed management practices such as herbicides, tillage, or cultural tactics. Rather, it is meant as a late-season tactic to manage weeds that survived in-season tactics, preventing them from contributing to future weed problems. Research and development is ongoing to evaluate HWSC's potential effectiveness in the Mid-Atlantic and other U.S. regions. All HWSC tactics are dependent on seed remaining on the plant at harvest time. For success, harvest needs to occur as soon as the crop is ready but before weeds shed seed. Almost all of the information we currently have about HWSC is based on experiences of Australian farmers and weed scientists.

Harvest weed seed control techniques

Narrow windrow burning. Narrow windrow burning (NWB) places combine residues into a narrow windrow, which is burned to kill any weed seeds. The windrows are formed by directing the chaff through chutes built onto the back of the combine (Walsh and Newman 2007) (Photo 15.1). This method provides more effective weed control than burning the whole field because the narrow windrows create high temperatures that destroy weed seeds (Schwartz et al. 2016b) (Photo 15.2).

While this tactic has shown success in Australia and in Arkansas, it is not yet known whether it will be a viable HWSC strategy in the Mid-Atlantic due to state-level burn regulations and timing of rainfall. Several years of testing at the University of Arkansas show promising results, and 30% of farmers in Australia use it as an

effective method to control multiple-herbicide-resistant rigid ryegrass. In Arkansas, NWB testing has shown 100% kill of Palmer amaranth, morningglory, johnsongrass,



Photo 15.1. Chaff being formed into windrows during harvest in preparation for narrow windrow burning in a western Australia wheat field (Photo credit: R. Messina and A. Messina, ABC News Australia).



Photo 15.2. A narrow windrow burning in a Virginia Tech research project (Photo credit: A. Klodd).

and barnyardgrass seeds. Over three years, this resulted in a 73% reduction in escaped Palmer amaranth plants and a 62% reduction in the Palmer amaranth seedbank (Norsworthy et al. 2016).

Farmers can optimize their techniques for successful NWB in several ways. Harvesting as close to the ground as possible will leave more crop residue in the narrow windrow, increasing the fuel for burning. High temperatures are key, but the temperature and length of exposure needed to kill seed can differ among weed species. For instance, 10 seconds at 400°F is sufficient to kill rigid ryegrass, while 30 seconds was needed to kill radish seeds. Australian NWB experts recommend burn temperatures reach at least 750°F for 30 seconds at any given spot in the windrow in order to completely kill seed. The speed of the burn is important: a slow burn increases flame temperatures. Denser windrows also increase temperatures. The burn must reach the soil surface below the windrow to contact ground-level seeds. Because different crops burn at different rates, burn protocols in the Mid-Atlantic need to be designed to meet the needs of the crops in the region.

Challenges to narrow windrow burning include complying with burn regulations, modifying the back of the combine to eject chaff in narrow windrows, isolating the burn area, and harvesting at the right speed for forming dense windrows. Poor weather conditions such as low temperatures, high humidity, high winds, and rainfall at the time of burning affect the success of a burn (Newman 2014). In the Mid-Atlantic, autumn rainfall may create excess moisture, challenging the ability to effectively burn windrows.

Chaff carts. A chaff cart is a large bin that follows the combine during harvest, collecting the weed seed-containing chaff ejected from the combine (Photo 15.3). The cart collects only the chaff. Typically, the straw fraction (dried crop vegetation) is still spread across the field. For success, the combine must be adjusted (and in some cases modified with baffles) so that weed seeds exit the combine in the chaff fraction and not in the straw fraction.



Photo 15.3. A chaff cart pulled behind a combine in Australia (Photo credit: M. Walsh, Australian Herbicide Resistance Initiative).

The collected chaff is then emptied into a pile either on or off the field. The pile can be burned or composted. Burning in a large pile creates temperatures high enough

to kill the weed seed and prevent the spread of seeds to other areas. As in narrow windrow burning, feasibility of the burning method in the Mid-Atlantic partly depends on state and local burning regulations. Proper composting methods are needed to create internal temperatures hot enough and long enough to kill most weed seeds.

The Australian Herbicide Resistance Initiative tested chaff carts on several commercial harvesters and found the carts collected 75 to 85% of rigid ryegrass seeds that entered the combine during harvest (Walsh and Powles 2007).

Chaff carts provide a relatively simple method of HWSC compared to narrow windrow burning or the seed destruction machines because highly specialized equipment is not required. However, one challenge of chaff carts is that their size and weight add to already large harvest equipment. Turning in small fields may be difficult, and the potential for soil compaction is great. Additionally, the need to dump the contents of the chaff cart contents periodically slows harvest. At this time, there are very few companies in the U. S. that make chaff carts.

Seed Destruction. The Harrington Seed Destructor (HSD) and Seed Terminator are mechanical systems that grinds the weed seed-containing chaff, which kills weed seeds, and then discharges residue onto the field (Photo 15.4). These machines are used

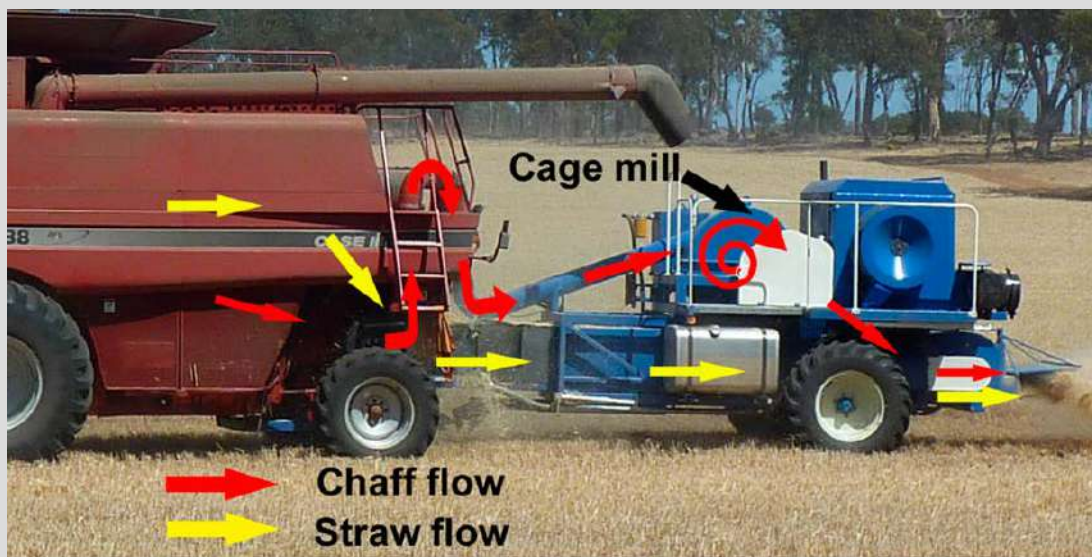

Photo 15.4. Flow of chaff and straw through the combine and the Harrington Seed Destructor.

during the combining operation. The HSD is designed and manufactured in Australia by deBruin Manufacturing. In the U.S., preliminary data from Illinois found the HSD killed nearly 100% of seeds that enter the cage mill (Figure 15.1 and Photo 15.5). Weed species in this study included common waterhemp, common lambsquarters, giant foxtail, velvetleaf, morningglory species, giant ragweed, and common cocklebur. Larger

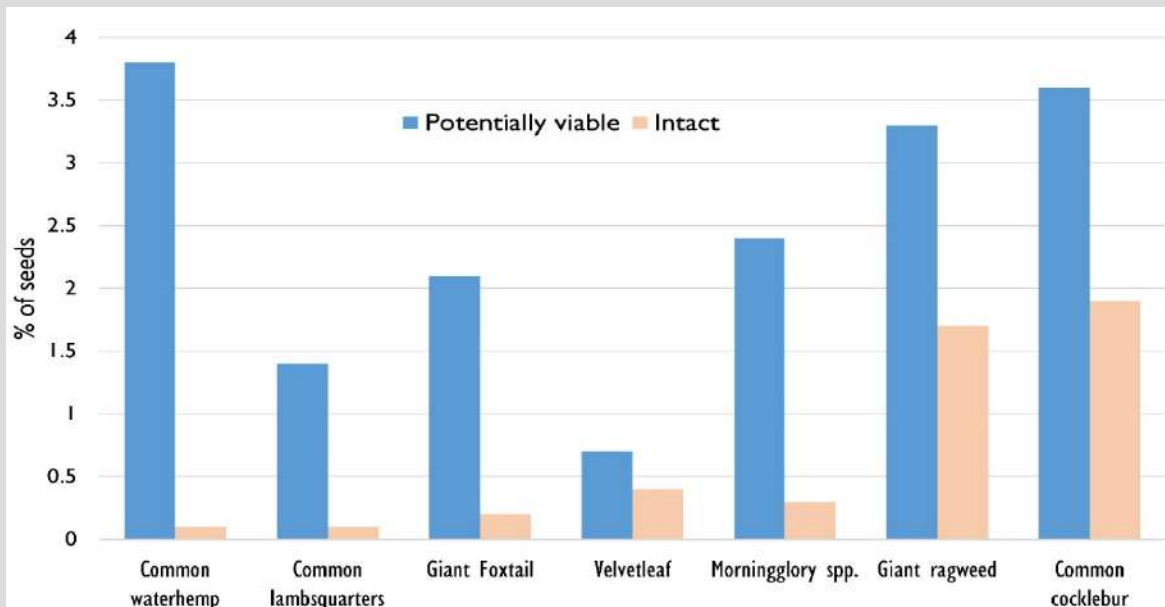

Figure 15.1. Percent potential viability of seeds of seven common weed species after going through a stationary Harrington Seed Destructor (HSD). Seeds were visually inspected and labeled fully intact or if the seed coat was mostly intact, potentially viable. For each species tested, the HSD rendered at least 96% of the weed seeds nonviable (Davis, 2016, personal communication).

seeds (giant ragweed, common cocklebur) remained intact at a higher percentage than smaller seeds. Furthermore, seeds sent through the HSD that remained intact were buried, but very few were viable the following spring. In Australia, extensive testing has found that the HSD kills 95% of wild radish, wild oat, brome, and annual ryegrass seeds (Walsh et al. 2013).

Effect of HWSC on weed species in the Mid-Atlantic region

Ongoing trials are evaluating the potential of HWSC for controlling weeds of concern in cropping systems of the Mid-Atlantic region. Because HWSC targets weed seeds at harvest time, this method is most effective at controlling species whose seeds stay on the plants during the crop harvest period and have shorter



Photo 15.5. Pigweed seeds exhibit significant damage after HSD processing in Urbana-Champaign, IL, rendering most seeds nonviable (Photo credit: A. Davis, USDA-Urbana).

seedbank lifespans. Species that shed seeds prior to harvest are not effected by HWSC strategies. In the Mid-Atlantic, the herbicide-resistant weeds of highest concern are Palmer amaranth, common waterhemp, horseweed, common ragweed, and common lambsquarters, which vary in seed-drop timing and seedbank lifespan (Figure 15.2).

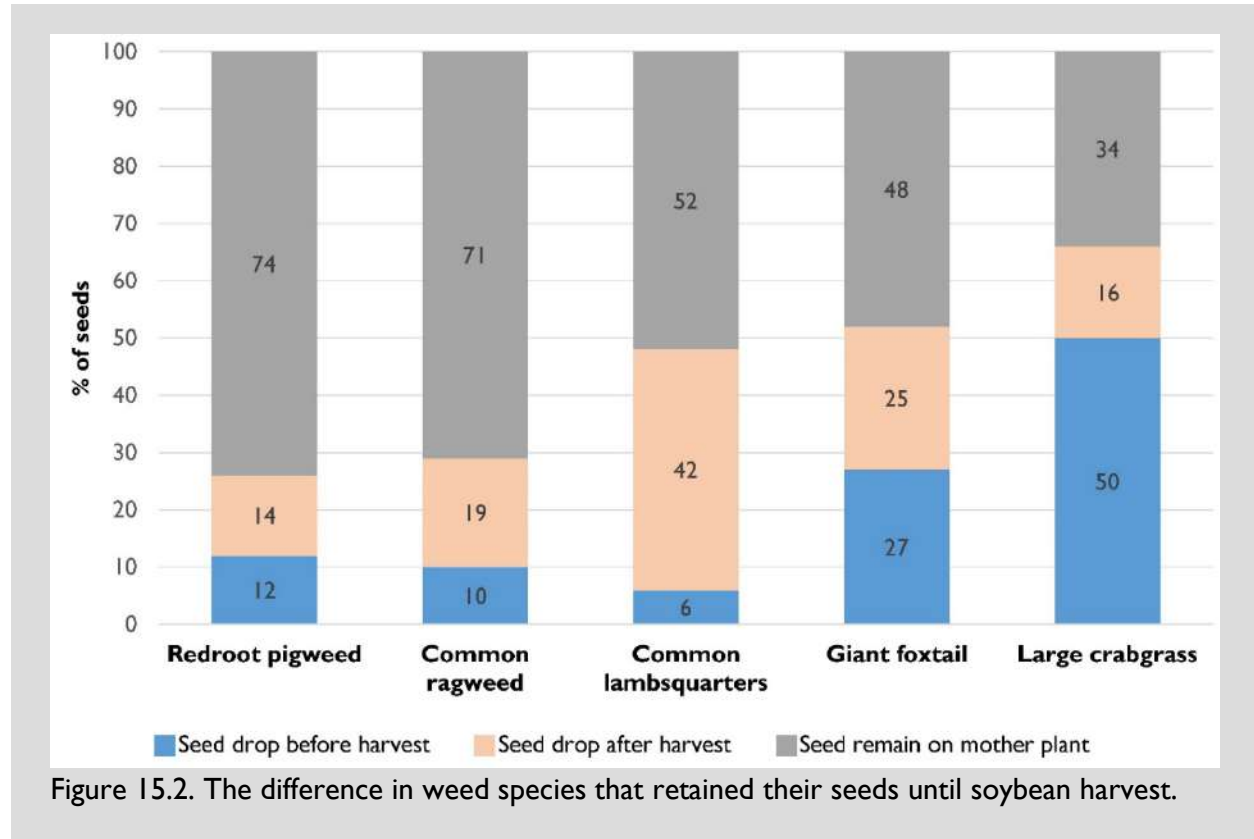

Figure 15.2. The difference in weed species that retained their seeds until soybean harvest.

Researchers note that HWSC will be most successful on weed species that wait to drop their seeds until after harvest. Research in Arkansas found that 95 to 100% of Palmer amaranth and common waterhemp seeds remained on the plants at soybean harvest (Schwartz et al. 2015, 2016a). These results may not be the same in the Mid-Atlantic, where harvest often begins later in the fall. Research is ongoing in the Mid-Atlantic and other regions to understand seed drop time in relation to crop harvest for annual weeds like common ragweed and common lambsquarters. Weed species that drop their seeds earlier, leading to a lower percentage on the plant at the time of harvest, enable more seeds to enter the soil before HWSC is implemented to kill them.

Plan Your Harvest Strategy

If weeds and their seeds are not removed prior to harvesting, then preventing their spread within the field or from field to field is important. Limiting seed spread in the field requires knowing what portions of the fields are infested. One method is to map the field before harvest. This can be done in advance of harvest, by marking

infested areas in the field on a map and then planning a strategy to avoid contamination of the weed-free areas.

Maps should be based on scouting or with drones outfitted with a video camera. If using drones, the suspected weedy patches should be ground-truthed. Your knowledge of individual fields is the most important tool you have to identifying weedy areas.

Harvest the weed free portion of the fields first, leaving the weedy portions for last to prevent further spread of weed seeds. After harvesting the infested patches be sure to thoroughly clean the combine to remove as many weed seeds as possible

Key Points

- Failure to control weeds early in the season leads to “escaped” weeds that drop seeds, often in the fall, and contribute to the soil seedbank.
- Reducing the soil weed seedbank is an important strategy to manage weed pressure in a field.
- Harvest weed seed control (HWSC) is a new method to kill or remove weed seeds during harvest-time and can be accomplished by using a variety of tactics.
- HWSC is most successful when harvest occurs as soon as possible and target weeds that are short-lived in the seedbank.
- In narrow windrow burning, rows of chaff are formed during harvest are then burned to kill weed seeds.
- A chaff cart travels behind a combine during harvest and collects weed seed-containing chaff.
- Seed destruction is a mechanized grinding mill that pulverizes weed seeds contained in the chaff.
- Harvest fields (or portion of fields) with mature seeds last to prevent field to field and in-field spread of weed seeds.

References

Davis AS (2008) Weed seed pools concurrent with corn and soybean harvest in Illinois. *Weed Sci* 56: 503-508

Norsworthy JK, Korres N.E., Walsh MJ, Powles SB (2016) Integrating herbicide programs with harvest weed seed control and other fall management practices for the control of glyphosate-resistant Palmer amaranth (*Amaranthus palmeri*). *Weed Sci* 64:540-550

- Schwartz LM, Gibson DJ, Gage KL, Matthews JL, Jordan DL, Owen MDK, Shaw DR, Weller SC, Wilson RG, Young BG (2015) Seedbank and field emergence of weeds in glyphosate-resistant cropping systems in the United States. *Weed Sci* 63:425-439
- Schwartz LM, Norsworthy J, Young BG, Bradley KW, Kruger GR, Davis VM, Steckel LE, Walsh MJ (2016a) Tall waterhemp (*Amaranthus tuberculatus*) and Palmer amaranth (*Amaranthus palmeri*) seed production and retention at soybean maturity. *Weed Technol* 30:284-290
- Schwartz LM, Norsworthy JK, Barber LT, Scott RC (2016b) Harvest Weed Seed Control – an Alternative Method for Measuring the Soil Seedbank. Fayetteville, AR. University of Arkansas Division of Agriculture Research and Extension, Agriculture and Natural Resources. FSA2180. 4p
- Walsh MJ (2013) Harvest Weed Seed Control. Australian Herbicide Resistance Initiative. 1-26 p. www.ahri.uwa.edu.au
- Walsh MJ, Newman P (2007) Burning narrow windrows for weed seed destruction. *Field Crop Res* 104: 24-30
- Walsh MJ, Powles SB (2007) Management strategies for herbicide-resistant weed populations in Australian dryland crop production systems. *Weed Technol* 21: 332-338
- Walsh MJ, Powles SB (2014) High seed retention at maturity of annual weeds infesting crop fields highlights the potential for harvest weed seed control. *Weed Technol* 28:486-493
- Walsh MJ, Newman P, Powles SB (2013) Targeting weed seeds in-crop: a new weed control paradigm for global agriculture. *Weed Technol* 27:431-436

Chapter 16: Coordinating Integrated Weed Management Tactics, A Scenario

Mark VanGessel

Summary

Integrated weed management involves a very broad range of tactics, some directly impacting weeds and others having an indirect effect. The goal is to lessen the over-reliance on any one tactic that allows one species to become dominant in a field, including selecting for herbicide-resistance populations. There are a number of potential approaches, many that require planning one to two years in advance. Each farm (or field) needs to be evaluated for what is feasible and what will be successful.

Introduction

Successful IWM programs will be site-specific. Many factors determine what tactics to use, such as weed species in the field, soil type, environment, and grain prices. Integrated tactics such as prevention, scouting, and identification are all important for implementing successful IWM strategies, even though none of them directly kill weeds. Other tactics such as crop rotation or cultural practices are often selected for agronomic reasons but also can have important effects on weed management. In many cases, these nonchemical approaches will not replace herbicides. Instead they supplement herbicides to provide more consistent control and reduce the risk that a few plants might survive and produce seeds. Other tactics like cultivation or herbicide application are used with the main purpose of killing weeds.

Each farmer should evaluate what is feasible for a particular field, prioritizing fields that need a more comprehensive approach or higher level of IWM utilization (i.e. the use of multiple IWM tactics). A farmer should then determine appropriate mechanical, cultural, chemical, and biological tactics and evaluate his or her ability to implement these tactics. It is not possible to discuss all potential IWM scenarios, but analyzing the scenario below provides better understanding of the relationship among various IWM tactics.

Scenario

Scouting history from the past three years indicates a field contains triazine-resistant common lambsquarters, acetolactate synthase-resistant (ALS-R or Group 2-resistant) redroot pigweed, velvetleaf, and large crabgrass. For the upcoming season, the field will be planted with corn. This field has followed corn-soybean rotation for the past 6 years.

Prevention and scouting

Prevent any new species or herbicide-resistant biotypes from entering the field. This includes cleaning any equipment used in fields with hard-to-manage weeds before leaving that field. When purchasing used equipment or having custom work done, be sure the equipment is inspected and cleaned prior to delivery to prevent unwanted weed species from being transported with the equipment.

Purchase certified corn seed and find a reputable supplier of cover crop seeds. This includes buying certified cover crop seeds; or if buying local seed it should have been grown in weed-free fields, and the combine and seed handling equipment cleaned thoroughly to exclude foreign matter and weed seeds.

Triazine herbicides will not control common lambsquarters and ALS-inhibiting herbicides will not control redroot pigweed because of the presence of herbicide-resistant biotypes. However, these herbicide-resistant biotypes are still susceptible to other control tactics, such as cultural and mechanical weed control and the application of herbicide groups to which they are not resistant. Herbicide resistance does not change these weeds' emergence patterns, growth rates, or susceptibility to other weed management tactics.

Table 16.1. Relative advantage of various tactics for weed management for the scenario described.

Crop rotation	Relative advantage
Corn last year	neutral
Soybean last year	Low
Wheat fb ² soybean last year	High
Tillage	
Chisel plow	neutral
No-till	Moderate
Considerations: <ul style="list-style-type: none"> • no-till systems requires special equipment to cultivate • no-till prevents mechanically incorporating herbicides 	
Cover crop	
None	neutral
Rye - terminated April 1	Low
Rye - terminated 10 days before planting	High
Considerations: <ul style="list-style-type: none"> • cultivating fields with cover crop residue requires special cultivator • planter adjustments maybe needed due to cover crop residues 	
Cultural	
Timely planting	Low
Fertility	
all at planting	disadvantage
side-dress application	High
Hybrid selection²	
allows sunlight infiltration	neutral
provides dense leaf canopy	Low
provides late-season shading	Moderate
Row spacing³	
30-inch	neutral
15-inches or less	neutral
Considerations: <ul style="list-style-type: none"> • corn canopy can intercept herbicide spray, be sure to treat the field early to avoid canopy interference 	
Herbicide⁴	
Reduced rate PRE ¹ fb glyphosate	disadvantage
Full rate PRE fb glyphosate + Callisto®+ atrazine	Low to Mod ⁵

Inter-row cultivation		
None		neutral
One or more cultivations		Moderate
Considerations:		
<ul style="list-style-type: none"> requires special equipment for no-till or cover crops 		
Late-season weed control		
None		disadvantage
Hand pulling		Moderate
Harvest time		
Delayed harvest (2 wks past 15% moist.)		disadvantage
Harvest fb mowing stalks		Low
Harvest fb wheat planting ⁶		Moderate
<p>¹Abbreviations: fb= followed by; PRE= preemergence; wks= weeks.</p> <p>²Corn hybrids differ in their abilities to produce shade, depending on maturity date, leaf architecture, stay green, and drydown. Hybrids with horizontal leaves provide more shading and better weed control than hybrids with upright leaves. Hybrids with better stay green ratings provide more late-season shading.</p> <p>³Corn row spacing has little impact on weed suppression. However, soybean and sorghum are more competitive with weeds when planted in 15-inch rows or narrower.</p> <p>⁴Level of IWM related to herbicides is dependent on what herbicides were used last season. If corn was planted last season, then avoid using the same herbicide program.</p> <p>⁵Callisto[®] (mesotrione) is an example of an herbicide site of action that is effective on common lambsquarters and redroot pigweed. A high level of IWM would ensure that Callisto[®] (or another Group 27 herbicide) is not used in consecutive years.</p> <p>⁶Emerged weeds are controlled with plowing or effective non-selective herbicide prior to planting wheat.</p>		

Weed emergence

The success of weed management tactics often relies on knowing when weeds begin to emerge and for how long emergence occurs. Common lambsquarters and redroot pigweed begin to emerge in early spring and continue emerging throughout July, although the majority of plants emerge by early June. Velvetleaf has a shorter weed emergence period, starting shortly after redroot pigweed and common lambsquarters. By late May, the emergence of most velvetleaf is complete. Large crabgrass emergence begins later (late May) and continues through late July. There is not a single time that is ideal for controlling all four of these species. The long emergence period of large crabgrass will require that the ground is shaded by the crop canopy or cover crop residue, or a postemergence herbicide with residual control is used.

Crop rotation and cultural weed management

Successful IWM takes into account what happened in a field the previous year. Rotating between different crops allows for a more diverse IWM approach. IWM programs for a second year of corn should use different tactics from the previous year. If soybean were planted last season, the different planting dates and fertility programs will increase the diversity of IWM options. Because corn is planted earlier than soybean, tillage or herbicide applications occur at different times and target weeds at different stages of growth over the two seasons.

IWM options become even more diverse if last year the field was planted with winter wheat followed by double-cropped soybean. This rotation provides a dramatically different planting date, with early-emerging weeds controlled prior to planting soybean with a non-selective herbicide (i.e. glyphosate, paraquat or glufosinate), and then a short growing-season that would have minimized the potential number of weed seeds produced. The narrow row spacing of small grain would provide maximize shading early in the summer. Using winter wheat and soybean result in fertilizer applications at different times of the year. Winter wheat fertilizers are applied in early spring well before most summer annual weeds begin to emerge. Because no nitrogen is applied to soybean, summer weed growth is slowed or limited by lack of nitrogen availability.

Crop rotation reduces crop disease and insect pressure compared to continuous cropping, and this in turn increases crop competitiveness with weeds. In addition, crop rotation often allows use of different herbicide sites of action. While monocultures can incorporate different herbicide sites of action, crop rotation allows farmers to use an even wider selection of herbicide groups.

Corn hybrids differ in their abilities to develop competitive crop canopies that prevent sunlight from reaching weed seedlings. Characteristics such as leaf architecture (upright versus horizontal), stay green, and drydown all affect how late into the season the crop canopy can intercept sunlight and prevent weed growth. A moderate and high level of IWM utilization would consider crop hybrid selection based on these characteristics and select hybrids with horizontal leaves and higher stay green ratings and quick drydown traits. These stay green and drydown traits give the plant maximum sun interception for as long as possible.

Light interception and corn competitiveness when planted in row spacings less than 30 inches have little to no impact on weed management. Soybean and sorghum that have a significant improvement on weed management in row spacing less than 20 inches, but the same is not observed with corn.

Tillage

The effect of tillage on weeds is difficult to predict. If the field has been tilled annually or every other year, then planting corn after chisel plowing will likely increase

the germination rates and density of all the four weed species in this scenario. Using no-till for this season would reduce overall weed emergence. However, if the field has been managed under a no-till system, then weed seeds are concentrated in the upper one to two inches of the soil rather than evenly distributed throughout the soil. As a consequence, chisel plowing or no-till this year may lead to higher weed densities than if the field is moldboard plowed. Chisel plowing results in soil gas exchange and seed coat damage. At the same time, it does not bury seeds, so the process will likely lead to a large flush (or cohort) of seedlings right after tillage. No-till often will lead to a longer weed emergence period than tillage. Moldboard plowing will bury seeds at least four inches deep, where they are less likely to emerge and become established (see Chapter 13: *Pre- and Post-Plant Mechanical Weed Control*).

Since common lambsquarters, redroot pigweed and velvetleaf are early emerging species, tillage as a stale-seedbed approach can reduce weed density (see Chapter 13: *Pre- and Post-Plant Mechanical Weed Control*). Plowing and disking the soil two to three weeks before planting corn will provide stimuli for weed emergence with a final field cultivation just prior to planting to eliminate all emerged weeds. This strategy is likely to be less effective on large crabgrass since it is a later emerging species.

It should be noted that tillage and stale-seedbed will reduce or eliminate the benefits of cover cropping for weed management. In addition, tillage can have negative effects on soil structure and reduce organic matter in the soil. When including cover crops for IWM, tillage is either eliminated or restricted to narrow bands over the crop row with strip tillage or row cleaners.

Post-plant cultivation can increase the diversity of IWM practices employed and is compatible with crop rotations and most herbicides. Cultivation is an effective tool that can control most annual weed species and affects all but a narrow band of soil where the crop is planted. It can disrupt herbicide layers if the cultivator sweeps are set lower than the herbicide depth, which could reduce weed control. It also can result in additional weed flush due to soil gas exchange, reducing soil crusting, and/or weed seed coat scarification. Cultivation is generally considered an option only with conventional tillage, but cultivators are available to control weeds in no-till and with cover crop residues.

Cover crop

Cover crops often provide competition that reduces the number, size, and vigor of winter annual weeds and early-emerging summer annual weeds. Cover crop effectiveness depends on species planted, planting date, and termination timing. Slow-growing cover crops such as hairy vetch or crimson clover are not as effective competing with winter annual weeds as rapidly growing cover crop species such as cereal rye. However, if hairy vetch or crimson clover are allowed to reach the flowering stage in the spring prior to termination, they can be very effective in suppressing

summer annual species. If enough cover crop residue is left after termination, it can improve summer annual weed control by preventing light from reaching the soil and hindering further weed germination and seedling growth.

When cover crops grow later in the spring, the plants produce more lignin and the cover crop residue is more resistant to degradation on the soil surface. Cover crops terminated seven to ten days before cash crop planting will be more effective in suppressing later emerging weeds, such as large crabgrass, than a cover crop terminated three weeks or longer prior to planting.

The process of terminating cover crops also can kill emerged weed seedlings. Herbicides often used to terminate cover crops, such as glyphosate or paraquat, will provide control of emerged weeds. Mowing or using roller-crimping to terminate cover crops is often less effective for control of small or short weeds, which may grow rapidly once the cover crop is terminated. In addition, mowing will cut and shred the cover crop into small pieces that are likely to break down rapidly and not provide suppression of later emerging weed species.

Chemical weed control

Herbicides are commonly used for weed control. As discussed in Chapter 7: *Chemical Control*, the information collected while scouting should be used to tailor a herbicide program for the weed species present, determine when to treat the field, and ascertain if the treatment was successful. Since this field has species that emerge both early (common lambsquarters and redroot pigweed) and late (large crabgrass), herbicides that provide residual control will improve overall weed control. Since two weed species are herbicide resistant, herbicide options are limited. While common lambsquarters are resistant to triazines, this herbicide group will likely be used for corn to control redroot pigweed and velvetleaf. Since a number of weed species have developed resistance to ALS-inhibiting herbicides, and there are effective alternatives for the weeds present in the field, moderate and high IWM utilization would not use ALS-inhibiting herbicides in corn. This would limit the selection pressure of ALS-inhibiting herbicides by using them only in soybean.

Large crabgrass has a long germination period and may require a postemergence herbicide. Scouting will determine if a postemergence spray is necessary and ensure the application is made before the large crabgrass becomes too tall for effective control.

Late-season weed control

A low-intensity IWM program would not use any additional weed control after “layby” (the time when the crop canopy starts to shade the entire soil surface). A moderate level of weed control may incorporate the application of an appropriate herbicide with drop nozzles to control late emerging weeds that could produce weed seed. A high level of IWM utilization would hand pull patches of velvetleaf and

lambquarters before they produce viable seed. Both of these species produce seeds that survives for over 10 years in the soil seedbank, hampering weed management for many years.

Harvesting the corn in a timely fashion can influence late-season weed growth and limit weed seed production. Once the corn crop starts to dry down, sunlight can reach shorter weeds and allow them to regrow and produce additional weed seeds. With a high level of IWM utilization a farmer would harvest fields as soon as grain reaches an acceptable moisture level. Harvest would be followed by mechanical or chemical control of emerged weeds to prevent further weed seed production.

If weed management was not successful and common lambquarters and velvetleaf produced mature seeds, a high level of IWM would limit their spread. An example is harvesting the infested portion of a field last, and then thoroughly cleaning the combine before it leaves the field to keep the infestation confined.

Scouting at harvest is critical for high levels of IWM to determine which weed species are present and which ones produced viable seed. Each year, review and evaluate the success of achieving zero weed seed production and make modifications based on scouting information.

Key Points

- Including multiple, effective weed management tactics is the cornerstone of managing herbicide-resistant weeds and reducing the risk of selecting for additional herbicide-resistant biotypes.
- Understanding the compatibility of various tactics will allow for a higher level of IWM utilization.
- IWM can improve the consistency of chemical weed control.
- While many cultural and tillage practices may be used solely for agronomic regions, recognizing the practices' benefits allows for a more comprehensive approach to IWM.

Glossary

Adjuvant – a product typically used with postemergence herbicides to improve herbicide activity, including nonionic surfactants, crop oil concentrates, or methylated seed oil.

Between-row cultivation – cultivating or tilling between the crop rows to control weeds after the crop has emerged.

Biennial – a species that requires two years to complete its life cycle. The life cycle begins with seed germination and emergence.

Biological weed control (biocontrol) – the deliberate use of a weed's natural enemies to reduce weed density to a tolerable level. Natural enemies are usually insects or pathogens, but grazing animals are used as biological weed control in some situations.

Biomass – the tissue (roots, stems, leaves, and reproductive structures) produced by a plant.

Biotypes – a group of individuals within a species that have a distinct genetic variation, such as a trait for herbicide-resistance.

Blind cultivation (also known as blind tillage) - Shallow tillage performed shortly after planting the cash crop for weed control. This process disturbs 100 percent of the soil surface without regard for crop rows.

Bulb – underground perennial food storage organ; contains numerous overlapping leaf scales.

Carabids – ground beetles that are commonly associated with seed predation.

Chaff – the small pieces of crop and weed residue separated from the harvested grain and larger pieces stems and leaves.

Cohort (also known as weed flush) – all weeds that emerge within a short time period, typically after tillage, planting, or similar activities.

Conservation biocontrol – manipulating a cropping system to increase the populations of natural weed suppressing organisms (typically insects).

Conventional tillage – the use of inversion tillage, such as a moldboard plow or chisel plow, prior to planting to create a seedbed. Leaves little exposed plant residue on the soil surface.

Cracking – soybean beginning to emerge from the soil, and the soil surface “cracks”; soybean are in the crook stage (see below).

Critical weed-free period – the time during which the crop needs to be free of weeds to show no detrimental effect on yield

Crook stage – the stage of plant growth when a bean seedling is emerging from the soil and only the stem (hypocotyl) is exposed. The cotyledons are still beneath the surface.

Crop rotation – the sequence of crops planted in one field. This can include more than one crop per year or a crop sequence spanning multiple years.

Desiccate – to remove the moisture from something or dry out.

Dicots (also known as broadleaves) - group of plants that have two cotyledons contained within the seed; the first leaves to emerge are on opposite side of the stem.

Dispersal – the act of spreading. Weed seed dispersal can occur by many mechanisms including animals, such as birds, by wind or water, or by the movement of machinery through fields.

Drydown – the physiological process of a crop losing moisture after it has reached full reproductive stage.

Fallow – a period during a crop rotation when no crop is grown; generally done to control weeds and/or conserve soil moisture.

Genetically modified (GM) crop (also known as **traited crop**) – plants developed with genetic engineering, a more precise method of plant breeding than traditional techniques. This procedure enables specific, predictable changes to be made to the plant.

Green-up – when plants break winter dormancy and begin growing again; easily visible because the plants literally become greener in color.

Ground beetles (also known as carabids) – A group of insects associated with seed predation.

Growing point – the region of the plant where the plant tissue is actively growing, resulting in larger plants. For broadleaf plants, this is typically at the top of the stem, while for grasses, it is at the base of the stems.

Growth stage – definite periods of plant growth during its life, marked by number of leaves, plant growth, or plant development.

Guidance systems – systems that use mechanical, hydraulic, and electronic methods to monitor equipment movement in relation to the crop row, and then move the tractor, the hitch or the tool to the desired alignment.

Harrow – an agricultural implement consisting of many spikes, tines, or discs dragged across the soil.

High residue – cropping systems that maintain crop residue on the soil surface; often associated with no-till or conservation tillage.

Inter-row cultivation – cultivating or tilling to control weeds after the crop has emerged between the crop rows.

Knockdown – application of a non-selective herbicide that kills all plants.

Mechanism of action (also known as **site of action**) – the specific enzymatic activity that a herbicide targets to kill a plant.

Meristem (also known as **meristematic tissue**) - undifferentiated plant tissue where new cell development occurs. Its main function is to trigger the growth of new cells in young seedlings at the tips of roots and shoots and forming buds.

Minimum tillage – generally synonymous with reduced tillage.

Mode of action – effect that a herbicide has on plant growth. These are typically visual symptoms observed within days or weeks of herbicide application.

Monocots – group of plants that includes grasses and sedges. Monocots have a single cotyledon contained within the seed. They tend to have a fibrous root system and narrow leaves.

Node – slightly enlarged portion of the stem where leaves and buds develop.

Nonselective – a herbicide that generally controls a large number of plants, including crops.

Overwinter – when organisms begin growth in late summer or fall and then goes dormant during the cold winter months and resumes growth in the spring. Usually pertains to organisms that complete their life-cycles within a twelve month period.

Perennial – a plant that produces vegetative structures that allow it to live for more than two years.

Plasticity (also known as phenotypic plasticity) – plants responding to their environment often changing growth characteristics.

Postemergence – a herbicide application put down after plants have emerged from the soil.

Post-plant tillage – tillage or cultivation that takes place after the crop is planted; primarily used for weed control.

Predation – the event in which a hunting organism or predator attacks and feeds on another organism or prey. For example, a ground beetle is the predator, and weed seed is the prey.

Preplant tillage – tillage that occurs prior to planting a crop.

Primary tillage – the first tillage operation that occurs in a phase of a growing rotation, such as plowing after a crop is harvested and before planting the next crop.

Propagules – structures by which new plants develop; includes seeds, rhizomes, stolons, bulbs, etc.

Reduced tillage – uses less intensive tillage tools, such as a chisel plow, that generally do not invert the soil. A soil conservation practice used to create the seedbed prior to planting.

Refuge – a place of shelter, protection or safety.

Rhizome - horizontal, underground stem capable of producing stems and roots at a buds.

Ridge tillage – a management system that plants crops on ridges created by cultivation of the previous year's crop.

Rosette – a cluster of leaves that grow close to the ground, generally in a circular pattern.

Scarification – abrasion or scrapes of the seed coat that allows moisture to enter.

Secondary tillage – additional tillage operations that occur after primary tillage to create a finer seedbed; often uses disks and field cultivators.

Seed rain – seeds naturally released from the mother plant. Seeds may fall directly to the ground, be forcibly ejected a short distance, or released and carried by winds over long distances.

Seed shed – the period during which weeds release mature seeds into the environment.

Seedbank (also known as **weed seedbank**) – weed seeds that exist in the plow layer of the soil that could potentially germinate and emerge in the future.

Selection pressure – a factor or event that results in one or a few weed species producing seed and increasing in density while other species are controlled. The factor or event could be herbicides, tillage, biological control organism, etc.

Shank – a metal rod that connects the frame or toolbar to a cultivation tool such as a sweep or shovel. Shanks can be of various shapes, providing different utilities.

Shovel – a V-shaped blade with a raised center (crown) that is used to cultivate the soil.

Site of action (also known as **mechanism of action**) – the physical location within a plant cell where herbicide activity first occurs.

Species shift – see **weed species shift**.

Stale seedbed – tilling or disturbing the soil several weeks prior to planting the crop to stimulate weed germination and emergence. Emerged weeds are controlled with additional tillage or other tactics before planting.

Stay green – a crop trait that allows the plant to remain green very late into its life cycle and hinders the plant from drying down.

Stolon – horizontal, aboveground stem capable of producing stems and roots at a buds.

Summer annual – a plant that germinates from seed in the spring or summer and completes its life cycle before winter.

Sweep (also known as share) – a V-shaped blade that is used to cultivate the soil. They come in different widths and shapes that determine the amount of area tilled and intensity of tillage or soil movement.

Tank-mix – adding more than one herbicide to a spray tank; allows multiple herbicides to be applied simultaneously.

Termination – killing of a plant by any number of methods, including herbicide, tillage or mowing. Often refers to killing cover crops.

Trifoliate leaves – plant leaves composed of three leaflets. Soybean have trifoliate leaves, with the exception of the first set of leaves on the plant (see unifoliate leaves).

Tubers – enlarged end of a rhizome or stolon, capable of producing new shoots and roots.

Unifoliate leaves – typically the first set of soybean leaves to develop. These leaves develop across from one another on the soybean stem; all later developing leaves are trifoliate.

Vegetative stage – the development stage of a plant before it produces any flower structures (including flower buds).

Volatilization – converting a liquid or solid into a vapor or gas stage.

Weed – a plant that is unwanted in a specific setting. Weeds often interfere with human activities and are undesirable.

Weed escapes – weeds that are not killed when they are seedlings and actively grow late in the vegetative or reproductive stage of the crop.

Weed flush – all weeds that emerge within a short time period, typically after tillage, planting, or similar activities. Also known as cohort.

Weed species dynamics – how the agricultural environment changes the abundance of different weed species over time.

Weed species shifts – an agricultural practice or environmental change that allows for new weed species to increase in density, usually as other species decline in density.

White thread stage – the stage after a weed seed germinates and the shoot begins to elongate, but has not yet emerged above the soil surface. In the absence of exposure to sunlight, the shoot appears white and resembles a thread.

Winter annual – a plant that germinates from seed in late summer or fall and completes its life cycle before the following fall. A plant that emerges in the fall, survives the winter, and resumes growth in the spring.

Appendix I. Plant Descriptions

Common features of broadleaf weed seedlings (source Michigan State University, Integrated Pest Management, Publication E3081).

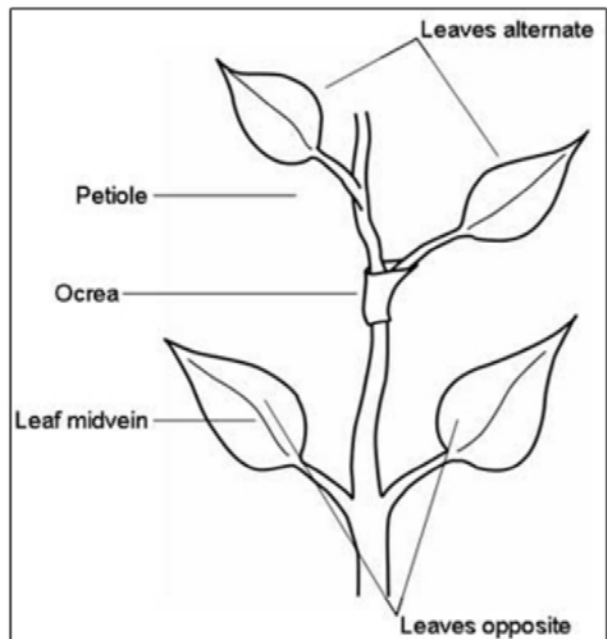
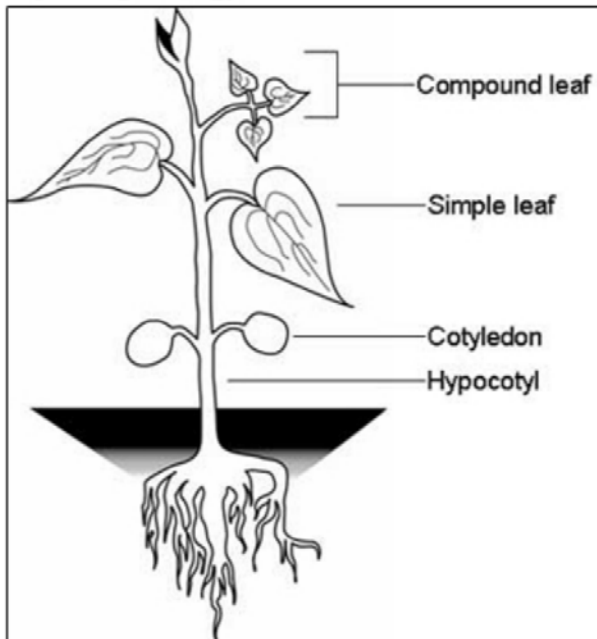

Common features of grassy weeds (source: /PMG/WEEDS/ID/idcharac.html, Agriculture and Natural Resources, University of California).

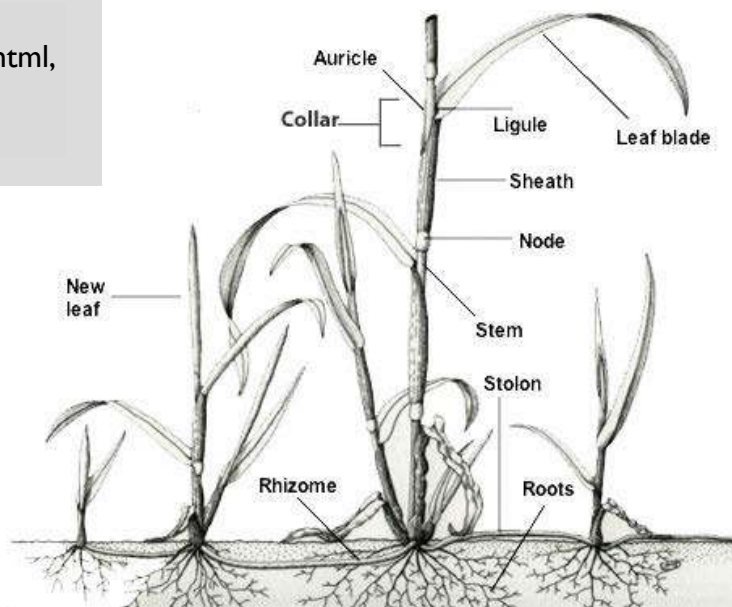

Appendix 2. Weed Identification Resources

Item	Source	Link
Websites	Virginia Tech	https://weedid.cals.vt.edu/
	Penn State	http://plantscience.psu.edu/research/centers/turf/extension/plant-id
	UMass Amherst	https://extension.umass.edu/landscape/weed-herbarium
	Ohio State University	Perennial and Biennial weeds: http://www.oardc.ohio-state.edu/weedguide/
Guide/Key	University of Delaware	Grasses: https://cdn.extension.udel.edu/wp-content/uploads/2012/08/31095159/NE-42-Life-History_Grass-ID.pdf
	University of Delaware	Broadleaves: https://cdn.extension.udel.edu/wp-content/uploads/2012/08/31095159/Phillips_Weeds-of-the-NE_basal-leaf-characteristics.pdf
Apps	Virginia Tech	https://weedid.cals.vt.edu/
	University of Missouri	http://weedid.missouri.edu/
	iNaturalist	https://www.inaturalist.org/pages/seek_app
	PictureThis	https://apps.apple.com/us/app/picturethis-plant-identifier/id1252497129
	ScoutPro	https://www.scoutpro.org/
	Xarvio	https://www.xarvio.com/en/Scouting
	Clinic	Virginia Tech
Fee-based Services	University of Tennessee	http://www.weeddiagnostics.org/Pages/Weed-Identification.aspx
Book	Weeds of the Northeast	ISBN-13: 978-0801483349 http://www.cornellpress.cornell.edu/book/?GCOI=80140100077290