





ALEXANDER KUPERS

LECTURES ON DIFFEO-  
MORPHISM GROUPS OF  
MANIFOLDS, VERSION  
FEBRUARY 22, 2019



# Contents

1	<i>Introduction</i>	13
1.1	<i>Diffeomorphisms of disks</i>	13
1.2	<i>Why?</i>	14
1.3	<i>An overview of this book</i>	16
	<i>I Comparing diffeomorphism groups</i>	19
2	<i>Prerequisites</i>	21
2.1	<i>Manifolds and maps between them</i>	21
2.2	<i>Submanifolds and embeddings</i>	24
3	<i>The Whitney topology</i>	25
3.1	<i>The Whitney topology</i>	25
3.2	<i>The diffeomorphisms of <math>D^1</math></i>	30
3.3	<i>The strong Whitney topology</i>	31
4	<i>Collars</i>	33
4.1	<i>Comparing diffeomorphism groups</i>	33
4.2	<i>Collars</i>	34
4.3	<i>The left horizontal arrows</i>	37

5	<i>The exponential map</i>	39
5.1	<i>The exponential map</i>	39
5.2	<i>Tubular neighborhoods</i>	41
5.3	<i>The right horizontal maps</i>	43
6	<i>Convolution</i>	49
6.1	<i>Weak Whitney embedding theorem</i>	49
6.2	<i>Approximation by smooth functions</i>	51
6.3	<i>The vertical arrows</i>	53
6.4	<i>Diffeomorphism groups as simplicial groups</i>	54
	<i>II Low dimensions</i>	57
7	<i>Smale's theorem</i>	59
7.1	<i>Squares vs. disks</i>	59
7.2	<i>Smale's proof</i>	60
7.3	<i>Diffeomorphisms of <math>S^2</math></i>	65
8	<i>Parametrized isotopy extension</i>	67
8.1	<i>Parametrized isotopy extension</i>	67
9	<i>Embeddings of Euclidean space</i>	73
9.1	<i>Embeddings of <math>\mathbb{R}^m</math></i>	73
9.2	<i>Connected sums</i>	76
9.3	<i>Diffeomorphisms of <math>S^2</math> revisited</i>	77
10	<i>Gramain's proof of Smale's theorem</i>	79
10.1	<i>Gramain's proof of Smale's theorem</i>	79
10.2	<i>Path-components of embeddings of arcs in surfaces</i>	82
10.3	<i>Path-components of diffeomorphism groups of surfaces</i>	84

11	<i>Hatcher's proof of the Smale conjecture</i>	87
	11.1 <i>A restatement of Smale's theorem</i>	87
	11.2 <i>Hatcher's proof and Alexander's theorem</i>	90
	11.3 <i>Consequences of Hatcher's theorem</i>	92
	<i>III The s-cobordism theorem</i>	95
12	<i>Transversality</i>	97
	12.1 <i>Sard's lemma</i>	97
	12.2 <i>Transversality</i>	100
	12.3 <i>Jet transversality</i>	104
13	<i>Morse functions</i>	107
	13.1 <i>Morse functions</i>	107
	13.2 <i>The Morse lemma</i>	109
14	<i>Handles</i>	113
	14.1 <i>The difference between level sets</i>	113
	14.2 <i>Handles</i>	118
15	<i>Handle modifications</i>	121
	15.1 <i>Cobordisms</i>	121
	15.2 <i>The handle isotopy lemma</i>	122
	15.3 <i>The handle rearrangement lemma</i>	123
	15.4 <i>The handle cancellation lemma</i>	124
16	<i>Handle exchange</i>	127
	16.1 <i>Handle decompositions and topology</i>	127
	16.2 <i>The handle exchange lemma</i>	129
	16.3 <i>Removing handles of index 0, 1, <math>w - 1</math>, and <math>w</math></i>	131
	16.4 <i>Smooth structures on <math>D^2</math></i>	132

17	<i>The s-cobordism theorem</i>	135
	17.1 <i>The two-index lemma</i>	135
	17.2 <i>Manipulating two-index h-cobordisms</i>	136
	17.3 <i>The s-cobordism theorem</i>	138
18	<i>The Whitney trick</i>	143
	18.1 <i>The Whitney trick</i>	143
	18.2 <i>Dimension 4</i>	147
19	<i>A first look at surgery theory</i>	153
	<i>IV Diffeomorphisms and algebraic K-theory</i>	155
20	<i>Algebraic K-theory</i>	157
	20.1 <i>Algebraic K-theory</i>	157
	20.2 <i>Group completion</i>	159
21	<i>The theorems of Igusa and Waldhausen</i>	165
	21.1 <i>The <math>S_\bullet</math>-construction</i>	165
	21.2 <i>Algebraic K-theory of spaces</i>	168
	21.3 <i>Moduli spaces of h-cobordisms</i>	173
22	<i>The Hatcher-Wagoner-Igusa sequence</i>	177
	22.1 <i>The s-cobordism theorem</i>	177
	22.2 <i>The Hatcher-Wagoner-Igusa sequence</i>	180
23	<i>Isotopy classes</i>	185
	23.1 <i>Pseudoisotopy implies isotopy</i>	185
	23.2 <i>Application to diffeomorphisms of disks</i>	187
	23.3 <i>Facts about <math>\Theta_{n+1}</math></i>	189



24	<i>The results of Kervaire-Milnor</i>	191
25	<i>The Hatcher spectral sequence</i>	193
25.1	<i>Concordance diffeomorphisms of <math>D^n</math>, rationally</i>	193
25.2	<i>Block diffeomorphisms</i>	195
25.3	<i>The Hatcher spectral sequence</i>	196
25.4	<i>The Farrell-Hsiang theorem</i>	200
	<i>V Topological manifolds and smoothing theory</i>	203
26	<i>Topological manifolds and handles</i>	205
26.1	<i>The theory of topological manifolds</i>	205
26.2	<i>Existence of handle decompositions</i>	209
26.3	<i>Remarks on low dimensions</i>	210
27	<i>Kister's theorem and microbundles</i>	211
27.1	<i>Topological self-embeddings of <math>\mathbb{R}^n</math></i>	212
27.2	<i>Microbundles</i>	215
28	<i>Topological transversality</i>	217
28.1	<i>Locally flat submanifolds and normal microbundles</i>	217
28.2	<i>Topological microbundle transversality</i>	218
29	<i>The Kirby-Siebenmann bundle theorem</i>	223
29.1	<i>Bundles and submersions</i>	223
29.2	<i>A weak version of the Kirby-Siebenmann bundle theorem</i>	227
29.3	<i>The Kirby-Siebenmann bundle theorem</i>	229

30	<i>Flexibility and smoothing theory</i>	235
	30.1 <i>The space of smooth structures</i>	235
	30.2 <i>Flexible sheaves</i>	236
	30.3 <i>Flexibility and h-principles</i>	238
	<i>VI Homological stability and cobordism categories</i>	243
31	<i>Stability for symmetric groups</i>	245
	31.1 <i>Quillen's stability argument</i>	245
	31.2 <i>Injective words</i>	247
	31.3 <i>The transfer</i>	249
32	<i>The Barratt-Priddy-Quillen-Segal theorem</i>	251
	32.1 <i>Compact-open configuration spaces</i>	251
	32.2 <i>The 0-dimensional cobordism category</i>	255
	32.3 <i>Comparison to configurations in a cylinder</i>	258
	32.4 <i>A delooping argument</i>	260
	32.5 <i>Application to stable homotopy groups of spheres</i>	262
33	<i>Homological stability for <math>W_{g,1}</math>'s</i>	265
	33.1 <i>Homological stability</i>	265
	33.2 <i>Thickened cores</i>	266
	33.3 <i>Semi-simplicial spaces of thickened cores</i>	269
	33.4 <i><math>K_\bullet(W)</math> is highly-connected</i>	270
	33.5 <i>Quillen's argument</i>	274
34	<i>Homotopy type of cobordism category</i>	277
	34.1 <i>Compact open spaces of submanifolds</i>	277
	34.2 <i>The <math>d</math>-dimensional cobordism category</i>	281
	34.3 <i>Tangential structures</i>	286

- 35 *Surgery in cobordism categories* 289
  - 35.1 *The tangential structure  $\theta$*  289
  - 35.2 *Surgery in cobordism category: statement* 291
  - 35.3 *Surgery in cobordism category: proof outline* 293
  
- 36 *The Weiss fiber sequence* 299
  - 36.1 *Monoids of self-embeddings* 299
  - 36.2 *Self-embeddings of  $W_{g,1}$*  301
  - 36.3 *The Weiss fiber sequence* 302
  
- 37 *Embedding calculus* 307
  - 37.1 *Embeddings and immersions* 307
  - 37.2 *Manifold calculus* 308
  - 37.3 *Embedding calculus* 311
  
- 38 *Finiteness results* 313
  - 38.1 *Finiteness for embeddings* 313
  - 38.2 *Diffeomorphisms of disks* 316



# 1

## Introduction

We give a motivation and an overview for this book. Takeaways:

- Studying diffeomorphism groups of disks is a subject of philosophical and mathematical interest.
- Dimensions  $\leq 3$  and  $\geq 5$  behave quite differently.
- In high dimensions  $\geq 5$ , surgery theory, smoothing theory and cobordism categories provide different approaches and perspectives.

### 1.1 Diffeomorphisms of disks

The focal point of this book are the diffeomorphism groups of disks. More generally, we will also look at moduli spaces of smooth disks (which incorporates the fact that disks may have different smooth structures), or diffeomorphism groups of other manifolds with a relationship to disks (e.g. spheres). Let me for now only give the definition of diffeomorphism groups of disks, with these generalizations and more details to follow in later lectures.

The  $n$ -dimensional disk  $D^n$  is the subspace of  $\mathbb{R}^n$  given by those  $x \in \mathbb{R}^n$  such that  $\|x\| \leq 1$ . This is a smooth manifold with boundary  $\partial D^n$  given by the  $(n-1)$ -sphere  $S^{n-1} := \{x \in \mathbb{R}^n \mid \|x\| = 1\}$ .

**Definition 1.1.1.** We let  $\text{Diff}_\partial(D^n)$  be the group of  $C^\infty$ -diffeomorphisms of  $D^n$  that are the identity on a neighborhood of  $\partial D^n$ , topologized using the  $C^\infty$ -topology.

The guiding question will be the following:

**Question 1.1.3.** What is the homotopy type of  $\text{Diff}_\partial(D^n)$ ?

For example, what are its path components? What are its homology groups? What are its homotopy groups? Is it homotopy equivalent to a Lie group? Are its homotopy groups finitely generated? Can we relate it to other objects in algebraic topology? Can we relate it to other objects in manifold theory?

**Example 1.1.2.** For  $n = 2$ , consider the “swirl”  $C^2$ -diffeomorphism described in polar coordinates by

$$f(r, \theta) := \left( r^2, \theta + 2\pi r^3(1-r) \right)$$

and drawn in Figure 1.1. We can make it  $C^\infty$  by replacing  $r^3(1-r)$  with a  $C^\infty$ -function of the radius that 0 in a neighborhood of 0.

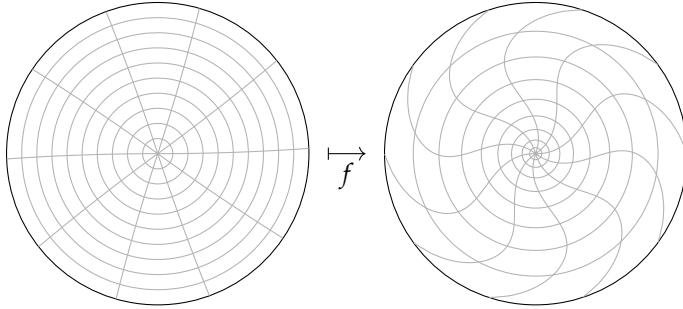

Figure 1.1: The punchy swirl diffeomorphism of  $D^2$ .

## 1.2 Why?

Before telling you about partial answers to this question, we shall give some reasons why one might find it an interesting question. Not of all these might be convincing to you, but hopefully at least one of them is.

### *Intrinsic interest*

The hardest way to motivate a mathematical topic is to say that it is intrinsically interesting. The notion of a manifold is one of several ways modern mathematicians have formalized the notion of “geometry,” as a way to study the intuitive ideas of space, time, shape, and extension. Such a link is made precise in modern theoretical physics (though one might argue that differential geometry and higher category theory are more relevant to physics than differential topology), but even without this manifolds capture a part of these intuitive ideas underlying our experience of reality. Thus results about manifolds can serve to illuminate our intuitions (or challenge manifolds as a good formalization of these intuitions).

Disks play a more fundamental role than the average manifold; using Morse theory or handle theory, we shall see that any smooth manifold can be build out of disks by gluing along their boundary; disks are the basic building blocks of all manifolds.

More importantly, the homotopy type of the topological group of diffeomorphism of disks make *quantitative* some of the intuitive distinctions discussed above. Firstly, diffeomorphism groups of disks capture the subtle phenomena that link the local and global geometry of manifolds; the difference between infinitesimal/infinite and finite extension. Locally, a manifold looks like  $\mathbb{R}^n$  and on  $\mathbb{R}^n$  “difficulties can be pushed out to infinity.” However, in a compact manifold this is not possible, and the non-triviality of diffeomorphisms of disks is the most direct incarnation of this failure, capturing non-local but compactly-supported phenomena. Secondly, in a similar

way diffeomorphism groups of disks capture the subtle differences between smooth and continuous or piecewise-linear phenomena. When studying piecewise linear or topological manifolds, instead of “pushing difficulties to infinity,” one can “push them into a point;” there are no derivatives to blow up. This may be used to prove that homeomorphisms or PL-homeomorphisms of  $D^n$  fixing the boundary pointwise are contractible, known as the *Alexander trick*. Thus the non-triviality of diffeomorphisms of disks measures the difference between smooth and PL or topological manifolds.

### *Interactions with other fields*

The study of manifolds was such an important motivation for the development of topology in the 50's, 60's and 70's, that I will not attempt to give a list. One of the major achievements of that era of topology was the theory of how to build manifolds out of disks is called *surger theory*. In a range of dimensions increasing with the dimension, it solves the problem of classifying manifolds, diffeomorphisms and families of diffeomorphisms, in terms of homotopy theory and algebraic  $K$ -theory. In the case of disks this link is most clear. For example, when  $n \geq 5$  it allows the computation of the set of smooth structures on  $D^n$ . In this direction also lie the Farrell-Jones approach of studying aspherical manifolds, which are very rigid [?].

In the last decade, the study of manifolds has shifted to a field-theoretical perspective. On the one hand, cobordism categories provide a manageable setting for studying all manifolds of a given dimension simultaneously. On the other hand, field theoretic techniques may be used to define invariants of manifolds, diffeomorphisms, or families of diffeomorphisms, which can detect some of these non-trivial in ways not visible to surgery theory.

### *An exciting future*

As mentioned above, the surgery-theoretic techniques to study  $\text{Diff}_\partial(D^n)$  only work in a range and approaches inspired by field theories have given rise two new approaches which are linked and whose full potential has been not realized (in my opinion).

Let me give one example. Variations of the Madsen-Weiss theorem allow one to compute much of the diffeomorphism groups of manifolds with many handles. These may seem far from disks, but by comparing two similar manifolds with many handles one can recover information about disks. The resulting answers seems to indicate that characteristic classes for disk bundles obtained from configuration space integrals, and indexed by graphs, play a prominent role.

### 1.3 An overview of this book

I will now describe the main results that we shall discuss.

#### Low dimensions

As mentioned above, we will start in low dimensions  $n = 1, 2, 3$  to get reacquainted (or acquainted) with the tools of differential topology that we will use throughout the course. At first sight the results in low dimensions are disappointing, but they play a large role in low-dimensional manifold theory and in view of the systematic picture available in high dimensions, highly surprising.

The right object to look at is not  $\text{Diff}_\partial(D^n)$ , but the moduli space  $\mathcal{M}_\partial(D^n)$  of  $n$ -dimensional smooth manifolds that are homeomorphic to  $D^n$  and have the standard smooth structure near the boundary. This is weakly equivalent to a disjoint union

$$\mathcal{M}_\partial(D^n) \simeq \bigsqcup_{[\sigma]} B\text{Diff}_\partial(D^n_\sigma),$$

where  $[\sigma]$  ranges over the isotopy classes of smooth structure on  $D^n$  that are standard near the boundary and  $BG$  denote a classifying space of a topological group  $G$ . The following theorems thus respectively compute  $\pi_0(\mathcal{M}_\partial(D^n))$  [Moi77] and the homotopy type of the unique connected component [Sma59b, Hat83]. We will give proofs of these results for  $n = 1, 2$ , and outline the ideas for  $n = 3$ .

**Theorem 1.3.1** (Folklore, Radó, Moise). *For  $n = 1, 2, 3$ ,  $D^n$  has a unique smooth structure that is standard near the boundary up to isotopy.*

**Theorem 1.3.2** (Folklore, Smale, Hatcher). *For  $n = 1, 2, 3$ ,  $\text{Diff}_\partial(D^n)$  is weakly contractible.*

#### High dimensions: $\pi_0$

In dimension 4 nothing is known (many experts won't commit to conjectures, nor is there an approach), so we skip directly to the high dimensions  $n \geq 5$ .

We shall start by discussing the  $s$ -cobordism theorem. This is the most important of the results relating homotopy theory and algebraic K-theory to manifolds. A cobordism between two closed  $n$ -dimensional manifolds  $M_0$  and  $M_1$ , is a compact  $(n + 1)$ -dimensional manifold  $N$  with an identification  $\partial N \cong M_0 \sqcup M_1$ . It is an  $h$ -cobordism if both inclusions  $M_0 \hookrightarrow N$  and  $M_1 \hookrightarrow N$  are weak equivalences. An example of an  $h$ -cobordism is a product  $N = M_0 \times I$ , and the  $s$ -cobordism gives a condition under which an  $h$ -cobordism is diffeomorphic to one of this form [Sma61, Mil65].



**Theorem 1.3.3** (Smale). *Suppose  $n \geq 5$ , then an  $h$ -cobordism  $N$  between  $M_0$  and  $M_1$  is diffeomorphic to  $M_0 \times I$  rel  $M_0$  if and only if an invariant  $\tau(N) \in \text{Wh}_1(\mathbb{Z}[\pi_1(M_0)])$  vanishes.*

Here  $\text{Wh}_1(\mathbb{Z}[\pi_1(M_0)])$  is a quotient of the group  $K_1(\mathbb{Z}[\pi_1(M_0)])$ , defined as  $\text{colim}_{n \rightarrow \infty} \text{GL}_n(\mathbb{Z}[\pi_1(M_0)])^{\text{ab}}$ , an example of an algebraic  $K$ -theory group. We will use this theorem and ideas from its proof to show that

$$\pi_0(\mathcal{M}_\partial(D^n)) \cong \Theta_n \quad \text{and} \quad \pi_0(\text{Diff}_\partial(D^n)) \cong \Theta_{n+1},$$

where  $\Theta_n$  is the group of homotopy  $n$ -spheres under connected sum. The groups  $\Theta_n$  are related to the stable homotopy groups of spheres by a famous result of Kervaire-Milnor [KM63].

### High dimensions: algebraic $K$ -theory

The results for  $\pi_0$  were generalized to families of manifolds. The parametrized  $h$ -cobordism theorem via Igusa's pseudo-isotopy stability theorem [Igu88] and Waldhausen's stable parametrized  $h$ -cobordism theorem [WJR13b]. Using this Farrell and Hsiang computed  $\pi_i(\text{Diff}_\partial(D^n)) \otimes \mathbb{Q}$  in a range  $i \lesssim n/3$  [FH78]. In this range, it is given by

$$\pi_i(\text{Diff}_\partial(D^n)) \otimes \mathbb{Q} \cong \begin{cases} 0 & \text{if } n \text{ is even} \\ K_i(\mathbb{Z}) \otimes \mathbb{Q} & \text{if } n \text{ is odd,} \end{cases}$$

the latter of which was computed by Borel [Bor74]. We shall prove this using the Hatcher spectral sequence.

### High dimensions: smoothing theory

The space  $\text{Diff}_\partial(D^n)$  has additional algebraic structure: given an embedding  $e: \sqcup_i D^n \hookrightarrow D^n$  and  $i$  elements  $f_i$  of  $\text{Diff}_\partial(D^n)$ , we may produce a new diffeomorphism of  $D^n$  fixing the boundary pointwise by inserting the  $f_i$  into the image of the  $i$  disks of the embedding and extend by the identity, see Figure 1.2.

This gives  $B\text{Diff}_\partial(D^n)$  the additional algebraic structure of an  $E_n$ -algebra and since it is path-connected it is weakly equivalent to  $\Omega^n X$  for some space  $X$  called an  $n$ -fold delooping. After recalling the recognition principle for  $n$ -fold loop spaces, we will produce an explicit example of a  $n$ -fold delooping of  $B\text{Diff}_\partial(D^n)$  by understanding the link between smooth and topological manifolds [BL74]:

**Theorem 1.3.4** (Morlet).  *$B\text{Diff}_\partial(D^n) \simeq \Omega_0^n \text{Top}(n) / O(n)$ , where  $\text{Top}(n)$  is the topological group of homeomorphisms of  $\mathbb{R}^n$  in the compact-open topology.*

$\pi_1$	$\text{Wh}_1(\mathbb{Z}[\pi_1])$
$\{e\}$	0
$\mathbb{Z}$	0
$\mathbb{Z}/2\mathbb{Z}$	0
$\mathbb{Z}/5\mathbb{Z}$	$\mathbb{Z}[t]/(t^5 - 1)$

Table 1.1: Some examples of Whitehead groups.

$n$	5	6	7	8	9	10	11
$ \Theta_n $	1	1	28	2	8	6	992

Table 1.2: The order of  $\Theta_n$  for  $5 \leq n \leq 11$ . See <https://oeis.org/A001676> for the full list for  $n \leq 63$ .

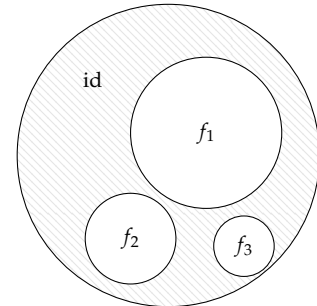

Figure 1.2: Producing a new diffeomorphism of  $D^2$  from three diffeomorphisms  $f_1, f_2, f_3$  of  $D^2$ , and an embedding  $e: \sqcup_3 D^2 \hookrightarrow D^2$ .

This is proven using a combination of general  $h$ -principle machinery [Gro86] and the Kirby-Siebenmann bundle theorem, Essay II of [KS77].

### *High dimensions: cobordism categories*

After this we will describe how to use cobordism categories in combination with embedding calculus to obtain results about  $B\text{Diff}_\partial(D^n)$ , an idea due to Michael Weiss.

We will start with the Pontryagin-Thom theorem computing the groups of manifolds with tangential structure  $\psi: B \rightarrow BO(n)$  up to cobordism in terms of the homotopy groups of the Thom spectrum  $MT\psi$  associated to the virtual bundle  $-\psi^*\gamma$  with  $\gamma$  the universal  $n$ -dimensional vector bundle over  $BO(n)$ . Then we shall explain the parametrized extension of this result [GTMW09]:

**Theorem 1.3.5** (Galatius-Madsen-Tillmann-Weiss). *There is a weak equivalence*

$$BCob^\psi(n) \simeq \Omega^{\infty-1}MT\psi.$$

Results of Galatius-Randal-Williams relate this theorem to diffeomorphism groups of the manifolds  $W_{g,1} := (\#_g S^n \times S^n) \setminus \text{int}(D^{2n})$  [GRW14, GRW18] for the tangential structure  $\theta: BO(2n)\langle n \rangle \rightarrow BO(2n)$ ,<sup>1</sup> there is a map

$$B\text{Diff}_\partial(W_{g,1}) \rightarrow \Omega^\infty MT\theta$$

inducing an isomorphism on homology in the degrees  $\leq \frac{g-3}{2}$ . After that we shall describe embedding calculus [Wei99, BdBW13],<sup>2</sup> which can be used to study spaces of embedding  $\text{Emb}_\partial(M, N)$  as long as the handle dimension  $\text{hdim}_\partial(M)$  of  $M$  rel boundary is smaller than  $\dim(N)$ . The reason this is helpful is that the Weiss fiber sequence relates diffeomorphisms of  $W_{g,1}$  and embeddings of  $W_{g,1} \setminus D^{n-1}$  (where  $D^{n-1} \subset S^{n-1} \cong \partial W_{g,1}$ ) into  $W_{g,1}$ . Taking the complement of an embedding invertible up to isotopy produces a disk with boundary identified with  $S^{n-1}$  and this fits into a fiber sequence

$$\text{Diff}_\partial(W_{g,1}) \rightarrow \text{Emb}_{D^{n-1}}^{\text{inv}}(W_{g,1}) \rightarrow \mathcal{M}_\partial(D^{2n}).$$

One may use this to find non-trivial rational homotopy groups of  $B\text{Diff}_\partial(D^{2n})$  [Wei15], and to show that the homotopy groups are degree-wise finitely generated [Kup17]. A similar story exists in odd dimensions using [BP15, Per15].

<sup>1</sup> For  $n = 1$ ,  $W_{g,1}$  is a genus  $g$  surface with one boundary component. It may thus be regarded as a higher-dimensional analogue of a surface.

<sup>2</sup> The “pointillistic” study of manifolds.

**Part I**

**Comparing diffeomorphism  
groups**



## 2

# Prerequisites

### 2.1 Manifolds and maps between them

In this section we recall some standard definitions, mostly to fix notation.

#### Topological manifolds

There are two equivalent definitions, via charts and sheaves. We start with the classical definition in terms of charts, due to Whitney.

**Definition 2.1.1.** A  $d$ -dimensional topological manifold  $X$  is defined to be a second countable Hausdorff topological space<sup>1</sup> that is locally homeomorphic to an open subset of  $\mathbb{R}^d$ .<sup>2</sup>

Note that every point of an open subset of  $\mathbb{R}^d$  has a subset homeomorphic to  $\mathbb{R}^d$ , so we could have written “locally homeomorphic to  $\mathbb{R}^d$ ” above. That is,  $X$  should come equipped with an *atlas*, that is, a collection of homeomorphisms  $\phi_i: X \supset V_i \rightarrow W_i \subset \mathbb{R}^d$  called *charts*. To make sure different atlases do not lead to different manifolds, one demands that the atlas should be maximal under inclusion (by Zorn’s lemma maximal atlases always exist).

An atlas determines a topological space  $X$  by glueing, i.e. as a coequalizer<sup>3</sup>

$$\bigsqcup_{i,j} W_{i,j} \rightrightarrows \bigsqcup_i W_i \longrightarrow X,$$

where  $W_{i,j} = \phi_i(V_i \cap V_j) \subset W_i$ . Then  $W_{i,j}$  and  $W_{j,i}$  are identified by  $\phi_j \phi_i^{-1}$ , called a *transition function*.

We may rephrase this in analogy with algebraic geometry, and define manifolds as topological spaces with a certain conditions on their real structure sheaf (see Section II.3 of [MLM94]). A *presheaf* of sets  $\mathcal{F}$  on a topological space  $X$  assigns to each open subset  $U \subset X$  a set  $\mathcal{F}(U)$  and to each inclusion  $U \subset V$  a map<sup>4</sup>

$$\text{res}_U^V: \mathcal{F}(V) \rightarrow \mathcal{F}(U)$$

<sup>1</sup> *Second countable* means that the topology on  $X$  has a countable basis, and *Hausdorff* means that every pair of distinct points can be separated by open subsets. These two properties have two important consequences: *paracompactness* and *metrizability*.

<sup>2</sup> This property is called being *locally Euclidean*.

<sup>3</sup> This is a notion from category theory, see [?], and a special case of a *colimit*.

<sup>4</sup> The notation  $\text{res}_U^V$  obviously being shorthand for “restriction from  $V$  to  $U$ .”

such that (i)  $\text{res}_U^U = \text{id}$ , (ii) for  $U \subset V \subset W$  we have  $\text{res}_U^V \circ \text{res}_V^W = \text{res}_U^W$ . In other words, a functor from the opposite of the poset  $\mathcal{O}(X)$  of open subsets of  $X$  to  $\text{Set}$ .<sup>5</sup>

It is a *sheaf* if for all collections of open subsets  $\{U_i\}_{i \in I}$  of  $X$  we have that

$$\mathcal{F}(\cup_i U_i) \longrightarrow \prod_i \mathcal{F}(U_i) \rightrightarrows \prod_{i,j} \mathcal{F}(U_i \cap U_j)$$

is an equalizer. That is, every collection of elements  $f_i \in \mathcal{F}(U_i)$  such that  $\text{res}_{U_i \cap U_j}^{U_i} f_i = \text{res}_{U_i \cap U_j}^{U_j} f_j$  for all  $i, j$ , is obtained from a unique  $f \in \mathcal{F}(\cup_i U_i)$  by restriction.

**Example 2.1.2.** For a topological space  $X$ , the assignment  $C_X^0: U \mapsto \{\text{continuous } f: U \rightarrow \mathbb{R}\}$  forms a sheaf of sets (in fact  $\mathbb{R}$ -algebras) on  $X$ ; this is the sheaf of  $\mathbb{R}$ -valued continuous functions.

We may then rephrase the previous definition as follows:

**Definition 2.1.3.** A  $d$ -dimensional topological manifold  $X$  is a second countable Hausdorff topological space with the following property: for all  $p \in X$  there exists an open neighborhood  $V$  of  $p$  and  $d$  functions  $x_1, \dots, x_d$  in  $C_X^0(V)$ , such that the map  $\phi := (x_1, \dots, x_d): V \rightarrow \mathbb{R}^d$  is a homeomorphism onto an open subset  $W \subset \mathbb{R}^d$  and the sheaf  $\phi^* C_W^0$  is isomorphic to the sheaf  $C_X^0|_V$ . Here  $\phi^* C_W^0$  is the pullback sheaf, defined by assigning to  $U \subset W$  the set  $C_W^0(\phi(U))$ .

### *$C^r$ -manifolds and $C^r$ -maps*

One reason to prefer the definition by sheaves is that it is a more global definition, which allows for a cleaner definition of  $C^r$ -map. So we shall start with this definition and define a  $C^r$ -manifold for  $r \in \mathbb{N} \cup \{\infty\}$ . We know what the sheaf of  $C^r$ -functions assigns to an open subset  $W$  of  $\mathbb{R}^d$ : the set of functions  $f: W \rightarrow \mathbb{R}$  that are  $r$  times continuous differentiable in the following sense (we recall this to fix some notation): for  $|I| \leq r$  the  $I$ th partial derivative  $D^I f$  exists and is continuous. Here  $I$  is an  $s$ -tuple of non-negative integers  $(i_1, \dots, i_s)$  with  $i_k \in \{1, \dots, m\}$ , we define  $|I| := s$ , and for  $f: \mathbb{R}^m \supset W \rightarrow \mathbb{R}$  we then set

$$D^I f := \frac{\partial^{|I|} f}{\partial x_{i_1} \cdots \partial x_{i_s}}.$$

**Definition 2.1.4.** A  $C^r$ -manifold of dimension  $d$  is a topological space  $X$  with a subsheaf  $C_X^r \subset C_X^0$  such that for all  $p \in X$  there exists an open neighborhood  $V$  of  $p$  and  $d$  functions  $x_1, \dots, x_d$  in  $C_X^r(V)$  such that the map  $\phi := (x_1, \dots, x_d): V \rightarrow \mathbb{R}^d$  is a homeomorphism onto an open subset  $W \subset \mathbb{R}^d$  and the sheaf  $\phi^* C_W^r$  is isomorphic to the sheaf  $C_X^r|_V$ . The elements of  $C_X^r(V)$  are called  $C^r$ -functions.

<sup>5</sup> One may define the category of presheaves valued in any category  $\mathcal{C}$  as functors  $\mathcal{O}(X)^{\text{op}} \rightarrow \mathcal{C}$ .

**Definition 2.1.5.** Let  $g: M \rightarrow N$  be a continuous map between  $C^r$ -manifolds. It is  $C^r$  if  $f \circ g \in C_M^r(M)$  for all  $f \in C_N^r(N)$ . Let  $C^r(M, N)$  denote the set of  $C^r$ -maps  $M \rightarrow N$ .

Like the equivalence of the definition of topological manifolds using chart and sheaves, the above definition of a  $C^r$ -manifold is equivalent to one using charts:

**Definition 2.1.7.** A  $C^r$ -manifold is a second countable Hausdorff topological space  $X$  with a maximal atlas of charts  $\phi_i: X \supset V_i \rightarrow W_i \subset \mathbb{R}^d$  whose transition functions  $\phi_j \phi_i^{-1}: W_i \supset \phi_i(V_i \cap V_j) \rightarrow W_j$  have  $r$  times continuously differentiable components.

### Topological and $C^r$ -manifolds with boundary

We may define a topological manifold of dimension  $d$  with boundary as a second countable Hausdorff space locally homeomorphic to  $c$ . The subset of  $X$  consisting of points  $p$  that are mapped to  $\mathbb{R}^{d-1} \times \{0\}$  under these local homeomorphisms is well-defined.<sup>6</sup> The subspace of such points is called the *boundary* of  $X$  and denoted  $\partial X$ .

A smooth manifold with boundary may then either be directly defined in terms of an atlas where the domains of charts are now open subsets of  $\mathbb{R}^{d-1} \times [0, \infty)$ , or as a topological manifold with boundary with a subsheaf of its sheaf of continuous functions. There is a subtlety in the latter case; what is the subsheaf  $C_V^r \subset C_V^0$  for  $V \subset \mathbb{R}^{d-1} \times [0, \infty)$ ? There seem to be multiple reasonable options. On the one hand, one might say that  $C_V^r(U)$  consists of those  $f: U \rightarrow \mathbb{R}$  which extend to some open subset  $\tilde{U}$  of  $U$  in  $\mathbb{R}^d$ . On the other hand, one may take those  $f$  that are  $C^r$  on  $U \cap (\mathbb{R}^{d-1} \times (0, \infty))$  with  $D^I f$  for  $|I| \leq r$  extending to continuous functions on  $U$ . The Whitney extension theorem says that these two conditions are equivalent.

### Topological and $C^r$ -manifolds with corners

Similarly, we may consider second countable Hausdorff spaces that are locally homeomorphic to  $[0, \infty)^d$ . This is called a topological manifold with *corners*. Since  $[0, \infty)^d$  is homeomorphic to  $\mathbb{R}^{d-1} \times [0, \infty)$ , every such space is a manifold with corners. However, for manifolds with corners we should remember the data of the atlas, and then manifold with corners comes with a stratification by *depth*, the numbers of coordinates that are 0. The union of subsets of depth  $> 0$  is the boundary. The extension to  $C^r$ -manifolds is similar as for corners.

**Example 2.1.6.** The assignment  $C_M^r: M \supset U \mapsto C^r(U, N)$  is a sheaf of sets on  $M$ ; this is the sheaf of  $C^r$ -maps to  $N$ .

<sup>6</sup> This may be proven by computing the local homology groups  $H_{d-1}(U, U \setminus \{x\})$  for a  $U$  a neighborhood of  $x \in X$ . This will be  $\mathbb{Z}$  if  $x$  is not in the boundary, and 0 if it is.

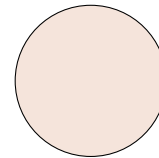

Figure 2.1: A disk  $D^k$  is a smooth manifold with boundary given by  $\partial D^k = S^{k-1}$ .



Figure 2.2: A cube  $[0, 1]^d$  is a  $d$ -dimensional manifold with corners.

## 2.2 Submanifolds and embeddings

Recall that  $M \subset N$  is a  $C^r$ -submanifold of a  $C^\infty$ -manifold  $N$  if for each  $p \in M$  there is a chart  $\psi: N \supset V \rightarrow \mathbb{R}^n$  such that  $\psi^{-1}(\mathbb{R}^m) = M \cap V$ . Given a  $C^r$ -embedding  $\varphi: M \rightarrow N$ , its image  $\varphi(M)$  is a submanifold as a consequence of the inverse function theorem (to prove this, note it suffices to prove this locally in the source and target, reducing to the case of a map  $\mathbb{R}^m \rightarrow \mathbb{R}^n$  with injective differential and sending 0 to 0, which we want to show admits the desired charts near 0, now add  $(n - m)$  additional coordinates and use this to offset the image in  $(n - m)$  directions complementary to the image of the differential at the origin).



# 3

## The Whitney topology

The goal of this lecture is to define diffeomorphism groups as topological groups. To do so we discuss the weak topology on function spaces, which will also be used for several later results in the course, which can be stated as continuity, density or openness results. For background reading on this material see [Hir94, Wal16].

### 3.1 The Whitney topology

So far  $C^r(M, N)$  is just a set. We describe its topology in detail, because it is the topology we will use on the group of diffeomorphisms, and because the topology will play a role in approximation arguments involving “generic smooth functions.” We shall give two definitions of the Whitney topology:

- by giving a sub-basis, which is more concrete and convenient for understanding some examples,
- by giving it as a subspace of a section space, which is more convenient for checking formal properties.

**Remark 3.1.1.** Another good model for spaces is given by simplicial sets. One can always pass from topological spaces to simplicial sets by taking the singular simplicial set. We will see a different simplicial set weakly equivalent to  $C^r(M, N)$  in Section XXX.

#### The Whitney topology by sub-basis

We shall start with a definition in terms of a sub-basis. This means a subset is open if every point has a neighborhood that is a finite intersection of elements of the sub-basis.

**Definition 3.1.2.** Let  $r$  be finite. The (weak) Whitney topology on the set of  $C^r$ -functions  $M \rightarrow N$  has a sub-basis given by sets

$$\mathcal{N}^r(f, \phi, \varphi, K, \epsilon)$$

Takeaways:

- There is a topology on the set of  $C^r$  maps defined in terms of convergence of partial derivatives on compact sets.
- This is best defined as a subspace of the topological space of sections of the  $r$ -jet bundle.
- In this topology the diffeomorphisms form a topological group.
- The topological group  $\text{Diff}_0(D^1)$  is contractible.

indexed by

- $f: M \rightarrow N$  a  $C^r$ -function,
- $\phi: M \supset V \rightarrow W \subset \mathbb{R}^m$  a chart,
- $\varphi: N \supset V' \rightarrow W' \subset \mathbb{R}^n$  a chart,
- $K \subset V$  compact such that  $f(K) \subset V'$ ,
- $\epsilon > 0$ ,

and consisting of all  $g: M \rightarrow N$  that  $C^r$  and have that property that  $g(K) \subset V'$  and  $|D^I(\phi f \phi^{-1})_k^{-1}(x) - D^I(\phi g \phi^{-1})_k^{-1}(x)| < \epsilon$  for all  $x \in \phi(K)$ ,  $|I| \leq r$  and  $1 \leq k \leq n$ .

In this topology a sequence of  $C^r$ -maps converges if and only if on all compact subsets in charts the first  $r$  partial derivatives converge uniformly.

**Definition 3.1.3.** For  $r \in \mathbb{N}$ , we let  $C_{\mathcal{W}}^r(M, N)$  denote the topological space of  $C^r$ -functions  $M \rightarrow N$  with the (weak) Whitney topology, and define  $C_{\mathcal{W}}^{\infty}(M, N)$  to be the coarsest topology on  $C^{\infty}(M, N)$  making all inclusions  $C_{\mathcal{W}}^{\infty}(M, N) \hookrightarrow C_{\mathcal{W}}^r(M, N)$  continuous.

**Notation 3.1.4.** Unless there is a risk of confusion, we will omit the subscript  $W$  from the notation.

A definition in terms of a sub-basis is not a helpful definition if one wants to check this topology behaves as expected. For example, trying to prove that composition is continuous involves covering compact subsets by charts and quickly gets messy.

### *The Whitney topology as a subspace of a section space*

To avoid the messiness of arguments involving the sub-basis, we give a nicer construction of this topology; we construct  $C^r(M, N)$  as a closed subset of a section space in the compact-open topology.

**Definition 3.1.5.** For  $s \leq r$ , the set  $J^s(\mathbb{R}^m, \mathbb{R}^n)$  of  $s$ -jets of  $C^r$  functions  $f: \mathbb{R}^m \rightarrow \mathbb{R}^n$  is defined to be the quotient of  $C^r(\mathbb{R}^m, \mathbb{R}^n)$  by the equivalence relation that says  $f \sim_s g$  if  $D^I f_k(0) = D^I g_k(0)$  for all  $|I| \leq s$  and  $1 \leq k \leq n$  (where  $f_k$  and  $g_k$  denotes the  $k$ th components).

Under addition these form an  $\mathbb{R}$ -vector space, which is isomorphic to the finite-dimensional vector space of ordered  $n$ -tuples polynomials of degree  $\leq s$  in  $m$  variables, by the correspondence<sup>1</sup>

$$[f] \rightsquigarrow \sum_{|I| \leq s} \frac{1}{I!} D^I f(0) t^I,$$

where  $I!$  is defined by  $\prod_{i=1}^m (\#i\text{'s in } I)!$ .<sup>2</sup> We may use this to topologize  $J^s(\mathbb{R}^m, \mathbb{R}^n) := C^r(\mathbb{R}^m, \mathbb{R}^n) / \sim_s$ .

<sup>1</sup> This is just Taylor approximation at the origin.

<sup>2</sup> E.g. for  $I = (1, 1, 2, 3, 3, 3, 3)$ ,  $I! = 2!1!3!$ .

Given a point  $m \in M$ , we can use charts to generalize the definition of  $\sim_s$  to an equivalence relation  $\sim_{s,m}$  on  $C^r(M, N)$  where two  $C^r$ -functions are equivalent under  $\sim_{s,m}$  if their partial derivatives of degree  $\leq s$  coincides at  $m$ . This is well-defined because equality of partial derivatives is independent of the choice of charts

**Definition 3.1.6.** We define the set  $J^s(M, N)$  of  $s$ -jets of  $C^r$  functions  $f: M \rightarrow N$  as the quotient of  $M \times C^r(M, N)$  by the equivalence relation generated by  $(m, f) \sim (m', f')$  if  $m = m'$  and  $f \sim_{s,m} f'$ .

There is a well-defined map  $\pi: J^s(M, N) \rightarrow M$  induced by the projection  $M \times C^r(M, N) \rightarrow M$  and a well-defined map  $\tau: J^s(M, N) \rightarrow N$  induced by evaluation map  $M \times C^r(M, N) \rightarrow N$ . Using charts of  $M$ , one sees that  $\pi$  is a locally trivial bundle over  $M$  with fiber  $J^s(\mathbb{R}^m, N)$ . Similarly using charts of  $N$ , one sees that for  $J^s(\mathbb{R}^m, N)$ ,  $\tau$  is a locally trivial bundle over  $N$  with fiber  $J_0^s(\mathbb{R}^m, \mathbb{R}^n)$ , the subspace of  $s$ -jets mapping 0 to 0. We may use these identifications to topologize  $J^s(M, N)$ .

By construction, the combined map  $(\pi, \tau): J^s(M, N) \rightarrow M \times N$  is locally trivial with fiber  $J_0^s(\mathbb{R}^m, \mathbb{R}^n)$ . We will usually consider it as a bundle over  $M$  via the map  $\pi$ , and then call it the bundle of  $r$ -jets  $M \rightarrow N$  over  $M$ . It is isomorphic to the associated bundle over the principal  $\text{Diff}^r(M)$ -bundle over  $M$  for the action  $\text{Diff}^r(M) \curvearrowright J^s(M, N)$  acting by precomposition.

Given a  $C^r$ -map  $f: M \rightarrow N$ , we can record its  $s$ -jets, by sending it the map  $j^s(f): M \rightarrow J^s(M, N)$  given by  $j^s(f)(m) = [f]_m$ , the latter denoting to the equivalence class of  $f$  under  $\sim_{s,m}$ . The map  $j^s(f)$  is continuous because it is the composite of  $M \rightarrow M \times C^r(M, N)$  given by  $m \mapsto (m, f)$  and the quotient map. It satisfies  $\pi \circ j^s(f) = \text{id}_M$ , so is a section of  $\pi$ .

So, letting  $\Gamma(M, J^s(M, N))$  denote the set of continuous sections, a subset of the set  $\text{Map}(M, J^s(M, N))$  of continuous maps  $f: M \rightarrow J^s(M, N)$ , taking the  $s$ -jets gives a map

$$j^s: C^r(M, N) \rightarrow \Gamma(M, J^s(M, N))$$

We may recover  $f$  from  $j^s(f)$  as the composition  $\tau \circ j^s(f)$ , so the map  $j^s: C^r(M, N) \rightarrow \Gamma(M, J^s(M, N))$  is injective. This is called the inclusion of holonomic sections into all sections, or the inclusion of functions into formal functions. There is a natural topology on  $\Gamma(M, J^s(M, N))$  as a subspace of the mapping space  $\text{Map}(M, J^s(M, N))$  topologized using the *compact-open topology*:

**Definition 3.1.7.** The *compact-open topology* on the set  $\text{Map}(X, Y)$  of continuous functions  $X \rightarrow Y$  has a sub-basis given by sets  $\mathcal{N}(K, W)$  indexed by

- $K \subset X$  compact,
- $W \subset Y$  open,

and consisting of all  $f: X \rightarrow Y$  such that  $f(K) \subset W$ .

However, an advantage of the compact-open topology is that when restricted to reasonable spaces (compactly-generated weakly Hausdorff), then  $\text{Map}(X, -)$  is right adjoint to  $X \times -$  (indeed, mapping spaces between CGWH spaces are again CGWH). For example, the evaluation map  $X \times \text{Map}(X, Y) \rightarrow Y$  is the continuous map adjoint to the identity  $\text{Map}(X, Y) \rightarrow \text{Map}(X, Y)$ . By constructing their adjoints instead, it is possible to prove that various natural maps between mapping spaces is continuous without doing arguments using sub-basis elements.

For the application to the Whitney topology, let us now take  $s = r$ .

**Lemma 3.1.8.** *The subspace topology on  $C^r(M, N) \subset \Gamma(M, J^r(M, N))$  coincides with the weak Whitney topology, and  $C^r(M, N) \subset \Gamma(M, J^r(M, N))$  is closed.*

*Proof.* Those sub-basis elements  $\mathcal{N}(K, W)$  for  $K$  in a chart of  $M$  and  $W$  defined as  $\epsilon$ -neighborhood of  $j^r(f)|_K$  with respect to the identification of  $r$ -jets near  $K$  with polynomials using the charts  $\phi$  and  $\varphi$ , define the same topology as the compact-open topology, because any  $\mathcal{N}(K, W)$  is a union of these special sub-basis neighborhoods. But these sub-basis elements are exactly those generating the Whitney topology.

It is closed since being holonomic means that higher jets are determined by the partial derivatives of the 0th jet, a closed condition.  $\square$

### *Properties of the Whitney topology*

This identification of  $C^r(M, N)$  with a subspace of a section space is a useful tool for proving properties of  $C^r(M, N)$  with the Whitney topology. We shall prove the following properties, always using the strategy of *proving the result for sections of the  $r$ -jet bundle and restricting to holonomic sections*:

- The inclusion  $C^r(M, N) \hookrightarrow C^{r-1}(M, N)$  is continuous.
- Composition  $C^r(M, N) \times C^r(N, P) \rightarrow C^r(M, P)$  is continuous.
- The immersions and submersions are open in  $C^r(M, N)$ .

**Lemma 3.1.9.** *The inclusion  $C^r(M, N) \hookrightarrow C^{r-1}(M, N)$  is continuous.*

*Proof.* If  $E \rightarrow E'$  is a continuous map of locally trivial bundles over  $M$ , then  $\Gamma(M, E) \rightarrow \Gamma(M, E')$  is continuous. To prove this, one notes

that it is the restriction of the map  $\text{Map}(M, E) \rightarrow \text{Map}(M, E')$  obtained by Yoneda from the right adjoint to the natural transformation

$$\text{CGWH}(M \times -, E) \rightarrow \text{CGWH}(M \times -, E').$$

We will apply this to  $E = J^r(M, N) \rightarrow E' = J^{r-1}(M, N)$ . This is continuous, since local triviality we may assume  $M = \mathbb{R}^m$  and  $N = \mathbb{R}^n$  and in that case it is just the claim that a projection in a finite dimensional real vector space is continuous. The lemma follows by restriction to holonomic sections.  $\square$

**Lemma 3.1.10.** *The composition map  $C^r(M, N) \times C^r(N, P) \rightarrow C^r(M, P)$  is continuous. In particular, for  $U \subset M$  open the restriction map  $i_U^*: C^r(M, N) \rightarrow C^r(U, N)$  is continuous.*

*Proof sketch.* Composition of  $C^r$ -functions induces a continuous map  $J^r(M, N) \times_N J^r(N, P) \rightarrow J^r(M, P)$ . This in turn induces a continuous map  $\Gamma(M, J^r(M, N)) \times \Gamma(N, J^r(N, P)) \rightarrow \Gamma(M, J^r(M, P))$ . The lemma follows by restriction to holonomic sections.  $\square$

**Lemma 3.1.11.** *The subsets of immersions and submersions are open in  $C^r(M, N)$ .*

*Proof sketch.* If  $U \subset J^s(\mathbb{R}^m, N)$  is open and invariant under the action  $\text{Diff}^r(M)$ , then the subspace of  $\Gamma(M, J^s(M, N))$  of sections with values in  $U$  is open. Now take  $U$  to be those  $r$ -jets with injective or surjective differential.  $\square$

### *Diffeomorphisms as a topological group*

We now focus our attention on the subspace  $\text{Diff}_W^r(M) \subset C_W^r(M, M)$  consisting of diffeomorphisms. We have shown above that composition of diffeomorphisms is continuous. To show that taking the inverse is continuous is a bit harder, since one not can take the inverse of a general section.

The  $r$ -jet of a diffeomorphism  $f$  has two special properties:

- (i) its  $r$ -jets of  $f$  lie in the subspace  $J^{r,\text{inv}}(M, M)$  of  $r$ -jets of those  $C^r$ -maps have bijective differential, by the inverse function theorem,
- (ii) the map  $\tau \circ j^r(f): M \rightarrow M$  is a homeomorphism.

As for property (i), using local coordinates one sees that inversion is a continuous operation on  $J^{r,\text{inv}}(M, M)$  switching  $\pi$  and  $\tau$ . We thus get an induced map  $\text{inv}: \text{Map}(M, J^{r,\text{inv}}(M, M)) \rightarrow \text{Map}(M, J^{r,\text{inv}}(M, M))$ , but it doesn't preserve sections because  $\pi \circ \text{inv}(s) = \tau(s)$ .

Getting property (ii) involved, suppose we restrict to the subspace  $\Gamma^{\text{Homeo}}(M, J^{r,\text{inv}}(M, M))$  of  $\Gamma(M, J^{r,\text{inv}}(M, M))$  such that  $\tau(s)$  lies in

the homeomorphisms of  $M$ . Then we may consider the continuous map

$$(\tau, \text{inv}): \Gamma^{\text{Homeo}}(M, J^{r,\text{inv}}(M, M)) \rightarrow \text{Homeo}(M) \times \text{Map}(M, J^{r,\text{inv}}(M, M))$$

and compose with the continuous map given by composition of the source

$$\text{Homeo}(M) \times \text{Map}(M, J^{r,\text{inv}}(M, M)) \rightarrow \text{Map}(M, J^{r,\text{inv}}(M, M)).$$

This composition is continuous and lands in the sections. By restricting to holonomic sections coming from diffeomorphisms this amounts to taking the inverse, we conclude:

**Corollary 3.1.12.**  *$\text{Diff}^r(M)$  with the Whitney topology is a topological group.*

### *$C^r$ -manifolds with boundary*

The above definitions can be modified to define the Whitney topology on the  $C^r$ -maps  $f: M \rightarrow N$  between manifolds with possibly non-empty boundary. Similarly, the above arguments can be modified to show that if  $M$  is a manifold with boundary, the group  $\text{Diff}_0^r(M)$  of  $C^r$ -diffeomorphisms fixing the boundary pointwise is a topological group in the Whitney topology.

## 3.2 *The diffeomorphisms of $D^1$*

Having defined Whitney topology on  $\text{Diff}^r(M)$ , we will show that the first non-trivial diffeomorphism group is in fact contractible by a convexity argument.

**Theorem 3.2.1.**  $\text{Diff}_0^r(D^1) \simeq *$ .

*Proof.* We will construct a deformation retraction onto the subspace  $\{\text{id}\}$ . This is done by linear interpolation. That is, we claim that  $H: \text{Diff}_0^r(D^1) \times [0, 1] \rightarrow \text{Diff}_0^r(D^1)$  given by

$$(f, t) \mapsto (1 - t) \cdot f + t \cdot \text{id}$$

is a continuous and well-defined. In particular, we claim that  $H(f, t) \in \text{Diff}_0^r(D^1)$  for all  $(f, t)$ . Continuity follows from the fact that when the manifold is compact and has a single chart, the Whitney topology coincides with the topology of uniform convergence of the map and the first  $r$  derivatives. To prove that  $f_t := (1 - t) \cdot f + t \cdot \text{id}$  is a diffeomorphism, we compute its derivative at  $x_0 \in [0, 1]$ :

$$\frac{df_t}{dx}(x_0) = (1 - t) \frac{df}{dx}(x_0) + t.$$

Since  $f$  is a diffeomorphism its derivative is always non-zero, and since  $f$  must be increasing near 0, the derivative is always positive. This implies  $\frac{df_t}{dx}(x)$  is always non-zero, proving that  $f_t$  is a local diffeomorphism using the inverse function theorem. It also implies that  $f_t$  is strictly increasing, and hence injective. Thus it is a diffeomorphism.  $\square$

This argument proves that  $\text{Diff}_\partial^{r+1}(D^1) \simeq \text{Diff}_\partial^r(D^1)$ , since both are contractible. By a similar argument, one also proves contractibility of the topological groups of diffeomorphisms that are the identity near  $\partial D^1$ , or whose value and first  $r$  derivatives coincide with those of the identity at  $\partial D^1$ , so these are also weakly equivalent. In the next couple of chapters, we will prove all these variations are weakly equivalent for all  $M$ .

### 3.3 The strong Whitney topology

As the adjective weak in our definition of the (weak) Whitney topology suggests, there is also a strong Whitney topology. This serves to control the behavior at  $\infty$  when  $M$  is not compact. It will not reappear, but we shall give its definition for the edification of the reader.

#### *The strong Whitney topology by sub-basis*

**Definition 3.3.1.** For  $r$  finite, the strong Whitney topology on  $C^r(M, N)$  has sub-basis given by

$$\mathcal{N}^r(J, f, \{\phi_j\}, \{\varphi_j\}, \{K_j\}, \{\epsilon_j\})$$

indexed by

- a set  $J$ ,
- $f: M \rightarrow N$  a  $C^r$ -function,
- $\{\phi_j: M \supset V_j \rightarrow W_j \subset \mathbb{R}^m\}_{j \in J}$  a locally finite collection of charts covering  $M$ ,
- $\{\varphi_j: N \supset V'_j \rightarrow W'_j \subset \mathbb{R}^n\}_{j \in J}$  a collection of charts,
- $\{K_j \subset V_j\}_{j \in J}$  a collection of compact subsets such that  $f(K_j) \subset V'_j$ ,
- $\{\epsilon_j\}_{j \in J}$  a collection of positive real numbers,

and consisting of all  $g: M \rightarrow N$  that are  $C^r$  and have that property that  $g(K_j) \subset V'_j$  and  $|D^I(\varphi_j f \phi_j^{-1})_k(x) - D^I(\varphi_j g \phi_j^{-1})_k(x)| < \epsilon_j$  for all  $j \in J$ ,  $x \in \phi_j(K)$ ,  $|I| \leq r$  and  $1 \leq k \leq n$ .

We let  $C_S^r(M, N)$  denote  $C^r(M, N)$  with the strong Whitney topology, and  $C_S^\infty(M, N)$  again by letting  $C^\infty(M, N)$  have the coarsest topology making the inclusion  $C^\infty(M, N) \hookrightarrow C_S^r(M, N)$  continuous.

*The strong Whitney topology as a subspace of a section space*

One may define this in terms of  $r$ -jets by taking the fine topology on the mapping space  $\text{Map}(X, Y)$  instead of the compact-open topology, with sub-basis given by

$$\mathcal{N}(f, U) = \{f \mid \text{id} \times f \in U \subset X \times Y\}$$

for  $U \subset X \times Y$  open. The compact-open and fine topology coincide if the domain  $X$  of the mapping space is compact, from which we conclude:

**Lemma 3.3.2.** *The identity is a continuous map  $C_S^r(M, N) \rightarrow C_W^r(M, N)$ , which is a homeomorphism if  $M$  is compact.*

Using the properties of the fine topology on mapping spaces, one may also prove that composition is continuous, as is inversion of diffeomorphisms, so that  $\text{Diff}_S^r(M)$  is also a topological group.



# 4

## Collars

In the previous chapter we discussed the Whitney topology and showed that diffeomorphism groups in this topology were topological groups. We now start a general discussion how groups of diffeomorphisms with different boundary conditions and differentiability conditions compare, which serves as an excuse to revisit some differential topology. As before, references are [Hir94, Wal16].

Takeaways:

- All reasonable variations on diffeomorphisms are weakly equivalent.
- Collars exist by flowing along an inward pointing vector field constructed using a partition of unity.
- By “sliding along a collar” you can make families of diffeomorphisms be the identity on a neighborhood of the boundary.

### 4.1 Comparing diffeomorphism groups

Let  $M$  be an  $m$ -dimensional compact smooth (i.e.  $C^\infty$ ) manifold with boundary  $\partial M$ . Then there are several variations of its diffeomorphism group that one may define.

- (1) Firstly, we have a choice of differentiability condition, i.e. for  $r \in \mathbb{N} \cup \{\infty\}$  we may let  $\text{Diff}_\partial^r(D^n)$ , etc., denote  $C^r$ -diffeomorphisms that are the identity on  $\partial D^n$  in the (weak) Whitney topology discussed in the previous lecture.
- (2) Secondly, we can change the boundary conditions:
  - $\text{Diff}_{\partial, D}^r(M)$  denotes those diffeomorphisms that are the identity pointwise on  $\partial M$  and all of whose derivatives coincide with those of the identity on  $\partial M$ .
  - $\text{Diff}_{\partial, U}^r(M)$  denotes those diffeomorphisms that are the identity on an open neighborhood of  $\partial M$ .

If we give these the subspace topology, they are all topological groups and we get a commutative diagram of inclusions of topological groups:

$$\begin{array}{ccccc}
 \text{Diff}_{\partial,U}^1(M) & \longrightarrow & \text{Diff}_{\partial,D}^1(M) & \longrightarrow & \text{Diff}_{\partial}^1(M) \\
 \uparrow & & \uparrow & & \uparrow \\
 \text{Diff}_{\partial,U}^2(M) & \longrightarrow & \text{Diff}_{\partial,D}^2(M) & \longrightarrow & \text{Diff}_{\partial}^2(M) \\
 \uparrow & & \uparrow & & \uparrow \\
 \dots & \longrightarrow & \dots & \longrightarrow & \dots \\
 \uparrow & & \uparrow & & \uparrow \\
 \text{Diff}_{\partial,U}^\infty(M) & \longrightarrow & \text{Diff}_{\partial,D}^\infty(M) & \longrightarrow & \text{Diff}_{\partial}^\infty(M).
 \end{array} \tag{4.1}$$

**Theorem 4.1.1.** *All these inclusions are weak equivalences.*

This will take the next few lectures to prove, and during the proof we will also discuss:

- Partitions of unity.
- Existence and uniqueness of collars.
- Weak Whitney embedding theorem.
- Existence of tubular neighborhoods.
- Approximation by smooth functions.

In this chapter we will discuss the left horizontal arrows and collars, and it will *not* be necessary that  $M$  is compact.

### 4.2 Collars

Our main tool be the existence of collars.

**Definition 4.2.1.** If  $M$  is a  $C^r$ -manifold with boundary  $\partial M$ , a *collar* is a  $C^r$ -embedding  $c: \partial M \times [0,1) \rightarrow M$  that is the identity on the boundary.

The existence of collars uses two important tools for studying manifolds: patching together local data using partitions of unity, and flowing along vector fields.

**Definition 4.2.2.** A *partition of unity* subordinate to an open cover  $\{U_i\}_{i \in I}$  of a topological space  $X$  is a collection of continuous functions  $\eta_i: X \rightarrow [0,1]$  such that

- (i) for all  $i \in I$ , the support  $\text{supp}(\eta_i) := \text{cl}\{x \in X \mid \eta_i(x) \neq 0\}$  is contained in  $U_i$ ,
- (ii) only finitely many  $\eta_i$  are non-zero at a given point  $p \in M$ ,
- (iii)  $\sum_{i \in I} \eta_i = 1$ .

Partitions of unity exist if  $X$  is paracompact, and one of the reasons that topological manifolds were assumed to be second countable Hausdorff is because this implies they are paracompact.

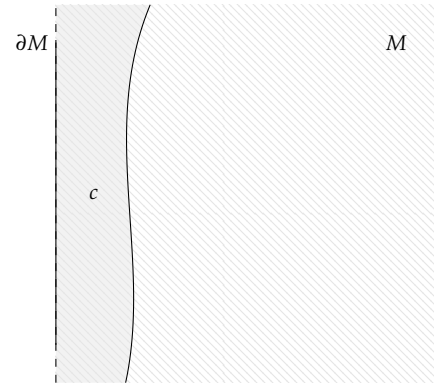

Figure 4.1: A collar of  $\partial M$ .

**Lemma 4.2.3.** *If  $\{U_i\}_{i \in I}$  is an open cover of a  $C^r$ -manifold  $M$ , then there exists a  $C^r$ -partition of unity subordinate to this open cover.*

*Proof.* If the  $U_i$  are contained in charts, this may be deduced by convolution as explained in Chapter 6.<sup>1</sup> The general case may be deduced from this; take a second open cover  $\{V_j\}_{j \in J}$  with each  $V_j$  contained in a chart. Then we take the open cover  $\{U_i \cap V_j\}_{i,j \in I \times J}$ , and construct a  $C^r$ -partition of unity  $\eta_{i,j}$ . Now take  $\eta_i = \sum_{j \in J} \eta_{i,j}$ , which is well-defined since only finitely many  $\eta_{i,j}$  are non-zero at each point.  $\square$

We will use partitions of unity to produce a vector field  $\mathcal{X}$  on  $M$  that points inwards at the boundary.

**Definition 4.2.4.** A vector field  $\mathcal{X}$  on  $M$  *points inwards* at  $p \in \partial M$  if all charts  $M \supset V \rightarrow W \subset \mathbb{R}^{m-1} \times [0, \infty)$  around  $p$ , we have that the  $m$ th component  $\mathcal{X}(p)_m$  in the expression  $\mathcal{X}(p) = \sum_{i=1}^m \mathcal{X}(p)_i \partial/\partial x_i$  is strictly positive. It is said to be *inwards pointing* if it is inwards pointing at all points of  $\partial M$ .

Note that the condition for a vector field to be inwards pointing at  $p$  is true in all charts around  $p$  if and only if it is true in one chart around  $p$ , and that this condition is convex, i.e. if  $\mathcal{X}$  and  $\mathcal{Y}$  are inwards pointing at  $p$ , then so is  $t \cdot \mathcal{X} + (1 - t) \cdot \mathcal{Y}$  for all  $t \in [0, 1]$ .

**Lemma 4.2.5.** *There exists an inwards-pointing vector field.*

*Proof.* We can clearly produce such an inwards-pointing vector field locally; just take  $\partial/\partial x_m$  in some chart and pull back the vector field (which you can do along a diffeomorphism).

To produce an inwards-pointing vector field on  $M$ , take a locally finite open cover  $\{V_i\}_{i \in I}$  by charts and a  $C^r$  partition of unity  $\{\eta_i\}_{i \in I}$  subordinate to this open cover. For each  $V_i$  take  $\mathcal{X}_i$  to be the pull back of  $\partial/\partial x_m$  as describe above. Then  $\sum_i \eta_i \mathcal{X}_i$  does the job, because the space of inwards pointing vector fields is convex.  $\square$

Now consider the following the ordinary differential equation on  $M$  given by

$$\frac{d}{dt} \gamma(t) = \mathcal{X}(\gamma(t)), \tag{4.2}$$

with initial condition  $\gamma(0) = p \in M$ . We claim that its solutions exist, are locally unique, and depend  $C^r$  on  $t$  and the initial condition  $p$  (note for  $p \in \partial M$ , we may only take  $t \geq 0$ ). To prove this, it suffices to prove this is in a chart around the initial condition  $p \in M$  — a transition function between two charts takes a solution to a solution, so this is well-defined — and in that case we can apply the Picard-Lindelöf theorem.

<sup>1</sup> This is the only case that we will use in this chapter.

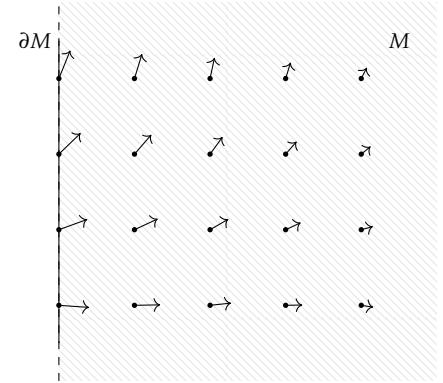

Figure 4.2: An inwards pointing vector field.

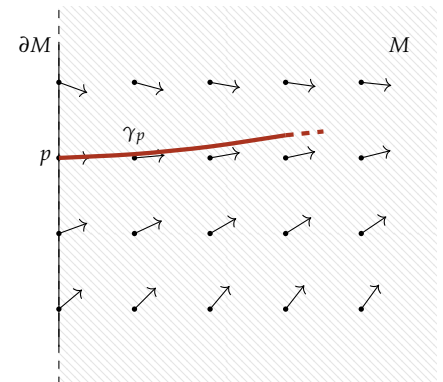

Figure 4.3: Flowing along an inwards pointing vector field.

**Definition 4.2.6.** There is an open neighborhood  $U$  of  $M \times \{0\}$  in  $M \times [0, \infty)$  and a  $C^r$ -map

$$\begin{aligned} \Phi_{\mathcal{X}}: U &\rightarrow M \\ (p, t) &\mapsto \gamma_p(t) \end{aligned}$$

where  $\gamma_p$  is the solution of (4.2) with initial condition  $\gamma(0) = p \in M$ . This is called the *(non-negative time) flow of  $\mathcal{X}$* .<sup>2</sup>

We shall use  $\Phi_{\mathcal{X}}$  to produce a collar using the inverse function theorem. The tangent space of  $M$  at  $q \in \partial M$  is a direct sum of  $T_q\partial M$  and a one-dimensional normal direction  $T_qM/T_q\partial M$ . With respect to this direct sum decomposition, the derivative of  $\Phi_{\mathcal{X}}$  at  $(q, 0) \in U \cap (\partial M \times [0, \infty))$  is given by  $\text{id}_{T_q\partial M}$  and the projection of  $\mathcal{X}$  to the normal direction. We arranged that the latter is positive in charts, so the differential is bijective and we conclude that  $\Psi := \Phi_{\mathcal{X}}|_{U \cap (\partial M \times [0, \infty))}: U \cap (\partial M \times [0, \infty)) \rightarrow M$  is a local diffeomorphism.

It might be not injective yet, but may be fixed by shrinking  $U$  using the following point-set lemma, see e.g. Corollary A.2.6 of [Wal16]. This requires the existence of a metric on  $M$ , which exists by Urysohn's theorem.

**Lemma 4.2.7.** *If  $Y$  is a metric space,  $f: Y \rightarrow Z$  is a continuous map such that  $f$  is a local embedding and for  $X \subset Y$  we have that  $f|_X$  is injective, then there is a neighborhood  $U$  of  $X$  in  $Y$  such that  $f|_U$  is an embedding.*

*Proof.* □

Since  $\Psi$  is the identity on  $\partial M \times \{0\}$ , we may thus shrink  $U$  so that  $\Psi$  is an embedding. By picking a  $C^r$ -function  $\epsilon: \partial M \rightarrow [0, \infty)$  such that  $(q, t\epsilon(q)) \in U$  for all  $t \in [0, 1]$ , we may finally produce our collar as

$$\begin{aligned} c: \partial M \times [0, 1] &\rightarrow M \\ (p, t) &\mapsto \Psi(p, t\epsilon(p)) \end{aligned}$$

and thus have proven the following theorem:

**Theorem 4.2.8.** *Collars exist.*

**Remark 4.2.9.** We did not prove the optimal result. If we already had a collar  $\tilde{c}$  near a closed subset  $C$  of  $\partial M$ , then we could have used the same technique to produce a collar  $c$  that coincides with  $\tilde{c}$  near  $C$ . This can be used to prove that the collars are unique up to isotopy (i.e. for every two collars  $c_1, c_2: \partial M \times [0, 1] \rightarrow M$  there exists a map  $[0, 1] \rightarrow \text{Emb}_{\partial M}(\partial M \times [0, 1], M)$  that begins at  $c_1$  and ends at  $c_2$ . More generally it may be used to prove that the space of collars is weakly contractible.

<sup>2</sup> We have only  $t \geq 0$  because we have a manifold with boundary and do not want to flow "out of  $M$ ."

### Gluing manifolds along their boundary

A first application of collars is to show that gluing manifolds along a diffeomorphism identifying their boundary is well-defined; that is, given  $C^r$ -manifolds  $N$  and  $M$  and a  $C^r$ -diffeomorphism  $\phi: \partial N \rightarrow \partial M$ , there is a  $C^r$  structure on  $N \cup_\phi M$  agreeing with the  $C^r$  structure on  $N$  and  $M$ . Because a  $C^r$ -structure may be defined locally, after picking collars it suffices to give a  $C^r$ -structure on  $\partial N \times (-1, 0] \cup_\phi \partial M \times [0, 1)$  agreeing with those on  $\partial N \times (-1, 0]$  and  $\partial M \times [0, 1)$ . Now note that we can use  $\text{id} \cup_\phi \phi$  to identify  $\partial N \times (-1, 0] \cup_\phi \partial M \times [0, 1)$  with  $\partial N \times (-1, 1)$  which clearly admits a  $C^r$ -structure. This  $C^r$ -structure obviously agrees with the one on  $\partial N \times (-1, 0]$ , and agrees with the one on  $\partial M \times [0, 1)$  since  $\phi$  was a  $C^r$ -diffeomorphism. The uniqueness of collars up to isotopy discussed above implies the  $C^r$ -structure is independent of the choice of collars.

### 4.3 The left horizontal arrows

We shall now prove that inclusion  $\text{Diff}_{\partial, U}^r(M) \hookrightarrow \text{Diff}_{\partial, D}^r(M)$  of (4.1) is a homotopy equivalence. This proof involves the gluing construction described at the end of the previous section, and a “sliding along a collar”-construction common in differential topology.

**Proposition 4.3.1.** *For all  $r \geq 1$ , the inclusion  $i: \text{Diff}_{\partial, U}^r(M) \rightarrow \text{Diff}_{\partial, D}^r(M)$  is a homotopy equivalence.*

*Proof.* Let  $c: \partial M \times [0, 1) \rightarrow M$  be a collar and  $\eta: (-1, 1) \rightarrow (-1, 1)$  a  $C^r$ -embedding that is the identity near 1 and maps  $[0, 1)$  to  $[1/2, 1)$ , e.g. Figure 4.4. Consider the manifold

$$\tilde{M} := (\partial M \times (-1, 0]) \cup_{\partial M} M,$$

which has an extended collar  $\tilde{c}: \partial M \times (-1, 1) \rightarrow M$ .

Recall that the boundary condition imposed on elements  $f$  of  $\text{Diff}_{\partial, D}^r(M)$  is that at  $\partial M$ ,  $f$  and its first  $r$  derivatives coincide with the  $\text{id}$  and its first  $r$  derivatives. Thus  $\text{Diff}_{\partial, D}^r(M)$  is homeomorphic to the subspace of  $\text{Diff}^r(\tilde{M})$  of diffeomorphisms that are the identity on  $\partial M \times (-1, 0]$ . Similarly  $\text{Diff}_{\partial, U}^r(M)$  is homeomorphic to the subspace of  $\text{Diff}^r(\tilde{M})$  of diffeomorphisms that are the identity on a neighborhood of  $\partial M \times (-1, 0]$ . It hence suffices to construct a homotopy equivalence between these two subspaces of  $\text{Diff}^r(\tilde{M})$ .<sup>3</sup>

The homotopy inverse  $r$  to  $i$  is given by “sliding along the collar.” That is, we define an embedding  $s_\eta: \tilde{M} \rightarrow \tilde{M}$  by

$$s_\eta(p) := \begin{cases} \tilde{c}(q, \eta(t)) & \text{if } p = \tilde{c}(q, t) \in \tilde{c}(\partial M \times (-1, 1)) \\ p & \text{otherwise} \end{cases}$$

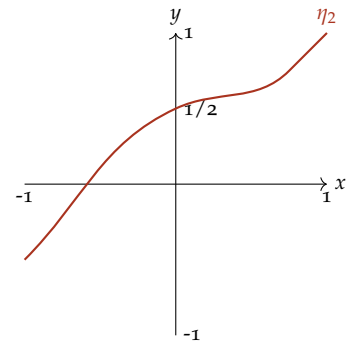

Figure 4.4: A  $C^r$ -embedding that is the identity near 1 and maps  $[0, 1)$  to  $[1/2, 1)$ .

<sup>3</sup> By convention, we use the (weak) Whitney topology, not the strong one. Since  $\tilde{M}$  is not compact, these do not coincide. However, they do coincide when restricted to the subspaces of  $\text{Diff}^r(\tilde{M})$  that play a role in our proof.

and map a diffeomorphism  $f$  of  $\tilde{M}$  coming from  $\text{Diff}_{\partial, D}^r(M)$  to the following diffeomorphism:

$$r(f)(p) := \begin{cases} s_\eta \circ f \circ s_\eta^{-1}(p) & \text{if } p \in s_\eta(\tilde{M}) \\ p & \text{otherwise.} \end{cases}$$

This may be described by saying we insert  $f$  in the image of  $s_\eta$  and extend by the identity. By construction it is the identity on the neighborhood  $\tilde{c}(\partial M \times (-1, 1/2))$  of  $\partial M$ .

To obtain homotopies  $i \circ r \sim \text{id}_{\text{Diff}_{\partial, D}^r(M)}$  and  $r \circ i \sim \text{id}_{\text{Diff}_{\partial, U}^r(M)}$ , we isotope  $\eta$  to the identity through embeddings that are the identity near 1 and map  $[0, 1)$  into  $[0, 1)$  by linear interpolation. We shall only do the case  $i \circ r$ . Let us denote for  $s \in [0, 1]$  an embedding  $s_{\eta, s}: \tilde{M} \rightarrow \tilde{M}$  by

$$s_{\eta, s}(p) := \begin{cases} \tilde{c}(q, (1-s)\eta(t) + st) & \text{if } p = \tilde{c}(q, t) \in \tilde{c}(\partial M \times (-1, 1)) \\ p & \text{otherwise.} \end{cases}$$

Then the homotopy  $\text{Diff}_{\partial, D}^r(M) \times [0, 1] \rightarrow \text{Diff}_{\partial, D}^r(M)$  from  $i \circ r$  to  $\text{id}$  is given by sending

$$(f, s) \mapsto \left( p \mapsto \begin{cases} s_{\eta, s} \circ f \circ s_{\eta, s}^{-1}(p) & \text{if } p \in s_\eta(\tilde{M}) \\ p & \text{otherwise.} \end{cases} \right). \quad \square$$

# 5

## The exponential map

In Proposition 4.3.1 we showed that in the commutative diagram below, the left horizontal maps are weak equivalences, and in this chapter we show that the right horizontal arrows are weak equivalences too. References for this chapter are again [Hir94, Wal16], but also [Mil63].

$$\begin{array}{ccccc}
 \text{Diff}_{\partial,U}^1(M) & \xrightarrow{\cong} & \text{Diff}_{\partial,D}^1(M) & \longrightarrow & \text{Diff}_{\partial}^1(M) \\
 \uparrow & & \uparrow & & \uparrow \\
 \text{Diff}_{\partial,U}^2(M) & \xrightarrow{\cong} & \text{Diff}_{\partial,D}^2(M) & \longrightarrow & \text{Diff}_{\partial}^2(M) \\
 \uparrow & & \uparrow & & \uparrow \\
 \cdots & \xrightarrow{\cong} & \cdots & \longrightarrow & \cdots \\
 \uparrow & & \uparrow & & \uparrow \\
 \text{Diff}_{\partial,U}^\infty(M) & \xrightarrow{\cong} & \text{Diff}_{\partial,D}^\infty(M) & \longrightarrow & \text{Diff}_{\partial}^\infty(M)
 \end{array}$$

### 5.1 The exponential map

In this section, we still allow non-compact  $M$ . For convenience, we shall start with the assumption that  $M$  has empty boundary and explain how to weaken this later.

The definition of the exponential map requires a Riemannian metric, which exists by an argument analogous to that proving the existence of an inwards-pointing vector field in Lemma 4.2.5:

**Lemma 5.1.1.**  $M$  admits a  $C^\infty$ -Riemannian metric,<sup>1</sup> unique up to homotopy.

*Proof.* We use that the space of Riemannian metrics is convex. This means that is contractible as soon as it is non-empty. A Riemannian metric exists because Riemannian metrics exist locally, i.e. on open subsets of  $\mathbb{R}^m$ , and using a smooth partition of unity we can combine these local Riemannian metrics to a Riemannian metric on  $M$ .  $\square$

Takeaways:

- Exponential maps exist by moving along geodesics with given initial position and velocity.
- Exponential maps are used to produce tubular neighborhoods.
- They may be also used together with collars to do a linear interpolation using geodesic segments or “bend straight” derivatives of a diffeomorphism at the boundary.

<sup>1</sup> A Riemannian metric may be given in a chart by a symmetric matrix  $g_{ij}$  of functions. It is  $C^\infty$  if each of these functions is  $C^\infty$ . If  $M$  was only  $C^r$ , it would only admit a  $C^r$ -Riemannian metric.

Let us fix a smooth Riemannian metric  $g$  on  $M$ . For a  $C^1$ -path  $\gamma: \mathbb{R} \supset [a, b] \rightarrow M$ , the derivative  $\gamma'(t)$  is an element of  $TM$  and we can evaluate  $g: TM \otimes TM \rightarrow \mathbb{R}$  on  $\gamma'(t) \otimes \gamma'(t)$  to get its squared length  $\|\gamma'(t)\|^2 \in \mathbb{R}_{\geq 0}$ , and its (non-negative) square root  $\|\gamma'(t)\|$ . We can then define the *length* and *energy* of  $\gamma$  as

$$\ell(\gamma) := \int_a^b \|\gamma'(t)\| dt, \quad E(\gamma) := (b-a) \int_a^b \|\gamma'(t)\|^2 dt.$$

By Cauchy-Schwarz we have that

$$\ell(\gamma)^2 = \left( \int_a^b \|\gamma'(t)\| dt \right)^2 \leq \left( \int_a^b dt \right) \left( \int_a^b \|\gamma'(t)\|^2 dt \right) = E(\gamma)$$

with equality if and only if  $\|\gamma'(t)\|$  is constant, i.e.  $\gamma$  is parametrized by arc-length up to rescaling.

**Definition 5.1.3.** A  $C^1$ -path  $\gamma: \mathbb{R} \supset [a, b] \rightarrow M$  is said to be a *geodesic*<sup>2</sup> if for all  $a' < b'$  in  $[a, b]$ , the restricted path  $\gamma|_{[a', b']}$  is a local minimum for the energy function<sup>3</sup> among  $C^1$ -paths with the end points  $\gamma(a')$  and  $\gamma(b')$ .

Variational calculus tells us that  $\gamma$  is a geodesic if and only if it satisfies the Euler-Lagrange equations for this variational problem. In this case, the *Lagrangian* is given by  $L := \|\cdot\|^2: TM \rightarrow \mathbb{R}$  and the *Euler-Lagrange equations* with respect to coordinates  $(x_i, v_i)$  on  $TM$  are given by

$$\frac{d}{dt} \frac{\partial L}{\partial v_r} - \frac{\partial L}{\partial x_r} = 0 \quad (5.1)$$

for all  $r$ . To deduce this, one may work in charts and evaluate  $L$  on a small perturbation  $\gamma + \epsilon\eta$  for  $\epsilon > 0$ . The derivative with respect to  $\epsilon$  must be zero at  $\epsilon = 0$ , and this gives (5.1).

Writing  $g_{ij}(x)$  for the Riemannian metric in local coordinates, we may write out these differential equations as

$$0 = 2 \frac{d}{dt} \left( \sum_i g_{ri} \gamma'_i \right) - \sum_{i,j} \frac{\partial g_{ij}}{\partial x_r} \gamma'_i \gamma'_j = \sum_i 2g_{ri} \gamma''_i + \sum_{i,j} 2 \frac{\partial g_{ri}}{\partial x_j} \gamma'_i \gamma'_j - \sum_{i,j} \frac{\partial g_{ij}}{\partial x_r} \gamma'_i \gamma'_j, \quad (5.2)$$

which is an equation expressing the second derivative of  $\gamma$  in terms of a quadratic function of the first derivatives.<sup>4</sup> We can rewrite this as a system of ordinary differential equations

$$\frac{dx_i}{dt} = v_i \quad \text{and} \quad \frac{dv_i}{dt} = -\Gamma_{jk}^i(x) v_j v_k, \quad (5.3)$$

where the *Christoffel symbols*  $\Gamma_{jk}^i$ , which are smooth maps  $T^*M \otimes T^*M \rightarrow T^*M$  obtained from (5.2) as

$$\Gamma_{ij}^s := \sum_r g^{sr} \frac{1}{2} \left( -\frac{\partial g_{ij}}{\partial x_r} + \frac{\partial g_{ri}}{\partial x_j} + \frac{\partial g_{jr}}{\partial x_i} \right),$$

**Example 5.1.2.** The geodesics on the 2-sphere with standard spherical metric are thus paths that locally coincide with great circles.

<sup>2</sup> A notion which of course depends on the choice of Riemannian metric  $g$ .

<sup>3</sup> Equivalently of the length function if  $\gamma$  is parametrized by arc-length.

<sup>4</sup> Ideally we would have written  $\gamma'_i$  with  $\gamma'_i$  with superscripts, in accordance to the convention that subscripts refer to sections of the cotangent bundle and superscripts to sections of the tangent bundle.

**Remark 5.1.4.** This is the same differential equation as the one that arises when defines a geodesic as a parallel path, in the sense that parallel transport along  $\gamma'$  preserves  $\gamma'$ . This shows that the length of  $\gamma'$  is constant, so that a geodesic can also be defined as a local minimum for  $\ell$  instead. Since the energy has a quadratic term, however, finding minimizers for the energy functional is a more robust problem than finding minimizers for the length functional, see Chapters 10–12 of [Mil63].



where  $g^{ri}$  denotes the inverse of the metric (that is, the dual metric  $T^*M \otimes T^*M \rightarrow \mathbb{R}$ ). Note that  $\Gamma_{ij}^s$  depends smoothly on  $x$ , as  $g$  does.

Applying existence and uniqueness of solutions to (5.3), we obtain the following:

**Lemma 5.1.6.** *For all  $p \in M$  there exists a neighborhood  $U \subset M$  of  $p$ , and an  $\epsilon > 0$ , such that for each  $q \in U$  and  $v \in T_qM$  with  $\|v\| < \epsilon$  there is a unique geodesic  $\gamma: (-2, 2) \rightarrow M$  satisfying  $\gamma(0) = q$  and  $\gamma'(0) = v$ .<sup>5</sup> The geodesic depends in a  $C^\infty$ -manner on  $q$  and  $v$ .*

**Definition 5.1.7.** There is an open neighborhood  $V$  of the 0-section in  $TM$ , such that there is a  $C^r$ -map

$$\Gamma: V \times (-2, 2) \rightarrow M$$

with the property that  $\Gamma|_{(q,v) \times (-2,2)}: (-2, 2) \rightarrow M$  is the geodesic through  $q$  with tangent vector  $v$ .

The exponential map  $\exp: V \rightarrow M$  is obtained from  $\Gamma$  by evaluating at time 1  $\in (-2, 2)$ . It is a  $C^\infty$ -map, and it is useful to know its derivative at a point  $(p, 0)$  in the 0-section. The tangent space  $T_{(q,0)}V$  canonically is a direct sum  $T_qM \oplus T_q(M)$  and by construction in local coordinates for small times (equivalently near the 0-section) we have that  $\gamma_i(t) = x_i + tv_i + \text{higher order terms}$ , so that the derivative is given by the addition map  $+: T_{(q,0)}V \cong T_qM \oplus T_qM \rightarrow T_qM$ .

### Non-empty boundary

If  $M$  has non-empty boundary, we construct an exponential map by picking a collar for  $\partial M$  and a Riemannian metric that is of the form  $g = g_\partial + dt^2$  on the collar with  $g_\partial$  a Riemannian metric on  $\partial M$ . The only difference is that  $\Gamma$  will not be defined for negative time at the boundary, unless  $v$  lies in  $T\partial M$ .

## 5.2 Tubular neighborhoods

We start by giving a classical application of the exponential map; the existence of tubular neighborhoods. This will be used in the next chapter. For convenience we shall again assume at first that  $M$  has empty boundary. We may identify the tangent bundle  $TM$  to a  $C^r$ -submanifold  $M \subset N$  with a sub-vector bundle of the tangent bundle  $TN$  restricted to  $M$ .

**Definition 5.2.1.** The normal bundle  $\nu_M$  is the quotient vector bundle  $TN|_M/TM$ . We let  $\pi_\nu: TN|_M \rightarrow \nu_M$  denote the projection.

This vector bundle has the property that its transition functions are  $C^r$ , which means its total space also has the structure of a  $C^r$ -manifold.

**Remark 5.1.5.** In fact, a stronger claim is true by our assumption that  $M$  is compact; geodesics are in fact defined for all of  $\mathbb{R}$  instead of just  $(-2, 2)$ .

<sup>5</sup> The choice of the number 2 here is of course arbitrary.

**Remark 5.1.8.** The exponential map should remind the reader of the exponential map for Lie groups. This is a map  $\exp: \mathfrak{g} \rightarrow G$ , in general only defined on a neighborhood of 0 in  $\mathfrak{g}$ . In this analogy, the space of  $C^\infty$  vector fields  $\Gamma^{C^\infty}(M, TM)$  is the ‘‘Lie algebra’’ for the group  $\text{Diff}^\infty(M)$ . This is a useful point of view, but suffers from the unfortunate defect that in contrast with the case of Lie group, the exponential map for diffeomorphisms is *not* locally surjective, see [Mil84].

**Definition 5.2.2.** A tubular neighborhood is an  $C^r$ -embedding  $\Phi: \nu_M \rightarrow N$  such that  $\Phi$  is the identity on the 0-section and the composition  $\pi \circ D\Phi: T\nu_M \cong TM \oplus \nu_M \rightarrow TN \rightarrow \nu_M$  is the identity on  $\nu_M$ .

**Theorem 5.2.3.** Every compact  $C^r$ -submanifold  $M \subset N$  with empty boundary has a  $C^r$  tubular neighborhood.

*Proof.* Given a Riemannian metric, we may identify  $\nu_M$  with the orthogonal complement to  $TM$  in  $TN|_M$ . We may then apply  $\exp$  to an  $\epsilon$ -disk bundle  $D_\epsilon \nu_M \subset \nu_M$  for  $\epsilon > 0$  small enough such that  $\exp$  is defined on  $D_\epsilon$  (this exists since  $M$  was assumed compact). By the above computation its derivative is

$$\begin{aligned} TM \oplus \nu_M &\rightarrow TN \\ (v, w) &\mapsto v + w, \end{aligned}$$

and hence is bijective of the desired form. By the inverse function theorem this is a local  $C^r$ -diffeomorphism, and since  $\exp$  is the identity on the 0-section, a point-set lemma implies that by decreasing  $\epsilon$  the map  $\exp: D_\epsilon \nu_M \rightarrow N$  is an embedding (this also uses that  $M$  is compact).

We may then identify  $D_\epsilon \nu_M$  with  $\nu_M$  by a fiberwise applying the map

$$v \mapsto \begin{cases} \eta(\|v\|)v/\|v\| & \text{if } v \neq 0, \\ 0 & \text{if } v = 0, \end{cases}$$

where  $\eta(-)$  is a strictly-increasing function that is the identity near 0 and has image  $[0, \epsilon)$ .  $\square$

**Remark 5.2.4.** This proof does not give a relative version of existence, but one can again prove uniqueness up to isotopy and in fact that the space of tubular neighborhoods is contractible.

### Non-empty boundary

If  $M$  has non-empty boundary, we should consider only embeddings  $\varphi: M \hookrightarrow N$  that are *neat* (see Figure 5.3).

**Definition 5.2.5.** An embedding  $\varphi: M \hookrightarrow N$  is neat if it satisfies the following two properties:

- $\varphi^{-1}(\partial N) = \partial M$ ,
- for each  $p \in \partial M$  there is a chart  $\psi: N \supset V \rightarrow W \subset \mathbb{R}^{n-1} \times [0, \infty)$  such that  $\psi^{-1}(\mathbb{R}^{n-1} \times [0, \infty)) = M \cap V$ .

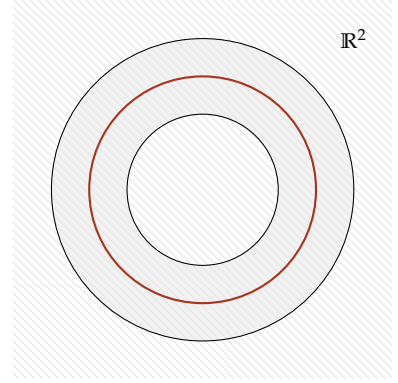

Figure 5.1: A tubular neighborhood for  $S^1 \subset \mathbb{R}^2$ .

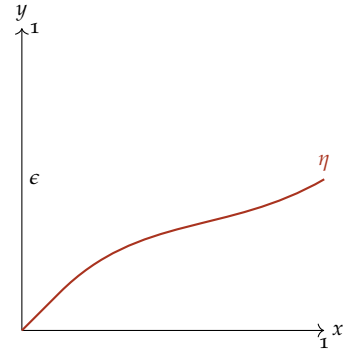

Figure 5.2: The function  $\eta$ .

Then we may pick a collar for  $N$  and Riemannian metric such that  $g = g|_{\partial N} + dt^2$  on the collar and  $TM|_{\partial M} = T\partial M \oplus \frac{\partial}{\partial t}$ , i.e.  $M$  leaves the boundary orthogonally. This is proven in Section 2.3 of [Wal16]. Then the argument above also gives a tubular neighborhood of  $M$ .

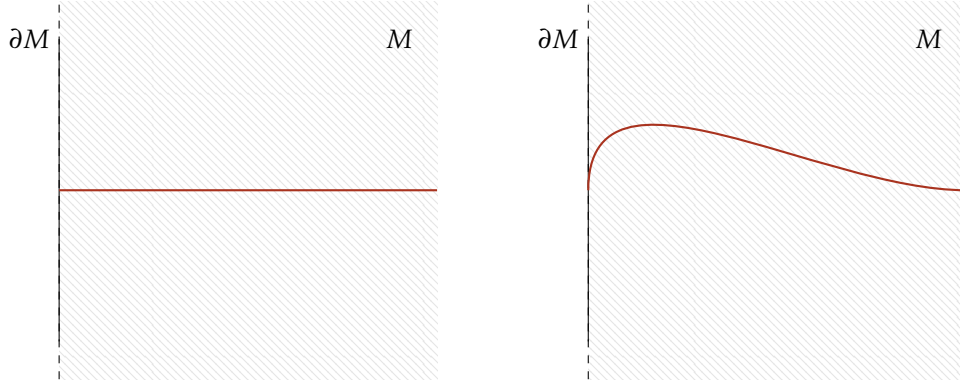

Figure 5.3: A neat submanifold (left) and a non-neat submanifold (right).

### 5.3 The right horizontal maps

We shall now show that the inclusion

$$\text{Diff}_{\partial, D}^r(M) \hookrightarrow \text{Diff}_{\partial}^r(M) \quad (5.4)$$

is a weak equivalence.

The main idea is to use geodesics to interpolate between  $f \in \text{Diff}_{\partial}^r(M)$  and  $\text{id}$  near  $\partial M$ . We shall restrict to compact  $M$  and shall show that

$$\text{Diff}_{\partial, U}^r(M) \hookrightarrow \text{Diff}_{\partial}^r(M)$$

is a weak equivalence.

We begin by noting that for each diffeomorphism  $f \in \text{Diff}_{\partial}^r(M)$ , there exists a  $\epsilon > 0$  such that  $f(\partial M \times [0, \epsilon]) \subset \partial M \times [0, 1]$ . By further decreasing  $\epsilon$ , we may arrange that for all  $q \in \partial M$  and  $t \in [0, \epsilon]$ , there is a unique geodesic segment from  $q$  to  $\pi_{\partial M}(f(q, t)) \in \partial M$ . This depends in  $C^\infty$ -manner on  $q$  and  $\pi_{\partial M}(f(q, t))$ , though of course  $\pi_{\partial M}(f(q, t))$  only depends in a  $C^r$ -manner on  $(q, t)$ .

Let  $\omega: [0, 1) \rightarrow [0, 1]$  be a smooth function that is 0 near 0, and 1 near 1. Letting  $\gamma(f, q, t): [0, 1] \rightarrow \partial M$  denote the unique geodesic segment from  $q$  to  $\pi_{\partial M}(f(q, t))$  in  $\partial M$  (if it exists, which by assumption it does if  $t \leq \epsilon$ ). Then we may write down the following smooth map  $M \rightarrow M$ :

$$\tilde{f}_\omega(p) := \begin{cases} \left( \gamma(f, q, t)\left(\omega\left(\frac{t}{\epsilon}\right)\right), (1 - \omega\left(\frac{t}{\epsilon}\right))t + \omega\left(\frac{t}{\epsilon}\right)\pi_{[0,1]}(f(q, t)) \right) & \text{if } p = (q, t) \in \partial M \times [0, \epsilon], \\ f(p) & \text{otherwise,} \end{cases}$$

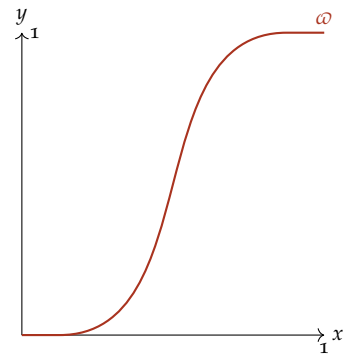

Figure 5.4: The function  $\omega$ .

where the first expression gives a point in  $\partial M \times [0, \epsilon]$ .

If  $\epsilon$  is small enough, this is a diffeomorphism. By construction, it is the identity on a neighborhood of  $\partial M$ . If  $\epsilon$  is small enough, by interpolating between  $\omega$  and the smooth function  $[0, 1] \rightarrow [0, 1]$  that is constant equal to 1, we obtain an isotopy  $\tilde{f}_{(1-\tau)+\tau\cdot\omega}$  between  $\tilde{f}_\omega$  and  $f$ . To justify these arguments about small enough  $\epsilon$ , one can use the result that embeddings are open when the domain is compact, Theorem 2.1.4 of [Hir94].

**Theorem 5.3.1.** *The map  $\text{Diff}_{\partial, U}^r(M) \hookrightarrow \text{Diff}_\partial^r(M)$  is a weak equivalence.*

*Proof.* Suppose we are given a commutative diagram

$$\begin{array}{ccc} S^i & \xrightarrow{h} & \text{Diff}_{\partial, U}^r(M) \\ \downarrow & & \downarrow \\ D^{i+1} & \xrightarrow{H} & \text{Diff}_\partial^r(M) \end{array}$$

then we need to provide a homotopy through commutative diagrams to one where there is a lift.

Let  $\epsilon(f) > 0$  satisfy all the conditions used above; (i)  $f(\partial M \times [0, \epsilon]) \subset \partial M \times [0, 1]$ , (ii) there is a unique geodesic segment from  $q$  to  $\pi_{\partial M}(f(q, t))$  for all  $q \in \partial M$  and  $t \in [0, \epsilon]$ , (iii) for all  $\tau \in [0, 1]$ , the map  $\tilde{f}_{(1-\tau)+\tau\cdot\omega}$  is a diffeomorphism. This depends in a continuous manner on  $f$ , and since  $D^{i+1}$  is compact, there is a single  $\epsilon_0 > 0$  which works for all  $H_s$  for  $s \in D^{i+1}$ . Then the desired homotopy is given by

$$[0, 1] \ni \tau \mapsto \widetilde{(H_s)}_{(1-\tau)+\tau\cdot\omega}.$$

It is clear from the construction that this preserves the property that a diffeomorphism lies in  $\text{Diff}_{\partial, U}^\infty(M)$ , and that for  $\tau = 1$  we land in  $\text{Diff}_{\partial, U}^r(M)$ .  $\square$

### *Application to the topology of diffeomorphism groups*

We can use the techniques of the previous proof to prove that the  $\text{Diff}_{\partial, U}^r(M)$  is locally contractible for compact  $M$ , where we shall assume for convenience that  $M$  has empty boundary.

**Proposition 5.3.2.** *If  $M$  is compact with empty boundary, then  $\text{Diff}^r(M)$  is locally contractible.*

*Proof.* It suffices to prove that there exists a neighborhood  $U$  of  $\text{id}_M$  which deformation retracts onto  $\text{id}_M$ . Fix a Riemannian metric, then there exists an  $\epsilon > 0$  such that for all  $v \in TM$  with  $\|v\| \leq \epsilon$ , there is a unique geodesic from  $\pi(v)$  to  $\exp(v)$ , where  $\pi: TM \rightarrow M$  denotes the projection.

Let us take the open subset of  $C^\infty(M, M)$  consisting of those diffeomorphisms whose graph lies in the open subset of  $M \times M$  consisting of  $(v, \exp(v))$  for  $\|v\| < \epsilon$ . For each such diffeomorphism  $f$  we may write down a canonical geodesic interpolation  $f_t$  from  $f_0 = f$  to  $f_1 = \text{id}_M$ . For each  $t \in [0, 1]$  this is a smooth function depending continuously on  $f$ . Since diffeomorphisms are open in the smooth functions, by shrinking  $U$ , we may assume that all of these paths consist of diffeomorphisms.  $\square$

*The case  $r = 1$*

Let us also show that in the case  $r = 1$  the map (5.4) is a homotopy equivalence without requiring  $M$  to be compact. I believe this proof may be modified for  $r > 1$ , but the details are involved.

Understanding the map (5.4) amounts to understanding the difference between  $\text{Diff}_\partial^1(M)$  and  $\text{Diff}_{\partial, D}^1(M)$ . Pick a  $C^\infty$ -collar  $c: \partial M \times [0, 1] \hookrightarrow M$ , and identify the image of  $c$  with  $\partial M \times [0, 1]$  to reduce the amount of notation. For  $p = (q, t) \in \partial M \times [0, 1]$ , the tangent space  $T_p M$  decomposes as  $T_q \partial M \oplus \epsilon$ , with  $\epsilon$  the trivial sub-bundle spanned by  $\frac{\partial}{\partial t}$ . Since both  $\text{Diff}_\partial^1(M)$  and  $\text{Diff}_{\partial, D}^1(M)$  fix pointwise the boundary  $\partial M$ , the  $T_q \partial M$ -component of their derivatives equals the identity in both cases. For  $\text{Diff}_{\partial, D}^1(M)$  the derivative is also the identity on  $\epsilon$ , but for  $\text{Diff}_\partial^1(M)$  this may not be the case.

The difference is thus that the derivative at  $p = (q, 0)$  of  $f \in \text{Diff}_{\partial, D}^1(M)$  may be described by a matrix of the form

$$D_p f = \begin{bmatrix} \text{id}_{T_q \partial M} & 0 \\ 0 & \text{id}_\epsilon \end{bmatrix}$$

while the derivative of  $g \in \text{Diff}_\partial^1(M)$  may be described by a matrix of the form

$$D_p g = \begin{bmatrix} \text{id}_{T_q \partial M} & \mathcal{X}(g)(q) \\ 0 & \lambda(g)(q) \cdot \text{id}_\epsilon \end{bmatrix}. \quad (5.5)$$

with  $\lambda(g): \partial M \rightarrow (0, \infty)$  a  $C^1$ -function and  $\mathcal{X}(g)$  a  $C^1$ -vector field on  $\partial M$  (which is the same as a fiberwise linear map  $\epsilon \rightarrow T\partial M$ ).

**Theorem 5.3.3.** *The map  $i: \text{Diff}_{\partial, D}^1(M) \hookrightarrow \text{Diff}_\partial^1(M)$  is a homotopy equivalence.*

*Proof.* We continue the notation used above. We shall deform a  $C^1$ -diffeomorphism  $g \in \text{Diff}_\partial^1(M)$  into  $\text{Diff}_{\partial, D}^1(M)$  in two steps. Firstly, we shall do a scaling in the collar direction to make  $\lambda$  equal to 1. Secondly, we will use  $\Gamma$  to make  $\mathcal{X}$  equal to 0.

*Step 1 – rescaling  $\lambda$*  Recall that  $\lambda(g)$  denotes the  $C^r$ -function  $\lambda: \partial M \rightarrow (0, \infty)$  appearing in (5.5). This depends continuously on  $g$ . The

idea is that by scaling the collar in the  $[0, 1)$ -direction, we can scale  $\lambda(g)$  by a positive function.

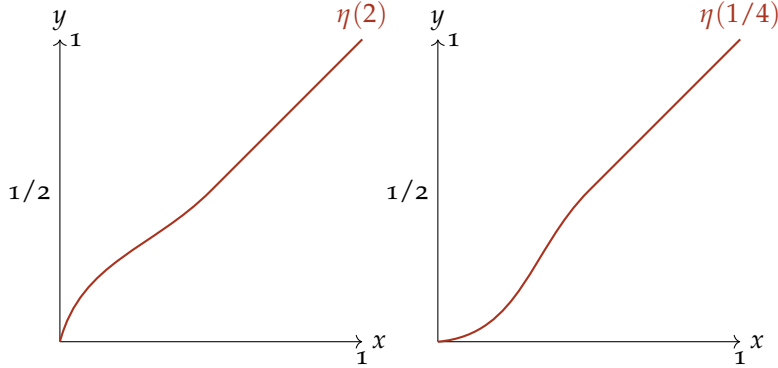

Pick a map  $\eta: (0, \infty) \rightarrow C^\infty([0, 1), [0, 1))$  such that the adjoint  $(0, \infty) \times [0, 1) \rightarrow [0, 1)$  is smooth,  $\eta(l)$  is a  $C^r$ -diffeomorphism that maps 0 to 0, is the identity on  $[1/2, 1)$  and has derivative  $1/l$  at 0 and so that  $\eta(1)$  is the identity. Using this we can define a continuous map  $\bar{\eta}: C^1(\partial M, (0, \infty)) \rightarrow \text{Diff}_\partial^1(M)$  by sending  $\lambda$  to the diffeomorphism given by

$$\bar{\eta}(\lambda)(p) := \begin{cases} (q, \eta(\lambda(q))(t)) & \text{if } p = c(q, t) \\ p & \text{otherwise} \end{cases}$$

Consider the composition

$$\bar{\eta}(\lambda(g)) \circ g,$$

which is a new  $C^1$ -diffeomorphism of  $M$ , whose derivative at  $(q, 0) \in \partial M$  given by the composition

$$\begin{bmatrix} \text{id}_{T_q \partial M} & \mathcal{Y}(q) \\ 0 & 1/\lambda(q) \text{id}_\epsilon \end{bmatrix} \begin{bmatrix} \text{id}_{T_q \partial M} & \mathcal{X}(q) \\ 0 & \lambda(q) \text{id}_\epsilon \end{bmatrix} = \begin{bmatrix} \text{id}_{T_q \partial M} & \mathcal{Y}(q) + \mathcal{X}(q) \\ 0 & \text{id}_\epsilon \end{bmatrix},$$

where  $\mathcal{Y}(q)$  involves the derivatives of  $\lambda(g)$  with respect to  $q$ . Thus the composition  $\bar{\eta}(\lambda(g)) \circ g$  has function  $\lambda = 1$ . We may interpolate from  $g$  to this diffeomorphism by taking the isotopy

$$[0, 1] \ni \tau \mapsto \bar{\eta}(1 - \tau + \tau \lambda(g)) \circ g.$$

This gives a homotopy  $H^{(1)}: \text{Diff}_\partial^r(M) \times [0, 1] \rightarrow \text{Diff}_\partial^1(M)$  whose values on the subspace  $\text{Diff}_\partial^1(M) \times \{1\}$  lie in the subspace  $\text{Diff}_{\partial, \lambda=1}^1(M)$  where  $\lambda = 1$ . Since  $\eta(1) = \text{id}$ , this homotopy is the identity on  $\text{Diff}_{\partial, D}^1(M)$ . We denote the end result at  $\tau = 1$  by  $H_1^{(1)}(g)$ .

*Step 2 – subtracting  $\mathcal{X}$*  Now that we have made  $\lambda$  equal to 1, it remains to make  $\mathcal{X}$  equal to 0. We will use  $\Gamma$  to do this.

The idea is that given a vector field  $\mathcal{X}$  on  $\partial M$ , the diffeomorphism of  $\partial M \times [0, 1]$  given by  $(q, t) \mapsto (\Gamma(q, -\mathcal{X}(v), t), t)$  has derivative at  $(q, 0)$  given by

$$\begin{bmatrix} \text{id}_{T_q \partial M} & -\mathcal{X}(q) \\ 0 & \text{id}_\epsilon \end{bmatrix}$$

and thus can cancel  $\mathcal{X}(q)$ . Suitably interpolating to the identity near  $\partial M \times \{1\}$ , we can extend this diffeomorphism  $M$ , and then compose it with  $H_s$  to kill  $\mathcal{X}(H_s)$ .

This interpolation is accomplished by picking a  $C^1$ -function  $\rho: [0, \infty) \rightarrow [0, 1)$  that has derivative 1 near 0, that is 0 on  $[1/2, \infty)$ . Another concern is that we can only follow the geodesic  $\mathcal{X}(q)$  for a small time depending on  $\mathcal{X}(q)$ . Thus we also need to pick a  $C^r$ -function  $\sigma: T\partial M \rightarrow (0, 1)$  such that  $\Gamma(q, v, t)$  is defined for  $|t| \leq \sigma(q, v)$ . We then define

$$\rho_\sigma(q, v, t) := \sigma(q, v) \rho(t/\sigma(q, v)).$$

which has the effect of modifying  $\rho$  so that its values never exceed  $\sigma(q, v)$ , while keeping its derivative 1 at 0.

Let  $\Gamma^{C^1}(\partial M, T\partial M) \subset \Gamma(M, T\partial M)$  denote the subspace of  $C^1$  vector fields in the Whitney topology. We can define a continuous map  $G: \Gamma^{C^1}(\partial M, T\partial M) \rightarrow \text{Diff}_0^1(M)$  by sending  $\mathcal{X}$  to the diffeomorphism given by

$$G(\mathcal{X})(p) := \begin{cases} (\Gamma[q, -\mathcal{X}(q), \rho_\sigma(q, -\mathcal{X}(q), t)], t) & \text{if } p = c(q, t) \\ p & \text{otherwise} \end{cases}$$

For  $g \in \text{Diff}_{\partial, \lambda=1}^1(M)$ , recall that  $\mathcal{X}(g)$  denotes the  $C^r$ -vector field  $\mathcal{X}$  appearing in (5.5), and consider the composition

$$G(\mathcal{X}(g)) \circ g,$$

which is a new  $C^1$ -diffeomorphism of  $M$ . Its derivative at  $(q, 0) \in \partial M$  is now given by the composition

$$\begin{bmatrix} \text{id}_{T_q \partial M} & -\mathcal{X}(q) \\ 0 & \text{id}_\epsilon \end{bmatrix} \begin{bmatrix} \text{id}_{T_q \partial M} & \mathcal{X}(q) \\ 0 & \text{id}_\epsilon \end{bmatrix} = \begin{bmatrix} \text{id}_{T_q \partial M} & -\mathcal{X}(q) + \mathcal{X}(q) \\ 0 & \text{id}_\epsilon \end{bmatrix},$$

which is the identity. We may interpolate from  $g$  to this diffeomorphism by taking the isotopy

$$[0, 1] \ni \tau \mapsto G(\tau \cdot \mathcal{X}(g)) \circ g.$$

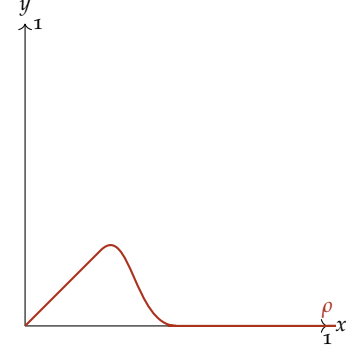

Figure 5.5: The function  $\rho$ .

This gives a homotopy  $H^{(2)}: \text{Diff}_{\partial, \lambda=1}^1(M) \times [0, 1] \rightarrow \text{Diff}_{\partial, \lambda=1}^1(M)$  whose values on the subspace  $\text{Diff}_{\partial, \lambda=1}^r(M) \times \{1\}$  lie in  $\text{Diff}_{\partial, D}^1(M)$ . Since  $G(0) = \text{id}$ , this is the identity on  $\text{Diff}_{\partial, D}^1(M)$ . We denote the end result at  $\tau = 1$  by  $H_1^{(2)}(g)$ .

Thus the homotopy inverse is given by  $r: g \mapsto H_1^{(2)}(H_1^{(1)}(g))$ , and the homotopies provided in steps 1 and 2 above give homotopies from  $i \circ r$  and  $r \circ i$  to the identity.  $\square$



# 6

## Convolution

In the previous two chapters we showed that in the commutative diagram below all horizontal maps are weak equivalences, and now we show that the middle vertical arrows are weak equivalences. The results of this chapter are also discussed in [Hir94], in Section 2.2.

$$\begin{array}{ccccc}
 \text{Diff}_{\partial,U}^1(M) & \xrightarrow{\simeq} & \text{Diff}_{\partial,D}^1(M) & \xrightarrow{\simeq} & \text{Diff}_{\partial}^1(M) \\
 \uparrow & & \uparrow & & \uparrow \\
 \text{Diff}_{\partial,U}^2(M) & \xrightarrow{\simeq} & \text{Diff}_{\partial,D}^2(M) & \xrightarrow{\simeq} & \text{Diff}_{\partial}^2(M) \\
 \uparrow & & \uparrow & & \uparrow \\
 \cdots & \xrightarrow{\simeq} & \cdots & \xrightarrow{\simeq} & \cdots \\
 \uparrow & & \uparrow & & \uparrow \\
 \text{Diff}_{\partial,U}^\infty(M) & \xrightarrow{\simeq} & \text{Diff}_{\partial,D}^\infty(M) & \xrightarrow{\simeq} & \text{Diff}_{\partial}^\infty(M)
 \end{array}$$

### 6.1 Weak Whitney embedding theorem

We shall use a technique to increase the smoothness of functions by convolving them with bump functions, essentially averaging them locally with the goal of making them smoother. This averaging procedure requires a notion of translation, and it is enough that this translation exists locally. We construct it by giving an embedding of  $M$  into an open neighborhood of Euclidean space and using the globally defined translation on  $\mathbb{R}^N$ . To do so we must show that we can embed  $M$  into Euclidean space.

**Theorem 6.1.1.** *Every compact  $C^r$ -manifold  $M$  with empty boundary admits a  $C^r$ -embedding  $\varphi$  into some Euclidean space  $\mathbb{R}^N$ .*

*Proof.* Let  $\{V_i\}_{i=1}^k$  be a finite cover by charts  $\phi_i: M \supset V_i \rightarrow W_i \subset \mathbb{R}^m$ , which exists by compactness. Let  $\{\eta_i\}_{i=1}^k$  be a  $C^r$  partition of unity

Takeaways:

- Every compact manifold can be embedded in a Euclidean space.
- Convolution with a bump function makes functions smoother, and can be applied to maps between manifolds using embeddings and tubular neighborhoods.
- The differentiability of diffeomorphisms does not affect the homotopy type of the diffeomorphism group, because the condition of being a diffeomorphism only involves conditions on the underlying continuous function and the first differential.
- Convolution can be used to produce a weakly equivalent simplicial group of diffeomorphisms, without reference to the Whitney topology.

subordinate to this finite cover. Let us define the functions

$$\begin{aligned} \bar{\phi}_i: M \supset V_i &\rightarrow \mathbb{R}^{m+1} \\ x &\mapsto \begin{cases} (\eta_i(x), \eta_i(x)\phi_i(x)) & \text{if } x \in \text{supp}(\eta_i) \subset V_i, \\ 0 & \text{otherwise,} \end{cases} \end{aligned}$$

which are well-defined  $C^r$  functions. Then we define a  $C^r$ -map

$$\begin{aligned} \varphi: M &\rightarrow \mathbb{R}^{k(m+1)}, \\ x &\mapsto (\bar{\phi}_1(x), \dots, \bar{\phi}_k(x)). \end{aligned}$$

This map is injective, because if  $\varphi(x) = \varphi(y)$ , then this means that  $\eta_i(x) = \eta_i(y) \neq 0$  for some  $i$ , so both lie in the same  $V_i$ , and then we can recover  $x$  and  $y$  from the  $\eta_i(x)\phi_i(-)$  part  $\bar{\phi}_i$  by dividing by  $\eta_i(x) = \eta_i(y)$ . The image  $\varphi$  is a compact Hausdorff space, so  $\varphi$  is in fact a homeomorphism.

To check it is a  $C^r$ -embedding it thus suffices to check that the differential is injective. Suppose that  $\eta_i(x) \neq 0$ . Then it suffices to prove that the differential of  $\bar{\phi}_i$  is injective at  $x$ . Let us compose  $\bar{\phi}_i$  with the  $C^r$ -diffeomorphism  $\rho: (0, \infty) \times \mathbb{R}^m \rightarrow (0, \infty) \times \mathbb{R}^m$  that sends  $(x_0, \dots, x_m)$  to  $(x_0, \frac{1}{x_0}x_1, \dots, \frac{1}{x_0}x_m)$ . Then  $\rho \circ \bar{\phi}_i$  has injective differential at  $x$  if and only if  $\bar{\phi}_i$  has. But  $\rho \circ \bar{\phi}_i$  is given by  $x \mapsto (\eta_i(x), \phi_i(x))$ , and hence its differential is injective between  $\phi_i$  was a chart.  $\square$

A similar proof gives a relative version: given a compact  $C^r$ -manifold  $M$ , a closed subset  $D \subset M$  containing  $\partial M$  and an open subset  $U \subset M$  with an  $C^r$ -embedding  $\varphi_0: U \rightarrow \mathbb{R}^N$ , there exists a  $C^r$ -embedding  $\varphi: M \rightarrow \mathbb{R}^{N+N'}$  that near  $D$  coincides with  $\varphi_0: U \rightarrow \mathbb{R}^N \hookrightarrow \mathbb{R}^{N+N'}$ . This implies uniqueness up to isotopy after possibly increasing  $N$ . The same technique may be used to show that  $\text{Emb}(M, \mathbb{R}^\infty) := \text{colim}_{N \rightarrow \infty} \text{Emb}(M, \mathbb{R}^N)$  is weakly contractible.

### Non-empty boundary

Recall that we prefer our embeddings  $\varphi: M \hookrightarrow N$  of manifolds with boundary to be neat, cf. Definition 5.2.5: (i)  $\varphi^{-1}(\partial N) = \partial M$ , and (ii) for each  $p \in \partial M$  there is a chart  $\psi: N \supset V \rightarrow W \subset \mathbb{R}^{n-1} \times [0, \infty)$  such that  $\psi^{-1}(\mathbb{R}^{m-1} \times [0, \infty)) = M \cap V$ .

The relative existence and the existence of collars can be used to construct neat embeddings of manifolds with boundary. To do so, we will need a small addendum to relative version stated before; if the last coordinate of  $\varphi_0$  is larger than  $R$  on  $M \setminus U$ , then we can find  $\varphi$  such that the last coordinate of  $\varphi$  is larger than  $R - \epsilon$  for any  $\epsilon > 0$ .

**Proposition 6.1.3.** *Every compact  $C^r$ -manifold  $M$  with boundary admits a neat  $C^r$ -embedding  $\phi$  into  $\mathbb{R}^{N-1} \times [0, \infty)$ .*

**Remark 6.1.2.** There are stronger versions of the Whitney embedding theorem. Transversality will get you to  $\mathbb{R}^{2m+1}$ , see Proposition 12.1.7. Using the Whitney trick, one can improve this to  $\mathbb{R}^{2m}$ , see Theorem 18.1.4. Using this, one prove the existence of proper embeddings of a non-compact manifold into  $\mathbb{R}^{2m}$ . A relative version will prove that  $\text{Emb}(M, \mathbb{R}^N)$  is high-connected, see Lemma 34.1.1.

*Proof.* Pick an  $C^r$ -embedding  $\varphi_\partial$  of  $\partial M$  into  $\mathbb{R}^{N'}$ . Then using a collar  $c: \partial M \times [0, 1) \hookrightarrow M$ , we can extend this to an embedding of the image of the collar into  $\mathbb{R}^{N'} \times [0, \infty)$  by simply taking  $\varphi_0(q, t) = (\varphi_\partial(q), t)$  if  $x = c(q, t)$ . By applying the previous proposition with addendum we can extend this without modifying the embedding near  $\partial M$  nor intersecting the hyperplane with last coordinate equal to 0, i.e. staying inside  $\mathbb{R}^{N'} \times [0, \infty)$ .  $\square$

## 6.2 Approximation by smooth functions

We first discuss this smoothing on functions on Euclidean spaces. We then generalize this to manifolds using the Whitney embedding theorem and tubular neighborhoods.

### Approximation on Euclidean spaces

The main tool for smoothing is convolution, see Chapter I of [DK10].

**Definition 6.2.1.** The *convolution*  $f * g: \mathbb{R}^n \rightarrow \mathbb{R}^n$  of a compactly supported continuous function  $f: \mathbb{R}^n \rightarrow \mathbb{R}$  with a continuous function  $g: \mathbb{R}^n \rightarrow \mathbb{R}^m$  is given by

$$(f * g)(x) := \int_{y \in \mathbb{R}^n} f(x - y)g(y) = \int_{y \in \mathbb{R}^n} f(y)g(x - y).$$

By differentiation under the integral sign, this inherits the smoothness of  $f$ . Thus to obtain smooth approximations, one lets  $\eta: \mathbb{R}^n \rightarrow [0, \infty)$  be a  $C^\infty$ -function with support in  $D^n$  such that  $\int_{\mathbb{R}^n} \eta = 1$ , see e.g. Figure 6.1. Then  $\eta_\epsilon$  defined by  $x \mapsto \frac{1}{\epsilon^n} \eta(x/\epsilon)$  has support in  $D_\epsilon^n(0) := \{x \in \mathbb{R}^n \mid \|x\| \leq \epsilon\}$  and integral 1. Even if  $g$  is  $C^r$ , we still have that  $\eta_\epsilon * g$  is  $C^\infty$  for  $\epsilon > 0$ , and one checks that as  $\epsilon \rightarrow 0$ ,  $\eta_\epsilon * g \rightarrow g$  in the weak  $C^r$ -topology.

### An application of smoothing functions

We thus have a general technique to approximate  $C^r$ -functions by  $C^\infty$ -functions. As an illustrative example we prove the following.

**Theorem 6.2.2.** *Every compact  $C^r$ -manifold  $M$  with empty boundary and stably trivial normal bundle admits a  $C^\infty$ -structure.*

Here the normal bundle is *stably trivial* if for some embedding  $\phi: M \hookrightarrow \mathbb{R}^{N'}$  the normal bundle is trivial, i.e. isomorphic to the trivial bundle  $M \times \mathbb{R}^{N'-m}$ . By the uniqueness of embeddings up to isotopy upon increasing  $N$ , which we will prove later, we see that eventually  $\phi$  is unique up to isotopy, and this notion is well-defined.

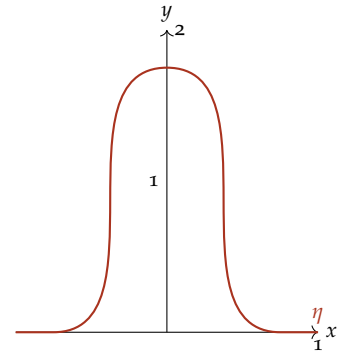

Figure 6.1: An example of a bump function  $\eta$  on  $\mathbb{R}$ . One may give a formula by combining appropriately two copies of the function given by 0 if  $x \leq 0$  and  $\exp(-1/x)$  if  $x > 0$ . On  $\mathbb{R}^n$  one may take  $\prod_{i=1}^n \eta \circ \pi_i$ , with  $\pi_i: \mathbb{R}^n \rightarrow \mathbb{R}$  the projection.

*Proof.* Let  $\varphi: M \rightarrow \mathbb{R}^N$  be a  $C^r$ -embedding into  $\mathbb{R}^N$ , and  $\Phi: M \times \mathbb{R}^{N-m} \rightarrow \mathbb{R}^N$  be a tubular neighborhood. Here we have used that the normal bundle is stably trivial. Then  $M$  is a collection of components of the inverse image of 0 under the  $C^r$ -map  $\tilde{\pi}: \mathbb{R}^N \rightarrow \mathbb{R}^{N-m}$  given by projection to  $M$  on  $\Phi(M \times D^{N-m})$  and extended by some smooth map elsewhere. Now approximate  $\tilde{\pi}$  by a smooth map by convolving it with  $\eta_\epsilon$ . Since 0 was a regular value on  $\Phi(M \times D^{N-m})$  and  $\eta_\epsilon * \tilde{\pi} \rightarrow \tilde{\pi}$  as  $\epsilon \rightarrow 0$  in the weak  $C^r$ -topology, the same is still true for  $\eta_\epsilon * \tilde{\pi}$  for  $\epsilon$  small enough. Thus the components of  $(\eta_\epsilon * \tilde{\pi})$  near  $M$  form a  $C^\infty$ -submanifold  $\tilde{M}$ . Consider the map  $p: \Phi(M \times D^{N-m}) \rightarrow M$  given by projecting away the  $D^{N-m}$  factor, then  $p|_M$  is the identity and thus has injective differential, and thus  $p|_{\tilde{M}}$  also has injective differential for  $\epsilon$  small enough. We conclude that  $p|_{\tilde{M}}: \tilde{M} \rightarrow M$  is a  $C^r$ -diffeomorphism from a smooth manifold to  $M$ .  $\square$

With more effort we could have proven a “strongly relative version” of this theorem, which allows one to extend a given smooth structure to a larger part of the  $C^r$ -manifold, by noting the above construction works locally because every normal bundle is locally trivial. Using this one may prove that any  $C^r$ -manifold with empty boundary admits a  $C^\infty$ -structure (Theorem 2.2.9 of [Hir94]). Using collars one may prove the same for  $C^r$ -manifolds with boundary. The arguments given later will show that any  $C^r$ -diffeomorphism between smooth manifolds is  $C^r$ -isotopic to a smooth diffeomorphism, implying that the smooth structure is unique up to isotopy.

### *Approximation on manifolds*

We next explain how to extend convolution to manifolds. Suppose we have two compact  $C^\infty$ -manifolds  $M$  and  $N$ , for the moment with empty boundary. Take  $C^\infty$ -embeddings  $\varphi_M: M \rightarrow \mathbb{R}^{N_M}$ ,  $\varphi_N: N \rightarrow \mathbb{R}^{N_N}$ , and tubular neighborhoods  $\Phi_M: \nu_M \hookrightarrow \mathbb{R}^{N_M}$ ,  $\Phi_N: \nu_N \hookrightarrow \mathbb{R}^{N_N}$ . Denote the images of the tubular neighborhoods by  $U(M)$  and  $U(N)$ , and let  $\pi_M: U(M) \rightarrow M$  and  $\pi_N: U(N) \rightarrow N$  denote the projections onto the 0-section.

There exists an  $\epsilon > 0$  such that for any  $p, p' \in M$  satisfying  $\|p - p'\| < \epsilon$  (with respect to the Euclidean metric on  $\mathbb{R}^{N_M}$ ), the line segment  $[0, 1] \ni t \mapsto t \cdot p + (1 - t) \cdot p'$  lies in  $U(M)$ . Similarly, given a continuous map  $f: M \rightarrow N$  there exists an  $\epsilon(f) > 0$ , such that the convex hull in  $\mathbb{R}^{N_N}$  of the set  $f(\pi_M(B_{\epsilon(f)}(p)))$  is contained in  $U(N)$  for all  $p \in M$ .

For a continuous map  $f: M \rightarrow N$ , the expression

$$\int_{y \in \mathbb{R}^{N_M}} \eta_\epsilon(y) f(\pi_M(x - y))$$

is well-defined for  $x \in M \subset \mathbb{R}^{N_M}$ , because  $\eta_\epsilon$  has support in a ball of radius  $\epsilon$  and hence  $x - y$  never leaves  $U(M)$ . This is smooth if  $\eta_\epsilon$  was. If  $\epsilon < \epsilon(f)$ , we may apply the  $C^\infty$  map  $\pi_N$  to get a  $C^\infty$  map we denote

$$\eta_\epsilon * \pi f: M \rightarrow N.$$

By construction, as  $\epsilon \rightarrow 0$  this approaches  $f$  in the  $C^r$ -topology.

We have thus extended the approximation technique of the previous section to manifolds. When  $M$  has boundary, some extra care is required: both embeddings need to be neat and  $\epsilon$  tuned down near the boundary. In the next section we will describe a situation where this extra care is taken in a slightly different manner.

### 6.3 The vertical arrows

We shall now prove that the inclusions

$$\text{Diff}_{\partial, D}^\infty(M) \hookrightarrow \text{Diff}_{\partial, D}^r(M)$$

are weak equivalences for all  $r \in \mathbb{N}$ .

We start by picking a  $C^\infty$  collar neighborhood  $c: \partial M \times [0, 1] \hookrightarrow M$ . We shall pick a neat  $C^\infty$  embedding  $\varphi_M \hookrightarrow M \rightarrow \mathbb{R}^{N-1} \times [0, \infty)$  such that  $\varphi_M^{-1}(\mathbb{R}^{N-1} \times \{0\}) = \partial M$ , and denote  $\varphi_M|_{\partial M}$  by  $\varphi_{\partial M}$ . Using the collar we may assume that  $\varphi_M$  is given by  $\varphi_{\partial M} \times \text{id}$  on  $\partial M \times [0, 1/2]$ . If we use the Euclidean metric to construct a  $C^\infty$  tubular neighborhood  $\Phi_M: \nu_M \rightarrow \mathbb{R}^{N-1} \times [0, \infty)$ , it will be of the form  $\Phi_{\partial M} \times \text{id}$  on  $\partial M \times [0, 1/2]$ .

**Theorem 6.3.1.** *The maps  $\text{Diff}_{\partial, D}^\infty(M) \hookrightarrow \text{Diff}_{\partial, D}^r(M)$  are weak equivalences.*

*Proof.* Suppose we are given a commutative diagram

$$\begin{array}{ccc} S^i & \xrightarrow{h} & \text{Diff}_{\partial, D}^\infty(M) \\ \downarrow & & \downarrow \\ D^{i+1} & \xrightarrow{H} & \text{Diff}_{\partial, D}^r(M), \end{array}$$

then we need to provide a homotopy through commutative diagrams to one where there is a lift. We may start with an initial collar sliding trick homotopy as in Chapter 4 to make each  $H_s \in \text{Diff}_{\partial, D}^r$  the identity on  $\partial M \times [0, 1/2]$ .

We define a cut-off version of the convolution construction. Let us assume  $\epsilon < 1/4$ , pick a smooth function  $\rho: [0, 1] \rightarrow [0, 1]$  that is 0 on  $[0, 1/4]$  and 1 on  $[1/2, 1]$ . Using it we may define a function

$\bar{\rho}: M \rightarrow [0, 1]$  by

$$\bar{\rho}(p) := \begin{cases} \rho(t) & \text{if } p = (q, t) \in \partial M \times [0, 1] \\ 1 & \text{otherwise,} \end{cases}$$

and set

$$(\eta_\epsilon \bar{*} \pi f)(x) := \pi_M \left( (1 - \rho(x)) \cdot f(x) + \rho(x) \cdot \int_{y \in \mathbb{R}^{N_M}} \eta_\epsilon(y) f(\pi_M(x - y)) \right).$$

By construction this is the identity on  $y \in \partial M \times [0, 1/4 - \epsilon]$ , and it is interpolation between the smooth identity map and a smooth convolution elsewhere. Thus it is smooth everywhere.

For each  $s \in D^{i+1}$ , there exists a single  $\epsilon_s \in (0, 1/4)$  such that  $\eta_\epsilon \bar{*} \pi H_s: M \rightarrow N$  is well-defined for  $\epsilon < \epsilon_s$  and this depends continuously on  $s$ . These are smooth maps  $M \rightarrow M$  converging uniformly to  $H_s$  in the  $C^r$ -topology as  $\epsilon \rightarrow 0$ . This means that the first derivative of  $\eta_\epsilon \bar{*} \pi H_s$  is bijective when  $\epsilon$  is small enough, and since  $H_s$  is injective,  $\eta_\epsilon \bar{*} \pi H_s$  will be injective for  $\epsilon$  small enough, again depending continuously on  $s$ . By compactness of  $D^{i+1}$  there exists a single  $\epsilon_0 \in (0, 1/4)$  such that this is true for all  $H_s$ . Thus we define the homotopy by the formula

$$\tau \ni [0, 1] \mapsto \pi_M \left( (1 - \rho \cdot \tau) \cdot H_s + \rho \cdot \tau \cdot \int_{y \in \mathbb{R}^{N_M}} \eta_{\epsilon_0}(y) H_s(\pi_M(x - y)) \right).$$

We remark that this preserves  $C^\infty$ -functions. For  $\tau = 1$ , we land in the  $C^\infty$ -diffeomorphisms.  $\square$

## 6.4 Diffeomorphism groups as simplicial groups

We promised a construction of a simplicial group of diffeomorphism which does not involve the Whitney topology. This is sketched in this final section of this lecture.

### *A recollection of simplicial sets*

We recall the definition of a *simplicial set*, see e.g. [GJ09]. This is a different notion of space than topological space,<sup>1</sup> which is more combinatorial.

Let  $\Delta$  be the category of finite ordered sets, which has a skeleton given by  $[k] = \{0, \dots, k\}$  for  $k \geq 0$ . Then a simplicial set is a functor  $Y: \Delta^{\text{op}} \rightarrow \text{Set}$ . Evaluating on  $[k] = \{0, \dots, k\}$  we obtain a collection of sets of  $Y_k$  for  $k \geq 0$ , called the sets of *k-simplices*. In geometric examples, these are *k*-parameters families of geometric objects. The inclusions  $\{0, \dots, \hat{i}, \dots, k\} \rightarrow \{0, \dots, k\}$  induce the *face maps*  $d^i: Y_k \rightarrow Y_{k-1}$ , and the map  $\{0, \dots, k\} \rightarrow \{0, \dots, k-1\}$  hitting *i* twice induces the *degeneracy map*  $s_i: Y_{k-1} \rightarrow Y_k$ . These two

<sup>1</sup> This can be made precise. Homotopy theories on a category may be presented by *model category structures*. There is a Quillen model structure on both simplicial sets and compactly generated weakly Hausdorff spaces, and these are Quillen equivalent; this implies they have the same homotopy category.

special types of morphisms generate all the morphisms of  $\Delta$ , so the  $k$ -simplices, face maps and degeneracy maps describe the simplicial set completely. To see the reason for these names, note that the combinatorics of  $d_i$  are those of the faces of the standard  $k$ -simplices  $\Delta^k := \{(t_0, \dots, t_k) \mid t_i \in [0, 1], \sum_i t_i = 1\}$ .

To every topological space  $X$  we can assign a simplicial set  $\text{Sing}(X)$  with  $k$ -simplices given by the set of continuous maps  $\Delta^k \rightarrow X$ . These simplicial sets are Kan complexes, which are the simplicial sets one should think of as corresponding to topological spaces (the definition is that they have horn fillers, and they are the fibrant objects in the Quillen model structure). Kan complexes  $Y$  have homotopy groups  $\pi_i(Y, y_0)$  based at a 0-simplex  $y_0 \in Y_0$ , see Section I.7 of [GJ09], and so we can make sense of weak equivalences between them.

A simplicial map between two simplicial sets is a natural transformation, i.e. consists of maps  $f_k: Y_k \rightarrow Z_k$  that are compatible with the face and degeneracy map. A map between Kan complexes is said to be a weak equivalence if it induces an isomorphism on all these homotopy groups. A continuous map  $f: Y \rightarrow Z$  is a weak equivalence in the classical sense if  $\text{Sing}(f): \text{Sing}(Y) \rightarrow \text{Sing}(Z)$  is, so if you are interested in the homotopy theory of spaces, you might as well think about Kan complexes.

### *Diffeomorphism groups as simplicial groups*

Note that if a space  $X$  is a topological group, then each of the sets  $\text{Sing}(X)_k$  is a group, and all face and degeneracy maps are group homomorphisms. In other words, it is a functor  $\Delta^{\text{op}} \rightarrow \text{Grp}$ , and hence called a *simplicial group*. All simplicial groups are Kan by Lemma I.3.4 of [GJ09].

We will now give a simplicial group weakly equivalent to  $\text{Sing}(\text{Diff}_0^r(M))_k$  whose definition does not involve the Whitney topology. It does unfortunately involve manifolds with corners, which are locally modeled on  $[0, \infty)^k$  instead of  $\mathbb{R}^k$  (manifolds with empty boundary) or  $\mathbb{R}^{k-1} \times [0, \infty)$  (manifolds with boundary).

**Definition 6.4.1.** Let  $\text{SDiff}_0^r(M)$  denote the simplicial group with  $k$ -simplicial given by the  $C^r$ -diffeomorphisms  $\Delta^k \times M \rightarrow \Delta^k \times M$  that fix  $\Delta^k \times \partial M$  pointwise and preserve the projection to  $\Delta^k$ .<sup>2</sup>

It follows directly from the definition that the simplicial group  $\text{SDiff}_0^r(M)$  is a sub-simplicial group of  $\text{Sing}(\text{Diff}_0^r(M))_k$ , consisting of the “smooth simplices.” It is not all of  $\text{Sing}(\text{Diff}_0^r(M))_k$ , as the 1-simplex

$$\begin{aligned} \Delta^1 &\cong \{(t_0, t_1) \mid t_i \in [0, 1], t_0 + t_1 = 1\} \rightarrow \text{Diff}^r(\mathbb{R}) \\ (t_0, t_1) &\mapsto x \mapsto x + \max(0, t_0 - 1/2) \end{aligned} \tag{6.1}$$

<sup>2</sup> One may similarly define  $\text{SDiff}_{\partial, D}^r(M)$  and  $\text{SDiff}_{\partial, U}^r(M)$  and these will be weakly equivalent to  $\text{SDiff}_0^r(M)$ .

consists of diffeomorphisms and is continuous in the Whitney topology, as all partial derivatives converge uniformly on all compact subsets of  $\mathbb{R}$ , but is not a 1-simplex of  $\text{SDiff}^r(M)$ .

The following is proven by applying the smoothing techniques of this lecture not in the manifold direction, but in the parameter direction. For example, in (6.1), this amounts to smoothing the function  $x \mapsto x + \max(0, t_0 - 1/2)$ . To prevent issues at the boundary, a preliminary step involving a collar of  $\partial\Delta^k \times M \cup \Delta^k \times \partial M$  in  $\Delta^k \times M$  is required, just like in Theorem 6.3.1.

**Proposition 6.4.2.** *The inclusion  $\text{SDiff}_\partial^r(M) \hookrightarrow \text{Sing}(\text{Diff}_\partial^r(M))$  is a weak equivalence.*



## **Part II**

# **Low dimensions**



# 7

## Smale's theorem

We spend the previous three chapters proving that a number of variations of the definition of a diffeomorphism group are weakly equivalent. Hence we make the following convention.

**Convention 7.0.1.** In the remainder of this book, unless mentioned otherwise, differentiable manifolds and diffeomorphisms are  $C^\infty$ . Diffeomorphisms will always have the weak Whitney topology.

Today we will prove that the diffeomorphism group  $\text{Diff}_0(D^2)$  is contractible, using the proof in [Sma59b]. We will later discuss isotopy extension, and the alternative proof by Gramain [Gra73]. There are three other proofs:

- (1) using complex geometry [EE69], see [EM88] for a variation,
- (2) by modifying Hatcher's proof for  $D^3$  [Hat83],
- (3) by using a curve-shortening flow as in [Gra89].

We shall also discuss the related diffeomorphism group  $\text{Diff}(S^2)$ , and start the proof that is weakly equivalent to  $O(3)$ .

### 7.1 Squares vs. disks

We shall need to compare diffeomorphisms of the square to diffeomorphisms of the 2-disk. This uses the following general construction.

If  $M, M'$  are compact manifolds of dimension  $m$  (possibly with boundary), and  $i: M \hookrightarrow M'$  is an embedding, then there is an induced continuous map:

$$i_*: \text{Diff}_{\partial, U}(M) \rightarrow \text{Diff}_{\partial, U}(M')$$
$$f \mapsto i_*(f)(p) := \begin{cases} p & \text{if } p \notin i(M), \\ i(f(i^{-1}(p))) & \text{otherwise.} \end{cases}$$

This inserts  $f$  on the image of  $i$ , and extends the identity elsewhere.

Takeaways:

- Diffeomorphisms of  $D^2$  fixing the boundary are contractible.
- The proof of this involves two ideas:
  - (i) the space of non-zero vector fields on  $D^2$  that are equal to  $\vec{e}_1$  near the boundary is contractible,
  - (ii) Poincaré-Bendixson implies the flow-lines of such a vector field has to leave  $D^2$  in finite time.
- This allows one to compute that  $\text{Diff}(S^2) \simeq O(3)$ .

If  $i$  is isotopic to  $i'$ , then  $i_*$  is homotopic to  $(i')_*$ ; an isotopy  $i_t$  induces a homotopy  $(i_t)_*$ . Thus if we also have an embedding  $j: M' \hookrightarrow M$  so that  $i$  and  $j$  are mutually inverse up to isotopy, then  $i_*$  and  $j_*$  are mutually inverse up to homotopy. Applying this to the embeddings of Figure 7.1, we obtain the following:

**Proposition 7.1.1.** *The topological groups  $\text{Diff}_{\partial,U}(I^2)$  and  $\text{Diff}_{\partial,U}(D^2)$  are homotopy equivalent topological groups.*

**Remark 7.1.2.** Strictly speaking we did not define diffeomorphism of manifolds with corners, like  $I^2$ . However, since we require them to be equal to the identity on a neighborhood of the boundary, we can equivalently think of  $\text{Diff}_{\partial,U}(I^2)$  as a subgroup of  $\text{Diff}(\mathbb{R}^2)$ . Wall's book has a section on manifolds with corners and smoothing of corners, [Wal16].

## 7.2 Smale's proof

To prove that  $\text{Diff}_{\partial}(D^2)$  is weakly contractible, it thus suffices to prove the analogous statements for squares.

**Theorem 7.2.1** (Smale).  *$\text{Diff}_{\partial,U}(I^2)$  is contractible.*

The idea is to consider for a diffeomorphism  $f \in \text{Diff}_{\partial,U}(I^2)$  the vector field  $\mathcal{X}(f)$  on  $I^2$  obtained by pushing forward  $\vec{e}_1$  along  $f$ :

$$\mathcal{X}(f)(x, y) := (f_*(\vec{e}_1))(x, y) = Df_{f^{-1}(x,y)}(\vec{e}_1).$$

One can reconstruct  $f$  from  $\mathcal{X}(f)$  as follows. To avoid issues with domain of certain maps, let us first remark we may extend  $\mathcal{X}(f)$  by the constant vector field  $\vec{e}_1$  to a bounded vector field on  $\mathbb{R}^2$ , which we shall also denote  $\mathcal{X}(f)$ . Then its flow  $\Phi_{\mathcal{X}(f)}$  is defined for all  $t \in \mathbb{R}$ , see e.g. Proposition 1.4.4 of [Wal16].

Let us now take a point  $(0, y) \in \{0\} \times I$  and flow for time  $t$ . Since  $\mathcal{X}(f)$  is obtained by pushing forward a vector field on  $\mathbb{R}^2$  along a diffeomorphism, we may compute the flow by flowing for time  $t$  along this vector field and applying  $f$ . To see this, note that a flowline  $\gamma$  of  $\Phi_{\mathcal{X}(f)}$  is determined uniquely by the equations

$$\begin{aligned} \frac{d}{dt}(\gamma(t)) &= \mathcal{X}(f)(\gamma(t)) = (Df)_{f^{-1}(\gamma(t))}(\vec{e}_1) \\ \gamma(0) &= (0, y). \end{aligned}$$

But  $t \mapsto f(t, y)$  also satisfies these equations:  $f(0, y) = (0, y)$  since  $f$  is the identity near  $\partial I^2$  and  $\frac{d}{dt}f(t, y) = (Df)_{(x,y)}(\vec{e}_1) = (Df)_{f^{-1}(f(x,y))}(\vec{e}_1)$ . Hence from uniqueness of solutions to ODE's, we may conclude that

$$\Phi_{\mathcal{X}(f)}(t, 0, y) = f(t, y).$$

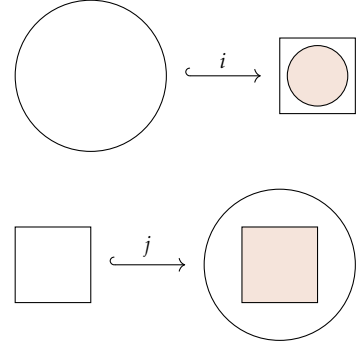

Figure 7.1: Embeddings of disk into square, and square into disk, by translation and scaling. Note that  $i \circ j$  and  $j \circ i$  are isotopic to the identity by linear interpolation.

Now that we have shown how to recover  $f$  from  $\mathcal{X}(f)$ , the plan is to use a convexity argument on the vector field  $\mathcal{X}(f)$ . Before doing so, we start with some preparation.

Observe that  $\mathcal{X}(f)$  lies in the space  $\mathcal{S}$  of *non-zero* smooth vector fields on  $I^2$  that are equal to  $\vec{e}_1$  on an open neighborhood of  $\partial I^2$ . It is topologized as a subspace of all smooth maps  $\mathbb{R}^2 \rightarrow \mathbb{R}^2$ . Conversely, we claim that any  $\mathcal{Y} \in \mathcal{S}$  gives rise to a diffeomorphism. The construction of this diffeomorphism is essentially by flowing, but there are some technical details to address.

Let  $\Phi_{\mathcal{Y}}: \mathbb{R} \times \mathbb{R}^2 \rightarrow \mathbb{R}^2$  denote the map obtained by flowing along the vector field  $\mathcal{Y}$ , where again we have implicitly extended  $\mathcal{Y}$  to  $\mathbb{R}^2$  by the constant vector field  $\vec{e}_1$ . This lemma is one of two places where we use that we are in dimension 2 in a non-superficial manner. The second place is when we show that  $\mathcal{S}$  is contractible in Lemma 7.2.5.

**Lemma 7.2.2.** *Let  $\mathcal{Y} \in \mathcal{S}$ , then for all  $(0, y) \in \{0\} \times I$  there exists a  $\tau(\mathcal{Y}, y) \in (0, \infty)$  such that  $\Phi_{\mathcal{Y}}(\tau(\mathcal{Y}, y), 0, y) \in \{1\} \times I$ , see Figure 7.2. This is unique and depends continuously on  $\mathcal{Y}$  and smoothly on  $y$ .*

*Proof.* The uniqueness follows directly by remarking that the  $x$ -coordinate increases linearly in  $t$  as soon as one leaves  $I^2$ . Continuity in  $\mathcal{Y}$  and smoothness in  $y$  follow from Picard-Lindelöf.

Existence is less easy. Since  $\mathcal{Y}$  equals  $\vec{e}_1$  near  $\partial I$ , if a flow-line leaves, it has to do so through  $\{1\} \times I$ . Thus we see that existence of  $\tau(\mathcal{Y}, y)$  can only fail if the flow-line does not hit  $\{1\} \times I$ .

Suppose that  $\gamma: [0, \infty) \rightarrow I^2$  is a flow-line that does not hit  $\{1\} \times I$ . In that case, we consider the *forwards-time limiting set*

$$\infty^*(\gamma) := \bigcap_{\alpha > 0} \overline{\gamma((\alpha, \infty))}.$$

It is closed and invariant under the flow. It is non-empty as an intersection of nested compact subsets. Furthermore, since  $\mathcal{Y}$  is  $\vec{e}_1$  near  $\partial I^2$ , it is contained in the interior of  $I^2$ .

Let us thus pick a point  $q$  in  $\infty^*(\gamma)$ , then since  $\mathcal{Y} \in \mathcal{S}$  we have  $\mathcal{Y}(q) \neq 0$ . Hence there is a straight line segment  $\eta$  through  $q$  which is transverse to  $\mathcal{Y}$  near  $q$ , i.e. an affine linear embedding  $(-1, 1) \rightarrow I^2$  such that  $\eta(0) = q$  and all  $s \in (-1, 1)$ ,  $T_s\eta \oplus \mathcal{Y}(\eta(s)) = \mathbb{R}^2$ . The subset  $\gamma^{-1}(\text{im}(\eta))$  is discrete, and we can order its non-negative elements as  $t_1 < t_2 < \dots$ . For each  $\gamma(t_i) \in \text{im}(\eta)$ , we introduce the notation  $s_i := \eta^{-1}(\gamma(t_i))$ .

*Claim:* either (i)  $s_1 = s_2 = 0$ , or (ii)  $s_i$  is strictly increasing or decreasing to 0.

*Proof of claim.* Suppose (i) does not hold. Then for concreteness, consider the instructive Figure 7.3.

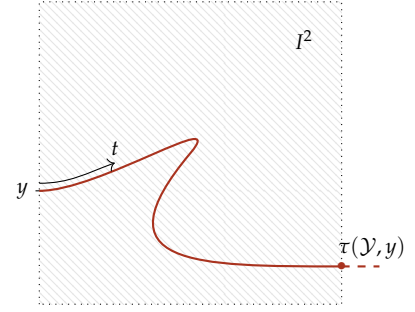
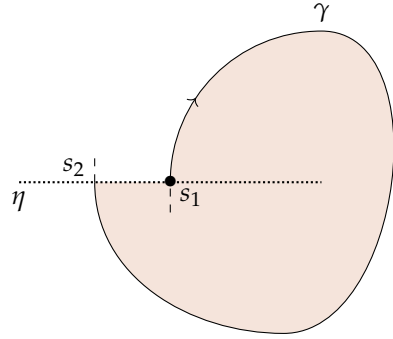

Figure 7.2: The red line is the flow-line  $t \mapsto \Phi_{\mathcal{Y}}(t, 0, y)$ , and the  $\tau(\mathcal{Y}, y)$  is the first and only time where this flowline hits the side  $\{1\} \times I$  of  $I^2$ .

**Example 7.2.3.** For  $\mathcal{X}(f)$ , the function  $\tau(\mathcal{X}(f), y)$  is identically 1.

In fact, a similar argument proves the stronger Poincaré-Bendixson theorem, Theorem 7.2.3 of [CC00], which says that  $\infty^*(\gamma)$  is of one of the following three forms:

- a fixed point,
- a union of paths between fixed points,
- a periodic orbit.

Figure 7.3: The flow-line  $\gamma$  intersecting the transversal  $\eta$ .

Since  $\eta$  is transverse to  $\mathcal{Y}$  and  $\mathcal{Y}$  points upwards at  $s_1$ , any flow-line through  $\eta$  must point upwards. Thus  $\gamma$  cannot re-enter the shaded region through  $\eta$ . By uniqueness of solutions to ordinary differential equations, it cannot re-enter through  $\gamma$ . Finally, the piecewise-smooth Schoenflies theorem<sup>1</sup> applied to the union  $S$  of the segment of  $\gamma$  between  $t_0$  and  $t_1$  and the segment of  $\eta$  between  $s_0$  and  $s_1$ , implies that  $S$  separates the plane and thus  $\gamma$  can not re-enter in any other way. This implies (ii).  $\square$

<sup>1</sup> We will prove the smooth Schoenflies theorem in Theorem 11.1.3, and the piecewise-smooth version easily follows.

In case (i), uniqueness of solutions to ordinary differential equations implies  $\gamma$  is periodic. In case (ii), let  $\tilde{\gamma}$  be the flowline through  $q$ . Then  $\infty^*(\tilde{\gamma}') \subset \infty^*(\gamma)$  and the argument above implies that  $\infty^*(\tilde{\gamma}') \cap \text{im}(\eta)$  consists of the convergence points of  $\infty^*(\gamma) \cap \text{im}(\eta)$  and hence only of  $q$ . Thus  $\tilde{\gamma}'$  is periodic.

Thus in both cases, we obtain that there is a loop in the interior of  $I^2$  along which  $\mathcal{Y}$  has winding number 1. This implies that it must have a zero in the interior, by the Hopf-Rinow theorem. We have thus obtained a contradiction, and  $\gamma$  must leave.  $\square$

It is tempting to define a diffeomorphism

$$(x, y) \mapsto \Phi_{\mathcal{Y}}(\tau(\mathcal{Y}, y) \cdot x, 0, y), \quad (7.1)$$

but this is not the identity near  $\partial I^2$ . It has two defects:

- (a) It might do some scaling in the  $x$ -direction near  $\{0, 1\} \times I$ .
- (b) A flowline might end up moving vertically, e.g. in Figure 7.2, we have that the flowline enters at a higher  $y$ -coordinate than the one at which it exists. This means the map is a non-trivial diffeomorphism  $\phi(\mathcal{Y}): I \rightarrow I$  when restricted to  $\{1\} \times I$ .

We have already seen before that these issues do not tend to matter, and we can get rid of them if we slightly more careful in (7.1). To address (a), we pick a smooth family of smooth embeddings  $\eta_{\tau}: [0, 1] \rightarrow [0, \infty)$  with the following properties:

- (i) the image of  $\eta_{\tau}$  is  $[0, \tau]$ ,

- (ii)  $\eta_\tau$  has derivative 1 near 0 and  $\tau$ , and
- (iii)  $\eta_1 = \text{id}$ .

We shall use this to reparametrize the time coordinate.

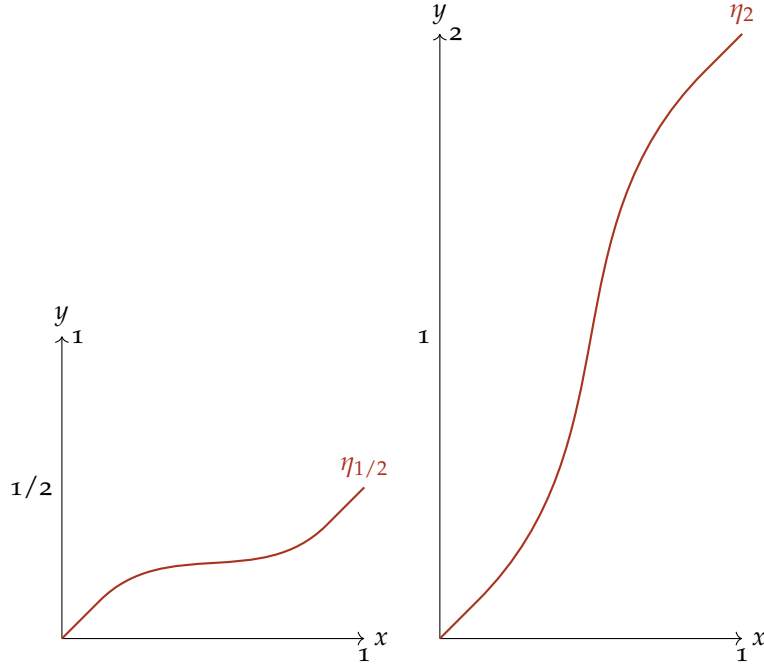

To address (b), we pick a smooth function  $\rho: [0, 1] \rightarrow [0, 1]$  that is 0 near 0 and 1 near 1. Given a diffeomorphism  $\phi: I \rightarrow I$  that is the identity near  $\partial I$ , we define a diffeomorphism of  $I^2$

$$\begin{aligned} \bar{\rho}_\phi: I^2 &\rightarrow I^2 \\ (x, y) &\mapsto (x, (1 - \rho(x)) \cdot y + \rho(x) \cdot \phi^{-1}(y)). \end{aligned}$$

We shall use this to modify the diffeomorphism near  $\{1\} \times I$ .

We then define

$$\begin{aligned} \Psi_{\mathcal{Y}}: I^2 &\rightarrow I^2 \\ (x, y) &\mapsto \bar{\rho}_{\phi(\mathcal{Y})}[\Phi_{\mathcal{Y}}(\eta_{\tau(\mathcal{Y}, y)}(x), 0, y)]. \end{aligned}$$

**Lemma 7.2.4.** *For any  $\mathcal{Y} \in \mathcal{S}$ , the map  $\Psi_{\mathcal{Y}}$  is a diffeomorphism.*

*Proof.* The map  $\Psi_{\mathcal{Y}}$  is a composition of the three maps

$$\begin{aligned} (x, y) &\mapsto (\eta_{\tau(\mathcal{Y}, y)}(x), 0, y), \\ (t, y) &\mapsto \Phi_{\mathcal{Y}}(t, 0, y), \\ (x, y) &\mapsto \bar{\rho}_{\phi(\mathcal{Y})}, \end{aligned}$$

which are easily shown to have bijective differential. Thus as a consequence of the inverse function theorem,  $\Psi_{\mathcal{Y}}$  is a local diffeomorphism.

Thus it suffices to show it is injective and surjective. It will be surjective as a consequence of the Brouwer fixed point theorem. If it failed to be injective, this would imply that there exist  $(x, y) \neq (x', y')$  such that  $\Psi_{\mathcal{Y}}(x, 0, y) = \Psi_{\mathcal{Y}}(x', 0, y')$ . Uniqueness of solutions implies that  $y = y'$  and since there are no periodic orbits we must have  $x = x'$ , leading to a contradiction.  $\square$

By smoothness of the family  $\eta_\tau$ , the map  $\Psi: \mathcal{S} \rightarrow \text{Diff}_{\partial, U}(I^2)$  is continuous, and by property (iii) we have that  $\Psi_{\mathcal{X}(f)} = f$ . Thus it suffices to deform the vector field  $\mathcal{X}(f)$  to  $\mathcal{X}(\text{id}) = \vec{e}_1$  in  $\mathcal{S}$ , continuously in  $f$ .

**Lemma 7.2.5.** *The space  $\mathcal{S}$  smoothly deformation retracts onto the constant vector field  $\vec{e}_1$ .*

*Proof.* Identify  $\mathcal{S}$  with the space of smooth maps  $I^2 \rightarrow \mathbb{R}^2 \setminus \{0\}$  that equal  $\vec{e}_1$  near the boundary. The non-zero vectors may be identified with  $\mathbb{R}^2 \setminus \{0\}$ , so pick a lift  $\tilde{e}_1$  of  $\vec{e}_1$  to the universal cover

$$p: \tilde{\mathbb{R}}^2 \setminus \{0\} \rightarrow \mathbb{R}^2 \setminus \{0\}.$$

Every vector field in  $\mathcal{S}$  lifts uniquely to a  $C^\infty$ -function  $\tilde{\mathcal{X}}(f): I^2 \rightarrow \tilde{\mathbb{R}}^2 \setminus \{0\}$  once we specify that on  $I \times \{0\}$  it should take value  $\tilde{e}_1$ . Then automatically it has value  $\tilde{e}_1$  on  $\partial I^2$  since  $I^2$  is simply-connected. Thus we may identify  $\mathcal{S}$  with a subspace of the space of smooth maps  $I^2 \rightarrow \tilde{\mathbb{R}}^2 \setminus \{0\}$  that are equal to  $\tilde{e}_1$  near  $\partial I^2$ .

Since  $\mathbb{R}^2 \setminus \{0\}$  is homotopy equivalent to  $S^1$ , its universal cover  $\tilde{\mathbb{R}}^2 \setminus \{0\}$  is contractible. Hence there is a deformation retraction  $h_s, s \in [0, 1]$  onto  $\tilde{e}_1$ . By the techniques of the previous lecture this deformation retraction may be made smooth. Then the homotopy

$$\begin{aligned} H: \mathcal{S} \times [0, 1] &\rightarrow \mathcal{S} \\ (\mathcal{Y}, s) &\mapsto p \circ h_s(\tilde{\mathcal{Y}}), \end{aligned}$$

obtained by applying  $h_s$  to the values of  $\tilde{\mathcal{Y}}$ , is a deformation retraction of  $\mathcal{S}$  onto  $\vec{e}_1$ .  $\square$

*Proof of Theorem 7.2.1.* There is a deformation retraction onto the identity given by

$$(f, s) \mapsto \Psi_{H_s(\mathcal{X}(f))}. \quad \square$$

This proof fails in dimension  $n > 2$  because there may be non-zero smooth vector fields  $\mathcal{X}$  that are equal to  $\vec{e}_1$  near  $\partial I^n$  but have periodic orbits. These can not be integrated to diffeomorphism  $f$  by the above construction, because then  $\mathcal{X}(f)$ , the pushforward of the vector field  $\vec{e}_1$  without periodic orbits, would have to equal  $\mathcal{X}$  (possible up to composition with some easily understood diffeomorphisms).<sup>2</sup>

<sup>2</sup> Here is an example of how to construct such an  $\mathcal{X}$ . First, take a solid torus  $D^{n-1} \times S^1$  with the longitudinal vector field  $\frac{d}{d\theta}$  for  $\theta$  the  $S^1$ -coordinate. Embed this solid torus in  $I^n$  so that  $\{1\} \times S^1$  bounds a disk. Then we can extend the vector field to a non-zero vector field on this disk, as  $\pi_1(S^{n-1}) = 0$  where  $S^{n-1}$  is the homotopy type of the non-zero vectors (here you see where  $n = 2$  is different: we would get  $\pi_1(S^1) \cong \mathbb{Z}$  instead). After this step



### 7.3 Diffeomorphisms of $S^2$

We give a partial proof of an application of Smale's theorem, which we will revisit in the next lecture when we have developed parametrized isotopy extension. This application is that there is a weak euivalence  $\text{Diff}(S^2) \simeq O(3)$ . Today we shall show that  $\text{Diff}(S^2)$  is a product of  $O(3)$  with a topological group  $G$  similar to  $\text{Diff}_\partial(D^2)$ , which will later be shown to be contractible.

We start with the following well-known observations. We consider  $S^2$  as the subspace of  $\mathbb{R}^3$  given by  $\{z \in \mathbb{R}^3 \mid \|z\| = 1\}$ . Its tangent space at  $z$  may thus be identified with the subspace of  $\mathbb{R}^3$  orthogonal to  $z$ . This means that the orthonormal frame bundle  $\text{Fr}^O(TS^2)$  can be identified by ordered triples of orthonormal vectors in  $\mathbb{R}^3$ . This admits a free transitive action of  $O(3)$ , so we may identify  $\text{Fr}^O(TS^2)$  with  $O(3)$ .

The orthonormal frame bundle is homotopy equivalent to the general linear frame bundle  $\text{Fr}^{\text{GL}}(TS^2)$ . This consistent of ordered triples  $(z_1, z_2, z_3)$  in  $\mathbb{R}^3$ , with  $z_1 \in S^2$ , and the pair  $(z_2, z_3)$  linearly independent and orthogonal to  $z_1$ . Gram-Schmidt gives a continuous map

$$GS: \text{Fr}^{\text{GL}}(TS^2) \rightarrow \text{Fr}^O(TS^2)$$

$$(z_1, z_2, z_3) \mapsto \left( z_1, \frac{z_2}{\|z_2\|}, \frac{z_3 - \langle z_2, z_3 \rangle \frac{z_2}{\|z_2\|^2}}{\|z_3 - \langle z_2, z_3 \rangle \frac{z_2}{\|z_2\|^2}\|} \right),$$

which is easily seen to be a homotopy equivalence.

A diffeomorphism  $f$  of  $S^2$  acts on the general linear frame bundle. By applying the Gram-Schmidt map and identifying the orthonormal frame bundle with  $O(3)$ , we see that there is a map

$$\alpha: \text{Diff}(S^2) \rightarrow O(3)$$

$$f \mapsto GS(f(\vec{e}_1), D_{\vec{e}_1}f(\vec{e}_2), D_{\vec{e}_1}f(\vec{e}_3)).$$

On the other hand, there is a map  $O(3) \rightarrow \text{Diff}(S^2)$  by rotating the sphere, which is a section of the previous map:

$$\begin{array}{ccccc} G := \ker(g) & \longrightarrow & \text{Diff}(S^2) & \xrightarrow{\alpha} & \text{Fr}^{\text{GL}}(TS^2) \\ & & \uparrow & \searrow & \downarrow GS \\ & & \text{rotation} & g & \text{Fr}^O(TS^2) \\ & & \uparrow & & \downarrow \cong \\ & & O(3) & \xlongequal{\quad} & O(3). \end{array}$$

We conclude that there is a homeomorphism

$$\text{Diff}(S^2) \cong O(3) \times G,$$

**Remark 7.3.1.** There is also an inclusion  $O(3) \hookrightarrow \text{GL}_3(\mathbb{R})$  and the Gram-Schmidt map induces a splitting  $\text{GL}_3(\mathbb{R}) \cong O(3) \times H$ , where  $H$  is the group of upper-triangular matrices with positive diagonal entries. This is an example of the Iwasawa decomposition  $G = KAN$  for  $G = \text{GL}_3(\mathbb{R})$ .

where  $G$  is the subgroup of  $\text{Diff}(S^2)$  consisting of diffeomorphisms which fix  $\vec{e}_1$  and the frame  $(\vec{e}_2, \vec{e}_3)$  in  $T_{\vec{e}_1}S^2$  up to an upper triangular matrix with positive diagonal entries. There is an inclusion of  $\text{Diff}_{\partial, U}(D^2)$  into  $G$  by acting on the hemisphere around  $-\vec{e}_1$ . We claim this inclusion is a weak equivalence. If so, it follows from Smale's theorem that:

**Theorem 7.3.2.** *We have that  $\text{Diff}(S^2) \simeq O(3)$ .*

# 8

## Parametrized isotopy extension

In the previous chapter we proved Smale's theorem that  $\text{Diff}_0(D^2) \simeq *$ . We left open a step in the computation of  $\text{Diff}(S^2)$ . To finish this computation, we shall use the parametrized isotopy extension theorem to show that certain restriction maps are fibrations. Isotopy extension is discussed in [Hir94, Wal16].

### 8.1 Parametrized isotopy extension

#### Isotopy extension

A basic question about manifolds is the following: if we move a point around a manifold  $M$ , is this motion induced by a family of diffeomorphisms? To answer it, we must state the question in a precise way. In doing so, we shall also generalize it from points to arbitrary submanifolds.

**Definition 8.1.2.** • An *isotopy of embeddings*  $M \hookrightarrow N$  is a neat smooth embedding  $g: M \times [0, 1] \hookrightarrow N \times [0, 1]$  that fits into a commutative diagram

$$\begin{array}{ccc} M \times [0, 1] & \xrightarrow{g} & N \times [0, 1] \\ & \searrow & \swarrow \\ & [0, 1] & \end{array}$$

• An *isotopy of diffeomorphisms* of  $N$  is a diffeomorphism  $f: N \times [0, 1] \rightarrow N \times [0, 1]$  that fits into a commutative diagram

$$\begin{array}{ccc} N \times [0, 1] & \xrightarrow{f} & N \times [0, 1] \\ & \searrow & \swarrow \\ & [0, 1] & \end{array}$$

Takeaways:

- We can extend isotopies of embeddings to isotopies of diffeomorphisms by flowing along a vector field obtained by extending the derivative of the embedding with respect to  $t$ .
- With care, this proves that the action of diffeomorphisms on embeddings is a fibration.

**Example 8.1.1.** Consider the case of the path  $[0, 1] \ni t \mapsto t \cdot \vec{e}_1$  in  $\mathbb{R}^2$ , a point moving with constant speed along a straight line from  $(0, 0)$  to  $(1, 0)$ . If we imagine the manifold  $\mathbb{R}^2$  being made out of a stretchy material, you put your finger on  $(0, 0)$  and, by pushing, deform the entire manifold while you move your finger from  $(0, 0)$  to  $(1, 0)$ . This should convince you that the question may be answered positively in this particular case. See Figure 8.1 for a picture of the end result.

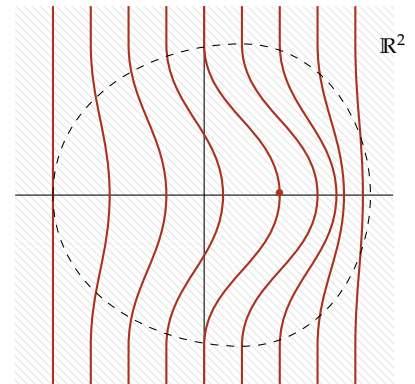

Figure 8.1: The end result of the point-pushing, depicted by its effect on vertical lines in  $\mathbb{R}^2$ . The dashed line gives the boundary of the support.

An isotopy of diffeomorphisms is also called an *ambient isotopy*. We remark that  $g_t := g|_{M \times \{t\}}$  is an embedding  $M \hookrightarrow N$ , and  $f_t := g|_{N \times \{t\}}$  is a diffeomorphism of  $N$ .

The isotopy extension theorem answers the following question: given an isotopy  $g$  of embeddings, when is there an isotopy  $f$  of diffeomorphisms such that  $g_t = f_t \circ g_0$ ? We will answer this in the case of a *compactly-supported* isotopy of embeddings; this means that there is a compact set  $K \subset M$  such that  $g_t|_{M \setminus K} = g_0|_{M \setminus K}$  for all  $t \in [0, 1]$ . There is a similar notion of a compactly-supported isotopy of diffeomorphisms.

**Theorem 8.1.4** (Isotopy extension). *Given a compactly-supported isotopy of embeddings  $g: M \times [0, 1] \hookrightarrow N \times [0, 1]$  with support  $K$  such that  $K \cap \partial M = \emptyset$ , there exists a compactly-supported isotopy of diffeomorphisms  $f: N \times [0, 1] \rightarrow N \times [0, 1]$  such that  $f_0 = \text{id}$  and  $g_t = f_t \circ g_0$ .*

*Proof.* The smooth vector field on  $M \times [0, 1]$  given by  $\frac{\partial}{\partial t}$  can be pushed forward along the embedding  $g$  to obtain a vector field  $\mathcal{X}(g)$  in  $T(N \times [0, 1])|_{M \times [0, 1]}$ . If we flow along  $\mathcal{X}(g)$  for time  $t$  with initial condition  $(p, 0)$ , we end up at  $(g_t(p), t)$ : it satisfies the same differential equations and initial conditions as applying  $g_t$  to the flow along  $\frac{\partial}{\partial t}$  on  $M \times [0, 1]$ .<sup>1</sup> We can deduce that  $g$  preserves the projection  $\pi$  to  $[0, 1]$  by noting that  $g$  preserves  $\pi$  if and only if the vector field  $\pi_*(\mathcal{X}(g))$  on  $[0, 1]$  equals  $\frac{\partial}{\partial t}$ .

If we can extend  $\mathcal{X}(g)$  to a smooth vector field  $\mathcal{X}(f)$  on  $N \times [0, 1]$  that projects to  $\frac{\partial}{\partial t}$  under  $\pi_*$ , we can attempt to flow along it to produce  $f$ . The fact that it extends  $\mathcal{X}(g)$  will then imply  $g_t = f_t \circ g_0$ , and the fact that it projects to  $\frac{\partial}{\partial t}$  under  $\pi_*$  will imply that it preserves  $\pi$ . To guarantee that  $f$  is compactly-supported, we make sure that  $\mathcal{X}(f)$  is equal to  $\frac{\partial}{\partial t}$  outside of a compact set. This will also imply that the flow of  $\mathcal{X}(f)$  is well-defined, i.e. can't flow away to infinity in finite time, see e.g. Proposition 1.4.4 of [Wal16].

In fact, we can slightly weaken the conditions on the  $\mathcal{X}(f)$  we need to construct; it suffices that  $\mathcal{X}(f)$  coincides with  $\mathcal{X}(g)$  on  $M \times [0, 1]$ , coincides with  $\frac{\partial}{\partial t}$  outside a compact subset of  $N \times [0, 1]$  and  $\pi_*(\mathcal{X}(f))$  is a positive multiple of  $\frac{\partial}{\partial t}$  everywhere. We may then modify  $\mathcal{X}(f)$  by scaling it with smooth function that is 1 on  $M \times [0, 1]$  and outside a compact set, to get that  $\pi_*(\mathcal{X}(f)) = \frac{\partial}{\partial t}$  on all of  $N \times [0, 1]$ .

The condition that  $\mathcal{X}(f)$  maps under  $\pi_*$  to a vector field that is a multiple of  $\frac{\partial}{\partial t}$  by a positive smooth function is convex, so we can produce  $\mathcal{X}(f)$  by a partition of unity. Since the support of  $g$  is compact, we may find a finite collection of charts  $\phi_i: N \times [0, 1] \supset V_i \rightarrow W_i \rightarrow \mathbb{R}^{n-1} \times [0, \infty)$  covering the image of the support of  $g$ , so that  $\phi_i(V_i \cap g(M \times [0, 1])) = W_i \cap (\mathbb{R}^{n-1} \times [0, \infty))$ . Let  $\mathcal{X}_i(f)$

**Remark 8.1.3.** A compactly-supported isotopy is the same as a smooth map  $\bar{g}: M \times [0, 1] \rightarrow N$  such that each  $\bar{g}_t$  is an embedding and  $\bar{g}_t|_{M \setminus K} = \bar{g}_0|_{M \setminus K}$  for all  $t \in [0, 1]$  for some compact  $K$ . This is *not* true without the assumption of compact support [Gei17].

<sup>1</sup> This is similar to what happened in the proof of Theorem 7.2.1.

be the vector field on  $V_i$  given by first extending  $(\phi_i)_*(\frac{\partial}{\partial t})$  is on  $W_i \cap (\mathbb{R}^{m-1} \times [0, \infty))$  in constant fashion to the remaining  $(n - m)$  directions and then applying  $(\phi_i^{-1})_*$ . After possibly shrinking  $V_i$  to a smaller open neighborhood of  $(M \times [0, 1]) \cap V_i$ ,  $\pi_*$  of  $\mathcal{X}_i(f)$  is a positive multiple of  $\frac{\partial}{\partial t}$ .

Let  $V_0$  be an open subset of  $N \times [0, 1]$  satisfying  $V_0 \cap g(M \times [0, 1]) = \emptyset$  and  $V_0 \cup \bigcup_{i=1}^k V_i = N \times [0, 1]$ , and let  $\eta_i$  be smooth partition of unity subordinate to this open cover. The desired vector field is

$$\mathcal{X}(f) := \eta_0 \cdot \frac{\partial}{\partial t} + \sum_{i=1}^k \eta_i \cdot \mathcal{X}_i(f). \quad \square$$

**Remark 8.1.5.** We can avoid having to rescale  $\mathcal{X}(f)$  if we had used nicer charts in our argument. The precise statement concerning existence of these nice charts is as follows: given an embedding  $M \times K \rightarrow N \times K$  over  $K$ , there exists a chart  $\kappa: K \supset V \rightarrow W \subset \mathbb{R}^k$ , and  $\phi: N \times K \supset V' \rightarrow W' \times \mathbb{R}^{n+k}$  such that (i)  $\phi((M \times K) \cap V') = W' \times \mathbb{R}^{m+k}$ ,  $\pi_K(V') \subset V$  with  $\pi_K: N \times K \rightarrow K$  the projection, and (ii) the following diagram commutes

$$\begin{array}{ccc} V' & \xrightarrow{\phi} & W' \\ \downarrow \pi_2 & & \downarrow \pi \\ V & \xrightarrow{\kappa} & W \end{array}$$

for  $\pi: \mathbb{R}^{n+k} \rightarrow \mathbb{R}^k$  the projection.

This also works when you have submersions of  $K$ , or when there are boundaries involved. A reference for these types of technical results is [Sie72].

**Example 8.1.6.** The compact support condition is necessary, as is clear from the proof. For example, consider the family given by moving a knot tied in the  $x$ -axis to  $\infty$ , see Figure 8.2. This can not be induced by an ambient isotopy, because if it were then  $\mathbb{R}^3 \setminus K_0$  would be diffeomorphic to  $\mathbb{R}^3 \setminus \mathbb{R}$ , but they have different fundamental groups (see Chapter 3 of [Rol76] for fundamental groups of knot complements).<sup>2</sup>



A knot  $K_0$  centered at the origin for  $t = 0$  moving rightwards to  $\infty$  as  $t$  increases.

<sup>2</sup> There is an interesting review of this book in [Neu77], which starts with "I have a friend whom I do not see very often these days." It also contains the word "knotology".

### Parametrized isotopy extension

What if instead of a single parameter  $t \in [0, 1]$ , we have multiple parameters? If we define a  $k$ -parameter isotopy of neat embeddings  $g: M \times \Delta^k \rightarrow N \times \Delta^k$  by replacing  $[0, 1] \cong \Delta^1$  with  $\Delta^k$ , and similarly define a  $k$ -parameter isotopy of diffeomorphisms  $f: N \times \Delta^k \rightarrow N \times \Delta^k$ . This involves embeddings and diffeomorphisms of manifolds with corners, which are locally modeled on  $[0, \infty)^k$ , and are explained in [Wal16]. The proof of Theorem 8.1.7 is easily modified to give:

**Theorem 8.1.7** (Parametrized isotopy extension). *Given a compactly-supported isotopy of embeddings  $g: M \times \Delta^k \hookrightarrow N \times \Delta^k$  with support  $K$  such that  $K \cap \partial M = \emptyset$ , there exists a compactly-supported isotopy of diffeomorphisms  $f: N \times \Delta^k \rightarrow N \times \Delta^k$  such that  $g_{\vec{t}} = f_{\vec{t}} \circ g_{(1,0,\dots,0)}$  for each  $\vec{t} \in \Delta^k$ .*

One should think of this Theorem as saying that acting by diffeomorphisms  $g_0$  is a Serre fibration. This is not true, but it is true that up to smooth approximation, which is sufficient to compute the homotopy fiber of this map and get a long exact sequence of homotopy groups. As before, the issue is that a  $k$ -parameter isotopy is *not* the same as a continuous map  $\Delta^k \rightarrow \text{Emb}(M, N)$ : “a continuous family of smooth embeddings is not a smooth family of smooth embeddings.” To avoid this problem we define:

**Definition 8.1.8.** Let  $\text{SEmb}(M, N)$  be the simplicial set with  $k$ -simplices given by smooth embeddings  $M \times \Delta^k \rightarrow N \times \Delta^k$  covering the projections to  $\Delta^k$ .

Given a smooth neat embedding  $g_0: M \hookrightarrow N$ ,  $\text{SEmb}_{c,\partial,U}(M, N)$  denotes the subsimplicial set of compactly-supported smooth embedding  $M \hookrightarrow N$  which agree with  $g_0$  on an open neighborhood of  $\partial M$ .

As in Section 6.4, the inclusion

$$\text{SEmb}_{c,\partial,U}(M, N) \hookrightarrow \text{Sing}(\text{Emb}_{c,\partial,U}(M, N))$$

is a weak equivalence.<sup>3</sup> This is a reasonable statement, if  $\text{SEmb}_{c,\partial,U}(M, N)$  is Kan, which we shall prove momentarily. The following is a consequence of the parametrized isotopy extension theorem. It uses the notion of a Kan fibration, see e.g. Section I.3 of [GJo9], which means it has the left lifting property for horn fillers  $\Lambda_i^n \hookrightarrow \Delta^n$ . Let  $\text{SDiff}_{c,\partial,U}(N) \subset \text{SDiff}(N)$  denote the subsimplicial set of compactly-supported diffeomorphisms that are the identity on an open neighborhood of  $\partial N$ .

**Corollary 8.1.9.** *Fix a smooth neat embedding  $g_0: M \hookrightarrow N$ . Then the map  $\text{SDiff}_{c,\partial,U}(N) \rightarrow \text{SEmb}_{c,\partial,U}(M, N)$  given by acting on  $g_0$  is a Kan fibration.*

<sup>3</sup> Strictly speaking that argument was only given for  $M$  and  $N$  compact, but it may be appropriately generalized.

**Corollary 8.1.10.** *The simplicial set  $\text{SEmb}(M, N)$  is Kan.*

*Proof.* Given maps of simplicial sets  $X \rightarrow Y \rightarrow Z$ , if  $X \rightarrow Y$  and  $X \rightarrow Z$  are Kan fibrations, so  $Y \rightarrow Z$ . This is clear from the definition of a Kan fibration in terms of a lifting property. Apply this  $X = \text{SDiff}_{c, \partial, U}(N)$  (which is Kan because it is a simplicial group),  $Y = \text{SEmb}_{c, \partial, U}(M, N)$  and  $Z = *$ .  $\square$

**Convention 8.1.11.** We will not distinguish between  $\text{Emb}$  and  $\text{SEmb}$ , and similarly for  $\text{Diff}$  and  $\text{SDiff}$ . Thus we apply parametrized isotopy extension to say a map is a fibration, the reader should either implicitly substitute fiber sequence, or replace the topological spaces with weakly equivalent simplicial sets and substitute Kan fibration.

### *Manifolds with boundary*

There are several extensions of parametrized isotopy extension to manifolds with boundary. Firstly, we can allow the boundary  $\partial M$  of  $M$  to move in  $\partial N$  as well, that is, as long as it always maps to the boundary of  $N$ .

**Corollary 8.1.12.** *Given a compactly-supported isotopy  $g: M \times \Delta^k \rightarrow N \times \Delta^k$  of neat embeddings, there exists a compactly-supported isotopy of diffeomorphisms  $f: N \times \Delta^k \rightarrow N \times \Delta^k$  such that  $g_t = f_t \circ g_0$ .*

*Sketch of proof.* First apply parametrized isotopy extension to  $g|_{\partial M \times \Delta^k}: \partial M \times \Delta^k \rightarrow \partial N \times \Delta^k$  to obtain  $f^\partial: \partial N \times \Delta^k \rightarrow \partial N \times \Delta^k$ . The neatness assumption means that we can extend all the vector fields used to build  $f^\partial$  to  $N$ , so this extends to an  $f: N \times \Delta^k \rightarrow N \times \Delta^k$ . Now  $f^{-1} \circ g$  satisfies the assumptions of Theorem 8.1.7.  $\square$

Secondly, it is also acceptable if  $M$  (including its boundary  $\partial M$ ) maps to the interior of  $N$ .

**Corollary 8.1.13.** *Given a compactly-supported isotopy  $g: M \times \Delta^k \rightarrow \text{int}(N) \times \Delta^k$  of embeddings, there exists a compactly-supported isotopy of diffeomorphisms  $f: N \times \Delta^k \rightarrow N \times \Delta^k$  such that  $g_t = f_t \circ g_0$ .*

*Sketch of proof.* First apply parametrized isotopy extension to  $g|_{\partial M \times \Delta^k}$ , to obtain  $f^\partial: N \times \Delta^k \rightarrow N \times \Delta^k$ . Then  $f^\partial \circ g$  fixes  $\partial M$  pointwise. By a version of the argument used to show that  $\text{Diff}_\partial(M) \simeq \text{Diff}_{\partial, U}(M)$ , one may deform this through ambient isotopy so that it fixes an open neighborhood of  $\partial M$  pointwise. Cut out a small neighborhood of the image of  $\partial M$  and apply parametrized isotopy extension again.  $\square$





# 9

## Embeddings of Euclidean space

In the previous chapter we proved parametrized isotopy extension. This was one step on the argument started in Chapter 7 deducing  $\text{Diff}(S^2) \simeq O(3)$  from Smale's theorem  $\text{Diff}_\partial(D^2) \simeq *$ . Today we shall finish this argument by computing the homotopy type of the space of embeddings of  $\mathbb{R}^m$  into  $M$ . This shall be used many more times in later chapters.

### 9.1 Embeddings of $\mathbb{R}^m$

It shall be useful to describe the homotopy type of the space of embeddings of  $\mathbb{R}^m$  into an  $m$ -dimensional manifold  $M$ .

#### Embeddings of $\mathbb{R}^m$ into $\mathbb{R}^m$

We start with the case where the target is also  $\mathbb{R}^m$ , and along the way determine the homotopy type of  $\text{Diff}(\mathbb{R}^m)$ .

**Theorem 9.1.1.** *The inclusions  $O(m) \hookrightarrow \text{GL}_m(\mathbb{R}) \hookrightarrow \text{Diff}(\mathbb{R}^m) \hookrightarrow \text{Emb}(\mathbb{R}^m, \mathbb{R}^m)$  are all weak equivalences.*

*Proof.* We start with the inclusion  $\text{GL}_m(\mathbb{R}) \hookrightarrow \text{Emb}(\mathbb{R}^m, \mathbb{R}^m)$ . Firstly, by translation, we may deformation retract  $\text{Emb}(\mathbb{R}^m, \mathbb{R}^m)$  onto the subspace  $\text{Emb}_0(\mathbb{R}^m, \mathbb{R}^m)$  of embeddings that fix the origin. This fixes the subspace  $\text{GL}_m(\mathbb{R}) \subset \text{Emb}(\mathbb{R}^m, \mathbb{R}^m)$  pointwise.

Next we shall prove that every commutative diagram

$$\begin{array}{ccc} S^i & \longrightarrow & \text{GL}_m(\mathbb{R}) \\ \downarrow & & \downarrow \\ D^{i+1} & \xrightarrow{H} & \text{Emb}_0(\mathbb{R}^m, \mathbb{R}^m) \end{array}$$

may be homotoped through commutative diagrams, to one in which there exists a lift. To do so, we first deform  $H$  into subspace of

Takeaways:

- $\text{Emb}(D^m, M) \simeq \text{Emb}(\mathbb{R}^m, M) \simeq \text{Fr}^{\text{GL}}(TM)$ .
- As the stabilizer of the action of  $\text{Diff}(S^2)$  on  $\text{Emb}(D^2, S^2)$  is  $\text{Diff}_\partial(D^2)$ , we obtain  $\text{Diff}(S^2) \simeq O(3)$ .

The observant reader may have noticed that there is a shorter proof of Theorem 9.1.1; by taking for an embedding  $h$  the family

$$[1, \infty] \mapsto \begin{cases} \frac{1}{\tau} \cdot h(\tau \cdot -) & \text{if } \tau < \infty, \\ D_0 h & \text{if } \tau = \infty. \end{cases}$$

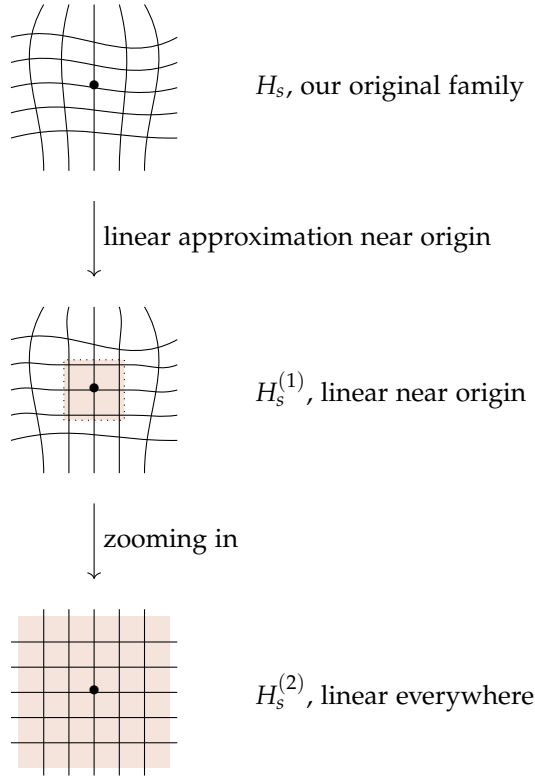

Figure 9.1: An outline for the strategy for Theorem 9.1.1.

$\text{Emb}_0(\mathbb{R}^m, \mathbb{R}^m)$  of embeddings that are linear near the origin. This uses a linear interpolation cut off using a small enough bump function supported near the origin in  $\mathbb{R}^m$ , and preserves  $\text{GL}_m(\mathbb{R})$ .

Let  $\eta: \mathbb{R}^m \rightarrow [0, 1]$  be a smooth function that equals 1 near the origin and is supported in  $D^m$ . By compactness of  $D^{i+1}$  and the inverse function theorem, one proves that there exists an  $\epsilon_0 > 0$  such that for all  $s \in D^{i+1}$ , we have that

$$[0, 1] \ni \tau \mapsto (1 - \tau\eta(-/\epsilon_0)) \cdot H_s + \tau\eta(-/\epsilon_0) \cdot D_0H_s$$

is a path of embeddings. At  $\tau = 0$ , it is  $H_s$ , At  $\tau = 1$ , near the origin it is the linear map  $D_0H_s$ . This deformation fixes  $\text{GL}_m(\mathbb{R})$  pointwise. Let us call the end result  $H^{(1)}: D^{i+1} \rightarrow \text{Emb}_0(\mathbb{R}^n, \mathbb{R}^n)$ .

Finally, we push out the non-linear stuff to  $\infty$  by precomposing with a family of scaling maps. For  $\lambda \in (0, \infty)$ , let  $r_\lambda$  denote the scaling map  $x \mapsto \lambda \cdot x$ . Then the following is a homotopy of embeddings ending at linear maps

$$[0, 1] \ni \tau \mapsto \begin{cases} r_{\frac{1}{1-\tau}} \circ H_s^{(1)} \circ r_{1-\tau} & \text{if } \tau < 1 \\ D_0H_s^{(1)} & \text{otherwise,} \end{cases}$$

which again fixes  $\text{GL}_m(\mathbb{R})$  pointwise. This completes the proof that  $\text{GL}_m(\mathbb{R}) \hookrightarrow \text{Emb}(\mathbb{R}^m, \mathbb{R}^m)$  is a weak equivalence. (Remark it was

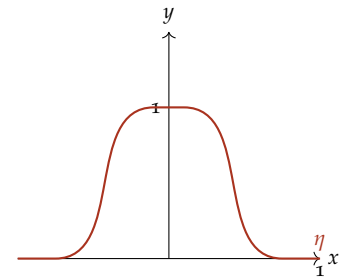

Figure 9.2: The smooth function  $\eta$  in the case  $m = 1$ .

important here that we used the weak Whitney topology of the strong one, otherwise this homotopy of embeddings would not be continuous.)

All of these deformations preserve the subspace  $\text{Diff}_0(\mathbb{R}^m)$  of diffeomorphisms fixing the origin, which is easily seen to be a deformation retract of  $\text{Diff}(\mathbb{R}^m)$ , so it also proves  $\text{GL}_m(\mathbb{R}) \hookrightarrow \text{Diff}(\mathbb{R}^m)$  is a weak equivalence. Finally,  $O(m) \hookrightarrow \text{GL}_m(\mathbb{R})$  is a weak equivalence by Gram-Schmidt.  $\square$

The map  $\text{Emb}(\mathbb{R}^m, \mathbb{R}^m) \rightarrow \text{GL}_m(\mathbb{R})$  taking the derivative at 0 is a weak homotopy inverse to  $\text{GL}_m(\mathbb{R}) \hookrightarrow \text{Emb}(\mathbb{R}^m, \mathbb{R}^m)$ . to see this, note that  $\text{GL}_m(\mathbb{R}) \rightarrow \text{Emb}(\mathbb{R}^m, \mathbb{R}^m) \rightarrow \text{GL}_m(\mathbb{R})$  is the identity map.

### Embeddings into $M$

Now we generalize the target to  $M$ . Note that taking the value and derivative at the origin gives us a map

$$\text{Emb}(\mathbb{R}^m, M) \rightarrow \text{Fr}^{\text{GL}}(TM).$$

**Theorem 9.1.2.** *The map  $\text{Emb}(\mathbb{R}^m, M) \rightarrow \text{Fr}^{\text{GL}}(TM)$  is a weak equivalence.*

*Proof.* There is a commutative diagram

$$\begin{array}{ccc} \text{Emb}(\mathbb{R}^m, M) & \longrightarrow & \text{Fr}^{\text{GL}}(TM) \\ \downarrow \text{ev}_0 & & \downarrow \pi \\ M & \xlongequal{\quad\quad\quad} & M, \end{array}$$

the first of which is a fibration by parametrized isotopy extension and the second of which is a fibration since it is the projection of a locally trivial bundle. Thus it suffices to prove that the map on fibers over  $p \in M$  is a weak equivalence. By shrinking in the  $\mathbb{R}^m$  direction, we may assume we always land in some fixed chart around  $p \in M$ . This reduces the proof to the statement that the derivative map  $\text{Emb}_0(\mathbb{R}^m, \mathbb{R}^m) \rightarrow \text{GL}_m(\mathbb{R})$  is a weak equivalence, which we proved above.  $\square$

This also allows us to compute the homotopy type of  $\text{Emb}(D^m, M)$ . The following is a generalization of a result on diffeomorphisms from Section 7.1. Note we do not need a compactness assumption in this case.

**Lemma 9.1.3.** *Given  $m$ -dimensional manifolds  $M$  and  $M'$  with embeddings  $i: M \rightarrow M'$  and  $j: M' \rightarrow M$  that are inverse up to isotopy, the spaces of embeddings  $\text{Emb}(M, N)$  and  $\text{Emb}(M', N)$  are homotopy equivalent.*

**Corollary 9.1.4.** *The restriction map  $\text{Emb}(\mathbb{R}^m, M) \rightarrow \text{Emb}(D^m, M)$  is a homotopy equivalence.*

### Generalization to embeddings of $\mathbb{R}^k$

We shall state the generalization of the results of the previous section to embeddings of  $\mathbb{R}^k$  into  $M$ , where  $k < m$ . Let  $\text{GL}(\mathbb{R}^k, \mathbb{R}^m)$  be the space of injective linear maps  $\mathbb{R}^k \rightarrow \mathbb{R}^m$ , and  $O(\mathbb{R}^k, \mathbb{R}^m)$  the space of linear isometries  $\mathbb{R}^k \rightarrow \mathbb{R}^m$ . Then Theorem 9.1.1 generalizes to

**Theorem 9.1.5.** *The inclusions*

$$O(\mathbb{R}^k, \mathbb{R}^m) \hookrightarrow \text{GL}(\mathbb{R}^k, \mathbb{R}^m) \hookrightarrow \text{Emb}(\mathbb{R}^k, \mathbb{R}^m)$$

are all weak equivalences. Taking the derivative at 0 gives a homotopy inverse  $\text{Emb}(\mathbb{R}^k, \mathbb{R}^m) \rightarrow \text{GL}(\mathbb{R}^k, \mathbb{R}^m)$  to the latter map.

Just like the orthonormal and general linear frame bundles generalize  $O(m)$  and  $\text{GL}_m(\mathbb{R})$ , the orthonormal and general linear Stiefel bundles generalize  $O(\mathbb{R}^k, \mathbb{R}^m)$  and  $\text{GL}(\mathbb{R}^k, \mathbb{R}^m)$ . These may be defined as associated bundles for the orthogonal and general linear frame bundles. This uses that there are right actions of  $O(m)$  on  $O(\mathbb{R}^k, \mathbb{R}^m)$ , and  $\text{GL}_m(\mathbb{R})$  on  $\text{GL}(\mathbb{R}^k, \mathbb{R}^m)$ :

$$\begin{aligned} V_k^O(M) &:= O(\mathbb{R}^k, \mathbb{R}^m) \times_{O(m)} \text{Fr}^O(TM), \\ V_k^{\text{GL}}(M) &:= \text{GL}(\mathbb{R}^k, \mathbb{R}^m) \times_{\text{GL}_m(\mathbb{R})} \text{Fr}^{\text{GL}}(TM). \end{aligned}$$

Recording the value and derivative at the origin gives a map  $\text{Emb}(\mathbb{R}^k, M) \rightarrow V_k^{\text{GL}}(M)$ .

**Theorem 9.1.6.** *The map  $\text{Emb}(\mathbb{R}^k, M) \rightarrow V_k^{\text{GL}}(M)$  is a weak equivalence.*

## 9.2 Connected sums

We shall give a classical corollary of Theorem 9.1.1: by combining it with isotopy extension, we can prove a result of Palais on the well-definedness of the *connected sum* operation [Pal60]. The input for this construction is a pair of path-connected oriented manifolds  $M, N$  of the same dimension. It is given by taking an orientation-preserving embedding  $\varphi_M: D^m \hookrightarrow M$ , and an orientation-reversing embedding  $\varphi_N: D^m \hookrightarrow N$ . One then removes the interiors of their images, and glues the resulting manifolds along their boundary using the identity.

**Definition 9.2.1.** The *connected sum*  $M \# N$  is given by

$$(M \setminus \varphi_M(\text{int } D^m)) \cup (N \setminus \varphi_N(\text{int } D^m)),$$

where we identify

$$\partial(M \setminus \varphi_M(\text{int } D^m)) \cong S^{m-1} \quad \text{and} \quad \partial(N \setminus \varphi_N(\text{int } D^m)) \cong S^{m-1}$$

via the identity map.

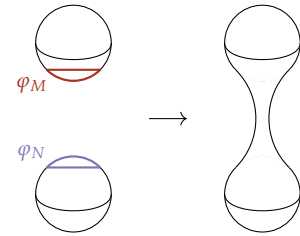

Figure 9.3: A connected sum.

The connected sum  $M\#N$  is again an oriented manifold, this was the reason for choosing one embedding to be orientation-preserving and the other to be orientation-reversing. Of course the construction  $M\#N$  depends on the choice of  $\varphi_M$  and  $\varphi_N$ , and if we want to remember this in the notation we write  $M\#_{\varphi_M, \varphi_N} N$ . We shall show that  $M\#N$  is well-defined up to diffeomorphism.

**Lemma 9.2.2.** *If  $\varphi_M$  is isotopic to  $\varphi'_M$ , then  $M\#_{\varphi_M, \varphi_N} N$  is diffeomorphic to  $M\#_{\varphi'_M, \varphi_N} N$ .*

*Proof.* By isotopy extension there is a diffeomorphism  $f: M \rightarrow M$  such that  $f \circ \varphi_M = \varphi'_M$ . This induces a diffeomorphism

$$f\#\text{id}: M\#_{\varphi_M, \varphi_N} N \rightarrow M\#_{\varphi'_M, \varphi_N} N$$

$$p \mapsto \begin{cases} f(p) & \text{if } p \in M \setminus \varphi_M(\text{int}(D^m)), \\ p & \text{otherwise,} \end{cases}$$

where we use  $f \circ \varphi_M = \varphi'_M$  to see that this is well-defined.  $\square$

By symmetry the same is true when we modify  $\varphi_N$  by an isotopy. Thus to show that  $M\#N$  is well-defined, it suffices to show that the spaces  $\text{Emb}^+(D^m, M)$  and  $\text{Emb}^+(D^m, N)$  of orientation-preserving embeddings are path-connected. If so, the same is true for the space of orientation-reversing embeddings because it is homeomorphic.

**Lemma 9.2.3.** *If  $M$  is path-connected and oriented,  $\text{Emb}^+(D^m, M)$  is path-connected.*

*Proof.* We computed above that  $\text{Emb}^+(D^m, M) \simeq \text{Fr}^{SO}(M)$ , and the latter fits into a fiber sequence

$$SO(m) \rightarrow \text{Fr}^{SO}(M) \rightarrow M,$$

with both fiber and base path-connected.  $\square$

### 9.3 Diffeomorphisms of $S^2$ revisited

In Chapter 7, we showed that  $\text{Diff}(S^2) \cong O(3) \times G$ , with  $G$  similar to  $\text{Diff}_{\partial}(D^2)$ , and claimed that in fact there is a weak equivalence  $\text{Diff}(S^2) \simeq O(3)$ . This result is originally due to Smale [Sma59b].

**Theorem 9.3.1.** *We have that  $\text{Diff}(S^2) \simeq O(3)$ .*

*Proof.* The map  $\text{Diff}(S^2) \rightarrow O(3)$  factors as

$$\text{Diff}(S^2) \rightarrow \text{Emb}(D^2, S^2) \rightarrow \text{Emb}(\mathbb{R}^2, S^2) \rightarrow \text{Fr}^{\text{GL}}(TS^2) \rightarrow \text{Fr}^O(TS^2),$$

with all except the first map weak equivalences. Hence it suffices to show that the homotopy fiber of  $\text{Diff}(S^2) \rightarrow \text{Emb}(D^2, S^2)$  is a weakly contractible. But this map is a fibration by parametrized isotopy extension and its fiber is the contractible space  $\text{Diff}_{\partial}(D^2)$ .  $\square$



## Gramain's proof of Smale's theorem

In Chapter 7, we proved Smale's theorem that  $\text{Diff}_\partial(D^2) \simeq *$ . We will now give a different proof due to Gramain (based on a proof of Cerf in [Cer68]). It has the advantage of avoiding dynamics in the form of the Poincaré-Bendixson theorem, instead using that  $O(2)$  has few homotopy groups and the parametrized isotopy extension theorem. The proof appears in [Gra73], but we instead follow Hatcher's exposition [Hat11] (which I highly recommend).

**Convention 10.0.1.** Having spend a few lectures discussing how various boundary conditions do not affect the homotopy type, we shall henceforth not distinguish between them.

### 10.1 Gramain's proof of Smale's theorem

We shall prove that  $\text{Diff}_\partial(D^2)$  is weakly contractible by letting it act on the arc  $\gamma_0$  in  $D^2 \subset \mathbb{R}^2$  connecting  $-\vec{e}_2$  and  $\vec{e}_2$ , see Figure 10.1. By parametrized isotopy extension as discussed in Chapter 8, we obtain a fibration

$$\text{Diff}_\partial(D^2) \rightarrow \text{Emb}_\partial(I, D^2).$$

Its fiber over  $\gamma_0$  is given by those diffeomorphisms that fix  $\gamma_0$  pointwise. Since both components of the complement of  $\gamma_0$  are disks, up to smoothing corners, this is weakly equivalent to  $\text{Diff}_\partial(D^2) \times \text{Diff}_\partial(D^2)$ .<sup>1</sup>

**Remark 10.1.1.** In the above paragraph, we strictly speaking should have used simplicial sets of diffeomorphisms that are the identity near  $\partial D^2$  and embeddings that equal  $\gamma_0$  near  $\partial I$  to apply parametrized isotopy extension. Then the fiber over  $\gamma_0$  would have been a simplicial set of diffeomorphisms that fix  $\gamma_0$  and a neighborhood of  $\partial D^2$  pointwise, which is weakly equivalent  $\text{Diff}_\partial(D^2) \times \text{Diff}_\partial(D^2)$  using the results of Chapters 4 and 5. These technical details are tedious and easy to provide.

Takeaways:

- That  $\text{Diff}_\partial(D^2) \simeq *$  is equivalent to a space of embedded arcs being weakly contractible, which can be deduced from the fact that  $O(2)$  only has non-trivial  $\pi_0$  and  $\pi_1$ .
- The same techniques prove that the path-components of  $\text{Emb}_\partial(I, \Sigma)$  are weakly contractible for any surface  $\Sigma$  with compact boundary components.
- This implies the diffeomorphism groups of most surfaces have weakly contractible components.

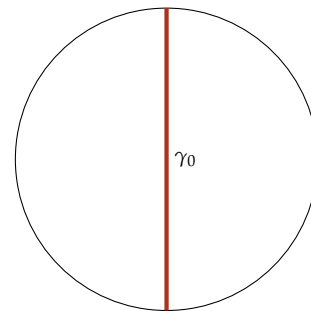

Figure 10.1: The arc  $\gamma_0$  in  $D^2$ .

<sup>1</sup> This strategy is a slight deviation from Hatcher's proof in [Hat11], who lets  $\text{Diff}_\partial(D^2)$  act on  $\text{Emb}_{\partial^+}(D_+^2, D^2)$ .

Now consider the long exact sequence of homotopy groups, based at the identity in the total space  $\text{Diff}_\partial(D^2)$ . Restricting to the relevant components of the base (the one containing  $\gamma_0$ ) and total space (the identity), in low degrees this is the exact sequence of groups

$$\begin{array}{c} \pi_1(\text{Diff}_\partial(D^2))^2 \longrightarrow \pi_1(\text{Diff}_\partial(D^2)) \longrightarrow \pi_1(\text{Emb}_\partial^{[\gamma_0]}(I, D^2)) \\ \left. \begin{array}{c} \longleftarrow \\ \longleftarrow \\ \longleftarrow \end{array} \right\} \\ \longrightarrow \{(g, g^{-1})\} \longrightarrow \{\text{id}\} \longrightarrow \{[\gamma_0]\}, \end{array}$$

with  $g \in \pi_0(\text{Diff}_\partial(D^2))$  and  $\text{Emb}_{[\gamma_0], \partial}(I, D^2)$  denotes the path component of  $\text{Emb}_\partial(I, D^2)$  containing  $\gamma_0$ . We have also slightly simplified notation by leaving out the path components we restrict to in  $\pi_1$  of the diffeomorphism groups (since it doesn't matter anyway).

Thus  $\pi_0(\text{Diff}_\partial(D^2))$  is trivial if the path component of  $\text{Emb}_\partial^{[\gamma_0]}(I, D^2)$  is simply-connected. For the higher homotopy groups  $\text{Diff}_\partial(D^2)$  there is a long exact sequence of abelian groups

$$\cdots \longrightarrow \pi_i(\text{Diff}_\partial(D^2))^{\oplus 2} \longrightarrow \pi_i(\text{Diff}_\partial(D^2)) \longrightarrow \pi_i(\text{Emb}_\partial^{[\gamma_0]}(I, D^2)) \longrightarrow \cdots$$

←-----

There is a section up to homotopy  $\text{Diff}_\partial(D^2) \rightarrow \text{Diff}_\partial(D^2)^2$  given by  $f \mapsto f \times \text{id}$ , which induces the dashed arrow. This implies that the long exact sequence splits into a collection of split short exact sequences and for  $i \geq 1$  we get an isomorphism of abelian groups

$$\pi_i(\text{Diff}_\partial(D^2)) \cong \pi_{i+1}(\text{Emb}_\partial^{[\gamma_0]}(I, D^2)).$$

The conclusion is that the higher homotopy groups of  $\text{Diff}_\partial(D^2)$  vanish if and only if the path component of  $\text{Emb}_\partial(I, D^2)$  containing  $\gamma_0$  is weakly contractible. We have thus reduced Smale's theorem to the following statement:

**Theorem 10.1.3** (Equivalent to Smale's theorem). *The path component  $\text{Emb}_\partial^{[\gamma_0]}(I, D^2)$  of  $\text{Emb}_\partial(I, D^2)$  containing  $\gamma_0$  is weakly contractible.*

*Proof.* Consider the manifold  $T$  given by gluing a 1-handle  $[-1, 1] \times I$  to  $\partial D^2$  containing both components of  $\partial D^2 \setminus \partial \gamma_0$  as in Figure 10.2. It is diffeomorphic to the manifold obtained by removing the disk  $S$  from a larger 2-disk  $(D^2)'$ .

We shall study embeddings of  $I \cup S$  into  $(D^2)'$  that send  $0 \in I$  to the boundary. Even though  $I \cup S$  is not a manifold, but one can still prove that a version of parametrized isotopy extension is true for it by applying ordinary parametrized isotopy extension first to  $S$  and then to  $I$ . We conclude that we have a fiber sequence

$$\text{Emb}_\partial(I, T) \rightarrow \text{Emb}_\partial(I \cup S, (D^2)') \rightarrow \text{Emb}(S, (D^2)'). \quad (10.1)$$

**Remark 10.1.2.** Note that we do not claim that  $\text{Emb}_\partial(I, D^2)$  is path-connected, though this is true. This follows from the smooth 2-dimensional Schoenflies theorem, which we will prove next chapter.

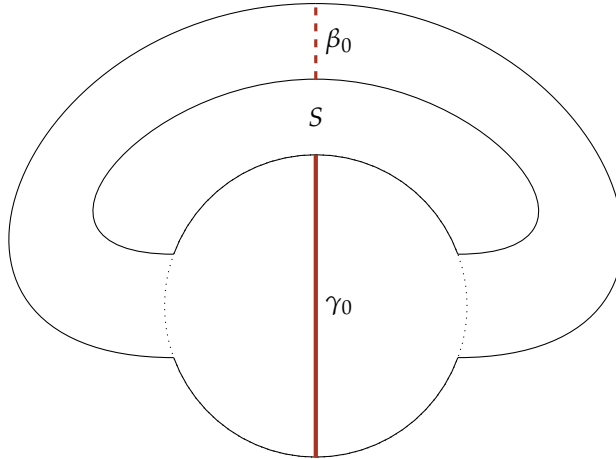

Figure 10.2: The surface  $T$ , diffeomorphic to an annulus.

As  $S \cong D^2$ , the results of the previous lecture say that the base  $\text{Emb}(S, (D^2)')$  is weakly equivalent to  $O(2)$ . We next claim that  $\text{Emb}_\partial(I \cup S, (D^2)')$  is weakly contractible. To see this, “drag the lollipop into the part where the embedding is the identity.” Firstly, precomposition  $I \hookrightarrow I \cup S$  induces a weak equivalence  $\text{Emb}_\partial(I \cup S, (D^2)') \rightarrow \text{Emb}_\partial(I, (D^2)')$  by techniques as in the previous lecture. Next, we may use a collar as in Lecture 3 to replace any compact family in  $\text{Emb}_\partial(I \cup S, (D^2)')$  by one that coincides with  $\gamma_0$  on half of  $I$ . Then by precomposing with self-embeddings  $I \rightarrow I$  fixing  $\{0\}$ , we can homotope this compact family to one equal to constant map given by a small vertical line segment.

From the long exact sequence of homotopy groups for (10.1) and the fact that  $\pi_i(O(2)) = 0$  for  $i > 1$ , it thus follows that  $\pi_i(\text{Emb}_\partial(I, T)) = 0$  for  $i > 0$  and base point in *any* path component.

We shall now use this to prove that  $\text{Emb}_\partial^{[\gamma_0]}(I, D^2)$  is weakly contractible. Let  $\beta_0 = \{0\} \times I$  denote the so-called *core* of the added 1-handle. As  $D^2$  and  $T \setminus \beta_0$  are isotopy equivalent, there is a homotopy equivalence  $\text{Emb}_\partial^{[\gamma_0]}(I, D^2) \simeq \text{Emb}_\partial^{[\gamma_0]}(I, T \setminus \beta_0)$  and it suffices to prove the latter is weakly contractible. We then remark that there is an inclusion

$$\iota: \text{Emb}_\partial^{[\gamma_0]}(I, T \setminus \beta_0) \hookrightarrow \text{Emb}_\partial^{[\gamma_0]}(I, T),$$

which we claim induces an injection on homotopy groups. Once we establish this claim, we have finished the proof because we showed that latter has vanishing higher homotopy groups; only trivial groups inject into the trivial group.

To prove the claim we consider the universal cover  $\tilde{T}$  of  $T$ . We can identify this explicitly; it is diffeomorphic to  $\mathbb{R} \times I$ , and we may pick

coordinates such that  $\beta_0$  lifts to the arcs  $\{2i + 1\} \times I$  and a lift  $\tilde{\gamma}_0$  of  $\gamma_0$  is given by the arc  $\{0\} \times I$  (of course there are other choices, we pick one). An arc  $\gamma \in \text{Emb}_\partial^{[\gamma_0]}(I, T \setminus \beta_0)$  has a unique lift  $\tilde{\gamma}$  which coincides with  $\tilde{\gamma}_0$  at 0. Hence we may identify  $\text{Emb}_\partial^{[\gamma_0]}(I, T)$  with a subspace

$$E \subset \text{Emb}_\partial^{[\tilde{\gamma}_0]}(I, \mathbb{R} \times I).$$

Similarly, we may identify  $\text{Emb}_\partial^{[\gamma_0]}(I, T \setminus \beta_0)$  with the subspace

$$\text{Emb}_\partial^{[\tilde{\gamma}_0]}(I, (-1, 1) \times I) \subset \text{Emb}_\partial^{[\tilde{\gamma}_0]}(I, \mathbb{R} \times I).$$

There is a retraction  $r: \text{Emb}_\partial^{[\tilde{\gamma}_0]}(I, \mathbb{R} \times I) \rightarrow \text{Emb}_\partial^{[\tilde{\gamma}_0]}(I, (-1, 1) \times I)$  by precomposition with an embedding  $\mathbb{R} \hookrightarrow (-1, 1)$ , i.e. shrinking the  $\mathbb{R}$ -direction. We conclude that there is a homotopy commutative diagram

$$\begin{array}{ccc} \text{Emb}_\partial^{[\gamma_0]}(I, T \setminus \beta_0) & \xleftarrow{\iota} & \text{Emb}_\partial^{[\gamma_0]}(I, T) \\ \parallel & & \downarrow \cong \\ \text{Emb}_\partial^{[\gamma_0]}(I, T \setminus \beta_0) & \xleftarrow{r} & \text{Emb}_\partial^{[\tilde{\gamma}_0]}(I, \mathbb{R} \times I) \end{array} \quad \begin{array}{c} \nearrow \\ \searrow \\ E \end{array}$$

which establishes the claim.  $\square$

**Remark 10.1.4.** Why does this argument fail in higher dimensions? To make the argument go through,  $T$  should have been obtained by attaching a 1-handle to the boundary of  $D^n$ . But then the base we would be studying in our generalization of (10.1) involves the space of embeddings of a complementary  $D^{n-2} \times D^2$  rel  $\partial D^{n-2} \times D^2$  into  $D^n$ . These spaces of embeddings will be highly non-trivial in general.

## 10.2 Path-components of embeddings of arcs in surfaces

We shall now generalize the results of the previous sections from arcs in  $D^2$  to arcs in a surface  $\Sigma$  with non-empty boundary, whose boundary components are compact (hence circles). We have already done most of the work, and only need to replace  $D^2$  with  $\Sigma$  in the arguments.

We fix two points  $x_0, x_1$  in  $\partial\Sigma$ , and a smoothly embedded arc  $\gamma_0$  in  $\Sigma$  between them. Let  $\text{Emb}_\partial^{[\gamma_0]}(I, \Sigma)$  denote the path-component of  $\text{Emb}_\partial(I, \Sigma)$  containing  $\gamma_0$ .

**Lemma 10.2.1.** *If  $x_0$  and  $x_1$  do not lie in the same boundary component, then  $\text{Emb}_\partial^{[\gamma_0]}(I, \Sigma)$  is weakly contractible.*

*Proof.* The proof in the first part of Theorem 10.1.3 works. One defines  $\Sigma'$  as the surface obtained by gluing a disk  $S$  to the boundary component containing  $x_1$ . Analogous to (10.1), we obtain a fiber sequence

$$\text{Emb}_{\partial, U}(I, \Sigma) \rightarrow \text{Emb}_{\partial, U}(I \cup S, \Sigma') \rightarrow \text{Emb}(S, \Sigma') \quad (10.2)$$

where again  $\text{Emb}_{\partial, U}(I \cup S, \Sigma')$  is weakly contractible and now there is a weak equivalence  $\text{Emb}(S, \Sigma') \simeq \text{Fr}^O(T\Sigma')$ . The space  $\text{Fr}^O(T\Sigma')$  has vanishing  $\pi_i$  for  $i > 1$  using the long exact sequence of homotopy groups associated to the fiber sequence

$$O(2) \rightarrow \text{Fr}^O(T\Sigma') \rightarrow \Sigma',$$

using that  $\pi_i(\Sigma') = 0$  for  $i > 1$  since  $\Sigma'$  is a path-connected surface with non-empty boundary. As before, the long exact sequence of homotopy groups for (10.2) implies the lemma.  $\square$

**Lemma 10.2.2.** *If  $x_0$  and  $x_1$  lie in the same boundary then,  $\text{Emb}_{\partial}^{[\gamma_0]}(I, \Sigma)$  is weakly contractible.*

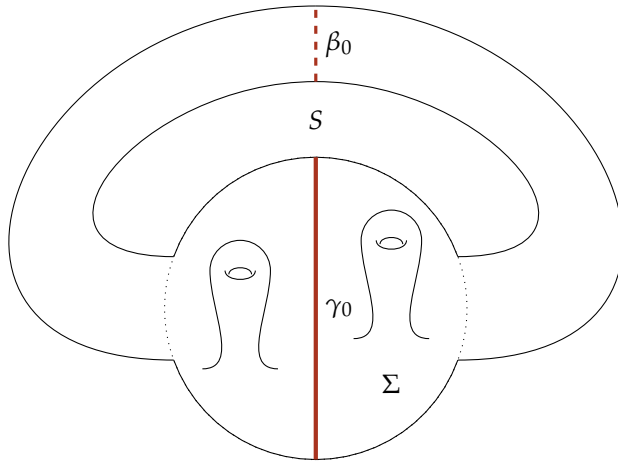

Figure 10.3: The surface  $T$ , in the case diffeomorphic to the boundary connected sum of a genus 2 surface  $\Sigma$  with boundary component, and an annulus.

*Proof.* If  $\partial_0\Sigma$  denote the path-component of  $\partial\Sigma$  containing  $x_0, x_1$ , and glue a 1-handle  $[-1, 1] \times I$  via  $\{-1, 1\} \times I$  to both components of  $\partial_0\Sigma \setminus \{x_0, x_1\}$  to obtain surface similar to  $T$ .

Let  $\beta_0$  denote the core  $\{0\} \times I$  of this handle, then we have that  $\text{Emb}_{\partial}^{[\gamma_0]}(I, \Sigma) \simeq \text{Emb}_{\partial}^{[\gamma_0]}(I, T \setminus \beta_0)$ . As before we claim that

$$\iota: \text{Emb}_{\partial}^{[\gamma_0]}(I, T \setminus \beta_0) \hookrightarrow \text{Emb}_{\partial}^{[\gamma_0]}(I, T)$$

is injective on higher homotopy groups. Since in  $T$ ,  $\gamma_0$  goes between two *different* boundary components, Lemma 10.2.1 says that its higher

homotopy groups vanish, and establishing the claim would imply the lemma.

To do so, note that  $\pi_1(T) \cong \pi_1(\Sigma) * \mathbb{Z}$  and let  $\tilde{T}$  denote the cover corresponding to the summand  $\pi_1(\Sigma)$ . That is,  $\pi_1(\tilde{T}) \cong \pi_1(\Sigma)$ . This is obtained by cutting  $T$  along  $\beta_0$  to get a surface  $U$  with two copies  $\beta_0^{(1)}$  and  $\beta_0^{(2)}$  of  $\beta_0$  in its boundary, letting  $\tilde{U}$  denote its universal cover (which is contractible), and writing

$$\tilde{T} := \tilde{U} \cup U \cup \tilde{U}$$

where we identify  $\beta_0^{(1)}$  with a lift of  $\beta_0^{(2)}$  in the first copy of  $\tilde{U}$ , and  $\beta_0^{(2)}$  with a lift of  $\beta_0^{(1)}$  in the second copy of  $\tilde{U}$ .

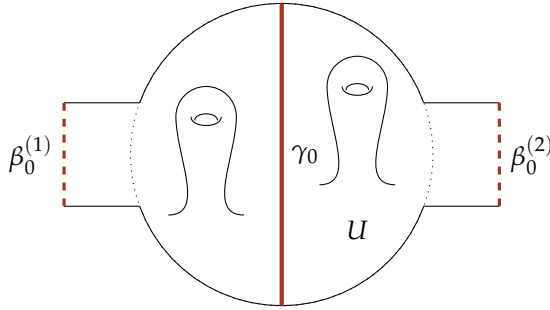

Figure 10.4: The surface  $U$ .

After picking a lift  $\tilde{\gamma}_0$  of  $\gamma_0$ , we may identify  $\text{Emb}_\partial^{[\gamma_0]}(I, T)$  with a subspace of  $\text{Emb}_\partial^{[\tilde{\gamma}_0]}(I, \tilde{T})$  and  $\text{Emb}_\partial^{[\gamma_0]}(I, T \setminus \beta_0)$  with  $\text{Emb}_\partial^{[\gamma_0]}(I, U)$ . As before, we may give a retraction  $r: \text{Emb}_\partial^{[\tilde{\gamma}_0]}(I, \tilde{T}) \rightarrow \text{Emb}_\partial^{[\gamma_0]}(I, U)$ . We conclude that there is a homotopy commutative diagram

$$\begin{array}{ccc}
 \text{Emb}_\partial^{[\gamma_0]}(I, T \setminus \beta_0) & \xleftarrow{\iota} & \text{Emb}_\partial^{[\gamma_0]}(I, T) \\
 \parallel & & \downarrow \cong \\
 \text{Emb}_\partial^{[\gamma_0]}(I, T \setminus \beta_0) & \xleftarrow{r} & \text{Emb}_\partial^{[\tilde{\gamma}_0]}(I, \tilde{T})
 \end{array}
 \begin{array}{c}
 \nearrow \\
 E \\
 \nwarrow
 \end{array}$$

which establishes the claim. □

### 10.3 Path-components of diffeomorphism groups of surfaces

We may use the previous results to prove a version of the Earle-Eels theorem [EE67]. We are going to assume the classification of compact oriented smooth surfaces.

**Theorem 10.3.1.** *Let  $\Sigma$  be a compact path-connected oriented surface with non-empty boundary. Then the path-components of  $\text{Diff}_\partial(\Sigma)$  are weakly contractible.*

*Proof.* It suffices to prove that the path component of the identity is weakly contractible. The proof is by induction over the genus  $g$  and number  $n$  of boundary components, in lexicographic order. The initial case  $(g, n) = (0, 1)$  is the disk, which we have proven already. Let  $\gamma_0: I \rightarrow \Sigma$  be a non-trivial arc (i.e. it does not isotopic to an arc in the boundary). Then there is a fiber sequence

$$\mathrm{Diff}_{\partial, U}^{\mathrm{id}}(\Sigma_{\gamma_0}) \rightarrow \mathrm{Diff}_{\partial, U}^{\mathrm{id}}(\Sigma) \rightarrow \mathrm{Emb}_{\partial}^{[\gamma_0]}(I, \Sigma)$$

where  $\Sigma_{\gamma_0}$  is the surface  $\Sigma$  cut upon along  $\gamma_0$  (so that there are two copies of  $\gamma_0$  in the boundary). This has lower genus  $g' < g$ , or equal genus  $g' = g$  and lower number  $n' < n$  of boundary components (the latter happens when  $\gamma_0$  connects two different boundary components, the former when it does not). Thus  $\mathrm{Diff}_{\partial, U}^{\mathrm{id}}(\Sigma_{\gamma_0})$  is weakly contractible by the induction hypothesis. But we have also proven that  $\mathrm{Emb}_{\partial}^{[\gamma_0]}(I, \Sigma)$  is weakly contractible. The long exact sequence of homotopy groups finishes the proof.  $\square$

We can extend this to closed surfaces:

**Theorem 10.3.3.** *Let  $\Sigma$  be a compact oriented surface of genus  $> 1$ . Then the path-components of  $\mathrm{Diff}(\Sigma)$  are weakly contractible.*

*Proof.* It again suffices to prove that the path-component of the identity is weakly contractible. We have a fiber sequence

$$\mathrm{Diff}_{\partial}(\Sigma \setminus \mathrm{int}(D^2)) \rightarrow \mathrm{Diff}(\Sigma) \rightarrow \mathrm{Emb}^+(D^2, \Sigma)$$

and we know that the fiber has weakly contractible components. The base is weakly equivalent to  $\mathrm{Fr}^{SO}(T\Sigma)$ , and we saw before that this implies its components only have non-vanishing  $\pi_1$  (this only needs  $g > 0$ ). Now an argument is needed that the map  $\pi_1(\mathrm{Emb}^+(D^2, \Sigma)) \rightarrow \pi_0(\mathrm{Diff}_{\partial}(\Sigma \setminus \mathrm{int}(D^2)))$  is injective (this needs  $g > 1$ ). This is a theorem of Birman, e.g. Theorem 4.6 of [FM12]. The long exact sequence of homotopy groups finishes the proof.  $\square$

**Remark 10.3.2.** What about  $g = 0, 1$ ? We saw before that  $\mathrm{Diff}(S^2)$  has two path-components, each of which homotopy equivalent to  $SO(3)$ . Since  $\mathbb{T}^2$  is itself a topological group, at least  $\mathbb{T}^2$  splits off  $\mathrm{Diff}(\mathbb{T}^2)$ . This is in fact the homotopy type of the identity component, and its path-components are given by  $SL_2(\mathbb{Z})$ , see e.g. Chapter 2 of [FM12].



## Hatcher's proof of the Smale conjecture

We gave two proofs that  $\text{Diff}_\partial(D^2)$  is weakly contractible. After reading a paper of Cerf, Smale conjectured that  $\text{Diff}_\partial(D^3)$  is weakly contractible as well. This was proven by Hatcher in [Hat83], after Cerf computed  $\pi_0(\text{Diff}_\partial(S^3)) \cong \pi_0(O(4))$  which amounts to computing  $\pi_0(\text{Diff}_\partial(D^3)) = 0$  [Cer68]. We shall not be able to give Hatcher's proof, but shall attempt to describe the approach and state some consequences. There is also an approach due to Eliashberg using contact geometry, the  $\pi_0$ -case of which is worked out in [GZ10].

### 11.1 A restatement of Smale's theorem

Hatcher did not directly prove that  $\text{Diff}_\partial(D^3)$  is contractible, like Smale did. Instead, the proof is more along the lines of Gramain's theorem, which leveraged a proof that a certain space of embeddings is contractible.

In this section we will use Smale's theorem to prove in dimension 2 the statement that Hatcher proved in dimension 3:

**Proposition 11.1.1.** *The restriction map  $\text{Emb}(D^2, \mathbb{R}^2) \rightarrow \text{Emb}(S^1, \mathbb{R}^2)$  is a weak equivalence.*

*Proof.* We shall let  $\text{Diff}(\mathbb{R}^2)$  act on the standard embedding of  $D^2$ , resp.  $S^1$ , into  $\mathbb{R}^2$ . This gives a commutative diagram

$$\begin{array}{ccc}
 \text{Diff}(\mathbb{R}^2) & \xlongequal{\quad} & \text{Diff}(\mathbb{R}^2) \\
 \downarrow & & \downarrow \\
 \text{Emb}(D^2, \mathbb{R}^2) & \xrightarrow{(*)} & \text{Emb}(S^1, \mathbb{R}^2),
 \end{array} \tag{11.1}$$

where both vertical maps are fibrations by parametrized isotopy extension. They are also surjections on  $\pi_0$ . For the left map this follows from the results of Lecture 7, and for the right map this follows from smooth 2-dimensional Schoenflies, proven below in

Takeaways:

- Smale's theorem together with 2-dimensional smooth Schoenflies is equivalent to the statement that  $\text{Emb}(D^2, \mathbb{R}^2) \rightarrow \text{Emb}(S^1, \mathbb{R}^2)$  is a weak equivalence.
- Hatcher's proof uses Morse theory to prove  $\text{Emb}(D^3, \mathbb{R}^3) \rightarrow \text{Emb}(S^2, \mathbb{R}^3)$  is a weak equivalence, which implies  $\text{Diff}_\partial(D^3) \simeq *$ .
- This may be used to prove 3-dimensional versions of the consequences of Smale's theorem.

Theorem 11.1.3. Thus it suffices to prove that the map on fibers over the standard embeddings is a weak equivalence; this map is given by

$$\text{id} \times \{\text{id}\}: \text{Diff}(\mathbb{R}^2 \text{ rel } D^2) \hookrightarrow \text{Diff}(\mathbb{R}^2 \text{ rel } D^2) \times \text{Diff}_\partial(D^2)$$

which is a weak equivalence by Smale's theorem.  $\square$

For completeness and later comparison with the three-dimensional case, let us prove the relative  $\pi_0$ -case, i.e. that the map (\*) is surjective on  $\pi_0$ , which amounts to proving smooth Schoenflies in dimension 2. We shall only be able to give a sketch, because the proof uses codimension one Morse theory, which we have not discussed yet. One may even take this as a motivation for the Morse theory that we will discuss in the next couple of lectures.

**Theorem 11.1.3** (Smooth Schoenflies in dimension 2). *Every smooth embedding  $\varphi: S^1 \hookrightarrow \mathbb{R}^2$  extends to a smooth embedding  $D^2 \hookrightarrow \mathbb{R}^2$ .*

We shall need the following basic consequences of Morse theory, to be discussed in Chapter ??; any smooth function  $f: S^1 \rightarrow \mathbb{R}$  admits an arbitrarily small perturbation to a smooth function  $g$  with the following properties:

- (i) The set of  $p \in S^1$  such that  $D_p g = 0$ , called *critical points*, is finite.
- (ii) The values  $g(p)$  for  $p$  a critical point, called *critical values*, are distinct.
- (iii) Near each critical point  $p$  there is a local coordinate  $x$  on  $S^1$  with  $p$  corresponding to  $x = 0$  such that  $g$  is given by  $g(x) = g(p) + \alpha x^2$  with  $\alpha \in \mathbb{R} \setminus \{0\}$ .

Such a function is said to be *generic Morse*.

*Sketch of proof.* We shall ignore most issues involving corners and parametrizations, as this is only a sketch. Using the previous facts, we may take the height function

$$h: S^1 \xrightarrow{\varphi} \mathbb{R}^2 \rightarrow \mathbb{R}$$

and perturb it to be generic Morse. Since the subspace of embeddings in all smooth maps is open, if this perturbation is small enough, a linear interpolation to it will stay in the subspace of embeddings. By isotopy extension this interpolation is induced by an ambient isotopy. Thus it suffices to prove that the perturbed  $\varphi$  smoothly bounds a disk (since we may use the ambient isotopy to get a bounding disk for the original  $\varphi$  from one for the perturbed  $\varphi$ ).

Let us now temporarily forget about  $\varphi$ , and only remember its image  $\varphi(S^1)$ . Then we can find a finite set  $\{y_i\}_{i=1}^k$  of  $y_i \in \mathbb{R}$  which are not critical values of  $h$ , and such that each subset  $f^{-1}([y_i, y_{i+1}]) \subset$

**Remark 11.1.2.** In Theorem 9.1.1 we proved that the left vertical map  $\text{Diff}(\mathbb{R}^2) \rightarrow \text{Emb}(D^2, \mathbb{R}^2)$  of (11.1) is a weak equivalence, and hence  $\text{Diff}(\mathbb{R}^2 \text{ rel } D^2)$  is weakly contractible.



$\mathbb{R}^2$  contains at most one critical point. By linear interpolation, we can arrange that near  $\mathbb{R} \times \{y_i\}$  the image of  $\varphi$  is vertical. The image of the embedding now looks like Figure 11.1.

Next we shall simplify  $\varphi$  by a number of *cuts* along the lines  $\mathbb{R} \times \{y_i\}$ . We shall remember the order in which we do these cuts, and the exact process we use, since we later want to reverse them.

To make the first cut, we note that there is always an even number of points  $\varphi(S^1) \cap (\{y_i\} \times \mathbb{R})$  and so we may pick an “innermost” pair, i.e. so that the interval connecting them in  $\mathbb{R} \times \{y_i\}$  contains no other points. Since the embedding is locally vertical, we can separate two cuts by a small distance  $\epsilon_1 > 0$  from  $\mathbb{R} \times \{y_i\}$ . That is, we insert parallel vertical translates of these intervals connecting the innermost pair, separated by distance  $2\epsilon_1$ . The missing pieces left out separating the cuts are bounded by a rectangle, which obviously bounds a square in a standard manner.

Next we do the same for a next choice of points innermost after removing the pair, now separating the parallel translates by distance  $2\epsilon_2$  with  $\epsilon_2 < \epsilon_1$ , etc. At the end of the process, the result might look like Figure 11.2 (depending on the choice of innermost pairs).

Let us restrict our attention to each of the pieces. The crucial observation is that they contain at most one critical point, because the  $y_i$ 's separated all critical values and all critical values for all critical points are distinct. Away from the critical points, each piece is described by a smooth family of embeddings of a finite number of points into  $\mathbb{R}$ . We know how to manipulate these, so we can write down an isotopy moving these pieces into the inverse image under  $f$  of a small neighborhood of the critical values. This is chosen small enough so that we can use the local coordinates near the critical point and so that we can linearly interpolate the parallel families of points to be straight. By isotopy extension this isotopy is induced by a compactly-supported isotopy of  $\mathbb{R}^2$ .

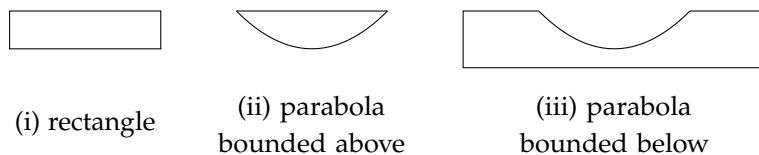

Now the situation has been isotoped to look like a disjoint union of the five standard models given by Figure 11.3 or their vertical reflections. Here it is very important that we do not mean just an impressionistic shape: these are given by explicit formulas. This means we can write down formulas for the half-disks or squares that they bound, and running the ambient isotopy in reverse, the pieces in Figure 11.2 bound a disk (or rather half-disk or rectangle).

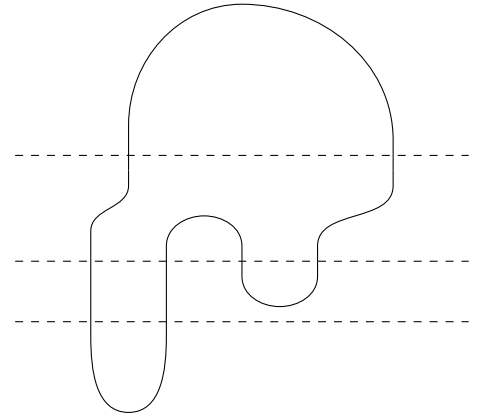

Figure 11.1: Intermediate result 1.

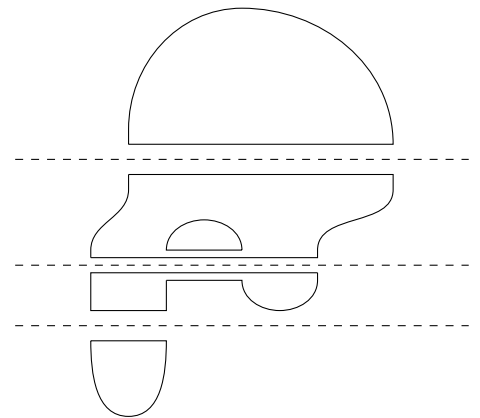

Figure 11.2: Intermediate result 2. It has 5 pieces (not 4!).

Figure 11.3: Standard models. Only (i) and (ii) occur in Figure 11.2, but if we had picked the innermost pairs differently for the middle line, (iii) would have occurred.

Now we reverse the cutting process. By construction, we obtain Figure 11.1 by combining these pieces along some standard rectangles. This combination process involves finitely many steps given by either an addition or subtraction of a disk. By Lemma 11.1.4 this preserves the diffeomorphism type. Thus the image of  $\varphi$  bounds a disk.

Now we remember  $\varphi$  again, instead of just its image. We realize that we may have ended up with a bounding disk  $D^2$  for  $\varphi(S^1)$  whose boundary parametrization does not agree with that coming from  $\varphi$ . However, since  $\text{Diff}(S^1)$  has two path-components, we can isotope and/or reflect the disk to make the parametrizations line up.  $\square$

**Lemma 11.1.4.** *Given a smooth manifold  $M$ , smooth embeddings  $\varphi_0: D^{m-1} \hookrightarrow D^m$  and  $\varphi_1: D^{m-1} \hookrightarrow \partial M$ , we have that  $M$  and  $M \cup D^m$  (obtained using  $\varphi_0$  and  $\varphi_1$ ) are diffeomorphic modulo smoothing corners.*

*Proof.* This follows from isotopy extension, as gluing along isotopic embeddings gives a diffeomorphic manifold. On the one hand, we observe that  $\text{Emb}(D^{m-1}, \partial D^m)$  has two path components, so up to reflection, we may assume that  $\varphi_0$  is the standard inclusion  $D^{m-1} \hookrightarrow D^m$ . On the other hand, after picking a chart of  $\mathbb{R}^{m-1} \times [0, \infty) \hookrightarrow M$  hitting the component of  $\partial M$  containing the image of  $\varphi_1$ , we may assume  $\varphi_1$  coincides up to reflection with the standard inclusion  $D^{m-1} \times \{0\} \hookrightarrow \mathbb{R}^{m-1} \times [0, \infty)$ . Then the observation is that

$$(\mathbb{R}^{m-1} \times [0, \infty)) \cup D^m$$

obtained from gluing along standard inclusions, is diffeomorphic to  $\mathbb{R}^{m-1} \times [0, \infty)$ . This is proven by writing down an explicit diffeomorphism.  $\square$

## 11.2 Hatcher's proof and Alexander's theorem

Hatcher's approach is to prove the following analogue of Proposition 11.1.1, which is equivalent to the combination of smooth Schoenflies in dimension 3 with  $\text{Diff}_\partial(D^3) \simeq *$ .

**Theorem 11.2.1** (Hatcher). *The restriction map  $\text{Emb}(D^3, \mathbb{R}^3) \rightarrow \text{Emb}(S^2, \mathbb{R}^3)$  is a weak equivalence.*

In words, any smooth family of embeddings  $S^2 \hookrightarrow \mathbb{R}^3$  can be extended to a smooth family of embeddings  $D^3 \hookrightarrow \mathbb{R}^3$ . This is equivalent to the combination of  $\text{Diff}_\partial(D^3) \simeq *$  and the 3-dimensional Schoenflies theorem, by the same argument as in the previous section. To give an idea of why this is true, we shall sketch the proof of Alexander's theorem. This is equivalent to the relative  $\pi_0$ -case of

Theorem 11.2.1, saying that  $\text{Emb}(D^3, \mathbb{R}^3) \rightarrow \text{Emb}(S^2, \mathbb{R}^3)$  is surjective on  $\pi_0$ . More details are given in Theorem 1.1 of [Hato7].

**Theorem 11.2.2** (Alexander). *Every smooth embedding  $\varphi: S^2 \hookrightarrow \mathbb{R}^3$  extends to a smooth embedding  $D^3 \hookrightarrow \mathbb{R}^3$ .*

*Sketch of proof.* The argument is basically the same as for Theorem 11.1.3:

1. Make the height function generic Morse.
2. Pick non-critical values  $\{z_i\}$  separating the critical points and make the embedding vertical near the planes  $\mathbb{R}^2 \times \{z_i\}$ .
3. Cut along the  $\mathbb{R}^2 \times \{z_i\}$ , innermost<sup>1</sup> circles first, separating the cuts by  $\epsilon$ 's.
4. Isotopy the pieces to live near a critical level, so that the local coordinates near the critical point apply.
5. Using your understanding of  $\text{Emb}(S^1, \mathbb{R}^2)$  to maneuver the circles so that we have a disjoint union of pieces described by one of seven standard models as in Figure 11.4. These by construction bound a disk.
6. Run the isotopy and cutting process in reverse, and put together the pieces. By Lemma 11.1.4 the result is again a disk.
7. Adjust difference between parametrization of boundary coming from embedding and the bounding disk using Smale's theorem on diffeomorphisms of  $S^2$ . □

<sup>1</sup> In fact, the situation is slightly nicer now; where before there were sometimes non-equivalent choices which pairs of points in  $\varphi(S^1) \cap (\mathbb{R} \times \{y_i\})$  to consider innermost, e.g. in the middle line of Figure 11.1, now there is *no* need to make such a choice. This is essentially because circles are path-connected, but pair of points are not. Thus there is now only a choice of order in which circle to take innermost, which in the 2-dimensional case you take different pairs. This is why in Figure 11.4 no "cylinder with half-disk removed" analogous to the "parabola bounded below" as in Figure 11.3 shows up among the pieces.

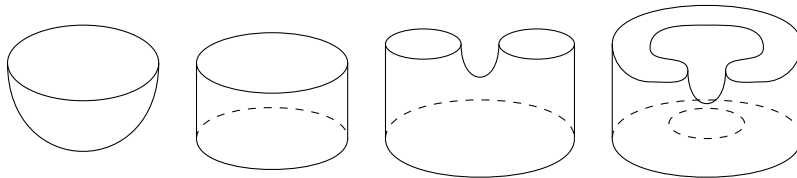

Figure 11.4: Four of the standard models. The remaining three are obtained by reflecting vertically. Note that in the right one, the inner horizontal disk does *not* reach all the way down (otherwise it would bound a solid torus, not a disk).

Note that we used our understanding of path-components of  $\text{Emb}(S^1, \mathbb{R}^2)$ , and proving the  $\pi_i$ -versions will involve the entire strength of Proposition 11.1.1.

**Remark 11.2.3.** Why does this strategy fail for dimension 4? It was important that in both 2- and 3-dimensional case the intersections with the hyperplanes of constant height were very simple: either points in dimension 2, or circles in dimension 3. For dimension 4 we'd be dealing with surfaces in  $\mathbb{R}^3$ . We can still define a notion of "innermost" for these and isotope the pieces to live near a critical level. Thus steps (1)–(4) work. However, step (5) fails, as the pieces may not bound a disk, being of the form  $\partial(\Sigma \times I \cup \{1\text{-handle}\})$  and hence a surface of possibly high genus.

### 11.3 Consequences of Hatcher's theorem

We give a few consequences of Hatcher's theorem.

#### Diffeomorphisms of $S^3$

Recall our proof that  $\text{Diff}(S^2) \cong O(3)$ . Hatcher's theorem implies a similar result for  $\text{Diff}(S^3)$ .

**Theorem 11.3.1.** *We have that  $\text{Diff}(S^3) \simeq O(4)$ .*

*Proof.* There is a fiber sequence

$$\text{Diff}(S^3 \text{ rel } D^3) \rightarrow \text{Diff}(S^3) \rightarrow \text{Emb}(D^3, S^3),$$

with fiber homeomorphic to  $\text{Diff}_0(D^3) \simeq *$  and base weakly equivalent to  $\text{Fr}^O(TS^3) \cong O(4)$ .  $\square$

#### Path-components of diffeomorphism groups

Recall we proved that for path-connected compact oriented surfaces  $\Sigma$  with non-empty boundary,  $\text{Diff}_0^{\text{id}}(\Sigma)$  is weakly contractible. One way of rephrasing this, is saying that the map

$$\text{Diff}_0^{\text{id}}(\Sigma) \rightarrow \text{haut}_0^{\text{id}}(\Sigma)$$

is a weak equivalence. This follows since we claim that  $\text{haut}_0^{\text{id}}(\Sigma)$  is weakly contractible. To see this in the case that  $\Sigma$  has one boundary component, note that  $\text{haut}_0^{\text{id}}(\Sigma) \cong \text{Map}_*^{\text{id}}(\bar{\Sigma}, \bar{\Sigma})$ , where  $\bar{\Sigma}$  is the surface obtained by filling in the boundary component with a disk, putting a base point in its center. For  $i \geq 1$ , any map  $S^i \times \bar{\Sigma} \rightarrow \bar{\Sigma}$  extends to  $D^{i+1}$ ; we need to extend from  $* \times S^i$  to  $* \times D^{i+1}$  (which we can do by a constant map), then for each of  $2g$  arcs  $D^1$  from  $D^1 \times S^i \cup \partial D^1 \times D^{i+1}$  to  $D^1 \times D^{i+1}$  (which we can do since this is the same as extending a map from  $S^{i+1}$  into  $\Sigma_g$  to  $D^{i+2}$ , and  $\Sigma_g$  has to  $\pi_{i+1}$  for  $i \geq 1$ ), and then from  $D^2 \times S^i \cup \partial D^2 \times D^{i+1}$  (for similar reasons as before).

One generalization of this to 3-manifolds is the following [Hat76, Iva76] (though the  $\pi_0$  and  $\pi_1$  case are due to Waldhausen and Laudénbach respectively). A *Haken 3-manifold* is by definition a compact path-connected  $P^2$ -irreducible sufficiently large 3-manifold, though we have not defined the majority of these terms (see e.g. [Hemo4], [Wal68]).

**Theorem 11.3.2** (Hatcher-Ivanov). *For  $M$  a Haken 3-manifold, we have that  $\text{Diff}_0^{\text{id}}(M) \rightarrow \text{haut}_0^{\text{id}}(M)$  is a weak equivalence.*

### Spaces of long knots

Let  $\text{Emb}_c(\mathbb{R}, \mathbb{R}^3)$  denote the space of embeddings  $\mathbb{R} \hookrightarrow \mathbb{R}^3$  that are standard outside of a compact set. These look like knots tied in a straight line, called *long knots*. Of course there are many path-components, but we can say something about that of the trivial long knot. We start by noting that  $\text{Emb}_c(\mathbb{R}, \mathbb{R}^3) \simeq \text{Emb}_\partial(D^1, D^3)$  and prove some preliminary results.

**Lemma 11.3.3.** *We have that  $\text{Emb}_\partial(D^2, D^3)$  is weakly contractible.*

*Proof.* We reverse the proof of Gramain's theorem to obtain a fiber sequence

$$\text{Diff}_\partial(D^3)^2 \rightarrow \text{Diff}_\partial(D^3) \rightarrow \text{Emb}_\partial(D^2, D^3)$$

with fiber and total space weakly contractible. Use the 3-dimensional smooth Schoenflies or Alexander's theorem for path-connectedness.  $\square$

Let  $D_+^2$  be the half-disk, and define the subset  $S_+^1 := S^1 \cap D_+^2$  of its boundary  $\partial D_+^2$ . Then it is easy to prove that  $\text{Emb}(D_+^2, D^3 \text{ rel } S_+^1)$  is weakly contractible, by precomposing with self-embeddings of  $D_+^2$  fixing  $S_+^1$  to move into the neighborhood of  $S_+^1$  where the embedding is the identity.

We may now also fix  $D^1 := D_+^2 \cap \mathbb{R} \times \{0\}$  (so that  $\partial D_+^2 = S_+^1 \cup D^1$ ); to be the standard embedding  $D^1 \hookrightarrow D^3$ . We have that  $D^3$  and  $D^3 \setminus D_-^2$  are isotopy equivalent, so that  $\text{Emb}(D_+^2, D^3 \setminus D_-^2 \text{ rel } \partial D_+^2)$  is homotopy equivalent to  $\text{Emb}_\partial(D^2, D^3)$ . Hatcher proved in [Hat76] (see also [Hat]) that

$$\text{Emb}(D_+^2, D^3 \setminus D_-^2 \text{ rel } \partial D_+^2) \hookrightarrow \text{Emb}(D_+^2, D^3 \text{ rel } \partial D_+^2)$$

is a weak equivalence. One should think of this as an analogue of the argument we compare arcs in  $\Sigma$  and  $\Sigma \cup \text{strip}$  in the previous lecture.

**Proposition 11.3.4.** *We have that the path-component  $\text{Emb}_c^0(\mathbb{R}, \mathbb{R}^3)$  of  $\text{Emb}_c(\mathbb{R}, \mathbb{R}^3)$  containing the standard inclusion  $\mathbb{R} \hookrightarrow \mathbb{R}^3$  is weakly contractible.*

*Proof.* Consider the fiber sequence

$$\text{Emb}^0(D_+^2, D^3 \setminus D_-^2 \text{ rel } \partial D_+^2) \rightarrow \text{Emb}^0(D_+^2, D^3 \text{ rel } \partial D_+^2) \rightarrow \text{Emb}_\partial^0(D^1, D^3)$$

with fiber weakly contractible and left map a weak equivalence. The long exact sequence of homotopy groups implies that  $\text{Emb}_\partial^0(D^1, D^3)$  is weakly contractible.  $\square$

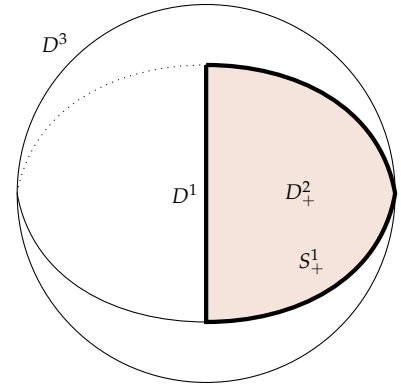



## **Part III**

# **The s-cobordism theorem**





# 12

## Transversality

Now that we have discussed dimension 2 in detail, and outlined what happens in dimension 3, we shall start to move on to high dimensions. Our next main goal is the  $s$ -cobordism theorem. This is done using Morse theory, or equivalently handle theory. Today we shall show that Morse function exists. References are Chapters 2 and 3 of [Mil97], Chapter 4 of [Wal16], and Chapter IV of [Kos93].

### 12.1 Sard's lemma

Sard's famous lemma is one of the basic foundational results of smooth manifold theory, rivaled in importance only by the inverse function theorem and existence and uniqueness for solutions of ordinary differential equations. We start by recalling some definitions. For the moment, all manifolds have empty boundary.

**Definition 12.1.1.** If  $f: M \rightarrow N$  is a smooth map, then  $q \in M$  is said to be a *critical point* if  $D_q f: T_q M \rightarrow T_{f(q)} N$  is not surjective. A point  $p \in N$  is said to be a *critical value* if it is the image under  $f$  of a critical point.

Conversely, if  $D_q f: T_q M \rightarrow T_{f(q)} N$  is surjective, we call  $q \in M$  a *regular point*, and if  $p \in N$  is not a critical value, we call it a *regular value*.

If  $p \in N$  is regular, then  $f^{-1}(p)$  is a smooth submanifold of  $M$  by the implicit function theorem and it has codimension  $n$ .

**Theorem 12.1.3 (Sard).** Let  $U \subset \mathbb{R}^m$  be open and  $f: U \rightarrow \mathbb{R}^n$  be a smooth map. Then the set  $C \subset \mathbb{R}^n$  of critical values has measure 0.

Here measure 0 makes sense without defining a Lebesgue measure; a set is measure 0 if in each chart it is contained in a union of disks of total volume  $< \epsilon$  for every  $\epsilon > 0$ . A measure 0 set can not contain an open subset, and thus we conclude that the regular values are dense. Furthermore, the continuity of the derivative means that

Takeaways:

- Sard's lemma says that regular values are dense.
- This can be used to reprove the Brouwer fixed point theorem, and to improve the Whitney embedding theorem.
- Using Sard's lemma and a strongly relative argument, we can prove functions can be made transverse to submanifolds of the target.
- A stronger version of transversality is jet transversality.

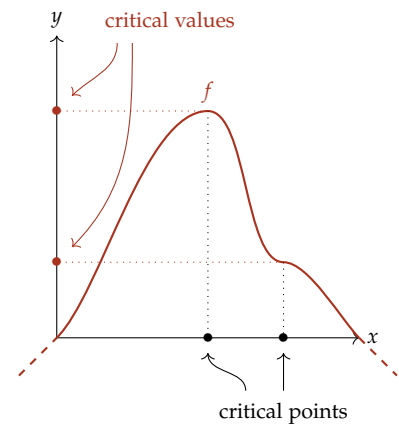

Figure 12.1: The graph of a smooth function  $f: \mathbb{R} \rightarrow \mathbb{R}$ .

**Example 12.1.2.** The element  $1 \in \mathbb{R}$  is a regular value of  $\sum x_i^2: \mathbb{R}^m \rightarrow \mathbb{R}$  and its inverse image is the  $(m-1)$ -sphere  $S^{m-1}$ . Its only critical value is 0.

the regular values form an open subset. Thus another formulation of Sard's lemma is sometimes that the regular values are a dense open subset of the target.

A proof of Sard's lemma is given in Chapter 3 of [Mil97], and Chapter 4.1 of [Wal16] gives a short proof in the case  $m < n$ . We start with a mild generalization.

**Proposition 12.1.4.** *The set of critical values of a smooth map  $f: M \rightarrow N$  has measure 0. As a consequence the regular values are open and dense.*

*Proof.* First assume that  $\partial M = \partial N = \emptyset$ . We first consider the case  $M = U \subset \mathbb{R}^m$  open. Cover  $N$  with a countable collection of charts of the form  $\varphi_i: N \supset V_i \rightarrow \mathbb{R}^n$ . Then we have that

$$\text{Crit}(f_i) = \bigcup_i \varphi_i^{-1}(\text{Crit}(\varphi_i \circ f|_{f^{-1}(V_i)})),$$

the union of the inverse images under  $\varphi_i$  of the critical values of the maps  $\varphi_i \circ f|_{f^{-1}(V_i)}: \mathbb{R}^m \supset f^{-1}(V_i) \rightarrow \mathbb{R}^n$ . Since smooth maps preserve measure 0 sets, e.g. Lemma 4.1.1 of [Wal16],  $\text{Crit}(f)$  is a countable union of measure 0 sets and hence has measure 0.

By a similar argument, we reduce the general case to that of  $M$  open in  $\mathbb{R}^m$ . Cover  $M$  with a countable collection of charts  $\varphi'_i: M \supset V'_i \rightarrow \mathbb{R}^m$ . Then we have that

$$\text{Crit}(f) = \bigcup_i \text{Crit}(f \circ (\varphi'_i)^{-1}),$$

the union of the sets of critical values of the maps  $f \circ (\varphi'_i)^{-1}: \varphi'_i(V'_i) \rightarrow N$ . Again this is a countable union of measure 0 sets and hence measure 0.

Finally, if the boundaries are not empty, one adds an exterior collar on  $N$ , and remarks that the critical values are the union of the critical values of  $f|_{\partial M}$  and a Whitney extension of  $f$  after adding exterior collar on  $M$ . Since a union of two measure 0 sets has measure 0, this reduces it to the case of empty boundary.  $\square$

### Manifolds with boundary

If we are dealing with manifolds with boundary, for the definition of critical point we need to distinguish two cases. In the case  $p \in \text{int}(M)$ , the definition is as above. However, in the case  $p \in \partial M$ , it is a critical point if it is a critical point of  $f$  or  $f|_{\partial M}$  (or both). We may then also define critical value, regular points and regular values, and  $f^{-1}(p)$  is a neat submanifold when  $p$  is a regular value in the interior of  $N$ , by Lemma 2.4 of [Mil97]. It is also true that  $\partial(f^{-1}(p)) = f^{-1}(p) \cap \partial M$ . Sard's lemma and its consequences hold as before.

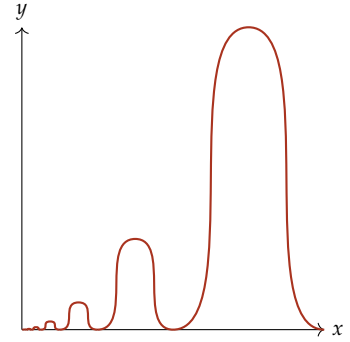

Figure 12.2: The critical values can have a convergence point.

The role of neatness is sufficiently subtle that we give an explanation; firstly, this is a local question and only subtle near the boundary of  $M$ , in which case we are considering a map

$$f: \mathbb{R}^{m-1} \times [0, \infty) \rightarrow \mathbb{R}^n.$$

Either by definition or the Whitney extension theorem, we may extend  $f$  to a smooth map  $\tilde{f}: U \rightarrow V$ , with  $U$  a neighborhood of  $\mathbb{R}^{m-1} \times [0, \infty)$  in  $\mathbb{R}^m$ . Without loss of generality  $\tilde{f}$  has no critical points, so that  $\tilde{f}^{-1}(p)$  is a submanifold of  $U$ . If  $\pi_M: \mathbb{R}^m \rightarrow \mathbb{R}$  denotes the projection onto the last coordinate, we claim that the map  $\pi_m: \tilde{f}^{-1}(p) \rightarrow \mathbb{R}$  has 0 as a regular value. This is because the tangent space of  $\tilde{f}^{-1}(p)$  at  $q$  is the kernel of  $D_q \tilde{f}$  and if  $\ker(D_q \tilde{f})$  was contained in  $\ker(D_q \pi_m) = T_q \partial M$ , then  $f|_{\partial M}$  would not have had  $p$  as a regular value. This guarantees  $\tilde{f}^{-1}(p)$  is neat, and if we had dropped the assumption that  $f|_{\partial M}$  was regular, then  $f^{-1}(p)$  might not have been neat.

### *A generalization of the Brouwer fixed point theorem*

We can now give the first of two classical applications of Sard's lemma, which is a generalization of the Brouwer fixed point theorem.

**Theorem 12.1.5** (Hirsch). *If  $M$  is a compact manifold, there is no smooth map  $f: M \rightarrow \partial M$  that is the identity on  $\partial M$ .*

*Proof.* This is a proof by contradiction. Let  $q \in \partial M$  be a regular value, which exists since they are dense by Lemma 12.1.4. Then  $f^{-1}(q)$  is a compact 1-dimensional neat submanifold of  $M$  whose boundary lies in  $\partial M$ . By construction,  $f^{-1}(q) \cap \partial M = \{q\}$ . But all compact 1-dimensional manifolds are a finite disjoint union of circles and intervals as in Figure 12.3, and hence have an even number of points in their boundary.  $\square$

Applying this to  $M = D^n$  and using the smooth approximation techniques of Chapter 6, we obtain:

**Corollary 12.1.6.** *There is no continuous retraction  $D^n \rightarrow \partial D^n$ .*

From this the Brouwer fixed point theorem follows as usual, which says that every continuous map  $f: D^n \rightarrow D^n$  has a fixed point. From an  $f: D^n \rightarrow D^n$  without fixed points one constructs a continuous retraction  $g: D^n \rightarrow \partial D^n$  by sending  $x$  to  $\frac{f(x)-x}{\|f(x)-x\|}$ .

### *An improved Whitney embedding theorem*

The second is the first improvement on the result that a compact smooth manifold  $M$  admits a smooth embedding into some Eu-

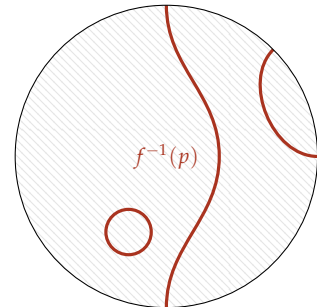

Figure 12.3: An  $f^{-1}(p)$  as in the proof of Theorem 12.1.5 when  $M = D^2$ .

clidean space; we shall show that if  $M$  has dimension  $m$ , it can be smoothly embedded into  $\mathbb{R}^{2m+1}$ .

**Proposition 12.1.7.** *Every compact smooth manifold  $M$  can be smoothly embedded into  $\mathbb{R}^{2m+1}$ .*

*Proof.* Starting with a smooth embedding  $\varphi: M \hookrightarrow \mathbb{R}^N$ , then we shall show that one can reduce  $N$  by 1 as long as  $N > 2m + 1$ .

The idea is to pick a unit vector  $v \in S^{N-1}$  and consider  $\pi_{v^\perp} \circ \varphi: M \hookrightarrow \mathbb{R}^{N-1}$  where  $\pi_{v^\perp}: \mathbb{R}^N \rightarrow \mathbb{R}^{N-1}$  is projection onto the hyperplane orthogonal to  $v$ . What can go wrong? Firstly,  $\pi_{v^\perp} \circ \varphi$  may not be injective, or secondly,  $\pi_{v^\perp} \circ \varphi$  may be injective but its derivative might have a kernel somewhere. The first happens if there are  $x, y \in M$  distinct such that  $v = \frac{\varphi(x) - \varphi(y)}{\|\varphi(x) - \varphi(y)\|}$  and the second happens if there is a  $w \in TM$  such that  $D\varphi(w) = v$ .

So, we should pick an  $v$  in the complement of the union of the images of the smooth maps <sup>1</sup>

$$\begin{aligned} \text{cho}: \{(x, y) \mid x \neq y\} \subset M^2 &\rightarrow S^{N-1} \\ (x, y) &\mapsto \frac{\varphi(x) - \varphi(y)}{\|\varphi(x) - \varphi(y)\|} \end{aligned}$$

$$\begin{aligned} \text{tan}: \{w \mid \|w\| = 1\} \subset TM &\rightarrow S^{N-1} \\ (x, w) &\mapsto \frac{D\varphi(w)}{\|D\varphi(w)\|}. \end{aligned}$$

If  $2m < N - 1$ , then  $v \in S^{N-1}$  is a regular value of cho if and only if it is not in the image of cho, and similar for tan as long as  $2m - 1 < N - 1$ . Thus if we assume that  $2m < N - 1$ , it suffices to show that  $\text{im}(\text{cho}) \cup \text{im}(\text{tan}) \neq S^{N-1}$ . But this follows from the fact that both terms are sets of critical values and hence have measure 0.

Thus as long as  $N \geq 2m + 2$ , we can find a unit vector  $v \in S^{N-1}$  to project along and still have an embedding.<sup>2</sup> □

## 12.2 Transversality

The main consequences of Sard's lemma are transversality results. We shall prove the basic version.

### Definition of transversality

Let us start with the definition of transversality. For the moment, all manifolds have empty boundary.

**Definition 12.2.1.** Let  $f: M \rightarrow N$  and  $g: M' \rightarrow N$  be smooth maps. Then  $f$  and  $g$  are said to be *transverse*, denoted  $f \pitchfork g$ , if for

<sup>1</sup> cho stands for "chord", and tan for "tangent line". Alternatively one could define a single map on the Fulton-MacPherson compactification of the configuration space  $C_2(M)$ .

<sup>2</sup> The proof also makes clear that we can go down to  $\mathbb{R}^{2m}$  if we only want to avoid cusps. A variation of cho would also allow us to guarantee that the tangent plane at any intersection point are distinct.

all  $p \in f(M) \cap g(M')$ ,  $q \in f^{-1}(p)$  and  $q' \in g^{-1}(p)$ , we have that  $Df_q(T_q(M)) + Dg_{q'}(T_{q'}(M')) = T_p(N)$ .

**Example 12.2.2.** If  $\dim M + \dim M' < \dim N$  then  $f$  and  $g$  are transverse if and only if  $f(M)$  and  $g(M')$  are disjoint.

Let us discuss some special cases:

**Example 12.2.4.** If  $g$  is the inclusion of a submanifold  $X$ , then the definition simplifies upon identifying  $X$  with its image;  $f \pitchfork X$  if for all  $p \in f(M) \cap X$  and  $q \in f^{-1}(p)$  we have that  $Df_q(T_q(M)) + T_p(X) = T_p(N)$ . An equivalent statement is that for all  $p \in f^{-1}(f(M) \cap X)$  the map  $\pi \circ D_p f: T_p M \rightarrow T_{f(p)} N \rightarrow \nu_{f(p)} X$ , the latter being a fiber of the normal bundle of  $X$  in  $N$ , is surjective.

The *implicit function theorem* says that if  $f$  is transverse to  $X$  then  $f^{-1}(X) \subset M$  is a smooth submanifold. It will be of codimension  $n - x$ , hence of dimension  $m + x - n$ .

**Example 12.2.5.** If  $f$  is the inclusion of a submanifold, this definition simplifies: two smooth submanifolds  $M$  and  $X$  are transverse if  $T_p M + T_p X = T_p N$  for all  $p \in M \cap X$ . The implicit function theorem then says that we can find a chart  $U$  near  $x$  such that  $N \cap U$  and  $X \cap U$  in this chart are given by two affine planes intersecting generically (that is, in an  $(m + x - n)$ -dimensional affine plane).

Let us explain the modification to manifolds with boundary only in the case of  $f \pitchfork X$  with  $\partial X = \emptyset$ . Then  $f \pitchfork X$  if not only  $f$  is transverse to  $X$  in the ordinary sense, but also  $f|_{\partial M}$  is transverse to  $X$ . In this case  $f^{-1}(X) \subset M$  is a neat submanifold with boundary (see IV.1.4 of [Kos93]). Remark that  $X \subset N$  is neat if and only if  $X \pitchfork \partial N$ .

### *Proof of transversality*

We shall now give a proof that every smooth map can be approximated by smooth maps transverse to  $X$ . The case of transversality with respect to a map  $g$  is done by considering graphs, see Chapter IV of [Kos93]. We give this proof as an example how a *strongly relative statement* allows one to do an induction over charts and reduce to the local case. This is a very common technique.

**Theorem 12.2.6.** *Every smooth map  $f: M \rightarrow N$  can be approximated by a smooth map transverse to  $X$ .*

*Proof.* To do induction over charts in Step 3, we actually need to prove a strongly relative version. That is, we assume we are given a closed subsets  $C_{\text{done}}, D_{\text{todo}} \subset M$  and open neighborhoods  $U_{\text{done}}, V_{\text{todo}} \subset M$  of  $C_{\text{done}}, D_{\text{todo}}$  respectively, such that  $f$  is already transverse to  $X$  on  $U_{\text{done}}$  (note that  $C_{\text{done}} \cap D_{\text{todo}}$  could be non-empty).

**Remark 12.2.3.** There are several other useful notions of transversality of a map with respect to a submanifold, which generalize better to PL and topological manifolds. These include microbundle transversality, block bundle transversality, and stable transversality. The main issue is that PL or topological submanifolds might *not* have normal bundles [RS67].

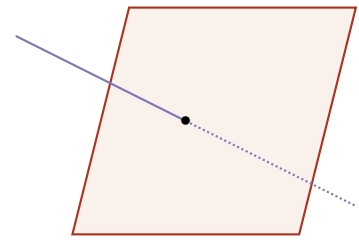

Figure 12.4: A transverse intersection of a 2-dimensional and a 1-dimensional submanifold.

See Figure 12.5. It will be helpful to let  $r := n - x$  denote the codimension of  $X$ .

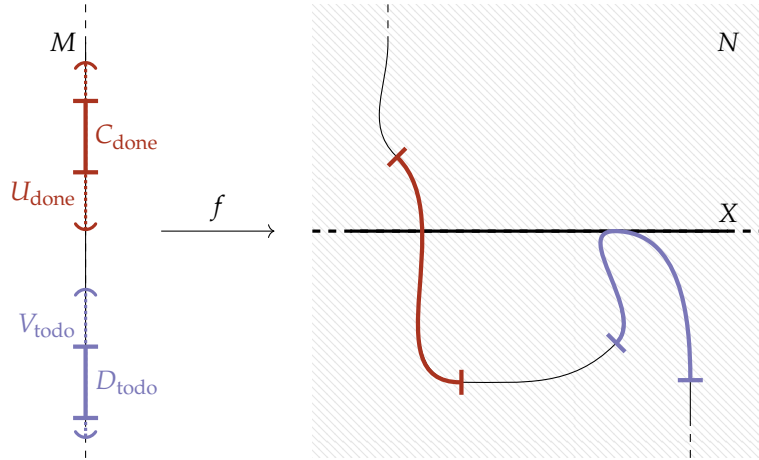

Figure 12.5: The input for the strongly relative version of transversality in Theorem 12.2.6. We are then asked to fix  $f$  near  $D_{\text{todo}}$  with support in  $V_{\text{todo}}$ , by moving the graph for example a bit upward or downwards.

Then we want to make  $f$  transverse on a neighborhood of  $C_{\text{done}} \cup D_{\text{todo}}$  without changing it on a neighborhood of  $C_{\text{done}} \cup (M \setminus V_{\text{todo}})$ . We also fix a continuous  $\epsilon: M \rightarrow (0, \infty)$  and a metric on  $N$ , and demand that  $f(m)$  is not moved more than  $\epsilon(m)$ .<sup>3</sup>

*Step 1:*  $M$  open in  $\mathbb{R}^m$ ,  $X = \{0\}$ ,  $N = \mathbb{R}^r$ ,  $D_{\text{todo}}$  is compact We first prove that the subset of  $C^\infty(M, \mathbb{R}^r)$  which consists of smooth functions  $M \rightarrow \mathbb{R}^r$  that are transverse to  $\{0\}$  is open and dense.

Note that  $f$  is transverse to 0 near  $D_{\text{todo}}$  if and only if 0 is regular. Openness follows from the fact that being transverse to 0 near a compact subset  $K$  is an open condition. For density, we use Sard's lemma, which says that the regular values are dense in  $\mathbb{R}^r$ . Thus for every  $f \in C^\infty(M, \mathbb{R}^n)$  there is a sequence of  $x_k \in \mathbb{R}^r$  of regular values of  $f: M \rightarrow \mathbb{R}^r$  converging to 0. Then

$$f_k := f - x_k$$

is a sequence of functions transverse to  $\{0\}$  converging to  $f$ .

This is not a strongly relative version yet. Fix a compactly-supported smooth function  $\eta: M \rightarrow [0, 1]$  such that  $\eta$  is 0 near  $C_{\text{done}} \cup (M \setminus V_{\text{todo}})$  and 1 on a neighborhood of  $D_{\text{todo}} \setminus U_{\text{done}}$  (compactness of  $D_{\text{todo}}$  means we can take the support of  $\eta$  to be compact). Then consider the smooth functions

$$\tilde{f}_k := \eta f_k + (1 - \eta)f.$$

For  $k$  sufficiently large, this is transverse to  $\{0\}$  on a neighborhood of  $C_{\text{done}} \cup D_{\text{todo}}$ , by openness of the condition of being transverse to  $\{0\}$  near a fixed compact subset (here the support of  $\eta$ ). Taking  $k$

<sup>3</sup> In fact, we could have ignored the smallness of the approximation, because it turns out that strongly relative results *always* imply approximations, see Appendix I.C of [KS77].

even larger, we can also arrange that  $d(\tilde{f}_k(m), f(m)) < \epsilon(m)$  for all  $m$ .

*Step 2:  $M$  open in  $\mathbb{R}^m$ ,  $N = \mathbb{R}^r \times X$ ,  $D_{\text{todo}}$  compact* Then  $f: M \rightarrow N = \mathbb{R}^r \times X$  is transverse to  $X$  if and only if  $\tilde{f} := \pi_1 \circ f: M \rightarrow \mathbb{R}^r \times X \rightarrow \mathbb{R}^r$  is transverse to  $\{0\}$ . So this reduces it to step (1).

*Step 3:  $M$  open in  $\mathbb{R}^m$ ,  $\nu_X$  trivializable,  $D_{\text{todo}}$  compact* Since  $\nu_X$  is trivializable, we may take a trivialized tubular neighborhood  $\mathbb{R}^r \times X$  in  $N$ , and substitute

- $M' = f^{-1}(\mathbb{R}^r \times X)$  and  $N' = \mathbb{R}^r \times X$ ,
- $f' = f|_{M'}$ .
- $C'_{\text{done}} = C_{\text{done}} \cap f^{-1}(\mathbb{R}^r \times X)$ ,
- $U'_{\text{done}} = U_{\text{done}} \cap f^{-1}(\mathbb{R}^r \times X)$ ,
- $D'_{\text{todo}} = D_{\text{todo}} \cap f^{-1}(D^r \times X)$  (which is fine since if  $f(x) \notin D^r \times X$  then you are transverse to  $X$  anyway),
- $V'_{\text{todo}} = V_{\text{todo}} \cap f^{-1}(\text{int}(2D^r) \times X)$  (which serves to control the support so that we can extend by  $f$  outside  $M' \subset M$ ),
- $\epsilon' = \epsilon'|_{M'}$ ,  $d' = d|_{N'}$ .

This reduces it to step 3.

*Step 4: General case* This will be an induction over charts. Take a locally finite covering  $U_\alpha$  of  $X$  so that each  $\nu_X|_{U_\alpha}$  is trivializable. We can then find a locally finite collection of charts  $\varphi_i: M \supset V_i \rightarrow W_i \subset \mathbb{R}^m$  covering  $M$ , such that (i)  $2D^m \subset W_i$ , (ii)  $D_{\text{todo}} \subset \bigcup_i \varphi_i^{-1}(D^m)$  and (iii) for all  $i$  there exists an  $\alpha$  with  $f(V_i) \subset U_\alpha$ .

Let's order the  $i$ , and write them as  $i \in \mathbb{N}$  from now on. By induction one then constructs a deformation to  $f_i$  transverse on some open neighborhood  $U_i$  of  $C_i := C_{\text{done}} \cup \bigcup_{j \leq i} \varphi_j^{-1}(D^m)$ . For the induction step from  $i-1$  to  $i$ , use step (3) with the substitution

- $M' = W_{i+1}$  and  $N' = N$ ,
- $f' = f_i \circ \varphi_{i+1}^{-1}$ ,
- $C'_{\text{done}} = \varphi_{i+1}(C_i \cap V_i)$ ,
- $U'_{\text{done}} = \varphi_{i+1}(U_i \cap V_i)$ ,
- $D'_{\text{todo}} = D^m \cap \varphi_i(D_{\text{todo}} \cap V_i)$  (note this is compact),
- $V'_{\text{todo}} = \text{int}(2D^m) \cap \varphi_i(V_{\text{todo}} \cap V_i)$ ,
- $\epsilon'$  is smaller than  $\epsilon$  and sufficiently small such that we do not to disturb property (iii) and  $d' = d$ .

Since the cover is locally finite,  $f$  is modified near each  $p \in M$  only finitely many times. Thus  $\lim_{i \rightarrow \infty} f_i$  is a well-defined smooth map that is transverse to  $X$  near  $\bigcup C_i \supset C_{\text{done}} \cup D_{\text{todo}}$ .  $\square$

We may apply this to the case that  $f$  is the inclusion of a submanifold.

**Corollary 12.2.7.** *If  $M$  and  $X$  are smoothly embedded compact submanifolds of  $N$ , then there is an arbitrarily small ambient isotopy  $\phi_t$  of  $N$  such that  $\phi_1(M) \pitchfork X$ . In particular, if  $m + x < n$  we can make  $M$  and  $X$  disjoint.*

*Proof.* Pick a Riemannian metric  $g$  on  $N$ . The embeddings are open in all smooth maps, so if we pick a perturbation  $\tilde{f}$  of the inclusion  $f: M \hookrightarrow N$  transverse to  $X$  small enough, then it is an embedding and furthermore has the property that for all  $q \in M$  there is a unique geodesic in  $N$  connecting  $\tilde{f}(q)$  and  $f(q)$  in  $N$ . This gives a family of embeddings  $f_t$  such that  $f_0 = f$  and  $f_1 = \tilde{f}$ . By isotopy extension  $f_t$  is induced by an ambient isotopy.  $\square$

### 12.3 Jet transversality

A Morse function will be a particularly nice type of function, and we shall show that such functions exist using a transversality theorem that applies to the jet spaces we used to define the Whitney topology. To explain this, let us revisit transversality.

One can rephrase transversality in terms of the first jet space. Recall that  $J^r(M, N)$  was given by the space of pairs of a point in  $m$  and an  $r$ -jet of a map  $f: M \rightarrow N$  near  $m$ . This  $r$ -jet contains the data of the  $r$ th Taylor approximation of  $f$  at  $m$ , i.e. for  $r = 1$  its value and first derivative. It is a locally trivial bundle over  $M \times N$  with fiber given by  $n$ -tuples of polynomial of degree  $\leq r$  in  $m$  variables taking the value 0 at the origin. As the transition maps between these local trivializations are induced by diffeomorphisms and hence smooth, we see that  $J^r(M, N)$  is in fact a smooth manifold, of dimension  $m + n(1 + m + \binom{m+1}{2} + \dots + \binom{m+r-1}{r})$ .

There is a  $r$ -jet map

$$j^r: C^\infty(M, N) \rightarrow \Gamma(M, J^r(M, N))$$

recording the  $r$ -jets of a smooth map  $f$  at all points in  $m$ . Considered as a map  $M \rightarrow J^r(M, N)$  this is smooth.

For any  $r \geq 1$ , we can describe the condition  $f$  is transverse to  $X$  in terms of  $j^r(f)$ . For concreteness, let us take  $r = 1$ , then there is a subspace  $\mathcal{X}$  of  $J^1(M, N)$  consisting of those 1-jets with image in  $X$  (and arbitrary first derivatives). We then have  $f \pitchfork X$  if and only if  $j^1(f) \pitchfork \mathcal{X}$ . Note that  $\mathcal{X}$  has dimension  $m + x + nm$ , i.e. codimension  $m - x$ , as locally we are imposing  $(m - x)$  equations to get the values to lie  $X$ .

We can arrange  $j^1(f) \pitchfork \mathcal{X}$  using *jet transversality*, a transversality result with respect to any closed stratified subset of the jet bundle.

**Example 12.3.1.** If  $r = 0$ ,  $J^r(M, N)$  is just the product  $M \times N$  and  $(m + n)$ -dimensional. If  $r = 1$ , there is the additional data of the  $n$ -dimensional directional derivative in each of the  $m$  directions, so it is  $(m + n + nm)$ -dimensional.

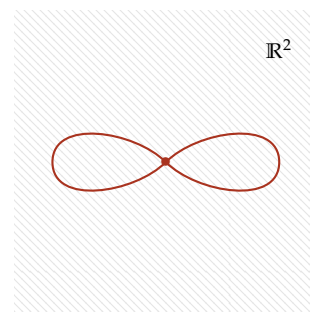

Figure 12.6: A 1-dimensional stratified subset of  $\mathbb{R}^2$ .



A *stratified subset* here is in the sense of Whitney; it is a subset  $Y \subset J^r(M, N)$  that is a union of finitely many  $i$ -dimensional submanifolds  $Y_i$  so that  $\text{cl}(Y_i) = \bigcup_{j \leq i} Y_j$ . A proof may be found in Section 4.5 of [Wal16].

**Theorem 12.3.2.** *Let  $\mathcal{D}$  be a closed stratified subset of  $J^r(M, N)$ . Every smooth map  $f: M \rightarrow N$  can be approximated by a smooth map whose  $r$ -jet is transverse to  $\mathcal{D}$ , i.e. transverse to each stratum. There is also a strongly relative version.*

### Generic maps

The classical application is the studying of generic maps  $M \rightarrow N$  when  $m \geq n$ , the starting point of singularity theory [AGZV12]. To do so, one defines a stratification of  $J^1(M, N)$  in terms of the dimension of the cokernel of the derivative. That is, it is the union of strata  $\mathcal{S}^i$  given by the subspace of  $J^1(M, N)$  where the derivative has  $i$ -dimensional kernel.

**Lemma 12.3.3.** *The  $\Sigma^i$  form a stratification of  $J^1(M, N)$ , and  $\Sigma^i$  has codimension  $(m - n + i)i$ .*

Then the jet transversality theorem implies that any smooth map  $f: M \rightarrow N$  can be arbitrarily approximated by a map  $\tilde{f}$  such that  $j^1(\tilde{f}) \pitchfork \Sigma^i$ . In particular, the subset  $\Sigma^i(\tilde{f})$  where the rank of the derivative drops by  $i$ , is a submanifold of codimension  $i(m - n + i)$  and its closure in  $M$  is  $\bigcup_{j \geq i} \Sigma^j(\tilde{f})$ .

**Example 12.3.4.** If  $n = m$ , then  $(m - n + i)i = i^2$ . For example, a map  $S^2 \rightarrow \mathbb{R}^2$  will generically only have regular points and circles of folds.



# 13

## Morse functions

We shall define Morse functions, prove that they exist, and explain that near a critical point a Morse function admits a nice form in well-chosen coordinates. References are Chapters 2 and 3 of [Mil97], Chapter 2 of [Mil63], and Chapter 4 of [Wal16].

### 13.1 Morse functions

Morse functions are particularly nice functions from manifolds to  $\mathbb{R}$ ; they are the functions where the critical points are as non-degenerate as possible.

#### Definition of Morse functions

To make this precise, we define the Hessian  $\text{Hess}_p(f)$  of a smooth map  $f: M \rightarrow \mathbb{R}$  at a critical point  $p \in M$ . Before giving a coordinate-independent definition, we discuss its construction on  $\mathbb{R}^m$ . The Hessian of  $f$  at  $0 \in \mathbb{R}^m$  is defined in terms of Taylor approximation around 0 as

$$f(x) = f(0) + \langle \nabla_0 f, x \rangle + \frac{1}{2} \langle \text{H}_0(f)x, x \rangle + \text{remainder}, \quad (13.1)$$

with  $\langle -, - \rangle$  denoting the standard standard Euclidean inner product, and the remainder vanishes up to second order at 0. To make this equation hold, the symmetric matrix  $\text{H}_0(f)$  must be given by<sup>1</sup>

$$(\text{H}_0(f))_{ij} := \frac{\partial^2 f}{\partial x_i \partial x_j}(0).$$

The matrix  $\text{H}_0(f)$  at 0 is *not* invariant under coordinate changes, as it is non-zero is not invariant under coordinate changes unless 0 was a critical point.

However, if 0 was a critical point, the following appropriate version of  $\text{H}_0(f)$  is invariant under coordinate changes. Any two tangent vectors  $v, w \in T_p M$  may be extended to smooth vector fields  $\tilde{v}$  and

Takeaways:

- Morse functions are smooth functions  $M \rightarrow \mathbb{R}$  with non-degenerate critical points. One proves that these exist by rephrasing the condition in terms of jet transversality.
- The Morse lemma says that non-degenerate critical points locally look like  $-\sum_{i=1}^{\lambda} x_i^2 + \sum_{i=\lambda+1}^m x_i^2$ .

<sup>1</sup> So if  $m = 1$ ,  $\text{H}_0(f)$  is just the second derivative  $\frac{d^2 f}{dx^2}(0)$ .

$\tilde{w}$ .<sup>2</sup> Let  $\tilde{v}[f]: M \rightarrow \mathbb{R}$  denote the *directional derivative* of  $f$  in the  $\tilde{v}$ -direction, and  $\tilde{v}[f](p)$  its value at  $p$ . This is independent of the choice of  $\tilde{v}$  extending  $v$  and linear in  $v$ . If  $p$  is a critical point, then  $\tilde{v}[f]$  vanishes at  $p$  for any  $v$ .

Let us now consider the expression  $\tilde{w}[\tilde{v}[f]](p) \in \mathbb{R}$ , which satisfies

$$\tilde{v}[\tilde{w}[f]](p) - \tilde{w}[\tilde{v}[f]](p) = [\tilde{v}, \tilde{w}][f](p) = 0, \quad (13.2)$$

with  $[\tilde{v}, \tilde{w}]$  the vector field obtained by taking the Lie bracket. Since  $\tilde{v}[g](p)$  is independent of the choice of extension  $\tilde{v}$  for any  $g: M \rightarrow \mathbb{R}$ , (13.2) implies  $\tilde{w}[\tilde{v}[f]](p)$  is independent of the choices of extensions  $\tilde{v}$  and  $\tilde{w}$  of  $v$  and  $w$  to vector fields.

Let us denote the real number  $\tilde{w}[\tilde{v}[f]](p)$  by  $\text{Hess}_p(f)(v, w)$ . The function  $\text{Hess}_p(f): T_p(M) \times T_p(M) \rightarrow \mathbb{R}$  given by  $(v, w) \mapsto \text{Hess}_p(f)(v, w)$ , is bilinear by construction, and symmetric by (13.2). This is the right definition of the *Hessian*.

**Definition 13.1.1.** A critical point  $p \in M$  is said to be a *non-degenerate* if the Hessian  $\text{Hess}_p(f): T_p(M) \otimes T_p(M) \rightarrow \mathbb{R}$  of  $f$  at  $p$  is a non-degenerate bilinear form.

The classification of non-degenerate bilinear forms is easy; by Gram-Schmidt up to  $\text{GL}_m(\mathbb{R})$  they are equivalent to a unique bilinear form of the form  $-\sum_{i=1}^{\lambda} x_i^2 + \sum_{i=\lambda+1}^m x_i^2$ . The integer  $\lambda \in \{0, \dots, m\}$  is called the *index*, and thus we can associate to each non-degenerate critical point a well-defined index.

**Definition 13.1.2.** A smooth function  $f: M \rightarrow \mathbb{R}$  is *Morse* if it is regular near  $\partial M$ , i.e. there is an open neighborhood of  $\partial M$  that contains no critical points, and all critical points of  $f$  are non-degenerate.

### Existence of Morse functions

We may describe this in terms of the second jet space  $J^2(M, \mathbb{R})$ . This contains a subspace  $\mathcal{D}$  of 2-jets with arbitrary value, vanishing first derivatives and degenerate second derivatives. This is a stratified subset, with stratification by the dimension of the kernel of the Hessian. We have chosen  $\mathcal{D}$  so that  $j^2(f)(m) \notin \mathcal{D}$  is equivalent to  $f$  either being regular at  $m$  or having a non-degenerate critical point. That is, for  $f$  that are regular near the boundary.  $j^2(f) \cap \mathcal{D} = \emptyset$  if and only if  $f$  is Morse.

Note  $\mathcal{D}$  has codimension  $m + 1$ , because all first derivatives have to vanish, as does the determinant of the Hessian. We conclude that  $j^2(f)$  is disjoint from  $\mathcal{D}$  if and only if it is transverse to  $\mathcal{D}$ . Using the relative version of the jet transversality theorem of Theorem 12.3.2, we conclude that Morse functions exist:

<sup>2</sup> Clearly this is possible in a chart and we may use a bump function to extend to  $M$ .

**Theorem 13.1.3.** *Every smooth function  $f: M \rightarrow \mathbb{R}$  which is regular near  $\partial M$  may be approximated by a Morse function without modifying it near  $\partial M$ .*

### Generic Morse functions

In Chapter 11 we used the notion of a *generic Morse function*, i.e. a Morse function all of whose critical values are distinct. We could have proven this by a stronger version of jet transversality called multi-jet transversality. However, it is easy to prove their existence by hand. We start with the following remark:

**Lemma 13.1.5.** *The Morse functions are open in  $C^\infty(M, \mathbb{R})$ .*

*Proof.* It suffices to prove that  $\mathcal{D} \subset J^2(M, \mathbb{R})$  is closed. □

**Corollary 13.1.6.** *Every smooth function  $f: M \rightarrow \mathbb{R}$  which is regular near  $\partial M$  may be approximated by a generic Morse function without modifying it near  $\partial M$ .*

*Proof.* Without loss of generality  $f$  is Morse already. Then for critical point  $p \in M$  pick a smooth function  $\eta_p: M \rightarrow \mathbb{R}$  that is 1 at  $p$  and with support away from the other critical points and an open neighborhood of  $\partial M$ . Then consider for  $\epsilon_i \in \mathbb{R}$  consider

$$f + \sum_i \epsilon_i \eta_i,$$

which is Morse with the same critical points if all  $\epsilon_i$  are small enough. Now just pick the  $\epsilon_i$  such that the critical values  $f(p_i) + \epsilon_i$  are distinct. □

## 13.2 The Morse lemma

Now that we have defined Morse functions and have shown they exist, we shall study them in more detail. In particular, we shall see that there exist coordinate near a non-degenerate critical point in which the function takes a standard form.

### Morse singularities

We shall describe a particular situation in which a critical point is non-degenerate.

**Definition 13.2.1.** A critical point  $p \in M$  of  $f: M \rightarrow \mathbb{R}$  is said to be a *Morse singularity* if there exists a chart with coordinates  $(x_1, \dots, x_m)$  around  $p$  (that is,  $p$  corresponds to 0) so that  $f$  near  $p$  is given by

$$(x_1, \dots, x_m) \mapsto f(p) - \sum_{i=1}^{\lambda} x_i^2 + \sum_{i=\lambda+1}^m x_i^2.$$

**Remark 13.1.4.** Note that the codimension of  $\mathcal{D}$  is barely enough for Theorem 13.1.3. In particular, one can not use the same argument to show that a 1-parameter family of smooth functions  $M \rightarrow \mathbb{R}$  can be approximated by a family of Morse functions. This is in fact impossible, and one needs to allow additional singularities. These are the so-called *birth-death singularities*, which locally look like

$$x_1^3 - \sum_{i=2}^{\lambda} x_i^2 + \sum_{i=\lambda+1}^m x_i^2.$$

**Lemma 13.2.2.** *Every Morse singularity is a non-degenerate critical point.*

*The Morse lemma*

The Morse lemma is the converse to Lemma 13.2.2, and is proven in Chapter 2 of [Mil63]. We shall follow the proof in Section 4.8 of [DKo4] instead.

**Theorem 13.2.3** (Morse lemma). *Every non-degenerate critical point is a Morse singularity.*

*Proof.* Without loss of generality we may assume that  $f(p) = 0$ , and fix a chart  $\varphi: M \supset V \rightarrow W \subset \mathbb{R}^m$  so that  $\varphi(p) = 0$ . Let  $x = (x_1, \dots, x_m)$  denote the coordinates near  $p$  coming from this chart, defined on  $W \subset \mathbb{R}^m$ .

Let  $\text{Sym}(\mathbb{R}^m)$  denote the space of symmetric  $(m \times m)$ -matrices over  $\mathbb{R}$ . The multi-variable version of Taylor approximation says that there is a smooth map  $Q: W \rightarrow \text{Sym}(\mathbb{R}^m)$  such that  $f(x) = \langle Q(x)x, x \rangle$ , which satisfies  $Q(0) = H_0(f)$  (e.g. obtained from (13.1) by absorbing the remainder into the Hessian term). We first want to change coordinates from  $x$  to  $y$  so that  $Q$  is independent of  $y$ . To do this, make the ansatz that  $y = A(x)x$  for a smooth map  $A: W \rightarrow \text{GL}_n(\mathbb{R})$ . In that case we need to solve the equation

$$\langle Q(0)A(x)x, A(x)x \rangle = \langle Q(x)x, x \rangle,$$

or equivalently  $A^t(x)Q(0)A(x) = Q(x)$ . The insight of Duistermaat-Kolk's proof is to consider the smooth map  $G: \text{Sym}(\mathbb{R}^m) \times W \rightarrow \text{Sym}(\mathbb{R}^m)$  given by

$$(B, x) \mapsto \left( \text{id} + \frac{1}{2}Q(0)^{-1}B \right)^t Q(0) \left( \text{id} + \frac{1}{2}Q(0)^{-1}B \right) - Q(x).$$

This is equal to 0 at  $(B, x) = (0, 0)$  and its derivative with respect to  $B$  at  $B = 0$  is the identity

$$\begin{aligned} \frac{\partial}{\partial B} G(B, 0) &= \left( \frac{1}{2}Q(0)^{-1} \right)^t Q(0) + Q(0) \left( \frac{1}{2}Q(0)^{-1} \right) \\ &= \frac{1}{2}\text{id} + \frac{1}{2}\text{id} = \text{id}. \end{aligned}$$

By the implicit function theorem, there exists a neighborhood  $U$  of 0 in  $W$  and a smooth map  $\beta: U \rightarrow \text{Sym}(\mathbb{R}^m)$  such that  $G(\beta(x), x) = 0$ . Taking

$$A(x) := \text{id} + \frac{1}{2}Q(0)^{-1}\beta(x)$$

we obtain that  $\langle Q(0)A(x)x, A(x)x \rangle = \langle Q(x)x, x \rangle$ . So we shall use coordinates  $y = A(x)x$ . Since  $x \mapsto A(x)x$  has derivative  $\text{id}$  at 0, by the

inverse function theorem there exists some smaller neighborhood  $U'$  on which this map is a diffeomorphism.

Now that in  $y$ -coordinates we have that  $f(y) = \langle Q(0)y, y \rangle$ , it is a matter finding a matrix  $A$  such that  $A^t Q(0) A$  diagonal with entries  $\pm 1$  and using the coordinates  $z = Ay$  instead. This is possible as a consequence of Gram-Schmidt.  $\square$

A useful observation following from the Morse lemma is that non-degenerate critical points are isolated. In particular, a compact manifold can only contain a finite number of them.





# 14

## Handles

Now that we have defined Morse functions and have shown that there exist coordinates near a non-degenerate critical point in which the function takes a standard form, we use this to relate Morse functions to handle decompositions. References are Chapters 2 and 3 of [Mil97], Chapter 2 of [Mil63], and Chapter 4 of [Wal16].

### 14.1 The difference between level sets

A generic Morse function  $f: M \rightarrow \mathbb{R}$  will provide us an understanding of  $M$  by studying the inverse images of points of intervals in  $\mathbb{R}$ . A *level set* of  $f$  is a subset of  $M$  of the form  $f^{-1}(a)$ , which is a submanifold of codimension 1 if  $a$  is a regular value. A *sub-level set* of  $f$  is a subset of  $M$  of the form  $f^{-1}((-\infty, a])$ , which is a manifold with boundary if  $a$  is a regular value.

The difference between two sub-level sets involves  $f^{-1}([a, b])$ . If  $a$  and  $b$  are regular values of  $f$ , then  $f^{-1}([a, b])$  is a smooth manifold with boundary. We shall start by explaining how its diffeomorphism type depends on  $a$  and  $b$ .

#### No critical values in $[a, b]$

The first case is when  $[a, b]$  contains no critical values, i.e.  $f^{-1}([a, b])$  contains no critical points. Recall that a continuous function is said to be *proper* if the inverse image of a compact subset is compact.

**Proposition 14.1.1.** *If  $f: M \rightarrow \mathbb{R}$  is proper and  $f^{-1}([a, b])$  contains no critical points, then  $f^{-1}([a, b])$  is diffeomorphic to  $f^{-1}(a) \times [a, b]$ .*

*Proof.* To prove this, we use the notion of a *strict gradient-like vector field*. This is a smooth vector field  $\mathcal{X}$  on  $f^{-1}([a, b])$  such that  $df(\mathcal{X}) = 1$ . One way to construct these is by picking a Riemannian metric  $g$  on  $f^{-1}([a, b])$  and taking the gradient  $\nabla f$ , the dual of the 1-form  $df$ . Since the condition on a strict gradient-like vector field is convex, we

Takeaways:

- If  $f: M \rightarrow \mathbb{R}$  is a Morse function, every critical point corresponds to a handle in a handle decomposition of  $M$ , i.e. we write  $M$  as being built by attaching copies of  $D^\lambda \times D^{m-\lambda}$  along  $\partial D^\lambda \times D^{m-\lambda}$  corresponding to critical points.
- This implies compact smooth manifolds have the homotopy type of finite CW complexes.

can also patch them together from local constructions using smooth bump functions.

So let  $\mathcal{X}$  be a strict gradient-like vector field. Since  $f^{-1}([a, b])$  is compact and  $df(\mathcal{X}) = 1$ , its forwards-time flow  $\Phi_{\mathcal{X}}$  exists until the flow-line hits  $f^{-1}(b)$  at time  $(b - a)$  (as  $f$  increases linearly along the flow-line). Consider the smooth map given by

$$\begin{aligned} \varphi: f^{-1}(a) \times [a, b] &\rightarrow f^{-1}([a, b]) \\ (p, t) &\mapsto \Phi_{\mathcal{X}}(p, t). \end{aligned}$$

It has bijective differential, and hence is a local diffeomorphism using the inverse function theorem. It is injective by uniqueness of solutions to ordinary differential equations and surjective because every point  $p \in f^{-1}([a, b])$  lies on a flow-line from  $f^{-1}(a)$  to  $f^{-1}(b)$ . Hence it is a diffeomorphism.  $\square$

For  $a \leq b$ , the sub-level set  $f^{-1}((-\infty, b])$  is obtained by glueing  $f^{-1}([a, b])$  to the sub-level set  $f^{-1}((-\infty, a])$  along  $f^{-1}(a)$ . Proposition 14.1.1 then implies:

**Corollary 14.1.2.** *If  $M$  is compact and  $f^{-1}([a, b])$  contains no critical points, then the sub-level sets  $f^{-1}((-\infty, a])$  and  $f^{-1}((-\infty, b])$  are diffeomorphic manifolds with boundary.*

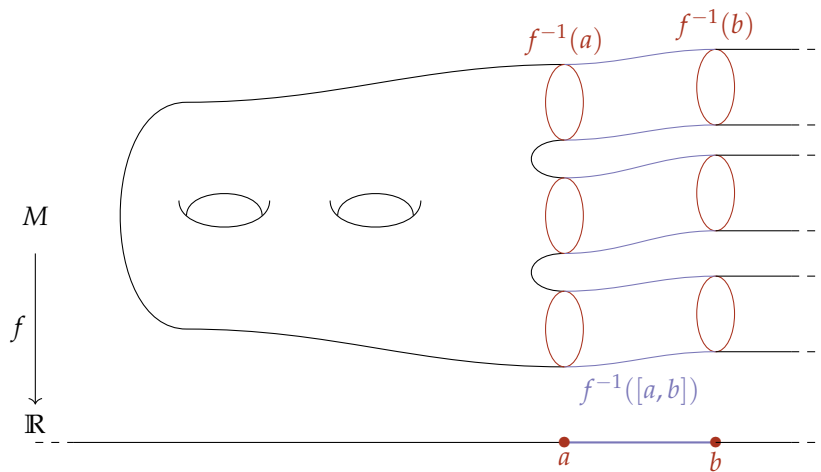

Figure 14.1: An example of a proper map  $f: M \rightarrow \mathbb{R}$  such that  $f^{-1}([a, b])$  contains no critical point. note that  $f^{-1}((-\infty, a])$  contains 7 critical points.

### A single critical value in $[a, b]$

What happens when there is a unique non-degenerate critical point  $p$  in  $f^{-1}([a, b])$ ? Pick a coordinate chart  $\varphi: M \supset V \rightarrow W \subset \mathbb{R}^m$  such

that  $\varphi(p) = 0$ , and in terms of coordinates  $(x_1, \dots, x_n) \in W$ ,  $f$  is given by

$$f(x_1, \dots, x_n) = c - \sum_{i=1}^{\lambda} x_i^2 + \sum_{i=\lambda+1}^m x_i^2.$$

This is possible by Theorem 13.2.3.

Let  $\epsilon > 0$  be small enough such that  $W$  contains the ball  $B_{\sqrt{2\epsilon}}(0)$  and  $a < c - 2\epsilon < c + 2\epsilon < b$ . Then we shall describe the difference between  $f^{-1}([a, c - \epsilon])$  and  $f^{-1}([a, c + \epsilon])$ , at first homotopy-theoretically and then as a manifold. To do so, define the subset  $C \subset B_{\sqrt{2\epsilon}}(0)$  by  $\{(x_1, \dots, x_\lambda, 0, \dots, 0) \mid \sum_{i=1}^{\lambda} x_i^2 \leq \epsilon\}$ , where  $C$  stands for *core*. This is of course a  $\lambda$ -dimensional disk, whose boundary  $(\lambda - 1)$ -sphere lies in  $f^{-1}(c - \epsilon)$ .

The description of  $f^{-1}([a, c + \epsilon])$  up to homotopy is as follows, and along the way we will in fact obtain a description up to diffeomorphism.

**Proposition 14.1.3.** *The union  $f^{-1}([a, c - \epsilon]) \cup C$  is a deformation retract of  $f^{-1}([a, c + \epsilon])$ .*

To prove this, we follow Milnor and shall find a neighborhood  $U$  of  $f^{-1}([a, c - \epsilon]) \cup C$  that is a deformation retract of  $f^{-1}([a, c + \epsilon])$  and itself deformation retracts onto  $f^{-1}([a, c - \epsilon]) \cup C$ :

$$f^{-1}([a, c - \epsilon]) \cup C \xrightarrow{\cong} U \xrightarrow{\cong} f^{-1}([a, c + \epsilon]).$$

The construction uses a modification  $F$  of  $f$ . This modification is obtained by changing  $f$  only on the subset  $f^{-1}([c - \epsilon, c + \epsilon])$ , using a smooth function  $\phi: [0, \infty) \rightarrow [0, \infty)$  satisfying (i)  $\phi(0) \in (\epsilon, 2\epsilon)$ , (ii)  $\phi(t) = \phi(0)$  for  $t$  near 0, (iii)  $\phi(t) = 0$  for  $t \in [2\epsilon, \infty)$ , and (iv)  $\phi'(t) \in (-1, 0]$  for all  $t \in [0, \infty)$ .

Then  $F$  is given by

$$F: M \rightarrow \mathbb{R}$$

$$x \mapsto \begin{cases} f(x) - \phi\left(\sum_{i=1}^{\lambda} x_i^2 + 2\sum_{i=\lambda+1}^m x_i^2\right) & \text{if } x \in V \\ f(x) & \text{otherwise.} \end{cases}$$

This is a smooth function because  $\phi\left(\sum_{i=1}^{\lambda} x_i^2 + 2\sum_{i=\lambda+1}^m x_i^2\right)$  has compact support in  $V$ .

**Lemma 14.1.4.**  *$F$  has the following properties:*

- (i)  $f^{-1}([a, c + \epsilon]) = F^{-1}([a, c + \epsilon])$ .
- (ii)  $F$  has the same critical points as  $f$ .
- (iii) In  $B_{\sqrt{2\epsilon}}(0) \subset W$ ,  $F^{-1}([a, c - \epsilon])$  is described by Figure 14.3. More precisely,  $U$  is diffeomorphic to  $f^{-1}([a, c - \epsilon]) \cup (D^\lambda \times D^{m-\lambda})$  attached along an embedding  $\partial D^\lambda \times D^{m-\lambda}$  (up to smoothing corners), with  $C$  corresponding to  $D^\lambda \times \{0\}$ .

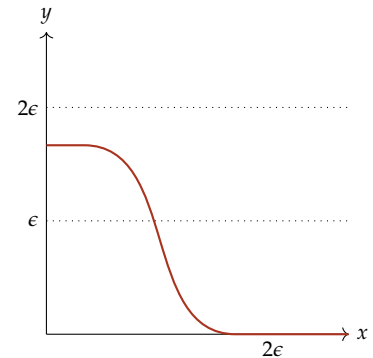

Figure 14.2: The function  $\phi$ .

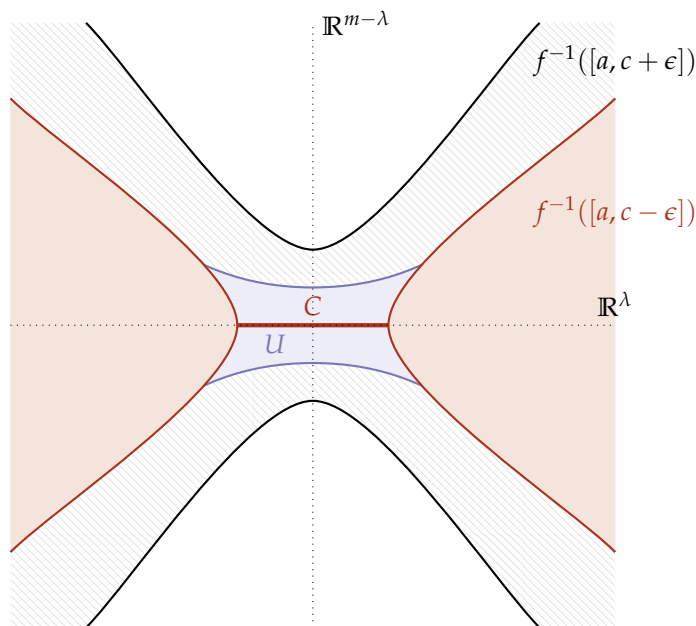

Figure 14.3: The set  $U$  is the union of the red and purple parts. The set  $f^{-1}([a, c + \epsilon])$  is the union of the red, purple and dashed parts.

*Proof.* Let us write  $x = (y, z)$  when  $x \in V$ , with  $y = (y_1, \dots, y_\lambda)$  denoting the first  $\lambda$  coordinates and  $z = (z_1, \dots, z_{m-\lambda})$  denoting the remaining  $m - \lambda$ .

Part (i) follows by noting that since  $F \leq f$  (since  $\phi$  is non-negative), we have that  $f^{-1}([a, c + \epsilon]) \subset F^{-1}([a, c + \epsilon])$ . For the converse, if  $x \in F^{-1}([a, c + \epsilon])$  and  $\phi(\|y\|^2 + 2\|z\|^2) > 0$ , then  $\|y\|^2 + 2\|z\|^2 < 2\epsilon$  (since  $\phi(t) = 0$  when  $t \geq 2\epsilon$ ), so that

$$f(x) - f(c) = -\|y\|^2 + \|z\|^2 \leq \frac{1}{2}\|y\|^2 + \|z\|^2 < \epsilon$$

and thus  $x \in f^{-1}([a, c + \epsilon])$  as well.

For part (ii) there is only something to check when  $p \in V$ . Working in local coordinates, we have that  $\frac{1}{2}\nabla F(x) = (-y - \phi'(x)y, z - \phi'(x)2z)$ . This certainly vanishes at 0, so  $p$  is a critical point. To see this is the only critical point, note that since  $\phi'(x) > -1$ , we must have  $y = 0$  and since  $\phi'(x) \leq 0$ , we must have  $z = 0$ .

The precise proof of part (iii) is a rather long computation, as we need to produce an explicit diffeomorphism. For details the reader may look at Chapter 3 of [Mil63] or Section VII.2.2 of [Kos93]. The main observation is that upon fixing the first  $\lambda$ -coordinates to be equal to  $y = (y_1, \dots, y_\lambda)$  with  $\|y\|^2 \leq \epsilon$ , the intersection of  $F^{-1}([a, c - \epsilon])$  with the  $(m - \lambda)$ -dimensional plane  $\{y\} \times \mathbb{R}^{m-\lambda}$  is given by a disk whose radius depends smoothly on  $y$ . Of course, as soon as  $\|y\|^2 + 2\|z\|^2$  reaches  $T_0 := \inf\{t \mid \phi(t) = 0\}$ , then this disk coincides with the intersection of the original set  $f^{-1}([a, c - \epsilon])$  with

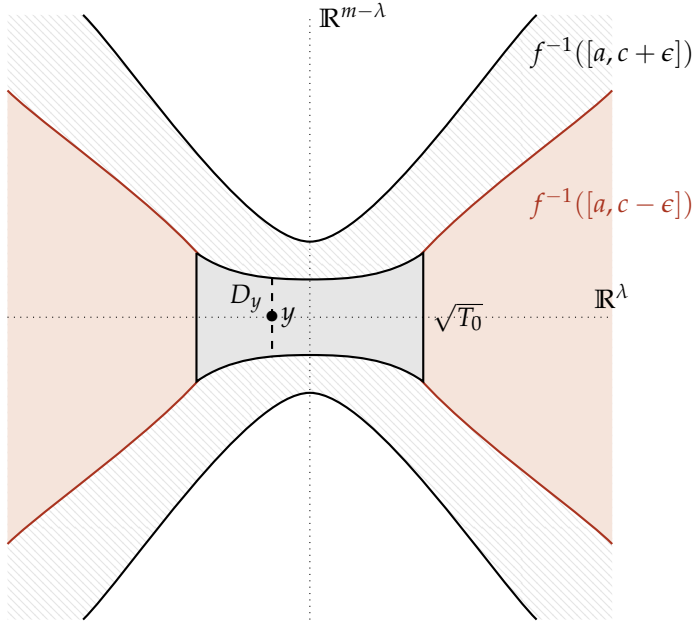

Figure 14.4: The gray part consists of those disks  $D_y$  in the proof of Lemma 14.1.4 that do not coincide with those for the original function  $f$ .

the  $(m - \lambda)$ -dimensional plane  $\{y\} \times \mathbb{R}^{m-\lambda}$ .

To check this, note that this intersection is given by the set  $(y, z) \in \mathbb{R}^\lambda \times \mathbb{R}^{m-\lambda}$  with  $z$  satisfying

$$c - \|y\|^2 + \|z\|^2 - \phi(\|y\|^2 + 2\|z\|^2) \leq c - \epsilon.$$

The condition may be rewritten in terms of  $\alpha(y, z) := \|y\|^2 + 2\|z\|^2$  as

$$\phi(\alpha(y, z)) - \alpha(y, z)/2 \geq \epsilon - \frac{3}{2}\|y\|^2. \quad (14.1)$$

Since  $\phi(t) - t/2$  is decreasing on the interval  $[0, 2\epsilon]$  from  $\phi(0) > \epsilon$  to  $-\epsilon$ , there is a unique  $t_0 > 0$  such that  $\phi(t_0) - t_0/2 = \epsilon - \frac{3}{2}\|y\|^2$ . In terms of  $t_0$ , the inequality (14.1) is equivalent to

$$\|z\|^2 \leq \frac{1}{2}(t_0 - \|y\|^2). \quad (14.2)$$

Since  $\phi(0) > \epsilon$  and  $\phi'(t) > -1$ , we have that  $\phi(t_0) > \epsilon - t_0$ , so that we have  $\phi(t_0) - t_0/2 > \epsilon - \frac{3}{2}t_0$  and thus that  $t_0 > \|y\|^2$ , so the right hand side of (14.2) is strictly positive. The set  $D_y := \{(y, z) \mid \|z\|^2 \leq \frac{1}{2}(t_0 - \|y\|^2)\}$  is the desired disk.  $\square$

We shall then define  $U = F^{-1}([a, c - \epsilon])$ , which is diffeomorphic to  $f^{-1}([a, c + \epsilon])$ . To see this, apply Proposition 14.1.1 using the observation that there is no critical point in  $f^{-1}([a, c + \epsilon]) \setminus U$ . From this observation and part (iii) of the Lemma, we not only obtain the homotopy-theoretic description also the stronger statement that  $f^{-1}([a, c + \epsilon])$  is diffeomorphic to  $(f^{-1}(\{a\}) \times [a, c - \epsilon]) \cup (D^\lambda \times D^{m-\lambda})$ .

**Corollary 14.1.5.** *If  $f$  is proper and  $f^{-1}([a, b])$  contains a unique non-degenerate in its interior, then the sub-level set  $f^{-1}((-\infty, b])$  is given by  $f^{-1}((-\infty, b]) \cup_{\partial D^\lambda \times D^{m-\lambda}} (D^\lambda \times D^{m-\lambda})$  up to diffeomorphism.*

## 14.2 Handles

### Handle decompositions

We say that the manifold with boundary  $f^{-1}((-\infty, b])$  is obtained from  $f^{-1}((-\infty, a])$  by *attaching a handle* (and implicitly smoothing corners, see Chapter 2.6 of [Wal16]):

**Definition 14.2.1.** Let  $M$  be a smooth manifold with boundary  $\partial M$ , and let  $\varphi: \partial D^i \times D^{m-i} \hookrightarrow \partial M$  be a smooth embedding. Then the manifold

$$M \cup_\varphi (D^i \times D^{m-i})$$

is a smooth manifold with boundary (after smoothing corners) and is said to be the result of *attaching a handle* to  $M$ .

We shall also introduce some terminology for handles (see Figure 14.5).

**Definition 14.2.2.** Suppose we are given a handle attachment  $M \cup_\varphi (D^i \times D^{m-i})$ .

- the subset  $D^i \times D^{m-i}$  is called the *handle*, and is said to have *index*  $i$ , so is also called an  *$i$ -handle*,
- the subset  $D^i \times \{0\}$  is called the *core* and its boundary  $\partial D^i \times \{0\}$  the *attaching sphere*,
- the subset  $\{0\} \times D^{m-i}$  is called the *cocore* and its boundary  $\{0\} \times \partial D^{m-i}$  the *transverse sphere*.

A *handle decomposition* of  $M$  is a way of writing  $M$  as obtained by iterated handle attachments from  $\emptyset$ . If we use that generic proper Morse functions exist and that each critical point gives rise to a handle attachment, we conclude that:

**Corollary 14.2.3.** *Every closed smooth manifold admits a handle decomposition.*

This is a necessarily finite handle decomposition, since we remarked before that there can only be finitely many non-degenerate critical points.

**Example 14.2.4.** For example,  $S^n$  has a handle decomposition with a single 0-handle and a single  $n$ -handle. The  $n$ -handle is attached along the identity map  $\partial D^n \times D^0 \cong S^{n-1} \rightarrow S^{n-1} \cong \partial(D^0 \times D^n)$ .

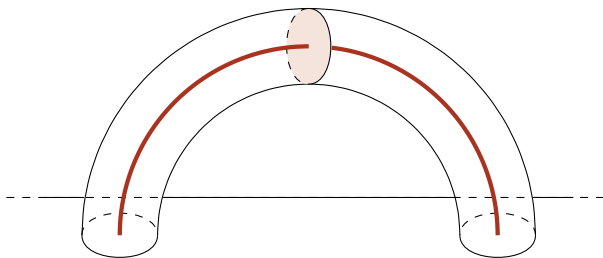

Figure 14.5: A 3-dimensional 1-handle attached to  $\mathbb{R}^2 = \partial(\mathbb{R}^2 \times (-\infty, 0])$ . The colored 2-disk is the cocore (its boundary the transverse sphere), the thick line (i.e. 1-disk) the core (its boundary the attaching sphere).

### An application

We shall deduce a corollary about the topology of manifolds from this:

**Corollary 14.2.6.** *Every compact smooth manifold has the homotopy type of a finite CW-complex.*

*Proof.* The proof is by induction over the number of handles, the case of no handles being trivial. If  $M$  is a CW-complex, then  $M \cup_{\varphi} (D^i \times D^{m-i})$  deformation retracts onto  $M \cup_{\varphi|_{\text{core}}} (D^i \times \{0\})$ . This amounts to attaching a cell to a CW complex, and it is well-known that a space obtained by attaching a cell to a CW complex is homotopy equivalent to a CW complex (you just need to rearrange the order of the cell attachments to that the next  $i$ -cell is attached to the  $(i-1)$ -skeleton).  $\square$

**Remark 14.2.5.** In fact, even compact topological manifolds have the homotopy type of a finite CW-complex [Mil59], though they need not admit handle decompositions [FQ90].





## Handle modifications

In the previous lecture we proved that closed manifolds admit handle decompositions. Now we shall apply the same theory to cobordisms, and give several lemmas that will aid us in the manipulation of handle decompositions. The main reference of this material is the first chapter of [Lö2], but see also Chapters VI and VII of [Kos93], Chapter 5 of [Wal16], and Milnor's book [Mil65] for a purely Morse-theoretic approach. We prefer the handle-theoretic approach, since it applies to PL and topological manifolds once one establishes transversality, isotopy extension and the existence of handle decompositions.

### 15.1 Cobordisms

We start with the definition of a cobordism, see Figure 15.1 for an example in the case  $m = 1$ .

**Definition 15.1.1.** Let  $M_0, M_1$  be closed manifolds of the same dimension  $m$ . A *cobordism* from  $M_0$  to  $M_1$  consists of a 5-tuple  $(W, \partial_0(W), f_0, \partial_1(W), f_1)$  where  $W$  is a compact  $(m + 1)$ -dimensional manifold with boundary  $\partial(W)$ ,  $\partial_0(W)$  and  $\partial_1(W)$  are submanifolds of  $\partial(W)$  and  $\partial(W) = \partial_0(W) \sqcup \partial_1(W)$ , and  $f_0: M_0 \rightarrow \partial_0(W)$  and  $f_1: M_1 \rightarrow \partial_1(W)$  are diffeomorphisms.

Handle attachments give rise to cobordisms. In describing this, it shall be useful to change the focus to the cobordism, whose dimension is  $w$ . Indeed, given an embedding  $\phi: \partial D^i \times D^{w-i} \hookrightarrow \partial_0(W) \times \{1\}$ , we obtain a cobordism by taking

$$(\partial_0(W) \times I) \cup_{\phi} (D^i \times D^{w-i})$$

and smoothing the corners. I find Lück's notation convenient for this,  $(\partial_0(W) \times I) + (\phi)$ . This is a cobordism from  $\partial_0(W)$  to the manifold  $\partial_1(W) := \partial_1((\partial_0(W) \times I) + (\phi))$  given by

$$(\partial_0(W) \setminus \phi(\partial D^i \times \text{int}(D^{w-i})) \cup (D^i \times \partial D^{w-i}),$$

Takeaways:

- One may change the attaching map of a handle up to isotopy.
- Transversality may be used to move the attaching map of a  $j$ -handle off an  $i$ -handle if  $i \geq j$ . Consequently, handles may be rearranged in order of increasing index.
- If an attaching sphere of a handle intersects a transverse sphere of another handle transversally in a single point, these handles cancel.

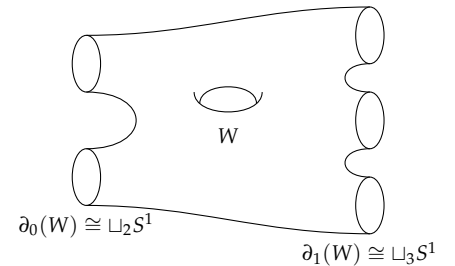

Figure 15.1: A cobordism from  $S^1 \sqcup S^1$  to  $S^1 \sqcup S^1 \sqcup S^1$ .

**Example 15.1.2.** Every closed  $(m + 1)$ -dimensional manifold is a cobordism from  $\emptyset$  to  $\emptyset$ .

which is said to be the result of *doing surgery along  $\phi$  to  $\partial_0(W)$* .

If we attach a second handle to  $\partial_1(W)$  along  $\phi'$  we get a larger cobordism  $(\partial_0(W) \times I) + (\phi) + (\phi')$ . Note that the order matters;  $(\partial_0(W) \times I) + (\phi') + (\phi)$  does not even make sense, as  $\phi'$  does not have image in  $\partial_0(W) \times \{1\}$  and hence can not be used to attach a handle.

In fact, all cobordisms can be written as iterated handle attachments. To see this, we use that our previous results imply that there is a generic Morse function  $f: W \rightarrow \mathbb{R}$  that takes the value 0 on  $\partial_0(W)$  and 1 on  $\partial_1(W)$  and is regular near the boundary. Each critical point of this Morse function will correspond to a handle and since critical points are isolated and  $W$  is compact, there are only finitely many.

**Proposition 15.1.3.** *Every cobordism  $W$  can be written up to diffeomorphism rel  $\partial_0(W)$  as*

$$(\partial_0(W) \times I) + (\phi_1) + \dots + (\phi_k),$$

and  $\partial_1(W)$  is hence diffeomorphic to  $\partial_0(W)$  modified by finitely many surgeries.

One next immediate goal is to see how we can manipulate handle decompositions without changing the diffeomorphism type of the cobordism rel  $\partial_0(W)$ . We will see that we can in particular make the following changes:

- (1) Change the  $\phi_i$ 's by isotopes.
- (2) When  $\text{index}(\phi_i) \geq \text{index}(\phi_{i+1})$ , interchange  $\phi_i$  and  $\phi_{i+1}$  after an isotopy of  $\phi_{i+1}$ .
- (3) When  $\text{index}(\phi_{i+1}) = \text{index}(\phi_i) + 1$  and the attaching sphere of  $\phi_{i+1}$  meets the transverse sphere of  $\phi_i$  transversally in a single point, cancel  $\phi_i$  and  $\phi_{i+1}$ .

The last part contained some terminology introduced at the end of last section, which we review. We call that for a handle  $D^i \times D^{w-i}$ ,  $D^i \times \{0\}$  was called the *core* and  $\{0\} \times D^{w-i}$  the *cocore*. The boundary  $\partial D^i \times \{0\}$  of the core is the *attaching sphere*, and the boundary  $\{0\} \times \partial D^{w-i}$  of the cocore is the *transverse sphere*.

In the next chapters we will develop more subtle tools to manipulate handle decompositions, culminating in the  $s$ -cobordism theorem. These have topological assumptions, in contrast with the tools in this chapter.

## 15.2 The handle isotopy lemma

We start by proving that changing the map  $\phi$  by an isotopy does not affect the diffeomorphism type of the cobordism rel  $\partial_0(W)$ .

**Lemma 15.2.1** (Handle isotopy lemma). *If  $\phi_1$  is isotopic to  $\phi'_1$ , then  $W + (\phi_1)$  is diffeomorphic to  $W + (\phi'_1)$  rel  $\partial_0(W)$ .*

*Proof.* Let  $\phi_1(t): D^i \times D^{w-i} \times [0, 1] \rightarrow \partial_1(W) \times [0, 1]$  denote the isotopy of embeddings, with  $\phi_1(0) = \phi_1$  and  $\phi_1(1) = \phi'_1$ . By the isotopy extension theorem, there is an isotopy of diffeomorphisms  $f_t: \partial_1(W) \times [0, 1] \rightarrow \partial_1(W) \times [0, 1]$  such that  $f_0 = \text{id}$  and  $\phi_1(1) = f_1 \circ \phi_1(0)$ . Now let  $c: \partial_1(W) \times [0, 1] \rightarrow W$  be a collar, and define a diffeomorphism

$$F: W + (\phi_1) \rightarrow W + (\phi_1)$$

$$p \mapsto \begin{cases} c(f_{1-t}(q), t) & \text{if } p = c(q, t) \in W, \\ p & \text{otherwise.} \end{cases} \quad \square$$

Suppose that before applying the handle isotopy lemma, a handle is attached using  $\phi_2$  to  $W + (\phi_1)$ . Then we can use  $\phi'_2 := F \circ \phi_2$  as an attaching map to  $W + (\phi'_1)$ , where  $F: W + (\phi_1) \rightarrow W + (\phi'_1)$  is the diffeomorphism defined in the proof of Lemma 15.2.1. Then the diffeomorphism  $W + (\phi_1) \cong W + (\phi'_1)$  extends to a diffeomorphism  $W + (\phi_1) + (\phi_2) \cong W + (\phi'_1) + (\phi'_2)$ . Thus if we modify one handle by an isotopy, we can compatibly modify subsequent handles too.

### 15.3 The handle rearrangement lemma

We will use the handle isotopy lemma to prove the handle rearrangement lemma. Recall that the outgoing  $\partial_1(W + (\phi_0))$  is obtained from  $\partial_1(W)$  by a surgery, and in particular contains the subset  $\partial_1(W) \setminus \phi_0(\partial D^i \times \text{int}(D^{w-i}))$  of  $\partial_1(W)$ .

**Lemma 15.3.1** (Handle rearrangement). *Suppose we are given a cobordism  $W + (\phi_0) + (\phi_1)$ . If  $\text{index}(\phi_0) \geq \text{index}(\phi_1)$ , we may isotope  $\phi_1$  to  $\phi'_1$  with image in  $\partial_1(W + (\phi_0)) \setminus \phi_0(\partial D^{i_0} \times \text{int}(D^{w-i_0}))$ , where  $i_0 := \text{index}(\phi_0)$ .*

*Proof.* There are four steps. We shall use the notation  $i_0 := \text{index}(\phi_0)$  and  $i_1 := \text{index}(\phi_1)$ .

*Step 1(a): make transverse and attaching spheres disjoint.* Our first step is to show that we can make the attaching spheres of  $\phi_1$  disjoint from the transverse sphere of  $\phi_0$  by an isotopy of  $\phi_1$ .

We know by transversality results discussed in Chapter 12 that by an ambient isotopy of  $\partial_1(W + (\phi_0))$  we can make the attaching sphere of  $\phi_1$  transverse to the transverse sphere of  $\phi_0$ . This transverse sphere is diffeomorphic to  $\{0\} \times \partial D^{w-i_0}$  and thus  $(w - i_0 - 1)$ -dimensional, while the attaching sphere is diffeomorphic to  $\partial D^{i_1} \times \{0\}$  and thus  $(i_1 - 1)$ -dimensional. They live in the

$(w - 1)$ -dimensional manifold  $\partial_1(W + (\phi_0))$ , so they are transverse if and only if they are disjoint.

*Step 1(b): shrink rest of image to be disjoint from attaching sphere.* By shrinking the  $D^{w-i_1}$ -direction of the image of  $\phi_1$ , we can make the entire image of  $\partial D^{i_1} \times D^{w-i_1}$  under  $\phi_1$  disjoint from the transverse sphere.

*Step 2(a): flow attaching sphere out of handle.* Now pick a vector field on  $\partial_1(W + (\phi_0)) \setminus \text{transverse}(\phi_0)$  that is pointing radially outwards in  $D^{w-i_0} \setminus \{0\}$ -direction of  $\phi_0((D^{i_0} \setminus \{0\}) \times \partial D^{w-i_0})$ . Flowing along this for finite time will isotope the attaching sphere of  $\phi_1$  out of  $\phi_0((D^i \setminus \{0\}) \times \partial D^{w-i})$ .

*Step 2(b): shrink rest of image out of handle.* By shrinking the  $D^{w-i_1}$  direction of the domain  $\partial D^{i_1} \times D^{w-i_1}$  of  $\phi_1$ , we can isotope  $\phi_1$  so that its image lies in the complement of  $\phi(D^{i_0} \times \partial D^{w-i_0})$  in  $M$ .  $\square$

By the handle isotopy lemma,  $W + (\phi_0) + (\phi_1)$  and  $W + (\phi_0) + (\phi'_1)$  are diffeomorphic rel  $\partial_0(W)$ . But in the conclusion of the lemma, we *can* make sense of  $M + (\phi'_1) + (\phi_0)$  and it is clear that this is diffeomorphic to  $W + (\phi_0) + (\phi_1)$  rel  $\partial_0(W)$ . Let us record this:

**Lemma 15.3.2** (Handle rearrangement lemma). *Given a cobordism  $W + (\phi_0) + (\phi_1)$ , if  $\text{index}(\phi_0) \geq \text{index}(\phi_1)$ , we may isotope  $\phi_1$  to  $\phi'_1$  such that  $W + (\phi_0) + (\phi_1)$  is diffeomorphic to  $W + (\phi'_1) + (\phi_0)$  rel  $\partial_0(W)$ .*

Thus we can always arrange the handle attachments to happen in order of increasing index, and have all handles of the same index by attaching simultaneously.

**Corollary 15.3.3.** *Every cobordism  $W$  is diffeomorphic rel  $\partial_0(W)$  to one of the form*

$$(\partial_0(W) \times I) + \sum(\phi_{i_0}^0) + \dots + \sum(\phi_{i_w}^w),$$

where the superscript denotes the index of the handle.

**Remark 15.3.4.** In the duality between handle decomposition and Morse functions, this implies that every Morse functions is homotopic through Morse functions to a self-indexing one, i.e.  $f(\partial_0(W)) = -1$ ,  $f(\partial_1(W)) = w + 1$  and  $f(p) = \text{index}(p)$  for each critical point. This simplifies the proof in the previous lecture that compact smooth manifolds admit a finite CW decomposition.

#### 15.4 The handle cancellation lemma

So far we have only rearranged the handles, but not changed the number (or indices) of handles. Now we described a special situation where you can remove two handles of adjacent index.

**Example 15.4.1.** We have already seen a case of this where discussing Hatcher's proof of the Smale conjecture. Supposed that we have a 0-handle  $\phi_0$  and a 1-handle  $\phi_1$  so that  $\phi_1$  one component of  $\partial D^1 \times D^{w-1}$  is mapped to  $\phi_0(\partial D^w) \subset W + (\phi_0)$ . Then up to isotopy, we may assume  $\phi_1$  is a standard embedding, and  $W + (\phi_0) + (\phi_1)$  is given by glueing a disk  $D^w$  to  $\partial_1(W)$  along half its boundary  $D^{w-1} \subset \partial D^w$ . We saw before this is diffeomorphic to  $W \text{ rel } \partial_0(W)$ .

The following lemma is the generalization of this from adjacent indices 0 and 1, to adjacent indices  $i$  and  $i + 1$ .

**Lemma 15.4.2** (Handle cancellation lemma). *Given a cobordism  $W + (\phi_0) + (\phi_1)$  with  $\text{index}(\phi_1) = \text{index}(\phi_0) + 1$  so that the attaching sphere  $\phi_1$  intersects the transverse sphere  $\phi_0$  transversally in a single point, there is a diffeomorphism from  $W + (\phi_0) + (\phi_1)$  to  $W \text{ rel } M_0$ .*

*Proof.* We now use the notation  $i := \text{index}(\phi_0)$ , so that  $\text{index}(\phi_1) = i + 1$ . Our strategy will be to isotope  $\phi_1$  so that it has a certain standard form on  $\partial(W + (\phi_0))$ , and then find nice coordinates to reduce to a computation in a standard model. Let us identify  $D^i \times \partial D^{w-i}$  with a subset of  $\partial(W + (\phi_0))$ .

*Step 1(a): make intersection point standard* Recall that  $\partial D^{i+1} \times \{0\} \subset \partial D^{i+1} \times D^{w-i-1}$  is the attaching sphere of  $(\phi_1)$ . By rotating  $\partial D^{i+1}$ , and dilating and translating  $D^{w-i-1}$ , we can assume that  $\phi_1^{-1}(\phi_1(\partial D^{i+1} \times D^{w-i-1}) \cap (\{0\} \times \partial D^{w-i})) = (\vec{e}_1, 0)$  and  $\phi_1(\vec{e}_1, 0) = (0, \vec{e}_1)$ .

*Step 1(b): make derivative at intersection point standard* Now we consider the derivative of  $\phi_1$  at  $(\vec{e}_1, 0)$ , a bijective linear map

$$T_{(\vec{e}_1, 0)}(\partial D^{i+1} \times D^{w-i-1}) \cong \mathbb{R}^i \times \mathbb{R}^{w-i-1} \xrightarrow{D_{(\vec{e}_1, 0)}\phi_1} T_{(0, \vec{e}_1)}(D^i \times \partial D^{w-i}) \cong \mathbb{R}^i \times \mathbb{R}^{w-i-1}.$$

By transversality of the intersection of the attaching sphere with the transverse sphere, the composition

$$\mathbb{R}^i \times \{0\} \hookrightarrow \mathbb{R}^i \times \mathbb{R}^{w-i-1} \rightarrow \mathbb{R}^i \times \mathbb{R}^{w-i-1} \rightarrow \mathbb{R}^w / \mathbb{R}^{w-i-1} \quad (15.1)$$

is surjective. Since the group of invertible matrices that map  $\mathbb{R}^i$  surjectively onto  $\mathbb{R}^w / \mathbb{R}^{w-i-1}$  is a lower triangular group and hence has at most two connect components, we can homotopy the derivative, so that it is given by id (up to reflection) within losing the property that (15.1) is surjective.

To show that this to homotopy of derivatives is induced by an isotopy of embeddings, we recall that the map

$$\text{Emb}(\partial D^{i+1} \times D^{w-i-1}, \partial(W + (\phi_0))) \rightarrow \text{Fr}(T\partial(W + (\phi_0)))$$

given by recording the derivative at  $(\vec{e}_1, 0)$  is a fibration.

*Step 1(c): make  $\phi_1$  standard near intersection point* The restriction to a hemisphere  $\partial D^{i+1} \times D^{w-i-1} \supset D_+^i \times D^{w-i-1} \rightarrow D^i \times \partial D^{w-i}$  (so that  $(\vec{e}_1, 0)$  corresponds to  $(0, 0)$ ) lands in a hemisphere  $D^i \times D_+^{w-i-1} \subset D^i \times \partial D^{w-i}$  (so that  $(0, \vec{e}_1)$  corresponds to  $(0, 0)$ ). By linear interpolation we can make it the identity near the origin.

*Step 2: make attaching map standard on handle* By first shrinking the  $D^{w-i-1}$ -direction and then flowing along an appropriate vector field as in Step 2 of Lemma 15.3.1 and reparametrizing, we can make  $\phi_1$  standard on the entire handle, in the sense that the map  $\partial D^{i+1} \times D^{w-i-1} \supset D_+^i \times D^{w-i-1} \rightarrow D^i \times D_+^{w-i-1} \subset D^i \times \partial D^{w-i}$  is the identity.

*Step 3: find standard coordinates* We may now use  $\phi_1$  itself to find nice coordinates of the part of the image of  $\phi_1$  outside of the handle. Indeed, we may identify that image using  $\phi_1$  with  $D_-^i \times D^{w-i-1}$ . Combining the image of  $\phi_0$  and this part of the image of a  $\phi_1$ , we obtain a subset of  $\partial_1(W)$  identified with

$$(\partial D^i \times D^{w-i}) \cup_{\partial D^i \times D_-^{w-i-1}} (D_-^i \times D^{w-i-1}) \cong D^{w-1}.$$

*Step 4: prove result in standard model* In these coordinates, we first attach an  $i$ -handle along

$$\varphi_0: \partial D^i \times D^{w-1} \rightarrow D^{n-1} \cong (\partial D^i \times D^{w-i}) \cup_{\partial D^i \times D_-^{w-i-1}} (D_-^i \times D^{w-i-1})$$

given by the inclusion of the first term. Next we attach an  $(i+1)$ -handle along the inclusion of the union  $(D_-^i \times D^{w-i-1}) \cup_{\partial D^i \times D_-^{w-i-1}} (D_+^i \times D^{w-i-1}) \cong \partial D^{i+1} \times D^{w-i-1}$ . In a local model, one can prove this is diffeomorphic to attaching  $D^n$  along an embedding of a bottom hemisphere  $D_-^{n-1} \subset \partial D^n$ , and we say before that this is diffeomorphic rel  $\partial_0(W)$  to not attaching anything at all.  $\square$

## Handle exchange

In the previous lectures we proved that manifolds admit handle decompositions, and obtained the handle isotopy, handle rearrangement and handle cancellation lemma's as tools to manipulate handle decompositions. We shall now make additional assumptions on our cobordism  $W$  which shall allow us to use these tools, are results derived from them, to simplify the cobordism. This is based on Chapter 1 of [Lö2], see also Chapter 8 of [Mil65].

### 16.1 Handle decompositions and topology

#### CW decompositions

Let us provide more details about producing a CW-complex out of a rearranged handle decomposition. Suppose that we are given a rearranged handle decomposition

$$W = (\partial_0 W \times I) + \sum_{I_0} (\phi_{i_0}^0) + \dots + \sum_{I_w} (\phi_{i_w}^w),$$

where the superscript denotes the index of the handle. Then we may inductively produce a CW complex  $X$  relative to  $\partial_0 W$  which is homotopy equivalent to  $W \text{ rel } \partial_0 W$ . To do so define

$$W_k := W = (\partial_0 W \times I) + \sum (\phi_{i_0}^0) + \dots + \sum (\phi_{i_k}^k),$$

and remark that  $W_{-1} = (\partial_0 W \times I)$  and  $W_k$  is obtained from  $W_{k-1}$  as a pushout

$$\begin{array}{ccc} \bigsqcup_{I_k} \partial D^k \times D^{w-k} & \xrightarrow{\bigsqcup f_{k-1} \circ \phi_{i_k} |_{\partial D^k \times \{0\}}} & W_{k-1} \\ \downarrow & & \downarrow \\ \bigsqcup_{I_k} D^k \times D^{w-k} & \longrightarrow & W_k. \end{array} \quad (16.1)$$

We then define  $X_{-1} = \partial_0 W$  with homotopy equivalence  $f_{-1}: W_{-1} = \partial_0 W \times I \rightarrow X_{-1}$  given by projection onto the first component, and inductively produce  $X_k$  with map  $f_k: W_k \rightarrow X_k$  by letting  $X_k$  be defined

Takeaways:

- Rearranged handle decompositions correspond to relative CW decompositions.
- Topologically the simplest cobordisms are  $h$ -cobordisms, where the inclusions of  $\partial_0(W)$  and  $\partial_1(W)$  into  $W$  are weak equivalences.
- If certain geometric conditions are satisfied, it is possible to exchange an  $i$ -handle for an  $(i+2)$ -handle. This allows one to remove the  $0, 1, w-1, w$ -handles of an  $h$ -cobordism.

as the pushout

$$\begin{array}{ccc}
 \bigsqcup_{I_k} \partial D^k & \xrightarrow{\bigsqcup f_{k-1} \circ \phi_{i_k} |_{\partial D^k \times \{0\}}} & X_{k-1} \\
 \downarrow & & \downarrow \\
 \bigsqcup_{I_k} D^k & \xrightarrow{\quad\quad\quad} & X_k,
 \end{array} \tag{16.2}$$

and letting  $f_k$  be induced by the obvious map of commutative diagrams from (16.1) to (16.2) induced by the projection  $D^{w-k} \rightarrow *$  and the map  $f_{k-1}: W_{k-1} \rightarrow X_{k-1}$ . We're finished when  $k = w$ , and we set  $X := X_w$ .

This construction is easily seen to have the following properties. Firstly, the  $k$ -cells of  $X$  are in bijection with the  $k$ -handles of  $X$ , so that

$$\begin{aligned}
 H_*(W_k, W_{k-1}) &\cong \bigoplus_{I_k} H_*(D^k \times D^{w-k}, \partial D^k \times D^{w-k}) \\
 &\cong \bigoplus_{I_k} H_*(D^k, \partial D^k) \\
 &\cong H_*(X_k, X_{k-1}).
 \end{aligned}$$

In computing cellular homology, we use these identifications in combination with the map

$$\partial_k: H_*(X_k, X_{k-1}) \rightarrow H_{*-1}(X_{k-1}) \rightarrow H_{*-1}(X_{k-1}, X_{k-2})$$

to obtain a small chain complex computing the homology of  $X$  (and hence  $W$ ). Given the bases of  $H_*(X_k, X_{k-1})$  and  $H_{*-1}(X_{k-1}, X_{k-2})$  in terms of handles, we can compute the coefficient of  $\partial_k$  from a  $k$ -cell  $D_{i_k}^k$  to a  $(k-1)$ -cell  $D_{i_{k-1}}^{k-1}$ , as the intersection number of the attaching sphere of the corresponding  $k$ -handle with the transverse sphere of the  $(k-1)$ -handle (i.e. the number of points in a transverse sphere of the  $(k-1)$ -handle (i.e. the number of points in a transverse perturbation counted with sign). Note this involves a choice of orientation of the core of each handle (which then induces one via your favorite convention on the attaching and transverse sphere), just like in the cellular homology of a CW complex we implicitly choose an orientation on each cell.

### *Poincaré duality*

Thus we can compute  $H_*(W, \partial_0 W)$  from the geometric data of the handles and the intersection numbers of attaching spheres and transverse spheres of adjacent indices.

A classical consequence is a special case of Poincaré duality. Without loss of generality we may add a little collar  $\partial_1(W) \times I$  at the end of a cobordism. In that case, we can read the handle decompositions backwards; we note that each  $i$ -handle contributes



a subset  $D^i \times D^{w-i}$  to  $W$ , and we can start at  $\partial_0(W)$ , thinking of each of these as attached along  $\partial D^i \times D^{w-i}$ . However, we can also start at  $\partial_1(W)$ , thinking of each of these as attaching along  $\partial(D^i \times D^{w-i}) \setminus \partial D^i \times D^{w-i} = D^i \times \partial D^{w-i}$ . This converts attaching spheres in transverse spheres and vice versa.

To translate the matrix of  $\partial_k$  with respect to the bases of handles from the original handle decomposition to the reversed one, we run into a difficulty is that an orientation of a core does not induce a canonical orientation of the cocore unless  $W$  is oriented. But if we assume  $W$  is oriented, then the matrix for  $\partial_k$  for the reversed handle decomposition is the transposes up to sign of the matrix for  $\partial_k$  of the original handle decomposition. From this we conclude that

$$H_*(W, \partial_1(W)) \cong H_{w-*}(W, \partial_0(W)),$$

a version of Poincaré duality.

### *h-cobordisms*

We shall use the relationship between handle decompositions and homology by translating statements about homology to statements about the intersection numbers of attaching spheres and transverse spheres. The goal is to produce a pair of handles that has a single transverse intersection point, so that we can apply handle cancellation to simplify the handle decomposition. The following definition will give us the topological information about a cobordism which shall allow us to achieve this goal in many cases:

**Definition 16.1.1.** A cobordism  $(W, M_0, M_1, f_0, f_1)$  is said to be an *h-cobordism* if both inclusions  $M_0 \hookrightarrow W$  and  $M_1 \hookrightarrow W$  are weak equivalences.

From now on our task will be to simplify handle decompositions of *h-cobordisms*.

### 16.2 *The handle exchange lemma*

Occasionally it is helpful to create to new handles. This is done using the handle addition lemma, obtained by running the proof of the handle cancellation lemma in reverse.

**Lemma 16.2.1** (Handle addition). *Given an embedding  $D^{w-1} \hookrightarrow \partial_1(W)$ , let  $\phi_0: \partial D^i \times D^{w-i} \rightarrow \partial_1(W)$  denote the restriction to a standard  $\partial D^i \times D^{w-i} \subset D^{w-1}$ . Then there exists an embedding  $\phi_1: \partial D^{i+1} \times D^{w-i-1} \rightarrow \partial_1(W + (\phi_0))$  such that  $W \cong W + (\phi_0) + (\phi_1)$ .*

Following Lück, we say an attaching map  $\phi_0: \partial D^i \times D^{w-i} \rightarrow \partial_1(W)$  is *trivial* if it is the restriction to  $\partial D^i \times D^{w-i}$  of an embedding  $D^{w-1} \hookrightarrow \partial_1(W)$ . Note that  $\phi_0$  is trivial.

The handle addition lemma is often used to *create* a  $(i+1)$ -handle custom built to cancel an  $i$ -handle, at the expense of create a new  $(i+2)$ -handle. This procedure is called a *handle exchange*, since we exchanged an  $i$ -handle to an  $(i+2)$ -handle. We introduce some notation in addition to  $W^i$ , the subcobordism with only  $j$ -handles for  $j \leq i$ :

$$\hat{\partial}_1(W^i) := \partial_1(W^i) \setminus \bigsqcup_{I_{i+1}} \phi_j^{i+1}(\partial D^{i+1} \times D^{w-i-1})$$

is the complement of the images of the attaching maps of the  $(i+1)$ -handles.

**Lemma 16.2.2** (Handle exchange). *Let  $W$  have a handle decomposition given by*

$$W = \partial_0(W) \times I + \sum(\phi_j^i) + \sum(\phi_j^{i+1}) + \dots + \sum(\phi_j^w).$$

Suppose that for one of the  $i$ -handles  $\phi_{j_0}^i$ , there exists an embedding  $\varphi^{i+1}: \partial D^{i+1} \times D^{w-i-1} \rightarrow \hat{\partial}_1(W^i)$  such that

- (a) *the attaching sphere of  $\varphi^{i+1}$  is isotopic in  $\partial_1(W^i)$  to an embedding intersecting the belt sphere of  $\phi_{j_0}^i$  transversally in a single point.*
- (b)  *$\varphi^{i+1}$  is isotopic to a trivial embedding in  $\partial_1(W^{i+1})$ .*

Then  $W$  is diffeomorphic rel  $\partial_0(W)$  to

$$W = \partial_0(W) \times I + \sum_{j \neq j_0}(\phi_j^i) + \sum(\phi_j^{i+1}) + (\bar{\varphi}^{i+2}) + \dots + \sum(\phi_j^w).$$

*Proof.* We can disregard all handles of index  $> i+1$ . By handle addition we have that

$$\begin{aligned} W &= \partial_0(W) \times I + \sum(\phi_j^i) + \sum(\phi_j^{i+1}) \\ &\cong \partial_0(W) \times I + \sum(\phi_j^i) + \sum(\phi_j^{i+1}) + (\bar{\varphi}^{i+1}) + (\bar{\varphi}^{i+2}) \end{aligned}$$

for some  $\bar{\varphi}^{i+1}$  isotopic to  $\varphi^{i+1}$  and  $\bar{\varphi}^{i+2}$  coming from handle addition. By handle isotopy we have that

$$\begin{aligned} W &\cong \partial_0(W) \times I + \sum(\phi_j^i) + \sum(\phi_j^{i+1}) + (\bar{\varphi}^{i+1}) + (\bar{\varphi}^{i+2}) \\ &\cong \partial_0(W) \times I + \sum(\phi_j^i) + \sum(\phi_j^{i+1}) + (\varphi^{i+1}) + (\bar{\varphi}^{i+2}), \end{aligned}$$

and now  $\varphi^{i+1}$  has image in  $\hat{\partial}_1(W^i)$ . Thus we may interchange it with the  $(i+1)$ -handles. Then isotoping  $\varphi^{i+1}$ , we may write this as

$$\begin{aligned} W &\cong \partial_0(W) \times I + \sum(\phi_j^i) + \sum(\phi_j^{i+1}) + (\varphi^{i+1}) + (\bar{\varphi}^{i+2}) \\ &\cong \partial_0(W) \times I + \sum(\phi_j^i) + (\varphi^{i+1}) + \sum(\phi_j^{i+1}) + (\bar{\varphi}^{i+2}) \\ &\cong \partial_0(W) \times I + \sum(\phi_j^i) + (\bar{\varphi}^{i+1}) + \sum(\phi_j^{i+1}) + (\bar{\varphi}^{i+2}) \end{aligned}$$

where  $\tilde{\varphi}^{i+1}$  has an attaching sphere which intersects the belt sphere of  $\phi_{j_0}^i$  once transversally, so that we may use handle cancellation to write

$$\begin{aligned} W &\cong \partial_0(W) \times I + \sum(\phi_j^i) + (\tilde{\varphi}^{i+1}) + \sum(\phi_j^{i+1}) + (\tilde{\varphi}^{i+2}) \\ &= \partial_0(W) \times I + \sum_{j \neq j_0}(\phi_j^i) + \sum(\phi_j^{i+1}) + (\tilde{\varphi}^{i+2}). \quad \square \end{aligned}$$

### 16.3 Removing handles of index 0, 1, $w - 1$ , and $w$

We start by explaining how to remove the 0- and 1-handles when  $w \geq 6$ . By reversing the handle decompositions, the same argument also removes the  $w$ - and  $(w - 1)$ -handles.

**Lemma 16.3.1.** *Let  $\partial_0(W) \hookrightarrow W$  be 0-connected. Then there exists a handle decomposition of  $W$  without 0-handles.*

*Proof.* We inductively remove the 0-handles. Since  $\partial_0(W) \rightarrow W$  is a bijection on connected components, for some 0-handle there must a 1-handle connecting its transverse sphere  $\partial D^w$  to  $\partial_1(\partial_0(W) \times I)$ . This 1-handle will have attaching sphere intersecting the transverse sphere  $\partial D^w$  transversally in a single point, so by the handle cancellation Lemma 15.4.2, they cancel. With one less 0-handle, the induction hypothesis kicks in.  $\square$

**Lemma 16.3.2.** *Let  $w \geq 6$  and  $\partial_0(W) \hookrightarrow W$  be 0-connected. Then there exists a handle decomposition of  $W$  without 0- and 1-handles.*

*Proof.* By the previous lemma we may assume there are no 0-handles. We will use the handle exchange lemma to inductively trade each 1-handle for a 3-handle. To do so, it suffices to explain how to build an embedding  $\varphi^2: \partial D^2 \times D^{w-2} \rightarrow \hat{\partial}_1(W^1)$  suited to apply Lemma 16.2.2 to  $(\phi_1^1)$ . The easiest way to guarantee condition (a) is to start with the interval  $S_+^1$  given by restriction of the copy of  $D^1 \times \{\vec{e}_1\}$  inside the  $D^1 \times \partial(D^{n-1})$  inside  $\partial_1(\phi_1^1)$ . This automatically intersects the transverse sphere  $\{0\} \times \partial D^{n-1}$  once transversally.

Since  $\pi_0(\partial_0(W)) \rightarrow \pi_0(W)$  is a bijection and there are no 0-handles, both endpoints have to lie in the same path-component of  $\partial_0(W)$ . Since  $\hat{\partial}_1(W^0) = \partial_1(W) \setminus \bigsqcup_{I_1} \phi_{I_1}^1(\partial D^1 \times D^{w-1})$  is up homotopy given by removing some points from  $\partial_0(W)$  and  $w \geq 6$ , this does not affect path-connectivity. Hence the endpoints of  $S_+^1$  also lie in the same path component of  $\hat{\partial}_1(W^0)$ , and we may connect them by a path  $S_-^1$  there. Since  $w \geq 6$ ,  $\pi_1(\hat{\partial}_1(W^0))$  is isomorphic to  $\pi_1(\partial_1(W^0)) \cong \pi_1(\partial_0(W))$  and hence surjects onto  $\pi_1(W)$ . Thus we may assume  $S^1 := S_+^1 \cup S_-^1$  is null-homotopic in  $W$ , adding a non-trivial loop in  $\hat{\partial}_1(W^0)$  if necessary (which does not affect the fact that  $S^1$  intersects the transverse sphere of  $\phi_1^1$  in a single point).

We may assume  $S^1$  is embedded by transversality, since  $w - 1 \geq 3$ . The result is an embedded circle  $S^1$  in  $\partial_1(W^1)$ , which satisfies the relevant part of condition (a). Since a circle is 1-dimensional and the attaching spheres of the 2-handles are also 1-dimensions, and  $w - 1 \geq 3$ , we can isotope the attaching spheres of the 2-handles so that they do not intersect  $S^1$ , i.e. into  $\hat{\partial}_1(W^1)$ .

We claim that  $\partial_1(W^2) \rightarrow W$  is an isomorphism on  $\pi_1$ . This is the case since to obtain  $W$  from  $\partial_1(W^2)$  one needs to add  $i$ -handles for  $i \geq 3$ , as well as  $(w - 1)$  and  $(w - 2)$ -handles (the 1- and 2-handles on the other side), and  $w - 2 \geq 4$ . Up to homotopy, this amounts to attaching cells of dimension  $\geq 3$ , which does not affect  $\pi_1$ . We conclude that  $S^1$  is nullhomotopic in  $\partial_1(W^2)$ , and because a generic map of a 2-disk into a  $(w - 1)$ -dimensional manifold is embedded when  $n \geq 6$ , bounds an embedded  $D^2$  in  $\partial_1(W^2)$ . This 2-disk guarantees the existence of an extension of  $S^1$  full-fledged  $\varphi^2: \partial D^2 \times D^{w-2}$ , since a disk has trivial normal bundle, satisfying condition (b).  $\square$

**Corollary 16.3.3.** *If  $W$  is an  $h$ -cobordism of dimension  $\geq 6$ , it has a handle decomposition of the form*

$$W = (\partial_0 W \times I) + \sum_{I_2} (\phi_{I_2}^2) + \dots + \sum_{I_{w-2}} (\phi_{I_{w-2}}^{w-2}).$$

## 16.4 Smooth structures on $D^2$

We may use the results obtained in the previous section to prove a result that should have appeared in the previous part of this book.

**Theorem 16.4.1.** *Let  $\Sigma$  be a compact smooth surface with boundary  $S^1$  and such that there is a homotopy equivalence  $\Sigma \rightarrow D^2 \text{ rel } S^1$ . Then  $\Sigma$  is diffeomorphic to  $D^2 \text{ rel } S^1$ .*

*Proof.* Since every homeomorphism of  $S^1$  is homotopic through homeomorphism to a diffeomorphism,  $S^1$  has a unique smooth structure and it suffices to prove that  $\Sigma$  is diffeomorphic to  $D^2$ .

Let us remove a small disk from the interior of  $\Sigma$  to obtain an 2-dimensional smooth cobordism  $S$  from  $S^1$  to  $S^1$ . An easy application of Mayer-Vietoris and Seifert-van Kampen implies  $S$  is an  $h$ -cobordism. In particular, both inclusions  $S^1 \hookrightarrow S$  are homotopy equivalences.

If we put a handle decomposition on  $S$ , then 16.3.1 will allow us to remove the 0- and 2-handles. Thus  $S$  is obtained from  $S^1 \times I$  by adding only 1-handles. However, we cannot add any 1-handles without changing the homology and violating the condition that  $S$  is an  $h$ -cobordism, so in fact we must have that  $S$  is diffeomorphic to  $D^2 \cup S^1 \times I$  and hence diffeomorphic to  $D^2$ .  $\square$

In particular, if  $\Sigma$  is homeomorphic to  $D^2 \text{ rel } S^1$ , then  $\Sigma$  is diffeomorphic to  $D^2$ . This is captured by the slogan:  *$D^2$  has a unique smooth structure rel boundary.*



## The $s$ -cobordism theorem

We finish the proof of the  $h$ -cobordism theorem [Mil65, Kos93, L 2, Wal16], and deduce some consequence for manifolds homotopy equivalent to spheres [Sma61], and the group of path components of diffeomorphisms of disks.

### 17.1 The two-index lemma

Our next goal is to generalize the techniques of the previous lecture to trade  $i$ -handles for  $(i + 2)$ -handles, eventually reaching the following conclusion:

**Lemma 17.1.1** (Two-index lemma). *Let  $2 \leq q \leq w - 3$ . If  $W$  is an  $h$ -cobordism of dimension  $w \geq 6$ , it has a handle decomposition of the form*

$$W = (\partial_0(W) \times I) + \sum_{I_q} (\phi_{I_q}^q) + \sum_{I_{q+1}} (\phi_{I_{q+1}}^{q+1}).$$

For ease of exposition we shall make the following simplification:  $W$  is simply-connected.

*Proof.* It suffices to explain how, for  $i < q$ , to trade an  $i$ -handle in a handle decomposition

$$W = \partial_0(W) \times I + \sum_{I_i} (\phi_{I_i}^i) + \dots + \sum_{I_r} (\phi_{I_r}^r)$$

for an  $(i + 2)$ -handle. We can then inductively remove all handles of index  $< q$ , and reversing the handle decomposition also all handles of index  $> q + 1$ .

Suppose  $(\phi_i^i)$  is the handle we want to exchange. Then we pick a trivial embedding  $\psi^{i+1}: S^i \times D^{w-i-1} \hookrightarrow \hat{\partial}_1(W^i)$ , which is condition (b) of the handle exchange lemma. We show that  $S^i$  admits an isotopy in  $\partial_1(W^{i+1})$  to an embedded sphere lying in  $\hat{\partial}_1(W^i)$  which satisfies property (a) of the handle exchange lemma, i.e. its attaching sphere intersects the transverse sphere of  $(\phi_i^i)$  transversally in a single point.

Takeaways:

- If  $\dim W \geq 6$ , the Whitney trick may be used to show that a homological condition implies that the geometric condition be arranged by an isotopy, implying that an  $h$ -cobordism has a handle decomposition with only  $q, q + 1$ -handles for  $2 \leq q \leq w - 2$ .
- The Whitehead torsion  $\tau(W)$  of  $W$  is an invariant in the algebraic  $K$ -theoretic group  $\text{Wh}_1(\mathbb{Z}[\pi_1])$ , extracted from a two-index handle decomposition by noting which modifications of the matrix of degrees of attaching matrix can be realized geometrically.
- In dimension  $\geq 6$ , an  $h$ -cobordism is diffeomorphic to a product if and only if  $\tau(W) = 0$ .
- This implies homotopy spheres of dimension  $\geq 6$  are homeomorphic to spheres, and that  $\pi_0(\text{Diff}_\partial(D^n))$  surjects onto the set  $\Theta_{n+1}$  of homotopy  $(n + 1)$ -spheres.

We start by noting the relative homology group  $H_i(W, \partial_0(W)) = 0$  because  $W$  is an  $h$ -cobordism, and there are no  $i'$ -handles for  $i' < i$ . Thus we must have that in the cellular chain complex  $[\phi_i^i] = \sum a_j d[\phi_j^{i+1}]$ . That is, there is some formal  $\mathbb{Z}$ -linear combination of the attaching spheres of the  $(i+1)$ -handles  $\phi_j^{i+1}$  which has intersection number 1 with the transverse sphere of  $\phi_i^i$ .

We shall explain how to modify  $S^i \times D^{w-i-1}$  by an isotopy in  $\partial_1(W^{i+1})$  to an embedding in  $\hat{\partial}_1(W^i)$  which represents  $\sum a_j d[\phi_j^{i+1}]$ . To do so, it suffices to explain how to add a single copy of  $d[\phi_j^{i+1}]$  (or its negative). This is called a *handle slide*. Pick one of the infinitely many parallel translates  $\bar{S}_j^i$  of the  $i$ -dimensional attaching sphere  $(\phi_j^{i+1})$  in  $\hat{\partial}_1(W^i)$  (these certainly exist after shrinking the  $D^{w-i}$ -direction of  $\phi_j^{i+1}$ ). Now pick an arc in  $\hat{\partial}_1(W^i)$  from  $\vec{e}_1 \in S^i$  to a point in  $\bar{S}_j^i$ . Generically the arc is embedded and its interior avoids  $S^i$  and  $\bar{S}_j^i$ . We may thicken it to a  $I \times D^i$ , so that  $\{0, 1\} \times D^{w-i-1}$  coincide with  $S^i$  and  $\bar{S}_j^i$ , with orientations depending on the desired sign. We use the arc to create an embedded connected sum  $S^i \# \bar{S}_j^i$  in  $\hat{\partial}_1(W^i)$ . By construction  $\bar{S}_j^i$  bounds an  $(i+1)$ -dimensional disk in  $\partial_1(W^{i+1})$ , and thus  $S^i \# \bar{S}_j^i$  is isotopic to  $S^i$  in  $\partial_1(W^{i+1})$ . By isotopy extension, we extend  $S^i$  to  $S^i \times D^{w-i-1}$ .

This is a candidate  $S^i \times D^{w-i-1}$  which almost satisfies (a) and (b), with the exception that in (a) instead of the actual number of intersection point being 1, we only have that the intersection number of  $S^i$  with the transverse sphere of  $\phi_i^i$  is 1. We now use a consequence of the Whitney trick; this consequence says since  $\hat{\partial}_1(W^i)$  is at least 5-dimensional,  $i$  is at least 2 and  $w - i - 1 \leq w - 3$  with the complement of the  $(w - i - 1)$ -dimensional transverse sphere of  $\phi_i^i$  in  $\hat{\partial}_1(W^i)$  simply-connected, we can isotope  $S^i$  such that actual number of intersection points is 1. An application of the exchange lemma now exchanges  $(\phi_i^i)$  for an  $(i+2)$ -handle.  $\square$

## 17.2 Manipulating two-index $h$ -cobordisms

Now we have reached the stage where for  $2 \leq q \leq w - 3$ , the  $h$ -cobordism  $W$  has a handle decomposition of the form

$$W = (\partial_0 W \times I) + \sum_{I_q} (\phi_{I_q}^q) + \sum_{I_{q+1}} (\phi_{I_{q+1}}^{q+1}).$$

### Manipulation of the remaining handles

Since  $W$  is an  $h$ -cobordism, the relative homology  $H_*(W, \partial_0(W))$  has to vanish. Thus the differential  $\partial_q$  from the free abelian group on  $(q+1)$ -handles to that on  $q$ -handles has to be an isomorphism.



In particular  $I_q = r = I_{q+1}$ , and taking the handles as a basis we obtained an invertible  $(r \times r)$ -matrix  $D_q$  representing over the integers. We have shown how to do three manipulations on the handles which affects this matrix:

- (i) We can change the arbitrary choice of orientations we made, multiplying a row or column by  $-1$ .
- (ii) We can change the order of the handles, switching rows and columns.
- (iii) We use handle addition to add a canceling pair of handles, which replaces  $D_q$  by

$$\begin{bmatrix} D_q & 0 \\ 0 & 1 \end{bmatrix}.$$

- (iv) We can do a handle slide as in the proof of Lemma 17.1.1, which adds a multiple of one column to another (or a row if we reverse the handle decomposition).

If  $W$  were not simply-connected, we should instead have lifted everything to the universal cover and would have obtained an isomorphism  $\tilde{d}_q$  of free  $\mathbb{Z}[\pi_1]$ -modules with canonical basis after a choice of lift of handles, so that we get a representative matrix  $\tilde{D}_q$  with entries in  $\mathbb{Z}[\pi_1]$  on which geometrically we can do the following operations:

- (i) We can change the arbitrary choice of orientations and lifts we made, multiplying a row or column by  $\pm\gamma$  for  $\gamma \in \pi_1$ .
- (ii) We can change the order of the lifts of handles, switching rows and columns.
- (iii) We use handle addition to add a canceling pair of handles, which replaces  $\tilde{D}_q$  by

$$\begin{bmatrix} \tilde{D}_q & 0 \\ 0 & 1 \end{bmatrix}. \tag{17.1}$$

- (iv) We can do a handle slide as in the proof of Lemma 17.1.1, which adds a  $\mathbb{Z}[\gamma]$ -multiple of one column to another (or a row if we reverse the handle decomposition).

If it is possible to reduce the matrix  $\tilde{D}_q$  to the identity matrix using these operations, we can apply the Whitney trick as in Lemma 17.1.1 to cancel all the  $i$ -handles against an  $(i+1)$ -handles and end up with a handle decomposition without any handles!

### *The Whitehead torsion*

Let us define a group which carries the obstruction to this. We first note that third operation amount to multiplication with an elementary matrix  $e_{ij}(a)$  for  $i \neq j$  and  $a \in \mathbb{Z}$ , which is equal to the identity matrix except the  $(i, j)$ th entry is  $a$  instead of 0.

This leads to define for any ring  $R$ , here  $\mathbb{Z}[\pi_1]$ , the group  $E_n(R)$  as the subgroup  $\mathrm{GL}_n(R)$  generated by elementary matrices. If  $n \geq 3$ , elementary matrices are commutators; for  $i, j, k$  all distinct we have

$$e_{ik}(ab) = [e_{ij}(a), e_{jk}(b)].$$

This contains (up to sign) matrices switching rows or columns as in (ii) by modifying the following expression for  $n = 2$ :

$$e_{12}(1)e_{12}(-1)e_{12}(1) = \begin{bmatrix} 0 & 1 \\ -1 & 0 \end{bmatrix} \quad (17.2)$$

Taking the colimit  $E(R)$  over the map (17.1),  $\mathrm{colim}_{n \rightarrow \infty} E_n(R)$ , we claim we get the commutator subgroup of  $\mathrm{GL}(R) := \mathrm{colim}_{n \rightarrow \infty} \mathrm{GL}_n(R)$ . This uses the equation in  $\mathrm{GL}_{2n}(R)$  for  $[g, h] \in \mathrm{GL}_n(R)$  stabilized  $n$  times;

$$[g, h] = \begin{bmatrix} g & 0 \\ 0 & g^{-1} \end{bmatrix} \begin{bmatrix} h & 0 \\ 0 & h^{-1} \end{bmatrix} \begin{bmatrix} (hg)^{-1} & 0 \\ 0 & hg \end{bmatrix}$$

and we have that in  $\mathrm{GL}_{2n}(R)$

$$\begin{bmatrix} g & 0 \\ 0 & g^{-1} \end{bmatrix} = \begin{bmatrix} \mathrm{id}_n & g \\ 0 & \mathrm{id}_n \end{bmatrix} \begin{bmatrix} \mathrm{id}_n & 0 \\ -g^{-1} & \mathrm{id}_n \end{bmatrix} \begin{bmatrix} \mathrm{id}_n & g \\ 0 & \mathrm{id}_n \end{bmatrix} \begin{bmatrix} 0 & -\mathrm{id}_n \\ \mathrm{id}_n & 0 \end{bmatrix},$$

and in this expression all except the last matrix are obviously in  $E_{2n}(R)$ , and the last is by a mild generalization of (17.2).

So let us instead define for a not necessarily commutative ring  $R$ , the first algebraic  $K$ -theory group as

$$K_1(R) := \mathrm{colim}_{n \rightarrow \infty} H_1(\mathrm{GL}_n(R)) = \mathrm{colim}_{n \rightarrow \infty} \mathrm{GL}_n(R)^{\mathrm{ab}},$$

which takes care of (ii), (iii) and (iv). When  $R = \mathbb{Z}[G]$  (note  $G = \pi_1$  in our application), we thus obtain the group containing the invariant by killing of  $\pm g$  in  $K_1(\mathbb{Z}[G])$ , so as to implement (i):

**Definition 17.2.1.** If  $R = \mathbb{Z}[G]$ , then we have  $\{\pm g | g \in G\} \in \mathrm{GL}_1(\mathbb{Z}[G])^{\mathrm{ab}}$ , and we define the first Whitehead group as

$$\mathrm{Wh}_1(G) := K_1(\mathbb{Z}[G]) / (\pm g).$$

See Table 1.1 for some computations of Whitehead groups.

**Definition 17.2.2.** We denote the class of the matrix  $M$  in  $\mathrm{Wh}_1(\pi_1)$  by  $\tau(W)$  and called it the *Whitehead torsion* of  $W$ .

### 17.3 The $s$ -cobordism theorem

We can now state the  $s$ -cobordism theorem, and prove the most relevant part. After that we shall also give an important application,

the high-dimensional Poincaré conjecture. We also explain its consequences for diffeomorphisms of disks.

Here is the statement, Theorem 1.1 of [Lö2], of which we proved the most relevant “if” part.

**Theorem 17.3.2** (*s-cobordism theorem*). *If  $W$  is an  $h$ -cobordism and  $w \geq 6$ , then  $W \cong \partial_0(W) \times I$  rel  $\partial_0(W)$  if and only if the torsion  $\tau(W) \in \text{Wh}_1(\pi_1)$  vanishes. In fact, every element of  $\text{Wh}_1(\pi_1)$  is realized by an  $h$ -cobordism and two  $h$ -cobordisms are diffeomorphic rel  $\partial_0(W)$  if and only if they have the torsion.*

For  $\tau \in \text{Wh}_1(\pi_1)$ , one may build an  $h$ -cobordism with torsion  $\tau$  by attaching handles according to a representative matrix for  $\tau$ . The remaining parts of the theorem follow by showing that Whitehead torsion may be defined purely topologically and satisfies certain addition formula’s, see Chapter 2 of [Lö2].

### The Poincaré conjecture

We shall now give the classical application of this theorem, the Poincaré conjecture in dimension  $\geq 6$  [Sma61]. It requires the following fact:

**Proposition 17.3.3.**  $\text{Wh}_1(\{e\}) = 0$ .

*Proof.* Firstly, the determinant  $\det: \text{GL}_n(\mathbb{Z}) \rightarrow \{\pm 1\}$  factors over the abelianization. Since the map

$$\{\pm 1\} \xrightarrow{\cong} \text{GL}_1(\mathbb{Z}) \rightarrow \text{GL}_n(\mathbb{Z}) \rightarrow \{\pm 1\}$$

is an isomorphism, it suffices to show that the kernel of  $\det$ , the special linear group  $\text{SL}_n(\mathbb{Z})$ , is perfect when  $n \geq 3$ . Thus  $H_1(\text{GL}_n(\mathbb{Z})) \cong \{\pm 1\}$  if  $n \geq 3$  (this is an example of homological stability).

To show this, we use that  $\text{SL}_n(\mathbb{Z})$  equals  $E_n(\mathbb{Z})$  for  $n \geq 3$  (a baby case of [BMS67]). Clearly  $E_n(\mathbb{Z}) \subset \text{SL}_n(\mathbb{Z})$ , so it suffices to prove  $\text{SL}_n(\mathbb{Z}) \subset E_n(\mathbb{Z})$ . This is not so hard: in order for a integer matrix to be invertible, all columns and rows have to have gcd equal to 1. Thus by adding rows to rows according to the Euclidean algorithm we can make the last column have a single non-zero entry  $\pm 1$ . By switching the rows using (17.2) we can assume it is the last entry that is  $\pm 1$ . Then we can also make the last row be 0 except the last entry. Inductively, we can make the entire matrix be diagonal with entries  $\pm 1$ . Using for  $a \in \mathbb{Z}^\times \cong \{\pm 1\}$  the equation

$$e_{12}(-a)e_{21}(1/a)e_{12}(-a)e_{12}(1)e_{21}(-1)e_{12}(1) = \begin{bmatrix} a & 0 \\ 0 & a^{-1} \end{bmatrix},$$

we can make all diagonal entries by 1 except possibly the bottom-right one. But since we are in  $\text{SL}_n(\mathbb{Z})$ , this has to be 1 as well. Since

**Remark 17.3.1.** Let us recap the proof strategy:

- (1) Give a  $W$  a handle decomposition.
- (2) Get rid of 0-handles by handle cancellation, and 1-handles by handle exchange. By turning the handle decomposition upside down, we may also remove the  $w$  and  $(w-1)$ -handles.
- (3) For  $i \geq 2$ , exchange  $i$ -handles for  $(i+1)$ -handles using the handle exchange lemma until only handles of index  $> \lfloor w/2 \rfloor$  remain. This uses the  $h$ -cobordism theorem assumption and  $w \geq 6$  to create the  $\varphi^{i+1}$ ’s, and the Whitney trick (which we still need to discuss). Turning the handle decomposition upside down, exchange  $i$ -handles for  $(i-2)$ -handles using the handle exchange lemma until only handles of index  $\lfloor w/2 \rfloor$  and  $\lfloor w/2 \rfloor + 1$  remain.
- (4) Extract the algebraic invariant  $\tau \in \text{Wh}_1(\pi_1)$  from the matrix containing the intersection numbers the transverse spheres of the  $\lfloor w/2 \rfloor$ -handles and the attaching spheres of the  $(\lfloor w/2 \rfloor + 1)$ -handles.
- (5) Show that the vanishing of  $\tau$  implies we can get rid of the remaining handles. This uses that the invariant is built so that it encodes the obstruction to reducing matrices to the identity using only certain moves (namely those that can modeled geometrically by manipulations of handles).

all operations are implemented by multiplying with elements of  $E_n(\mathbb{Z})$  on the left or right, we conclude that the matrix was in  $E_n(\mathbb{Z})$ .  $\square$

The following is a special case of the  $s$ -cobordism theorem which follows from the above computation.

**Corollary 17.3.6** ( *$h$ -cobordism theorem*). *If  $W$  is an  $h$ -cobordism,  $w \geq 6$  and  $\pi_1(W) = \{e\}$ , then  $W \cong \partial_0(W) \times I$  rel  $\partial_0(W)$ .*

**Theorem 17.3.7** (Smale). *If  $M$  is a smooth closed manifold of dimension  $\geq 6$  which is homotopy equivalent to  $S^m$ , then it is (PL-)homeomorphic to  $S^m$ .*

*Proof.* Embed two disks  $D^m$  disjointly in  $M$ . Their complement is a cobordism  $W$ . It is simply-connected by Seifert-van Kampen and the two maps  $\partial D^m \rightarrow W$  are homology equivalences by Mayer-Vietoris. We conclude that  $M$  is an  $h$ -cobordism.

By the  $h$ -cobordism theorem, we conclude that  $M \cong S^{n-1} \times [0, 1]$  rel  $S^{m-1} \times \{0\}$ . This means that  $M$  is obtained from  $D^m \cup_{\text{id}} S^{m-1} \times [0, 1] = D^m_+$  by gluing on a copy of  $D^m_+$  along a possibly non-trivial orientation-preserving diffeomorphism  $f$  of  $S^{m-1}$ . By the Alexander trick for (PL-)homeomorphisms, every (PL-)homeomorphism  $f: S^{m-1} \rightarrow S^{m-1}$  extends to a (PL-)homeomorphism  $F: D^m \rightarrow D^m$ . Then a (PL-)homeomorphism  $M \rightarrow S^m$  is given by

$$G: M \cong D^m_- \cup_f D^m_+ \rightarrow S^m \cong D^m_- \cup_{\text{id}} D^m_+$$

$$x \mapsto \begin{cases} F^{-1}(x) & \text{if } x \in D^m_+ \\ x & \text{if } x \in D^m_- \end{cases} \quad \square$$

### Consequences for diffeomorphism groups

The following is a fundamental object in the theory of smooth manifolds (see Table 1.2 for a table):

**Definition 17.3.8.** Let  $\Theta_m$  denote the set of oriented smooth closed manifold of dimension  $m$  which are homotopy equivalent to  $S^m$ , up to orientation-preserving diffeomorphism. We shall later see that it admits an abelian group structure, and call it the *group of homotopy spheres of dimension  $m$*  (or *exotic spheres*).

From the construction in Smale's theorem, we see that for  $m \geq 5$  every  $(m+1)$ -dimensional homotopy sphere is obtained by gluing a  $D^{m+1}$  to a  $D^{m+1}$  along a orientation-preserving diffeomorphism of  $S^m$ .

**Corollary 17.3.9.** *If  $m \geq 5$ , then the map  $\pi_0(\text{Diff}^+(S^m)) \rightarrow \Theta_{m+1}$  is surjective.*

**Remark 17.3.4.** Note we just proved that  $K_1(\mathbb{Z}) \cong \mathbb{Z}/2\mathbb{Z}$ , as in Table 20.2.

**Remark 17.3.5.** A similar but easier proof using row reduction tells us that if  $\mathbb{F}$  is a field and  $n \geq 3$ , then  $\text{SL}_n(\mathbb{F})$  is generated by  $e_{ij}(a)$ . We conclude that  $K_1(\mathbb{F}) = \mathbb{F}^\times$  for all fields  $\mathbb{F}$ .

Recalling our discussion of diffeomorphisms of  $S^2$ , we can relate this to disks. Note that the inclusion  $D^m \hookrightarrow S^m$  induces a homomorphism  $\pi_0(\text{Diff}_\partial(D^m)) \rightarrow \pi_0(\text{Diff}^+(S^m))$ , and hence a map  $\pi_0(\text{Diff}_\partial(D^m)) \rightarrow \Theta_{m+1}$ .

**Corollary 17.3.10.** *If  $m \geq 5$ , then the map  $\pi_0(\text{Diff}_\partial(D^m)) \rightarrow \Theta_{m+1}$  is surjective.*

*Proof.* As in the 2-dimensional case, the above inclusion and the inclusion of rotations of  $S^m$  into diffeomorphisms induce a weak equivalence

$$\text{Diff}_\partial(D^m) \times SO(m+1) \rightarrow \text{Diff}_\partial^+(S^m),$$

which implies that the map  $\pi_0(\text{Diff}_\partial(D^m)) \rightarrow \pi_0(\text{Diff}^+(S^m))$  is an isomorphism.  $\square$

**Example 17.3.11.** Milnor proved that  $\Theta_7$  contains a copy of  $\mathbb{Z}/7\mathbb{Z}$  [Mil56] (it is in fact isomorphic to  $\mathbb{Z}/28\mathbb{Z}$  [KM63]). Thus we conclude that  $\pi_0(\text{Diff}_\partial(D^6))$  has at least 7 (or least 28) path components.



## The Whitney trick

To finish the proof of the  $s$ -cobordism theorem, we need a tool to make the number of intersection points of two submanifolds equal to the absolute value of their algebraic intersection number. The latter counts the intersection points *with sign*, and hence some may cancel. This tool will be the so-called *Whitney trick* [Mil65, Chapter 6], [Sco05, Section 1.5]. We shall also discuss what happens in dimension 4, in particular the *Casson trick* [Cas86], [Sco05, Chapter 2]. Takeaways:

- The Whitney trick allows one to cancel two intersection points of opposite sign. It works for submanifolds of dimension  $m, x$  in a simply-connected  $(m + x)$ -manifold, when  $m + x \geq 6$  and  $m, x \geq 3$ .
- The assumptions come from: (i) finding an immersed 2-disk bounding a pair of paths between the intersection points, (ii) making this 2-disk generically embedded, (iii) finding normal vector fields.
- In dimension four, it fails, but you can localize this failure to (ii) using the Casson trick. This is the starting point of Freedman's proof of the Whitney trick for topological 4-manifolds.

### 18.1 The Whitney trick

We give the standard proof of the Whitney trick, as in Milnor's book [Mil65]. We then give an application by improving the dimension bound in the Whitney embedding theorem.

#### The Whitney trick

Suppose that  $N$  is a smooth manifold, and we have smooth submanifolds  $M, X \subset N$  such that  $m + n = x$  and  $M \pitchfork X$ . Let us take two intersection points  $p_0, p_1 \in M \cap X$  such that  $p_0, p_1$  are in the same path components of  $M$  and  $X$ . Let us pick embedded smooth paths  $\gamma_M: [0, 1] \rightarrow M$  and  $\gamma_X: [0, 1] \rightarrow X$  starting at  $p_0$  and ending at  $p_1$  avoiding other intersection points, see Figure 18.1.

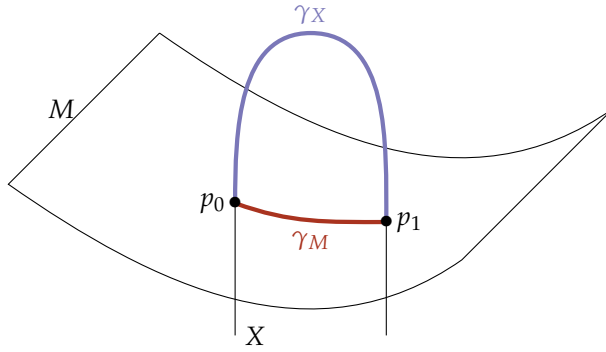

Figure 18.1: The submanifolds  $M, X$  of  $\mathbb{R}^3$ , and the arcs  $\gamma_M$  and  $\gamma_X$ .

We shall also pick a Riemannian metric on  $N$ , such that  $M$  and  $X$  are totally geodesic near  $\gamma_M \cup \gamma_X$ , and at  $p_0$  and  $p_1$ ,  $M$  and  $X$  are orthogonal. This may be arranged by constructing the Riemannian metric by a partition of unity; clearly these conditions can be arranged locally first near  $p_0$  and  $p_1$  and then near  $\gamma_M$  and  $\gamma_X$  independently, and we may extend the Riemannian metric elsewhere arbitrarily.

Now pick a basis  $(\zeta_1(0), \dots, \zeta_x(0))$  of  $T_{p_0}(X) \cong T_{p_0}(M)^\perp$  at  $p_0$ , with  $\zeta_x(0) = \frac{d\gamma_X}{dt}(0)$ , and similarly a basis  $(\xi_1(0), \dots, \xi_m(0))$  of  $T_{p_0}(M) \cong T_{p_0}(X)^\perp$  at  $p_0$  with  $\xi_m(0) = \frac{d\gamma_M}{dt}(0)$ . In particular, we obtain a basis  $(\zeta_1(0), \dots, \zeta_x(0), \xi_1(0), \dots, \xi_m(0))$  of  $T_{p_0}(N)$ , see Figure 18.2.

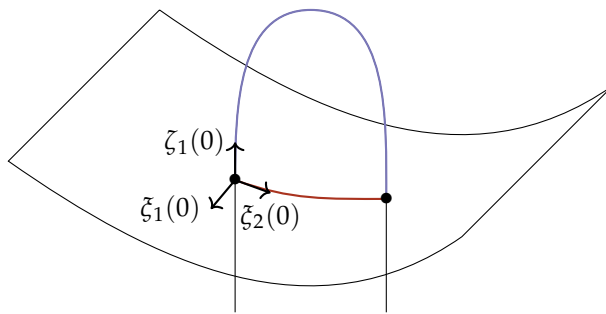

Figure 18.2: The basis of  $T_{p_0}(N)$ .

We can parallel transport these along  $\gamma_M$  and  $\gamma_X$  respectively, resulting in two families of frames for  $t \in [0, 1]$

$$(\zeta_1(t)^M, \dots, \zeta_{n-m}^M(t), \xi_1^M(t), \dots, \xi_{n-x}^M(t)) \text{ over } \gamma_M,$$

$$(\zeta_1(t)^X, \dots, \zeta_{n-m}^X(t), \xi_1^X(t), \dots, \xi_{n-x}^X(t)) \text{ over } \gamma_X.$$

We shall need to assume that their values at  $t = 1$ , in  $T_{p_1}N$ , are *oppositely* oriented. This makes sense without reference to any orientation of  $N$ .



For later use we make two independent remarks. Firstly, since  $M$  was totally geodesic near  $\gamma_M$ , parallel transport along  $\gamma_M$  preserves lying in or being orthogonal to  $M$ , and similarly for  $X$ . Secondly,  $\tilde{\zeta}_{n-x}^M(1) = \frac{d\gamma_M}{dt}(1)$  and  $\zeta_{m-x}^X(1) = \frac{d\gamma_X}{dt}(1)$ , so by flipping one of these in one of the frames we can make the frames at  $p_1$  be *equally* oriented.

It shall be useful to consider the following manifold with corners now: let  $B^2$  (a 2-dimensional *bigon*) be the submanifold of  $\mathbb{R}^2$  as in Figure 18.3. We get an embedding of the boundary  $\partial B^2 \hookrightarrow N$  by sending the top half to  $\gamma_M$  and the bottom half to  $\gamma_X$ .

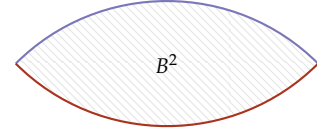

Figure 18.3: A 2-dimensional bigon.

<sup>1</sup> In fact  $n \geq 6$  is forced;  $m+x = n$  and  $m, x \leq n-3$  implies that  $n \leq 2n-6$ , so that  $0 \leq n-6$  so  $n \geq 6$ .

**Lemma 18.1.1.** *If  $m, x < n-2$  and  $N$  is simply-connected, then  $N \setminus (M \cup X)$  is simply-connected. If additionally  $n \geq 5$ ,<sup>1</sup> then there exists an embedding  $B^2 \hookrightarrow N$  such that  $B^2 \cap (M \cup X) = \partial B^2$ , i.e. given by  $\gamma_M \cup \gamma_X$ .*

*Proof.* For the first statement, we note that by transversality any 2-disk in  $N$  generally avoids both  $M$  and  $X$ , so their complement in  $N$  is simply-connected,  $\pi_1(N \setminus (M \cup X)) = 0$ . Thus there exists an extension of  $\partial B^2 \rightarrow N$  to a continuous map  $B^2 \rightarrow N$  the image of whose boundary is the image of  $\gamma_M \cup \gamma_X$  and whose interior lands in  $N \setminus (M \cup X)$ . We can make it smooth and generically an immersion. In fact, if  $n > 4$  it is generically even an embedding (since generically it is self-transverse using multi-jet-transversality, and self-intersections have dimension  $2 \cdot 2 - n < 0$ ).  $\square$

We may assume that  $B^2$  is totally geodesic near  $\partial B^2$ , and the tangent space to  $B^2$  will coincide with the span of  $\zeta_x^M(t), \tilde{\zeta}_m^M(t)$  over  $\gamma_M$  and the span of  $\zeta_x^X(t), \tilde{\zeta}_m^X(t)$  over  $\gamma_X$ .

**Lemma 18.1.2.** *If  $m-1 \geq 2$ , we can extend  $(\zeta_1^X(t), \dots, \zeta_{x-1}^X(t))$  (resp.  $(\tilde{\zeta}_1^M(t), \dots, \tilde{\zeta}_{m-1}^M(t))$ ) from  $\gamma_X$  (resp.  $\gamma_M$ ) to  $B^2$ , such that they together from a trivialization of the normal bundle  $(TB^2)^\perp$ , the extension of the  $\zeta^X$ 's over  $\gamma_M$  is orthogonal to  $M$  and the extension of the  $\zeta^M$ 's over  $\gamma_X$  is orthogonal to  $X$ .*

*Proof.* We start with the  $\zeta$ 's, here both the sign condition on the intersections and the dimensional restrictions will come in.

Let  $\rho$  be a vector field on  $B^2$  that is orthogonal to  $\partial_- B^2$ . Then at  $p_0$  and  $p_1$ , the points in  $\partial(\partial_+ B^2)$ , we have  $x$ -frames  $(\zeta_1^X, \dots, \zeta_{x-1}^X, \rho_1)$  in  $(TM)^\perp$ . Since  $\rho_1(p_0) = \frac{d\gamma_X}{dt}$ , but  $\rho_1(p_1) = -\frac{d\gamma_X}{dt}$ , these have the same orientation in  $(TM)^\perp$  (as trivialized over  $\gamma_M$ ) and thus can be extended over  $\partial_+(B^2)$  lying in  $(TM)^\perp$ .

Now we have an  $(x-1)$ -frame over  $\partial B^2$  and we want to extend it to the (trivial)  $(n-2)$ -dimensional normal bundle to  $B^2$ . The obstruction to extension lies in  $\pi_1(O(n-2)/O(m-1))$ , which vanishes as long as  $m-1 \geq 2$ .

Finally, the  $\tilde{\zeta}^{M'}$ 's provide us with  $(m-1)$ -frames over  $\partial B^2_+$ , and we need to extend this to the remaining  $(m-1)$ -dimensional sub-bundle

over the normal bundle to  $B^2$  orthogonal to the  $\zeta'$ s. As  $\partial B^2_+ \rightarrow B^2$  is a weak equivalence, this is always possible.  $\square$

Let us denote the corresponding vector fields on  $B^2$  by

$$(\zeta_1, \dots, \zeta_{x-1}, \xi_1, \dots, \xi_{m-1}).$$

These form an *integrable distribution*, i.e. their span is closed under the Lie bracket, since they are constructed orthogonal to  $TB^2$ . The Frobenius theorem then implies that we can extend them a bit outside  $B^2$  so that they may be consistently exponentiated to give a neighborhood  $U \subset N$  of  $B^2$  whose intersections with  $N$  and  $X$  are as in the following standard model: the two parts of  $\partial B^2$  are parts of graphs  $P_1 = \{(t, t^2 - 1) \mid t \in \mathbb{R}\}$  and  $P_2 = \{(t, 1 - t^2) \mid t \in \mathbb{R}^2\}$ , then  $N$  is  $\mathbb{R}^n$ ,  $B^2$  is the subset bounded by  $P_1$  and  $P_2$  in  $\mathbb{R}^2 \times \{0\}$ ,  $M$  is given by  $P_1 \times \mathbb{R}^{m-1} \times \{0\}$ ,  $X$  is given by  $P_2 \times \{0\} \times \mathbb{R}^{n-1}$ . In this standard model,  $M$  and  $X$  intersect once with opposite sign, and we can create a compactly supported isotopy removing both intersections by moving either  $P_1$  upwards or  $P_2$  downwards, see Figure 18.4.

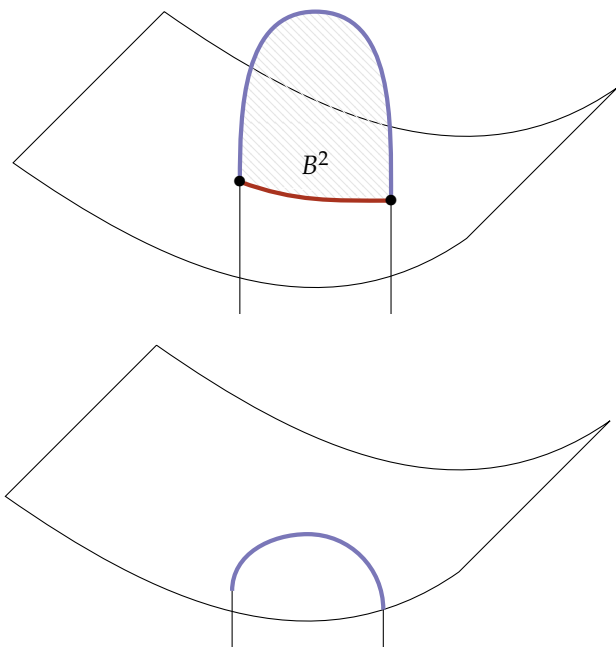

Figure 18.4: The Whitney move.

The conclusion is the following:

**Theorem 18.1.3** (Whitney trick). *Suppose that  $N$  is simply-connected,  $M$  and  $X$  smooth submanifolds of dimension  $m, x \geq 3$ ,<sup>2</sup>  $m + x = n$ , intersecting transversally. If  $p_0, p_1 \in M \cap X$  have opposite sign on same path components of  $M$  and  $X$ , then there is a compactly supported ambient isotopy  $\phi_t$  of  $N$  such that  $M \cap \phi_1(X) = M \cap X \setminus \{p_0, p_1\}$ .*

<sup>2</sup> As the proof shows, it is in fact acceptable to have  $m = 3$  and  $x = 2$ , as long as we assume that  $\pi_1(N \setminus M) = 0$ .

Here originally the sign was only defined with respect to some arcs  $\gamma_M$  and  $\gamma_X$ , but since  $N$  is orientable because simply-connected, we can define this sign a priori (and it is in particular independent of the arcs).

### *The strong Whitney embedding theorem*

The classical application of the Whitney trick is the strong Whitney embedding theorem. So far we have proven the “moderately strong” Whitney embedding theorem, every closed smooth  $m$ -dimensional manifold  $M$  embeds into  $\mathbb{R}^{2m+1}$ .

**Theorem 18.1.4** (Whitney). *Every closed smooth  $m$ -dimensional manifold  $M$  embeds into  $\mathbb{R}^{2m}$ .*

*Proof.* We have classified all  $\leq 2$ -dimensional manifolds, so we can check it by hand for these. Let us thus assume  $m \geq 3$ .

Recall that to obtain the embedding into  $\mathbb{R}^{2m+1}$  one projects along a line onto a hyperplane. Doing this once more, generically results in an immersion  $M \looparrowright \mathbb{R}^{2m}$  with only double points, i.e. transverse self-intersections. If we can find paths pairing these with opposite sign, then we can apply the Whitney trick to remove all intersections. However, a priori there is no reason that this is possible. Whitney solved this by showing that you can locally introduce a self-intersection of whichever sign you want, the higher-dimensional generalization of Figure 18.5. You can thus modify the immersion by creating for each self-intersection point its own canceling one.  $\square$



Figure 18.5: A Whitney pinch.

## 18.2 Dimension 4

The main concern with trying to applying the Whitney trick in dimension 4 is when  $m = x = 2$ , as there are often special techniques to deal with 1-dimensional submanifolds. In this case we run into three obstructions: (i) the complement of  $M$  and  $X$  in  $N$  may not be simply-connected even if  $N$  (or even  $N \setminus M$ ) is, (ii) a generic immersion of a 2-disk into  $N$  is not an embedding, and (iii) we might encounter a framing obstruction in  $\pi_1(O(2)/O(1)) \cong \mathbb{Z}$ . One might think a hands-on method might get around it. This is *not* possible, as the following example by Lackenby shows [Lac96].

**Proposition 18.2.1.** *Given  $N = S^2 \times S^2$ ,  $M = S^2 \times *$ , there is a smoothly embedded 2-sphere  $Q \subset S^2 \times S^2$  intersecting  $M$  in two points with opposite sign, such that no Whitney disk exists.*

However, we can still try to construct a Whitney disk. It turns out that (i) and (iii) may be fixed, at the expensive of making (ii) worse. For (i) we refer to Section 1.3 of [FQ90]. The idea is to twist an immersed 2-disk around this boundary to change the obstruction by 1. Instead we focus on the more geometrically intersection (iii).

### *The Casson trick*

The construction underlying Casson's trick is a finger move. This is 4-dimensional construction and involves an immersed surfaces  $\Sigma \subset N$  and an embedded arc  $\gamma$  in  $N$ , whose interior avoids  $\Sigma$  (generically always the case) and whose endpoints are two distinct points  $p_0, p_1$  in  $\Sigma$  which are *not* points of self-intersection. Then we form a tubular neighborhood  $U \cong D^3 \times (-\epsilon, 1 + \epsilon)$  of  $\gamma$ , such that  $U \cap \Sigma$  is given near  $p_0$  by  $D^2 \times \{0\} \times \{0\}$ , and near  $p_1$  by  $\{0\} \times D^2 \times \{1\}$ . We may "push up"  $\Sigma$  near  $p_0$  by replacing  $D^2 \times \{0\} \times \{0\}$  with points  $\mathcal{F} = \{(x, y, 0, f(x^2 + y^2))\}$  with  $f: [0, 1] \rightarrow (-\epsilon, 1 + \epsilon)$  a smooth strictly decreasing function that is  $1 + \epsilon/2$  at 0, 1 at  $1/4$  and 0 on  $[1/2, 1]$ . Then  $\mathcal{F} \cap \{0\} \times D^2 \times \{1\}$  consists of two points of the form  $\{(0, \pm y, 0, 1)\}$ , and the intersection is transverse. Let us denote  $\mathcal{F}(\Sigma)$  the result of replacing  $D^2 \times \{0\} \times \{0\}$  with  $\mathcal{F}$ , which has two more intersection points.

Now let us consider the special situation that  $p_1$  is really close to  $p_0$ . In that case we shall describe the difference between  $\pi_1(N \setminus \mathcal{F}(\Sigma))$  and  $\pi_1(N \setminus \Sigma)$ .

For every point the image of  $N$  that is not a self-intersection, there is a loop in  $N \setminus \Sigma$  called the *meridian*. It is given by noting that locally  $N$  looks like  $\mathbb{R}^2 \hookrightarrow \mathbb{R}^4$  and the loop  $S^1 \ni \theta \mapsto (0, 0, \sin(\theta), \cos(\theta))$  circles around the surface near the origin. So, let  $z$  be class of the the meridian around  $\Sigma$  at  $p_0$  in  $\pi_1(N \setminus \Sigma)$ . We may construct from  $\gamma$  a loop  $\eta$  in  $\pi_1(N \setminus \Sigma)$  (well-defined up to the meridian). See Figure 18.6.

**Lemma 18.2.2.** *We have that  $\pi_1(N \setminus \mathcal{F}(\Sigma)) \cong \pi_1(N \setminus \Sigma) / ([z, z^\eta])$ , with  $([z, z^\eta])$  denoting the normal subgroup generated by the commutator of  $z$  and the conjugate of  $z$  by  $\eta$ .*

*Proof.* If we remove a 2-disk  $C$  whose boundary connects the new intersection points through  $N$  and the finger (in coordinates  $\{0, y, 0, t\}$  with  $y^2 \leq 1/4$ ,  $1 \leq t \leq f(x^2 + y^2)$ ), the result is equivalent to moving the finger slightly less far and connecting by an arc, see Figure 18.7. Since an arc is 1-dimensional, removing it does not affect  $\pi_1$ . Thinking of  $C$  as the cocore of a two-handle, we see that to get from this

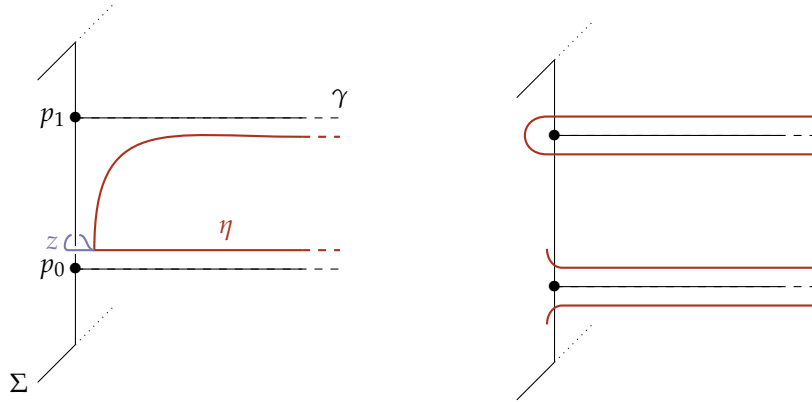

Figure 18.6: The result of a finger move along  $\gamma$ .

picture to  $N \setminus \mathcal{F}(\Sigma)$ , we add a 2-handle, which is a  $D^2 \times D^2$  attaching along a  $\partial D^2 \times D^2$ , so kills off a single generator of  $\pi_1$ . It suffices to figure out this is  $[z, z^\eta]$ .

The generator it kills is represented by the meridian of  $C$ . To identify it, we look near one of the new intersection points in  $N \setminus \mathcal{F}(\Sigma)$ , its link is a 2-torus, a product of a meridian of  $N$  and a meridian of the finger. The disk  $C$  intersects its 2-torus once. This show that the meridian of  $C$  is the commutator of the meridian of  $N$ , which is  $z$ , and the meridian of the finger, which is  $z^\eta$ .  $\square$

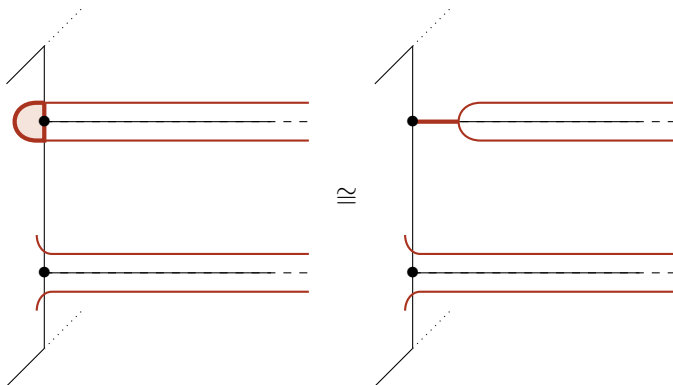

Figure 18.7: Removing a disk from a finger move.

We shall give a slightly simpler version of Casson’s trick; a similar argument works to make simply-connected the complement of two embedded surfaces, each with simply-connected complement but possibly intersecting, instead using finger moves of one of the surfaces onto the other.

**Theorem 18.2.3** (Casson trick). *Suppose we have a simply-connected compact 4-manifold  $N$  and an immersed  $D^2$  in  $N$  with boundary embedded in  $\partial N$ . If there exists a homology class  $\beta \in H_2(N)$  such that the intersection*

number  $[D^2] \cdot \beta = 1$ , then we may modify  $D^2$  rel  $\partial D^2$  by finger moves such that  $N \setminus D^2$  is simply-connected (increasing the number of self-intersections).

*Proof.* We first show that  $\pi_1(N \setminus D^2)$  normally generated by meridians. To see this, note that any loop  $\gamma$  in  $N \setminus D^2$  is nullhomotopic in  $N$  and this null-homotopy generically intersects  $D^2$  in finitely many points away from the points of self-intersection. This shows  $\gamma$  is freely homotopic in  $N \setminus D^2$  to a wedge of meridians, one for each intersection point, which proves the claim.

This means that  $[z] \in H_1(N \setminus D^2)$  generates, as all meridians are conjugate to a fixed one  $z$ . Let us now represent  $\beta$  by an immersed surface  $B$  intersecting  $D^2$  transversally, and removing disks from  $B$  around the intersection points to obtain  $B'$ . Then  $[\partial B'] = [z]$  since the signed count of intersection points was 1 and each intersection point contributes a signed copy of a meridian. Thus  $[z]$  is null-homologous in  $N \setminus D^2$  and we conclude  $H_1(N \setminus D^2) = 0$ .

Thus  $\pi_1(N \setminus D^2)$  is generated by commutators. If a group is generated by commutators, and by a set of generators  $I$ , then it is generated by conjugates of the commutators of the generators and their inverses: the basic identity is

$$[ab, c] = abcb^{-1}a^{-1}c^{-1}a = (abcb^{-1}ca^{-1})(aca^{-1}c^{-1}) = [b, c]^a[a, c]$$

Thus it is generated by commutators of the form  $[z^w, z^{w'}]^u$ . It suffices to kill the generators up to conjugacy  $[z^w, z^{w'}]$ , which is possible using finger moves as a consequence of the formula  $[z^w, z^{w'}] = [z, z^{w'w^{-1}}]^w$ .  $\square$

### *Casson handles and Freedman's theorem*

One can try to push these techniques to give something like a Whitney trick. It will try to produce an embedded disk out of an immersed one, but only succeeds up to homotopy.

The image of the immersed  $D^2$  that is a candidate Whitney disk might have  $\pi_1$  (from loops over self-intersections). Now apply Casson's trick and disks, called accessory disks, for the intersection points (adding pinches if necessary), creating a 2-stage tower of Whitney disks. This kills the original  $\pi_1$  in the Whitney disk, but possibly adds new  $\pi_1$  in the new accessory disks. However, if we repeat the above procedure infinitely many times, creating an infinite tower, no  $\pi_1$  should remain; any potentially non-trivial loop lives in a compact subset and dies when we add the next layer of accessory disks. This large limiting object is called an *Casson handle*. Casson gave a precise definition — something we neglect to do — and proved the following:

**Theorem 18.2.4** (Casson). *For any immersion of  $D^2$  in simply-connected  $N$  with  $\partial D^2 \subset \partial N$  embedded, and  $\beta \in H_2(N)$  such that  $[D^2] \cdot \beta = 1$ , there exists a Casson handle  $V$  in  $N$  such that  $(V \cap \partial N)$  is a regular neighborhood of  $\partial D^2$  and  $D^2$  can be homotoped rel  $\partial D^2$  into  $V$ .*

**Lemma 18.2.5.** *A Casson handle  $(V, V \cap \partial N)$  is properly homotopy equivalent to  $(D^2 \times \mathbb{R}^2, S^1 \times \mathbb{R}^2)$ .*

The most important theorem in topological 4-manifolds is then Freedman's re-embedding theorem, one version of which says, page 79 of [Sco05]:

**Theorem 18.2.6** (Freedman). *Every Casson handle  $V$  contains a topological 2-handle  $D^2 \times D^2$  rel  $\partial D^2 \times D^2 \subset \partial N$ .*

This leads to a version of the Whitney trick for topological 4-manifolds (with fundamental group and homology restrictions). Its proof depends heavily on the classical theory of decomposition spaces, also known as Bing topology. This involves the collapsing of complicated subsets, and can certainly not be done smoothly. In fact, Theorem 18.2.6 must be false in the smooth category, because if it were not, none of the exotic smooth phenomena could occur.





19

*A first look at surgery theory*



## Part IV

# Diffeomorphisms and algebraic $K$ -theory



## Algebraic K-theory

Our next goal is to prove that the surjective map

$$\pi_0(\text{Diff}_\partial(D^n)) \twoheadrightarrow \Theta_{n+1}$$

is also injective. We shall not follow the original proof, but instead will ahistorically derive it from “final results” on the relationship between manifolds and algebraic K-theory. In this lecture we will set up the statements of these results. The main reference is [Wei13], but we shall also use [Seg74] and [MS76].

**Remark 20.0.1.** In these notes we will take classifying spaces of large categories. The reader should substitute a small version to avoid set-theoretical issues.

### 20.1 Algebraic K-theory

Algebraic K-theory can be motivated from several points of view:

- (i) It is a natural home for invariants from manifold theory.
- (ii) It is the algebro-geometric analogue of topological K-theory.
- (iii) It is a general method to simplify the study of two objects by performing in a homotopy-coherent way two simplifications:
  - (a) group completion, (b) forcibly splitting cofiber sequences.

We have only seen the torsion of a  $h$ -cobordism, so (i) is not very helpful for us. Instead, let us start with (ii), the historical origin of algebraic K-theory.

#### Algebraic K-theory via algebraic vector bundles

Fix a commutative ring  $R$ , then a vector bundle over  $\text{Spec}(R)$  is by definition a sheaf that locally in the Zariski topology is isomorphic to  $\mathcal{O}_{\text{Spec}(R)}^{\oplus n}$  for some  $n \geq 0$ . We claim that there is a correspondence:

$\{\text{vector bundles}\} / \text{iso} \cong \{\text{finitely generated projective } R\text{-modules}\} / \text{iso}.$

Takeaways:

- Algebraic K-theory is a generalization of the study of vector bundles on spaces or schemes by group completing and splitting cofiber sequences.
- It may be constructed by group completion (via  $\Gamma$ -spaces).
- By looking at cells or using the group completion theorem, we show this recovers  $K_0$  and  $K_1$ .

This correspondence is given by sending a vector bundle  $E$  to the  $\mathcal{O}_{\text{Spec}(R)}(\text{Spec}(R)) = R$ -module  $P$  of global sections  $\Gamma(E)$ . Conversely a finitely-generated projective  $R$ -module  $P$  is sent to the sheaf assigning to a basis element  $\text{Spec}(R_f)$  the localized  $R_f$ -module  $P_f$ . That this construction works requires some non-trivial commutative algebra, see Section II.5.2 of [Bou98] or Section I.2 of [Wei13].

To produce the analogue of topological  $K_0$ , we want to group complete the abelian monoid of isomorphism classes of vector bundles on  $\text{Spec}(R)$  under direct sum. This implements (a), and (b) is automatic because for projective modules every short exact sequence splits. Let  $K: \text{AbMon} \rightarrow \text{AbGr}$  the group completion of abelian monoids (i.e. the left adjoint to the inclusion of abelian groups into abelian monoids). For an abelian monoid  $M$ , this is explicitly given by the quotient of the free abelian group on the elements of  $M$ , by the equivalence relation  $[m] \sim [n]$  if there exists a  $q \in M$  such that  $m + q = n + q$ .

**Definition 20.1.1.** We define the *0th algebraic K-theory of a ring  $R$*  to be

$$K_0(R) := K(\{\text{fin.gen. projective } R\text{-modules}\} / \text{iso}, \oplus)$$

This construction is related to our earlier definition of  $K_1$  in terms of group homology by exact sequences, e.g. the localization long exact sequence for  $\mathbb{Z}_{(p)}$  (all primes exact  $p$  inverted)

$$K_1(\mathbb{F}_p) \rightarrow K_1(\mathbb{Z}_{(p)}) \rightarrow K_1(\mathbb{Q}) \rightarrow K_0(\mathbb{F}_p) \rightarrow K_0(\mathbb{Z}_{(p)}) \rightarrow K_0(\mathbb{Q}),$$

which you can find as (6.6) on page 449 of [Wei13]

It was long believed that this is the beginning of a long exact sequence of homotopy groups of a fiber sequence of spaces  $K(\mathbb{F}_p) \rightarrow K(\mathbb{Z}_{(p)}) \rightarrow K(\mathbb{Q})$  with additional structure (to make  $\pi_0$  an abelian group). This goal was achieved by Quillen, who gave several constructions of  $K(R)$ .

### Desiderata

At this point it is helpful to discuss how we will eventually recognize that we have the “right” construction of an algebraic  $K$ -theory space whose homotopy groups are the algebraic  $K$ -theory groups. It should satisfy many if not all of the following desiderata:

- (i) Its  $\pi_0$  and  $\pi_1$  recover  $K_0$  and  $K_1$  as defined before. There is also a notion of  $K_2$  due to Milnor for local rings, which we would like to recover as well, see Section III.5 of [Wei13].
- (ii) There is a standard list of desired formal properties we would like the algebraic  $K$ -theory groups to have, see Chapter V of [Wei13]: localization, cofinality, resolution, approximation, devissage.

$R$	$K_0(R)$
field	$\mathbb{Z}$
PID's, e.g. $\mathbb{Z}$	$\mathbb{Z}$
$\mathbb{Z}[\sqrt{-5}]$	$\mathbb{Z} \oplus \mathbb{Z}/2\mathbb{Z}$

Table 20.1: Some examples of  $K_0$ 's of rings.

- (iii) It should be an algebro-geometric version of the spaces  $BU$  and  $BO$  in topological  $K$ -theory.
- (iv) It should satisfy a homotopy-theoretic version of the universal property of group completion of abelian monoids.

All of these are true for the construction of an algebraic  $K$ -theory space that we will describe, once made precise, though we shall not discuss (iii) again. This leads one to motivic homotopy theory, e.g. [Levo8].

## 20.2 Group completion

We shall describe a construction which will evidently satisfy desiderata (i) and (iv).

### The group-completion construction of $K(R)$

We start by recalling the notion of a  $\Gamma$ -space [Seg74], where  $\Gamma$  is the category of pointed finite sets with skeleton given by  $\bar{n} = \{*, 1, \dots, n\}$  (warning: this is *opposite* of Segal's convention, but in my opinion more intuitive). This is a simplicial space  $X: \Gamma \rightarrow \text{Top}$  such the map  $X(n) \rightarrow X(1) \times \dots \times X(1)$  induced by the  $n$  projections  $\bar{n} = \{*, 1, \dots, n\} \rightarrow \bar{1} \cong \{*, i\}$  sending all elements except  $i$  to the base point, is a weak equivalence for all  $n$  (including  $n = 0$ , so that  $X(0) \simeq *$ ).

You should think of this as essentially a commutative unital monoid structure on  $X(1)$ ; the unit is the degeneracy  $X(0) \rightarrow X(1)$  induced by  $\bar{0} = \{*\} \rightarrow \bar{1} = \{*, 1\}$ , and the multiplication is  $X(1) \times X(1) \leftarrow X(2) \rightarrow X(1)$  with the left a weak equivalence and the right induced by  $c: \{*, 1, 2\} \rightarrow \{*, 1\}$  given by all non-base points to 1. The commutativity follows from the commutative diagram

$$\begin{array}{ccc}
 \{*, 1, 2\} & \xrightarrow{\text{swap}} & \{*, 1, 2\} \\
 & \searrow c & \swarrow c \\
 & \{*, 1\} &
 \end{array}$$

**Example 20.2.1.** If  $M$  is a commutative unital monoid, then  $X_M(n) := M^n$  is a  $\Gamma$ -space, maybe more conveniently written as  $S \mapsto M^{S \setminus \{*\}}$ .

The maps induced by various operations of pointed finite sets are as follows:

$$\begin{array}{l}
 \text{projection } \{*, 1\} \rightarrow \{*\} \rightsquigarrow \text{projection } M \rightarrow * \\
 \text{combination } \{*, 1, 2\} \rightarrow \{*, 1\} \rightsquigarrow \text{multiplication } M^2 \rightarrow M \\
 \text{permutation } \{*, 1, \dots, n\} \rightarrow \{*, 1, \dots, n\} \rightsquigarrow \text{permutations of terms } M^n \rightarrow M^n \\
 \text{inclusion } \{*\} \rightarrow \{*, 1\} \rightsquigarrow \text{unit } * \rightarrow M.
 \end{array}$$

**Example 20.2.2.** For a ring  $R$ , we can define a  $\Gamma$ -space  $X_R$  by letting  $X_R(n)$  be the classifying space of the category of  $n$ -tuples of finitely generated projective left  $R$ -modules and isomorphisms. The maps induced by various operations of pointed finite sets are induced by the following functors as follows:

$$\begin{aligned} &\text{projection } \{*, 1\} \rightarrow \{*\} \rightsquigarrow \text{projection } (P) \mapsto * \\ &\text{combination } \{*, 1, 2\} \rightarrow \{*, 1\} \rightsquigarrow \text{direct sum } (P, Q) \mapsto (P \oplus Q) \\ \text{permutation } \{*, 1, \dots, n\} &\rightarrow \{*, 1, \dots, n\} \rightsquigarrow \text{permutation } (P_1, \dots, P_n) \mapsto (P_{\sigma(1)}, \dots, P_{\sigma(n)}) \\ &\text{inclusion } \{*\} \rightarrow \{*, 1\} \rightsquigarrow \text{adding trivial module } * \mapsto (0). \end{aligned}$$

Given a  $\Gamma$ -space  $X: \Gamma \rightarrow \text{Top}$ , we can precompose with the opposite of the functor  $\Delta \rightarrow \Gamma^{\text{op}}$  sending  $[n] \cong \{0, \dots, n\}$  to  $\bar{n}$  by sending it to the set of gaps  $\{i < i + 1 \mid 0 \leq i \leq n - 1\}$  with disjoint base point. A map  $f: [n] \rightarrow [m]$  is sent to the induced map on gaps as in Figure 20.1. This gives a simplicial space  $B_\bullet X$ .

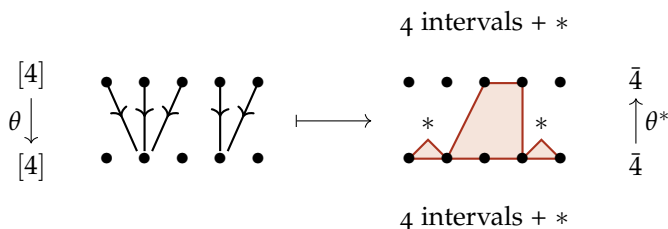

Figure 20.1: The functor  $\Delta \rightarrow \Gamma^{\text{op}}$  on morphisms. On the left hand side, a morphism in  $\Delta$  is written downwards in terms of arrows. On the right hand side, a morphism in  $\Gamma$  is written upwards in terms “mergings” of intervals encoded by blocks. Two intervals here are merged into the base point.

**Example 20.2.3.** For  $X_M$  it is indeed the bar construction, e.g.  $B_k(X_M) = M^k$ , and you should imagine the intervals being labeled by  $M$ . Then  $d_i$ , induced by skipping  $i$ , so merges two intervals if  $i \neq 0, k$  and then is given by multiplication.

The fact that  $X$  was a  $\Gamma$ -space implies that each map  $B_n(X) \rightarrow B_1(X)^n$  which is induced by the inclusion of  $\{i, i + 1\}$  into  $\{0, \dots, n\}$  (or of one interval into  $n$  intervals), is a weak equivalence. A simplicial space with this property is called a *Segal space*.

**Theorem 20.2.4** (Segal).  $BX := |B_\bullet(X)|$  is an infinite loop space (the 0th space of an  $\Omega$ -spectrum).

Before sketching the proof, we make some observations. Firstly, the inclusion

$$X(1) \times \Delta^1 \hookrightarrow |B_\bullet(X)| = \left( \bigsqcup_{n \geq 0} X(n) \times \Delta^n \right)$$

sends  $X(1) \times \partial\Delta^1$  to the contractible space  $X(0)$ , and so the adjoint may be extended unique up to homotopy to a map  $X(1) \rightarrow \Omega BX$ . We want to construct a map from  $BX$  to a loop space, etc.



To see this, note that  $BX$  is again the first space of a  $\Gamma$ -space. Assigning to each pointed finite set  $S$  the functor  $X^S: T \mapsto X(S \wedge T)$  gives a  $\Gamma$ -object in  $\Gamma$ -space. Thus, realizing in the  $T$ -direction we get a  $\Gamma$ -space  $B^{(1)}X: S \mapsto BX^S$ .

This satisfies  $B^{(1)}X(1) \simeq BX$ , so that we have a map  $BX \rightarrow \Omega B(B^{(1)}X)$ . Iterating this construction we get

$$X(1) \rightarrow \Omega BX \rightarrow \Omega^2 B(B^{(1)}X) \rightarrow \Omega^3 B(B^{(2)}X) \rightarrow \dots$$

and we note that  $B^{(k)}X$  is levelwise path-connected if  $k \geq 1$ .

**Lemma 20.2.5.** *If  $X$  is a levelwise path-connected  $\Gamma$ -space, then  $X(1) \rightarrow \Omega BX$  is a weak equivalence.*

*Proof sketch.* Consider the simplicial space  $\text{sh}B_\bullet(X)$  given by  $p \mapsto B_{p+1}(X)$ , i.e. precomposing with  $* \sqcup -: \Delta \rightarrow \Delta$ , which maps to  $B_\bullet(X)$ . It is a result of Segal, proven inductively by a quasifibration glueing lemma, that if  $E_\bullet \rightarrow B_\bullet$  is a map of proper simplicial spaces such that for each injective morphism  $\theta: [q] \rightarrow [p]$  in  $\Delta$ , we have that

$$\begin{array}{ccc} E_p & \xrightarrow{\theta^*} & E_q \\ \downarrow & & \downarrow \\ B_p & \longrightarrow & B_q \end{array}$$

homotopy cartesian, then so is

$$\begin{array}{ccc} E_0 & \longrightarrow & |E_\bullet| \\ \downarrow & & \downarrow \\ B_0 & \longrightarrow & |B_\bullet|. \end{array}$$

In our case  $E_\bullet = \text{sh}B_\bullet(X)$  and  $B_\bullet = X$ , and the second diagram would become

$$\begin{array}{ccc} X(1) & \longrightarrow & |\text{sh}B_\bullet(X)| \simeq * \\ \downarrow & & \downarrow \\ X(0) \simeq * & \longrightarrow & BX, \end{array}$$

where  $|\text{sh}B_\bullet(X)|$  is contractible by an extra degeneracy argument (indeed, every shift is). The diagram being homotopy cartesian is equivalent to the sequence of weak equivalences

$$\begin{aligned} X(1) &\simeq \text{hofib}(X(1) \rightarrow X(0)) \\ &\simeq \text{hofib}(|\text{sh}B_\bullet(X)| \rightarrow BX) \\ &\simeq \text{hofib}(* \rightarrow BX) \simeq \Omega BX. \end{aligned}$$

The restriction to injective morphisms is possible since we quickly shift to the semi-simplicial space  $\Delta_{\text{inj}}^{\text{op}} \rightarrow \Delta^{\text{op}} \rightarrow \text{Top}$ , and its thick geometric realization.

In the setting of  $\Gamma$ -spaces, we may replace the levels of the simplicial spaces with products of  $X(1)$  up to weak equivalence. Now observe that  $\theta^*$  for  $\theta$  injective is a composite of face maps  $d_i$ . Each  $d_i$  acts on only two terms and since products preserve homotopy cartesian squares, we are reduced to showing that

$$\begin{array}{ccc} X(1)^2 & \xrightarrow{c} & X(1) \\ \downarrow \pi & & \downarrow \\ X(1) & \longrightarrow & * \end{array}$$

is homotopy cartesian, with  $\pi$  projection on the second factor and  $c$  is the composition map of the  $\Gamma$ -space. To check it is homotopy cartesian, it suffices to check the map on vertical homotopy fibers is a weak equivalence. This map is given by multiplication by some element. Since  $X(1)$  is path-connected and  $X(1)$  is unital up to homotopy, this is always a weak equivalence.  $\square$

In general, it is not true that  $X(1) \rightarrow \Omega BX$  is a weak equivalence. Instead it is an interesting map called the *group completion* map for reasons that will soon become clear when we reach Theorem 20.2.10.

**Definition 20.2.7.** The *group completion algebraic K-theory* is given by

$$K^{\Omega B}(R) := \Omega BX_R.$$

**Corollary 20.2.8.**  $K^{\Omega B}(R)$  is the infinite loop space associated to a spectrum.

**Example 20.2.9.** We claim that  $\pi_0(\Omega BX_R) \cong K_0(R)$ . To see this, note that  $\pi_0(\Omega BX_R) \cong \pi_1(BX_R)$  and  $BX_R$  has a single 0-cell and 1-cells given by 0-cells in  $X(1)$ , i.e. finitely-generated projective  $R$ -modules  $P$ . Thus  $\pi_1$  is generated by homotopy classes of loops  $\gamma_P$ . The 2-cells come from 1-cells of  $X(1)$  and 0-cells of  $X(2)$ , and thus implement either  $\gamma_P \simeq \gamma_{P'}$  if  $P \cong P'$  and  $\gamma_{P \oplus Q} \simeq \gamma_P * \gamma_Q$ .

*Algebraic K-theory and homology of general linear groups*

To see that our previous definition of  $K_1$  in terms of group homology arises naturally from  $K^{\Omega B}$ , we will find a commutative unital monoid  $M_R$  (so strictly associative and strictly unital) such that  $BX_{M_R} \simeq BX_R$ .

To do so, consider the category with objects pairs  $(R^n, \pi)$  of a finitely generated free  $R$ -modules and a projection, and morphisms  $R$ -linear isomorphisms between the images. By direct sum, this becomes a homotopy commutative unital monoid. We have  $BX_R \simeq BX_{M_R}$ , and  $BX_{M_R}$  is isomorphic to the ordinary bar construction  $BM_R$ . The point of this is to apply the following theorem [MS76], usually called the *group completion theorem*.

**Remark 20.2.6.** In fact, this proof only needs that the abelian monoid structure induced on  $\pi_0(X(1))$  is a group, i.e. has inverses.

$i$	1	2	3	4	5
$K_i(\mathbb{Z})$	$\mathbb{Z}/2$	$\mathbb{Z}/2$	$\mathbb{Z}/48$	0	$\mathbb{Z}$

Table 20.2: The algebraic K-theory groups  $K_i(\mathbb{Z}) := \pi_i(K(\mathbb{Z}))$  for  $1 \leq i \leq 5$ .  $K_0 \cong \mathbb{Z}$  already appeared in Table 20.1.

**Theorem 20.2.10** (McDuff-Segal). *If  $M$  is a homotopy commutative unital monoid, then we have that*

$$H_*(\Omega BM) \cong H_*(M)[\pi_0(M)^{-1}].$$

The idea of its proof is to do a variation of the proof of Lemma 20.2.5, using homology instead of homotopy. Just like a square being homotopy cartesian means that the maps on homotopy fibers over all base points are weak equivalences, it being *homology cartesian* means they are homology equivalences.

*Proof sketch of Theorem 20.2.10.* Let us specialize to the case that  $\pi_0(M) \cong \mathbb{N}_0$  for ease of notation. We shall use a result about homology fibrations analogous to the one about quasi-fibrations used in Lemma 20.2.5. It says that if  $E_\bullet \rightarrow B_\bullet$  is a map of proper simplicial spaces such that for each injective  $\theta: [q] \rightarrow [p]$  in  $\Delta$  the diagram

$$\begin{array}{ccc} E_p & \xrightarrow{\theta^*} & E_q \\ \downarrow & & \downarrow \\ B_p & \xrightarrow{\theta^*} & B_q \end{array}$$

homology cartesian, then so is the diagram

$$\begin{array}{ccc} E_0 & \longrightarrow & |E_\bullet| \\ \downarrow & & \downarrow \\ B_0 & \longrightarrow & |B_\bullet|. \end{array}$$

In our case, pick  $m_1$  in the path-component of  $M$  corresponding to 1, and let  $M_\infty$  be the homotopy colimit over  $m_1 \cdot -: M \rightarrow M$ . Even though we have used up to left  $M$ -module structure, this is still a right  $M$ -module and its homology is  $\text{colim} H_*(M) \cong H_*(M)[\pi_0^{-1}]$ . Then we can consider the simplicial space

$$[p] \longmapsto M_\infty \times M^p$$

using the right  $M$ -module action on  $M_\infty$  (called the two-sided bar construction and usually denoted  $B(M_\infty, M, *)$ ), which maps to  $B_\bullet M$  by sending  $M_\infty$  to a point.

We want to apply the above result. Since geometric realization commute with filtered homotopy colimits, we have that

$$B(M_\infty, M, *) \simeq \text{hocolim} B(M, M, *) \simeq *,$$

the last step by an extra degeneracy argument. Furthermore  $B_0 = *$ , so like in Lemma 20.2.5, we would end up proving that  $M_\infty$  is homology equivalent to  $\Omega BM$ , as desired.

As before we only need to check the following diagram is homology cartesian:

$$\begin{array}{ccc} M_\infty \times M & \xrightarrow{a} & M_\infty \\ \downarrow \pi & & \downarrow \\ M & \longrightarrow & *, \end{array}$$

with  $\pi$  projection and  $a$  acting on the right, is homology cartesian.

Checking on fibers over  $M$ , it suffices that for every  $m \in M$ , the map  $-\cdot m: M_\infty \rightarrow M_\infty$  is a homology isomorphism. This is true since  $M$  is homotopy commutative, whence  $-\cdot m$  is homotopic to  $m \cdot -$  on  $M$ . If  $m$  is the  $n$ th component, acting by it is equal to  $(m_1 \cdot -)^n$ , which was inverted.  $\square$

**Remark 20.2.11.** The conditions for this theorem can weakened (e.g.  $\pi_0$  only needs to admit a calculus of right fractions), and the consequences often stronger (the map  $M_\infty \rightarrow \Omega BM$  is acyclic, i.e. the map is an isomorphism for local coefficients coming from the target) [RW13, MP15].

If  $M_R^{\text{free}}$  denotes the topological submonoid of those components corresponding to the free modules, then we have that

$$H_*(M_R^{\text{free}})[\pi_0^{-1}] \cong \operatorname{colim}_{n \rightarrow \infty} H_* \left( \bigsqcup_{n \geq 0} BGL_n(R) \right).$$

There is an inclusion  $M_R^{\text{free}} \hookrightarrow M_R$ , inducing a map

$$H_*(M_R^{\text{free}})[\pi_0^{-1}] \rightarrow H_*(M_R)[\pi_0^{-1}],$$

which will not be an isomorphism in degree 0 as there are more projective modules than just the free ones. However, it is an isomorphism onto those components that are in its image. This is because inverting just direct sum by free modules also inverts direct sum by projective modules, as every projective is a summand of a free module.

Since  $K^{\Omega B}(R)$  is an infinite loop space,  $\pi_1$  of each of its component (say the one corresponding to the equivalence class of the free module  $[0]$ ) is equal  $H_1$  of that component. Hence we conclude that

$$\pi_1(K^{\Omega B}(R)) \cong \operatorname{colim}_{n \rightarrow \infty} H_1(BGL_n(R)).$$

Thus  $K^{\Omega B}(R)$  satisfies (i) and at least part of (iv), the latter in the sense that  $\Omega B$  creates an infinite loop space, the homotopy-theoretic version of an abelian group. A universal property in the homotopy category is described in Theorem IV.1.5 of [Wei13].

## 21

# The theorems of Igusa and Waldhausen

Today will be a “story-time” lecture. This means we will not prove many of the results stated, but outline a theory. We will apply it in the next lecture to prove that the surjective map  $\pi_0(\text{Diff}_\partial(D^n)) \rightarrow \Theta_{n+1}$  is also injective. Our references are [Hat78, Wal85, Wei13].

### 21.1 The $S_\bullet$ -construction

Waldhausen generalized algebraic  $K$ -theory from rings to categories  $\mathcal{C}$  which have the additional structure of a Waldhausen category [Wal85] (see also Section IV.8 of [Wei13], which also discusses the delooped  $G_\bullet$ -construction by Gillet-Grayson in Section IV.9 and which some people find more intuitive because its  $\pi_0$  is  $K_0$ ). This is the most convenient construction for desiderata (ii) (technical tools) and (a higher-categorical version of) (iv) (a universal property) from last lecture.

#### The $S_\bullet$ -construction

A Waldhausen category is a category with the minimal data necessary to construct algebraic  $K$ -theory. Specializing to  $\mathcal{C} = \text{P}(R)$ , the category of finitely generated projective  $R$ -modules, we recover  $K(R)$ . The example of  $\mathcal{C}$  to keep in mind is the category  $\text{FinSet}_*$  of pointed finite sets.

**Definition 21.1.1.** A *Waldhausen category* is a pointed category  $\mathcal{C}$  with two classes of arrows  $c(\mathcal{C})$  and  $w(\mathcal{C})$  of cofibrations and weak equivalences. These should satisfy the following properties:

- (i) Isomorphisms are cofibrations and weak equivalences.
- (ii) Cofibrations and weak equivalences are closed under composition.
- (iii) The map from the initial object is a cofibration.

Takeaways:

- Algebraic  $K$ -theory may also be constructed by the  $S_\bullet$ -construction, which may be applied to a category of retractive finite spaces over  $X$  to obtain  $A(X)$ .
- If  $X$  is path-connected, this can be rewritten in terms of matrices.
- Including finite sets over  $X$  into retractive finite spaces over  $X$ , we get a map  $\text{QX}_+ \rightarrow A(X)$  whose homotopy fiber is  $\Omega\text{Wh}^{\text{Diff}}(X)$ .
- Igusa and Waldhausen proved that there is a highly-connected map  $H(M) \rightarrow \Omega\text{Wh}^{\text{Diff}}(X)$  with domain the moduli space of  $h$ -cobordisms starting at  $M$ .

- (iv) Cofibrations are preserved by cobase change: for each commutative diagram with horizontal map a cofibration

$$\begin{array}{ccc} B & \hookrightarrow & A \\ \downarrow & & \\ C & & \end{array}$$

the pushout  $A \cup_B C$  exists and the map  $C \rightarrow A \cup_B C$  is a cofibration.

- (v) Left properness: if in a commutative diagram

$$\begin{array}{ccccc} A & \hookrightarrow & B & \longrightarrow & C \\ \downarrow \simeq & & \downarrow \simeq & & \downarrow \simeq \\ A' & \hookrightarrow & B' & \longrightarrow & C' \end{array}$$

all vertical arrows are weak equivalences, and left horizontal maps are cofibrations, then  $A \cup_B C \rightarrow A' \cup_{B'} C'$  is also a weak equivalence.

**Definition 21.1.2.** Let  $\text{Ar}([n])$  be the category of arrows in the linear category  $[n]$  given by  $0 \rightarrow 1 \dots \rightarrow n$ . That is, the objects are morphisms  $(i \rightarrow j)$  and a morphism  $(i \rightarrow j) \rightarrow (k \rightarrow l)$  is given by a commutative diagram

$$\begin{array}{ccc} i & \longrightarrow & j \\ \downarrow & & \downarrow \\ k & \longrightarrow & l. \end{array}$$

**Definition 21.1.3.** We define a category  $S_n(\mathcal{C})$  as the full subcategory of functors  $F: \text{Ar}([n]) \rightarrow \mathcal{C}$  on those objects  $F$  such that  $F(i \rightarrow i) = *$ , all horizontal maps  $F(i \rightarrow j) \rightarrow F(i \rightarrow k)$  are cofibrations and each square

$$\begin{array}{ccc} F(i \rightarrow j) & \hookrightarrow & F(i \rightarrow k) \\ \downarrow & & \downarrow \\ F(j \rightarrow j) \cong * & \hookrightarrow & F(j \rightarrow k) \end{array}$$

is a pushout square.

For example, the objects of  $S_2(\mathcal{C})$  look like

$$\begin{array}{ccccc} * & \hookrightarrow & F(0 \rightarrow 1) & \hookrightarrow & F(0 \rightarrow 2) \\ & & \downarrow & & \downarrow \\ & & * & \hookrightarrow & F(1 \rightarrow 2) \\ & & & & \downarrow \\ & & & & * \end{array}$$

with the square a pushout square. In general the top line  $F(0 \rightarrow j)$  gives a filtration of the corner  $F(0 \rightarrow n)$ , with filtration quotients  $F(j \rightarrow j+1)$  appearing just above the diagonal with  $*$ 's. In fact, you can think of  $S_\bullet$ -construction as a space of filtrations with *chosen* subquotients (which a priori are only defined up to isomorphism).

By using the fact that  $[n] \mapsto \text{Ar}([n])$  is a cosimplicial category, we see that  $[n] \mapsto S_n(\mathcal{C})$  is a simplicial category. We have not yet used the weak equivalences, so let's do so:

**Definition 21.1.4.** Let  $\mathcal{C}$  be a Waldhausen category, then we define the *Waldhausen algebraic K-theory* to be

$$K^{S_\bullet}(\mathcal{C}) := \Omega |wS_\bullet(\mathcal{C})|,$$

where  $wS_n(\mathcal{C})$  is the subcategory of  $S_n(\mathcal{C})$  with same objects but only those morphisms that are natural transformations consisting of weak equivalences.

### *The category of projective modules*

We may apply this to the category  $\mathcal{P}(R)$  of finitely-generated projective  $R$ -modules, with cofibrations the monomorphisms with projective cokernel and weak equivalences the isomorphisms. Let us denote the resulting  $K$ -theory space by  $K^{S_\bullet}(R)$ . Results of Quillen and Waldhausen imply the following:

**Theorem 21.1.5** (Quillen-Waldhausen). *If  $R$  is a ring, then we have that*

$$K^{\Omega B}(R) \simeq K^{S_\bullet}(R).$$

*Proof sketch.* There is a simplicial map (it is convention to use  $i$  instead of  $w$  when the weak equivalences are the isomorphisms)

$$|iS_n(\mathcal{P}(R))| \rightarrow X_R(n)$$

by sending  $F$  to the "filtration quotients"  $(F(0 \rightarrow 1), F(1 \rightarrow 2), \dots, F(n-1, n))$  (the diagonal just above the  $*$ 's). Waldhausen proved using his additivity theorem that this becomes a weak equivalence upon realizing the  $[n]$ -direction.  $\square$

### *The category of finite sets*

We may also apply the  $S_\bullet$ -construction to  $\text{FinSet}_*$ , with cofibrations the injections and weak equivalences the isomorphisms. Let  $\text{FinSet}$  denote the category of finite sets of order  $n$  with isomorphisms, then we have that

$$|iS_n(\text{FinSet}_*)| \rightarrow (B\text{FinSet})^n$$

is an isomorphism, because short exact sequences of finite sets aren't just split but canonically so! It is clearly true that  $B\text{FinSet} \simeq \bigsqcup_{n \geq 0} B\Sigma_n$  by restriction to a skeleton. We conclude that

$$K^{\mathcal{S}\bullet}(\text{FinSet}_*) \simeq \Omega B \left( \bigsqcup_{n \geq 0} B\Sigma_n \right).$$

In Chapter 32, we will prove — when talking about cobordism categories — the following as the special case of a 0-dimensional cobordism category. This uses that finite sets are exactly the compact 0-dimensional manifolds. For a reference in the algebraic  $K$ -theory literature, see Theorem IV.4.9.3 of [Wei13].

**Theorem 21.1.6** (Barratt-Priddy-Quillen-Segal). *There is a weak equivalence*

$$\Omega B \left( \bigsqcup_{q \geq 0} B\Sigma_q \right) \simeq \Omega^\infty \mathcal{S},$$

where  $\mathcal{S}$  denotes the sphere spectrum. In particular, we have that  $K_i(\text{FinSet}_*)$  is isomorphic to the  $i$ th stable homotopy group of spheres.

That is, the sphere spectrum is the algebraic  $K$ -theory of finite sets.

## 21.2 Algebraic $K$ -theory of spaces

We shall discuss the algebraic  $K$ -theory of spaces  $A(X)$ , first using the  $S_\bullet$ -construction and then a version of group completion for path-connected  $X$ . We then construct the map  $QX_+ \rightarrow A(X)$ , whose homotopy fiber is  $\Omega\text{Wh}^{\text{Diff}}(X)$ .

### *Algebraic $K$ -theory of spaces via $S_\bullet$ -construction*

Let  $X$  be a space. Eventually this will be our manifold.

**Definition 21.2.1.** A *retractive finite space over  $X$*  is a space  $Y$  with cofibration  $i: X \hookrightarrow Y$  and retraction  $r: Y \rightarrow X$ , i.e.  $r \circ i = \text{id}_X$ , such that the pair  $(Y, X)$  is homotopy equivalent to a relative finite CW pair. A map of retractive finite spaces over  $X$  is a continuous map that is the identity on  $X$  and compatible with the retractions.

We can define a Waldhausen category  $R_f(X)$  of retractive finite spaces over  $X$  by taking the cofibrations to be the Hurewicz cofibrations, and the weak equivalences to be the homotopy equivalences  $\text{rel } X$  (or equivalently weak equivalences, since the objects are homotopy equivalent to a relative CW pair). Note that the category would not be pointed without the retraction, as it provides the maps exhibiting  $X$  itself (with identity cofibration and retraction) as the terminal object.



**Definition 21.2.2.** We define the algebraic  $K$ -theory of spaces  $A(X)$  of  $X$  to be

$$A(X) := K^{S^\bullet}(wR_f(X)).$$

Intuitively algebraic  $K$ -theory homotopy-coherently (a) group completes, and (b) splits cofiber sequences. In the previous lecture we focused our attention on (a), as cofiber sequences were already split in our examples. This is of course not true in retractive spaces, and forcing the splitting of cofiber sequences allows the computation  $\pi_0(A(X)) \cong \mathbb{Z}[\pi_0(X)]$ . Let us discuss this in some examples using the following lemma, which follows from a consideration of the 1-skeleton of  $K^{S^\bullet}(wR_f(X))$ :

**Lemma 21.2.3.** *The group  $\pi_0(A(X))$  is generated by symbols  $[Y]$  with  $Y$  a retractive finite space over  $X$ , under the equivalence relation that  $[Y] = [Y']$  if  $Y \simeq Y'$  over  $X$ , and  $[Y'] = [Y] + [Y'']$  if there is a cofiber sequence  $Y \hookrightarrow Y' \rightarrow Y'' \cong Y'/Y$ .*

**Example 21.2.4.** In  $\pi_0(A(*))$  each disk satisfies  $0 = [D^k] = [S^{k-1}] + [S^k]$ , because  $D^k$  is weakly equivalent to  $*$  and by splitting the inclusion of the boundary. Thus we have that  $[S^k] = (-1)^k[S^0]$ . This leads to the identification of  $\pi_0(A(*))$  with the *relative Euler characteristic*; e.g. we have that the class  $[\mathbb{T}^2]$  represented by a based torus is equivalent to  $[S^1 \vee S^1 \vee S^2]$  by splitting the inclusion of the 1-skeleton, and this is  $-[S^0] - [S^0] + [S^0] = -[S^0]$ , and  $-1$  is indeed equal to  $\chi(\mathbb{T}^2, *)$ .

**Example 21.2.5.** In  $\pi_0(A(S^1))$ ,  $S^1 \sqcup *$  admits many retractions to  $S^1$ ,  $r_\theta$  for  $\theta \in S^1$ . However, all represent the same class: for  $\theta_0, \theta_1 \in S^1$ , take  $S^1 \sqcup I$  with  $r_I: I \rightarrow S^1$  having both  $\theta_0$  and  $\theta_1$  in its image. Then there is a zigzag of weak equivalences over  $X$

$$(S^1 \sqcup *, r_{\theta_0}) \rightarrow (S^1 \sqcup I, r_I) \leftarrow (S^1 \sqcup I, r_{\theta_1}).$$

This generalizes to say that relative CW complexes with homotopic attaching maps represent the same class in  $\pi_0(A(S^1))$ .

Next, one may be concerned that apart from the class of  $S^1 \vee S^2$ ,  $\pi_0(A(S^1))$  contains another class from a non-trivial loop in  $S^1$ , e.g.  $S^1 \cup_{S^1} D^2$ . However, this does *not* admit a retraction to  $S^1$ .

### A group completion construction of $A(X)$

Waldhausen also proved there is an analogue of the group completion construction when  $X$  is path-connected. This uses the Kan loop group  $GX$ , weakly equivalent to  $\Omega X$  but in fact topological group, Section VI.5 of [GJo9].

Then we may consider the space of continuous pointed maps  $\bigvee_n S^k \wedge GX_+ \rightarrow \bigvee_n S^k \wedge GX_+$ . Let us take the subspace  $\text{haut}_{*,GX}(\bigvee_n S^k \wedge GX_+)$

of  $GX$ -equivariant pointed homotopy automorphisms. If  $k \geq 2$ , applying  $\pi_0$  gives an isomorphism with  $\mathrm{GL}_n(\mathbb{Z}[\pi_1])$ : there are weak equivalences

$$\begin{aligned} \mathrm{map}_{*,GX} \left( \bigvee_n S^k \wedge GX_+, \bigvee_n S^k \wedge GX_+ \right) &\simeq \mathrm{map}_* \left( \bigvee_n S^k, \bigvee_n S^k \wedge GX_+ \right) \\ &\cong \prod_n \Omega^k \left( \bigvee_n S^k \wedge GX_+ \right), \end{aligned}$$

and the latter has  $\pi_0$  given by  $\mathrm{Hom}_{\mathrm{Ab}}(\mathbb{Z}^n, \mathbb{Z}[\pi_1]^n) \cong \mathrm{Hom}_{\mathbb{Z}[\pi_1]\text{-Mod}}(\mathbb{Z}[\pi_1]^n, \mathbb{Z}[\pi_1]^n)$ .

We now want to let  $k \rightarrow \infty$ , in which case we can give a different description. Consider the symmetric spectrum  $\Sigma^\infty GX_+$ . Since  $\Sigma^\infty: \mathrm{Top}_+ \rightarrow \mathrm{Sp}$  is defined as  $Y \mapsto \mathbb{S} \wedge Y$  and symmetric spectra has a symmetric monoidal structure for which  $\mathbb{S}$  is the unit,  $\Sigma^\infty GX_+$  is a unital monoid in symmetric spectra. Thus we can define left modules over it, and set  $\mathrm{GL}_n(\Sigma^\infty GX_+)$  to be the space of homotopy invertible  $\Sigma GX_+$ -module maps from  $\bigvee_n \Sigma^\infty GX_+$  to itself. As before

$$\begin{aligned} \mathrm{map}_{\Sigma^\infty GX_+} \left( \bigvee_n \Sigma^\infty GX_+, \bigvee_n \Sigma^\infty GX_+ \right) &\simeq \mathrm{map}_{\mathrm{Spectra}} \left( \bigvee_n \mathbb{S}, \bigvee_n \Sigma^\infty GX_+ \right) \\ &\simeq \prod_n \Omega^\infty(\Sigma^\infty GX_+)^n, \end{aligned}$$

and we may define  $\mathrm{GL}_n(\Sigma^\infty GX_+)$  by picking the components corresponding to  $\mathrm{GL}_n(\mathbb{Z}[\pi_1])$ . By the Freudenthal suspension theorem we conclude that

$$\mathrm{GL}_n(\Sigma^\infty GX_+) \simeq \mathrm{hocolim}_{k \rightarrow \infty} \mathrm{haut}_{*,GX} \left( \bigvee_n S^k \wedge GX_+ \right).$$

We shall use the notation  $B\mathrm{GL}_n(\Sigma^\infty GX_+)$  for  $\mathrm{hocolim} B\mathrm{haut}_{*,GX} \left( \bigvee_n S^k \wedge GX_+ \right)$ , even though the left hand side is not a topological monoid (only an  $E_1$ -space). These classifying spaces form a topological monoid with multiplication map induced by wedging maps together. The following is proven in Section 2.2 of [Wal85].

**Theorem 21.2.6** (Waldhausen). *If  $X$  is path-connected, there is a weak equivalence*

$$\Omega B \left( \bigsqcup_{n \geq 0} B\mathrm{GL}_n(\Sigma^\infty GX_+) \right) \simeq K^{\mathbb{S}^\bullet}(wR_f(X)).$$

The map  $QX_+ \rightarrow A(X)$

We can form the wreath product topological group  $\Sigma_n \wr GX$  and include this into  $\mathrm{haut}_{*,GX} \left( \bigvee_n S^0 \wedge GX_+ \right)$  as “permutation matrices”

with entries in  $GX$ . By increasing the dimension of the sphere in the target and group completion we get a map

$$\Omega B \left( \bigsqcup_{n \geq 0} B(\Sigma_n \wr GX) \right) \rightarrow \Omega B \left( \bigsqcup_{n \geq 0} BGL(\Sigma^\infty GX_+) \right),$$

and by Waldhausen's theorem the target is weakly equivalent to  $A(X)$ . On the other hand, by a labeled version of the Barratt-Quillen-Priddy-Segal theorem we have that the source is weakly equivalent to  $QX_+ := \Omega^\infty \Sigma^\infty X_+$ , see Exercise IV.7.7 of [Wei13]. We thus obtain a map

$$QX_+ \rightarrow A(X),$$

and from the construction, it is clear that this is induced by a map of spectra

$$\Sigma^\infty X_+ \rightarrow \underline{A}(X),$$

which one should think of as being a delooping of the inclusion of the  $(1 \times 1)$ -matrices.

There is an alternative construction of this map, which uses a Waldhausen category of retractive finite spaces over  $X$  which are weakly equivalent to  $X \sqcup \{\text{finite set}\} \text{ rel } X$ , and retraction providing the finite set up to homotopy with a labeling by elements of  $X$ . This is particularly easy in the case  $X = *$ , in which case we may instead use actual finite sets and the map is induced upon  $S_\bullet$ -construction by the inclusion of Waldhausen categories

$$\text{FinSet}_* \hookrightarrow R_f(*).$$

### The Whitehead space

We can now define the Whitehead space.

**Definition 21.2.7.** The *smooth Whitehead spectrum*  $\underline{\text{Wh}}^{\text{Diff}}(X)$  of  $X$  is given by the cofiber of the map

$$\Sigma^\infty X_+ \rightarrow \underline{A}(X).$$

From this we obtain the *smooth Whitehead space*

$$\Omega \text{Wh}^{\text{Diff}}(X) := \Omega^{\infty+1} \underline{\text{Wh}}^{\text{Diff}}(X),$$

which is weakly equivalent to the homotopy fiber of  $QGX_+ \rightarrow A(X)$ . Note that taking  $\Omega^{\infty+1}$  does not discard any information: the map  $QGX_+ \rightarrow A(X)$  on  $\pi_0$  is simply the identity map  $\mathbb{Z} \rightarrow \mathbb{Z}$ , so  $\underline{\text{Wh}}^{\text{Diff}}(X)$  is 0-connected.

*Waldhausen’s splitting theorem*

A priori, the relation between  $\Omega\text{Wh}^{\text{Diff}}(X)$ ,  $\text{QGX}_+$  and  $A(X)$  may be complicated. However, using the Bökstedt trace (or equivalently Goodwillie linearization of  $A(-)$ ) we can map back to  $\Sigma X_+$ . This uses  $\text{THH}_S$ , which may easily be defined for ring spectra symmetric spectra using the cyclic bar construction, under cofibrancy conditions. This is the geometric realization of the simplicial object

$$[p] \mapsto B_p^{\text{cyc}}(R) := R^{\wedge p+1},$$

with differentials induced by thinking of  $[p]$  as  $(p + 1)$  points on the circle:

$$\text{THH}_S(R) := |B_{\bullet}^{\text{cyc}}(R)|.$$

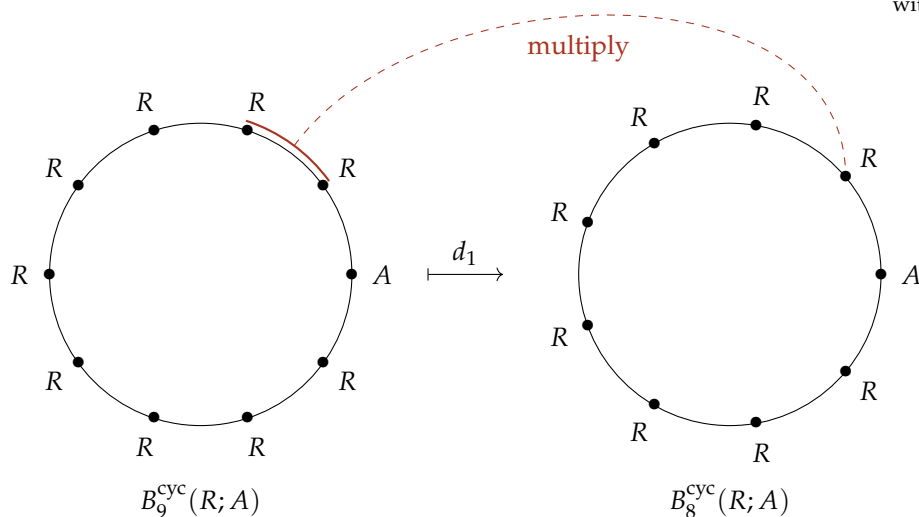

Figure 21.1: The cyclic bar construction with coefficients.

We can generalize the cyclic bar construction of  $R$  to have coefficients in a bimodule  $A$ , see Figure 21.1:

$$B_p^{\text{cyc}}(R; A) := R^{\wedge p} \wedge A.$$

Then we have that  $B_{\bullet}^{\text{cyc}}(R; R) = B^{\text{cyc}}(R)$ , while  $B_{\bullet}^{\text{cyc}}(R; S)$  is the double bar construction  $B(S, R, S)$ .

The Bökstedt trace is a generalization of the Dennis trace  $K_*(R) \rightarrow HH_*(R)$  (upgrading from base  $\mathbb{Z}$  to base  $S$ ). The latter is given by noting that there is a simplicial map<sup>1</sup>

$$B_p(\text{GL}_n(R)) = \text{GL}_n(R)^p \rightarrow B_p^{\text{cyc}}(R) = R^{p+1}$$

$$(M^1, \dots, M^p) \mapsto \sum_{i_1, \dots, i_p} M_{i_1, i_2}^1 M_{i_2, i_3}^2 \cdots M_{i_{p-1}, i_p}^{p-1} M_{i_p, i_1}^p.$$

**Remark 21.2.8.** We can also take the cyclic bar construction of an associative dg-algebra  $R$  with values in a dg-bimodule  $A$ , in the case  $\text{Ch}_{\mathbb{Z}}$ . Then the resulting chain complex is quasi-isomorphic to the Hochschild chain complex  $\text{HH}(R; A)$ .

<sup>1</sup> This is the ordinary trace when  $p = 1$ .

We thus get a map

$$\mathrm{tr}: \underline{A}(X) \rightarrow \mathrm{THH}_S(\Sigma^\infty GX_+),$$

whose target is weakly equivalent  $\Sigma^\infty LX_+$ , where  $LX$  denotes the free loop space. This is a generalization of Goodwillie's theorem that  $HH_*(C_*(\Omega X)) \cong H_*(LX)$  when  $X$  is path-connected [Goo85]. We can then evaluate the free loops at  $1 \in S^1$  to map to  $\Sigma^\infty X_+$ . One may check that the composite map

$$\Sigma^\infty X_+ \rightarrow \underline{A}(X) \rightarrow \mathrm{THH}_S(\Sigma^\infty GX_+) \simeq \Sigma^\infty LX_+ \rightarrow \Sigma^\infty X_+$$

is the identity: the trace restricted to  $(1 \times 1)$ -matrices is essentially the identity. As a consequence, we obtain Waldhausen's splitting theorem:

**Theorem 21.2.9** (Waldhausen). *There is a weak equivalence*

$$A(X) \simeq \mathrm{Wh}^{\mathrm{Diff}}(X) \times QX_+.$$

### 21.3 Moduli spaces of $h$ -cobordisms

We now explain the relationship between algebraic  $K$ -theory of spaces and  $h$ -cobordisms.

#### Concordance diffeomorphisms

The  $s$ -cobordism theorem classifies  $h$ -cobordisms of dimension  $n \geq 6$ . In particular, it says that given a closed  $(n-1)$ -dimensional manifold  $M$ , we have that

$$\{h\text{-cobordisms starting at } M\} / \text{diffeomorphism rel } M \cong \mathrm{Wh}_1(\pi_1(M)).$$

Following the philosophy of this course, we next want to know the automorphisms of the  $h$ -cobordisms. Since by composition of  $h$ -cobordisms we can move between different isomorphism classes, the homotopy type of the automorphisms is independent of the choice and we may as well take the trivial one. Then an automorphism is a diffeomorphism of  $M \times I$  which fixes only  $M \times \{0\}$  pointwise. Let us, for later use, define a version when  $M$  has non-empty boundary  $\partial M$ .

**Definition 21.3.1.** The concordance diffeomorphism group  $\mathcal{C}(M)$  is given by

$$\mathcal{C}(M) := \mathrm{Diff}(M \times I \text{ rel } M \times \{0\} \cup \partial M \times I).$$

Note that restriction to  $M \times \{1\}$  gives a homomorphism  $\mathcal{C}(M) \rightarrow \mathrm{Diff}_\partial(M)$  whose fiber over the identity is  $\mathrm{Diff}_\partial(M \times I)$ . Thus in the case of  $M = D^n$ , we have up to weak equivalence a fiber sequence

$$\mathrm{Diff}_\partial(D^{n+1}) \rightarrow \mathcal{C}(D^n) \rightarrow \mathrm{Diff}_\partial(D^n).$$

Thus through understanding the concordance diffeomorphisms  $\mathcal{C}(D^n)$  we get close to diffeomorphisms of disks.

The conclusion is that the *moduli space*  $H(M)$  of *h-cobordisms starting at  $M$*  may be described up to weak equivalence as

$$H(M) \simeq \text{Wh}_1(\pi_1(M)) \times BC(M),$$

as indeed a homotopy class of maps  $X \rightarrow \text{Wh}_1(\pi_1(M)) \times BC(M)$  classifies a bundle of *h-cobordisms* over  $X$  with incoming boundary trivialized as  $X \times M$ . However, there is also a direct geometric description:

**Definition 21.3.2.**  $H(M)$  is the simplicial set with  $k$ -simplices given by bundles  $W \rightarrow \Delta^k$  of smooth manifolds with boundary, with an embedding  $M \times \Delta^k \rightarrow W$  over  $\Delta^k$ , exhibiting  $W$  as a bundle of *h-cobordisms* starting with  $M$ .

*Stabilization*

There is a map on bundles of *h-cobordisms*, which takes the fiberwise product with an interval  $I$ . This induces a map  $H(M) \rightarrow H(M \times I)$ , where since  $M \times I$  has boundary we use relative *h-cobordisms*: the cobordism must be one of manifolds with boundary and the boundary cobordism is trivialized as a product. On concordance diffeomorphisms this may be described by Figure 21.2.

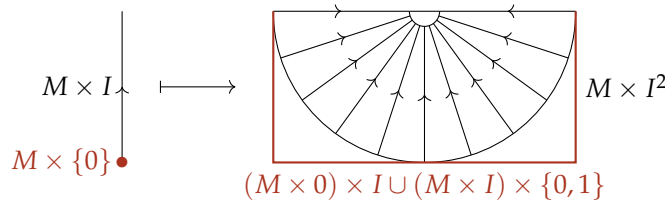

Figure 21.2: The stabilization map on concordance diffeomorphisms.

**Definition 21.3.3.** We define the stable *h-cobordism* space as

$$\mathcal{H}(M) := \text{hocolim}_{k \rightarrow \infty} H(M \times I^k).$$

This is weakly equivalent to  $\text{Wh}_1(\pi_1) \times \text{hocolim}_{k \rightarrow \infty} BC(M \times I^k)$ .

*The stable parametrized h-cobordism theorem and Igusa stability theorem*

The following are the main theorems of [Igu88] and [WJR13a].

**Theorem 21.3.4 (Igusa).** *Let  $M$  be of dimension  $m$ , then the map  $H(M) \rightarrow \mathcal{H}(M)$  is  $\min\left(\frac{m-1}{3}, \frac{m-5}{2}\right)$ -connected. It is already surjective on homotopy groups  $\pi_k$  for  $k \leq \frac{m-5}{2}$ .*

Recall an  $n$ -connected is an isomorphism on  $\pi_i$  for  $i < n$ . Thus, this becomes an isomorphism on  $\pi_0$  when  $m \geq 7$  and isomorphism on  $\pi_1$  when  $m \geq 9$ , but eventually the range of homotopy groups in which it is an isomorphism will grow with slope  $1/3$ . The  $s$ -cobordism theorem and work of Hatcher-Wagoner-Igusa show that  $\pi_0$  and  $\pi_1$  stabilize a bit earlier;  $\pi_0$  when  $m = 6$ , and  $\pi_1$  when  $m = 7$  [HW73, Igu84].

Thus it makes sense to want to compute  $\mathcal{H}(M)$  if one is interested in families of  $h$ -cobordisms. The stable computation is a result of Waldhausen, Theorem 0.3 of [WJR13a]:

**Theorem 21.3.5** (Waldhausen). *There is a natural weak equivalence*

$$\mathcal{H}(M) \simeq \Omega\mathrm{Wh}^{\mathrm{Diff}}(M).$$

It should *not* be obvious how to use this compute  $\mathcal{H}(M)$ , or even recover the  $s$ -cobordism theorem. In the next lecture we will explain how to do this, and we compute  $\pi_1(\mathcal{H}(M)) \cong \pi_0(\mathcal{C}(M))$ .





## The Hatcher-Wagoner-Igusa sequence

In the previous lecture we started the theorems of Igusa and Waldhausen. Today we use them to prove  $\pi_0(\text{Diff}_0(D^n)) \rightarrow \Theta_{n+1}$  is bijective is  $n \geq 7$ , as an application of the more general Hatcher-Wagoner-Igusa sequence. The classical references are [HW73, Igu84], but we follow [Jah10]. We also use some results from [Wal78].

Takeaways:

- To obtain computations in terms of Whitehead groups, one compares  $A(X)$  to  $K(\mathbb{Z}[\pi_1])$ .
- This gives a way to compute  $\pi_0(\mathcal{C}(M))$ .

### 22.1 The $s$ -cobordism theorem

Our goal in this first section will be to see how the Igusa-Waldhausen theorems allow for a computation of  $\pi_0(H(X))$ , as a practice for the computation of  $\pi_1(H(X)) \cong \pi_0(\mathcal{C}(X))$  in the next section. We shall assume throughout that  $X$  is path-connected.

#### Setting up the sequence

Recall that there was a weak equivalence

$$\Omega B \left( \bigsqcup_{n \geq 0} BGL_n(\Sigma^\infty GX_+) \right) \xrightarrow{\simeq} A(X).$$

This may be extended to a homotopy commutative diagram

$$\begin{array}{ccccc} \Omega B \left( \bigsqcup_{n \geq 0} B(\Sigma_n \wr GX) \right) & \longrightarrow & \Omega B \left( \bigsqcup_{n \geq 0} BGL_n(\Sigma^\infty GX_+) \right) & \xrightarrow{\simeq} & A(X) \\ \downarrow & & \downarrow & & \downarrow \\ \Omega B \left( \bigsqcup_{n \geq 0} B(\Sigma_n \wr \pi_1) \right) & \longrightarrow & \Omega B \left( \bigsqcup_{[P]} BGL(P) \right) & \xrightarrow{\simeq} & K(\mathbb{Z}[\pi_1]), \end{array}$$

where the  $[P]$  range over isomorphism classes of finitely generated projective  $\mathbb{Z}[\pi_1]$ -modules, and  $GL(P)$  are the automorphisms as a  $\mathbb{Z}[\pi_1]$ -module. The right hand vertical map may also be constructed as induced by the map of Waldhausen categories

$$R^f(X) \rightarrow \text{Ch}_{\mathbb{Z}[\pi_1]}^f,$$

given by the relative equivariant chains of the cover corresponding to  $\pi_1(X)$ : define  $\tilde{Y}$  as the pullback of the universal cover along  $Y \rightarrow X \rightarrow B\pi_1$ , let  $\tilde{X}$  be the lift to  $\tilde{Y}$  of the subspace  $\tilde{X}$ , and take  $C_*(\tilde{Y}, \tilde{X})$  as a chain complex of  $\mathbb{Z}[\pi_1]$ -modules.

We may identify both terms in the left column using the generalized Barratt-Quillen-Priddy-Segal theorem:  $\Omega B(\bigsqcup_{n \geq 0} B(\Sigma_n \wr G)) \simeq QBG_+$  where  $QY_+ := \Omega^\infty \Sigma^\infty Y_+$ . If we then complete the top row one step to the right, and take the homotopy fibers (over 0) in the first two vertical directions, we obtain a commutative diagram with rows and columns fiber sequences

$$\begin{array}{ccccc}
 \Omega Q(B\pi_1/X) & \longrightarrow & \mathcal{F} & & \\
 \downarrow & & \downarrow & & \\
 QX_+ & \longrightarrow & A(X) & \longrightarrow & \text{Wh}^{\text{Diff}}(X) \\
 \downarrow & & \downarrow & & \\
 Q(B\pi_1)_+ & \longrightarrow & K(\mathbb{Z}[\pi_1]) & & 
 \end{array}$$

From the vertical fiber sequences, we get two long exact sequence of homotopy groups with a map between them. We may identify some of these homotopy groups with higher algebraic  $K$ -theory groups, and also use  $\pi_n(QY_+) \cong \pi_n^s(Y_+)$ , the  $i$ th (reduced) stable homotopy group of the pointed space  $Y_+$ . If we then add the cokernels of the horizontal maps, we get:

$$\begin{array}{ccccccc}
 \vdots & & \vdots & & \vdots & & \\
 \downarrow & & \downarrow & & \downarrow & & \\
 \pi_{n+1}^s(B\pi_1/X) & \longrightarrow & \pi_n(\mathcal{F}) & \longrightarrow & F_n(X) & \longrightarrow & 0 \\
 \downarrow & & \downarrow & & \downarrow & & \\
 0 \longrightarrow & \pi_n^s(X_+) & \longrightarrow & \pi_n(A(X)) & \longrightarrow & \pi_n(\text{Wh}^{\text{Diff}}(X)) & \longrightarrow 0 \\
 \downarrow & & \downarrow & & \downarrow & & \\
 \pi_n^s((B\pi_1)_+) & \longrightarrow & K_n(\mathbb{Z}[\pi_1]) & \longrightarrow & W_n(\pi_1) & \longrightarrow & 0 \\
 \downarrow & & \downarrow & & \downarrow & & \\
 \vdots & & \vdots & & \vdots & & 
 \end{array}$$

where we define

$$W_n(\pi_1) := \text{coker}(\pi_n^s((B\pi_1)_+) \rightarrow K_n(\mathbb{Z}[\pi_1]))$$

$$F_n(X) := \text{coker}(\pi_{n+1}^s(B\pi_1/X) \rightarrow \pi_n(\mathcal{F})).$$

Note that the left vertical column might not be *not* exact. By taking the long exact sequence of a short exact sequence of chain complexes,

we see whether or not this is the case depends on the injectivity of the left horizontal maps (one out of three is always injective).

### The $s$ -cobordism theorem

As the map  $QX_+ \rightarrow A(X)$  is a  $\pi_0$ -isomorphism, the first possibly non-trivial homotopy group  $\pi_n(\text{Wh}^{\text{Diff}}(X))$  is  $n = 1$ . Let  $K(\mathbb{Z}[\pi_1])_{\text{free}}$  be the subspace consisting of those path-component corresponding to the free modules in  $K_0(\mathbb{Z}[\pi_1])$ .

**Lemma 22.1.1.** *The maps  $QX_+ \rightarrow Q(B\pi_1)_+$  and  $A(X) \rightarrow K(\mathbb{Z}[\pi_1])_{\text{free}}$  are 2-connected, i.e. an isomorphism on  $\pi_n$  for  $n \leq 1$ , and surjection on  $\pi_2$ .*

*Proof.* The first claim follows from the easy fact that  $X \rightarrow B\pi_1$  is 2-connected, and  $Q$  preserving connectivity. Because  $\pi_n(QY_+) \cong \pi_n^s(Y_+)$ , this may be deduced from the *Atiyah-Hirzebruch spectral sequence* for the generalized homology theory  $\pi_*^s(-)$  applied to the pointed space  $Y_+$

$$E_{pq}^2 = H_p(Y; \pi_q^s) \Rightarrow \pi_{p+q}^s(Y_+)$$

with  $\pi_q^s$  the  $q$ th stable homotopy group of spheres (so the  $E^2$ -page consists of reduced homology groups). If we run these spectral sequence for both  $X$  and  $B\pi_1$ , the fact that  $X \rightarrow B\pi_1$  is 2-connected will imply that the map  $\pi_n^s(X_+) \rightarrow \pi_n^s(B\pi_1)$  is an isomorphism for  $n \leq 1$  and a surjection for  $n = 2$ , as desired.

The second claim follows from the fact that the map  $\pi_0: \prod_n \Omega^k(\bigvee_n S^k \wedge GX_+) \rightarrow \bigoplus_n \mathbb{Z}[\pi_1]^n$  is 1-connected (considering the target as a discrete space), and we then apply  $B$ , increasing connectivity by 1. Applied  $\Omega B(\bigsqcup_{n \geq 0} -)$  preserves connectivity. It may be regarded as a special case of Proposition 1.1 of [Wal78].  $\square$

We may compute that  $\pi_1^s(X_+) \cong \pi_1((B\pi_1)_+) \cong \pi_1^{\text{ab}} \oplus \mathbb{Z}/2\mathbb{Z}$  using the Atiyah-Hirzebruch spectral sequence (there is no differential into the  $\pi_1^{\text{ab}}$ -term because you can map out to  $H_1 \cong \pi_1^{\text{ab}}$ ), while  $\pi_2^s(B\pi_1/X)$  vanishes because the map  $X \rightarrow B\pi_1$  is 2-connected.

The conclusion is that for  $n = 1$  the diagram simplifies to

$$\begin{array}{ccccccc}
& & 0 & & 0 & & 0 \\
& & \downarrow & & \downarrow & & \downarrow \\
0 & \longrightarrow & \pi_2^s(B\pi_1/X) \cong 0 & \longrightarrow & \pi_1(\mathcal{F}) \cong 0 & \longrightarrow & F_1(X) \cong 0 \longrightarrow 0 \\
& & \downarrow 0 & & \downarrow & & \downarrow \\
0 & \longrightarrow & \pi_1^s(X_+) \cong \pi_1^{\text{ab}} \oplus \mathbb{Z}/2\mathbb{Z} & \longrightarrow & \pi_1(A(X)) & \longrightarrow & \pi_1(\text{Wh}^{\text{Diff}}(X)) \longrightarrow 0 \\
& & \downarrow \cong & & \downarrow \cong & & \downarrow \cong \\
0 & \longrightarrow & \pi_1^s((B\pi_1)_+) \cong \pi_1^{\text{ab}} \oplus \mathbb{Z}/2\mathbb{Z} & \longrightarrow & K_1(\mathbb{Z}[\pi_1]) & \longrightarrow & W_1(\pi_1) \longrightarrow 0 \\
& & \downarrow & & \downarrow & & \downarrow \\
& & 0 & & 0 & & 0
\end{array}$$

Let us use this to reprove the  $s$ -cobordism theorem.

**Corollary 22.1.2.** *Let  $X$  be a closed smooth manifold of dimension  $n$ . Then we have that  $\pi_0(H(X)) \cong \pi_1(\text{Wh}^{\text{Diff}}(X)) \cong \text{Wh}_1(\mathbb{Z}[\pi_1])$  if  $n \geq 6$ .*

*Proof.* The identification  $\pi_0(\mathcal{H}(X)) \cong \pi_1(\text{Wh}^{\text{Diff}}(X))$  uses the combination of Igusa and Waldhausen's theorems (with improved range). It remains to identify

$$W_1(\pi) := \text{coker} \left( \pi_1^{\text{ab}} \oplus \mathbb{Z}/2\mathbb{Z} \rightarrow K_1(\mathbb{Z}[\pi]) \right)$$

with  $\text{Wh}_1(\pi_1)$ , but this is easy once one notes that  $[g] \in \pi_1^{\text{ab}}$  goes to the image of the  $(1 \times 1)$ -matrix in  $K_1(\mathbb{Z}[\pi_1])$  and the non-trivial element of  $\mathbb{Z}/2\mathbb{Z}$  goes to  $-1$ . Identifying the map with the inclusion of  $(1 \times 1)$ -matrices, we thus get exactly the  $\pm g$  in our original definition of  $\text{Wh}_1(\pi_1)$ .  $\square$

## 22.2 The Hatcher-Wagoner-Igusa sequence

Next we consider  $n = 2$ . In that case we can use the computations of the previous section to write

$$\begin{array}{ccccccc}
& & \vdots & & \vdots & & \vdots \\
& & \downarrow & & \downarrow & & \downarrow \\
& & \pi_3^s(B\pi_1/X) & \longrightarrow & \pi_2(\mathcal{F}) & \longrightarrow & F_2(X) \longrightarrow 0 \\
& & \downarrow & & \downarrow & & \downarrow \\
0 & \longrightarrow & \pi_2^s(X_+) & \longrightarrow & \pi_2(A(X)) & \longrightarrow & \pi_2(\text{Wh}^{\text{Diff}}(X)) \longrightarrow 0 \\
& & \downarrow & & \downarrow & & \downarrow \\
& & \pi_2^s((B\pi_1)_+) & \longrightarrow & K_2(\mathbb{Z}[\pi_1]) & \longrightarrow & W_2(\pi_1) \longrightarrow 0 \\
& & \downarrow & & \downarrow & & \downarrow \\
& & 0 & & 0 & & 0
\end{array}$$

We shall just take  $\text{Wh}_2(\pi_1)$  to be  $W_2(\pi_1)$ :

**Definition 22.2.1.** We set  $\text{Wh}_2(\pi_1) := \text{coker}(\pi_2^s((B\pi_1)_+) \rightarrow K_2(\mathbb{Z}[\pi_1]))$ .

It remains to do the following computations:

- (a) identify  $\pi_2(\mathcal{F})$ ,
- (b) identify  $\pi_3^s(B\pi_1/X)$  and show the map  $\pi_3^s(B\pi_1/X) \rightarrow \pi_2(\mathcal{F})$  is injective,
- (c) show the image of  $K_3(\mathbb{Z}[\pi_1]) \rightarrow \pi_2(\mathcal{F})$  contains a particular element,
- (d) show that the map  $\pi_2^s((B\pi_1)_+) \rightarrow K_2(\mathbb{Z}[\pi_1])$  is injective.

We start with (a).

**Lemma 22.2.3.** *We have that  $\pi_2(\mathcal{F}) \cong H_0(\pi_1; (\pi_2 \oplus \mathbb{Z}/2\mathbb{Z})[\pi_1])$ .*

*Proof.* By the group completion theorem, in the commutative diagram

$$\begin{array}{ccc} \text{colim}_{n \rightarrow \infty} BGL_n(\Sigma_+^\infty GX) & \longrightarrow & A(X) \\ \downarrow & & \downarrow \\ \text{colim}_{n \rightarrow \infty} BGL_n(\mathbb{Z}[\pi_1]) & \longrightarrow & K(\mathbb{Z}[\pi_1])_{\text{free}} \end{array}$$

the vertical maps have the same relative homology (when restricting the right hand side to a path component). Since the right map is 2-connected, its relative  $\pi_3$  (which is  $\pi_2$  of the homotopy fiber  $\mathcal{F}$ ) equals its relative  $H_3$  by the Hurewicz theorem and the fact that the spaces involved are simple, so  $\pi_1$  acts trivially on higher homotopy groups.

We may compute relative  $H_3$  using the left hand side, obtaining an isomorphism

$$\pi_2(\mathcal{F}) \cong \text{colim}_{n \rightarrow \infty} H_3(BGL_n(\Sigma_+^\infty GX), BGL_n(\mathbb{Z}[\pi_1])).$$

This may in turn be computed by a relative Serre sequence for the vertical maps in

$$\begin{array}{ccc} BGL_n(\Sigma_+^\infty GX) & \longrightarrow & BGL_n(\mathbb{Z}[\pi_1]) \\ \downarrow & & \downarrow \text{id} \\ BGL_n(\mathbb{Z}[\pi_1]) & \xrightarrow{\text{id}} & BGL_n(\mathbb{Z}[\pi_1]) \end{array}$$

From now on we suppress the colimit as  $n \rightarrow \infty$  from the notation (this is harmless as a consequence of homological stability). The left map is obtained by applying  $B$  to the map

$$GL_n(\Sigma_+^\infty GX) \rightarrow GL_n(\mathbb{Z}[\pi_1]).$$

The fiber of this map over all components of  $GL_n(\mathbb{Z}[\pi_1])$  are weakly equivalent, since all components of  $QGX_+$ , and may identified this

**Remark 22.2.2.** This is enough to obtain an interesting result, as we shall later see that  $\text{Wh}_2(\mathbb{Z}/2\mathbb{Z}) \cong \mathbb{Z}/2\mathbb{Z}$ .

with  $\prod_{n^2} Q_0GX_+$ . The action here is given by  $GL_n(\mathbb{Z}[\pi_1])$  is given by conjugation, upon writing this as  $M_n(Q_0GX_+)$ . Thus we obtain the spectral sequence

$$\begin{array}{c} E_{pq}^2 = H_p(BGL_n(\mathbb{Z}[\pi_1]); H_q(*, BM_n(Q_0GX_+))) \cong \\ H_p(BGL_n(\mathbb{Z}[\pi_1]); H_{q-1}(BM_n(Q_0GX_+))) \\ \Downarrow \\ H_{p+q}(BGL_n(\Sigma_+^\infty GX), BGL_n(\mathbb{Z}[\pi_1])). \end{array}$$

Thus we see that the only non-trivial contribution to  $H_3$  is

$$\begin{aligned} H_0(GL_n(\mathbb{Z}[\pi_1]); H_2(BM_n(Q_0GX_+))) &\cong H_0(GL_n(\mathbb{Z}[\pi_1]); \pi_1(M_n(Q_0GX_+))) \\ &\cong H_0(GL_n(\mathbb{Z}[\pi_1]); M_n(\pi_1^s(GX_+))). \end{aligned}$$

The trace  $\text{tr}: M_n(\pi_1^s(GX_+)) \rightarrow \pi_1^s(GX_+)$  does not factor over the  $GL_n(\mathbb{Z}[\pi_1])$ -coinvariants, but it does when we take the quotient of the latter by  $g \cdot a \cdot g^{-1} - a$  for  $g \in \pi_1$  and  $a \in \pi_1^s(GX_+)$  (think about the case  $n = 1$ ). In fact, it is a matter of elementary linear algebra that after taking this quotient, the trace induces an isomorphism, see Lemma 22.2.4. So the only contribution to relative  $H_3$  is  $H_0(\pi_1, \pi_1^s(GX_+))$ , where the action of  $g$  is by  $g: a \mapsto g \cdot a \cdot g$ .

Let us finally compute  $\pi_1^s(GX_+)$  using the Atiyah-Hirzebruch spectral sequence to be  $\bigoplus_{\gamma \in \pi_1} H_1(GX_\gamma) \oplus \bigoplus_{\gamma \in \pi_1} \mathbb{Z}/2\mathbb{Z}$ . Using  $H_1(GX_\gamma) \cong \pi_2$ , we may identify by translation with  $(\pi_2 \oplus \mathbb{Z}/2\mathbb{Z})[\pi_1]$  and compute  $\pi_2(\mathcal{F})$  as  $H_0(\pi_1; (\pi_2 \oplus \mathbb{Z}/2\mathbb{Z})[\pi_1])$ .  $\square$

**Lemma 22.2.4.** *For  $A$  a  $\mathbb{Z}[G]$ -module, we have that the trace induces an isomorphism  $H_0(GL_n(\mathbb{Z}[G]); M_n(A)) \rightarrow H_0(G; A)$ , where the action of  $GL_n(\mathbb{Z}[G])$  is by conjugation.*

*Proof.* Every element of  $M_n(A)$  is a sum of  $a_{ij}\delta_{ij}$ . Since conjugation can interchange basis vectors, we have that  $ae_{ii} \sim ae_{11}$ , and conjugation by a diagonal matrix with first diagonal entry  $g$  and the remainder are 1's gives  $ae_{11} \sim g \cdot g^{-1}e_{11}$ .

Similarly every  $ae_{ij}$  for  $i \neq j$  is equivalent to  $ae_{12}$  and conjugating with

$$\begin{bmatrix} 1 & 0 & & \\ & 1 & & \\ & & \ddots & \\ & & & \text{id}_{n-2} \end{bmatrix}$$

shows that  $ae_{12}$  is equivalent to  $-ae_{11} - ae_{21} + ae_{22} + ae_{12}$ , which is in turn equivalent to 0.  $\square$

**Remark 22.2.5.** We basically proved Proposition 1.2 of [Wal78], once one remarks that the quotient of  $\pi_1^s(GX_+)$  by  $g \cdot a - a \cdot g$  is  $\text{HH}_0(\mathbb{Z}[\pi_1], \pi_1^s(GX_+))$ , with HH denoting Hochschild homology.

The computation of  $\pi_3^s(B\pi_1/X)$  is easier, (b).

**Lemma 22.2.6.** *We have that  $\pi_3^s(B\pi_1/X) \cong H_0(\pi_1; \pi_2[1])$ , thinking of  $1 \in \pi_1$ .*

*Proof.* We have that

$$\pi_3^s(B\pi_1/X) \cong H_3(B\pi_1/X) \cong \pi_3(B\pi_1, X)/\pi_1 \cong H_0(\pi_1, \pi_2(X)).$$

The identification as a subset  $H_0(\pi_1; (\pi_2 \oplus \mathbb{Z}/2\mathbb{Z})[\pi_1])$  follows by identifying  $QBX_+ \rightarrow A(X)$  with the inclusion  $(1 \times 1)$ -matrices.  $\square$

We will not prove (c) and (d), as this gets too much into the details for a lecture, as both are proven by naturality and particular computations. For (c), the claim is that  $H_0(\pi_1; \mathbb{Z}/2\mathbb{Z}[1])$  is in the image of  $K_3(\mathbb{Z}[\pi_1]) \rightarrow \pi_2(\mathcal{F})$ . This follows by naturality using  $* \rightarrow X \rightarrow *$ , and a computation in the case  $* = X$ . For (d), one proves the case  $\pi_1 = \mathbb{Z}/2\mathbb{Z}$  first. See pages 250–252 of [Jah10].

**Definition 22.2.7.** We define  $\text{Wh}_1^+(\pi_1, \mathbb{Z}/2\mathbb{Z} \oplus \pi_2)$  as

$$\begin{aligned} \text{Wh}_1^+(\pi_1, \mathbb{Z}/2\mathbb{Z} \oplus \pi_2) &:= F_2(X) \\ &\cong H_0(\pi_1; (\pi_2 \oplus \mathbb{Z}/2\mathbb{Z})[\pi_1]) / H_0(\pi_1; (\pi_2 \oplus \mathbb{Z}/2\mathbb{Z})[\pi_1]). \end{aligned}$$

So our diagram becomes

$$\begin{array}{ccccccc} \pi_3^s((B\pi_1)_+) & \longrightarrow & K_3(\mathbb{Z}[\pi_1]) & \longrightarrow & W_3(\pi_1) & \longrightarrow & 0 \\ \downarrow & & \downarrow (*) & & \downarrow & & \\ 0 \longrightarrow & H_0(\pi_1; \pi_2[1]) & \longrightarrow & H_0(\pi_1; (\pi_2 \oplus \mathbb{Z}/2\mathbb{Z})[\pi_1]) & \longrightarrow & F_2(X) & \longrightarrow 0 \\ \downarrow & & \downarrow & & \downarrow & & \\ 0 \longrightarrow & \pi_2^s(X_+) & \longrightarrow & \pi_2(A(X)) & \longrightarrow & \pi_2(\text{Wh}^{\text{Diff}}(X)) & \longrightarrow 0 \\ \downarrow & & \downarrow & & \downarrow & & \\ 0 \longrightarrow & \pi_2^s((B\pi_1)_+) & \longrightarrow & K_2(\mathbb{Z}[\pi_1]) & \longrightarrow & \text{Wh}_2(\pi_1) & \longrightarrow 0 \\ \downarrow & & \downarrow & & \downarrow & & \\ & 0 & & 0 & & 0 & \end{array}$$

where  $(*)$  hits at least  $H_0(\pi_1; \mathbb{Z}/2\mathbb{Z}[1])$ . So using that we have a short exact sequence of chain complexes in a range, and applying the Igusa-Waldhausen theorems identifying  $\pi_1(H(X))$  with  $\pi_0(\mathcal{C}(X))$  for  $X$  a manifold of dimension  $\geq 7$ , we recover a result of Hatcher-Wagoner [HW73] with corrections by Igusa [Igu84]:

**Theorem 22.2.8.** *If  $n \geq 7$  we have an exact sequence:*

$$K_3(\mathbb{Z}[\pi_1]) \rightarrow \text{Wh}_1^+(\pi_1, \mathbb{Z}/2\mathbb{Z} \oplus \pi_2) \rightarrow \pi_1(H(X)) \cong \pi_0(\mathcal{C}(X)) \rightarrow \text{Wh}_2(\pi_1) \rightarrow 0. \quad (22.1)$$





## Isotopy classes of diffeomorphisms of disks

Having proven the Hatcher-Wagoner-Igusa sequence, we apply it to isotopy classes of diffeomorphisms of disks. Takeaways:

- $\pi_0(\mathcal{C}(M))$  vanishes if  $M$  is simply-connected of dimension  $\geq 7$  (in fact  $n \geq 5$ ).
- If an element of  $\pi_0(\text{Diff}^+(S^n))$  is in the kernel of the map to  $\Theta_{n+1}$ , it is pseudo-isotopic to the identity. Using the above, this means it is isotopic to the identity as long as  $n \geq 5$ .
- $\Theta_{n+1}$  is a finite abelian group for  $n \geq 5$ .

### 23.1 Pseudoisotopy implies isotopy

Recall that a diffeomorphism  $f$  of closed  $M$  is isotopic to the identity if there is diffeomorphism  $f_t: M \times [0, 1] \rightarrow M \times [0, 1]$  commuting with the projection to  $[0, 1]$ , such that  $f_0 = \text{id}$  and  $f_1 = f$ . The notion of pseudo-isotopy drops the condition that  $f_t$  commutes with the projection.

**Definition 23.1.1.** A diffeomorphism  $f$  of closed  $M$  is *pseudo-isotopic* to  $g$  if there is diffeomorphism  $F: M \times [0, 1] \rightarrow M \times [0, 1]$  such that  $F(M \times \{i\}) = M \times \{i\}$  for  $i = 0, 1$ ,  $F|_{M \times \{0\}} = \text{id}$  and  $F|_{M \times \{1\}} = g$ .

The following was first proven by Cerf, who also improved the range to  $n \geq 5$ , [Cer70].

**Lemma 23.1.2.** *If  $M$  is simply-connected of dimension  $n \geq 7$ , then  $\pi_0(\mathcal{C}(M)) = 0$ .*

*Proof.* Using the Hatcher-Wagoner-Igusa sequence, this reduces to algebra. It is clear from the definition that the  $\text{Wh}_1^+$ -term  $H_0(\pi_1, (\pi_2 \oplus \mathbb{Z}/2\mathbb{Z})[\pi_1]) / H_0(\pi_1, (\pi_2 \oplus \mathbb{Z}/2\mathbb{Z})[1])$  vanishes with  $\pi_1$  is trivial, as we take a quotient of a group by itself. For  $\text{Wh}_2(*)$ , we need to explain how to compute the map

$$\pi_2^s(*_+) \cong K_2(\text{FinSet}_*) \rightarrow K_2(\mathbb{Z}).$$

This is done by a Postnikov tower argument applied to the  $K$ -theory spaces. First, we kill  $\pi_0$  by picking a component. We may compute  $K_2$  by killing  $\pi_1$  and computing  $H_2$ . On the level of groups, killing  $\pi_1$  amounts to passing to the maximal perfect subgroup  $G_n$  of  $\Sigma_n$ , resp.  $\mathrm{GL}_n(\mathbb{Z})$ . These are given by  $A_n$  and  $\mathrm{SL}_n(\mathbb{Z})$  for  $n$  as  $n \rightarrow \infty$ .

We thus need to compute both groups and the map

$$H_2(BA_n) \rightarrow H_2(B\mathrm{SL}_n(\mathbb{Z}))$$

as  $n \rightarrow \infty$ . They are isomorphisms by Lemma 23.1.3.  $\square$

We'll compute the map on  $K_2$  using central extensions, see Section III.5.3 of [Wei13] or the notes [Pra15].

**Lemma 23.1.3.** *For  $n \gg 0$ , we have that  $\mathbb{Z}/2\mathbb{Z} \cong H_2(BA_n) \rightarrow H_2(B\mathrm{SL}_n(\mathbb{Z})) \cong \mathbb{Z}/2\mathbb{Z}$  is an isomorphism.*

*Proof.* The  $H_2$  of a perfect group  $G_n$  is related to the universal central extension  $\tilde{G}_n$  of  $G_n$  by the following short exact sequence

$$1 \rightarrow H_2(G_n) \rightarrow \tilde{G}_n \rightarrow G_n \rightarrow 1$$

of groups, where  $\tilde{G}_n$  has the property that each projective complex representation of  $G_n$  lifts uniquely to  $\tilde{G}_n$  or equivalently has the property that it has a unique map to every other central extension (the existence of this universal extension requires the perfectness, see Lemma III.5.3.2 of [Wei13]).

In particular, we may attempt to construct an approximation to  $\tilde{G}_n$  by mapping to a group which we know has a central extension taking the pull back. For example, we have the map  $A_n \rightarrow \mathrm{SO}_n(\mathbb{R})$  by acting on the permutation representation. The group  $\mathrm{SO}_n(\mathbb{R})$  has a  $\mathbb{Z}/2\mathbb{Z}$  central extension  $\mathrm{Spin}_n(\mathbb{R})$ , and it is a fact that the pullback of this to  $A_n$  is the universal central extension  $\tilde{A}_n$ . In particular, there is an isomorphism

$$\mathbb{Z}/2\mathbb{Z} \cong H_2(BA_n) \rightarrow H_2(B\mathrm{SO}_n(\mathbb{R})) \cong \mathbb{Z}/2\mathbb{Z}.$$

Firstly, one computes  $H_2(BA_n) \cong \mathbb{Z}/2\mathbb{Z}$  by using the identification with  $\pi_2^s(*_+)$  and computing this using stable homotopy theory<sup>1</sup>. Secondly, one shows that the map is surjective by using the construction of  $\mathrm{Spin}_n(\mathbb{R})$  to show that the pullback to  $A_n$  is a non-trivial central extension.

Since the map  $A_n \rightarrow \mathrm{SO}_n(\mathbb{R})$  factors over  $\mathrm{SL}_n(\mathbb{Z})$ , we conclude that  $H_2(BA_n) \rightarrow H_2(B\mathrm{SL}_n(\mathbb{Z}))$  is injective. But it is also true that  $H_2(B\mathrm{SL}_n(\mathbb{Z})) \cong \mathbb{Z}/2\mathbb{Z}$ , see e.g. Section III.5 of [Wei13], so it has to be an isomorphism. I do not know a non-involved proof of this; the standard one uses Steinberg symbols.  $\square$

**Remark 23.1.4.** We thus compute  $K_2(\mathbb{Z}) \cong \mathbb{Z}/2\mathbb{Z}$ , as listed in Table 20.2.

**Remark 23.1.5.** One should think of this proof of this lemma as studying the composition

$$K(\mathrm{FinSet}_*) \rightarrow K(\mathbb{Z}) \rightarrow K(\mathbb{R}^{\mathrm{top}}) = ko.$$

Alternatively, given presentations, we could in principle have proven  $H_2(A_n) \rightarrow H_2(\mathrm{SL}_n(\mathbb{Z}))$  is an isomorphism using Hopf's formula without resorting to topological  $K$ -theory.

<sup>1</sup> Using the Pontryagin-Thom theorem, one may also use framed manifolds or framed immersions, see e.g. [?]

Let us explicitly state the consequences in turns of pseudo-isotopies.

**Corollary 23.1.6.** *If  $M$  is simply-connected of dimension  $m \geq 5$ , then  $f$  is pseudo-isotopic to  $g$  if and only if  $f$  is isotopic  $g$ .*

*Proof.* The direction  $\Leftarrow$  is obvious, so let us prove  $\Rightarrow$ . If  $F: M \times I \rightarrow M \times I$  is a pseudo-isotopy from  $f$  to  $g$ , then  $F' := (f \times \text{id}_I)^{-1} \circ F$  is a pseudo-isotopy from  $f^{-1} \circ g$  to  $\text{id}$ . This is exactly an element of  $\mathcal{C}(M)$ . But  $\pi_0(\mathcal{C}(M)) = 0$  under the assumptions of the corollary, so there is a path  $F'_t$  of concordance diffeomorphisms from  $F'$  to  $\text{id}_{M \times I}$ . It we restrict  $F'_t$  to  $M \times \{1\}$ , we obtain an isotopy from  $F'_0|_{M \times \{1\}} = f^{-1}g$  to  $F'_1|_{M \times \{1\}} = \text{id}_M$ . Composing with  $f$ , we obtain an isotopy from  $g$  to  $f$ .  $\square$

## 23.2 Application to diffeomorphisms of disks

### The group of homotopy spheres

Before, we defined the set  $\Theta_{n+1}$  as the set of oriented homotopy  $(n+1)$ -spheres up to orientation-preserving diffeomorphism or equivalently (when  $n \geq 4$ ) up to  $h$ -cobordism.<sup>2</sup> We showed before that connected sums of path-connected oriented manifolds is well-defined up to diffeomorphism, so this induces an abelian monoid structure on  $\Theta_{n+1}$ .

<sup>2</sup> One of the big open questions of 4-manifold topology (that is, when  $n = 3$ ) is whether  $D^4$  admits a unique smooth structure.

**Lemma 23.2.1.** *If  $n \geq 4$ ,  $\Theta_{n+1}$  is an abelian group.*

*Proof.* Take  $\Sigma \times I$  and removed a neighborhood of  $* \times I$ . The result is a  $(n+2)$ -dimensional manifold whose boundary is diffeomorphic to  $\Sigma \# \bar{\Sigma}$ , where  $\bar{\Sigma}$  denotes  $\Sigma$  with opposite orientation. Removing a little disk from a point in its interior gives an  $h$ -cobordism from  $S^{n+1}$  to  $\Sigma \# \bar{\Sigma}$ , so the inverse of  $\Sigma$  is  $\bar{\Sigma}$ .  $\square$

Given a  $f \in \text{Diff}^+(S^n)$ , we get  $S_f^{n+1}$  be the homotopy sphere obtained by using  $f$  as an attaching map

$$S_f^{n+1} := D^{n+1} \cup_f D^{n+1}.$$

**Lemma 23.2.2.** *The map  $\pi_0(\text{Diff}_\partial(D^n)) \rightarrow \Theta_{n+1}$  given by  $[f] \mapsto S_f^{n+1}$  is a homomorphism.*

*Proof.* Let  $f, g \in \text{Diff}_\partial(D^n)$ . If we take the connected sum along the equator away from the support of the diffeomorphisms, the clutching function for  $S_f^{n+1} \# S_g^{n+1}$  is obtained by juxtaposing  $f$  and  $g$ . By an Eckmann-Hilton argument juxtaposition induces the same operation on  $\pi_0$  as composition.  $\square$

This means that to show  $\pi_0(\text{Diff}_\partial(D^n)) \rightarrow \Theta_{n+1}$  is injective, it suffices to show its kernel is trivial.

**Proposition 23.2.3.** *For  $f \in \text{Diff}^+(S^n)$ , the homotopy sphere  $S_f^{n+1}$  is diffeomorphic to  $S^{n+1}$  if and only if  $f$  is pseudo-isotopic to the identity.*

*Proof.* For  $\Leftarrow$ , a pseudoisotopy  $F$  from  $f$  to the identity may be used to construct a diffeomorphism  $S_f^{n+1} \rightarrow S^{n+1}$  by inserting  $F$  on the cylinder between a little disk around the origin in the first  $D^{n+1}$ , and the second  $D^{n+1}$ :

$$g: S_f^{n+1} \cong D^{n+1} \cup_f D^{n+1} \rightarrow S^{n+1}$$

$$x \mapsto \begin{cases} x & \text{if } x \in D_{1/2}^{n+1} \subset \text{first } D^{n+1}, \\ F(2r - 1, \theta) & \text{if } x = (r, \theta) \in \text{first } D^{n+1} \text{ and } r > 1/2, \\ x & \text{if } x \in \text{second } D^{n+1}. \end{cases}$$

For  $\Rightarrow$ , suppose we are given a diffeomorphism  $g: S_f^{n+1} \rightarrow S^{n+1}$ . We shall get a bit more control on it, and the pseudo-isotopy will appear. Firstly, without loss of generality  $g$  is orientation-preserving. Both  $S_f^{n+1}$  and  $S^{n+1}$  come with embeddings of  $D^{n+1} \sqcup D^{n+1}$ ; the first a small disk around the origin in the first  $D^{n+1}$ , the second equal to the second  $D^{n+1}$ . Consider the composition

$$D^{n+1} \sqcup D^{n+1} \hookrightarrow S_f^{n+1} \rightarrow S^{n+1}$$

whose isotopy class is given by an element of  $\pi_0$  of the configuration space of two points in  $S^{n+1}$  with labels in the oriented frame bundle of  $TS^{n+1}$ . This is path-connected, so we may find an isotopy to the standard inclusion  $D^{n+1} \sqcup D^{n+1} \hookrightarrow S^{n+1}$ , and by isotopy extension we may assume that the following diagram commutes

$$\begin{array}{ccc} & D^{n+1} \sqcup D^{n+1} & \\ \swarrow & & \searrow \\ S_f^{n+1} & \xrightarrow{g} & S^{n+1} \end{array}$$

Thus  $g$  may be interpreted as a diffeomorphism  $\bar{g}: S^n \times I \rightarrow S^n \times I$  which coincides with the identity on  $S^n \times \{0\}$  and  $f^{-1}$  on  $S^n \times \{1\}$ . Compose  $f \times \text{id}_I$  to get the desired pseudo-isotopy  $F$ .  $\square$

We obtain the following for  $n \geq 7$  (but let's state it with the improved  $n \geq 5$  range due to Cerf):

**Theorem 23.2.4.** *If  $n \geq 5$ , the surjective map*

$$\pi_0(\text{Diff}_\partial(D^n)) \rightarrow \Theta_{n+1}$$

*is also injective. That is,  $\pi_0(\text{Diff}_\partial(D^n)) \cong \Theta_{n+1}$ .*

*Proof.* If  $[f] \in \pi_0(\text{Diff}_\partial(D^n)) \cong \pi_0(\text{Diff}^+(S^n))$  is in the kernel of  $\pi_0(\text{Diff}_\partial(D^n)) \rightarrow \Theta_{n+1}$ , it is pseudo-isotopic to the identity by Proposition 23.2.3 and hence isotopic to the identity Corollary 23.1.6. Thus  $[f]$  is equal to the identity element of  $\pi_0(\text{Diff}^+(S^n)) \cong \pi_0(\text{Diff}_\partial(D^n))$ .  $\square$

### 23.3 Facts about $\Theta_{n+1}$

Kervaire and Milnor studied  $\Theta_{n+1}$  in detail [KM63]. Firstly, they showed that every homotopy  $(n+1)$ -sphere admits a stable framing, though not necessarily uniquely so. We will give the proof in the easy cases. The remaining cases use results of Rokhlin and Adams on the  $J$ -homomorphism.

**Lemma 23.3.1.** *For  $n+1 \equiv 0, 3, 4, 5, 6, 7 \pmod{8}$ , every homotopy  $(n+1)$ -sphere admits a stable framing.*

*Proof.* The stable tangent bundle is classified by an element  $\tau$  of  $\pi_{n+1}(BSO)$ . This group vanishes if  $n \equiv 3, 5, 6, 7 \pmod{8}$ . It is  $\mathbb{Z}$  if  $n \equiv 0, 4 \pmod{8}$ . In that case the homotopy group correspond rationally to a dual of  $p_{(n+1)/4}$ . In particular  $\tau \neq 4$  implies that the  $\langle p_{(n+1)/4}(T\Sigma), [\Sigma] \rangle \neq 0$ . All the lower degree Pontryagin classes have to vanish since they live in a zero cohomology group, so  $p_{(n+1)/4}(T\Sigma)$  is a non-zero rational multiple of the  $L$ -genus  $L_{(n+1)/4}(T\Sigma)$ . By the Hirzebruch signature theorem we have that  $\langle L_{(n+1)/4}(T\Sigma), [\Sigma] \rangle = \sigma(\Sigma)$ , which hence must also be non-zero. But the signature must be zero, as there is no cohomology in the relevant degrees. We conclude that  $\tau = 0$ .  $\square$

Thus, we may map an element  $\Sigma \in \Theta_{n+1}$  to the union  $p(\Sigma)$  over all its stable framings of the framed bordism class in the framed bordism group  $\Omega_{n+1}^{\text{fr}}$ . The group  $\Omega_{n+1}^{\text{fr}}$  may be identified with  $\pi_{n+1}^s$  by the Pontryagin-Thom theorem. This map becomes a well-defined group homomorphism if we quotient by  $p(S^{n+1})$ :  $\varphi: \Theta_{n+1} \rightarrow \pi_{n+1}^s/p(S^{n+1})$ . Its kernel  $\text{bP}^{n+2} := \ker(\varphi)$  consists of those homotopy  $(n+1)$ -spheres which admit a stable framing such that they bound a some stable framed manifold. We trivially get a short exact sequence

$$0 \rightarrow \text{bP}^{n+2} \rightarrow \Theta_{n+1} \rightarrow \Theta_{n+1}/\text{bP}^{n+2} \rightarrow 0$$

where the right term is finite since it is a subset of the finite group  $\pi_{n+1}^s/p(S^{n+1})$ .

What is the advantage of  $\text{bP}^{n+2}$ ? Any embedded sphere in the bounding manifold  $B$  for  $\Sigma \in \text{bP}^{n+2}$  will have trivial normal bundle, so is suitable for surgery. This allows one to simplify the bounding

manifold. If we can reduce it to a contractible manifold, we can use the  $h$ -cobordism theorem to show that  $\Sigma \cong S^{n+1}$ . When  $B$  is of odd dimension —  $n$  is even — there is no obstruction to making  $B$  contractible. When  $B$  is even dimension —  $n = 2k + 1$  is odd — there is an obstruction and you only make  $B$   $k$ -connected. However, Kervaire and Milnor were able to show that the obstruction group is finite, so that we can conclude:

**Theorem 23.3.2** (Kervaire-Milnor).  $\Theta_{n+1}$  is finite if  $n \geq 5$ .

**Corollary 23.3.3.** If  $n \geq 5$ , the group  $\pi_0(\text{Diff}_\partial(D^n))$  is finite abelian.

24

*The results of Kervaire-Milnor*





## The Hatcher spectral sequence and the Farrell-Hsiang theorem

Last lecture we finished the proof that  $\pi_0(\text{Diff}_\partial(D^n)) \cong \Theta_{n+1}$  for  $n \geq 5$ . We will use this to compute  $\pi_*(\text{Diff}_\partial(D^n)) \otimes \mathbb{Q}$ , a result originally due to Farrell and Hsiang. Instead of the original proof, we shall give one using the Hatcher spectral sequence. Our references are [FH78, Hat78].

### 25.1 Concordance diffeomorphisms of $D^n$ , rationally

Recall that the topological group  $\mathcal{C}(M)$  of concordance diffeomorphisms is given by those diffeomorphisms of  $M \times I$  that fix  $\sqcup(M) := M \times \{0\} \cup \partial M \times I$  pointwise.

Let us specialize to  $M = D^n$ . Restricting a concordance diffeomorphism of  $D^n$  to the upper boundary  $D^n \times \{1\}$ , gives the fiber sequence

$$\text{Diff}_\partial(D^{n+1}) \rightarrow \mathcal{C}(D^n) \rightarrow \text{Diff}_\partial(D^n). \quad (25.1)$$

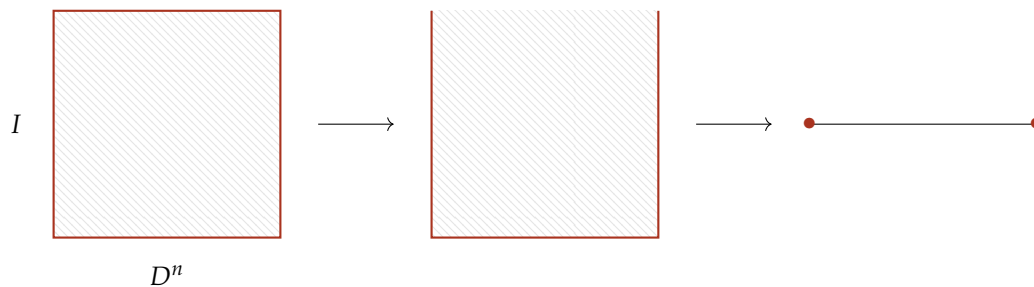

If our eventual goal is to compute  $\pi_*(\text{Diff}_\partial(D^n)) \otimes \mathbb{Q}$ , it is thus a good idea to compute  $\pi_*(\mathcal{C}(D^n)) \otimes \mathbb{Q}$  first. Using (25.1), this will serve as a reality check for Theorem 25.4.2.

Let us compute  $\pi_*(\mathcal{C}(D^n)) \otimes \mathbb{Q}$ . The Igusa-Waldhausen theorems imply that there is an isomorphism<sup>1</sup>

Takeaways:

- Rationally,  $A(*)$  is weakly equivalent to  $K(\mathbb{Z})$ .
- There is a spectral sequence computing  $\pi_*(B\text{Diff}_\partial(D^n)) \otimes \mathbb{Q}$  in terms of  $\pi_*(\mathcal{C}(D^n \times I^k))$  with  $d^1$ -differential involving an involution corresponding to flipping the  $h$ -cobordism.
- Using this, we show that in a range  $\pi_*(B\text{Diff}_\partial(D^n)) \otimes \mathbb{Q}$  vanishes when  $n$  is even, and is given by  $K_{*+1}(\mathbb{Z}) \otimes \mathbb{Q}$  when  $n$  is odd.

<sup>1</sup> Note that  $\mathcal{C}(D^n)$  is both a topological group and an  $E_n$ -algebra, so its homotopy groups are abelian when  $n \geq 1$ .

$$\pi_*(\mathcal{C}(D^n)) \otimes \mathbb{Q} \cong \pi_{*+2}(\mathrm{Wh}^{\mathrm{Diff}}(D^n)) \otimes \mathbb{Q} \quad (25.2)$$

for  $* \leq \min(\frac{n-7}{3}, \frac{n-9}{2})$  (called the *concordance stable range*).<sup>2</sup> We may replace  $\mathrm{Wh}^{\mathrm{Diff}}(D^n)$  with  $\mathrm{Wh}^{\mathrm{Diff}}(*)$ , as the Kan loop group  $G_X$  only depends on the weak homotopy type of  $X$  and thus  $\mathrm{Wh}^{\mathrm{Diff}}(-)$  is a weak homotopy invariant on path-connected spaces. One may also compare the Waldhausen categories  $\mathcal{R}^f(-)$ , by applying the covariant functoriality by taking pushouts to maps mutually inverse up to weak equivalence. This proof also works for spaces  $X$  that are not path-connected, see Proposition 2.1.7 of [Wal85].

<sup>2</sup> This range may be improved using Morlet’s disjunction theorem, see e.g. [RW15].

To compute the right hand side, we recall from the Waldhausen splitting theorem, here Theorem 21.2.9, stated in terms of spectra

$$\underline{A}(*) \simeq \mathbb{S} \times \underline{\mathrm{Wh}}^{\mathrm{Diff}}(*).$$

We also recall the fact that  $\mathbb{S} \rightarrow \underline{A}(*)$  is a  $\pi_0$ -isomorphism. It is well-known that  $\pi_*(\mathbb{S}) \otimes \mathbb{Q} \cong 0$  unless  $* = 0$ , so that to compute  $\pi_{*+2}(\underline{\mathrm{Wh}}^{\mathrm{Diff}}(*)) \otimes \mathbb{Q}$ , it suffices to compute  $\pi_*(\underline{A}(*)) \otimes \mathbb{Q}$  and discard the  $\mathbb{Q}$  in degree 0.

Let  $M_n(QS^0)_{\mathrm{id}}$  denote the component of  $\mathrm{GL}_n(\mathbb{S})$  corresponding to the identity matrix. By construction, there is fiber sequence

$$M_n(QS^0)_{\mathrm{id}} \rightarrow \mathrm{GL}_n(\mathbb{S}) \rightarrow \mathrm{GL}_n(\mathbb{Z}),$$

with fiber taking over the identity in  $\mathrm{GL}_n(\mathbb{Z})$ .

Since all components of  $QS^0$  are weakly equivalent, this is weakly equivalent to an  $n^2$ -fold product of  $Q_0S^0$ . Since  $Q_0S^0$  is rationally weakly contractible, so is  $M_n(QS^0)_{\mathrm{id}}$ . Thus, when we take a disjoint union over  $n \geq 0$  and apply  $\Omega B$  we obtain a rational weak equivalence

$$\begin{array}{ccc} \Omega B(\bigsqcup_{n \geq 0} B\mathrm{GL}_n(\mathbb{S})) & \xrightarrow{\simeq} & A(*) \\ \simeq_{\mathbb{Q}} \downarrow & & \downarrow \\ \Omega B(\bigsqcup_{n \geq 0} B\mathrm{GL}_n(\mathbb{Z})) & \xrightarrow{\simeq} & K(\mathbb{Z}). \end{array}$$

This discussion is summarized by the following rational computation of  $\mathrm{Wh}^{\mathrm{Diff}}(*)$ :

**Proposition 25.1.2.** *There is an isomorphism*

$$\pi_*(\mathrm{Wh}^{\mathrm{Diff}}(*)) \otimes \mathbb{Q} \cong \begin{cases} 0 & \text{if } * = 0 \\ K_*(\mathbb{Z}) \otimes \mathbb{Q} & \text{otherwise.} \end{cases}$$

**Remark 25.1.3.** The rational algebraic  $K$ -theory groups of  $\mathbb{Z}$  appearing in Proposition 25.1.2 were computed by Borel using analysis on the Borel-Serre compactification of  $\mathrm{SL}_n(\mathbb{Z}) \backslash \mathrm{SL}_n(\mathbb{R}) / \mathrm{O}_n(\mathbb{R})$ . In the end, he reduced it to a computation Lie algebra cohomology, whose result is as follows [Bor74, Jan16]:<sup>3</sup>

**Remark 25.1.1.** This generalizes to a map  $A(B\pi_1) \rightarrow K(\mathbb{Z}[\pi_1])$  that is a rational isomorphism away from  $\pi_0$ , as in general this map need not be surjective on  $\pi_0$  (it only hits the path components corresponding to finitely generated free modules).

<sup>3</sup> In previous chapters, we have already computed or stated  $K_0(\mathbb{Z}) \cong \mathbb{Z}$ ,  $K_1(\mathbb{Z}) \cong \mathbb{Z}/2\mathbb{Z}$ ,  $K_2(\mathbb{Z}) \cong \mathbb{Z}/2\mathbb{Z}$ , which is consistent with Borel’s computation. See also Table 20.2.

$$K_*(\mathbb{Z}) \otimes \mathbb{Q} \cong \begin{cases} \mathbb{Q} & \text{if } * = 0 \text{ or } * \geq 5 \text{ satisfies } * \equiv 1 \pmod{4} \\ 0 & \text{otherwise.} \end{cases}$$

## 25.2 Block diffeomorphisms

To get at  $\text{Diff}_\partial(D^n)$  instead of  $\mathcal{C}(D^n)$ , we use a different approach. This uses the simplicial group of block diffeomorphisms:

**Definition 25.2.1.** Let  $M$  be a smooth manifold, then the *block diffeomorphisms*  $\text{Diff}_\partial^b(M)$  is the simplicial group with  $k$ -simplices given by the set of diffeomorphisms  $f: M \times \Delta^k \rightarrow M \times \Delta^k$  such that (i) for each face  $\sigma \subset \Delta^k$  we have  $f(M \times \sigma) = M \times \sigma$ , and (ii)  $f$  fixes  $\partial M \times \Delta^k$  pointwise.

**Example 25.2.2.** We have that  $\pi_0(\text{Diff}_\partial^b(M))$  equals the set of pseudo-isotopy classes of diffeomorphisms of  $M$  rel boundary.

This simplicial group is built to be more easily studied by the surgery-theoretic techniques. These techniques are developed to classify manifolds or isotopy classes of diffeomorphisms, and block diffeomorphisms can be studied by these techniques because each of its homotopy groups may be identified with  $\pi_0$  of a different space. Let us explain this.

All simplicial groups are Kan, so an element of  $\pi_k(\text{Diff}_\partial^b(M))$  is represented by a diffeomorphism  $f: M \times \Delta^k \rightarrow M \times \Delta^k$  that is the identity on  $\partial M \times \Delta^k \cup M \times \partial \Delta^k$ , i.e. an element of  $\text{Diff}_\partial(M \times \Delta^k)$ . Two representatives  $f_0, f_1$  are equivalent if there is a diffeomorphism of  $M \times \Delta^k \times I$  that is face-preserving and the identity on all of the boundary except  $M \times \Delta^k \times \{0, 1\}$ , on which it is  $f_0$  and  $f_1$ . This is equivalent to  $f_0$  and  $f_1$  being pseudo-isotopic, and thus we have that

$$\pi_k(\text{Diff}_\partial^b(M)) \cong \pi_0(\text{Diff}_\partial^b(M \times \Delta^k)).$$

Recalling that the topological group  $\text{Diff}_\partial(M)$  was weakly equivalent to the simplicial group  $\text{SDiff}_\partial(M)$  with  $k$ -simplices given by the set of diffeomorphisms  $f: M \times \Delta^k \rightarrow M \times \Delta^k$  preserving the map to  $\Delta^k$  and fixing  $\partial M \times \Delta^k$  we obtain an inclusion

$$\text{SDiff}_\partial(M) \hookrightarrow \text{Diff}_\partial^b(M).$$

From now we will write  $\text{Diff}_\partial(M)$  instead of  $\text{SDiff}_\partial(M)$ , so as to make the notation more uniform.

Let us now restrict to  $M = D^n$  for  $n \geq 5$ . Then we see that

$$\pi_k(\text{Diff}_\partial^b(D^n)) \cong \pi_0(\text{Diff}_\partial^b(D^{n+k})) \cong \pi_0(\text{Diff}_\partial(D^{n+k})) \cong \Theta_{n+k+1},$$

the latter following from pseudoisotopy-implies-isotopy. Hence the homotopy groups of the block diffeomorphisms of  $D^n$  are finite by

Theorem 1.2 of Kervaire-Milnor [KM63], as long as  $n + k + 1 \geq 5$ .

We conclude from this that each path component of  $\text{Diff}_\partial^b(D^n)$  is rationally weakly contractible. Let us now consider the quotient  $\text{Diff}_\partial^b(D^n)/\text{Diff}_\partial(D^n)$ . Since  $\text{Diff}_\partial(D^n) \subset \text{Diff}_\partial^b(D^n)$ , the action is free and we have a fiber sequence

$$\text{Diff}_\partial(D^n) \rightarrow \text{Diff}_\partial^b(D^n) \rightarrow \text{Diff}_\partial^b(D^n)/\text{Diff}_\partial(D^n).$$

When  $n \geq 5$ , the middle term is rationally weakly contractible and the inclusion  $\text{Diff}_\partial(D^n) \hookrightarrow \text{Diff}_\partial^b(D^n)$  is a  $\pi_0$ -isomorphism. Hence we may conclude that the right term is a rational classifying space of the left term:

**Proposition 25.2.3.** *For  $n \geq 5$ , there is a rational weak equivalence*

$$B\text{Diff}_\partial(D^n) \simeq_{\mathbb{Q}} \text{Diff}_\partial^b(D^n)/\text{Diff}_\partial(D^n).$$

### 25.3 The Hatcher spectral sequence

We shall describe a spectral sequence due to Hatcher computing the homotopy groups  $\text{Diff}_\partial^b(M)/\text{Diff}_\partial(M)$  in terms of homotopy groups of  $\mathcal{C}(M \times I^k)$ , see Proposition 2.1 of [Hat78]. We then describe it in the concordance stable range.

#### *The construction of the spectral sequence*

To describe it, we need some new definitions.

**Definition 25.3.1.**  $D^k(M)$  is the quotient of the simplicial group of diffeomorphisms of  $M \times I^k \text{ rel } \partial M \times I^k$  which on  $M \times \partial I^k$  preserve the projection to  $I^k$ , by those diffeomorphisms preserving the projection to  $I^k$  everywhere.

**Remark 25.3.2.** Written out in symbols, we might denote  $D^k(M)$  by

$$\text{Diff}_\partial(M \times I^k \text{ over } \partial I^k) / \Omega^k \text{Diff}_\partial(M).$$

Using the  $D^k(M)$  we may provide a filtration of the homotopy groups of  $\text{Diff}_\partial^b(M)/\text{Diff}_\partial(M)$ . To do this, we use that there is a map  $\pi_{i+j}(D^k(M)) \rightarrow \pi_i(D^{k+j}(M))$  by interpreting a  $I^{i+j}$ -indexed family of diffeomorphism of  $M \times I^k$  as an  $I^i$ -indexed family of diffeomorphism of  $M \times I^{k+j}$ . There is also a map  $\pi_0(D^k(M)) \rightarrow \pi_k(\text{Diff}_\partial^b(M)/\text{Diff}_\partial(M))$ . We define the ascending filtration of  $\pi_k(\text{Diff}_\partial^b(M)/\text{Diff}_\partial(M))$  as the image of the vertical maps in

$$\begin{array}{ccccccc}
 0 & \longrightarrow & \pi_k(D^0(M)) & \longrightarrow & \pi_{k-1}(D^1(M)) & \longrightarrow & \cdots & \longrightarrow & \pi_0(D^k(M)) \\
 & & & \searrow & \searrow & & \downarrow & & \swarrow \\
 & & & & & & \pi_k(\text{Diff}_\partial^b(M)/\text{Diff}_\partial(M)) & & \\
 & & & & & & & & (25.3)
 \end{array}$$

We claim this is the  $E_\infty$ -page of the spectral sequence associated to an exact couple.

**Remark 25.3.3.** Let us recall how one checks this is the case. With our grading convention, an *exact couple* is a pair of bigraded abelian groups  $D^{*,*}$  and  $E^{*,*}$  with morphisms  $i, j, k$  of various bidegrees:

$$\begin{array}{ccc} D^{i,k} & \xrightarrow[\text{(-1,1)}]{i} & D^{i-1,k+1} \\ & \swarrow \text{(0,0)} \text{ } k \text{ (dashed)} & \searrow \text{(0,-1)} \text{ } j \\ & & E^{i-1,k} \end{array}$$

with the dashed line indicating that the target is a different bidegree (it should really map to  $D^{i-1,k}$ ). We require that this diagram is exact, i.e.  $\ker(j) = \text{im}(i)$ , etc.

We may then note that  $d := j \circ k$  maps  $E^{*,*}$  into a chain complex and take homology to obtain a new exact couple  $(E')^{*,*} = H(E^{*,*})$ ,  $(D')^{*,*} = \text{id}(i)$ ,  $i' = i|_{D'}$ , and  $j', k'$  defined appropriately (see page 38 of [McCo1]). Iterating this, and calling  $E^{*,*} E_{*,*,r}^1$ ,  $(E')^{*,*} E_{*,*,r}^2$ , etc., we obtain a spectral sequence. It is a priori unclear whether it converges to something. There are two natural conditions for the target:  $D^{-\infty} = \text{colim}_i D^{*,*}$  or  $D^\infty = \text{lim}_i D^{*,*}$ , with natural increasing filtration  $F_k D^\infty = \text{im}(D^{*,k} \rightarrow D^{-\infty})$  and decreasing filtration  $F^k D^{-\infty} = \ker(D^\infty \rightarrow D^{*,k})$  respectively.

In the case that in the diagram  $\dots \rightarrow D^{*+1,k-1} \rightarrow D^{*,k}$  vanishes for  $k \ll 0$ , the limit vanishes (as does a  $\lim^1$ -term, which one should always take into account when taking limits of abelian groups). Thus in this case  $D^{-\infty}$  is the natural candidate. General convergence results of Boardman [?] (see also pages 76–78 of [McCo1]) imply that the spectral sequence indeed converges when there are at most finitely many differential into or out of a given entry.

**Definition 25.3.4.**  $\mathcal{C}^k(M)$  is the quotient of the simplicial group of the diffeomorphisms  $M \times I^k \times I \text{ rel } \partial M \times I^k \times I$  which on  $M \times \square := M \times I^k \times \{0\} \cup M \times \partial I^k \times I$  preserve the projection to  $I^k \times I$ , by the subgroup preserving the projection to  $I^k \times I$  everywhere.

**Remark 25.3.5.** Written out in symbols, we might denote  $\mathcal{C}^k(M)$  by

$$\text{Diff}_\partial(M \times I^k \times I \text{ over } \square) / \Omega^{k+1} \text{Diff}_\partial(M).$$

Inclusion of concordance diffeomorphisms, which are the identity on  $M \times \square$ , gives a map  $\mathcal{C}(M \times I^k) \rightarrow \mathcal{C}^k(M)$ .

**Lemma 25.3.6.** *The map  $\mathcal{C}(M \times I^k) \rightarrow \mathcal{C}^k(M)$  is a weak equivalence.*

*Proof.* Using a smooth retraction  $r: I^k \times I \rightarrow \sqcup$ , we may construct a map  $\rho$  from  $\mathcal{C}^k(M)$  to the group of diffeomorphisms of  $M \times I^k \times I$  preserving the projection to  $I^k \times I$  everywhere:

$$\rho(f): (m, t) \mapsto (\pi_1 \circ f(m, r(t)), t).$$

This shows  $\mathcal{C}^k(M)$  is isomorphic to the quotient of  $\mathcal{C}(M \times I^k)$  by the intersection  $\mathcal{C}(M \times I^k)$  with the subgroup of diffeomorphisms of  $M \times I^k \times I$  preserving the projection to  $I^k \times I$ . But this subgroup is weakly contractible, by “pushing the non-trivial part out through the upper boundary.”  $\square$

Restricting elements of  $\mathcal{C}^k(M)$  to  $M \times I^k \times \{1\}$  induces a fiber sequence

$$D^{k+1}(M) \rightarrow \mathcal{C}^k(M) \rightarrow D^k(M),$$

and the long exact sequences of homotopy groups of these fiber sequences assemble into collection of groups:

$$\begin{array}{ccc} \pi_i(D^k(M)) & \xrightarrow{i} & \pi_{i-1}(D^{k+1}(M)) \\ & \swarrow k \quad \nwarrow j & \\ & \pi_i(\mathcal{C}^k(M)) & \end{array}$$

where the map  $i$  is indeed the map  $\pi_i(D^k(M)) \rightarrow \pi_{i-1}(D^{k+1}(M))$  described before. This is almost an exact couple, except that it is not exact at  $\pi_0(D^k)$ . To fix this, we make the following definition

$$D^{i,k} := \begin{cases} \pi_i(D^k(M)) & \text{if } i \geq 0 \\ \pi_{k+i}(\text{Diff}_\partial^b(M)/\text{Diff}_\partial(M)) & \text{if } i < 0 \end{cases}$$

$$E^{i,k} := \begin{cases} \pi_i(\mathcal{C}^k(M)) & \text{if } i \geq 0 \\ 0 & \text{otherwise,} \end{cases}$$

with the obvious extension of  $i, j$  and  $k$ : in particular, the extension of  $i$  to  $D^{0,k} \rightarrow D^{-1,k+1}$  is the map  $\pi_0(D^k(M)) \rightarrow \pi_k(\text{Diff}_\partial^b(M)/\text{Diff}_\partial(M))$  is induced by inclusion. To check exactness of this couple, we only need to remark two things. Firstly, each  $\pi_k(\text{Diff}_\partial^b(M)/\text{Diff}_\partial(M))$  is represented by an element of  $\pi_k(\text{Diff}_\partial^b(M)) \cong \pi_0(\text{Diff}_\partial^b(M \times I^k))$ , and so may be hit by an element of  $\pi_0(D^k(M))$ . Secondly, the kernel of  $\pi_0(D^{k+1}(M)) \rightarrow \pi_k(\text{Diff}_\partial^b(M)/\text{Diff}_\partial(M))$  consists of elements represented by  $f$  such that there is a diffeomorphism of  $M \times I^k \times I$  that equals  $f$  on  $M \times I^k \times \{1\}$ , i.e. if  $f$  in the image of  $\pi_0(\mathcal{C}^k(M))$  under  $j$ .

In this case  $D^\infty$  and  $\lim_i^1 D^{*,*}$  vanish, while  $D^{-\infty}$  is isomorphic to  $\pi_*(\text{Diff}_\partial^b(M)/\text{Diff}_\partial(M))$ . The induced filtration on  $D^{-\infty}$  is exactly the one from (25.3). We thus get a spectral sequence which converges since it is first quadrant. The  $E^1$ -page is  $E^{i,k} \cong \pi_i(\mathcal{C}^k(M)) \cong$

$\pi_i(\mathcal{C}(M \times I^k))$ . By construction the  $d^1$ -differential is the map  $k \circ j$ . This is easily seen to be given by the map

$$d^1: \pi_q(\mathcal{C}(M \times I^p)) \rightarrow \pi_q(\mathcal{C}(M \times I^{p-1}))$$

given by restriction to the upper boundary  $M \times I^p \times \{1\}$ .

The conclusion is the following, called the *Hatcher spectral sequence*, see Section 2 of [Hat78]:

**Proposition 25.3.7** (Hatcher). *There is a spectral sequence*

$$E_{pq}^1 = \pi_q(\mathcal{C}(M \times I^p)) \Rightarrow \pi_{p+q+1}(\text{Diff}_\partial^b(M)/\text{Diff}_\partial(M)),$$

which  $d^1$ -differential given by restriction to the upper boundary.

### The differential

The homotopy groups of  $\mathcal{C}(M)$  have at least two additions (three if  $n \geq 1$ ). The first comes from the group structure and the second is concatenation (a third one is ordinary addition on homotopy groups):

$$f * g: (m, t) \mapsto \begin{cases} f(m, 2t) & \text{if } t \leq 1/2 \\ g(m, 2t - 1) \circ f(m, 1) & \text{if } t > 1/2. \end{cases}$$

They are equal by an Eckmann-Hilton argument.

If  $f \in \mathcal{C}(M \times I^p)$  is in the image of the stabilization map  $\sigma: \mathcal{C}(M \times I^{p-1}) \rightarrow \mathcal{C}(M \times I^p)$  i.e.  $f = \sigma(g)$ , then we see in Figure 25.1 that

$$d^1([f]) = d^1(\sigma_*[g]) = [g * \bar{g}] = [g] + [\bar{g}].$$

Here  $\bar{g}$  is given by applying to  $g$  the involution on  $\mathcal{C}(N)$  (with  $N = M \times I^{p-1}$ ) given by

$$g \mapsto \bar{g} := (g|_{N \times \{1\}} \times \text{id}_I)^{-1} \circ g \circ (\text{id}_N \times \tau),$$

where  $\tau(t) = 1 - t$  (this is easier on  $\mathcal{C}^0(M)$ , where it simply is flipping). Intuitively, on the level of moduli spaces of  $h$ -cobordisms this amounts to switching the direction of the  $h$ -cobordism.

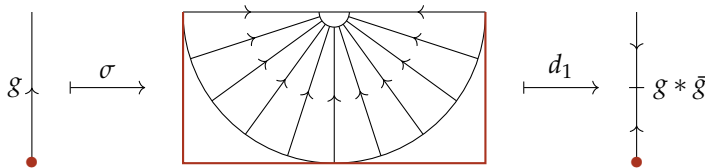

Figure 25.1: The stabilization map on concordance diffeomorphisms composed by restriction to the upper boundary.

**Lemma 25.3.8.** *We have that  $[\sigma(g)] = -\sigma_*[\bar{g}]$ .*

*Proof.* One uses  $\mathcal{C}^0(M)$  instead. Then Figure 25.2 repeats the argument-by-picture given by Hatcher. The left homotopy is given by bending straight, ending up in the subgroup of diffeomorphisms preserving the projection to  $I$  (the final factor in  $M \times I \times I$  in the definition of  $\mathcal{C}^0(M \times I)$ ). The right homotopy is given by noting that this is a concatenation of two elements, homotopic to respectively  $\sigma(g)$  and  $\overline{\sigma(g)}$  as we have adding a part that preserving the projection to  $I$ .  $\square$

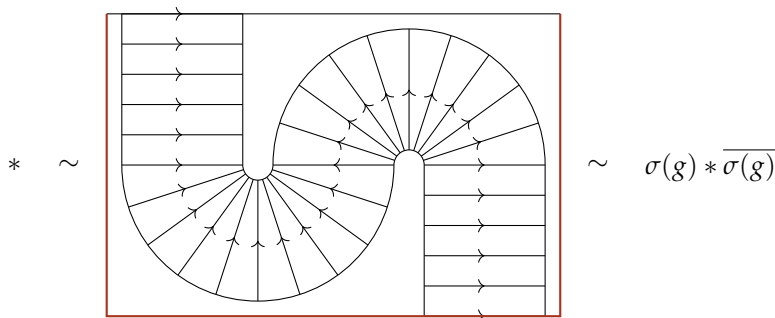

Figure 25.2: The picture proof of Lemma 25.3.8. This is happening in  $\mathcal{C}^0(M)$ , otherwise we'd have to be the identity at the bottom.

#### 25.4 The Farrell-Hsiang theorem

Let us now specialize this to  $M = D^n$  and work rationally. Using Proposition 25.2.3, we then obtain a spectral sequence

$$E_{pq}^1 = \pi_q(\mathcal{C}(D^n \times I^p)) \otimes \mathbb{Q} \Rightarrow \pi_{p+q+1}(B\text{Diff}_0(D^n)) \otimes \mathbb{Q}.$$

For  $q$  in the concordance stable range, i.e. below a horizontal line in the spectral sequence, we can identify each column as  $\pi_q(\mathcal{C}(D^n)) \otimes \mathbb{Q} \cong K_{q+2}(\mathbb{Z}) \otimes \mathbb{Q}$  by (25.2) and Proposition 25.1.2.

To understand  $d^1$  in this range, it remains to determine the involution on these homotopy groups. Farrell and Hsiang computed the action of the involution is on  $K_i(\mathbb{Z}) \otimes \mathbb{Q}$  (here it is dualization, on  $\text{GL}_n(\mathbb{Z})$  given by transpose inverse).

**Lemma 25.4.1.** *The involution on  $K_i(\mathbb{Z}) \otimes \mathbb{Q}$  acts by  $-1$ , except for  $i = 0$  when it is given by the identity.*

It turns out that the involution on  $K_i(\mathbb{Z}) \otimes \mathbb{Q}$  equals the involution on  $\pi_{i-2}(\mathcal{C}(D^n)) \otimes \mathbb{Q}$  up to a sign  $(-1)^{n+1}$  (indeed from Lemma 25.3.8 we know the involution changes by a sign depending when we stabilize).

We conclude that on the  $E^1$ -page the 0th column is a  $(+1)$ -eigenspace if  $n$  is even and a  $(-1)$ -eigenspace when  $n$  is odd. After that the columns alternate, by Lemma 25.3.8. From this, we see that the  $d^1$ -differential is alternatively an isomorphism or 0. On the one hand,



when  $n$  is even we have that the first differential  $d^1: E_{1q} \rightarrow E_{0q}$  is given by

$$d^1(\sigma_*[f]) = [f] + [\bar{f}] = [f] - (-1)^{n+1}[f] = [f] + [f] = 2[f],$$

so all columns cancel pairwise. On the other hand, when  $n$  is odd, the first  $d^1$ -differential is 0 and all columns *except the 0th column* cancel pairwise. See Figure 25.3.

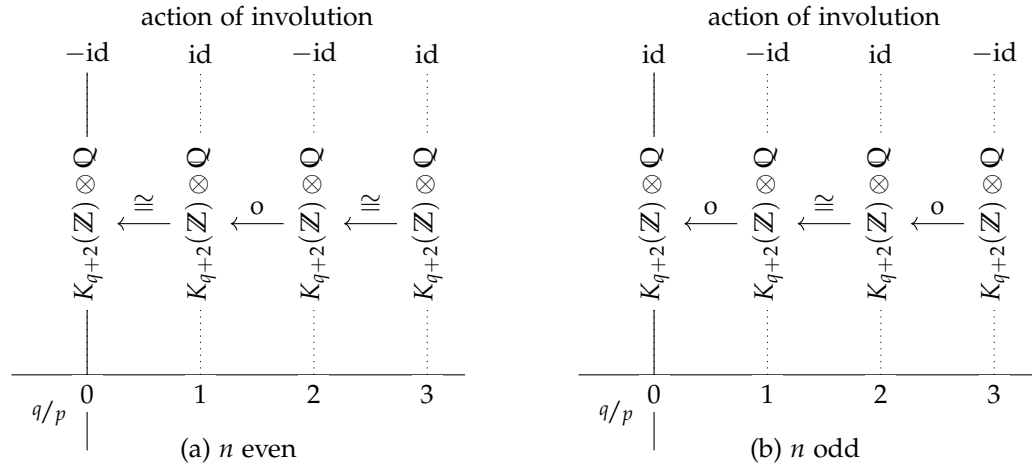

Figure 25.3: The  $E^1$ -page of the spectral sequences converging to  $\pi_{p+q+1}(B\text{Diff}_\partial(D^n)) \otimes \mathbb{Q}$ , with  $q$  in the concordance stable range.

**Theorem 25.4.2** (Farrell-Hsiang). *In the concordance stable range, we have that*

$$\pi_*(B\text{Diff}_\partial(D^n)) \otimes \mathbb{Q} \cong \begin{cases} 0 & \text{if } n \text{ is even} \\ K_{*+1}(\mathbb{Z}) \otimes \mathbb{Q} & \text{if } n \text{ is odd.} \end{cases}$$

Note this computation is compatible with (25.1) and (25.2), as it should be. In particular, when  $n$  is odd we have that  $\pi_*(B\text{Diff}_\partial(D^n)) \otimes \mathbb{Q}$  is 0 except when  $* = 4i$  for  $i > 0$ , in which case it is  $\mathbb{Q}$ .

**Remark 25.4.3.** At the time of the proof in [FH78], the Waldhausen splitting theorem was not yet proven, so the computation of  $\text{Wh}^{\text{Diff}}(*)$  was a lot harder. They also discussed aspherical manifolds. The techniques were generalized by Burghela [Bur79].



**Part V**

**Topological manifolds and  
smoothing theory**



## Topological manifolds and handles

### 26.1 The theory of topological manifolds

The theory of topological manifolds is modeled on that of smooth manifolds, using the existence and manipulation of handles. Hence the final definitions, tools and theorems that we want for topological manifolds are similar to those of smooth manifolds.

To obtain this theory, we intend to bootstrap from smooth or PL manifolds, a feat that was first achieved by Kirby and Siebenmann [KS77, Essay IV]. They did this by understanding smooth and PL structures on (open subsets of) topological manifolds. To state the results of Kirby and Siebenmann, we define three equivalence relations on smooth structures on (open subsets of) a topological manifold  $M$ , which one should think of as an open subset of a larger topological manifold.

To give these equivalence relations, we have to explain how to pull back smooth structures along topological embeddings of codimension  $o$ . In this case a topological embedding is just a continuous map that is a homeomorphism onto its image, and a typical example is the inclusion of an open subset. If  $\Sigma$  is a smooth structure on  $M$  and  $\varphi: N \rightarrow M$  is a codimension  $o$  topological embedding, then  $\varphi^*\Sigma$  is the smooth structure given by the maximal atlas containing the maps  $\varphi^{-1} \circ \phi_i: \mathbb{R}^n \subset U_i \hookrightarrow \varphi(N) \rightarrow N$  for those charts  $\phi_i$  of  $\Sigma$  with  $\phi_i(U_i) \subset \varphi(N) \subset M$ . Note that if  $N$  and  $M$  were smooth,  $\varphi$  is smooth if and only if  $\varphi^*\Sigma_M = \Sigma_N$ .

**Definition 26.1.1.** Let  $M$  be a topological manifold.

- Two smooth structures  $\Sigma_0$  and  $\Sigma_1$  are said to be *concordant* if there is a smooth structure  $\Sigma$  on  $M \times I$  that near  $M \times \{i\}$  is a product  $\Sigma_i \times \mathbb{R}$ .
- $\Sigma_0$  and  $\Sigma_1$  are said to be *isotopic* if there is a (continuous) family of homeomorphisms  $\phi_t: [0, 1] \rightarrow \text{Homeo}(M)$  such that  $\phi_t = \text{id}$  and  $\phi_1^*\Sigma_0 = \Sigma_1$  (i.e. the atlases for  $\Sigma_0$  and  $\Sigma_1$  are compatible).
- $\Sigma_0$  and  $\Sigma_1$  are said to be *diffeomorphic* if there is a homeomorphism

$\phi: M \rightarrow M$  such that  $\phi^*\Sigma_0 = \Sigma_1$ .

**Remark 26.1.2.** By the existence of smooth collars,  $\Sigma_0$  and  $\Sigma_1$  are concordant if and only if there is a smooth structure  $\Sigma$  on  $M \times I$  so that  $\Sigma|_{M \times \{i\}} = \Sigma_i$ , where implicitly we are saying that the boundary of  $M$  is smooth.

Note that isotopy implies concordance and isotopy implies diffeomorphism. Kirby and Siebenmann proved the following foundational results about smooth structures:

- *concordance implies isotopy:* If  $\dim M \geq 6$ , then the map

$$\frac{\{\text{smooth structures on } M\}}{\text{isotopy}} \longrightarrow \frac{\{\text{smooth structures on } M\}}{\text{concordance}}$$

is a bijection. Hence also concordance implies diffeomorphism:

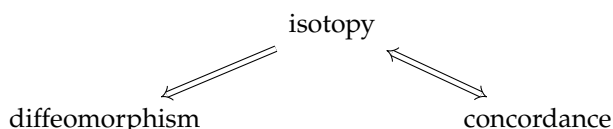

- *concordance extension:* Let  $M$  be a topological manifold of dimension  $\geq 6$  with a smooth structure  $\Sigma_0$  and  $U \subset M$  open. Then any concordance of smooth structures on  $U$  starting at  $\Sigma_0|_U$  can be extended to a concordance of smooth structures on  $M$  starting at  $\Sigma_0$ .
- the *product structure theorem:* If  $\dim M \geq 5$ , then taking the cartesian product with  $\mathbb{R}$  induces a bijection

$$\frac{\{\text{smooth structures on } M\}}{\text{concordance}} \xrightarrow{- \times \mathbb{R}} \frac{\{\text{smooth structures on } M \times \mathbb{R}\}}{\text{concordance}}$$

These theorems can be used to prove a classification theorem for smooth structures.

**Theorem 26.1.3** (Smoothing theory). *There is a bijection*

$$\frac{\{\text{smooth structures on } M\}}{\text{concordance}} \xrightarrow{\tau} \frac{\{\text{lifts of } TM: M \rightarrow B\text{Top to } BO\}}{\text{vertical homotopy}}$$

These techniques are used as follows: every point in a topological manifold has a neighborhood with a smooth structure. This means we can use all our smooth techniques locally. Difficulties arise when we want to move to the next chart. Using the above three theorems, it is sometimes possible to adapt the smooth structures so that we can transfer certain properties. We will do this for handlebody structures in this lecture and microbundle transversality in the next lecture. Perhaps the slogan to remember is a sentence in Kirby-Siebenmann (though we will replace “PL” by “smoothly”):

The intuitive idea is that ... the charts of a TOP manifolds ... are *as good as* PL compatible.

Let me try to somewhat elucidate one of harder parts of proving these results: it appears in the product structure theorem (which also happens to be the theorem we will use most in later lectures). The proof of this theorem is by induction over charts, and the hardest step is the initial case  $M = \mathbb{R}^n$ . We prove this by showing that for  $n \geq 6$ , both  $\mathbb{R}^n$  and  $\mathbb{R}^{n+1}$  have a unique smooth structure up to concordance; a map between two sets containing a single element is of course a bijection. To produce a concordance from any smooth structure of  $\mathbb{R}^n$  to the standard one, we will need both the *stable homeomorphism theorem* and *Kister's theorem*. Let us state these results.

**Definition 26.1.4.** A homeomorphism  $f: \mathbb{R}^n \rightarrow \mathbb{R}^n$  is *stable* if it is a finite composition of homeomorphisms that are identity on some open subset of  $\mathbb{R}^n$ .

**Remark 26.1.5.** Using the topological version of isotopy extension [EK71], one may prove that  $f$  is stable if and only if for all  $x \in \mathbb{R}^n$  there is an open neighborhood  $U$  of  $x$  such that  $f|_U$  is isotopic to a linear isomorphism.

The following is due to Kirby [?].

**Theorem 26.1.7** (Stable homeomorphism theorem). *If  $n \geq 6$ , then every orientation-preserving homeomorphism of  $\mathbb{R}^n$  is stable.*

**Lemma 26.1.8.** *A stable homeomorphism is isotopic to the identity.*

*Proof.* If a homeomorphism  $h$  is the identity near  $p \in \mathbb{R}^n$ , and  $\tau_p: \mathbb{R}^n \rightarrow \mathbb{R}^n$  denotes the translation homeomorphism  $x \mapsto x + p$ , then  $\tau_p^{-1}h\tau_p$  is the identity near 0. Thus the formula

$$[0, 1] \ni \tau \mapsto \tau_{\tau \cdot p}^{-1}h\tau_{\tau \cdot p}$$

gives an isotopy from  $h$  to a homeomorphism that is the identity near 0.

Next suppose we are given a stable homeomorphism  $h$ , which by definition we may write as  $h = h_1 \cdots h_k$  with each  $h_i$  a homeomorphism that is the identity on some open subset  $U_i$ . Then applying the above construction to each of the  $h_i$  using  $p_i \in U_i$ , shows that  $h$  is isotopic to a homeomorphism  $h'$  that is the identity near 0.

Finally, let  $\sigma_r: \mathbb{R}^n \rightarrow \mathbb{R}^n$  for  $r > 0$  denote the scaling homeomorphism given by  $x \mapsto rx$  then

$$[0, 1] \ni \tau \mapsto \begin{cases} \sigma_{1-\tau}^{-1}h'\sigma_{1-\tau} & \text{if } \tau \in [0, 1) \\ \text{id} & \text{if } \tau = 1 \end{cases}$$

**Remark 26.1.6.** In fact, the stable homeomorphism theorem is true in all dimensions. The case  $n = 0, 1$  are folklore,  $n = 2$  follows from work by Radó [Rad24],  $n = 3$  from work by Moise [Moi77], and the cases  $n = 4, 5$  are due to Quinn [?].

gives an isotopy from  $h'$  to the identity (note that for continuity in the compact open topology we require convergence on compacts).  $\square$

Thus the stable homeomorphism theorem implies that  $\text{Homeo}(\mathbb{R}^n)$  has two path components: one contains the identity, the other the orientation-reversing map  $(x_1, x_2, \dots, x_n) \mapsto (-x_1, x_2, \dots, x_n)$ . We will combine this with Kister's theorem [Kis64]. This result uses the definition of a topological embedding, which in this case — when the dimensions are equal — is just a continuous map that is a homeomorphism onto its image.

**Theorem 26.1.9** (Kister's theorem). *Every topological embedding  $\mathbb{R}^n \hookrightarrow \mathbb{R}^n$  is isotopic to a homeomorphism. In fact, the proof gives a canonical such isotopy, which depends continuously on the embedding.*

In the next section, we shall give a proof of this theorem. It is proven by what may be described impressionistically as a “convergent infinite sphere jiggling” procedure. Combining Kister's theorem with Theorem 26.1.7 and Lemma 26.1.8 we obtain:

**Corollary 26.1.10.** *If  $n \geq 6$ , every orientation-preserving topological embedding  $\mathbb{R}^n \hookrightarrow \mathbb{R}^n$  is isotopic to the identity.*

**Corollary 26.1.11.** *For  $n \geq 6$ , every smooth structure  $\Sigma$  on  $\mathbb{R}^n$  is concordant to the standard one.*

*Proof.* Any smooth chart for the smooth structure  $\Sigma$  can be used to obtain a smooth embedding  $\phi_0: \mathbb{R}_{\text{std}}^n \hookrightarrow \mathbb{R}_{\Sigma}^n$ , which without loss of generality we may assume to be orientation-preserving (otherwise precompose it with the map  $(x_1, x_2, \dots, x_n) \mapsto (-x_1, x_2, \dots, x_n)$ ). A smooth embedding is in particular a topological embedding and by Corollary 26.1.10, it is isotopic to the identity. Pulling back the smooth structure along this isotopy gives us a concordance of smooth structures starting at the standard one and ending at  $\Sigma$ .  $\square$

**Remark 26.1.12.** In particular, for  $n \geq 6$  there is a unique smooth structure on  $\mathbb{R}^n$  up to diffeomorphism, as concordance implies isotopy implies diffeomorphism. The smooth structure on  $\mathbb{R}^n$  is in fact unique in all dimension except 4. The stable homeomorphism theorem and Kister's theorem are true even in dimension 4, but concordance implies isotopy fails.

**Remark 26.1.13.** The proof of the stable homeomorphism theorem is beautiful, but has many prerequisites. It relies on both the smooth end theorem and the classification of PL homotopy tori using PL surgery theory [KS77, Appendix V.B] [?, Chapter 15A], and uses a so-called torus trick to construct a compactly-supported homeomorphism of  $\mathbb{R}^n$  agreeing with the original one on an open subset.



## 26.2 Existence of handle decompositions

As an application of the product structure theorem, we will prove that every topological manifold of dimension  $\geq 6$  admits a handle decomposition [KS77, Theorem III.2.1]. The definition of handle attachments and handle decompositions for topological manifolds are as in Definition ?? except  $\phi$  now only needs to be a topological embedding.

This definition involves topological manifolds with boundary, which are locally homeomorphic to  $[0, \infty) \times \mathbb{R}^{n-1}$  and the points which correspond to  $\{0\} \times \mathbb{R}^{n-1}$  form the boundary  $\partial M$  of  $M$ . A neighborhood of this boundary is a product.

**Definition 26.2.1.** A collar for  $\partial M$  in  $M$  is a map  $\partial M \times [0, \infty) \hookrightarrow M$  that is the identity on the boundary and a homeomorphism onto its image.

It is elementary that every topological manifold with boundary admits a collar, see e.g. [?]. Suppose one has a map  $e: M' \hookrightarrow M$  of a topological manifold with boundary  $M'$  into a topological manifold  $M$  of the same dimension that is a homeomorphism onto its image. Using a collar for  $M'$ , we may isotope the map  $e$  such that its boundary  $\partial M'$  has a bicollar in  $M$ , i.e. there is a map  $\partial M \times \mathbb{R} \hookrightarrow M$  that is the identity on  $\partial M \times \{0\}$  and is a homeomorphism onto its image. This isotopy is given by “pulling  $M$  back into its collar a bit.”

**Remark 26.2.2.** Not every map  $e: M' \hookrightarrow M$  as above admits a bicollar, e.g. the inclusion of the closure of one of the components of the complement of the Alexander horned sphere, see Remark 28.1.3.

**Theorem 26.2.3.** Every topological manifold  $M$  of dimension  $n \geq 6$  admits a handle decomposition.

*Proof.* Let us prove this in the case that  $M$  is compact. Then there exists a finite cover of  $M$  by closed subsets  $A_i$ , each of which is contained in an open subset  $U_i$  that can be given a smooth structure  $\Sigma_i$  (these do not have to be compatible). For example, one may obtain this by taking a finite subcover of the closed unit balls in charts.

By induction over  $i$  we construct a handlebody  $M_i \subset M$  whose interior contains  $\bigcup_{j \leq i} A_j$ , starting with  $M_{-1} = \emptyset$ . So let  $i \geq 0$  and suppose we have constructed  $M_{i-1}$ , then we will construct  $M_i$ . By the remarks preceding this theorem we assume that there exists a bicollar  $C_i$  of  $\partial(M_{i-1} \cap U_i)$  in  $U_i$ . In particular  $C_i$  is homeomorphic to  $\partial(M_{i-1} \cap U_i) \times \mathbb{R}$  and being an open subset of  $U_i$  with smooth structure  $\Sigma_i$ , admits a smooth structure. Thus we may apply the product structure theorem to  $\partial(M_{i-1} \cap U_i) \subset C_i$ , and modify the smooth structure on  $C_i$  by a concordance so that  $\partial(M_{i-1} \cap U_i)$  becomes a

smooth submanifold. By concordance extension we may then extend the concordance and resulting smooth structure to  $U_i$ . We can then use the relative version of the existence of handle decompositions for smooth manifolds to find a  $N_i \subset U_i$  obtained by attaching handles to  $M_{i-1} \cap U_i$ , which contains a neighborhood of  $A_i \cap U_i$ . Taking  $M_i := M_{i-1} \cup N_i$  completes the induction step.  $\square$

### 26.3 Remarks on low dimensions

What happens in dimensions  $n \leq 4$ ? The cases  $n \leq 3$  and  $n = 4$  are quite different. In dimensions  $n \leq 3$ , results of Radó and Moise say that every topological manifold admits a smooth structure unique up to isotopy [?]. Informally stated, topological manifolds are the same as smooth manifolds.

Dimension 4 is more complicated. A result of Freedman uses an infinite collapsing construction to show that an important tool of high dimensions, the *Whitney trick*, still works for topological 4-manifolds with relatively simple fundamental group [?]. This means that the higher-dimensional theory to a large extent applies to topological 4-manifolds [FQ90]. One important exception is that they may no longer admit a handle decomposition, though in practice one can work around this using the fact that a path-connected topological 4-manifold is smoothable in the complement of a point, see Section 8.2 of [FQ90].

In dimension 4, smooth manifolds behave differently. For example,  $n = 4$  is the only case in which  $\mathbb{R}^n$  admits more than one smooth structure up to diffeomorphism. In fact, it admits uncountably many. Furthermore, these can occur in families: in all dimensions  $\neq 4$  a submersion that is topologically a fiber bundle is smoothly a fiber bundle by the Kirby-Siebenmann bundle theorem [KS77, Essay II], but in dimension 4 there exists a smooth submersion  $E \rightarrow [0, 1]$  with  $E$  homeomorphic to  $\mathbb{R}^4 \times [0, 1]$  such that all fibers are non-diffeomorphic smooth structures on  $\mathbb{R}^4$  [?]. See also [?]. Hence the product structure theorem is false for 3-manifolds, as it also involves 4-manifolds. In particular, it predicts two smooth structures on  $S^3$ , but the now proven Poincaré conjecture says there is only one. However, it may not be the right intuition to think that there are different exotic smooth structures on a given manifold, but that many different smooth manifolds happen to be homeomorphic.

## *Kister's theorem and microbundles*

In this section we give a proof of Kister's theorem on topological self-embeddings of  $\mathbb{R}^n$ , which we use in two places: (i) to prove the initial case of the product structure theorem, and (ii) to prove Theorem 27.2.6 about the existence of  $\mathbb{R}^n$ -bundles in microbundles. The proof is rather elementary, and a close analogue plays an important role in the  $\varepsilon$ -Schoenflies theorem used in [EK71] to prove isotopy extension for locally flat submanifolds.

The goal is to compare the following two basic objects of manifold theory:

- (i) The topological groups

$$\{\text{CAT-isomorphisms } (\mathbb{R}^n, 0) \rightarrow (\mathbb{R}^n, 0)\}$$

with  $\text{CAT} = \text{Diff}$  or  $\text{Top}$ . In words, these are the diffeomorphisms, homeomorphisms and PL-homeomorphisms of  $\mathbb{R}^n$  fixing the origin. These are denoted  $\text{Diff}(n)$  and  $\text{Top}(n)$  respectively.

- (ii) The topological monoids

$$\{\text{CAT-embeddings } (\mathbb{R}^n, 0) \rightarrow (\mathbb{R}^n, 0)\}$$

with  $\text{CAT} = \text{Diff}$  or  $\text{Top}$ . In words, these are the self-embeddings of  $\mathbb{R}^n$  fixing the origin, either smooth or topological. There is no special notation for them, so we use  $\text{Emb}_0^{\text{CAT}}(\mathbb{R}^n, \mathbb{R}^n)$ .

**Remark 27.0.1.** We can include these spaces into the topological groups or monoids of CAT-isomorphisms or CAT-embeddings that do not necessarily fix the origin. A translation homotopy, i.e. deforming the embedding or isomorphism  $\phi$  through the family

$$[0, 1] \ni \tau \mapsto \phi - \tau \cdot \phi(0),$$

shows that these inclusions are homotopy equivalences.

The reason there is no special notation for the self-embeddings is the following theorem.

**Theorem 27.0.2.** *The inclusion*

$$\{\text{CAT-isomorphisms } (\mathbb{R}^n, 0) \rightarrow (\mathbb{R}^n, 0)\} \hookrightarrow \{\text{CAT-embeddings } (\mathbb{R}^n, 0) \rightarrow (\mathbb{R}^n, 0)\}$$

is a weak equivalence if CAT is Diff or Top.

In this section we prove this theorem, and the smooth case will serve as an explanation of the proof strategy for the topological case.

**Remark 27.0.3.** The PL version of Theorem 27.0.2 is also true [KL66].

### 27.1 Topological self-embeddings of $\mathbb{R}^n$

We next repeat the entire exercise in the topological setting. We want to show that the inclusion

$$\text{Top}(n) \hookrightarrow \text{Emb}_0^{\text{Top}}(\mathbb{R}^n, \mathbb{R}^n)$$

is a weak equivalence. As before it suffices to find a lift

$$\begin{array}{ccc} S^k & \longrightarrow & \text{Top}(n) \\ \downarrow & \nearrow^{g_s^{(2)}} & \downarrow \\ D^{k+1} & \xrightarrow{g_s} & \text{Emb}_0^{\text{Top}}(\mathbb{R}^n, \mathbb{R}^n) \end{array}$$

after homotoping the diagram. That is, we want to deform the family  $g_s, s \in D^{k+1}$  to homeomorphisms staying in homeomorphisms if we already are in homeomorphisms. Here it is helpful to remark that since a topological embedding is a homeomorphism onto its image, it is a homeomorphism if and only if it is surjective.

Our strategy is outlined by the following diagram:

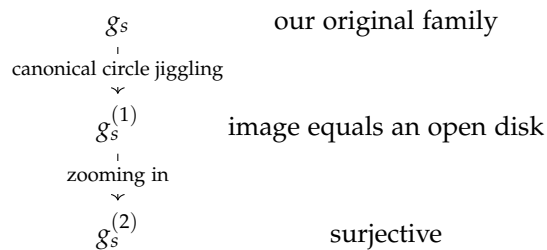

The important technical tool replacing Taylor approximation is the following “sphere jiggling” trick. Let  $D_r \subset \mathbb{R}^n$  denote the closed disk of radius  $r$  around the origin.

**Lemma 27.1.1.** *Fix  $a < b$  and  $c < d$  in  $(0, \infty)$ . Suppose we have  $f, h \in \text{Emb}_0^{\text{Top}}(\mathbb{R}^n, \mathbb{R}^n)$  with  $h(\mathbb{R}^n) \subset f(\mathbb{R}^n)$  and  $h(D_b) \subset f(D_c)$ . Then there exists an isotopy  $\phi_t$  of  $\mathbb{R}^n$  such that*

- (i)  $\phi_0 = \text{id}$ ,

(ii)  $\phi_1(h(D_b)) \supset f(D_c)$ ,

(iii)  $\phi_t$  fixes pointwise  $\mathbb{R}^n \setminus f(D_d)$  and  $h(D_a)$ .

This is continuous in  $f, h$  and  $a, b, c, d$ .

*Proof.* Since  $h(\mathbb{R}^n) \subset f(\mathbb{R}^n)$ , it suffices to work in  $f$ -coordinates. Our isotopy will be compactly supported in these coordinates, so we can extend by the identity to the complement of  $f(\mathbb{R}^n)$  in  $\mathbb{R}^n$ .

We will now define some subsets in  $f$ -coordinates and invite the reader to look at Figure 27.1. Let  $b'$  be the radius of the largest disk contained in  $h(D_b)$  (in  $f$ -coordinates, remember) and  $a'$  the radius of the largest disk contained in  $h(D_a)$ . Our first attempt for an isotopy is to make  $\phi_t$  piecewise-linearly scale the radii between  $a$  and  $d$  such that  $c$  moves to  $b'$ . This satisfies (i), (ii) and fixes  $\mathbb{R}^n \setminus f(D_d)$ . In words it “pulls  $h(D_b)$  over  $f(D_c)$ . It might not fix  $h(D_a)$ .”

This can be solved by a trick: we conjugate with a homeomorphism, described in  $h$ -coordinates as follows: piecewise-linearly radially scale between 0 and  $b$  by moving the radius  $a$  to radius  $a''$ , where  $a''$  is the radius of the largest disk contained in  $f(D_{a'})$ . In words, we temporarily decrease the size of  $h(D_a)$  to be contained in  $f(D_{a'})$ , do our previous isotopy, and restore  $h(D_a)$  to its original shape.

The continuity of this construction depends on the continuity of  $b', a'$  and  $a''$ , which we leave to the reader as an exercise in the compact-open topology.  $\square$

**Theorem 27.1.2.** *The inclusion*

$$\text{Top}(n) \hookrightarrow \text{Emb}_0^{\text{Top}}(\mathbb{R}^n, \mathbb{R}^n)$$

*is a weak equivalence.*

*Proof.* Following the strategy outlined before, we have two steps.

- (i) Our first step involves making the image of  $g_s$  into a (possibly infinite) open disk. Let  $R_s(r)$  be the piecewise linear function  $[0, \infty) \rightarrow [0, \infty)$  sending  $i \in \mathbb{N}_0$  to the radius of the largest disk contained in  $g_s(D_i)$ . Then we can construct an element of  $\text{Emb}_0^{\text{Top}}(\mathbb{R}^n, \mathbb{R}^n)$  given in radial coordinates by  $h_s(r, \varphi) = (R_s(r), \varphi)$ . This satisfies  $h_s(\mathbb{R}^n) \subset g_s(\mathbb{R}^n)$ ,  $h_s(D_i) \subset g_s(D_i)$  for all  $i \in \mathbb{N}_0$  and has image an open disk. It is continuous in  $s$ .

Our goal is to deform  $h_s$  to have the same image as  $g_s$  in infinitely many steps. For  $t \in [0, 1/2]$  we use the lemma to push  $h_s(D_1)$  to contain  $g_s(D_1)$  while fixing  $g_s(D_2)$ . For  $t \in [1/2, 3/4]$  we use the lemma to push the resulting image of  $h_s(D_2)$  to contain  $g_s(D_2)$  while fixing  $g_s(D_3)$  and the resulting image of  $h_s(D_1)$ , etc. These infinitely many steps converge to an embedding since on each

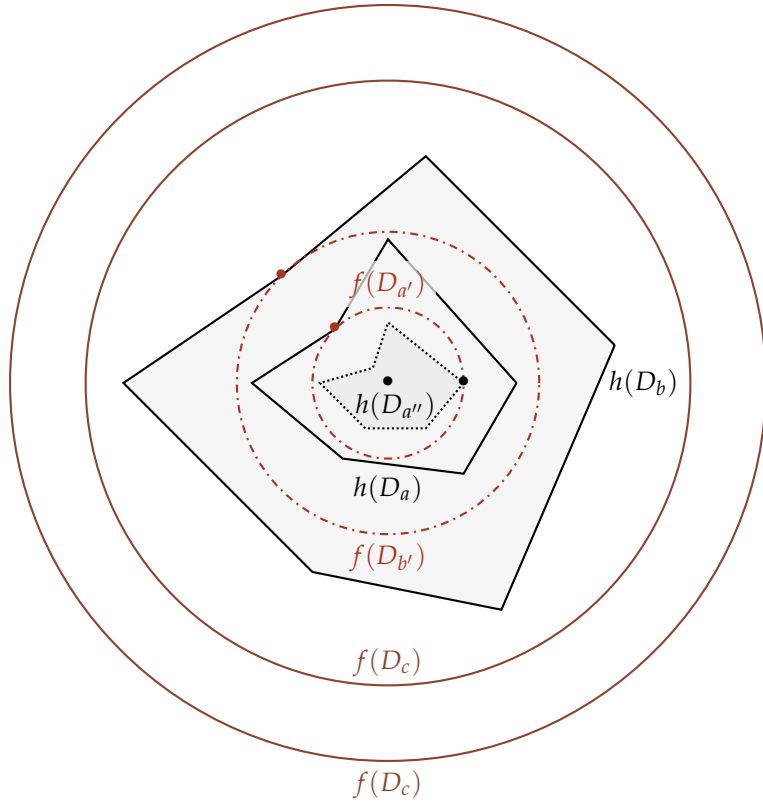

Figure 27.1: The disks appearing in Lemma 27.1.1. The dotted disks are derived from the marked intersection points.

compact only finitely many steps are not the identity. The result is a family  $H_s(-, t)$  in  $\text{Emb}_0^{\text{Top}}(\mathbb{R}^n, \mathbb{R}^n)$  such that  $H_s(-, 1)$  has the same image as  $g_s$ . It is continuous in  $s$  since  $h_s$  is. So step (i) does this:

$$G_s^{(1)}(x, t) := H_s(H_s(-, 1)^{-1}g_s(x), 1 - t)$$

For  $t = 0$ , this is simply  $g_s(x)$ . For  $t = 1$ , this is  $H_s(-, 1)^{-1}(g_s(x))$ , which we denote by  $g_s^{(1)}$  and has the same image as  $h_s(x)$ , i.e. a possibly infinite open disk. Note that if  $g_s$  were surjective, then so  $G_s^{(1)}(x, t)$  for all  $t$ .

- (ii) There is a piecewise-linear radial isotopy  $K_s$  moving  $h_s(x)$  to the identity. It is given by moving the values of  $R_s$  at each integer  $i$  to  $i$ . We set

$$G_s^{(2)}(x, t) := K_s(-, 1 - t)^{-1}g_s^{(1)}(x)$$

so that for  $t = 0$  we have get  $g_s^{(1)}$  and for  $t = 1$  we get  $g_s^{(2)}$  with image  $\mathbb{R}^n$ . Note that if  $g_s^{(1)}$  were surjective, then so  $G_s^{(2)}(x, t)$  for all  $t$ .

□

## 27.2 Microbundles

Let us reinterpret smooth transversality in terms of normal bundles.

Recall that  $f: M \rightarrow N$  was transverse to a smooth submanifold  $X \subset N$  if for all  $x \in X$  and  $m \in f^{-1}(x)$  we have that  $Tf(TM_m) + TX_x = TN_x$ . This is equivalent to the statement that  $Tf: TM_m \rightarrow \nu_x := TN_x/TX_x$  is surjective. The vector bundle  $\nu := TN|_X/TX$  over  $X$  is the so-called *normal bundle*.

In the topological world the notion of a vector bundle is replaced by that of a microbundle, due to Milnor [Mil64].

**Definition 27.2.1.** An  $n$ -dimensional microbundle  $\xi$  over a space  $B$  is a triple  $\xi = (X, i, p)$  of a space  $X$  with maps  $p: X \rightarrow B$  and  $i: B \rightarrow X$  such that

- $p \circ i = \text{id}$
- for each  $b \in B$  there exists open neighborhoods  $U \subset B$  of  $b$  and  $V \subset p^{-1}(U) \subset X$  of  $i(b)$  and a homeomorphism  $\phi: \mathbb{R}^n \times U \rightarrow V$  such that  $\{0\} \times U \rightarrow \mathbb{R}^n \times U \rightarrow V$  coincides with  $i$  and  $\mathbb{R}^n \times U \rightarrow V \rightarrow B$  coincides with the projection to  $U$ . More precisely, the following diagrams should commute

$$\begin{array}{ccc} \mathbb{R}^n \times U & \xrightarrow{\phi} & V \\ \uparrow i & & \uparrow i|_U \\ U & \xlongequal{\quad} & U \end{array} \qquad \begin{array}{ccc} \mathbb{R}^n \times U & \xrightarrow{\phi} & V \\ \downarrow \pi_2 & & \downarrow p \\ U & \xlongequal{\quad} & U \end{array}$$

Two  $n$ -dimensional microbundles  $\xi = (X, i, p)$ ,  $\xi' = (X', i', p')$  over  $B$  are *equivalent* if there are neighborhoods  $W$  of  $i(B)$  and  $W'$  of  $i'(B)$  and a homeomorphism  $W \rightarrow W'$  compatible with all the data.

**Example 27.2.2.** If  $\Delta: M \rightarrow M \times M$  denotes the diagonal, and  $\pi_2: M \times M \rightarrow M$  the projection on the second factor, then  $(M \times M, \Delta, \pi_2)$  is the *tangent microbundle* of  $M$ .

To show it is an  $m$ -dimensional microbundle near  $b$ , pick a chart  $\psi: \mathbb{R}^n \rightarrow M$  such that  $b \in \psi(\mathbb{R}^n)$ . Since the condition on the existence of the homeomorphism  $\phi$  in the definition of a microbundle is local, it suffices to prove that the diagonal in  $\mathbb{R}^n$  has one of these charts. Indeed, we can take  $U = \mathbb{R}^n$ ,  $V = \mathbb{R}^n \times \mathbb{R}^n$  and  $\phi: \mathbb{R}^n \times \mathbb{R}^n \rightarrow \mathbb{R}^n \times \mathbb{R}^n$  given by  $(x, y) \mapsto (x + y, y)$ .

**Example 27.2.3.** Every vector bundle is a microbundle. If  $M$  is a smooth manifold, the tangent microbundle is equivalent to the tangent bundle. This is a consequence of the tubular neighborhood theorem.

Kister's theorem allows us to describe these microbundles in more familiar terms. To give this description, we use that microbundles

behave in many respects like vector bundles. For example, any microbundle over a paracompact contractible space  $B$  is trivial, i.e. equivalent to  $(\mathbb{R}^n \times B, \iota_0, \pi_2)$ . This is Corollary 3.2 of [Mil64]. The following appears in [Kis64] and is a consequence of Theorem 26.1.9.

**Definition 27.2.4.** An  $\mathbb{R}^n$ -*bundle* over a space  $B$  is a bundle with fibers  $\mathbb{R}^n$  and transition functions in the topological group consisting of homeomorphisms of  $\mathbb{R}^n$  fixing the origin.

We say that two  $\mathbb{R}^n$ -bundles  $\xi_0, \xi_1$  over  $B$  are *concordant* if there is an  $\mathbb{R}^n$ -bundle  $\zeta$  over  $B \times I$  that for  $i \in \{0, 1\}$  restricts to  $\xi_i$  over  $X \times \{i\}$ .

**Theorem 27.2.6 (Kister-Mazur).** *Every  $n$ -dimensional microbundle  $\xi = (E, i, p)$  over a sufficiently nice space (e.g. locally finite simplicial complex or a topological manifold) is equivalent to an  $\mathbb{R}^n$ -bundle. This bundle is unique up to isomorphism (in fact concordance).*

*Proof.* Let us assume that the base is a locally finite simplicial complex. The total space of our  $\mathbb{R}^n$ -bundle  $\mathcal{E}$  will be a subset of the total space  $E$  of the microbundle, and we will find it inductively over the simplices of  $B$ .

We shall content ourselves by proving the basic induction step, by showing how to extend  $\mathcal{E}$  from  $\partial\Delta^i$  to  $\Delta^i$ , see Figure ???. So suppose we are given a  $\mathbb{R}^n$ -bundle  $\mathcal{E}_{\partial\Delta^i}$  inside  $\xi|_{\partial\Delta^i}$ . For an inner collar  $\partial\Delta^i \times [0, 1]$  of  $\partial\Delta^i$  in  $\Delta^i$ , the local triviality allows us to extend it to  $\mathcal{E}_{\partial\Delta^i \times [0, 1]}$  inside  $\xi|_{\partial\Delta^i \times [0, 1]}$ . Since  $\Delta^i$  is contractible, we can trivialize the microbundle  $\xi|_{\Delta^i}$  and in particular it contains a trivial  $\mathbb{R}^n$  bundle  $\mathcal{E}_{\Delta^i} \cong \mathbb{R}^n \times \Delta^i$ . By shrinking the  $\mathbb{R}^n$ , we may assume that its restriction to  $\partial\Delta^i \times [0, 1]$  is contained in  $\mathcal{E}_{\partial\Delta^i \times [0, 1]}$ . Thus for each  $x \in \partial\Delta^i$ , we get a map  $\phi_x: [0, 1] \rightarrow \text{Emb}_0(\mathbb{R}^n, \mathbb{R}^n)$ . Using the canonical isotopy proved by Kister's theorem 26.1.9, we can isotope this family continuously in  $x$  to  $\tilde{\phi}_x$  satisfying (i)  $\tilde{\phi}_x(0)$  is a homeomorphism, (ii)  $\tilde{\phi}_x(1) = \phi_x(1)$ . Thus the replacement of  $\mathcal{E}_{\Delta^i}|_{\Delta^i \times [0, 1]} \subset \mathcal{E}_{\partial\Delta^i \times [0, 1]}$  by  $\tilde{\phi} \circ \phi^{-1}(\mathcal{E}_{\Delta^i}|_{\Delta^i \times [0, 1]})$ , is an extension of  $\mathcal{E}_{\partial\Delta^i}$  to  $\Delta^i$ .  $\square$

**Remark 27.2.5.** Warning: an  $\mathbb{R}^n$ -bundle need *not* contain a disk bundle, in contrast with the case of vector bundles [?]. Even if there exists one, it does not need to be unique [?].



## Topological transversality

### 28.1 Locally flat submanifolds and normal microbundles

The appropriate generalization of a smooth submanifold to the setting of topological manifolds is given by the following definition.

**Definition 28.1.1.** A *locally flat submanifold*  $X$  of a topological manifold  $M$  is a closed subset  $X$  such that for each  $x \in X$  there exists an open subset  $U$  of  $M$  and a homeomorphism from  $U$  to  $\mathbb{R}^m$  which sends  $U \cap X$  homeomorphically onto  $\mathbb{R}^x \subset \mathbb{R}^m$ .

Locally flat submanifolds are well behaved: every locally flat submanifold of codimension 1 admits a bicollar, the Schoenflies theorem for locally flat  $S^{n-1}$ 's in  $S^n$  says that any locally flat embedded  $S^{n-1}$  in  $S^n$  has as a complement two components whose closures are homeomorphic to disks [?]. Moreover, there is an isotopy extension theorem for locally flat embeddings [EK71].

**Remark 28.1.2.** Every locally flat submanifold of codimension 1 admits a bicollar. This may be used to give a different version of the proof of Theorem 26.2.3, by noting that all  $M_i$  constructed have locally flat boundary  $\partial M_i$  in  $M$ . Generalize Theorem 26.2.3 to the relative case: if  $M$  is of dimension  $\geq 6$  and contains a codimension zero submanifold  $A$  with handle decomposition and locally flat boundary  $\partial A$ , then we may extend the handle decomposition of  $A$  to one of  $M$ .

**Definition 28.1.4.** A *normal microbundle*  $\nu$  for a locally flat submanifold  $X \subset N$  is a  $(n - x)$ -dimensional microbundle  $\nu = (E, i, p)$  over  $X$  together with an embedding of a neighborhood  $U$  in  $E$  of  $i(X)$  into  $N$ . The composite  $X \hookrightarrow U \hookrightarrow N$  should be the identity.

Does a locally flat submanifold always admit a normal microbundle? This is true in the smooth case, as a consequence of the tubular neighborhood theorem.

**Remark 28.1.3.** This is not the only possible definition: one could also define a “possibly wild” submanifold to be the image of a map  $f: X \rightarrow M$ , where  $X$  is a topological manifold  $X$  and  $f$  is a homeomorphism onto its image.

Examples of such possibly wild submanifolds include the Alexander horned sphere in  $S^3$  and the Fox-Artin arc in  $\mathbb{R}^3$ . These exhibit what one may consider as pathological behavior: the Schoenflies theorem fails for the Alexander horned sphere (it is not the case that the closure of each component of its complement is homeomorphic to a disk). The Fox-Artin arc has a complement which is not simply-connected, showing that there is no isotopy extension theorem for wild embeddings.

See [?] for more results about wild

**Lemma 28.1.5.** *Any smooth submanifold  $X$  of a smooth manifold  $N$  has a normal microbundle.*

**Remark 28.1.6.** In fact, one can define *smooth microbundles*, requiring all maps to be smooth and replacing homeomorphisms with diffeomorphisms. A smooth submanifold has a unique smooth normal microbundle.

However, the analogue of Lemma 28.1.5 is not true in the topological case, and there is an example of Rourke-Sanderson in the PL case [RS67]. However, they do exist after stabilizing by taking a product with  $\mathbb{R}^s$  [?]. The uniqueness statement uses the notion of concordance. We say that two normal microbundles  $\nu_0, \nu_1$  over  $X \subset N$  are *concordant* if there is a normal bundle  $\nu$  over  $X \times I \subset N \times I$  restricting for  $i \in \{0, 1\}$  to  $\nu_i$  on  $X \times \{i\}$ .

**Theorem 28.1.7** (Brown). *If  $X \subset N$  is a locally flat submanifold, then there exists an  $S \gg 0$  depending only on  $\dim X$  and  $\dim N$ , such that  $X$  has a normal microbundle in  $N \times \mathbb{R}^s$  if  $s \geq S$ , which is unique up to concordance if  $s \geq S + 1$ .*

**Remark 28.1.8.** By the existence and uniqueness of collars, normal microbundles do exist in codimension one. Kirby-Siebenmann proved they exist and are unique in codimension two (except when the ambient dimension is 4) [?], the case relevant to topological knot theory. Finally, in dimension 4 normal bundles always exist by Freedman-Quinn [FQ90, Section 9.3]. One can also relax the definitions and remove the projection map but keep a so-called block bundle structure. Normal block bundles exist and are unique in codimension  $\geq 5$  or  $\leq 2$ , see [?].

## 28.2 Topological microbundle transversality

We will now describe a notion of transversality for topological manifolds, which generalizes smooth transversality and makes the normal bundles part of the data of transversality.

**Definition 28.2.1.** Let  $X \subset N$  be a locally flat submanifold with normal microbundle  $\zeta$ . Then a map  $f: M \rightarrow N$  is said to be *microbundle transverse to  $\zeta$  (at  $\nu$ )* if

- $f^{-1}(X) \subset M$  is a locally flat submanifold with a normal microbundle  $\nu$  in  $M$ ,
- $f$  gives an open topological embedding of a neighborhood of the zero section in each fiber of  $\nu$  into a fiber of  $\zeta$ .

See Figure ?? for an example. We now prove that this type of transversality can be achieved by small perturbations, as we did in Lemma 12.2.6 for smooth transversality.

**Remark 28.2.2.** One can also define smooth microbundle transversality to a smooth normal microbundle. This differs from ordinary transversality in the sense that the smooth manifold has to line up with normal microbundle near the manifold  $X$ , i.e. the difference between the intersection “at an angle” of Figure ?? and the “straight” intersection of Figure ?. Smooth microbundle transversality implies ordinary transversality, and any smooth transverse map can be made smooth microbundle transverse. This is why one usually does not discuss the notion of smooth microbundle transversality.

**Remark 28.2.3.** There are other notions of transversality that may be more well-behaved; in particular there is Marin’s stabilized transversality [?] and block transversality [RS67]. A naive local definition is known to be very badly behaved: a relative version is false [?].

The following is a special case of [KS77, Theorem III.1.1].

**Theorem 28.2.4** (Topological microbundle transversality). *Let  $X \subset N$  be a locally flat submanifold with normal microbundle  $\zeta = (E, i, p)$ . If  $m + x - n \geq 6$  (the expected dimension of  $f^{-1}(X)$ ), then every map  $f: M \rightarrow N$  can be approximated by a map which microbundle transverse to  $\zeta$ .*

*Proof.* The steps of our proof are the same as those in Lemma 12.2.6. Again, we actually need to prove a strongly relative version. That is, we assume we are given  $C_{\text{done}}, D_{\text{todo}} \subset M$  closed and  $U_{\text{done}}, V_{\text{todo}} \subset M$  open neighborhoods of  $C_{\text{done}}, D_{\text{todo}}$  respectively such that  $f$  is already microbundle transverse to  $\zeta$  at  $\nu_{\text{done}}$  over a submanifold  $L_{\text{done}} := f^{-1}(X) \cap U_{\text{done}}$  in  $U_{\text{done}}$  (note that  $C_{\text{done}} \cap D_{\text{todo}}$  could be non-empty). We invite the reader to look at Figure ?? again. It will be helpful to let  $r := n - x$  denote the codimension of  $X$ .

Then we want to make  $f$  microbundle transverse to  $\zeta$  at some  $\nu$  on a neighborhood of  $C_{\text{done}} \cup D_{\text{todo}}$  without changing it on a neighborhood of  $C_{\text{done}} \cup (M \setminus V_{\text{todo}})$ . We will also ignore the smallness of the approximation, as it is a theorem that a strongly relative result *always* implies an  $\epsilon$ -small result, see Appendix I.C of [KS77].

*Step 1:*  $M$  open in  $\mathbb{R}^m$ ,  $X = \{0\}$ ,  $\zeta$  is a product,  $N = E = \mathbb{R}^r$  We want to apply the relative version of smooth transversality (with the small smooth microbundle transversality improvement mentioned in Remark 28.2.2). To do this we need to find a smooth structure  $\Sigma$  on  $M$  such that for some open neighborhood  $W_\Sigma$  of  $f^{-1}(0) \cap C_{\text{done}} \subset M$ , the microbundle  $\nu_{\text{done}} \cap W_\Sigma$  over  $L_{\text{done}} \cap W_\Sigma$  is smooth and  $f: M_\Sigma \rightarrow \mathbb{R}^r$  is transverse at  $\nu_{\text{done}} \cap W_\Sigma$  to 0 near  $C_{\text{done}}$ .

This uses a version of the product structure theorem. The version we stated before said that concordance classes of smooth structures

on  $M \times \mathbb{R}$  are in bijection to concordance classes of smooth structures on  $M$ . We need a local version, specializing [KS77, Theorem I.5.2]:

Suppose one has a topological manifold  $L$  of dimension  $\geq 6$ , an open neighborhood  $E$  of  $L \times \{0\} \subset L \times \mathbb{R}^s$ , a smooth structure  $\Sigma$  on  $E$ ,  $D \subset L \times \{0\}$  closed and  $V \subset E$  an open neighborhood of  $D$ . Then there exists a concordance of smooth structures on  $E \text{ rel } (E \setminus V)$  from  $\Sigma$  to a  $\Sigma'$  that is a product near  $D$ . See Figure ??.

We want to substitute the data  $(L, E, s, \Sigma, D, V)$  of this theorem by the data  $(L_{\text{done}}, E(v_{\text{done}}), r, \Sigma', L_{\text{done}} \cap C_{\text{done}}, V')$  with  $\Sigma'$  and  $V'$  to be defined. Thus here we get the condition that  $\dim(L_{\text{done}}) = m - r = m + x - n \geq 6$ . For this substitution to make sense, we must have that  $E_{\text{done}}$  is an open subset of  $L_{\text{done}} \times \mathbb{R}^r$ , which comes from the open inclusion  $(p, f): E(v_{\text{done}}) \hookrightarrow L_{\text{done}} \times \mathbb{R}^r$ . In terms of the latter coordinates  $f$  is simply the projection  $\pi_2: L_{\text{done}} \times \mathbb{R}^r \rightarrow \mathbb{R}^r$ . Since  $E(v_{\text{done}}) \subset M \subset \mathbb{R}^m$ , it inherits the standard smooth structure. The set  $V'$  will be an open neighborhood of  $L_{\text{done}}$  in  $E(v_{\text{done}})$  with closure also contained in  $E(v_{\text{done}})$ .

Then the application of the local version of the product structure theorem gives us a smooth structure on  $V'$ , which can be extended by the standard smooth structure to  $M$  since we did not modify it outside  $V'$ . In this smooth structure  $L_{\text{done}}$  is smooth and  $v_{\text{done}}$  is just the product with  $\mathbb{R}^n$ . This implies that  $f$  is now smooth, as it is given by the projection  $(L_{\text{done}})_{\Sigma} \times \mathbb{R}^r \rightarrow \mathbb{R}^r$ .

To finish this step, outside a small neighborhood of  $L_{\text{done}}$  we smooth  $f$  near  $D_{\text{todo}}$  without modifying outside  $V_{\text{todo}}$  and then apply a relative version of transversality with the same constraints on where we make the modifications.

*Step 2:  $M$  open in  $\mathbb{R}^m$ ,  $\xi$  trivializable* Since  $\xi$  is trivializable we may assume  $E(\xi)$  contains  $\mathbb{R}^r \times X$ . If we substitute

- $M' = f^{-1}(\mathbb{R}^r \times X)$ ,
- $C'_{\text{done}} = (C_{\text{done}} \cup f^{-1}(X \times (\mathbb{R}^r \setminus \text{int}(D^n)))) \cap f^{-1}(\mathbb{R}^r \times X)$ ,
- $D'_{\text{todo}} = D_{\text{todo}} \cap f^{-1}(\mathbb{R}^r \times X)$ ,

we reduce to the case where  $\xi$  is a product and  $Y = \mathbb{R}^r \times X$ .

Then we have that  $f: M \rightarrow Y$  is given by  $(f_1, f_2): M \rightarrow \mathbb{R}^r \times X$ . Consider the map  $f_1: M \rightarrow \mathbb{R}^r$ . Then  $(f_1)^{-1}(\{0\}) \cap U_{\text{done}} = f^{-1}(X) \cap U_{\text{done}}$  is a locally flat submanifold  $L_{\text{done}}$  with normal microbundle and  $f_1$  embeds a neighborhood of the 0-section of the fibers of  $v_{\text{done}}$  into  $\mathbb{R}^r$ , the fiber of projection to a point. By the previous step we thus can make  $f_1$  microbundle transverse to  $\xi$

near  $C_{\text{done}} \cup D_{\text{todo}}$  by a small perturbation to some  $f'_1$ , while fixing it on a neighborhood of  $C_{\text{done}} \cup (M \setminus V_{\text{todo}})$ .

A minor problem now appears when we add back in the component  $f_2$ : even though  $f' := (f'_1, f_2)$  has  $(f')^{-1}(X)$  a locally flat submanifold with normal bundle,  $f'$  may not embed neighborhoods of the 0-section of fibers of this normal bundle into fibers of  $\mathbb{R}^r \times X \rightarrow \mathbb{R}^r$ . This would be resolved if we precomposed  $f_2$  by a map that near  $C_{\text{done}} \cup D_{\text{todo}}$  collapses a neighborhood of the 0-section into the 0-section in a fiber-preserving way, extending by the identity outside a closed subset containing this neighborhood. Such a map can easily be found, see e.g. Lemma III.1.3 of [KS77].

*Step 3: General case* This will be an induction over charts, literally the same as Step 3 for smooth transversality. We can find a covering  $U_\alpha$  of  $X$  so that each  $\zeta|_{U_\alpha}$  is trivializable. Since  $X$  is paracompact (by our definition of topological manifold), we can find a locally finite collection of charts  $\{\phi_\beta: \mathbb{R}^m \supset V_\beta \hookrightarrow M\}$  covering  $V_{\text{todo}}$ , such that (i)  $D^m \subset V_\beta$ , (ii)  $D_{\text{todo}} \subset \bigcup_\beta \phi_\beta(D^m)$  and (iii) for all  $\beta$  there exists an  $\alpha$  with  $f(\phi_\beta(V_\beta)) \subset U_\alpha$ .

Order the  $\beta$ , and write them as  $i \in \mathbb{N}$  from now on. By induction one then constructs a deformation to  $f_i$  transverse on some open  $U_i$  of  $C_i := C \cup \bigcup_{j \leq i} \phi_j(D^m)$ . The induction step from  $i$  to  $i+1$  uses step (2) using the substitution  $M = V_{i+1}$ ,  $C_{\text{done}} = \phi_{i+1}^{-1}(C_i)$ ,  $U_{\text{done}} = \phi_{i+1}^{-1}(U_i)$ ,  $D_{\text{todo}} = D^m$  and  $V_{\text{todo}}$  is  $\text{int}(2D^m)$ .

Then a deformation is given by putting the deformation from  $f_i$  to  $f_{i+1}$  in the time period  $[1 - 1/2^i, 1 - 1/2^{i+1}]$ . This is continuous as  $t \rightarrow 1$  since the cover was locally finite.  $\square$

**Remark 28.2.5.** We could have used the local version of the product structure theorem in place of the ordinary product structure theorem and concordance extension in the proof of Theorem 26.2.3.

**Remark 28.2.6.** The case  $m + x - n < 0$  of Theorem 28.2.4 may be proven similarly, and does not require the local product structure theorem.

If re-examine the proof to see how important the role of the normal bundle  $\zeta$  to  $X$  is, we realize that we only used that  $X$  is paracompact and that  $X$  is the zero-section of an  $\mathbb{R}^n$ -bundle. The microbundle transversality result with these weaker assumptions on  $X$  will be used in the next lecture.

**Remark 28.2.7.** Theorem 28.2.4 does *not* prove that if  $M$  and  $X$  are locally flat submanifolds and  $X$  has a normal microbundle  $\zeta$ , then  $M$  can be isotoped to be microbundle transverse to  $\zeta$ . The reason is that

the smoothing of  $f$  in step (1) destroys embeddings, as locally flat embeddings are not open.

However, an embedded microbundle transversality result like this is true. The proof in [KS77, Theorem III.1.5] bootstraps from PL manifolds instead, a category of manifolds in which it does not even make sense to talk about openness (PL maps should always be considered as a simplicial set). One additional complication is that finding adapted PL structures requires a result of taming theory, which says that for a topological embedding of a PL manifold of codimension  $\geq 3$  into a PL manifold, the PL structures on the target can be modified so that the embedding is PL. This is applied to both  $X$  and  $N$ .

## The Kirby-Siebenmann bundle theorem

Having finished the algebraic K-theory part, we now work towards smoothing theory and proving the weak equivalence

$$\Theta_n \times B\text{Diff}_\partial(D^n) \simeq \Omega^n \text{Top}(n)/O(n).$$

The main tools are the Kirby-Siebenmann bundle theorem and Gromov's  $h$ -principle machinery. We start with the former, Essay II of [KS77]. For bundles, a good reference is [Hus94].

### 29.1 Bundles and submersions

We start with a preliminary discussion of the relationship between smooth manifold bundles and smooth submersions.

#### Manifold bundles

For a topological group  $G$ , the classifying space  $BG$  classifies principal  $G$ -bundles; these are maps  $\pi: E \rightarrow B$  with a free action of  $E \times G \rightarrow E$  of  $G$  over  $B$ , which are locally trivial in the sense that each  $b \in B$  has an open neighborhood  $U \subset B$  such that there is a  $G$ -equivariant homeomorphism

$$\begin{array}{ccc} \pi^{-1}(U) & \xrightarrow{\cong} & U \times G \\ & \searrow & \swarrow \\ & B & \end{array}$$

On the overlap of two such neighborhoods we obtain transition functions  $\varphi_{ij}: U_i \cap U_j \rightarrow G$  satisfying the cocycle condition.

The classifying space  $BG$  is determined up to weak equivalence by the existence of a universal principal  $G$ -bundle  $EG$  over  $BG$ , which is

Takeaways:

- Proper smooth submersions are smooth manifold bundles.
- Smooth submersions that are topological manifold bundles are smooth manifold bundles, even if they are not proper; the Kirby-Siebenmann bundle theorem.
- This allows us to compute the homotopy type of the space of smooth structures on a topological manifold  $M$  as a disjoint union of quotient spaces  $\text{Homeo}(M)/\text{Diff}(M_\Sigma)$  for different smooth structures  $\Sigma$  on  $M$ .

called *universal* because pullback gives a natural bijection

$$\begin{array}{c} [X, BG] \xrightarrow{\cong} \underbrace{\{\text{principal } G\text{-bundles over } X\}}_{\text{isomorphism}} \\ [f] \mapsto [f^*(EG)], \end{array}$$

as long as  $X$  is paracompact. See Chapter 4 and 5 of [Hus94].

For any space  $Y$  with  $G$ -action, we can define locally trivial  $Y$ -bundles with transition functions in  $G$ . One definition of this a map  $E' \rightarrow B$  that is isomorphic over  $B$  to one constructed from a principal  $G$ -bundle  $E \rightarrow B$  as  $E \times_G Y$  (I imagine one wants to encode the principal  $G$ -bundle as part of the data, but this will not matter soon).

The action  $G$  on  $Y$  is said to be *faithful* (also called effective) if  $g \cdot y = y$  for all  $y \in Y$  implies  $g = \text{id}$ . In this case,  $E$  may be recovered from  $E'$  up to isomorphism, and we conclude that there is a bijection

$$\begin{array}{c} \underbrace{\{\text{principal } G\text{-bundles over } X\}}_{\text{isomorphism}} \xrightarrow{\cong} \underbrace{\{Y\text{-bundles over } X \text{ with transition functions in } G\}}_{\text{isomorphism}} \\ [E \rightarrow X] \mapsto [E \times_G Y \rightarrow X]. \end{array}$$

Let us specialize to  $G = \text{Diff}_\partial(M)$ , which has a faithful action on  $M$  itself. No reference has been made so far to smooth structures. We may as well assume that the base  $B$  is a smooth, since any space with the homotopy type of a finite CW complex is homotopy equivalent to a smooth manifold. But even if the base  $B$  of an  $M$ -bundle with transition functions in  $\text{Diff}_\partial(M)$  is a smooth manifold, the total space  $E$  need not be. The reason is that the continuous maps  $g: U \rightarrow \text{Diff}_\partial(M)$  which appear as transition functions do not need to have the property that the associated map  $\bar{g}: U \times M \rightarrow U \times M$  over  $U$  is a diffeomorphism.

However, using the smoothing results for continuous maps into mapping spaces with  $C^\infty$ -topology discussed before, we can approximate all transition functions maps for which this is the case. This is related to the fact that the inclusion  $\text{SDiff}_\partial(M) \hookrightarrow \text{Sing}(\text{Diff}_\partial(M))$  of simplicial groups, given by including smooth simplices into all singular simplices, is a weak equivalence.

Once all the associated maps for the transition functions are diffeomorphisms, there is a unique smooth structure on  $E$  making the map  $\pi: E \rightarrow B$  smooth. We conclude that up to isomorphism, the  $M$ -bundles  $\pi: E \rightarrow B$  with transition functions in  $\text{Diff}(M)$  over smooth base  $B$ , are in bijection with the following objects:

**Definition 29.1.1.** A *smooth  $M$ -bundle over  $B$*  is smooth map  $\pi: E \rightarrow B$  such that each  $b \in B$  has a *bundle chart*: an open neighborhood  $U \subset E$  of  $\pi^{-1}(b)$  such that there is a diffeomorphism  $\pi^{-1}(U) \cong U \times M$



fitting in a commutative diagram:

$$\begin{array}{ccc} \pi^{-1}(U) & \xrightarrow{\cong} & U \times M \\ \downarrow \pi & & \downarrow \pi_1 \\ U & \xlongequal{\quad} & U. \end{array}$$

The upshot of this discussion is  $B\text{Diff}(M)$  also classifies smooth manifold bundles, as long as we map in smooth manifolds.

### Submersions

The notion of a smooth manifold bundle is local in the base. We may also demand locality in the fiber, which leads to the definition of a smooth submersion.

**Definition 29.1.2.** A smooth map  $\pi: E \rightarrow B$  is a *smooth submersion* such that each  $e \in E$  has a *submersion chart*: an open neighborhood  $U \subset E$  of  $e$  and an open neighborhood  $V \subset \pi^{-1}(\pi(e))$  of  $e$  such that there is a diffeomorphism  $\varphi: U \cong \pi(U) \times V$  fitting in a commutative diagram:

$$\begin{array}{ccc} U & \xrightarrow{\cong} & \pi(U) \times V \\ \downarrow \pi & & \downarrow \pi_1 \\ \pi(U) & \xlongequal{\quad} & \pi(U). \end{array}$$

That  $\pi(U)$  is open follows from the fact  $\pi(U) \times V$  is diffeomorphic to an open subset of  $E$ . Note that we may assume that  $\varphi|_{\pi(U) \times V} = \text{id}_V$  by composing with the diffeomorphism  $\text{id} \times \varphi|_{\pi(U) \times V}^{-1}$  over  $\pi(U)$ .

More generally, one can define a submersion chart for any subset of a fiber of  $\pi$ ; the above definition is for  $\{e\} \subset \pi^{-1}(\pi(e))$ . For example, a bundle chart is a submersion chart for an entire fiber with the additional data of an identification of that fiber with  $M$ .

**Example 29.1.3.** The implicit function theorem says that a smooth map  $\pi: E \rightarrow B$  is a submersion if and only if its derivative  $D\pi: TE \rightarrow TM$  is surjective. The definition given above has the advantage of easily generalizing to topological and PL manifolds.

### The union lemma for submersion charts

We want to prove that every compact subset  $K$  of a fiber of a submersion  $\pi: E \rightarrow B$  admits a submersion chart. This is directly consequence by induction over a finite cover of  $K$  by submersion charts, of the following union lemma. This lemma is a consequence of isotopy extension. The best reference for these types of technical results is [Sie72].

**Lemma 29.1.4.** *Let  $\pi: E \rightarrow B$  be a smooth submersion,  $b \in B$  and  $K_0, K_1 \subset \pi^{-1}(b)$  compact. If  $K_0$  and  $K_1$  admit a submersion chart, then so does  $K_0 \cup K_1$ .*

*Proof.* For  $i \in \{0, 1\}$ , let  $(U_i, V_i, \varphi_i)$  be a submersion chart for  $K_i$ ; that is,  $U_i \subset E$  and  $V_i \subset \pi^{-1}(b)$  are open neighborhoods of  $K_i$  with a diffeomorphism  $\varphi_i: U_i \rightarrow \pi(U_i) \times V_i$ . We may assume that  $(\varphi_i)|_{\pi(e) \times V_i} = \text{id}_{V_i}$  (as explained before), and that the subsets  $p(U_i)$  are both equal to  $p(U_i) \cap p(U_j) =: W_{01}$  (by restriction).

There exist compact codimension 0 submanifolds  $M_i \subset V_i$  containing  $K_i$  in their interior such that  $M_{01} := M_0 \cap M_1$  is compact codimension 0 submanifold with corners in  $V_{01} := V_0 \cap V_1$ . By shrinking  $W_{01}$  if necessary, we may assume that  $W_{01} = \mathbb{R}^k$  with  $b$  the origin and that we have  $\varphi_1^{-1}(\varphi_0(W_{01} \times M_{01})) \subset W_{01} \times V_{01}$ .

The latter implies that the map

$$f := \varphi_1^{-1} \circ \varphi_0: W_{01} \times M_{01} \rightarrow U_{01} \rightarrow W_{01} \times V_{01}$$

is well-defined. It may be interpreted as a  $k$ -parameter isotopy of  $M_{01}$  in  $V_{01}$  indexed by  $\mathbb{R}^k$ , which equal to the identity at the origin in the parameter  $\mathbb{R}^k$ . By isotopy extension there exists a compactly supported ambient isotopy  $\psi$  of  $V_{01}$  indexed by  $D^k$  such that  $f(t, m) = \psi_t(m)$ . By extension by the identity, after replacing  $W_{01}$  by  $D^k$ ,  $\psi$  may be interpreted as a compactly-supported diffeomorphism  $\bar{\psi}: U_0 \rightarrow U_0$  over  $W_{01}$ .

If we replace  $\varphi_0$  by  $\bar{\varphi}_0 := \bar{\psi}^{-1} \circ \varphi_0$ , then the maps  $\bar{\varphi}_0: W_{01} \times V_0 \rightarrow U_0$  and  $\varphi_1: W_{01} \times V_1 \rightarrow U_1$  agree on  $W_{01} \times M_{01}$ . So, define a new map

$$\begin{aligned} \bar{\varphi}: W_{01} \times (\text{int}(M_0 \cup M_1)) &\rightarrow E \\ (t, m) &\mapsto \begin{cases} \bar{\varphi}_0(t, m) & \text{if } m \in \text{int}(M_0 \cup M_1) \cap M_0 \\ \varphi_1(t, m) & \text{otherwise} \end{cases} \end{aligned}$$

This is a smooth immersion over  $W$ , that is an embedding at  $b \in W$ . By point-set lemma's, there exists a neighborhood  $W$  of  $b$  in  $W_{01}$  and a neighborhood  $V$  of  $K_0 \cup K_1$  in  $\text{int}(M_0 \cup M_1)$ , such that  $\bar{\varphi}: W \times V \rightarrow E$  is an embedding over  $W$ . Let us denote its image by  $U$  and  $\varphi$  be  $\bar{\varphi}|_U^{-1}: U \rightarrow W \times V$ . This is the desired submersion chart.  $\square$

If  $\pi: E \rightarrow B$  is proper, this means that every fiber has a submersion chart and thus as long as  $B$  is path-connected,  $\pi$  is actually a smooth manifold bundle. This is the Ehresmann fibration theorem:

**Corollary 29.1.5.** *If  $\pi: E \rightarrow B$  is a proper smooth submersion and  $B$  is path-connected, it is a smooth manifold bundle.*

There is also a version when  $E$  has non-empty boundary, and  $\pi|_{\partial E}: \partial E \rightarrow B$  is a smooth manifold bundle.

**Remark 29.1.6.** This may also be proven directly by constructing commuting vector fields on  $E$  whose projections to  $B$  are non-vanishing and flowing along them. The properness of  $\pi$  comes in when making sure this flow exists near the fiber.

**Remark 29.1.7.** This proof only uses the isotopy extension, which also known for topological and PL-manifolds [EK71, Hud66]. We have thus also proven an Ehresmann fibration theorem for these types of manifolds.

## 29.2 A weak version of the Kirby-Siebenmann bundle theorem

Corollary 29.1.5 is false without properness. The Kirby-Siebenmann bundle theorem gives a condition under which a smooth submersion which non-compact fibers is still a smooth manifold bundle.

### Statement and strategy

This result uses the notion of a *topological manifold bundle*, which has bundle charts given by *homeomorphisms*  $\pi^{-1}(U) \cong U \times M$  and is classified by a map  $B \rightarrow B\text{Homeo}(M)$ . We will prove the following weaker version of Kirby-Siebenmann's result:

**Theorem 29.2.1.** *If  $\pi: E \rightarrow B$  is a smooth submersion which is a topological manifold bundle, and the dimension  $d$  of the fibers of  $\pi$  are of dimension  $\geq 6$ , then it is a smooth manifold bundle.*

**Remark 29.2.2.** Kirby-Siebenmann's is stronger in the following sense: (i) they also allow their fibers to have boundary, (ii) our version is  $\text{Top} \rightsquigarrow \text{Diff}$ , it also works for  $\text{PL} \rightsquigarrow \text{Diff}$  or  $\text{Top} \rightsquigarrow \text{PL}$ , (iii) for the  $\text{Top} \rightsquigarrow \text{Diff}$  or  $\text{Top} \rightsquigarrow \text{PL}$  cases, they improve the dimensional restriction to  $d \neq 4$  (and  $d \neq 3$  if the boundary of the fibers is non-empty), and the  $\text{PL} \rightsquigarrow \text{Diff}$  case there is no dimensional restriction at all, (iv) the condition of being a topological manifold bundle is replaced by a weaker technical "engulfing condition."

**Remark 29.2.3.** The case  $d = 4$  is false. For example, there is a smooth submersion  $\mathbb{R}^5 \rightarrow \mathbb{R}$  all of whose fibers are mutually non-diffeomorphic.

Let us consider the case that  $E$  homeomorphic to  $B \times M \times \mathbb{R}$  over  $B$ , with  $M$  compact. The strategy will be to "roll up" the  $\mathbb{R}$ -direction to obtain a topological manifold bundle  $\tilde{\pi}: \tilde{E} \rightarrow B$  homeomorphic to  $B \times M \times \mathbb{R}/\mathbb{Z}$  over  $B$ , so that  $\pi$  factors as

$$\begin{array}{ccc} E & \xrightarrow{\tau} & \tilde{E} \\ & \searrow \pi & \swarrow \tilde{\pi} \\ & B & \end{array}$$

$\mathbb{Z}$  cover

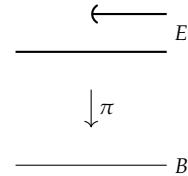

Figure 29.1: A non-proper submersion which is not a manifold bundle.

where  $\tau$  is a fiberwise covering map. Then  $\tilde{E}$  inherits a smooth structure from  $E$  making  $\tilde{\pi}$  a smooth submersion, and since  $\tilde{\pi}$  is proper it is a smooth manifold bundle by the Ehresmann fibration theorem. A fiberwise cover space of a smooth manifold bundle is a smooth manifold bundle, just by lifting the bundle charts.

### *The fiberwise engulfing condition*

Let us obtain a slightly weaker result under slightly weaker assumptions. The input is a smooth submersion  $\pi: E \rightarrow B$  with a continuous map  $p: E \rightarrow \mathbb{R}$ . We introduce the notation  $F_b := \pi^{-1}(b)$  and  $F_b(x, y) := F_b \cap p^{-1}([x, y])$  (where we shall also allow  $x, y$  to be  $\pm\infty$ ).

**Definition 29.2.4.** We say  $\pi$  satisfies the *fiberwise engulfing condition* if for any  $b \in B$  and pair  $m \leq n$  of integers, there exists a smooth isotopy  $h_t$  of  $F_b$  compactly supported in  $F_b(m-1, n+1)$  such that  $h_0 = \text{id}$  and  $\text{int } h_1(F_b(-\infty, m)) \supset F_b(\infty, n)$ .

We shall show that the fiberwise engulfing condition implies a global one:

**Proposition 29.2.5.** *Suppose  $B$  is compact and of dimension  $k$ . If  $\pi$  satisfies the fiberwise engulfing condition, then for any pair of integers  $m \leq n$  there exists a smooth isotopy  $g_t$  of  $E$  over  $B$  compactly supported in  $p^{-1}(m-k-1, n+k+1)$  such that  $g_0 = \text{id}$  and  $\text{int } g_1(p^{-1}(-\infty, m]) \supset p^{-1}(-\infty, n]$ .*

**Remark 29.2.6.** The compact support condition in the fiberwise engulfing condition implies that  $p$  is proper on each fiber.

This is a special case of an *engulfing condition*  $\mathcal{E}[r, c, C]$  for  $C \subset B$  compact,  $r \in (0, \infty]$  and  $c > 0$ :

For any pair  $m \leq n$  of integers with  $[m-c, n+c] \subset [-r+2, r-2]$ , there exists a smooth isotopy  $g_t$  of  $E$  compactly supported in  $p^{-1}(m-c, n+c)$  such that  $g_0 = \text{id}$  and  $\text{int } g_1(p^{-1}(-\infty, m]) \supset p^{-1}(-\infty, n] \cap \pi^{-1}(C)$ .

For example, the condition in Proposition 29.2.5 is  $\mathcal{E}[\infty, k+1, B]$ . Here are some facts about this condition, easily verified:

- $\mathcal{E}[r, c, C]$  implies  $\mathcal{E}[s, d, D]$  if  $r \geq s$ ,  $c \leq d$  and  $C \supset D$ .
- $\mathcal{E}[r, c, C]$  and  $\mathcal{E}[r, d, D]$  imply  $\mathcal{E}[r, c+d, C \cup D]$  (hint: compose isotopies). If  $C \cap D = \emptyset$ ,  $\mathcal{E}[r, c, C]$  and  $\mathcal{E}[r, d, D]$  imply  $\mathcal{E}[r, \max(c, d), C \cup D]$  (hint: shrink the support of the isotopies in the base).
- $\mathcal{E}[r_i, c, C]$  for a sequence of  $r_i$  going to  $\infty$  implies  $\mathcal{E}[\infty, c, C]$ .

**Lemma 29.2.8.** *Fixing  $r$  and assuming the fiberwise engulfing condition, for each  $b \in B$  there is an open neighborhood  $W_b \subset B$  of  $b$  such that for any closed  $C_b \subset W_b$  we have that  $\mathcal{E}[r, 1, C_b]$  holds.*

**Remark 29.2.7.** It is instructive to point out that to obtain  $\mathcal{E}[r, c, C]$  and  $\mathcal{E}[r, d, D]$  imply  $\mathcal{E}[r, c+d, C \cup D]$ , for integers  $m \leq n$ , we need  $g^C$  for  $m \leq n+d$  and  $g^D$  for  $m-c \leq n$  to avoid one of them messing up the condition for the other. This is the entire point of including the integer  $m \leq n$  everywhere.

*Proof.* By the union lemma for submersion charts, Lemma 29.1.4, we can find a submersion chart for  $F_b[-r, r]$ ;  $\varphi_b: U_b \rightarrow W_b \times V_b$  with  $V_b \subset F_b$  containing  $F_b[-r, r]$ . We need to produce an isotopy  $g_t$  for each  $m \leq n$  with  $[m-1, n+1] \subset [-r+2, r-2]$ . But this is done simply by extending  $h_t$  on  $F_b$  to  $U_b$  using the submersion chart, using a bump function  $\eta: W_b \rightarrow [0, 1]$  which is 1 on  $C_b$  and 0 near  $\partial W_b$ .  $\square$

We now give the proof of Proposition 29.2.5.

*Proof of Proposition 29.2.5.* By taking a fine enough triangulation and taking neighborhoods of vertices in the barycentric subdivision, there exists a cover of  $B$  by  $k+1$  closed subsets  $C_i$ , each of which is a finite disjoint union of closed subsets  $C_{ij}$  contained in a  $W_b$ . Lemma 29.2.8,  $\mathcal{E}[r, 1, C_{ij}]$  holds and hence  $\mathcal{E}[r, 1, C_i]$  holds. From this we conclude that  $\mathcal{E}[r, k+1, B]$  holds. Since  $r$  was arbitrary, we can conclude  $\mathcal{E}[\infty, k+1, B]$  from this.  $\square$

The following is a weak version of the bundle theorem.

**Corollary 29.2.9.** *For any pair  $m \leq n$  of integers there is an open subset  $E_{mn} \subset E$  containing  $p^{-1}([m, n])$  such that  $\pi|_{E_{mn}}: E_{mn} \rightarrow B$  is a smooth manifold bundle.*

Warning: this is *not* local condition, as  $E_{mn}$  constructed locally need not path together globally.

*Proof.* From  $\mathcal{E}[\infty, k+1, B]$ , which holds by Proposition 29.2.5, we obtain a diffeomorphism  $h_1$  of  $E$  over  $B$  such that  $\text{int } h_1(p^{-1}(-\infty, m]) \supset p^{-1}(-\infty, n]$ . This is a covering map on  $E_{mn}$  defined as follows:

$$\begin{aligned} Z_{mn} &:= h_1(p^{-1}(-\infty, m]) \setminus p^{-1}(-\infty, m), \\ E_{mn} &:= \bigcup_{i \in \mathbb{Z}} h_1^i(Z_{mn}). \end{aligned}$$

Then  $h_1$  induces a  $\mathbb{Z}$ -action on  $E_{mn}$  with  $Z_{mn}$  a compact fundamental domain, as  $h_1$  has compact support. Thus we obtain factorization

$$\begin{array}{ccc} E_{mn} & \xrightarrow{q} & E_{mn}/\mathbb{Z} \\ & \searrow \pi & \swarrow \tilde{\pi} \\ & B & \end{array}$$

where  $q$  is a covering map and  $\tilde{\pi}$  has compact fibers. We saw before this implies that  $\pi$  restricted to  $E_{mn}$  is a smooth manifold bundle.  $\square$

### 29.3 The Kirby-Siebenmann bundle theorem

There are two things to do now: (i) give a condition under which the fiberwise engulfing condition holds, (ii) deduce the Kirby-Siebenmann bundle from this.

### Verifying the fiberwise engulfing theorem

We shall now explain how to verify the fiberwise engulfing condition.

**Example 29.3.1.** We claim that if a fiber  $F_b$  is a (smooth) product  $M \times \mathbb{R}$  with  $M$  closed and  $\|p - \pi_2\| < 1$ , then  $F_b$  satisfies the fiberwise engulfing condition. To see this, pick  $m \leq n$ , so that  $p^{-1}([m, n])$  is compact and contained in  $M \times [m - 1 + \epsilon, n + 1 - \epsilon]$ . Now we simply pull  $(-\infty, m - 1 + \epsilon)$  over  $(-\infty, n + 1 - \epsilon]$  by a smooth isotopy with support in  $[m - 1, n + 1]$  and take the product with  $\text{id}_M$ , which verifies the fiberwise engulfing condition.

We now weaken the condition in the Example that  $F_b$  is a smooth product, to the statement that it is just a topological product. For convenience we take  $p = \pi_2$ , as this is enough for our purposes.

**Lemma 29.3.2.** *If the fiber  $F_b$  is homeomorphic to  $M \times \mathbb{R}$  for  $M$  a closed topological manifold of dimension  $\geq 5$  and  $p = \pi_2$ , then  $F_b$  satisfies the fiberwise engulfing condition.*

We will approach this differently than Kirby-Siebenmann, using Siebenmann's *end theorem* instead of engulfing. The end theorem is in the same class of theorems as the  $h$ -cobordism theorem and Waldhausen's theorem, and concerns the question whether a non-compact manifold  $N$  is the interior of a compact manifold with boundary [Sie65]. The answer involves a point-set topology condition on the ends of  $N$  called *tameness* and a *finiteness obstruction*  $\sigma(\epsilon)$  valued in  $K_0(\mathbb{Z}[\pi_1^\infty(\epsilon)])$ , where  $\pi_1^\infty(\epsilon)$  is the fundamental group at  $\infty$  of that end. We shall not explain what these terms mean, as we only need the following example:

**Example 29.3.3.** If  $N = \text{int}(\bar{N})$  with  $\bar{N}$  a compact topological manifold with boundary, then the ends of  $N$  are tame, in bijection with the path components of  $\partial N$ . The fundamental group  $\pi_1^\infty(\epsilon)$  at  $\infty$  of the end  $\epsilon$  corresponding to  $\partial_i N$  is  $\pi_1(\partial_i(N))$ . In this case the finiteness obstructions vanish.

Let  $\text{CAT} = \text{Diff, PL or Top}$ .

**Theorem 29.3.4** (Siebenmann). *Let  $N$  be a CAT-manifold with empty boundary of dimension  $n \geq 6$ . Then  $N$  is interior of a compact CAT-manifold with boundary  $\bar{N}$  if and only if it has tame ends and for each end  $\epsilon$  the finiteness obstruction  $\sigma(\epsilon) \in \tilde{K}_0(\mathbb{Z}[\pi_1^\infty(\epsilon)])$  vanishes.*

The condition of tameness and the construction of  $\sigma(\epsilon)$  are independent of CAT, only depending on the existence of a sufficiently powerful handle theory, which exists for all smooth and PL manifolds, and for topological manifolds of dimension  $\neq 4$ .

In this case the  $\bar{N}$  is unique up to  $h$ -cobordisms starting at  $\partial\bar{N}$ . In particular, it is unique up to CAT-isomorphism if  $\text{Wh}_1(\pi_1^\infty(\epsilon))$  vanishes for all ends. This uses that the  $h$ -cobordism is also true for  $PL$  or topological manifolds under the usual dimensional restrictions. Note that this includes the following claim:

**Lemma 29.3.5.** *If  $\bar{N}$  is a compact manifold with boundary and  $W$  is an  $h$ -cobordism starting that  $\partial\bar{N}$ , then  $\text{int}(\bar{N})$  is CAT-isomorphic to  $\text{int}(\bar{N} \cup W)$ .*

*Proof.* This is a consequence of an Eilenberg swindle: let  $W^{-1}$  be the inverse of  $W$  — that is,  $W \cup W^{-1} \cong \partial_0(W) \times I$  and  $W^{-1} \cup W \cong \partial_1(W) \times I$  — which exists by the full strength of the  $h$ -cobordism theorem classifying  $h$ -cobordisms in terms of the Whitehead group. The emphasis here is on the word *group*, so inverses exist.

Then we have that

$$\begin{aligned} W \setminus \partial_1(W) &\cong W \cup (\partial_1(W) \times I) \cup (\partial_1(W) \times I) \cup \dots \\ &\cong W \cup (W^{-1} \cup W) \cup (W^{-1} \cup W) \cup \dots \\ &\cong (W \cup W^{-1}) \cup (W \cup W^{-1}) \cup \dots \\ &\cong \partial_0(W) \times [0, \infty) \end{aligned}$$

so that we have

$$\text{int}(\bar{N} \cup W) = \bar{N} \cup (W \setminus \partial_1(W)) \cong \bar{N} \cup (\partial_0(W) \times [0, \infty)) \cong \text{int}\bar{N}. \quad \square$$

*Proof of Lemma 29.3.2.* Suppose that  $F_b$  is homeomorphic to  $M \times \mathbb{R}$  and of dimension  $\geq 6$ . Fix  $m \leq n$  and consider  $\dot{F}_b(m-1, n+1) := p^{-1}((m-1, n+1))$ , the interior of  $F_b(m-1, n+1)$ . As a topological manifold  $F_b$  is the interior of  $M \times [m-1, n+1]$ , so its ends are tame and have vanishing finiteness obstruction. This means that  $\dot{F}_b(m-1, n+1)$  is also the interior of a compact smooth manifold with boundary  $\bar{F}_b(m-1, n+1)$ . Forgetting the smooth structure we obtain a compactification as a topological manifold, which must hence be equal to  $M \times [m-1, n+1]$  up to gluing on  $h$ -cobordisms. This implies that  $\bar{F}_b(m-1, n+1)$  there are two boundary components  $\partial_0\bar{F}_b$  and  $\partial_1\bar{F}_b$ , the inclusions of which into  $\bar{F}_b(m-1, n+1)$  are weak equivalences. This means that  $\bar{F}_b(m-1, n+1)$  is an  $h$ -cobordism, and using Lemma 29.3.5 we may assume it has trivial torsion by gluing on an additional  $h$ -cobordism. By the  $h$ -cobordism theorem it is hence a product, and we conclude that  $\bar{F}_b(m-1, n+1) \cong M' \times [m-1, n+1]$  for some smooth closed manifold  $M'$ .

We now apply the same idea as in Example 29.3.1. Since  $p$  is proper, the subset  $p^{-1}([m, n])$  is compact in  $M' \times [m-1, n+1]$  and hence contained in  $M' \times [m-1+\epsilon, n+1-\epsilon]$ . Now we pull  $[m-1, m-1+\epsilon]$  over  $[m-1, n+1-\epsilon]$ , with compact support, and take the product with  $\text{id}_M$ . This extends by the identity to a smooth

compactly-supported isotopy of  $F_b$  verifying the fiberwise engulfing condition.  $\square$

**Remark 29.3.6.** Note that it seems as if we have implicitly proven a weak version of the product-structure theorem; if a topological manifold  $M \times \mathbb{R}$  of dimension  $\geq 6$  has a smooth structure  $(M \times \mathbb{R})_\Sigma$  then it is also smoothly a product with  $\mathbb{R}$ . However, in applying the end theorem and  $s$ -cobordism theorem to topological manifolds we rely on a handle theory for topological manifolds, whose existence was proven using the product-structure theorem by Kirby-Siebenmann. So this would be circular.

### *Finishing the proof*

The previous section allows us to remove the technical condition from the statement of the weak bundle theorem:

**Lemma 29.3.7.** *If  $\pi: E \rightarrow B$  is a smooth submersion which is homeomorphic to  $B \times M \times \mathbb{R}$  over compact  $B$  for some closed topological manifold  $M$  of dimension  $\geq 5$ , then for any pair of integers  $m \leq n$  there exists an open subspace  $E_{mn} \subset E$  containing  $B \times M \times [m, n]$  such that  $\pi|_{E_{mn}}: E_{mn} \rightarrow B$  is a smooth manifold bundle.*

Using this we can finish the proof of the Kirby-Siebenmann bundle theorem. We repeat its statement:

**Theorem 29.3.8.** *If  $\pi: E \rightarrow B$  is a smooth submersion that is a topological manifold bundle with dimension of dimension  $\geq 6$ , then it is a smooth manifold bundle.*

*Proof.* Being a smooth manifold bundle is a local condition, so we may assume  $B = D^k$  and that the topological manifold bundle is trivial: there is a homeomorphism  $\varphi: E \cong B \times N$  over  $B$ . We may exhaust the topological manifold  $N$  by compact topological submanifolds  $N_i$  with boundary  $\partial N_i$ .

Let us pick disjoint collar neighborhoods  $\partial N_i \times \mathbb{R}$  for these. Taking  $E_i := \varphi^{-1}(B \times \partial N_i \times \mathbb{R})$ , we obtain a smooth submersion  $\pi: E_i \rightarrow B$  whose total space  $E_i$  is homeomorphic to  $B \times \partial N_i \times \mathbb{R}$ . By the version of the weak bundle theorem there is a smooth manifold bundle  $\tilde{E}_i$  in this containing  $\varphi^{-1}(B \times \partial N_i \times [-1, 1])$ .

Since  $B = D^k$ , this bundle is trivial; letting  $U_i$  denote the fiber of  $\tilde{E}_i$  over the origin, we get a diffeomorphism between  $\tilde{E}_i$  and  $B \times U_i$  over  $B$ . Identifying  $U_i$  with a subset of  $\partial N_i \times \mathbb{R}$  through  $\varphi$  and projecting to  $\mathbb{R}$ , we get a continuous function  $p: U_i \rightarrow \mathbb{R}$  which takes values in  $[-1, 1]$  only on  $U_i \cap (\partial N_i \times [-1, 1])$ . Perturb with support in  $U_i \cap (\partial N_i \times [-1, 1])$  to a real-valued function  $\tilde{p}_i$  which is smooth on  $\tilde{p}_i^{-1}((-1/2, 1/2))$  and has 0 as a regular value. We get  $A_i :=$



$\tilde{p}_i^{-1}(0)$  a smooth compact submanifold of  $U_i$ . This is the boundary of the smooth manifold  $M_i$  with boundary obtained as the union of  $\tilde{p}_i^{-1}((-\infty, 0])$  and  $\varphi^{-1}(B \times (N_i \setminus \partial N_i \times (-\infty, -2]))$ .

Using the  $M_i$  we get an exhaustion of  $E$  by compact subsets  $E_i$ , whose boundaries are trivialisable manifold bundles. Then we may apply a version of the Ehresmann fibration theorem for smooth submersion  $\pi|_{E_i \setminus \text{int}(E_{i-1})}: E_i \setminus \text{int}(E_{i-1}) \rightarrow B$  to see that it is a smooth manifold bundle with boundary. Trivializing them and glueing, we obtain a diffeomorphism of  $E$  with  $B \times F_0$  over  $B$ . These give the bundle charts exhibiting  $\pi: E \rightarrow B$  as a smooth manifold bundle.  $\square$



## Flexibility and smoothing theory

Today we finish the proof of smoothing theory by using the Kirby-Siebenmann bundle theorem to show that the functor  $U \mapsto \text{Sm}(U)$  assigning to a topological  $n$ -manifold its space of smooth structures, fits into Gromov's framework of flexible invariant sheaves.

**Convention 30.0.1.** In this section we assume all dimensions are  $\geq 6$ .

### 30.1 The space of smooth structures

The bundle theorem is meant to be applied to the following object:

**Definition 30.1.1.** For  $U$  a topological manifold, let  $\text{Sm}(U)$  be the simplicial set with  $k$ -simplices a smooth submersion  $\pi: E \rightarrow \Delta^k$  together with a homeomorphism  $\varphi: E \rightarrow \Delta^k \times U$  over  $\Delta^k$ . We call it the *space of smooth structures on  $U$* .

The bundle theorem then implies that for a  $k$ -simplex  $(E, \pi, \varphi)$ , there is a diffeomorphism  $E \cong \Delta^k \times U_\Sigma$  over  $\Delta^k$  with  $U_\Sigma$  some smooth structure on  $U$ , as any smooth manifold bundle over a compact base is trivializable.

Given a smooth manifold  $M$ , we get a map  $\text{Sing}(\text{Homeo}(M)) \rightarrow \text{Sm}(M)$  by sending a  $k$ -simplex  $h$  to  $(\Delta^k \times M, \pi_1, h)$ . We just saw that all  $k$ -simplices are of this form up to diffeomorphism over  $\Delta^k$ . From this we conclude that if  $\text{Sm}(M)_{\Sigma_0}$  denotes those simplices whose fibers are diffeomorphic to  $M$  (a union of path components), then there is a weak equivalence of simplicial sets

$$\text{Sm}(M)_{\Sigma_0} \cong \text{Sing}(\text{Homeo}(M))/\text{SDiff}(M).$$

Since the latter is a quotient of a simplicial group by a simplicial subgroup, we conclude that  $\text{Sm}(M)$  is Kan, justifying the use of the word "space." More importantly, as  $\text{Sing}(\text{Homeo}(M))/\text{SDiff}(M)$  is a model for the homotopy fiber of  $B\text{Diff}(M) \rightarrow B\text{Homeo}(M)$ , we conclude that:

Takeaways:

- Given standard machinery, the Kirby-Siebenmann bundle theorem is the essential ingredient to smoothing theory.
- The conclusion is that for an  $n$ -dimensional manifold with boundary  $M$ ,  $\text{Sm}_\partial(M)$  is weakly equivalent to the space of sections of a bundle with fiber  $\text{Top}(n)/O(n)$  over  $M$  that are equal to the point  $O(n)/O(n)$  over  $\partial M$ .
- In particular  $B\text{Diff}_\partial(D^n)$  is weakly equivalent to a component of  $\Omega^n \text{Top}(n)/O(n)$ .

**Corollary 30.1.2.** *We have that  $\text{hofib}(B\text{Diff}(M) \rightarrow B\text{Homeo}(M))$  is weakly equivalent a union of path components of  $\text{Sm}(M)$ .*

In the next lecture we will explain how the bundle theorem implies an  $h$ -principle for  $\text{Sm}(-)$ . This gives a homotopy-theoretic descriptions of  $\text{Sm}_\partial(M)$  in terms of  $\text{Sm}(\mathbb{R}^m)$ . Let  $\text{Top}(m)$  denote the topological group of homeomorphisms of  $\mathbb{R}^m$  in the compact-open topology.

**Lemma 30.1.3.** *We have that  $\text{Sm}(\mathbb{R}^m) \simeq \text{Top}(m)/O(m)$ .*

*Proof.* There is a unique smooth structure on  $\mathbb{R}^m$  (recall  $m \geq 6$  was assumed). This means we have that  $\text{Sm}(\mathbb{R}^m)$  is weakly equivalent to the quotient  $\text{Homeo}(\mathbb{R}^m)/\text{Diff}(\mathbb{R}^m)$ . Now we substitute the notation  $\text{Top}(m) := \text{Homeo}(\mathbb{R}^m)$  and recall that in Lecture 8 we proved that  $\text{Diff}(\mathbb{R}^m) \simeq O(m)$ .  $\square$

There are also relative versions when the boundary has a fixed smooth structure, all submersions are trivialized on the boundary, and all diffeomorphisms and homeomorphisms fix the boundary pointwise. We will explore this in more detail in the next lecture, but we state this now for the following example:

**Lemma 30.1.4.** *We have that  $\text{Sm}_\partial(D^m)_0 \simeq B\text{Diff}_\partial(D^m)$ .*

*Proof.* This follows from the fact that  $\text{Homeo}_\partial(D^m)$  is contractible by the Alexander trick.  $\square$

In particular, the promised homotopy theorem description of  $\text{Sm}_\partial(D^m)$  in terms of  $\text{Sm}(\mathbb{R}^m) \simeq \text{Top}(m)/O(m)$  will give the link between diffeomorphisms of disks and homeomorphisms of Euclidean space promised by smoothing theory.

## 30.2 Flexible sheaves

We shall fit  $\text{Sm}(-)$  into a framework of Gromov [Gro86]. We start by recording the functoriality of  $\text{Sm}(U)$  in  $U$ . If  $U$  and  $V$  are topological manifolds of the same dimension with empty boundary, the space  $\text{Emb}^{\text{lf}}(U, V)$  of topological embeddings is the simplicial set with  $k$ -simplices given by a map  $\Delta^k \times U \rightarrow \Delta^k \times V$  over  $\Delta^k$  that is a homeomorphism onto its image. No locally flatness assumptions play a role because we are in codimension 0, but it is good to remember that in positive codimension they do.

**Definition 30.2.1.** Let  $\text{Mfd}_n^{\text{Top}}$  be the simplicially enriched category with objects  $n$ -dimensional topological manifolds with empty boundary, and morphisms from  $U$  to  $V$  the simplicial set  $\text{Emb}^{\text{lf}}(U, V)$ .

We remark that pullback along the embedding makes  $\text{Sm}(U)$  into a continuous functor

$$\begin{aligned} \text{Sm}: (\text{Mfd}_n^{\text{Top}})^{\text{op}} &\rightarrow \text{sSet} \\ U &\mapsto \text{Sm}(U). \end{aligned}$$

Since the conditions on smooth submersions and homeomorphisms are local, a  $k$ -simplex of  $\text{Sm}(U)$  is uniquely determined by its restrictions to an open cover  $\mathcal{U} = \{U_i\}$  of  $U$ . That is, the diagram

$$\text{Sm}(U) \longrightarrow \prod_i \text{Sm}(U_i) \rightrightarrows \prod_{i,j} \text{Sm}(U_i \cap U_j)$$

is an equalizer diagram. In other words,  $\text{Sm}$  satisfies the sheaf property.

**Definition 30.2.2.** A continuous functor

$$\Psi: (\text{Mfd}_n^{\text{Top}})^{\text{op}} \rightarrow \text{sSet}$$

satisfying the sheaf property is called a *invariant sheaf on topological  $n$ -manifolds*.

We may produce relative versions of the values of  $\text{Sm}$  or any invariant sheaf  $\Psi$  on topological  $n$ -manifolds. To do so, let  $A \subset U$  be a closed subset and define  $\Psi(A \subset U)$  to be colimit over all open subsets  $V$  of  $U$  containing  $A$  of  $\Psi(V)$ . This is called the *space of germs of  $\Psi$  near  $A$* . There is a canonical map  $\rho_A: \Psi(U) \rightarrow \Psi(A \subset U)$  and for  $a \in \Psi(A \subset U)$  we define

$$\Psi(U \text{ rel } (a, A)) := \rho_A^{-1}(a) \subset \Psi(U),$$

the subspace of elements equal to  $a$  near  $A$ .

**Definition 30.2.3.** A invariant sheaf on topological  $n$ -manifolds  $\Psi$  is said to be *flexible* if for all compact subsets  $L \subset K$  in  $U$ , the map

$$\Psi(K \subset U) \rightarrow \Psi(L \subset U)$$

is a Kan fibration.

Using the observation that for any compact pair  $(K, L)$  and open subsets  $(V, W)$  containing  $(K, L)$  there is a finite pair of handlebodies  $(N, P)$  such that  $K \subset N \subset V$  and  $L \subset P \subset W$ , and doing an induction of handles, one proves the following lemma:

**Lemma 30.2.4.**  $\Psi$  is flexible if and only if for all  $0 \leq i \leq n$  the map  $\Psi(D^i \times D^{n-i} \subset \mathbb{R}^n) \rightarrow \Psi(\partial D^i \times D^{n-i} \subset \mathbb{R}^n)$  is a Kan fibration.

**Proposition 30.2.5.** When the Kirby-Siebenmann bundle theorem holds,  $\text{Sm}$  is flexible.

*Proof.* A diagram

$$\begin{array}{ccc} \Lambda_i^j & \longrightarrow & \Psi(D^i \times D^{n-i} \subset \mathbb{R}^n) \\ \downarrow & & \downarrow \\ \Delta^j & \longrightarrow & \Psi(\partial D^i \times D^{n-i} \subset \mathbb{R}^n) \end{array}$$

is given by the data of an open  $U_0 \subset \mathbb{R}^n$  containing  $D^i \times D^{n-i}$  and an open  $U_1 \subset \mathbb{R}^n$  containing  $\partial D^i \times D^{n-i}$ , a manifold bundle  $E_0 \rightarrow \Lambda_i^j$  with fiber  $U_0$  and a manifold bundle  $E_1 \rightarrow \Delta^j$  with fiber  $U_1$ . Without loss of generality  $E_0$  both are trivial, since  $\Lambda_i^j$  and  $\Delta^j$  are contractible.

In that case we are asked to extend the bundle  $\Lambda_i^j \times U_0$  to  $\Delta^j$ , compatibly with the given extension of  $\Lambda_i^j \times U_1$  to  $\Delta^j \times U_1$ . But of course the trivial bundle  $\Delta^j \times U_0$  will do.  $\square$

This also implies that restriction maps between relative versions are Kan fibrations, using the following lemma:

**Lemma 30.2.6.** *If in a commutative diagram of simplicial sets*

$$\begin{array}{ccc} A & \longrightarrow & B \\ \downarrow & & \downarrow \\ C & \longrightarrow & D \end{array}$$

*all maps are Kan fibrations, the induced map on fibers of the vertical maps is also a Kan fibration.*

### 30.3 Flexibility and $h$ -principles

The flexibility condition is exactly what is necessary to do handle induction arguments. The easiest version uses the existence of handle decompositions, so we will assume that  $n \neq 4$  in which case Kirby and Siebenmann proved the existence of handle decompositions for topological  $n$ -manifolds. See Appendix V.A of [KS77] for an explanation how to avoid this, using a technique due to Lashof [Las70a, Las70b].

The following is the general version of a handle induction argument.

**Proposition 30.3.1.** *If  $n \neq 4$  and  $j: \Psi \rightarrow \Phi$  is a morphism of flexible invariant sheaves on topological  $n$ -manifolds, then*

$$j: \Psi(M \text{ rel } (k, K)) \rightarrow \Phi(M \text{ rel } (j(k), K))$$

*is a weak equivalence for all compact topological  $n$ -manifolds  $M, K \subset M$  compact and  $k \in \Psi(K \subset M)$  a germ, if and only if  $\Psi(\mathbb{R}^n) \rightarrow \Phi(\mathbb{R}^n)$  is a weak equivalence.*

*Proof.* As in Lemma 30.2.4 one reduces to the case where  $K$  is a handlebody  $N$ . We may take a finite handle decomposition of  $M$  extending that of  $N$ . The proof proceeds by induction over the number of handles in  $M$  that are not in  $N$ . For the induction step, if the filtration by handles is given by  $M_0 = N \subset M_1 \subset M_2 \subset \dots \subset M_k = M$  consider the pair of fiber sequences

$$\begin{array}{ccc} \Psi(M \text{ rel } (c_j, M_j)) & \xrightarrow{\simeq} & \Phi(M \text{ rel } (j(c_j), M_j)) \\ \downarrow & & \downarrow \\ \Psi(M \text{ rel } (c_{j-1}, M_{j-1})) & \longrightarrow & \Phi(M \text{ rel } (j(c_{j-1}), M_{j-1})) \\ \downarrow & & \downarrow \\ \Psi(D^{i_j} \times D^{n-i_j} \text{ rel } (c_j, \partial D^{i_j} \times D^{n-i_j})) & \longrightarrow & \Phi(D^{i_j} \times D^{n-i_j} \text{ rel } (j(c_j), \partial D^{i_j} \times D^{n-i_j})) \end{array}$$

where the top map is a weak equivalence by the inductive hypothesis. This reduces to the case of a single handle  $M = D^i \times D^{n-i}$  and  $K = \partial D^i \times D^{n-i}$ .

This case is proven by induction over  $i$ , and it shall be convenient to replace disks by cubes. Then there is a fiber sequence

$$\begin{array}{c} \Psi(I^i \times I^{n-i} \text{ rel } (c, \partial I^i \times I^{n-i} \cup I^i \times ([0, 1/2] \cup \{1\}) \times I^{n-i-1})) \\ \downarrow \\ \Psi(I^i \times I^{n-i} \text{ rel } (c, \partial I^i \times I^{n-i} \cup I^i \times \{1\} \times I^{n-i-1})) \\ \downarrow \\ \Psi(I^i \times [0, 1/2] \times I^{n-i-1} \text{ rel } (c, \partial I^i \times [0, 1/2] \times I^{n-i-1})) \end{array}$$

with base isomorphic to  $\Psi(I^i \times I^{n-i} \text{ rel } (c, \partial I^i \times I^{n-i}))$ , total space weakly contractible and fiber isomorphic to  $\Psi(I^{i+1} \times I^{n-i-1} \text{ rel } (c, \partial I^{i+1} \times I^{n-i-1}))$ . There is a similar fiber sequence for  $\Phi$  and using these identifications, we get a map of fiber sequence

$$\begin{array}{ccc} \Psi(I^{i+1} \times I^{n-i-1} \text{ rel } (c, \partial I^{i+1} \times I^{n-i-1})) & \longrightarrow & \Phi(I^{i+1} \times I^{n-i-1} \text{ rel } (c, \partial I^{i+1} \times I^{n-i-1})) \\ \downarrow & & \downarrow \\ * & \xrightarrow{\simeq} & * \\ \downarrow & & \downarrow \\ \Psi(I^i \times I^{n-i} \text{ rel } (c, \partial I^i \times I^{n-i})) & \xrightarrow{\simeq} & \Phi(I^i \times I^{n-i} \text{ rel } (c, \partial I^i \times I^{n-i})), \end{array}$$

with map on bases a weak equivalence by the inductive hypothesis (the initial case  $i = 0$  being the assumption of the proposition), so that the map on fibers is also a weak equivalence.  $\square$

So when one has a flexible invariant sheaf  $\Psi$ , the trick is finding a zigzag of morphisms between flexible invariant sheaves with weakly

equivalent values on  $\mathbb{R}^n$ , to a more easily understood one. Gromov provided a universal map

$$j: \Psi \rightarrow \Psi^f$$

which induces a weak equivalence on  $\mathbb{R}^n$ , and proved that the values of  $\Psi^f$  may be computed in terms of homotopy theory. The answer involves the topological version of the frame bundle of the tangent bundle: by the Kister-Mazur theorem there is a principal  $\text{Top}(n)$ -bundle  $\text{Fr}^{\text{Top}}(M)$  over  $M$  unique up to isomorphism. Since homeomorphisms are in particular embeddings, we have an action of  $\text{Top}(n)$  on  $\Psi(\mathbb{R}^n)$ .

**Lemma 30.3.2.** *Given a topological manifold  $M$  and a choice of  $\text{Fr}^{\text{Top}}(M)$ , there is a weak equivalence*

$$\Psi^f(M \text{ rel } (m, \partial M)) \simeq \Gamma_{\partial M}(M, \text{Fr}^{\text{Top}}(M) \times_{\text{Top}(n)} \Psi(\mathbb{R}^n)).$$

This may be simplified if  $M$  admits a smooth structure, since then we may use the orthonormal frame bundle  $\text{Fr}^{\text{O}}(M)$  to get  $\text{Fr}^{\text{Top}}(M) \cong \text{Fr}^{\text{O}} \times_{\text{O}(n)} \text{Top}(n)$  and thus

$$\text{Fr}^{\text{Top}}(M) \times_{\text{Top}(n)} \Psi(\mathbb{R}^n) \cong \text{Fr}^{\text{O}}(M) \times_{\text{O}(n)} \Psi(\mathbb{R}^n).$$

**Remark 30.3.3.** I did not go into much detail because the current construction is a bit unsatisfactory (requiring us to move away from simplicial sets, for example). Someone should redo Gromov's theory using  $\infty$ -categories.

#### *Morlet's theorem*

Applying the general  $h$ -principle technology to  $\text{Sm}(-)$  and recalling the identification  $\text{Sm}(\mathbb{R}^n) \simeq \text{Top}(n)/\text{O}(n)$  from the last lecture, we obtain the following result:

**Theorem 30.3.4.** *For all topological manifolds  $M$  of dimension  $n \neq 4$  there is a weak equivalence*

$$\text{Sm}(M) \simeq \Gamma_{\partial M}(M, \text{Fr}^{\text{Top}}(M) \times_{\text{Top}(n)} \text{Top}(n)/\text{O}(n))$$

and the left hand side may be identified with a disjoint union of  $\text{Homeo}_{\partial}(M)/\text{Diff}_{\partial}(M_{\Sigma})$  over smooth structures  $\Sigma$  of  $M$  up to concordance.

**Remark 30.3.5.** Kirby-Siebenmann avoid Lemma 30.3.2 by producing a length 4 zigzag of geometric spaces connecting the left and right hand sides of Theorem 30.3.4.

As a corollary of the Alexander trick  $\text{Homeo}_{\partial}(D^n) \simeq *$ , we obtain the promised identification of  $B\text{Diff}_{\partial}(D^n)$ :

**Corollary 30.3.6** (Morlet). *If  $n \neq 4$  there is a weak equivalence*

$$B\text{Diff}_{\partial}(D^n) \cong \Omega_0^n \text{Top}(n)/\text{O}(n).$$



*Another description of  $A(*)$* 

Note that combined with the results of the algebraic  $K$ -theory part, this establish a direct link between homeomorphisms of  $\mathbb{R}^n$  for  $n$  odd and algebraic  $K$ -theory of the integers. Using this, Waldhausen gave a different expression for  $A(*)$ , see page 15 of [Wal82]. Note that there is a map

$$S^1 \times \text{Top}(n) \rightarrow \text{Top}(n+1)$$

induced by  $\text{id}_{\mathbb{R}^{n-1}} \times \text{rot}_\theta$ . This sends  $\{1\} \times \text{Top}(n) \cup S^1 \times \text{Top}(n-1)$  into  $\text{Top}(n)$ , so that there is an induced map

$$\Sigma(\text{Top}(n)/\text{Top}(n-1)) \rightarrow \text{Top}(n+1)/\text{Top}(n),$$

making  $(\text{Top}(n+1)/\text{Top}(n))_{n \geq 0}$  into a spectrum.

**Theorem 30.3.7** (Waldhausen). *The spectrum  $(\text{Top}(n+1)/\text{Top}(n))_{n \geq 0}$  is weakly equivalent to  $\underline{A}(*)$ .*



## **Part VI**

# **Homological stability and cobordism categories**



## Homological stability for symmetric groups

Symmetric groups are the diffeomorphisms groups of compact 0-dimensional manifolds. Indeed, any such manifold is diffeomorphic to a disjoint union of finitely points and all permutations are diffeomorphisms. Today we will study their homology, as practice for studying the homology of diffeomorphism groups of higher-dimensional manifolds later.

Takeaways:

- We prove that the homology of the symmetric group  $\mathfrak{S}_n$  is independent of  $n$  in a range, by studying its action on a highly-connected semi-simplicial set.
- Alternatively, one may combine a transfer argument with the Barratt-Priddy-Quillen-Segal theorem.

### 31.1 Quillen's stability argument

The symmetric group  $\mathfrak{S}_n$  is the group of automorphisms of the finite set  $\{1, \dots, n\}$ . Thus the inclusion  $\{1, \dots, n\} \hookrightarrow \{1, \dots, n+1\}$  induces a homomorphism

$$\sigma: \mathfrak{S}_n \hookrightarrow \mathfrak{S}_{n+1}.$$

We claim that this sequence of groups and homomorphisms has a property called homological stability:

(\*) The relative groups  $H_*(B\mathfrak{S}_{n+1}, B\mathfrak{S}_n)$  of  $\sigma$  vanish if  $* \leq n/2$ . More concretely, the map  $\sigma_*: H_*(B\mathfrak{S}_n) \rightarrow H_*(B\mathfrak{S}_{n+1})$  is a surjection for  $* \leq n/2$  and an isomorphism for  $* \leq n/2 - 1$ .

We shall use a strategy of Quillen, which he never published as far as I know, but which appears in his 1974-I notebook [Qui]. A general machinery for these types of arguments is worked out in [RWW17].

The strategy is to prove the statement (\*) by induction over  $n$ . The statement is trivial for  $n = 0$ . For the induction step from  $n - 1$  to  $n$  we shall find a semi-simplicial set  $I_\bullet(n)$  with  $\mathfrak{S}_n$ -action satisfying a number of good properties. A *semi-simplicial set* is simply a simplicial set without degeneracies, i.e. substituting for  $\Delta$  the subcategory  $\Delta_{\text{inj}}$  with only injective maps. We may take its thick geometric realization

$$\|I_\bullet(n)\| := \left( \bigsqcup_{p \geq 0} \Delta^p \times I_p(n) \right) / \sim$$

**Example 31.1.1.** The first time the abelianization is non-trivial is  $H_1(B\mathfrak{S}_2) \cong \mathbb{Z}/2\mathbb{Z}$ . In this case, we indeed have that  $H_1(B\mathfrak{S}_1) \rightarrow H_1(B\mathfrak{S}_2)$  is not surjective yet, as  $(2-1)/2 < 1$ , while  $H_1(B\mathfrak{S}_2) \rightarrow H_1(B\mathfrak{S}_3)$  is predicted to be surjective.

and take the homotopy quotient by  $\mathfrak{S}_n$  to obtain a space  $\|I_\bullet(n)\| // \mathfrak{S}_n$ .

The space  $\|I_\bullet(n)\|$  is visibly a CW-complex and hence we may filter it by skeleta. Since homotopy quotients and geometric realization commute up to weak equivalence, we have that  $\|I_\bullet(n)\| // \mathfrak{S}_n \simeq \|I_\bullet(n) // \mathfrak{S}_n\|$ . Our first assumption on  $I_\bullet(n)$  shall be:

- (a) The group  $\mathfrak{S}_n$  acts transitively on each set  $I_p(n)$ . This implies that  $I_p(n) // \mathfrak{S}_n$  is the classifying space of the subgroup  $\text{Stab}_{\mathfrak{S}_n}(x_p)$  of  $\mathfrak{S}_n$ , for  $x_p$  any element of  $I_p(n)$ .

We thus get a spectral sequence

$$E_{pq}^1 = H_q(B\text{Stab}_{\mathfrak{S}_n}(\{1, \dots, p+1\})) \implies H_{p+q}(\|I_\bullet(n)\| // \mathfrak{S}_n),$$

with differential given by  $\sum_i (-1)^i (d_i)_*$ . It is slightly more convenient to work relative to the map to  $* // \mathfrak{S}_n = B\mathfrak{S}_n$ , in which the spectral sequence looks like:

$$E_{pq}^1 = \begin{cases} H_q(B\text{Stab}_{\mathfrak{S}_n}(\{1, \dots, p+1\})) & \text{if } p \geq 0 \\ H_p(B\mathfrak{S}_n) & \text{if } p = -1 \Rightarrow H_{p+q+1}(B\mathfrak{S}_n, \|I_\bullet(n)\| // \mathfrak{S}_n), \\ 0 & \text{if } p < -1 \end{cases} \quad (31.1)$$

with additional  $d^1$ -differential  $d^1: E_{0q}^1 \rightarrow E_{-1,q}^1$  induced by  $\sigma_*$ .

To make (31.1) useful, we need to establish additional properties:

- (b)  $\|I_\bullet(n)\|$  is  $(n-2)$ -connected. This implies  $\|I_\bullet(n)\| // \mathfrak{S}_n \rightarrow * // \mathfrak{S}_n = B\mathfrak{S}_n$  is  $(n-1)$ -connected, so that the spectral sequence converges vanishes in the range  $* \leq n-2$ .
- (c) The stabilizer of a  $p$ -simplex  $x_p \in I_p(n)$  is isomorphic to  $\mathfrak{S}_{n-p-1}$ . This implies that the  $E^1$ -page contains the homology of previous symmetric groups.
- (d) All maps  $d_i: B\mathfrak{S}_{n-p-1} \rightarrow B\mathfrak{S}_{n-p}$  are induced by homomorphisms  $\mathfrak{S}_{n-p-1} \rightarrow \mathfrak{S}_{n-p}$  which are conjugate to the stabilization map. This implies  $\sum_i (-1)^i (d_i)_*$  is 0 if  $p$  is odd and the map induced by the  $\sigma$  if  $p$  is even, because conjugate maps induce homotopic maps on the bar construction.

The resulting  $E^1$ -page can be seen in Figure 31.1. By the inductive hypothesis, for  $p > 0$  the horizontal maps in the commutative diagram

$$\begin{array}{ccc} H_*(B\mathfrak{S}_{n-2p-1}) & \xrightarrow{\sigma_*} & H_*(B\mathfrak{S}_{n-2p}) \\ \downarrow \cong & & \downarrow \cong \\ E_{2p,q}^1 & \xrightarrow{d^1} & E_{2p-1,q}^1 \end{array}$$

are surjective for  $q \leq \frac{n-2p-1}{2}$  and an isomorphism for  $q \leq \frac{n-2p-1}{2} - 1$ . Thus apart from the  $(-1)$ st and 0th column, the  $E^2$ -page vanishes in a range below a line of slope  $1/2$ , see Figure 31.2. Thus these

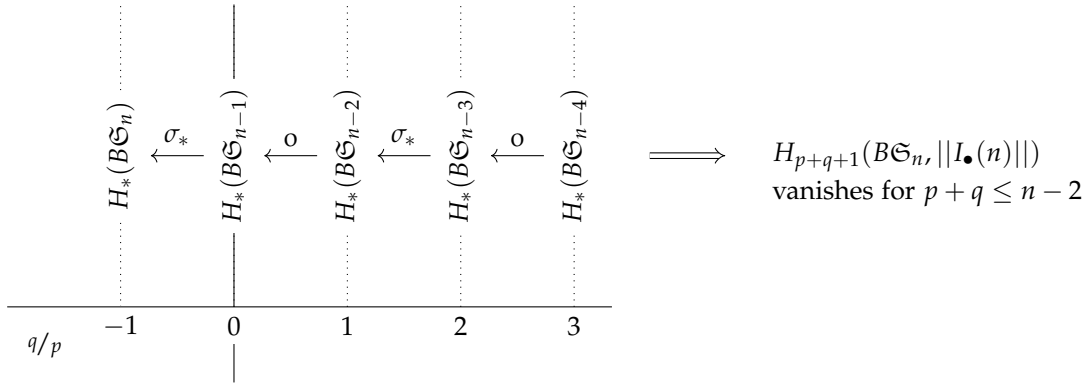

Figure 31.1: The  $E^1$ -page of (31.1) with properties (a)–(d) filled in.

groups can't serve as the domain of a higher differential to kill what remains on the  $(-1)$ st and  $0$ th column for  $q \leq \frac{n-1}{2}$  and  $q \leq \frac{n-1}{2} - 1$  respectively. This is enough to show that the the map

$$d^1 = \sigma_* : H_*(B\mathfrak{S}_{n-1}) \cong E_{0q}^1 \rightarrow E_{-1,q}^1 \cong H_*(B\mathfrak{S}_n)$$

must have been an isomorphism for  $q \leq \frac{n-1}{2} - 1$  and a surjection for  $q \leq \frac{n-1}{2}$ . This finishes the proof of the homological stability argument, up to establishing properties (a)–(d).

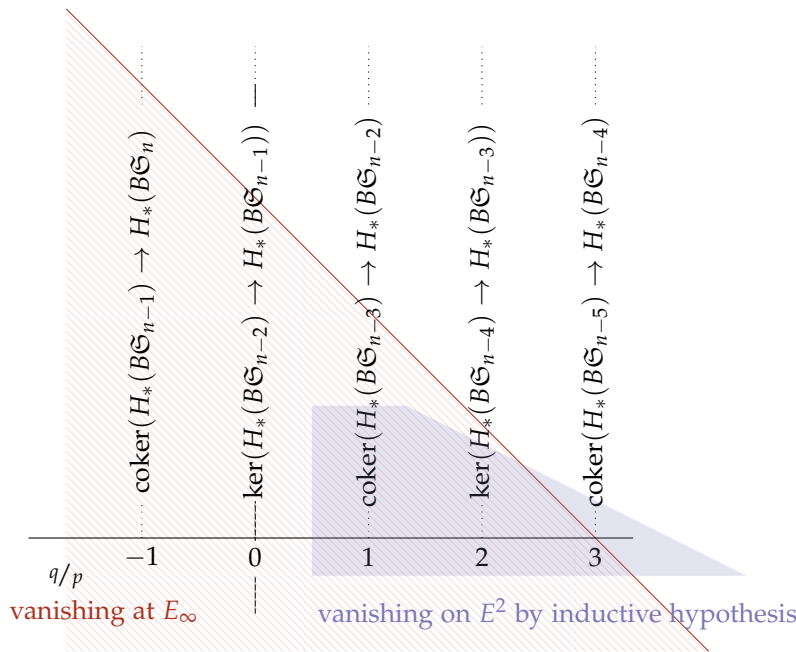

Figure 31.2: An illustrative  $E^2$ -page of (31.1).

### 31.2 Injective words

The  $p$ -simplices semi-simplicial set  $I_\bullet(n)$  is supposed to encode the “ways to undo  $(p + 1)$ -fold stabilization.” Of course there is no

canonical such way, but there is once we have picked  $(p + 1)$  elements of  $\{1, \dots, n\}$ . The complex of injective words should be thought of as the space of such choices and homotopies between them.

**Definition 31.2.1.** The semi-simplicial set  $I_\bullet(n)$  of *injective words* has  $p$ -simplices given by the set of injective maps  $[p] = \{0, \dots, p\} \rightarrow \{1, \dots, n\}$ . We shall write a  $p$ -simplex as  $(m_0, \dots, m_p)$ .

Property (a) is obvious, and for (c) we identify the stabilizer of  $(m_0, \dots, m_p)$  with the permutations of  $\{1, \dots, n\}$  fixing  $\{m_0, \dots, m_p\}$  pointwise, which is isomorphic to  $\mathfrak{S}_{n-p-1}$ . Then (d) amounts to checking whether the inclusions of  $\mathfrak{S}_{n-p-1}$  into  $\mathfrak{S}_{n-p}$  corresponding to different  $(n - p - 1)$ -element subsets are conjugate, and of course they are. Thus it remains to establish (b). This is again an inductive argument.

Let's do some initial cases as practice. Firstly, for  $n = 1$  the semi-simplicial set  $I_\bullet(1)$  has a single 0-simplex and no high simplices, so its geometric realization is non-empty, i.e.  $(1 - 2) = (-1)$ -connected. For  $n = 2$ ,  $I_\bullet(2)$  has two 0-simplices,  $(0)$  and  $(1)$ , which are connected by two 1-simplices  $(0, 1)$  and  $(1, 0)$ , so  $\|I_\bullet(2)\|$  is a circle and in particular 0-connected. See Figure 31.3. Similarly, for  $n \geq 2$  we can connect any two 0-simplices with a 1-simplex and  $\|I_\bullet(n)\|$  is path-connected.

**Lemma 31.2.2.** For  $n \geq 3$ ,  $I_\bullet(n)$  is simply-connected.

*Proof.* Its fundamental groupoid has objects  $(n)$ , has generating morphisms  $\gamma_{mn}$  for  $m \neq n$ . Each 2-simplex is given by  $(m, n, \ell)$  for  $m, n, \ell$  distinct, and encodes a relation  $\gamma_{n\ell}\gamma_{mn} = \gamma_{m\ell}$ . However, it is clear that using these equations we can shorten any loop until we reach a term of the form  $\gamma_{mn}\gamma_{nm}$ . For convenience take  $n = 1, m = 3$ . Then we have equations

$$\gamma_{31}\gamma_{13} = \gamma_{31}\gamma_{32}^{-1}\gamma_{12} = \text{id}_1$$

where the first comes from  $\gamma_{12} = \gamma_{32}\gamma_{13}$ , and the second comes from  $\gamma_{12}\gamma_{31} = \gamma_{32}$  upon multiplying by  $\gamma_{32}^{-1}$  from the right and conjugating by  $\gamma_{12}^{-1}$ . □

By the previous lemma, for proving the desired connectivity when  $n \geq 3$  it suffices to prove that the homology vanishes in a range. Latter, you may think through the argument in the previous section, and realize we only needed acyclicity of  $\|I_\bullet(n)\|$ .

**Lemma 31.2.3.**  $\tilde{H}_*(\|I_\bullet(n)\|)$  vanishes for  $* \leq n - 2$ .

*Proof.* The proof is by induction over  $n$ . Let  $C_*(I_\bullet(n))$  denote the augmented simplicial chains (i.e.  $\mathbb{Z}$  in degree  $-1$  and  $\mathbb{Z}[I_p(n)]$  in degree  $p$ ), so that  $H_*(C_*(I_\bullet(n))) \cong \tilde{H}_*(\|I_\bullet(n)\|)$ .

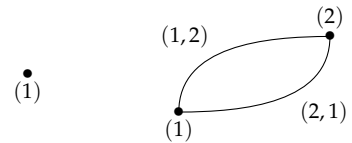

$\|I_\bullet(1)\|$

$\|I_\bullet(2)\|$

Figure 31.3: The geometric realization  $\|I_\bullet(n)\|$  for  $n = 1, 2$ .



Define an increasing filtration  $F_c C_*(I_\bullet(n))$  of  $C_*(I_\bullet(n))$  by letting  $F_c$  to be the span of those  $p$ -simplices such that none of the last  $p + 1 - c$  elements  $(m_c, \dots, m_p)$  in a  $p$ -simplex  $(m_0, \dots, m_p)$  is  $n$ . Then  $F_0 = C_*(I_\bullet(n-1))$ , and  $F_c/F_{c-1}$  is a direct sum over all  $c$ -element initial segments  $(m_0, \dots, m_{c-2}, n)$  of  $C_{*-c}(I_\bullet(n-c))$ .

Thus we obtain a spectral sequence converging to  $\tilde{H}_*(||I_\bullet(n)||)$  with  $E^1$ -page vanishing in degrees  $q \leq n-3$  for  $p=0$  and  $q \leq n-p-2$  for  $p \geq 1$ . We directly obtain that  $\tilde{H}_*(||I_\bullet(n)||)$  vanishes for  $* \leq n-3$ . The only group that can contribute to  $* = n-2$  is  $\tilde{H}_{n-2}(||I_\bullet(n-1)||)$ . But the inclusion  $||I_\bullet(n-1)|| \rightarrow ||I_\bullet(n)||$  is null-homotopic by using the element  $n$  to cone it off.  $\square$

### 31.3 The transfer

Considering the problem of non-uniqueness of unoding stabilization can be approached differently; on homology we can just sum over all choices. This is the transfer map

$$\text{tr}: H_*(B\mathfrak{S}_n) \rightarrow H_*(B\mathfrak{S}_{n-1}).$$

It is constructed explicitly by noting that  $B\mathfrak{S}_n$  has an  $n$ -fold cover with total space  $B\mathfrak{S}_{n-1}$ ; take any contractible space  $E$  with free properly discontinuous  $\mathfrak{S}_n$ -action, and consider the map  $E/\mathfrak{S}_{n-1} \simeq B\mathfrak{S}_{n-1} \rightarrow E/\mathfrak{S}_n \simeq B\mathfrak{S}_n$  with fiber  $\mathfrak{S}_n/\mathfrak{S}_{n-1}$ . Now define a chain map  $C_*(B\mathfrak{S}_n) \rightarrow C_*(B\mathfrak{S}_{n-1})$  by sending a singular simplex in  $B\mathfrak{S}_n$  to the sum of its lifts.

This is an example of a more general transfer map

$$\text{tr}_p: H_*(B\mathfrak{S}_n) \rightarrow H_*(B\mathfrak{S}_{n-p}),$$

construction using an analogous  $n!/(n-p)!$ -fold cover. This satisfies the equation  $\text{tr}_p \circ \sigma_* = \sigma_* \circ \text{tr}_p + \text{tr}_{p-1}$ . The following is Lemma A of [Dol62].

**Lemma 31.3.1** (Dold). *The map*

$$R_n := \bigoplus_{0 \leq p \leq n} \pi \circ \text{tr}_p: H_*(B\mathfrak{S}_n) \rightarrow \bigoplus_{0 \leq p \leq n} H_*(B\mathfrak{S}_{n-p})/\text{im}(\sigma_*)$$

*is an isomorphism.*

*Proof.* The proof is by induction over  $n$ , with the case  $n=0$  being trivial. For the induction step, consider the diagram

$$\begin{array}{ccc} & H_*(B\mathfrak{S}_n) & \\ \sigma_* \nearrow & & \searrow \pi_{>0} \circ R_n \\ H_*(B\mathfrak{S}_{n-1}) & \xrightarrow{R_{n-1}} & \bigoplus_{0 \leq p \leq n-1} H_*(B\mathfrak{S}_{n-1-p})/\text{im}(\sigma_*) \end{array}$$

where  $\pi_{>0}$  projects away the term  $p = 0$ . This commutes since  $\mathrm{tr}_p \circ \sigma_* = \mathrm{tr}_{p-1} \pmod{\mathrm{im}(\sigma_*)}$ . This shows that  $\sigma_*$  has a left inverse, and

$$H_*(B\mathfrak{S}_n) \cong H_*(B\mathfrak{S}_n)/\mathrm{im}(\sigma_*) \oplus \bigoplus_{0 \leq p \leq n-1} H_*(B\mathfrak{S}_{n-1-p})/\mathrm{im}(\sigma_*)$$

is an isomorphism, proving the induction step.  $\square$

With respect to these identifications the map  $\sigma_*$  is just the inclusion of summands. Thus we conclude that  $\sigma_*$  is split injective. If we can show that the stable homology of the symmetric groups is finitely generated in each degree, we obtain a homological stability result without an explicit range; at some point the split injections have to be isomorphisms.

This may be deduced from the identification on  $K(\mathrm{FinSet}_*) \simeq QS^0$  (to be proven in Chapter 32), since we saw that  $K(\mathrm{FinSet}_*) \simeq \Omega B(\bigsqcup_n B\mathfrak{S}_n)$  and thus by the group completion theorem the homology of a component  $Q_0S^0$  equals the stable homology of  $B\mathfrak{S}_n$ .

**Lemma 31.3.2.** *The homology of  $Q_0S^0$  is finitely generated in each degree.*

*Proof.* It suffices to prove that if a path-connected space  $X$  is abelian and has finitely generated homotopy groups in each degree, then its homology is finitely generated in each degree. The abelian condition implies that a Postnikov tower exists, so this may be proven by induction over  $n$  for  $P_n(X)$  (the space only having the first  $n$  homotopy groups non-zero) using the fiber sequences

$$P_n(X) \rightarrow P_{n+1}(X) \rightarrow K(\pi_{n+1}(X), n+2)$$

and the fact that  $H_*(K(\pi_{n+1}(X), n+2))$  is finitely generated in each degree if  $\pi_{n+1}(X)$  is finitely generated abelian.  $\square$

## The Barratt-Priddy-Quillen-Segal theorem

We shall now prove the long promised Barratt-Priddy-Quillen-Segal theorem

$$\Omega B \left( \bigsqcup_{n \geq 0} B\mathfrak{S}_n \right) \simeq QS^0,$$

using cobordism categories [BP72, Seg73], which we announced in Theorem 21.1.6. One should think of this as the 0-dimensional case of results to come. Our proof is modeled on the general scanning approach of [GTMW09, GRW10, Gal11], and [Hat11] gives an expository account.

### 32.1 Compact-open configuration spaces

We shall need a type of configuration space with particles that can disappear at infinity; we shall these *compact-open configuration spaces*, in analogy with the compact-open topology where a sequence of functions converges if and only if converges uniformly on compact subsets.

For  $n \geq 0$  the *unordered configuration spaces* of  $n$  particles in a manifold  $M$  are given by

$$C_n(M) := \text{Emb}(\{1, \dots, n\}, M) / \mathfrak{S}_n.$$

These spaces are closely related to classifying spaces of symmetric spaces when  $M = \mathbb{R}^N$  (or more generally when  $M$  is highly-connected and high-dimensional):

**Lemma 32.1.1.** *There is a  $(N - 1)$ -connected map  $C_n(\mathbb{R}^N) \rightarrow B\mathfrak{S}_n$ .*

*Proof.* Consider the space

$$\text{Emb}(\{1, \dots, n\}, \mathbb{R}^\infty) := \text{colim}_{N \rightarrow \infty} \text{Emb}(\{1, \dots, n\}, \mathbb{R}^N)$$

with free properly discontinuous  $\mathfrak{S}_n$ -action. We claim it is weak contractible. This is proven by noting that a map  $S^i \rightarrow \text{Emb}(\{1, \dots, n\}, \mathbb{R}^\infty)$

Takeaways:

- Unordered onfiguration spaces of Euclidean spaces provide approximations to  $B\mathfrak{S}_n$ .
- The group completion of  $\bigsqcup_{n \geq 0} B\mathfrak{S}_n$  is given by based loops of the classifying space of the 0-dimensional cobordism category.
- By iterated delooping  $BCob(0, N) \simeq \Omega^{N-1}C(\mathbb{R}^N)$ , and the latter is weakly equivalent to  $\Omega^{N-1}S^N$  by a scanning argument.

factors over some  $\text{Emb}(\{1, \dots, n\}, \mathbb{R}^\infty)$ . One then either applies the proof for finite  $N$  below, or just linearly interpolates from a configurations in the image of  $S^i$  to the configuration in  $\mathbb{R}^{N+n}$  with  $i$ th point at  $e_{N+i}$ . The conclusion of these observations is that the quotient space

$$C_n(\mathbb{R}^\infty) := \text{Emb}(\{1, \dots, n\}, \mathbb{R}^\infty) / \mathfrak{S}_n$$

is weakly equivalent to  $B\mathfrak{S}_n$ .

Thus it suffices to show that  $\text{Emb}(\{1, \dots, n\}, \mathbb{R}^N)$  is  $(N - 2)$ -connected, because then the inclusion  $\text{Emb}(\{1, \dots, n\}, \mathbb{R}^N) \hookrightarrow \text{Emb}(\{1, \dots, n\}, \mathbb{R}^\infty)$  is a  $(N - 1)$ -connected map between spaces with a free properly discontinuous  $\mathfrak{S}_k$ -action, and thus the map on quotient spaces be  $(N - 1)$ -connected. To compute the connectivity of  $\text{Emb}(\{1, \dots, n\}, \mathbb{R}^N)$ , note that  $S^i \rightarrow \text{Emb}(\{1, \dots, n\}, \mathbb{R}^N)$  may be extended to a map  $D^{i+1} \rightarrow (\mathbb{R}^N)^n$ . Generically, it is transverse to the fat diagonal  $\{(x_1, \dots, x_n) \mid \exists i, j \text{ such that } x_i = x_j\} \subset (\mathbb{R}^N)^n$ , a finite union of submanifolds of codimension  $N$ . If  $i + 1 < N$  transverse implies disjoint, so that if  $i \leq N - 2$  an  $i$ -sphere of configurations is null-homotopic.  $\square$

We now define a version where particles can disappear outside a subset  $N$ , and then let the size of  $N$  go to infinity. If  $N \subset M$ , we define

$$C(M, M \setminus N) := \left( \bigsqcup_{n \geq 0} C_n(M) \right) / \sim,$$

where two configurations  $\vec{x}$  and  $\vec{y}$  are equivalent if their intersections with  $N$  are equal.

**Definition 32.1.2.** We define  $C(\mathbb{R}^N)$  to be the colimit

$$\text{colim}_{n \rightarrow \infty} C(\mathbb{R}^N, \mathbb{R}^N \setminus B_n(0)),$$

where  $B_n(0) \subset \mathbb{R}^N$  denotes the closed ball of radius  $n$  around the origin. For  $U \subset \mathbb{R}^N$  we let  $C(U)$  be the image of  $\bigsqcup_{n \geq 0} C_n(U)$  in  $C(\mathbb{R}^N)$ .

**Example 32.1.3.** A sequence  $\vec{x}_i \in C(\mathbb{R}^N)$  converges if  $\vec{x}_i \cap B_n(0)$  converges for all  $n$ . Thus the map  $[-1, 1] \rightarrow C(\mathbb{R}^N)$  given by sending  $\pm 1$  to the empty configuration and any other  $t$  to  $(t/(1 - t^2), 0, \dots, 0)$  is continuous. Similar paths to infinity may be used to show that  $C(\mathbb{R}^N)$  is path-connected, connecting each configuration to  $\emptyset$  by moving all particles to infinity. The same path-connectivity statement is true for any codimension zero submanifold  $U \subset \mathbb{R}^N$  such that every path-connected contains a path to infinity.

Using an elaboration of this example we shall prove:

**Lemma 32.1.4.** *We have that  $C(\mathbb{R}^N) \simeq S^N$ , with basepoint given by the empty configuration.*

We shall use the following lemma:

**Lemma 32.1.5.** *If  $U_0 \cup U_1 = X$  is an open cover of  $X$  by two subsets, then the pushout*

$$\begin{array}{ccc} U_0 \cap U_1 & \longrightarrow & U_0 \\ \downarrow & & \downarrow \\ U_1 & \longrightarrow & X \end{array}$$

is also a homotopy pushout.

*Proof.* We use the notion of a *Serre microfibration*. This is a map of spaces  $f: E \rightarrow B$  such in each commutative diagram

$$\begin{array}{ccc} D^i & \xrightarrow{\quad} & E \\ & \searrow & \downarrow \\ & D^i \times [0, \epsilon] & \\ & \swarrow & \downarrow \\ D^i \times [0, 1] & \xrightarrow{\quad} & B \end{array}$$

there exists an  $\epsilon > 0$  and a lift. A Serre microfibration with weakly contractible fibers is a weak equivalence, [Weio5].

Now note that there is the canonical map

$$\pi: \tilde{X} := (U_0 \times \{0\}) \cup (U_0 \cap U_1 \times [0, 1]) \cup (U_1 \times \{1\}) \rightarrow X,$$

with the domain is a standard model for the homotopy pushout. We claim that the canonical map

$$f: U_0 \cup (U_0 \times [0, 1]) \cup U_1 \rightarrow X$$

is a Serre microfibration with contractible fibers. The contractibility of the fibers is obvious; they are either a point or an interval. To see it is a Serre microfibration think of a map  $g: Y \rightarrow U_0 \cup (U_0 \times [0, 1]) \cup U_1$  as a pair  $(g_1, g_2)$  of a map  $g_1: Y \rightarrow X$  and a map  $g_2: Y \rightarrow [0, 1]$  such that  $g_2(y) = 0$  if  $y \in X \setminus U_1$  and  $g_2(y) = 1$  if  $y \in X \setminus U_0$ .

Then given a commutative diagram

$$\begin{array}{ccc} D^i & \xrightarrow{h} & U_0 \cup (U_0 \times [0, 1]) \cup U_1 \\ \downarrow & & \downarrow f \\ D^i \times [0, 1] & \xrightarrow{H} & X \end{array}$$

we define two continuous functions  $\mu: [0, 1] \rightarrow [0, 1/4]$ ,  $\lambda: [0, 1] \rightarrow [3/4, 1]$  (the first non-decreasing, the second non-increasing) by

$$\mu(t) := \max\{h_2(d) \mid d \in h_2(d) \in [0, 1/4] \quad \exists (d, s) \in D^i \times [0, t] \text{ with } H_2(d, s) \in X \setminus U_1\},$$

$$\lambda(t) := \min\{h_2(d) \mid d \in h_2(d) \in [3/4, 1] \exists(d, s) \in D^i \times [0, t] \text{ with } H_2(d, s) \in X \setminus U_0\},$$

thought of as “error terms” measuring to what extent the function  $(d, t) \mapsto (H(d, t), h_2(t))$  fails to land in  $U_0 \cup (U_{01} \times [0, 1]) \cup U_1 \subset X \times [0, 1]$ . The maximum and minimum are taken over a closed hence compact subset of  $D^i$ , so exist. By construction  $\mu(0) = 0$  and  $\lambda(0) = 0$ , and by continuity there exists a  $\epsilon > 0$  such that  $\mu(\epsilon) < 1/4$  and  $\lambda(\epsilon) > 3/4$ . Then we define our partial lift on  $D^i \times [0, \epsilon]$  by first coordinate equal to  $H$  and second coordinate by

$$(d, t) \mapsto \min \left( 0, \max \left( 1, \frac{h_1(d) - \mu(t)}{\lambda(t) - \mu(t)} \right) \right).$$

In words, we modify  $(d, t) \mapsto (H(d, t), h_2(t))$  by translating and scaling the second values enough to overcome the errors.

Now note that fibers of  $\pi$  are either a point or an interval, see Figure 32.1. By Weiss’ Lemma it is hence a weak equivalence.  $\square$

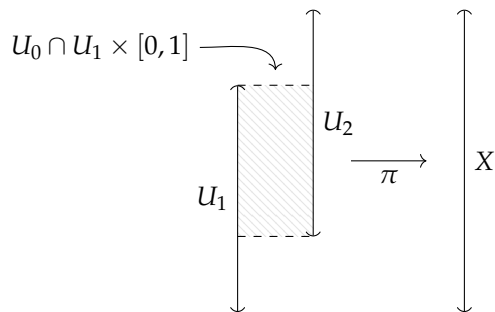

Figure 32.1: The map  $\pi$  of Lemma 34.1.5.

*Proof of Lemma 32.1.4.* There is an open cover of  $C(\mathbb{R}^N)$  by two open subsets:

- (i)  $U_0$  is those configuration with no particle at the origin,
- (ii)  $U_1$  is those configuration with a unique particle closest to the origin.

Then we have that  $U_0$  is contractible by pushing all particles out to infinity, while  $U_1$  is contractible by translating until the unique particle is at the origin and then pushing all remaining particles. Their intersection  $U_0 \cap U_1$  is the subspace of configurations without a particle at the origin but with a unique one closest to the origin. This deformation retracts onto  $S^{N-1}$  by moving the unique one to radius 1 by scaling and then pushing the remaining particles to infinity. We conclude with the help of the previous lemma that  $C(\mathbb{R}^N)$  is weakly equivalent to the homotopy pushout of the diagram

$$\begin{array}{ccc} S^{N-1} & \longrightarrow & * \\ \downarrow & & \\ * & & \end{array}$$

which may be computed by replacing the top and bottom maps by weakly equivalent cofibrations  $S^{N-1} \hookrightarrow D^N$  and taking the actual pushout to get  $S^N$ .  $\square$

### 32.2 The 0-dimensional cobordism category

We now define the 0-dimensional cobordism category.

#### Definition

A *topological category* is a category object in  $\mathbf{Top}$ . As such it has spaces of  $\text{ob}(\mathcal{C})$  and  $\text{mor}(\mathcal{C})$  of objects and morphisms, and continuous source, target, identity and composition maps.

**Definition 32.2.1.** Let  $\text{Cob}(0, N)$  be the topological category with space of objects given by  $\mathbb{R}$  and space of morphisms given by the subspace of those  $(t, t', \vec{x}) \in \mathbb{R}^2 \times C(\mathbb{R} \times I^{N-1})$  satisfying  $t \leq t'$  and  $\vec{x} \in C((t, t') \times I^{N-1})$ . The source of  $(t, t', \vec{x})$  is  $t$  and the target is  $t'$ . The identity at  $t$  is  $(t, t, \emptyset)$ . Composition is given by union of configurations.

**Remark 32.2.2.** One can also define a version  $\text{Cob}^\delta(0, N)$  of  $\text{Cob}(0, N)$  where the  $t \in \mathbb{R}$  are discrete. This is convenient for some arguments, and its classifying space is weakly equivalent to  $BCob(0, N)$ .

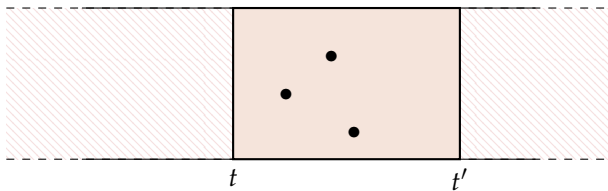

Figure 32.2: A morphism in  $\text{Cob}(0, N)$  for  $N = 2$ .

Note that particles in the morphism spaces can not disappear to infinity since they are constrained to the bounded set  $(t, t') \times I^{N-1}$ . By moving to  $t$  to 0 and  $t'$  to 1, Lemma 32.1.1 implies the morphism space admits an  $(N - 2)$ -connected map to  $\bigsqcup_{k \geq 0} B\mathfrak{S}_k$ .

We want to consider its classifying space  $BCob(0, N)$ . This is usually defined to be the geometric realization of the simplicial space given by the nerve  $N_\bullet \text{Cob}(0, N)$ , which has  $p$ -simplices given by the space of a sequence of  $(p + 1)$  objects and  $p$  morphisms between them:

$$\{t_0\} \xrightarrow{(t_0, t_1, \vec{x}_{01})} \{t_1\} \xrightarrow{(t_1, t_2, \vec{x}_{12})} \dots \xrightarrow{(t_{p-1}, t_p, \vec{x}_{p-1,p})} \{t_p\}$$

for  $t_0 \leq \dots \leq t_p$ . In general it is the  $p$ -fold pullback  $\text{mor}(\mathcal{C}) \times_{\text{ob}(\mathcal{C})} \text{mor}(\mathcal{C}) \times_{\text{ob}(\mathcal{C})} \dots \times_{\text{ob}(\mathcal{C})} \text{mor}(\mathcal{C})$ .

However, we shall find it convenient to take a slightly different geometric realization. For that purpose, let us discuss a bit of the homotopy theory of geometric realization.

A simplicial space  $X_\bullet$  is said to be *proper* if the inclusions  $\bigcup_i s_i(X_{p-1}) \hookrightarrow X_p$  are Hurewicz cofibrations.<sup>1</sup> A simplicial space  $X_\bullet$  is proper if it

<sup>1</sup> This is the same as being Reedy cofibrant with respect to the Ström model structure.

is good [Lew82] (this uses the union lemma for cofibrations [Lil73]); the inclusions  $s_i(X_{p-1}) \hookrightarrow X_p$  are cofibrations.<sup>2</sup> A simplicial space  $X_\bullet$  may be considered as a semi-simplicial space by forgetting the degeneracies, for which we usually use the same notation. Just like there is a geometric realization  $|X_\bullet|$  of a simplicial space there is a thick geometric realization  $\|X_\bullet\|$  of it considered as a semi-simplicial space: in the expression

$$\|X_\bullet\| := \left( \bigsqcup_{n \geq 0} \Delta^n \times X_n \right) / \sim,$$

the equivalence relation  $\sim$  just uses the face maps, not the degeneracy maps. There is a quotient map

$$\|X_\bullet\| \rightarrow |X_\bullet|$$

and Segal proved that if  $X_\bullet$  is proper this is a weak equivalence [Seg74]. This is a non-formal statement about the interaction of the Quillen and Strøm model structures.

**Lemma 32.2.3.**  $N_\bullet \text{Cob}(0, N)$  is a good simplicial space, and hence proper.

*Proof.* We have  $N_p \text{Cob}(0, N)$  is a disjoint union over  $n_0, \dots, n_{p-1} \in \mathbb{N}_0^p$  of a  $(p+1)$ -tuple  $(t_0, \dots, t_p) \in \mathbb{R}^{p+1}$  and  $p$  configurations of  $n_i$  particles in  $(t_i, t_{i+1}) \times I^{N-1}$ . By rescaling, we may identify each of these  $p$  spaces of configurations with either  $*$  (if  $n_i = 0$ ) or  $C_k((0, 1) \times I^{N-1})$  (if  $n_i > 0$ ).

Under these identifications, the degeneracy map is given by taking the product of the following map  $\tilde{s}_i$  with a fixed space:  $\tilde{s}_i$  is the map doubling the  $i$ th entry in the subspace  $(t_0, \dots, t_p) \in \mathbb{R}^{p+1}$  with  $t_0 \leq \dots \leq t_{p-1}$ . The map  $\tilde{s}_i$  is easily shown to be a Hurewicz cofibration and a product of a Hurewicz cofibration with a space is easily seen to be a Hurewicz cofibration by the product-mapping space adjunction.  $\square$

This means that we may also take the thick geometric realization of  $N_\bullet \text{Cob}(0, N)$ , considered as a semi-simplicial space. This is homotopically more well-behaved — see Lemma 33.4.5 — and so we shall use  $B(-)$  to denote the *thick geometric realization*.

### Comparison to group completion

We take a unital monoid model for  $\bigsqcup_{n \geq 0} B\mathfrak{S}_n$  by taking a Moore loop version of  $\bigsqcup_{n \geq 0} C_n(\mathbb{R}^\infty)$ . This is given by letting taking pairs of  $\tau \geq 0$  and a configuration in  $C((0, \infty) \times I^{N-1})$  that is contained in  $[0, \tau] \times I^{N-1}$ , and taking the colimit as  $N \rightarrow \infty$ . The unit is  $(0, \emptyset)$  and the multiplication is by concatenation.

<sup>2</sup> Some of the results used require the cofibration to have closed image. This is automatic in the category of CGWH spaces, —in which one should be working anyway — so we shall ignore this.



There is a simplicial map

$$N_\bullet \text{Cob}(0) \rightarrow N_\bullet M, \quad (32.1)$$

where we think of  $M$  as a topological category with a single object and morphism space  $M$ . This is a good simplicial space by a similar argument to Lemma 32.2.3, and hence proper, so we might as well use the thick geometric realization. The map (32.1) is induced by the functor sending the objects of  $\text{Cob}(0, N)$  to the unique object and a morphism  $(t, t', \vec{x})$  to the pair  $(t' - t, \vec{x} - t \cdot e_1)$ . This is a levelwise weak equivalence.

**Lemma 32.2.4.** *A levelwise weak equivalence of semi-simplicial spaces induces a weak equivalence upon geometric realization. More generally, a semi-simplicial map that is  $(n - p)$ -connected on  $p$ -simplices induces a  $n$ -connected map upon geometric realization.*

**Proposition 32.2.5.** *The map  $BCob(0, N) \rightarrow BM$  is  $(N - 1)$ -connected.*

The inclusion  $\mathbb{R}^N \hookrightarrow \mathbb{R}^{N+1}$  induces maps of cobordism categories, and we may define<sup>3</sup>

$$BCob(0) := \text{colim}_{N \rightarrow \infty} BCob(0, N).$$

The map  $BCob(0, N) \rightarrow BM$  is compatible with the map induced by the inclusion  $\mathbb{R}^N \hookrightarrow \mathbb{R}^{N+1}$  in the sense that there is a commutative diagram

$$\begin{array}{ccc} BCob(0, N) & & \\ \downarrow & \searrow & \\ & & BM \\ \downarrow & \nearrow & \\ BCob(0, N + 1), & & \end{array}$$

so that we obtain a map

$$BCob(0) \rightarrow BM$$

which is a weak equivalence. Using our discussion of  $K$ -theory and the group completion theorem, we may deduce the following corollary.

**Corollary 32.2.6.** *We have that  $\Omega BCob(0) \simeq K(\text{FinSet}_+)$  and that*

$$H_*(\Omega BCob(0)) \cong \left( \bigoplus_{n \geq 0} H_*(B\mathfrak{S}_n) \right) [\pi_0^{-1}],$$

that is, taking the colimit over stabilization maps.

<sup>3</sup> One can exchange  $B$  and the colimit if desired since geometric realization commutes with filtered colimits.

Using the homological stability results of the previous lecture, we may also conclude that  $H_*(B\mathfrak{S}_n) \rightarrow H_*(\Omega_0 BCob(0))$  is an isomorphism for  $* \leq n/2$  (the injectivity for  $* = n/2$  coming from the transfer argument). That is, the classifying space of the 0-dimensional cobordism category may be used to compute the stable homology of symmetric groups.

### 32.3 Comparison to configurations in a cylinder

Our starting point are the spaces  $\Omega BCob(0, N)$ , which we saw last time approximate  $K(\text{FinSet}_+)$  as  $N \rightarrow \infty$ . We start with identifying  $BCob(0)$  with a geometric object. This uses the technique of semi-simplicial resolution.

Let  $\Delta_+$  denote the category of possibly empty ordered finite sets and morphisms order-preserving maps, then an *augmented simplicial space* is a functor  $\Delta_+^{\text{op}} \rightarrow \text{Top}$ . The category  $\Delta_+$  differs from  $\Delta$  by adding a new isomorphism class of objects  $\emptyset$ , which have a unique map to every other objects. Thus an augmented simplicial space is a simplicial space with a map  $\epsilon: X_0 \rightarrow X_{-1}$  called an *augmentation*, which coequalizes both face maps  $d_0, d_1: X_1 \rightarrow X_0$ . This induces a map  $\|X_\bullet\| \rightarrow X_{-1}$ , also denoted  $\epsilon$ . The same construction goes through for semi-simplicial objects.

**Definition 32.3.1.** A *semi-simplicial resolution* of a space  $X$  is an augmented semi-simplicial object  $X_\bullet$  with  $X_{-1} = X$  so that  $\epsilon: \|X_\bullet\| \rightarrow X_{-1} = X$  is a weak equivalence.

**Proposition 32.3.2.** *There is a zigzag of weak equivalences*

$$C(\mathbb{R} \times I^{N-1}) \leftarrow \cdots \rightarrow BCob(0, N).$$

*Proof.* We shall build a semi-simplicial resolution  $X_\bullet$  of  $C(\mathbb{R} \times I^{N-1})$ . Its space of  $p$ -simplices  $X_p$  is given by

the subspace of  $C(\mathbb{R} \times I^{N-1}) \times \mathbb{R}^{p+1}$  of  $(\vec{x}, t_0, \dots, t_p)$  with  $t_0 < \dots < t_p$  such that  $\vec{x}$  is disjoint from the “walls”  $\{t_i\} \times I^{N-1}$ .

Its geometric realization  $\|X_\bullet\|$  has points given by a point  $\vec{x}$  and a finite collection of walls disjoint from  $\vec{x}$  with non-zero weights summing to 1. The element  $\vec{x}$  is topologized as before, the walls can move and the weights of the walls can vary (so that the walls disappear or appear when the weight hits 0).

There is a map

$$\epsilon: \|X_\bullet\| \rightarrow C(\mathbb{R} \times I^{N-1})$$

which forgets the walls, and this is a Serre microfibration since configurations of particles disjoint from walls stay so under small

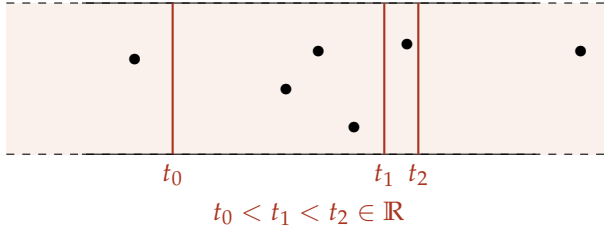
Figure 32.3: A point in  $X_2$  for  $N = 2$ , having  $2 + 1 = 3$  walls.

perturbations. Furthermore, its fiber  $\epsilon^{-1}(\vec{x})$  over  $\vec{x}$  is weakly contractible. To see this, we prove that a map  $f: S^i \rightarrow \epsilon^{-1}(\vec{x})$  with  $K$  compact is homotopic to one that has walls in a bounded subset  $B$  of  $\mathbb{R}$ . To see this note that the semi-simplicial map given by  $\rho_p: |\text{Sing}(X)_p| \rightarrow X_p$  is a levelwise weak equivalence. We saw last lecture that a thick geometric realization of a levelwise weak equivalence is a weak equivalence, and thus we may up to homotopy lift  $f$  to a map  $\tilde{f}: S^i \rightarrow ||[p] \mapsto |\text{Sing}(X)_p|||$ . But this is homeomorphic to the geometric realization of a simplicial set, so by simplicial approximation there exists a triangulation of  $S^i$  and a homotopy of  $\tilde{f}$  to a simplicial map  $\bar{f}$ . Since the triangulation has finitely many non-degenerate simplices,  $\mu \circ \rho \circ \bar{f}$  has image given by the union of the images of  $\mu$  restricted to finitely many simplices. This lies in a finite union of bounded subsets and hence is bounded.

We can then find a choice of wall disjoint from  $C$  and  $\vec{x}$  and load all the weights unto this wall to obtain a homotopy to a constant map. Thus the map  $||X_\bullet|| \rightarrow C(\mathbb{R} \times I^{N-1})$  is a weak equivalence.

A point in  $X_p$  is given by a collection  $t_0 < \dots < t_p$  and an element of

$$C((-\infty, t_0) \times I^{N-1}) \times \prod_{i=0}^{p-1} C((t_i, t_{i+1}) \times I^{N-1}) \times C((t_p, \infty) \times I^{N-1}),$$

see Figure 34.1. We can map  $X_p$  to  $N_p \text{Cob}(0, N)$  by forgetting the outer two terms. These outer two terms are contractible, by pushing the particles in  $(-\infty, t_0) \times I^{N-1}$  or  $(t_p, \infty) \times I^{N-1}$  out to infinity. Thus the map  $X_\bullet \rightarrow N_\bullet \text{Cob}(0, N)$  is a levelwise weak equivalence and hence so is its thick geometric realization.  $\square$

Note that the inclusion  $\mathbb{R}^N \hookrightarrow \mathbb{R}^{N+1}$  induces a commutative diagram

$$\begin{array}{ccccc} C(\mathbb{R} \times I^{N-1}) & \longleftarrow & ||X_\bullet(N)|| & \longrightarrow & BCob(0, N) \\ \downarrow & & \downarrow & & \downarrow \\ C(\mathbb{R} \times I^N) & \longleftarrow & ||X_\bullet(N+1)|| & \longrightarrow & BCob(0, N+1), \end{array}$$

so we may eventually take  $N$  to infinity and still get a zigzag of weak equivalences.

### 32.4 A delooping argument

We will now repeat a version of the previous argument to prove the following:

**Proposition 32.4.1.** *For  $k > 0$  there is a weak equivalence*

$$C(\mathbb{R}^k \times I^{N-k}) \simeq \Omega C(\mathbb{R}^{k+1} \times I^{N-k-1}).$$

This uses a consequence of the following delooping result, related to those discussed when we talked about algebraic  $K$ -theory. We call a semi-simplicial space  $X_\bullet$  a *semi-Segal space* if the map  $X_p \rightarrow X_1^p$ , induced by the  $p$  inclusions  $[1] \hookrightarrow [p]$  sending  $\{0, 1\}$  to  $\{i, i + 1\}$ , is a weak equivalence (this implies that  $X_0 \simeq *$ ). The following is a special case of Lemma 3.14 of [GRW10].

**Lemma 32.4.2.** *If  $X_\bullet$  is a semi-Segal space with  $X_1$  path-connected (or more generally group-like), then  $X_1 \simeq \Omega ||X_\bullet||$ .*

*Proof of Proposition 32.4.1.* It suffices to resolve  $C(\mathbb{R}^{k+1} \times I^{N-k-1})$  by a semi-Segal space  $X_\bullet$ , such that  $X_1 \simeq C(\mathbb{R}^k \times I^{N-k})$ .

We define  $X_\bullet$  to be the semi-simplicial space with  $p$ -simplices  $X_p$  given by

subspace of  $C(\mathbb{R}^{k+1} \times I^{N-k-1}) \times \mathbb{R}^{p+1}$  consisting of  $(\vec{x}, t_0, \dots, t_p)$  with  $t_0 < \dots < t_p$  such that  $\vec{x}$  is disjoint from the “walls”  $\mathbb{R}^k \times \{t_i\} \times I^{N-k-1}$ .

This clearly is a semi-Segal space with  $X_1 \simeq C(\mathbb{R}^k \times I^{N-k})$ , by pushing particles in the outer half-planes  $\mathbb{R}^k \times (-\infty, t_0) \times I^{N-k-1}$  and  $\mathbb{R}^k \times (t_p, \infty) \times I^{N-k-1}$  to infinity.

There is a canonical map  $\epsilon: ||X_\bullet|| \rightarrow C(\mathbb{R}^{k+1} \times I^{N-k-1})$  but to show that it is a weak equivalence it is helpful to define an intermediary space. The semi-simplicial space  $X'_\bullet$  has  $p$ -simplices given by

the subspace of  $C(\mathbb{R}^{k+1} \times I^{N-k-1}) \times \mathbb{R}^{p+1} \times (\mathbb{R}^k)^{p+1}$  consisting of  $(\vec{x}, t_0, \dots, t_p, y_0, \dots, y_p)$  with  $t_0 < \dots < t_p$  such that  $\vec{x}$  is disjoint from the subset  $\{y_i\} \times \{t_i\} \times I^{N-k-1}$  of a wall.

There is a simplicial map  $X_\bullet \rightarrow X'_\bullet$ , given by  $p$ -simplices by the map  $X_p \rightarrow X'_p$  sending  $(\vec{x}, t_0, \dots, t_p)$  to  $(\vec{x}, t_0, \dots, t_p, \vec{0}, \dots, \vec{0})$ . We obtain a factorization

$$\begin{array}{ccc} ||X_\bullet|| & \xrightarrow{\quad} & ||X'_\bullet|| \\ & \searrow \epsilon & \swarrow \epsilon' \\ & C(\mathbb{R}^{k+1} \times I^{N-k-1}). & \end{array}$$

The top map is a levelwise weak equivalence; push  $\mathbb{R}^k$  outwards from  $\{y_i\}$ . To show that  $\epsilon'$  is also a weak equivalence, we remark that

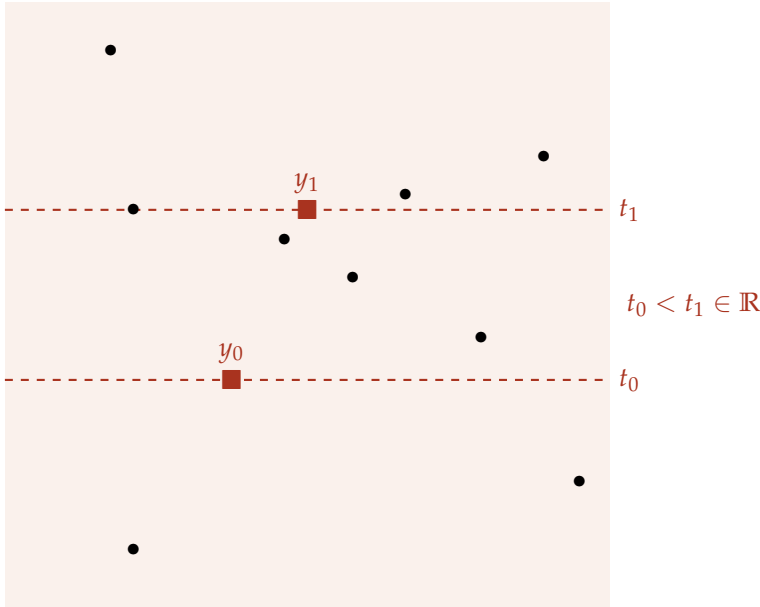
Figure 32.4: A point in  $X_1$  for  $N = 2$  and  $k = 2$ .

it is a microfibration (this is not true for  $\epsilon$  since points intersecting a wall can suddenly appear at infinity) and its fibers are weakly contractible by a similar argument as in Section 32.3.2.  $\square$

In fact, it is possible to give maps  $C(\mathbb{R}^k \times I^{N-k}) \rightarrow \Omega C(\mathbb{R}^{k+1} \times I^{N-k-1})$  that are homotopic to those in Proposition 34.2.5 but compatible with the inclusions  $\mathbb{R}^N \hookrightarrow \mathbb{R}^{N+1}$ . This map is given by identifying the domain of  $\Omega$  with  $[-\infty, \infty]$  and defining its adjoint  $[-\infty, \infty] \times C(\mathbb{R}^k \times I^{N-k}) \rightarrow C(\mathbb{R}^{k+1} \times I^{N-k-1})$  by

$$(s, \vec{x}) \mapsto (\vec{x} + s \cdot e_{k+1}).$$

Thus we get a sequence of weak equivalences

$$C(\mathbb{R} \times I^{N-1}) \xrightarrow{\simeq} \Omega C(\mathbb{R}^2 \times I^{N-2}) \xrightarrow{\simeq} \dots \xrightarrow{\simeq} \Omega^{N-1} C(\mathbb{R}^N),$$

and  $C(\mathbb{R}^N)$  was identified with  $S^N$  in the previous lecture by a scanning argument. Using Proposition 32.3.2, we thus conclude that

$$\Omega BCob(0, N) \simeq \Omega^N S^N.$$

Since the maps are compatible with the inclusion  $\mathbb{R}^N \hookrightarrow \mathbb{R}^{N+1}$ , we get commutative diagrams

$$\begin{array}{ccc} \Omega BCob(0, N) & \xrightarrow{\simeq} & \Omega^N S^N \\ \downarrow & & \downarrow \\ \Omega BCob(0, N+1) & \xrightarrow{\simeq} & \Omega^{N+1} S^{N+1} \end{array}$$

where the right vertical arrow is the Freudenthal suspension map. Recalling the notation  $QS^0 = \Omega^\infty \mathbb{S} = \operatorname{colim}_{N \rightarrow \infty} \Omega^N S^N$ , we conclude that

$$\Omega BCob(0) \simeq QS^0.$$

Combined with conclusion that  $\Omega BCob(0) \simeq K(\operatorname{FinSet}_+)$  of last time, this implies the Barratt-Priddy-Quillen-Segal theorem:

**Corollary 32.4.3** (Barratt-Priddy-Quillen-Segal). *We have that  $K(\operatorname{FinSet}_+) \simeq QS^0$ .*

### 32.5 Application to stable homotopy groups of spheres

One can use the Barratt-Priddy-Quillen-Segal theorem to deduce some properties of the stable homotopy groups of spheres.

#### *Bounds on torsion*

Recall the homological stability result that  $H_*(B\mathfrak{S}_n) \cong H_*(Q_0S^0)$  for  $* \leq n/2$ . Since  $\mathfrak{S}_n$  is a finite group and hence has homology groups which are finite in degree (e.g. using Lemma 32.5.2 below), this implies that the homology of  $Q_0S^0$  is finite in each degree. Since  $Q_0S^0$  is a homotopy-commutative  $H$ -space, the action of  $\pi_1$  on its higher homotopy groups is trivial and by an induction over the Postnikov tower, one may recover a theorem of Serre:

**Corollary 32.5.1** (Serre).  *$\pi_i(\mathbb{S})$  is finite for  $i > 0$ .*

One can better using the following basic lemma:

**Lemma 32.5.2.** *If  $G$  has order  $n$ , then  $H_i(BG)$  is annihilated by  $n$  for  $i > 0$ .*

*Proof.* Take the  $n$ -fold covering space  $\pi: EG \rightarrow BG$ , then the composition of  $\pi_*$  and the transfer  $\operatorname{tr}: H_i(BG) \rightarrow H_i(EG)$  is given by multiplication with  $n$ . But this factors over the trivial group  $H_i(EG)$ .  $\square$

Since the order of  $\mathfrak{S}_n$  is  $n!$ , this shows that no  $p$ -torsion can occur until  $n \geq p$ . This means that  $H_*(Q_0S^0)$  contains no  $p$ -torsion for  $* < \frac{p}{2}$ . By a Serre class argument one may show:

**Corollary 32.5.3.**  *$\pi_i(\mathbb{S})$  contains no  $p$ -torsion for  $i < \frac{p}{2}$ .*

This is not optimal as the first odd  $p$ -torsion shows up in  $i = 2p - 3$ , a result again due to Serre.

#### *Homology spheres*

There is an interesting method to construct elements of the stable homotopy groups of spheres using homology spheres with finite

fundamental group:  $i$ -dimensional manifolds  $\Sigma$  such that  $H_*(\Sigma) \cong H_*(S^i)$  and  $\pi_1(\Sigma)$  finite.

Such homology spheres have universal cover  $S^i$ , which is classified by a map  $\Sigma \rightarrow B\mathfrak{S}_N$  with  $N$  the order of  $\pi_1(\Sigma)$ . We want to map  $B\mathfrak{S}_N$  to  $K(\text{FinSet}_+)$ , and to do so we use another construction of  $K$ -theory, the  $+$ -construction. This construction takes a path-connected space  $X$  and produces a map  $X \rightarrow X^+$  which is a homology isomorphism with all local coefficients and surjective on  $\pi_1$  with kernel the maximal perfect subgroup of  $\pi_1(X)$ . It is functorial up to homotopy and Quillen proved that  $(B\mathfrak{S}_\infty)^+ \simeq Q_0S^0$ , where  $\mathfrak{S}_\infty := \text{colim}_{n \rightarrow \infty} \mathfrak{S}_n$ . Applying this to  $\Sigma \rightarrow B\mathfrak{S}_N$  we get

$$\Sigma^+ \rightarrow (B\mathfrak{S}_N)^+ \rightarrow (B\mathfrak{S}_\infty)^+ \simeq Q_0S^0,$$

and since  $\Sigma^+$  has the same homology as  $S^i$  but is simply-connected, it has to be weakly equivalent to  $S^i$ . Thus we have produced an element of  $\pi_i(\mathbb{S})$ .

**Example 32.5.4.** The classical example of a homology sphere is the Poincaré homology sphere  $\mathcal{P}$ , given by taking the quotient of  $SU(2) \cong S^3$  by the binary icosahedral group  $2 \cdot I$ , which has 120 elements. It gives us an element of  $\pi_3(\mathbb{S})$ , but which element is it?

By construction  $\mathcal{P}^+ \rightarrow (B\mathfrak{S}_{120})^+$  factors over  $(B2 \cdot I)^+$ . Since the map  $\mathcal{P} \rightarrow B2 \cdot I$  is 3-connected and the map  $S^3 \rightarrow \mathcal{P}$  is multiplication by 120 on top degree, we conclude that  $H_1(B2 \cdot I) = H_2(B2 \cdot I) = 0$  and  $H_3(B2 \cdot I) = \mathbb{Z}/120\mathbb{Z}$  (and its periodic after that). By the Hurewicz theorem  $\pi_3(B2 \cdot I)^+ \cong \mathbb{Z}/120\mathbb{Z}$ . This means that the element obtained is at least 120-torsion (note the map  $\pi_3(\mathcal{P}^+) \rightarrow \pi_3((B2 \cdot I)^+)$  is surjective).

There is a homomorphism  $\mathbb{Z}/3\mathbb{Z} \rightarrow 2 \cdot I$ , by including an order 3 rotation in the binary tetrahedral group  $2 \cdot T$  and including that into  $2 \cdot I$ . By construction, upon mapping to  $\mathfrak{S}_{120}$ , this gives a subgroup conjugate to  $\mathbb{Z}/3\mathbb{Z} \hookrightarrow \mathfrak{S}_3 \rightarrow \mathfrak{S}_{120}$ . Since  $\mathbb{Z}/3\mathbb{Z}$  is the 3-Sylow of  $\mathfrak{S}_3$ ,  $H_*(B\mathbb{Z}/3\mathbb{Z}; \mathbb{Z}_{(3)}) \cong H_*(B\mathfrak{S}_3; \mathbb{Z}_{(3)})$  and since the map  $H_*(B\mathfrak{S}_3; \mathbb{Z}_{(3)}) \rightarrow H_*(Q_0S^0; \mathbb{Z}_{(3)})$  is split injective, we conclude that  $H_3(\mathcal{P}^+) \rightarrow H_3(Q_0S^0)$  hits a  $\mathbb{Z}/3\mathbb{Z}$ -summand. Since  $\pi_1(\mathbb{S}) \cong \pi_2(\mathbb{S}) \cong \mathbb{Z}/2\mathbb{Z}$ , this means that there must be a  $\mathbb{Z}/3\mathbb{Z}$  in  $\pi_3(\mathbb{S})$  (note this verifies for  $p = 3$  the claim that the first odd  $p$ -torsion in the stable homotopy group of spheres shows up in  $i = 2p - 3$ ).

In fact, it is known that  $\pi_3(\mathbb{S}) \cong \mathbb{Z}/24\mathbb{Z}$ . The above argument shows the elements in this group produced from  $\mathcal{P}$  is non-trivial and generates a subgroup of order at least 3. I would not be surprised if the element in  $\pi_3(\mathbb{S})$  is a generator, but it is harder construct 2-torsion in  $\pi_3(\mathbb{S})$  through homology because  $\pi_1(\mathbb{S})$  and  $\pi_2(\mathbb{S})$  start interfering.





## Homological stability for diffeomorphism of $W_{g,1}$ 's

We shall now prove the results of the previous two lectures for the high-dimensional manifolds  $W_{g,1} := \#_g(S^n \times S^n) \setminus \text{int}(D^{2n})$ . Homological stability for the diffeomorphism groups of these manifolds is a result of Galatius and Randal-Williams [GRW18]. We shall prove this up to proving the connectivity of a certain simplicial complex related to the algebra of quadratic forms. Assuming this result, we explain how to lift the high-connectivity of this complex to the connectivity of semi-simplicial space of thickened cores, and use this to deduce homological stability.

### 33.1 Homological stability

As mentioned in the introduction, we are interested in the manifolds  $W_{g,1} := \#_g(S^n \times S^n) \setminus \text{int}(D^{2n})$ . These are high-dimensional analogues of genus  $g$  surfaces. We shall take  $n \geq 3$ , so that the dimension is  $2n \geq 6$  and the Whitney trick can be used, in contrast to  $n = 1$  where special low-dimensional techniques apply and  $n = 2$  where nothing is known.

Removing two disks from  $S^n \times S^n$ , we obtain a manifold  $W_{1,2}$ , which we may glue to  $W_{g,1}$  along one of its boundary components to obtain  $W_{g+1,1}$ . We can extend a diffeomorphism of  $W_{g,1}$  fixing the boundary pointwise over  $W_{1,2}$  by the identity, resulting in a homomorphism

$$\text{Diff}_\partial(W_{g,1}) \rightarrow \text{Diff}_\partial(W_{g+1,1})$$

which induces a *stabilization map* on classifying spaces

$$\sigma: \text{BDiff}_\partial(W_{g,1}) \rightarrow \text{BDiff}_\partial(W_{g+1,1}).$$

**Theorem 33.1.1** (Galatius-Randal-Williams). *For  $n \geq 3$ , the relative homology groups  $H_*(\text{BDiff}_\partial(W_{g+1,1}), \text{BDiff}_\partial(W_{g,1}))$  of the stabilization map vanish for  $*$   $\leq \frac{g-1}{2}$ .*

Takeaways:

- The diffeomorphism groups of  $W_{g,1}$  exhibit homological stability.
- Constructing a  $W_{1,1}$  in a  $W_{g,1}$  amount to finding a hyperbolic summand in the middle-dimensional homology, considered as a  $(-1)^n$ -quadratic module.
- The simplicial complex of such hyperbolic summands is highly-connected. This may be lifted to a discrete version of the semi-simplicial space, and then use the weakly Cohen-Macaulayness to deduce that the semi-simplicial space is highly-connected as well.
- The Quillen argument goes through as expected, with a few changes in low degrees due to the action not being transitive.

**Remark 33.1.2.** A similar statement is true for  $n = 1$ , i.e.  $W_{g,1}$  a genus  $g$  surface with one boundary component, though the range is better. This is a result due to Harer [Har85], with improvements by Ivanov, Boldsen and Randal-Williams. See [Wah13] for a survey. Though it is also based on Quillen’s argument, the connectivity of the relevant semi-simplicial set is proved in quite a different manner than in the high-dimensional case.

**Remark 33.1.3.** A similar result is true when studying  $N\#W_{g,1}$  for  $N$  a 1-connected manifold or even  $N$  with  $\pi_1(N)$  polycyclic-by-finite. It is also true with tangential structure, and for homeomorphisms or PL-homeomorphisms.

### 33.2 Thickened cores

#### *Producing thickened cores*

The manifold  $W_{1,1}$  can be build, up to smoothing corners, by *plumbing* together two cores; take two cores  $D^n \times S^n$  and once we pick  $D^n \subset S^n$ , identify  $D^n \times D^n$  in the first copy of  $D^n \times S^n$  with the  $D^n \times D^n$  in the second copy of  $D^n \times S^n$  using the diffeomorphism  $(x, y) \mapsto (y, x)$  of  $D^n \times D^n$ . Then  $W_{g,1}$  can be made by taking a  $g$ -fold boundary connected sum of  $W_{1,1}$ :

$$W_{g,1} \cong \natural_g W_{1,1}.$$

Undoing stabilization amounts to picking an embedded copy of a  $W_{1,1}$  in  $W_{g,1}$  whose complement is diffeomorphic to  $W_{g-1,1}$  and such that a disk  $D^{2n-1}$  in  $\partial W_{1,1} \cong S^{2n-1}$  is in  $\partial W = S^{2n-1}$ . To achieve this goal, we shall first study the problem of finding an embedded  $W_{1,1}$  in a  $(n-1)$ -connected  $2n$ -dimensional manifold  $W$  with boundary  $\partial W = S^{2n-1}$ . That is, we leave the connection to the boundary and the complement for later.

We claim it suffices to find two embedded  $S^n$ ’s in  $W$ , denoted  $e$  and  $f$ , with trivial normal bundle and intersecting once transversally in a single point  $p$ . The transversality implies that there exists a chart  $\phi: W \supset U \rightarrow \mathbb{R}^{2n}$  such that  $\phi(p) = 0$ ,  $\phi(e \cap U) = \mathbb{R}^n \times \{0\}$  and  $\phi(f \cap U) = \{0\} \times \mathbb{R}^n$ . Pick a trivialization of both normal bundles at  $p$ ,  $\nu_e \cong e \times \mathbb{R}^n$ ,  $\nu_f \cong f \times \mathbb{R}^n$ . Using a Riemannian metric that is standard near 0 in  $\phi$ -coordinates we get tubular neighborhoods  $E$  and  $F$  of  $e$  and  $f$  with the following properties: they are diffeomorphic to  $e \times D^n$  and  $f \times D^n$ , and furthermore, we have that  $\phi(E \cap U) = \mathbb{R}^n \times D^n$  and  $\phi(F \cap U) = D^n \times \mathbb{R}^n$ . This gives an identification of  $E \cup F$  with the plumbing  $W_{1,1}$ .

### The algebra of thickened cores

We shall now discuss how to use the Whitney trick to build a thickened core from algebraic data.

Pick an orientation on  $W$ , so that the intersection product is well-defined. Note that  $e$  and  $f$  represent homology classes  $[e], [f]$  in  $H_n(W)$  satisfying  $[e] \cdot [f] = 1$ . We can extract more algebraic data out of  $E$  and  $F$ , which are in particular immersions  $S^n \times D^n \looparrowright W$ . The set  $I_n^{\text{fr}}(W)$  of regular homotopy classes of such framed immersions has additional functions defined on it. Taking signed intersections of transverse representatives gives a map

$$\lambda: I_n^{\text{fr}}(W) \otimes I_n^{\text{fr}}(W) \rightarrow H_n(W) \otimes H_n(W) \rightarrow \mathbb{Z}$$

and taking signed transverse self-intersections gives a map

$$\mu: I_n^{\text{fr}}(W) \rightarrow \begin{cases} \mathbb{Z} & \text{if } n \text{ is even,} \\ \mathbb{Z}/2\mathbb{Z} & \text{if } n \text{ is odd.} \end{cases}$$

Note that taking signed self-intersections requires a choice of ordering of the self-intersection points. Changing the order can change the sign by  $(-1)^{n \cdot n}$ , and to remove the ambiguity we need to take the quotient by  $2\mathbb{Z}$  when  $n$  is odd. A path of immersions is called a *regular homotopy* and a generic regular homotopy is a composition of ambient isotopies, Whitney moves or inverse Whitney moves (see Section 1.6 of [FQ90]). This implies that  $\mu$  is well-defined, as self-intersections always appear in pairs, of opposite orientation if  $n$  is even.

Using the Whitney trick and the fact that  $W$  is simply-connected of dimension  $2n \geq 6$ , one may show that if  $\mu(e) = 0$  then  $[e]$  may be represented by an embedded framed  $n$ -sphere  $e$ . If we have another class  $[f]$  with  $\mu(f) = 0$  and  $\lambda(e, f) = 1$ , then by the Whitney trick we can find second embedded framed  $n$ -sphere  $f$  which intersects  $e$  once transversally in a single point. Then we can produce a thickened core as in Section 33.2.

To better study the maps  $\lambda$  and  $\mu$ , we need to replace the set  $I_n^{\text{fr}}(W)$  by an abelian group. We define the abelian group structure by taking connected sum, but to get this to be well-defined we need to identify the framings near a point in the core of each of the two immersions. To do so, fix a basepoint  $b_W$  in  $\text{Fr}(W)$ , and let  $\mathcal{I}_n^{\text{fr}}(W)$  be the set of regular homotopy classes of  $a: S^n \times D^n \looparrowright W$  with a path in  $\text{Fr}(W)$  from  $a|_{D^n \times D^n}$  to  $b_W$ . This gives  $\mathcal{I}_n^{\text{fr}}(W)$  the structure of an abelian group. Alternatively, one may use Smale-Hirsch to identify it with a homotopy group  $\pi_n(\text{Bun}(TS^n \times D^n, TW))$ .

Wall identified the algebraic structure on  $(\mathcal{I}_n^{\text{fr}}(W), \lambda, \mu)$  (the simply-connected case of Theorem 5.2 of [Wal99]).

**Example 33.2.1.** When  $W = \mathbb{R}^2$ , so  $n = 1$ , then  $I_1^{\text{fr}}(\mathbb{R}^2)$  may be identified with the set  $\mathbb{Z}/2\mathbb{Z} \times \mathbb{Z}$ . The  $\mathbb{Z}/2\mathbb{Z}$  records whether the immersion is orientation preserving, while the  $\mathbb{Z}$  records “twisting”. This may be proven by the classification of generic regular homotopies or by noting that Smale-Hirsch identifies  $I_1^{\text{fr}}(\mathbb{R}^2)$  with the set of free homotopy classes of maps of  $S^1$  into the frame bundle  $\text{Fr}(T\mathbb{R}^2) \cong \mathbb{R}^2 \times O(2)$  [Sma59a]. Note that while  $\lambda$  vanishes identically,  $\mu$  does not.

**Example 33.2.2.** In the case  $W = \mathbb{R}^2$ , we have that  $\mathcal{I}_1^{\text{fr}}(\mathbb{R}^2) \cong \mathbb{Z}$  as an abelian group. Using Smale-Hirsch, which identifies  $\mathcal{I}_1^{\text{fr}}(\mathbb{R}^2)$  with

$$\pi_1(O(2)) \cong \mathbb{Z}.$$

More generally  $\mathcal{I}_n^{\text{fr}}(\mathbb{R}^{2n}) \cong \pi_n(O(2n))$  and  $\mathcal{I}_n^{\text{fr}}(W) \cong \pi_n(\text{Fr}(TW))$ , and the group structure given by connected sum coincides with the group structure on the homotopy groups.

**Definition 33.2.3.** For  $\epsilon = \pm 1$ , an  $\epsilon$ -quadratic module is an abelian group  $A$  with a bilinear map

$$\lambda: A \otimes A \rightarrow \mathbb{Z}$$

such that  $\lambda(x, y) = \epsilon\lambda(y, x)$ , and a map  $\mu: A \rightarrow \mathbb{Z}/(1 - \epsilon)\mathbb{Z}$  such that

- (i) for  $a \in \mathbb{Z}$  and  $x \in A$  we have  $\mu(a \cdot x) = a^2\mu(x)$ ,
- (ii) for  $x, y \in A$  we have  $\mu(x + y) - \mu(x) - \mu(y) \equiv \lambda(x, y) \pmod{(1 - \epsilon)\mathbb{Z}}$ .

**Example 33.2.4.** The hyperbolic  $\epsilon$ -quadratic module is uniquely defined by  $H = \mathbb{Z}\{e, f\}$  with  $\lambda(e, e) = \lambda(f, f) = 0$ ,  $\lambda(e, f) = 1$ , and  $\mu(e) = \mu(f) = 0$ .

**Lemma 33.2.6.** We have that  $(\mathcal{I}_n^{\text{fr}}(W), \lambda, \mu)$  is an  $(-1)^n$ -quadratic module.

*Sketch of proof.* The linearity of  $\lambda$  in each entry follows from the fact that we can always take the tubes along which we take connected sums disjoint. For the symmetry, we use that the linear isomorphism of  $\mathbb{R}^n \times \mathbb{R}^n$  given by  $(x, y) \mapsto (y, x)$  preserves orientation if  $n$  is even and reverses orientation when  $n$  is odd. This means that upon switching the two immersions in  $\lambda$ , we have the same intersection points, with the same orientation if  $n$  is even and opposite orientation if  $n$  is odd.

The second condition on  $\mu$  follows by noting that the self-intersections of  $x \# y$  are given by the self-intersections of  $x$ , the self intersections of  $y$  and the intersections of  $x$  with  $y$  (see Figure 33.1). For the first condition, we note that  $a \cdot x$  is represented by taking a normal bundle and creating  $a$  parallel copies  $x_1, \dots, x_a$  of  $x$ , connected by tubes we can ignore. For each self-intersection of  $x$ , each  $x_i$  will intersect itself and the other  $x_j$  once with the same sign as the self-intersection, and this thus contributes  $a^2$  the amount of the original self-intersection.  $\square$

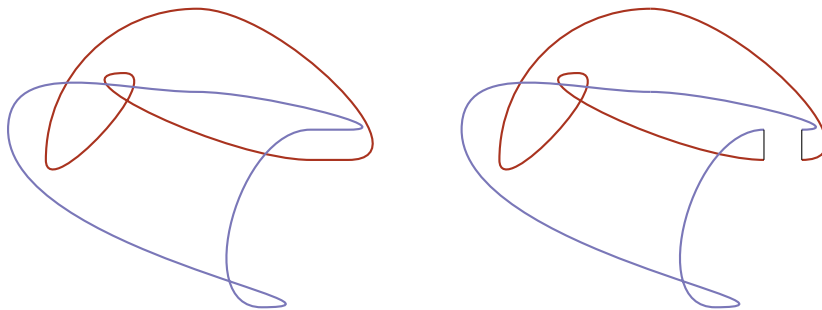

**Example 33.2.5.** Let us compute  $\mathcal{I}_n^{\text{fr}}(W_{1,1})$ . As  $W_{1,1}$  admits a framing, by Smale-Hirsch, the frame bundle  $\text{Fr}(TW_{1,1})$  is homotopy equivalent to  $W_{1,1} \times O(2n)$ . Thus we conclude that  $\mathcal{I}_n^{\text{fr}}(W_{1,1})$  is isomorphic as an abelian group to

$$\pi_n(W_{1,1} \times O(2n)) \cong \mathbb{Z}\{e, f\} \oplus \pi_n(O(2n)).$$

The standard embeddings  $D^n \times S^n, S^n \times D^n \hookrightarrow W_{1,1}$  correspond to  $(e, 0)$  and  $(f, 0)$ . Thus we get an embedding  $H \rightarrow \mathcal{I}_n^{\text{fr}}(W_{1,1})$  of  $(-1)^n$ -quadratic modules which is not far from being an isomorphism.

Figure 33.1: On the left hand side we have the connected sum of the two immersions on the right hand side. Its self-intersections are the union of the self-intersections of both immersions, together with their intersections.

Thus we have reduced the task of finding thickened cores in  $W$  to finding hyperbolic submodules in  $(\mathcal{I}_n^{\text{fr}}(W), \lambda, \mu)$ .

### The simplicial complex of hyperbolic summands

Most naturally  $K_{\bullet}^{\text{alg}}(W)$  is not a semi-simplicial set, but a simplicial complex. A simplicial complex  $X$  has a set of vertices and for each  $p \geq 1$  a set of  $p$ -simplices, consisting of unordered  $(p+1)$ -tuples in  $V^{p+1}$  and closed under taking subsets. By picking an arbitrary ordering of the vertices, this can be made into a semi-simplicial set and hence has a thick geometric realization, which up to homeomorphism is independent of the choice of ordering.

**Definition 33.2.7.** Let  $A$  be an  $\epsilon$ -quadratic module. Then the simplicial complex  $K_{\bullet}^{\text{alg}}(A)$  has vertices given by inclusions  $H \hookrightarrow A$  of summands. A  $(p+1)$ -tuple  $\{H_0, \dots, H_p\}$  forms a  $p$ -simplex if all  $H_i$  are mutually orthogonal.

For later arguments it shall be important that not only that  $K_{\bullet}^{\text{alg}}(A)$  is highly-connected, so are links of simplices. The *link*  $\text{Link}_X(\sigma)$  of a  $p$ -simplex  $\sigma$  in a simplicial complex  $X_{\bullet}$  is the simplicial subcomplex with  $q$ -simplices given by those  $\tau$  such that  $\tau \cap \sigma = \emptyset$  and  $\tau \cup \sigma$  is a  $(p+q-1)$ -simplex of  $X$ .

**Definition 33.2.8.** A simplicial complex  $X_{\bullet}$  is *weakly Cohen-Macaulay of dimension  $\geq n$*  if  $\|X_{\bullet}\|$  is  $(n-1)$ -connected and for each  $p$ -simplex  $\sigma$ ,  $\|\text{Link}_X(\sigma)\|$  is  $(n-p-2)$ -connected.

**Remark 33.2.9.** It is instructive to compare this definition to the characterization of PL-manifolds of dimension  $n$  in terms of simplicial complexes; a simplicial complex is a PL manifold of dimension  $n$  if the link of each  $p$ -simplex is PL  $(n-p-1)$ -sphere.

The following is proven by an argument similar to what we used to show that semi-simplicial set  $I_{\bullet}(n)$  of injective words was highly-connected, by comparing  $K_{\bullet}^{\text{alg}}(A)$  and  $K_{\bullet}^{\text{alg}}(A \oplus H)$ .

**Theorem 33.2.10** (Galatius-Randal-Williams). *Suppose that there exists an embedding of  $g$  orthogonal copies of  $H$  into an  $\epsilon$ -quadratic module  $A$ , then  $K_{\bullet}^{\text{alg}}(A)$  is weakly Cohen-Macaulay of dimension  $\leq \frac{g-2}{2}$ .*

### 33.3 Semi-simplicial spaces of thickened cores

As before, let  $W$  be a  $(n-1)$ -connected  $2n$ -dimensional manifold with boundary given by  $\partial W \cong S^{2n-1}$ . We shall define a semi-simplicial space  $K_{\bullet}(W)$  on whose thick geometric realization  $\text{Diff}_{\partial}(W)$  will eventually act. As a step towards proving that the relevant semi-simplicial space  $K_{\bullet}(W)$  is highly-connected, we also consider a discretized version  $K_{\bullet}^{\delta}(W)$ .

**Definition 33.3.1.** Fix an embedding  $D^{2n-1} \times \{1\} \hookrightarrow \partial W_{1,1}$  which avoids  $S^n \times \{0\}$  and  $\{0\} \times S^n$ . Let  $T_{1,1}$  be the manifold with corners  $W_{1,1} \cup D^{2n-1} \times [0, 1]$ , the *thickened core*.

Pick once and for all an embedded smooth path  $\gamma$  from  $\{0\} \times \{1\} \subset D^{2n-1} \times \{1\}$  to  $S^n \times \{0\}$  avoiding  $(S^n \times \{0\}) \cup (\{0\} \times S^n) \cup (\{0\} \times [0, 1])$ . Then

$$C_{1,1} := (S^n \times \{0\}) \cup (\{0\} \times S^n) \cup (\{0\} \times [0, 1]) \cup \gamma$$

is its *core*. See Figure 33.2.

Note that there exists a deformation retraction  $H: T_{1,1} \times [0, 1] \rightarrow T_{1,1}$  onto  $C_{1,1}$  which is an embedding for times  $t < 1$ , and that up to smoothing corners  $T_{1,1}$  is diffeomorphic to  $W_{1,1}$ .

Fix a boundary collar chart  $\mathbb{R}^{2n-1} \times [0, \infty) \hookrightarrow W$ . An *admissible embedding* of  $T_{1,1}$  into  $W$  is an embedding  $\phi: T_{1,1} \hookrightarrow W$  such that there exists an  $\epsilon > 0$  and  $a, b > 0$  such that  $\phi|_{D^{2n-1} \times [0, \epsilon]}$  is given with respect to the boundary collar coordinates by  $(x, t) \mapsto (ax + b \cdot e_1, t)$ .

**Definition 33.3.2.** The semi-simplicial space  $K_\bullet(W)$  has  $p$ -simplices given by

$$K_p(W) \subset \text{Emb}(T_{1,1}, W)^{p+1}$$

of ordered  $(p + 1)$ -tuples  $(\phi_0, \dots, \phi_p)$  of admissible embeddings, such that  $\phi_i(C_{1,1}) \cap \phi_j(C_{1,1}) = \emptyset$  if  $i \neq j$  and  $b_i < b_j$  if  $i < j$ . The  $i$ th face map  $d_i$  forgets  $\phi_i$ .

Some remarks about this semi-simplicial space: the images of the  $\phi_i$  need *not* be disjoint, only their cores. A priori  $(\phi_0, \dots, \phi_p)$  has two orderings; the one from its definition as an ordered  $(p + 1)$ -tuple and the other coming from the order in which their cores are attached along the line  $\mathbb{R} \times \{0\} \subset \mathbb{R}^{2n-1} \times [0, \infty)$ . We have demanded that these orderings coincide. In particular,  $(\phi_0, \dots, \phi_p)$  may be recovered from the unordered set  $\{\phi_0, \dots, \phi_p\}$ .

We then define the semi-simplicial set  $K_\bullet^\delta(W)$  by forgetting the topology on the embedding spaces.

### 33.4 $K_\bullet(W)$ is highly-connected

To prove that  $K_\bullet^\delta(W)$  is highly-connected, we compare it to the simplicial complex  $K_\bullet^{\text{alg}}(\mathcal{I}_n^{\text{fr}}(W))$  of hyperbolic summands in the  $\epsilon$ -quadratic module  $(\mathcal{I}_n^{\text{fr}}(W), \lambda, \mu)$  for  $\epsilon = (-1)^n$ .

#### From hyperbolic summands to discrete embeddings

Recall that a  $p$ -simplex of  $K_\bullet^\delta(W)$  is an ordered  $(p + 1)$ -tuple  $(\phi_0, \dots, \phi_p)$  of embeddings of thickened cores. These must have disjoint cores,

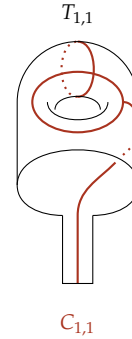

Figure 33.2: The thickened core  $T_{1,1}$  and its core  $C_{1,1}$ , in the case  $n = 1$ .

and their order coincides with the order in which they are attached to the boundary. Thus we can recover the order from the set  $\{\phi_0, \dots, \phi_p\}$ , and we may regard  $K_\bullet^\delta(W)$  as a simplicial complex without changing the homeomorphism type of its thick geometric realization.

Recall that if  $A$  is an  $\varepsilon$ -quadratic module, then the simplicial complex  $K_\bullet^{\text{alg}}(A)$  has vertices given by inclusions  $H \hookrightarrow A$  of summands. A  $(p+1)$ -tuple  $\{H_0, \dots, H_p\}$  forms a  $p$ -simplex if all  $H_i$  are mutually orthogonal. We saw last lecture that  $(\mathcal{I}_n^{\text{fr}}(W), \lambda, \mu)$  is an  $(-1)^n$ -quadratic module, after we pick a basepoint framing  $b \in \text{Emb}(D^n \times D^n, W) \simeq \text{Fr}(TW)$ . We pick the one coming from the boundary collar chart.

There is a simplicial map

$$\mathcal{I}_\bullet : K_\bullet^\delta(W) \rightarrow K_\bullet^{\text{alg}}(\mathcal{I}_n^{\text{fr}}(W))$$

sending  $\phi$  to the hyperbolic summand spanned by the classes of  $\phi|_{S^n \times \{0\}}$  and  $\phi|_{\{0\} \times S^n}$ . The path of framings to the base point is induced by moving the disk to which we restrict along  $W_{1,1}$  and  $D^{2n-1} \times [0, 1]$  to the boundary collar chart. It is easy to see that embeddings with disjoint cores gives orthogonal summands, as we may compute  $\lambda$  geometrically by counting intersection points with sign.

**Lemma 33.4.1.** *The map  $\mathcal{I}$  is surjective on vertices, up to changing the null-homotopies of framings.*

*Sketch of proof.* By the discussion in the previous lecture, from each hyperbolic summand we may produce an embedded copy of  $W_{1,1}$  whose spheres represent  $e, f \in H$  except for the path of framings (which we shall ignore per the statement of the lemma). It remains to attach  $W_{1,1}$  to the boundary via a “tether”  $D^{2n-1} \times [0, 1]$  and produce the path of framings. Pick any smooth path  $\eta$  from  $\{0\} \times \{1\} \in \partial W_{1,1}$  to the boundary collar chart. Generically it is embedded and avoids  $(S^n \times \{0\}) \cup (\{0\} \times S^n) \cup \gamma$ , so by shrinking  $W_{1,1}$  we may assume it is disjoint from it. Thicken it by taking a tubular neighborhood, taking care to make it attach to  $\partial W_{1,1}$  and the boundary collar chart correctly (as in the definition of an admissible embedding) by picking an appropriate Riemannian metric to use in the exponentiation. It may be the case that the framings lie in different path components, but then just change the orientations.  $\square$

Using this we prove the following lemma. We remark that a similar argument works for links of simplices of  $K_\bullet^\delta(W)$ , a generality which we shall use later, but we shall not give the proof in this generality for the sake of keeping the notation understandable.

**Lemma 33.4.2.** *Given a commutative diagram*

$$\begin{array}{ccc}
 S^i & \longrightarrow & ||K_{\bullet}^{\delta}(W)|| \\
 \downarrow & & \downarrow ||\mathcal{I}_{\bullet}|| \\
 D^{i+1} & \longrightarrow & ||K_{\bullet}^{\text{alg}}(\mathcal{I}_n^{\text{fr}}(W))||
 \end{array} \tag{33.1}$$

*we may produce a map  $D^{i+1} \rightarrow ||K_{\bullet}^{\delta}(W)||$  whose restriction to the boundary is homotopic to the top horizontal map.*

Note we do not claim this map is a lift. This is consequence of possible getting the framings wrong in Lemma 33.4.1. The following argument is a standard argument in the homotopy theory of simplicial complexes called a *lifting argument*.

*Sketch of proof.* By simplicial approximation there exists a pair simplicial complexes  $(K_{\bullet}, L_{\bullet})$  with  $(||K_{\bullet}||, ||L_{\bullet}||) \cong (D^{i+1}, S^i)$  and a commutative diagram of simplicial maps

$$\begin{array}{ccc}
 L_{\bullet} & \xrightarrow{f_{\bullet}} & K_{\bullet}^{\delta}(W) \\
 \downarrow & & \downarrow \mathcal{I}_{\bullet} \\
 K_{\bullet} & \xrightarrow{F_{\bullet}} & K_{\bullet}^{\text{alg}}(\mathcal{I}_n^{\text{fr}}(W))
 \end{array}$$

which upon geometric realization is homotopic to (33.1) through commutative diagrams.

Let us now for convenience assume that for all vertices in the image of  $f$ , the cores are transverse. This assumption is unnecessary, since one always arrange it to be true by an initial homotopy (using the weakly Cohen-Macauleyness), but we shall skip this step for ease of exposition.

We then try to produce a lift of  $F$  one vertex at a time. We shall fail to produce to the right null-homotopies of framings, but the statement allows us to ignore this. Pick an enumeration  $k_1, \dots, k_N$  of the vertices in  $K_{\bullet} \setminus L_{\bullet}$ , i.e. in the interior of  $D^{i+1}$ , and suppose we have produced a lift of the first  $M$  of these,  $k_1, \dots, k_M$ . We shall also suppose these lifts represent the same summand of  $H_n(W)$  (i.e. are the same up to framings), and that all cores are transverse to each other and the cores of the vertices in the image of  $L_{\bullet}$  under  $f$ .

For the next vertex  $k_{M+1}$ , we can use Lemma 33.4.1 to pick a lift. By a small perturbation we can make it transverse to the cores of the  $k_i$  for  $i \leq M$  and of the vertices in the image of  $L_{\bullet}$  under  $f$ . This may be done one core at a time using the fact that transversality is an open condition. Note the hyperbolic summand  $F(k_{M+1})$  is orthogonal to that of  $F(k_i)$  for all  $k_i$  in  $\text{Link}_K(k_{M+1})$ , using the fact that orthogonality only depends on its image in  $H_n(W)$ . This means that



we can use Whitney tricks to make its core disjoint from the cores of those  $k_i$ , one core at a time. This requires that all cores are transverse; to guarantee that doing a Whitney trick does not create new intersections requires us to find Whitney tricks disjoint from the other cores. This might be impossible if cores intersect non-transversally, e.g. if intersections separate on a core the two intersection points we are trying to cancel. This completes the induction step.  $\square$

If  $W$  contain  $g$  disjoint copies of  $W_{1,1}$ , then  $\mathcal{I}_n^{\text{fr}}(W)$  contains  $g$  orthogonal copies of  $H$ . Using the fact that  $K_{\bullet}^{\text{alg}}(W)$  is then  $\frac{g-2}{2}$ -connected, the previous lemma implies the following corollary:

**Corollary 33.4.3.** *Suppose that there exists an embedding of  $g$  disjoint copies of  $W_{1,1}$  into  $W$ , then  $K_{\bullet}^{\delta}(W)$  is weakly Cohen-Macaulay of dimension  $\leq \frac{g-2}{2}$ .*

In particular, this implies that for  $\frac{g-2}{2} - p - 2 \geq -1$  the complement of the cores of a  $(p+1)$ -tuple of admissible embeddings still admits an embedding of another  $W_{1,1}$  into it, as the link is non-empty.

#### *From discrete embeddings to topologized embeddings*

Now that we have established a connectivity result for  $K_{\bullet}^{\delta}(W)$ , we shall leverage it to prove a connectivity result for  $K_{\bullet}(W)$ . This is done by comparing discrete and topologized embeddings through a bi-semi-simplicial space.

**Definition 33.4.4.** Let  $\bar{K}_{\bullet,\bullet}(W)$  be the bi-semi-simplicial space with  $(p, q)$ -simplices given by ordered  $(p+q+2)$ -tuples of  $(\phi_0, \dots, \phi_{p+q+2})$  of admissible embeddings with disjoint cores and compatible ordering at the boundary (i.e. forming a  $p$ -simplex in  $K_{p+q+1}^{\delta}(W)$ ), where the first  $p+1$  are topologized and the last  $q+1$  are discrete. That is,  $\bar{K}_{p,q}(W)$  is topologized as a subspace of  $K_p(W) \times K_q^{\delta}(W)$ .

There are two augmentations

$$\epsilon: \bar{K}_{\bullet,\bullet}(W) \rightarrow K_{\bullet}(W)$$

$$\delta: \bar{K}_{\bullet,\bullet}(W) \rightarrow K_{\bullet}^{\delta}(W)$$

given by either forgetting the last  $q+1$  or first  $p+1$  admissible embeddings. There is also an inclusion map  $\iota: K_{\bullet}^{\delta}(W) \rightarrow K_{\bullet}(W)$ . By moving the discrete embedding into the topologized embeddings, one proves that the following diagram is homotopy-commutative

$$\begin{array}{ccc} \|\bar{K}_{\bullet,\bullet}(W)\| & \xrightarrow{\epsilon} & \|K_{\bullet}(W)\| \\ \delta \downarrow & \nearrow \iota & \\ \|K_{\bullet}^{\delta}(W)\| & & \end{array}$$

so that the map  $\epsilon$  factors over a highly-connected space. In particular, if there exists an embedding of  $g$  disjoint copies of  $W_{1,1}$  into  $W$ , the bottom space is  $\frac{g-4}{2}$ -connected. Thus if we can show that  $\epsilon$  is  $(\frac{g-4}{2} - 1)$ -connected, then we can conclude that  $\|K_\bullet(W)\|$  is  $\frac{g-4}{2}$ -connected as well. For this it suffices to prove that the map on  $p$ -simplices is  $(\frac{g-4}{2} - p - 1)$ -connected, using the following lemma used in Lecture 28:

**Lemma 33.4.5.** *A levelwise weak equivalence of semi-simplicial spaces induces a weak equivalence upon geometric realization. More generally, a semi-simplicial map that is  $(n - p)$ -connected on  $p$ -simplices induces a  $n$ -connected map upon geometric realization.*

Since disjointness of cores is an open condition, the map

$$\epsilon_p: \|[q] \mapsto \bar{K}_{p,q}(W)\| \rightarrow K_p(W)$$

is a Serre microfibration. The fiber of  $\epsilon$  over a  $p$ -simplex  $(\phi_0, \dots, \phi_p) \in K_p(W)$  is weakly equivalent to the semi-simplicial set of discrete admissible embeddings whose cores avoid those of the  $\phi_i$ . By an argument as before, this is still  $\frac{g-p-5}{2}$ -connected, and  $\frac{g-p-5}{2} \geq \frac{g-4}{2} - p - 1$ . A generalization of Weiss' lemma, Proposition 2.6 of [GRW18], says that:

**Lemma 33.4.6.** *A Serre microfibration  $f: E \rightarrow B$  with  $(n - 1)$ -connected fibers is  $n$ -connected.*

We conclude from this:

**Corollary 33.4.7.** *Suppose that there exists an embedding of  $g$  disjoint copies of  $W_{1,1}$  into  $W$ , then  $K_\bullet^\delta(W)$  is  $\frac{g-4}{2}$ -connected.*

### 33.5 Quillen's argument

As announced in the previous lecture, we shall now attempt to run Quillen's argument again. The proof shall be analogous but not identical to that for symmetric groups. We start by considering the action of  $\text{Diff}_\partial(W_{g,1})$  on the geometric realization of the semi-simplicial space  $K_\bullet(W_{g,1})$ . To directly copy the argument for symmetric groups, we would like that

- (1)  $\text{Diff}_\partial(W_{g,1})$  acts transitively on  $K_p(W_{g,1})$  and the stabilizer of a  $p$ -simplex is isomorphic to  $\text{Diff}_\partial(W_{g-p-1,1})$ .
- (2) All face maps are homotopic to  $\sigma_*$ .
- (3)  $\|K_\bullet(W)\|$  is  $\frac{g-4}{2}$ -connected.

We have already established (3) in Corollary 33.4.7, but (1) and (2) are not true. However, the failures of (1) and (2) will not be hard to overcome.

### The failure of (1) and (2)

For (1), we firstly note that transitivity fails simply because cores can be attached along different parts of the boundary and the action  $\text{Diff}_\partial(W_{g,1})$  fixes the boundary of  $W_{g,1}$  so can not map these to each other. However,  $K_p(W_{g,1})$  clearly deformation retracts onto the subspace  $K'_p(W_{g,1})$  of  $(p+1)$ -simplices with  $i$ th thickened core attached along  $(x, t) \mapsto (1/3 \cdot x + (i+1) \cdot e_1, t)$ .

This does not address all problems: transitivity fails because the thickened cores are not disjoint, only the cores. But we may similarly by shrinking the thickened cores onto their cores, produce a deformation retraction of  $K'_p(W)$  onto the subspace  $K''_p(W)$  where the thickened cores are disjoint.

The final obstruction is that it is not clear that the complement of a  $(p+1)$ -simplex is diffeomorphic to  $W_{g-p-1,1}$ . We shall prove this using the path-connectedness of  $\|K_\bullet(W_{g,1})\|$  for  $g$  sufficiently large.

**Lemma 33.5.1.** *Let  $e_0, e_1: T_{1,1} \hookrightarrow W_{g,1}$  be admissible embeddings that  $g \geq 4$ . Then there is a diffeomorphism  $f$  of  $W_{g,1}$  such that  $e_1 = f \circ e_0$  and  $f$  is isotopic to the identity on  $\partial W_{g,1}$ .*

*Proof.* If  $e_0$  and  $e_1$  are disjoint, the union of their images together with a little strip near the boundary is diffeomorphic to  $W_{2,1}$ , and one may construct the desired diffeomorphism by hand. If only their cores are disjoint, we may shrink them onto the cores and note that by isotopy extension it suffices to construct  $f$  for these embeddings.

For the general, we use that  $\|K_\bullet^\delta(W_{g,1})\|$  is path-connected. The proof is then by induction over the number of vertices in a path of 1-simplex connecting  $e_0$  and  $e_1$ , using the above argument for the induction step.  $\square$

**Corollary 33.5.2.** *Let  $e_0, e_1: T_{1,1} \hookrightarrow W_{g,1}$  be admissible embeddings that  $g \geq 4$ . Then the complement of  $e_0$  is diffeomorphic to the complement of  $e_1$ .*

Now we may check (2) using the preferred  $p$ -simplex given by a  $(p+1)$ -tuple of standard embeddings of  $T_{1,1}$  into  $W_{g,1}$ .

### Finishing the proof

The previous paragraphs implies the following weaker versions of (1)–(3) hold:

- (1) For  $g - p \geq 4$ ,  $K_p(W_{g,1}) // \text{Diff}_\partial(W_{g,1}) \simeq B\text{Diff}_\partial(W_{g-p-1,1})$ .
- (2) For  $g - p \geq 4$ , the face maps  $d_i: K_p(W_{g,1}) // \text{Diff}_\partial(W_{g,1}) \rightarrow K_{p-1}(W_{g,1}) // \text{Diff}_\partial(W_{g,1})$  are homotopic to  $\sigma_*$ .
- (3)  $\|K_\bullet(W)\|$  is  $\frac{g-4}{2}$ -connected.

The spectral sequence argument will then go as for symmetric groups, with an offset in the range to accommodate for the offsets. This proves Theorem 33.1.1:

**Theorem 33.5.3** (Galatius-Randal-Williams). *For  $n \geq 3$ , the relative homology groups  $H_*(B\text{Diff}_\partial(W_{g+1,1}), B\text{Diff}_\partial(W_{g,1}))$  of the stabilization map vanish for  $* \leq \frac{g-1}{2}$ .*

## The homotopy type of the cobordism category

In the previous lecture we proved homological stability for  $B\text{Diff}_\partial(W_{g,1})$ . Today we start with the computation of the stable homology. The first step is computing the homotopy type of the cobordism category of  $d$ -dimensional manifolds, analogous to the proof of the Barratt-Priddy-Quillen-Segal theorem. This is the subject of this lecture. The original reference is [GTMW09], but we shall follow [GRW10] and the exposition in [Hat11].

Takeaways:

- One can define right compact-open spaces of submanifolds using the existence of tubular neighborhoods, and then the proof of Barratt-Priddy-Quillen-Segal goes through without any real modification.
- The result is that  $BCob(d) \simeq \Omega^{\infty-1}MTO(d)$ , with  $MTO(d)$  the Thom spectrum of  $-\gamma$  over  $BO(d)$ . This generalizes to other tangential structures.

### 34.1 Compact open spaces of submanifolds

We shall start by defining the analogue of the spaces  $C(U)$  of compact-open configuration spaces. To do so, we first define spaces of submanifolds analogous to ordinary configuration spaces and compute their homotopy type. We then describe how to define its “compact-open variation”  $\Psi_d(U)$  for  $U \subset \mathbb{R}^N$  and compute the homotopy type of  $\Psi_d(\mathbb{R}^N)$ .

#### Spaces of submanifolds

Fix a compact  $d$ -dimensional manifold  $M$ , with empty boundary for the sake of convenience of exposition. Let us consider the space  $\text{Emb}(M, \mathbb{R}^N)$  of embeddings  $M \hookrightarrow \mathbb{R}^N$  in the  $C^\infty$ -topology. This has a continuous action of  $\text{Diff}(M)$  by precomposition.

**Lemma 34.1.1.** *The space  $\text{Emb}(M, \mathbb{R}^N)$  is  $(N/2 - d - 2)$ -connected.*

*Proof.* Given a map  $H: K \rightarrow C^\infty(M, \mathbb{R}^N)$ , we use  $h$  for the associated map  $K \times M \rightarrow K \times \mathbb{R}^N$  and  $\tilde{h}$  for the associated map  $K \times M \rightarrow \mathbb{R}^N$ , i.e.  $\tilde{h} = \pi_2 \circ h$ .

Consider a map  $F: S^i \rightarrow \text{Emb}(M, \mathbb{R}^N)$  and its associated map  $\tilde{f}: S^i \times M \rightarrow \mathbb{R}^N$ , then we may extend it to a map  $\tilde{g}: D^{i+1} \times M \rightarrow \mathbb{R}^N$ , as  $\mathbb{R}^N$  is contractible. Since the embeddings are open in all

smooth maps, for all  $t$  in an  $\epsilon$ -neighborhood of  $S^i$  in  $D^{i+1}$ , the map  $g(t, -): M \rightarrow \mathbb{R}^N$  is an embedding.

Now may make the restriction of  $\tilde{g}$  to  $B_{1-\epsilon/4}(0) \subset \mathbb{R}^{i+1}$  generic, the result we again denote by  $\tilde{g}$ . We may do this an perturbation that is small enough such that for  $t \in B_{1-\epsilon/4}(0) \setminus B_{1-\epsilon/2}(0)$ , linear interpolation between  $\tilde{f}(t, -)$  and  $\tilde{g}(t, -)$  is through embeddings, again using the fact that embeddings are open in all smooth maps. We then let  $\tilde{h}: D^{i+1} \times M \rightarrow \mathbb{R}^N$  be defined by

$$\tilde{h}(t, m) = \begin{cases} \tilde{f}(t, m) & \text{if } 1 - \epsilon/4 \leq \|t\| \leq 1 \\ \frac{1-\epsilon/2-\|t\|}{\epsilon/4} \tilde{f}(t, m) + (1 - \frac{1-\epsilon/2-\|t\|}{\epsilon/4}) \tilde{g}(t, m) & \text{if } 1 - \epsilon/2 \leq \|t\| \leq 1 - \epsilon/4 \\ \tilde{g}(t, m) & \text{otherwise} \end{cases}$$

A generic map  $D^{i+1} \times M \rightarrow \mathbb{R}^N$  is an embedding if  $2(d + i + 1) < N$ , i.e.  $i \leq N/2 - m - 2$ , which implies that the map  $H: D^{i+1} \rightarrow C^\infty(M, \mathbb{R}^N)$  lands in the subspace of embeddings; on  $B_1(0) \setminus B_{1-\epsilon/2}(0)$  it is an embedding by our condition on the smallness of the perturbation, and on  $B_{1-\epsilon/2}(0)$  it is because the map  $B_{1-\epsilon/2}(0) \times M \rightarrow B_{1-\epsilon/2}(0) \times \mathbb{R}^N \rightarrow \mathbb{R}^N$  is an embedding. Since  $H$  extends  $F$ , this concludes the proof.  $\square$

We claim that this makes  $\text{Emb}(M, \mathbb{R}^N)/\text{Diff}(M)$  an approximation for  $B\text{Diff}(M)$ , and in particular

$$\text{colim}_{N \rightarrow \infty} \text{Emb}(M, \mathbb{R}^N)/\text{Diff}(M) \simeq B\text{Diff}(M).$$

Note that the space  $\text{Emb}(M, \mathbb{R}^N)/\text{Diff}(M)$  has points given by a (unparametrized) submanifolds  $W \subset \mathbb{R}^N$  that are diffeomorphic to  $M$ , justifying the slogan “a model for  $B\text{Diff}(M)$  is given by the space of submanifolds of  $\mathbb{R}^\infty$  diffeomorphic to  $M$ .”

To prove the claim, we need to verify that

$$\pi: \text{Emb}(M, \mathbb{R}^N) \rightarrow \text{Emb}(M, \mathbb{R}^N)/\text{Diff}(M)$$

is a principal  $\text{Diff}(M)$ -bundle. As the action is free, it suffices to show the existence of local sections (as these then give local trivializations). That is, given a submanifold  $W \in \text{Emb}(M, \mathbb{R}^N)/\text{Diff}(M)$  we need to find an open subset  $U$  of  $\text{Emb}(M, \mathbb{R}^N)/\text{Diff}(M)$  containing  $W$  and a map  $s: U \rightarrow \text{Emb}(M, \mathbb{R}^N)$  so that  $\pi \circ s = \text{id}_U$ . This follows from the existence of tubular neighborhoods. Pick an embedding  $\varphi_0: M \rightarrow \mathbb{R}^N$  whose image is  $W$  and a tubular neighborhood  $\Phi_0: \nu_M \rightarrow \mathbb{R}^N$  extending  $\varphi_0$ , so that we have a map  $p_0: \Phi_0(\nu_M) \rightarrow W$ . Let  $U$  be the subset of  $W' \subset \mathbb{R}^N$  such that  $W' \subset \Phi_0(\nu_M)$  and the map  $p_0|_{W'}: W' \rightarrow W$  is a smooth submersion. This is open and the section  $s: U \rightarrow \text{Emb}(M, \mathbb{R}^N)$  is given by sending  $W'$  to the embedding  $\varphi_{W'}: M \rightarrow \mathbb{R}^N$  given by sending  $m \in M$  to  $p_0|_{W'}^{-1}(\varphi_0(m))$ .

### Compact-open spaces of submanifolds

We want consider submanifolds that are able to disappear partially at infinity, like how a single particle in a configuration was allowed to disappear in  $C(\mathbb{R}^N)$ . Our only option to allow their diffeomorphism types to change, and hence we might as well take *all* submanifolds.

**Definition 34.1.2.** Let  $\Psi_d(\mathbb{R}^N)$  denote the set of closed subsets  $W \subset \mathbb{R}^N$  that are smooth  $d$ -dimensional submanifolds, i.e. locally diffeomorphic to the pair  $(\mathbb{R}^N, \mathbb{R}^d)$ .

We next define the topology on this set, following Section 2 of [GRW10]. This is done in three steps:

- (1) Using a tubular neighborhood  $\Phi: \nu_W \hookrightarrow \mathbb{R}^N$  of  $W \in \Psi_d(\mathbb{R}^N)$ , let  $\Gamma_c(\nu_W)$  denote the space of compactly supported smooth sections and  $\Gamma_c(\nu_W) \rightarrow \Psi_d(\mathbb{R}^N)$  as the graph of the section, interpreted as a subspace of  $\mathbb{R}^N$  using  $\Phi$ . As a first approximation, topologize  $\Psi_d(\mathbb{R}^N)$  so that these are homeomorphisms onto open subsets. This is denoted  $\Psi_d(\mathbb{R}^N)^{\text{cs}}$ .
- (2) For  $N \subset \mathbb{R}^N$ , let  $\Psi_d(\mathbb{R}^N, \mathbb{R}^N \setminus N)$  be the quotient space of  $\Psi_d(\mathbb{R}^N)^{\text{cs}}$  by the equivalence relation where  $W \sim W'$  if and only if  $W \cap N = W' \cap N$ .
- (3) Let  $\Psi_d(\mathbb{R}^N)$  be the colimit of  $\Psi_d(\mathbb{R}^N, \mathbb{R}^N \setminus B_n(0))$  as  $n \rightarrow \infty$ .

**Example 34.1.3.** When  $d = 0$ , we have that  $\Psi_0(\mathbb{R}^N)$  is homeomorphic to the space  $C(\mathbb{R}^N)$  of compact-open configurations that we used in the proof of the Barratt-Priddy-Quillen-Segal theorem. This follows from the fact that (1) produces standard open neighborhoods in the configuration space, and (2) & (3) mirror the construction of  $C(\mathbb{R}^N)$ .

For  $U \subset \mathbb{R}^N$  open, let us denote by  $\Psi_d(U)$  the subspace of  $\Psi_d(\mathbb{R}^N)$  of those  $W$  such that  $W \subset U$ . We will occasionally consider  $\Psi_d(C)$  for  $C$  closed for notational convenience, then by definition this is  $\Psi_d(\text{int}(C))$ .

There is an operation on  $\pi_0(\Psi_d(\mathbb{R}^k \times I^{N-k}))$  given by juxtaposition:  $(W, W')$  is sent to  $W \sqcup (W' + e_{k+1})$  in  $\Psi(\mathbb{R}^k \times [0, 2] \times I^{N-k-1})$  and then  $[0, 2]$  is reparametrized to  $I$ . Indeed, this comes from the structure of an algebra over the little  $(N - k)$ -cubes operad on  $\Psi_d(\mathbb{R}^k \times I^{N-k})$ .

**Lemma 34.1.4.** For  $0 < k < N$ , we have that  $\pi_0(\Psi_d(\mathbb{R}^k \times I^{N-k}))$  is a group under juxtaposition.

*Proof.* For  $W \in \Psi_d(\mathbb{R}^k \times I^{N-k})$ , Sard's lemma says that the restriction to  $W$  of  $\pi: \mathbb{R}^k \times I^{N-k} \rightarrow \mathbb{R}^k$  has a regular value. Without loss of generality this the origin in  $\mathbb{R}^k$ . By zooming in on the origin, we find a path in  $\Psi_d(\mathbb{R}^k \times I^{N-k})$  from  $W$  to the product  $\mathbb{R}^k \times W|_0$ . We claim that the juxtaposition of  $\mathbb{R}^k \times W|_0$  with itself admits a path to the

empty manifold. To see this, note that there is a null-bordism  $V$  of  $W|_0 \sqcup W|_0$  which is embeddable in  $I^{N-k+1}$ . This provides a path from  $\mathbb{R}^k \times (W|_0 \sqcup W|_0)$  to  $\emptyset$  given by

$$t \mapsto \left( \mathbb{R}^{k-1} \times (-\infty, t] \times (W|_0 \sqcup W|_0) \right) \cup \left( \mathbb{R}^{k-1} \times (V + t \cdot e_k) \right). \quad \square$$

In fact, it is isomorphic to the group of  $(d - k)$ -dimensional manifolds in  $\mathbb{R}^{N-k}$  up to bordisms embedded in  $\mathbb{R}^{N-k} \times I$ .

*The homotopy type of  $\Psi_d(\mathbb{R}^N)$*

We shall compute  $\Psi_d(\mathbb{R}^N)$  by the same lemma we used before:

**Lemma 34.1.5.** *If  $U_0 \cup U_1 = X$  is an open cover of  $X$  by two subsets, then the pushout*

$$\begin{array}{ccc} U_0 \cap U_1 & \longrightarrow & U_0 \\ \downarrow & & \downarrow \\ U_1 & \longrightarrow & X \end{array}$$

*is also a homotopy pushout.*

To phrase the outcome of the computation, we recall the notion of a *Thom space*. Suppose we are given a vector bundle  $\zeta$  over a base  $B$ , i.e. an  $\mathbb{R}^k$ -bundle  $p: E \rightarrow B$  with transition functions in  $GL_k(\mathbb{R})$ . By definition this is the associated bundle with fiber  $\mathbb{R}^k$  of a principal  $GL_k(\mathbb{R})$ -bundle  $\text{Fr}(\zeta)$ . In fact, we may recover  $\text{Fr}(\zeta)$  as the space of maps  $\mathbb{R}^k \rightarrow E$  that are a linear map onto a fiber of  $p$ . Then the Thom space of  $\zeta$  is the pointed space given by taking the fiberwise one-point compactification and collapsing the section at infinity to a point.

**Definition 34.1.6.** We have that  $\text{Th}(\zeta)$  is given by  $\text{Fr}(\zeta) \times_{GL_k(\mathbb{R})} S^k$ , with  $GL_n(\mathbb{R})$  acting on  $S^k$  by identification the latter with  $\mathbb{R}^k \cup \{\infty\}$ , and collapsing  $s_\infty := \text{Fr}(\zeta) \times_{GL_k(\mathbb{R})} \{\infty\}$  to a point:

$$\text{Th}(\zeta) := (\text{Fr}(\zeta) \times_{GL_k(\mathbb{R})} S^k) / s_\infty.$$

If we endow  $\zeta$  with a Riemannian metric, this is homeomorphic to the quotient  $D(\zeta) / S(\zeta)$  of the closed unit disk bundle by the unit sphere bundle.

Let  $\text{Gr}_d(N)$  denote the Grassmannian of  $d$ -planes in  $\mathbb{R}^N$ . It carries several vector bundles, the first of which is the canonical bundle  $\gamma_d(N)$ . This is  $d$ -dimensional and has total space described by the subspace of  $\text{Gr}_d(N) \times \mathbb{R}^N$  consisting of  $(V, v)$  with  $v \in V$ . We shall instead be interested in  $\gamma_d^\perp(N)$ , the  $(N - d)$ -dimensional vector bundle with total space described by the subspace of  $\text{Gr}_d(N) \times \mathbb{R}^N$  consisting of  $(V, v)$  with  $v \in V^\perp$ . Note that  $\gamma_d(N) \oplus \gamma_d^\perp(N)$  is the trivial  $N$ -dimensional bundle.



**Proposition 34.1.7.** *We have that  $\Psi_d(\mathbb{R}^N) \simeq \text{Th}(\gamma_d^\perp(N))$ .*

*Proof.* We intend to cover  $\Psi_d(\mathbb{R}^N)$  by two open subsets  $U_0$  and  $U_1$ :

- $U_0$  is the subspace of  $\Psi_d(\mathbb{R}^N)$  of  $W$  such that  $0 \notin W$ .
- $U_1$  is the subspace of  $\Psi_d(\mathbb{R}^N)$  of  $W$  such that there is a unique point  $w_0$  in  $W$  that is closest to 0.
- $U_0 \cap U_1$  is then the subspace of  $\Psi_d(\mathbb{R}^N)$  of  $W$  such that  $0 \notin W$  but there is a unique point  $w_0$  in  $W$  that is closest to 0.

Unfortunately,  $U_1$  as above is not open, so we replace it with the following

- $U_1$  is the subspace of  $\Psi_d(\mathbb{R}^N)$  of those  $W$  such that restriction of  $W$  of function  $x \mapsto \|x\|^2$  has a unique minimum, which is a non-degenerate critical point.

Firstly,  $U_0$  has a deformation retraction onto  $\emptyset$  by pushing manifolds to infinity. Next, by first translating  $w_0$  to 0 and then zooming in on the origin (analogously to our proof that  $\text{Emb}(\mathbb{R}^n, \mathbb{R}^n) \simeq O(n)$ ), we see that  $U_1 \simeq \text{Gr}_d(N)$ . Finally, by moving  $w_0$  onto  $S^{N-1} \subset \mathbb{R}^N$  by scaling and then zooming in on it, we see that  $U_0 \cap U_1$  is homotopy equivalent to the space of affine  $d$ -planes in  $\mathbb{R}^N$ , whose closest point to the origin lies in  $S^{N-1}$ . This is the same as a point  $V \in \text{Gr}_d(\mathbb{R}^N)$  and a point in the unit sphere of the fiber of  $\gamma_d^\perp(N)$  at  $V$ , i.e. the unit sphere bundle  $S(\gamma_d^\perp(N))$ . By Lemma 34.1.5 we conclude that there is a homotopy pushout

$$\begin{array}{ccc} S(\gamma_d^\perp(N)) & \longrightarrow & * \\ \downarrow & & \downarrow \\ \text{Gr}_d(N) & \longrightarrow & \Psi_d(\mathbb{R}^N) \end{array}$$

with the left vertical map the projection to the base.

To compute this, we may replace the left vertical map by the cofibration  $S(\gamma_d^\perp(N)) \rightarrow D(\gamma_d^\perp(N))$ , where  $D(\gamma_d^\perp(N))$  denotes the closed unit disk bundle, and taking the actual pushout. This is given by  $D(\gamma_d^\perp(N))/S(\gamma_d^\perp(N))$ , which we saw before is homeomorphic to  $\text{Thom}(\gamma_d^\perp(N))$ . □

**Example 34.1.8.** When  $d = 0$ , we have that  $\text{Gr}_0(\mathbb{R}^N)$  is given by the Thom space of the orthogonal complement to the canonical bundle over the space  $\text{Gr}_0(\mathbb{R}^N)$ . This Grassmannian has a single point, and  $\gamma_d^\perp(N)$  has  $N$ -dimensional fibers, so that  $\text{Th}(\gamma_d^\perp(N)) \cong S^N$ .

### 34.2 The $d$ -dimensional cobordism category

We now define the  $d$ -dimensional cobordism category  $\text{Cob}(d, N)$ .

Like  $\text{Cob}(0, N)$  this is a topological category, i.e. has spaces of objects

Here is a collection of embeddings  $\mathbb{R} \rightarrow \mathbb{R}^2$  which are not in  $U_1$  but converge to a point in  $U_1$ . Let  $\eta: \mathbb{R} \rightarrow [0, 1]$  be a smooth function which is 0 on  $(-\infty, 0]$ ,  $> 0$  on  $(0, \infty)$  and strictly increases to  $\infty$ . Then take  $e_t: \mathbb{R} \rightarrow \mathbb{R}^2$  in radial coordinates  $(r, \theta)$  as follows

$$e_t(x) := \begin{cases} (\eta(x-t), x/(1+x^2)) & \text{if } x > 0, \\ (\eta(-x), x/(1+x^2)) & \text{if } x \leq 0. \end{cases}$$

This is at minimal radius 1 on the interval  $[0, t]$ , so for  $t > 0$  is not in  $U_1$  but for  $t = 0$  is.

and morphisms, and source, target and composition maps that are continuous.

Let  $\Psi_d(\mathbb{R} \times I^{N-1})$  denote the subspace of  $\Psi_d(\mathbb{R}^N)$  consisting of  $W$  contained in  $\mathbb{R} \times \text{int}(I^{N-1})$ . Note these are *not* allowed to disappear except at  $\{\pm\infty\} \times I^{N-1}$ . For open  $U \subset \mathbb{R}$  and  $W \in \Psi_d(\mathbb{R} \times I^{N-1})$  we let  $W|_U$  denote  $W \cap (U \times I^{N-1})$ . We also allow  $\{t\} \subset \mathbb{R}$ , and then  $W|_t := W \cap (\{t\} \times I^{N-1}) \in \Psi_{d-1}(\text{int}(I^{N-1}))$ , the latter being the subspace of  $\Psi_{d-1}(\mathbb{R}^{N-1})$  of  $X$  contained in  $\text{int}(I^{N-1})$ .

**Definition 34.2.1.** The  $d$ -dimensional cobordism category  $\text{Cob}(d, N)$  is the topological category with space of objects given by  $\mathbb{R} \times \Psi_{d-1}(\text{int}(I^{N-1}))$  and space of morphisms given by the subspace of  $\mathbb{R}^2 \times \Psi_d(\mathbb{R}^N)$  consisting of triples  $(t, t', W)$  such that  $t \leq t'$  and there exists an  $\epsilon > 0$  so that

$$\begin{aligned} W|_{(-\infty, t+\epsilon)} &= (\mathbb{R} \times W|_t)|_{(-\infty, t+\epsilon)}, \\ W|_{(t'-\epsilon, \infty)} &= (\mathbb{R} \times W|_{t'})|_{(t'-\epsilon, \infty)}. \end{aligned}$$

The source and target maps send  $(t, t', W)$  to  $W|_t$  and  $W|_{t'}$  respectively. The identity at  $(t, X)$  is  $(t, t, \mathbb{R} \times X)$ . The composition of  $(t, t', W)$  and  $(t', t'', W')$  is given by  $(t, t'', W'')$  with  $W''$  the union of  $W|_{(-\infty, t')}$  and  $W'|_{[t', \infty)}$ .

One should really think of the morphisms  $(t, t', W)$  as being submanifolds of  $[t, t'] \times \text{int}(I^{N-1})$ , the above is just slightly more technically convenient (because otherwise the subspace of  $\mathbb{R}^N$  they live in changes depending on  $t, t'$ ).

It is not clear that the simplicial space  $N_\bullet \text{Cob}(d, N)$  is proper. We shall thus take  $BCob(d, N)$  to be its *thick* geometric realization.

We shall postpone the identifying its homotopy type in terms of classifying of diffeomorphism groups until the next lecture. Instead we shall prove the following theorem:

**Theorem 34.2.2.** *We have that  $BCob(d, N) \simeq \Omega^{N-1} \text{Th}(\gamma_d^\perp(N))$ .*

These weak equivalences can be made natural in  $N$  (by an argument similar as for configurations, which we won't give for the sake of brevity), so that when we define  $\text{Cob}(d) := \text{colim}_{N \rightarrow \infty} \text{Cob}(d, N)$ , we have that

$$BCob(d) \simeq \text{colim}_{N \rightarrow \infty} \Omega^{N-1} \text{Th}(\gamma_d^\perp(N)).$$

We can identify the latter as  $\Omega^\infty$  of a Thom spectrum. This requires us thinking of  $\gamma_d^\perp(N)$  has being related to the formal vector bundle  $-\gamma_d(N)$  over  $BO(d)$ , as  $\gamma_d^\perp(N)$  is not a vector bundle over  $BO(d)$ .

By definition, the Thom spectrum  $M(-\xi)$  of the virtual bundle  $-\xi$  of an  $\xi$  that is  $n$ -dimensional over  $B$  is given as follows, supposing

there exists a filtration  $B(N)$  of  $B$  such that  $\xi$  has an  $N - n$  orthogonal complement  $\xi_N^\perp$  (this is always possible up to weak equivalence). The  $N$ th space of  $M(-\xi)$  is then given by  $\text{Th}(\xi_N^\perp)$ , so that in this convention, the Thom class is in degree  $-n$ . With this definition,  $\text{colim}_{N \rightarrow \infty} \Omega^N \text{Th}(\gamma_d^\perp(N))$  is the infinite loop space associated to  $MTO(d)$ , the Thom spectrum of  $-\gamma$  over  $BO(d)$ .

The following is the main result of [GTMW09].

**Corollary 34.2.4** (Galatius-Madsen-Tillmann-Weiss). *We have that  $BCob(d) \simeq \Omega^{\infty-1} MTO(d)$ .*

*Comparison to manifolds in cylinders*

The first step shall be to compare  $BCob(d, N)$  to  $\Psi_d(\mathbb{R} \times I^{N-1})$ .

**Proposition 34.2.5.** *There is a zigzag of weak equivalences*

$$\Psi_d(\mathbb{R} \times I^{N-1}) \leftarrow \dots \rightarrow BCob(d, N).$$

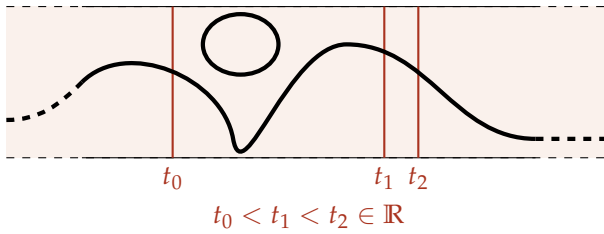

**Remark 34.2.3.** We leave to the reader to convince themselves that  $\pi_0(BCob(d)) \cong \Omega_{d-1}^O(*),$  the  $(d - 1)$ st unoriented bordism group. This may also be deduced from Corollary 34.2.4 using elementary homotopy theory, see Section 3 of [GTMW09], a fun but non-trivial exercise.

Figure 34.1: A point in  $X_2$  for  $d = 1,$   $N = 2,$  having  $2 + 1 = 3$  walls.

*Proof.* We shall build a semi-simplicial resolution  $X_\bullet$  of  $C(\mathbb{R} \times I^{N-1})$ . Its space  $X_p$  of  $p$ -simplices is given by

the subspace of  $\Psi_d(\mathbb{R} \times I^{N-1}) \times \mathbb{R}^{p+1}$  consisting of  $(W, t_0, \dots, t_p)$  with  $t_0 < \dots < t_p$  such that  $W$  is transverse to the “walls”  $\{t_i\} \times I^{N-1}$ .

See Figure 34.1. As before, the map

$$\epsilon: ||X_\bullet|| \rightarrow \Psi_d(\mathbb{R} \times I^{N-1})$$

induced by the augmentation, is a microfibration with contractible fibers. The former uses that transversality is an open condition, the latter that Sard’s lemma which says that for fixed  $W,$  the set  $\{t \mid \{t\} \times I^{N-1} \pitchfork W\} \subset \mathbb{R}$  is dense.

To compare this to the nerve of  $Cob(d, N),$  we consider the semi-simplicial subspace  $X'_\bullet$  of  $X_\bullet$  given by  $(W, t_0, \dots, t_p)$  such that there exists an  $\epsilon > 0$  such that  $W|_{(t_i - \epsilon, t_i + \epsilon)} = (\mathbb{R} \times W|_{t_i})|_{(t_i - \epsilon, t_i + \epsilon)}$ . See Figure 34.2. We may bend submanifolds straight by linear interpolation to prove that the inclusion

$$X'_\bullet \rightarrow X_\bullet$$

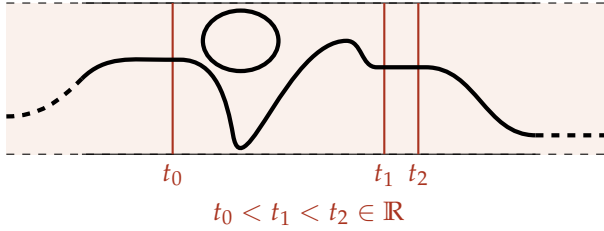

Figure 34.2: A point in  $X'_2$  for  $d = 1$ ,  $N = 2$ , having  $2 + 1 = 3$  walls, obtained by deforming the point in  $X_2$  of Figure 34.1 by linear interpolation near the walls.

is a level-wise weak equivalence, and hence so is its thick geometric realization.

Next we note that there is a semi-simplicial map  $X'_\bullet \rightarrow N_\bullet \text{Cob}(d, N)$  given by sending  $(W, t_0, \dots, t_p)$  to the  $p$ -tuple of morphisms obtained by taking  $W|_{[t_i, t_{i+1}]}$  and extending in constant fashion to  $(-\infty, t_i)$  and  $(t_{i+1}, \infty)$ . This forgets about the pieces  $W|_{(-\infty, t_0]}$  and  $W|_{[t_p, \infty)}$ , which are contractible pieces of data by pushing outwards to infinity. Thus this semi-simplicial map is a levelwise weak equivalence, and hence realizes to a weak equivalence,

We summarize by noting that we produced a zigzag of weak equivalences

$$\Psi_d(\mathbb{R} \times I^{N-1}) \xleftarrow{\simeq} \|X_\bullet\| \xleftarrow{\simeq} \|X'_\bullet\| \xrightarrow{\simeq} \text{BCob}(d, N). \quad \square$$

*A delooping argument: easy case*

Recall that  $\Psi_d(\mathbb{R}^k \times I^{N-k})$  denotes the subspace of  $\Psi_d(\mathbb{R}^N)$  of  $W$  contained in  $\mathbb{R}^k \times \text{int}(I^{N-k})$ . Now we repeat a version of the previous argument to prove the following:

**Proposition 34.2.6.** *For  $k > 0$  and  $d < k + 1$ , there is a weak equivalence*

$$\Psi_d(\mathbb{R}^k \times I^{N-k}) \simeq \Omega \Psi_d(\mathbb{R}^{k+1} \times I^{N-k-1}).$$

*Proof.* We again give a semi-simplicial resolution of  $\Psi_d(\mathbb{R}^{k+1} \times I^{N-k-1})$  by a semi-Segal space  $X_\bullet$  such that  $X_1 \simeq \Psi_d(\mathbb{R}^k \times I^{N-k})$ . As before,  $X_\bullet$  has space  $X_p$  of  $p$ -simplices given by

the subspace of  $\Psi_d(\mathbb{R}^{k+1} \times I^{N-k-1}) \times \mathbb{R}^{p+1}$  consisting of  $(W, t_0, \dots, t_p)$  with  $t_0 < \dots < t_p$  such that  $W$  is disjoint from the “walls”  $\mathbb{R}^k \times \{t_i\} \times I^{N-k-1}$ .

This is clearly a semi-Segal space with the desired  $X_1$  (which is group-like by Lemma 34.1.4) by pushing the submanifolds in  $\mathbb{R}^k \times (-\infty, t_0) \times I^{N-k-1}$  and  $\mathbb{R}^k \times (t_p, \infty) \times I^{N-k-1}$  out to infinity.

There is a canonical map  $\epsilon: \|X_\bullet\| \rightarrow \Psi_d(\mathbb{R}^{k+1} \times I^{N-k-1})$ , but to prove it is a weak equivalence, we use an additional augmented semi-simplicial space  $X'_\bullet$ . It has space  $X'_p$  of  $p$ -simplices given by

the subspace of  $\Psi_d(\mathbb{R}^{k+1} \times I^{N-k-1}) \times \mathbb{R}^{p+1} \times (\mathbb{R}^k)^{p+1}$  consisting of  $(W, t_0, \dots, t_p, y_0, \dots, y_p)$  with  $t_0 < \dots < t_p$  such that  $W$  is disjoint from  $\{y_i\} \times \{t_i\} \times I^{N-k-1}$ .

There is a semi-simplicial map

$$X_\bullet \rightarrow X'_\bullet$$

by picking  $y_i$  to be 0. This is a levelwise weak equivalence by pushing  $\mathbb{R}^k \times \{t_i\} \times I^{N-k-1}$  radially outwards in the  $\mathbb{R}^k$ -direction from  $\{y_i\} \times \{t_i\} \times I^{N-k-1}$ . We obtain a factorization

$$\begin{array}{ccc} \|\|X_\bullet\|\| & \xrightarrow{\cong} & \|\|X'_\bullet\|\| \\ & \searrow & \swarrow \\ & \Psi_d(\mathbb{R}^{k+1} \times I^{N-k-1}) & \end{array}$$

Finally, we note that right vertical map is a weak equivalence because it is a microfibration with contractible fibers. The condition that  $k > d$  is used to show that the fibers are non-empty:  $W$  is a  $d$ -dimensional manifold, and this must avoid some  $(N - k - 1)$ -dimensional manifold  $\{y\} \times \{t\} \times I^{N-k-1}$  if  $d + N - k - 1 < N$ , i.e.  $d < k + 1$ .  $\square$

Note that the conditions on  $d$  and  $k$  are necessary; in particular the fact that  $X_\bullet$  is a resolution implies that  $\Psi_d(\mathbb{R}^{k+1} \times I^{N-k-1})$  is path-connected, which is not true for  $k$  small.

*A delooping argument: hard case*

It remains to discuss the cases  $0 < k \leq d - 1$ . In this case a more subtle version of Proposition 34.2.5 is used. This takes advantage of the full strength of Lemma 3.14 of [GRW10], which uses the following notion: a semi-Segal space is *group-like* if the induced monoid structure<sup>1</sup> on  $\pi_0(X_1)$  has inverses.

**Lemma 34.2.7.** *If  $X_\bullet$  is a semi-Segal space with  $X_1$  group-like, then  $X_1 \simeq \Omega\|\|X_\bullet\|\|$ .*

**Proposition 34.2.8.** *For  $k > 0$  and  $d \geq k + 1$ , there is a weak equivalence*

$$\Psi_d(\mathbb{R}^k \times I^{N-k}) \simeq \Omega\Psi_d(\mathbb{R}^{k+1} \times I^{N-k-1}).$$

*Proof.* We now only attempt to resolve the path-component  $\Psi_d(\mathbb{R}^{k+1} \times I^{N-k-1})_\emptyset$  of  $\Psi_d(\mathbb{R}^{k+1} \times I^{N-k-1})$  corresponding to the empty manifold. This is the identity with respect to its group structure on  $\pi_0$ , and  $\Omega\Psi_d(\mathbb{R}^{k+1} \times I^{N-k-1})_\emptyset \simeq \Omega\Psi_d(\mathbb{R}^{k+1} \times I^{N-k-1})$ .

As before, the resolution is by a semi-Segal space  $X_\bullet$  such that  $X_1 \simeq \Psi_d(\mathbb{R}^k \times I^{N-k})$ . As before,  $X_\bullet$  has space  $X_p$  of  $p$ -simplices given by

the subspace of  $\Psi_d(\mathbb{R}^{k+1} \times I^{N-k-1})_\emptyset \times \mathbb{R}^{p+1}$  consisting of  $(W, t_0, \dots, t_p)$  with  $t_0 < \dots < t_p$  such that  $W$  is disjoint from the “walls”  $\mathbb{R}^k \times \{t_i\} \times I^{N-k-1}$ .

<sup>1</sup> That is, the map

$$\pi_0(X_1) \times \pi_0(X_1) \xleftarrow{\cong} \pi_0(X_2) \longrightarrow \pi_0(X_1),$$

which is associative by considering a diagram involving  $X_3$  and unital by considering a diagram involving  $X_0$ .

However, we shall need two different semi-simplicial spaces  $(X')^\blacklozenge$  and  $(X'')^\blacklozenge$ . The space of  $p$ -simplices of  $(X')^\blacklozenge$  is given by

the subspace of  $\Psi_d(\mathbb{R}^{k+1} \times I^{N-k-1}) \times \mathbb{R}^{p+1} \times (\mathbb{R}^k)^{p+1}$  consisting of  $(W, t_0, \dots, t_p, y_0, \dots, y_p)$  with  $t_0 < \dots < t_p$  such that  $W \pitchfork (\{y_i\} \times \{t_i\} \times I^{N-k-1})$ .

The space of  $p$ -simplices of  $(X'')^\blacklozenge$  is given by

the subspace of  $\Psi_d(\mathbb{R}^{k+1} \times I^{N-k-1}) \times \mathbb{R}^{p+1} \times (\mathbb{R}^k)^{p+1} \times (0, \infty)$  consisting of  $(W, t_0, \dots, t_p, y_0, \dots, y_p, \epsilon)$  with  $t_0 < \dots < t_p$  such that  $W \cap (\mathbb{R}^k \times (t_i - \epsilon, t_i + \epsilon) \times I^{N-k-1})$  equals  $\mathbb{R}^k \times (t_i - \epsilon, t_i + \epsilon) \times W|_{\{y_i\} \times \{t_i\}}$  and  $|t_{i+1} - t_i| > 2\epsilon$  for  $0 \leq i \leq p - 1$ .

There is a semi-simplicial map  $(X'')^\blacklozenge \rightarrow (X')^\blacklozenge$  forgetting the  $\epsilon$ 's. This is a level-wise weak equivalence by zooming in on the  $\{y_i\}$ . The map  $|(X')^\blacklozenge| \rightarrow \Psi_d(\mathbb{R}^{k+1} \times I^{N-k-1})_\emptyset$  is a Serre microfibration with weakly contractible fibers, so is a weak equivalence.

There is a semi-simplicial map  $X'_\bullet \rightarrow (X'')^\blacklozenge$ , taking  $\epsilon$  to be half of the distance from  $\{y_i\} \times \{t_i\} \times I^{N-k-1}$  to  $W$  and the  $y_i$  to be 0. We claim that this is a levelwise weak equivalence. To prove this, we use that because  $W|_{\{y_i\} \times \{t_i\}}$  is the restriction of an element of  $\Psi_d(\mathbb{R}^{k+1} \times I^{N-k-1})_\emptyset$ , there is an embedded null-bordism  $V_i$  of  $W|_{\{y_i\} \times \{t_i\}}$  in  $I^{N-k-1} \times I$ . As in the proof of Lemma 34.1.4, we may use this to deform  $W$  to have empty intersection with  $\mathbb{R}^k \times \{t_i\} \times I^{N-k-1}$ , see Figure 34.3. □

Note that this proof is not so different from Proposition 34.2.6, as there as we could have phrased disjointness as transversality, and the hard step of sliding in a null-bordism is unnecessary.

Combined with Propositions 34.1.7, 34.2.5 and 34.2.6, this finishes the proof of Theorem 34.2.2 and hence Corollary 34.2.4.

### 34.3 Tangential structures

Next lecture we shall use a stronger version involving *tangential structures*. Given a  $d$ -dimensional vector bundle  $\xi$  over  $B$  and a  $d$ -dimensional manifold  $W$ , let  $\text{Bun}(TW, \xi)$  denote the space of bundle maps  $TW \rightarrow \xi$ . This has a continuous action of  $\text{Diff}(W)$  by precomposition. Then

$$\text{Emb}(W, \mathbb{R}^N) \times_{\text{Diff}(W)} \text{Bun}(TW, \xi)$$

is the space of embedded submanifolds of  $\mathbb{R}^N$  diffeomorphic to  $W$  and with tangential structure  $\xi$ . If  $N$  is  $(d - 1)$ -dimensional, one uses instead  $\text{Bun}(TN \oplus \epsilon, \xi)$ .

**Example 34.3.1.** If  $\xi$  is the canonical bundle over  $BO(d)$ , this is the same up to homotopy as imposing no tangential structure. If  $\xi$  is the canonical bundle over  $BSO(d)$ , up to homotopy this is the same as a choice of orientation.

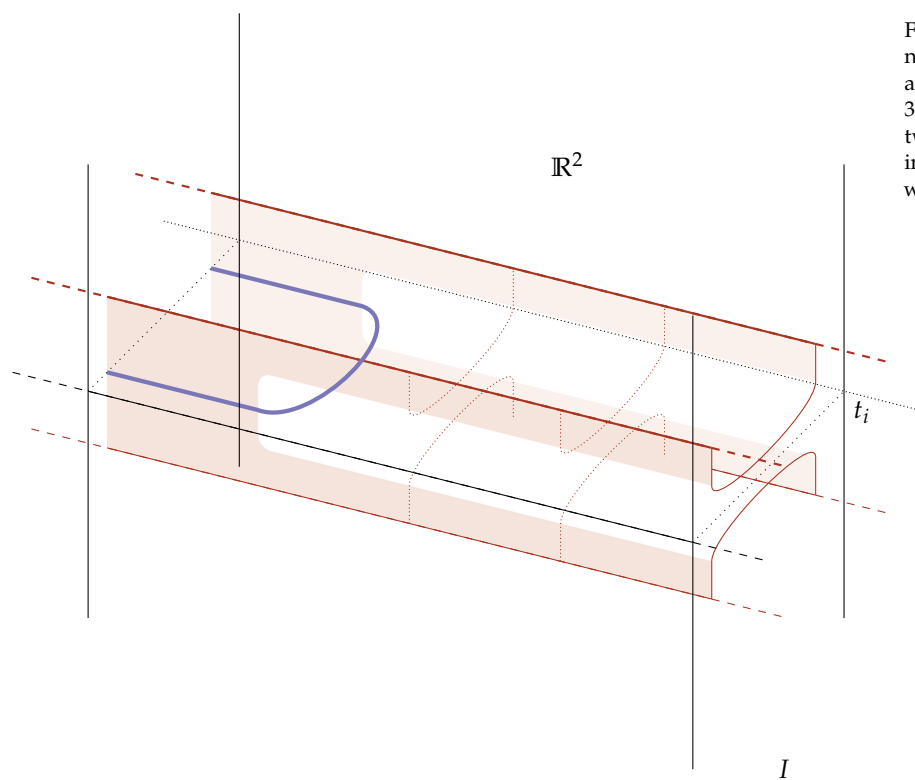

Figure 34.3: Halfway through using a null-bordism to clear intersections with a wall in the case  $k = 1$ ,  $d = 2$  and  $N = 3$ . The manifold  $W|_{\{y_i\} \times \{t_i\}}$  consists of two points, and the nullbordism is an interval. The purple is the intersection with  $\mathbb{R} \times \{t_i\} \times I$ .

We can define a version  $\Psi_d^{\zeta}(\mathbb{R}^N)$  of  $\Psi_d(\mathbb{R}^N)$  of submanifolds with  $\zeta$ -structure. Using this, one may define cobordism categories  $\text{Cob}^{\zeta}(d, N)$  and  $\text{Cob}^{\zeta}(d)$ . The results proven in this lecture generalize to:

**Corollary 34.3.2** (Galatius-Madsen-Tillmann-Weiss). *We have that  $B\text{Cob}^{\zeta}(d) \simeq \Omega^{\infty-1}MT\zeta$ , where  $MT\zeta$  is the Thom spectrum of the virtual vector bundle  $-\zeta$  over  $B$ .*



## Surgery in cobordism categories

In the previous lecture we proved that  $BCob(d) \simeq \Omega^{\infty-1}MTO(d)$ , and stated the more general version

$$BCob^{\xi}(d) \simeq \Omega^{\infty-1}MT\xi.$$

Today we will use the tangential structure  $\theta$  induced by  $n$ -connective cover  $BO(2n)\langle n \rangle \rightarrow BO(2n)$ . Surgery in cobordism categories is used to show that the stable homology of  $B\text{Diff}_{\partial}(W_{g,1})$  may be computed by  $\Omega BCob^{\theta}(2n) \simeq \Omega^{\infty}MT\theta$ . These results appear in [GRW14].

### 35.1 The tangential structure $\theta$

Recall  $\theta$  is the tangential structure coming from pulling back the universal  $2n$ -dimensional bundle  $\gamma$  along the  $n$ -connective cover  $\theta: BO(2n)\langle n \rangle \rightarrow BO(2n)$ , i.e.  $\pi_i(BO(2n)\langle n \rangle) = 0$  for  $0 \leq i \leq n$  and the map  $\pi_i(BO(2n)\langle n \rangle) \rightarrow \pi_i(BO(2n))$  is an isomorphism for  $i > n$ . In this section we consider the  $\theta$ -structures on  $W_{g,1} := \#_g(S^n \times S^n) \setminus \text{int}(D^{2n})$ .

#### $\theta$ -structures on the $(2n - 1)$ -sphere

Since the diffeomorphism group  $\text{Diff}_{\partial}(W_{g,1})$  fixes the boundary, it is natural to also fix the  $\theta$ -structure near the boundary. As in the previous lecture, the space of  $\theta$ -structures over  $S^{2n-1}$  is defined to be the space of bundle maps  $\text{Bun}(TS^{2n-1} \oplus \epsilon, \theta^*\gamma)$ .

**Lemma 35.1.1.** *For any  $2n$ -dimensional manifold  $W$ ,  $\text{Bun}(TW, \theta^*\gamma)$  is weakly equivalent to the space of lifts along  $\theta$  of “the” classifying map  $W \rightarrow BO(2n)$  of  $TW$ .*

We are justified in using “the” since the space of classifying maps of any vector bundle over reasonable base is weakly contractible (using the relative classifying property of the classifying space).

Takeaways:

- The manifolds  $W_{g,1}$  admit contractible spaces of  $\theta$ -structures, so we might as well use  $\text{Cob}^{\theta}(d)$  instead.
- By surgery on objects and morphisms, made possible using the  $\theta$ -structures, we can show that  $\Omega_0 BCob^{\theta}(d)$  is weakly equivalent a component of the group completion of  $\bigsqcup_{g \geq 0} B\text{Diff}_{\partial}(W_{g,1})$ .

*Proof.* We have that  $\ell \in \text{Bun}(TW, \xi)$  is given by pairs of a map  $l: W \rightarrow B$  and an isomorphism  $\lambda: TW \cong l^*\xi$ . If we fix a choice of tangent classifier for  $TW$  given by a map  $t: W \rightarrow BO(2n)$  and an isomorphism  $\tau: TW \cong t^*\gamma$ , then a lift  $t'$  of  $t$  along  $\theta$  gives us a bundle map  $TW \rightarrow \theta^*\gamma$  as the map  $t': W \rightarrow BO(2n)\langle n \rangle$  and the isomorphism  $TW \cong (t')^*\theta^*\gamma \cong t^*\gamma$ . Thus given  $(t, \tau)$  we get a map  $\text{Lift}_\theta(t) \rightarrow \text{Bun}(TW, \theta^*\gamma)$ .

We may change  $B$  by a homotopy equivalence, so by using the path-loop fibration we may suppose that  $\theta$  is a fibration. This implies that the map

$$\text{Bun}(\theta): \text{Bun}(TW, \theta^*\gamma) \rightarrow \text{Bun}(TW, \gamma)$$

is a fibration. It has image in the subspace of classifying maps for  $TW$ . This subspace is weakly contractible, so  $\text{Bun}(TW, \theta^*\gamma)$  is weakly equivalent to the subspace  $\text{Bun}(\theta)^{-1}(t, \tau)$ . By construction  $\text{Lift}_\theta(t) \rightarrow \text{Bun}(TW, \theta^*\gamma)$  factors over  $\text{Bun}(\theta)^{-1}(t, \tau)$ , and there is a homotopy inverse  $\text{Bun}(\theta)^{-1}(t, \tau) \rightarrow \text{Lift}_\theta(t)$  sending  $(l, \lambda)$  to  $l$ .  $\square$

Let  $F := \text{hofib}(BO(2n)\langle n \rangle \rightarrow BO(2n))$ , which has homotopy groups given by

$$\pi_i(F) = \begin{cases} \pi_i(O(2n)) & \text{if } i < n \\ 0 & \text{if } i \geq n \end{cases}$$

and one should think of it as  $O(2n)/O(2n)\langle n-1 \rangle$  (even though this does not make sense as  $O(2n)\langle n-1 \rangle$  is not a subgroup of  $O(2n)$ , or a group at all).

We may prove that single lift of  $TS^{2n-1} \oplus \epsilon$  exists by obstruction theory, as the obstruction classes in  $H^{i+1}(S^{2n-1}; \pi_i(F))$  all live in vanishing groups, and similarly it is unique up to homotopy once we fix an orientation as the obstructions for uniqueness lie in  $H^i(S^{2n-1}; \pi_i(F))$  (the orientation comes from  $H^0(S^{2n-1}; \pi_0(F)) \cong \mathbb{Z}/2\mathbb{Z}$ ).

An alternative argument uses the isomorphism  $TS^{2n-1} \oplus \epsilon \cong \epsilon^{\oplus 2n}$ . Using it, we may conclude that the space of  $\theta$ -structures is weakly equivalent to the mapping space  $\text{Map}(S^{2n-1}, F)$ . Using the fiber sequence

$$\Omega^{2n-1}F \rightarrow \text{Map}(S^{2n-1}, F) \rightarrow F$$

we see that  $\text{Map}(S^{2n-1}, F) \simeq F$ . This show  $\pi_0$  of the space of  $\theta$ -structures is  $\mathbb{Z}/2\mathbb{Z}$ , and also shows that space of  $\theta$ -structure is not weakly contractible.

### $\theta$ -structures on $W_{g,1}$

Let us pick a  $\theta$ -structure  $\ell_\partial$  near  $\partial W_{g,1}$  and let  $\text{Bun}_\partial(TW_{g,1}, \theta^*\gamma)$  denote the space of bundle maps extending  $\ell_\partial$ . We claim that this is weakly contractible.

To see that a single  $\theta$ -structure exists, note that the obstructions to extending  $\ell_\partial$  lie in  $H^{i+1}(W_{g,1}, \partial W_{g,1}; \pi_i(F))$ . As the homology groups vanishes if  $i+1 < n$  (i.e.  $i \leq n-2$ ) and the coefficients vanish if  $i \geq n$ , there is a single obstruction class in  $H^n(W_{g,1}, \partial W_{g,1}; \pi_{n-1}(O(2n)))$ . These obstruction class record whether the trivialization of the tangent bundle on the boundary of each of the  $2g$   $n$ -handles may be extended. We may show that it vanishes by noting that  $W_{1,1}$  admits a framing and hence so does  $W_{g,1}$ , and the restriction to a neighborhood of  $\partial W_{g,1} \cong S^{2n-1}$  of this framing is in particular a  $\theta$ -structure, and without loss of generality it is equal to  $\ell_\theta$ . For uniqueness there are no obstructions, so a  $\theta$ -structure extending  $\ell_\theta$  is unique up to homotopy.

If fact, by comparing to a framing one sees that the space of all  $\theta$ -structures is weakly equivalent to  $\text{Map}_*(W_g; F)$ , where  $W_g := \#_g(S^n \times S^n)$ . This fits into a fiber sequence

$$\Omega^{2n}(F) \rightarrow \text{Map}_*(W_g; F) \rightarrow \prod_{i=1}^{2g} \Omega^n F,$$

whose base and fiber are weakly contractible by our calculation of the homotopy groups of  $F$ . The conclusion is that  $\text{Bun}_\partial(TW_{g,1}, \theta^* \gamma)$  is weakly contractible, so that the moduli space of  $W_{g,1}$ 's with  $\theta$ -structure,

$$B\text{Diff}_\partial^\theta(W_{g,1}) := \text{Bun}_\partial(TW_{g,1}, \theta^* \gamma) // \text{Diff}_\partial(W_{g,1}),$$

is in fact weakly equivalent to  $B\text{Diff}_\partial(W_{g,1})$ .

This justifies the study of  $\text{Cob}^\theta(d)$  instead of  $\text{Cob}(d)$  if one is interested in diffeomorphism groups of  $W_{g,1}$ . The former has a technical advantage; embedded spheres of dimension  $\leq n$  in a  $\theta$ -manifold have a trivial normal bundle, and hence we can attempt to do surgery on them.

### 35.2 Surgery in cobordism category: statement

We start by stating the result of this lecture and do a rational computation.

#### Statement

Our definition of  $\text{Cob}^\zeta(d)$  was a colimit over  $N$  of topological categories  $\text{Cob}^\zeta(d, N)$ , whose space of objects was given by  $\mathbb{R} \times \Psi_{d-1}^\zeta(I^{N-1})$  and whose space of morphisms was a subspace of  $\mathbb{R}^2 \times \Psi_d^\zeta(\mathbb{R} \times I^{N-1})$ .

It is slightly more convenient to use instead a ‘‘Moore loop’’ variation. It shall also be useful to replace  $\Psi_{d-1}^\zeta(I^{N-1})$  and  $\Psi_d^\zeta(\mathbb{R} \times I^{N-1})$

with homeomorphic spaces  $\psi_{d-1}^{\zeta}(N-1, 0)$  and  $\psi_d^{\zeta}(N, 1)$ ; here  $\psi_d^{\zeta}(n, k)$  is defined to be the space of submanifolds of  $\mathbb{R}^k \times \mathbb{R}^{n-k}$  that are only allowed to go to infinity in the  $\mathbb{R}^k$ -directions.

**Definition 35.2.1.** The topological category  $\text{Cob}^{\zeta}[d, N]$  has space of objects given by  $\psi_{d-1}^{\zeta}(N-1, 0)$  and space of morphisms the subspace of  $[0, \infty) \times \psi_d^{\zeta}(N-1, 1)$  consisting of  $(t, W)$  such that  $W$  is a product outside of  $[0, t] \times \mathbb{R}^{N-1}$ .

The nerves of  $\text{Cob}^{\zeta}(d, N)$  and  $\text{Cob}^{\zeta}[d, N]$  are levelwise weakly equivalent, so their classifying spaces are weakly equivalent as well (recall these are defined using the thick geometric realization). Taking  $N \rightarrow \infty$ , we get a weak equivalence

$$BCob^{\zeta}(d) \simeq BCob^{\zeta}[d].$$

In contrast to  $\text{Cob}^{\zeta}(d)$ ,  $\text{Cob}^{\zeta}[d]$  has non-trivial endomorphisms and hence contains non-trivial monoids, to which we may attempt to apply the group completion theorem.

Taking  $d = 2n$  and  $\zeta = \theta$ , the strategy is to find a monoid  $\mathcal{M}$  (i.e. a subcategory with a single object) in  $\text{Cob}^{\theta}[2n]$  such that (i) the map

$$\Omega_0 B\mathcal{M} \rightarrow \Omega_0 BCob^{\theta}[2n]$$

is a weak equivalence, and (ii) there is a weak equivalence

$$\mathcal{M} \simeq \bigsqcup_{g \geq 0} B\text{Diff}_{\partial}^{\theta}(W_{g,1}),$$

with the monoid multiplication homotopic to boundary connected sum (which is easily seen to be homotopy commutative).

In the previous section we saw that for  $W_{g,1}$ ,  $\theta$ -diffeomorphisms are the same as ordinary diffeomorphisms, so we conclude there are weak equivalences

$$\Omega_0 B \left( \bigsqcup_{g \geq 0} B\text{Diff}_{\partial}^{\theta}(W_{g,1}) \right) \simeq \Omega_0 B\mathcal{M} \xrightarrow{\simeq} \Omega_0 BCob^{\theta}[2n] \simeq \Omega_0 BCob^{\theta}(d) \simeq \Omega_0^{\infty} MT\theta.$$

An application of the group completion theorem of McDuff-Segal [MS76] then gives Theorem 1.2 of [GRW14]:

**Theorem 35.2.2** (Galatius-Randal-Williams). *If  $n \geq 3$ , the stable homology of  $B\text{Diff}_{\partial}(W_{g,1})$  is computed by the isomorphism*

$$\text{colim}_{g \rightarrow \infty} H_*(B\text{Diff}_{\partial}(W_{g,1})) \cong H_*(\Omega_0^{\infty} MT\theta).$$

### Rational computation

We have that  $H_*(\Omega_0^\infty MT\theta; \mathbb{Q})$  is the free graded-commutative algebra on  $\pi_{*>0}(MT\theta) \otimes \mathbb{Q}$ . This is the same as the rational spectrum homology in positive degrees which may be identified with  $H_{*>2n}(BO(2n)\langle n \rangle; \mathbb{Q})$  shifted down by  $-2n$  using the Thom isomorphism, which applies since the base of  $\theta^*\gamma$  is simply-connected and hence  $\theta^*\gamma$  is orientable. We conclude that  $H_*(\Omega_0^\infty MT\theta; \mathbb{Q})$  is the free graded-commutative algebra on generators  $k_{\lambda^\vee}$ , where  $\lambda^\vee$  is a dual to a monomial  $\lambda$  in the Euler class  $e$  and Pontryagin classes  $p_i$  for  $\lceil \frac{n+1}{4} \rceil \leq i \leq n-1$  of total degree  $> 2n$ , in degree  $|\lambda| - 2n$ .

The weak equivalence  $B\text{Diff}_\partial(W_{g,1}) \simeq \Omega_0^\infty MT\theta$  is homotopic to a Pontryagin-Thom map. This implies that  $k_{\lambda^\vee}$  are dual to generalized MMM-classes  $\kappa_\lambda$  in cohomology. To define them, let

$$W_{g,1} // \text{Diff}_\partial(W_{g,1})$$

denote the universal  $W_{g,1}$ -bundle over  $B\text{Diff}_\partial(W_{g,1})$ , and take its vertical tangent bundle  $T_v$ , which is  $2n$ -dimensional. Given the monomial  $\lambda$ , we obtain  $\lambda(T_v) \in H^{|\lambda|}(W_{g,1} // \text{Diff}_\partial(W_{g,1}); \mathbb{Q})$ , and integrating over the  $2n$ -dimensional fiber gives the class  $\kappa_\lambda \in H^{|\lambda|-2n}(B\text{Diff}_\partial(W_{g,1}); \mathbb{Q})$ .

### 35.3 Surgery in cobordism category: proof outline

We now give an outline of the proof. Given that the entire paper [GRW14] is 74 pages long, we can not give full details.

#### Strategy

One starts with constructing a sequence of subcategories, with inclusions inducing weak equivalences upon taking classifying spaces:

$$\text{Cob}_{D,k,l}^\theta[2n] \hookrightarrow \text{Cob}_{D,k}^\theta[2n] \hookrightarrow \text{Cob}_D^\theta[2n] \hookrightarrow \text{Cob}^\theta[2n]. \quad (35.1)$$

We define them for finite  $N$  and take colimits as  $N \rightarrow \infty$ :

*Standard strip* To define  $\text{Cob}_D^\theta[2n, N]$  for  $N \geq 2n+1$ , we let  $D^{2n-1} \subset \mathbb{R}^{N-1}$  be given by taking  $S^{2n-1} \cap ((-\infty, 0] \times \mathbb{R}^{2n-1})$  and increasing the dimension to  $N-1$  by taking a product with  $\mathbb{R}^{N-1-2n}$ . We also fix a  $\theta$ -structure on  $D^{2n-1}$  by restricting  $\ell_\theta$  on  $S^{2n-1}$  to the bottom hemisphere.

Then  $\text{Cob}_D^\theta[2n, N]$  is the subcategory of  $\text{Cob}^\theta[2n, N]$  with objects given by  $X \in \psi_{d-1}^\theta(N-1, 0)$  such that  $(X, \ell) \cap ((-\infty, 0] \times \mathbb{R}^{N-2}) = (D^{2n-1}, \ell_\partial|_{D^{2n-1}})$  and morphisms given by  $(t, W, \ell)$  such that  $(W, \ell) \cap (\mathbb{R} \times (-\infty, 0] \times \mathbb{R}^{N-1}) = (\mathbb{R} \times D^{2n-1}, \mathbb{R} \times \ell_\partial)$ . That is,

**Example 35.2.3.** If  $n = 3$ , we have that  $H^*(\Omega_0^\infty(MT\theta); \mathbb{Q})$  is the free graded-commutative algebra

$$\mathbb{Q}[\kappa_e, p_1^*, p_2^* \mid 2nj + 4k + 8l > 6],$$

so only excluding  $\kappa_e$  and  $\kappa_{p_1}$ , as both  $i = 1, 2$  satisfy  $\lceil \frac{3+1}{4} \rceil \leq i \leq 3-1$ .

its intersection with the bottom half-space coincides a standard strip, as a manifold with  $\theta$ -structure.

*Highly-connected morphisms* For  $k \leq n - 1$ , let  $\text{Cob}_{D,k}^\theta[2n, N]$  be the subcategory where all morphisms  $(t, W)$  satisfy the property that the pair  $(W|_{[0,t]}, W|_t)$  is  $k$ -connected.

*Highly-connected objects* For  $k \leq n - 1$  and  $l \leq k$ , we let  $\text{Cob}_{D,k,l}^\theta[2n, N]$  be the subcategory of  $\text{Cob}_{D,k}^\theta[2n, N]$  with  $l$ -connected objects  $X$ .

We want to take  $d = 2n \geq 6$ ,  $k = n - 1$  and  $l = n - 1$ , and we get a weak equivalence

$$BCob_{D,n-1,n-1}^\theta[2n] \xrightarrow{\simeq} BCob^\theta[2n].$$

Note that the objects are  $(n - 1)$ -connected  $(2n - 1)$ -dimensional manifolds, so by Poincaré duality they must be homotopy equivalent to  $S^{2n-1}$ . of course, there can still be more than one isomorphism class of objects, due to the existence of exotic spheres.

Let  $\mathcal{A}$  be a set of isomorphism classes of objects containing at last one object in each path-component of classifying space and  $\text{Cob}_{D,n-1,n-1}^{\theta,\mathcal{A}}[2n]$  is the full subcategory on objects in  $\mathcal{A}$ . Then we have that  $BCob_{D,n-1,n-1}^\theta[2n]$  is weakly equivalent to  $BCob_{D,n-1,n-1}^{\theta,\mathcal{A}}[2n]$ . So let  $\bar{\mathcal{A}}$  be given by the class  $(S^{2n-1}, \ell_\partial)$  and one isomorphism class in each other path component, so that

$$BCob_{D,n-1,n-1}^{\theta,\bar{\mathcal{A}}}[2n] \xrightarrow{\simeq} BCob_{D,n-1,n-1}^\theta[2n].$$

Let us next take based loops at the object  $(S^{2n-1}, \ell_\partial)$  to get a weak equivalence of based loop spaces

$$\Omega BCob_{D,n-1,n-1}^{\theta,\bar{\mathcal{A}}}[2n] \simeq \Omega^\infty MT\theta.$$

The based loop space only sees the path component containing  $(S^{2n-1}, \ell_\partial)$ , and though there are still many objects, the space of such objects is path-connected. Now consider the simplicial space with  $p$ -simplices given by  $(N_0 \text{Cob}_{D,n-1,n-1}^{\theta,\bar{\mathcal{A}}}[2n])^{p+1}$ . Then the map

$$\begin{array}{ccc} N_p \mathcal{M} & \longrightarrow & N_p \text{Cob}_{D,n-1,n-1}^{\theta,\bar{\mathcal{A}}}[2n] \\ \downarrow & & \downarrow \\ * & \longrightarrow & (N_0 \text{Cob}_{D,n-1,n-1}^{\theta,\bar{\mathcal{A}}}[2n])^{p+1} \end{array}$$

with  $*$  in degree  $p$  mapping to the  $(p + 1)$ -fold product of  $(S^{2n-1}, \ell_\partial)$  is levelwise homotopy cartesian and satisfies the conditions for the Bousfield-Friedlander theorem<sup>1</sup> (Theorem 4.9 of [Gj09]). Thus upon

<sup>1</sup> The Bousfield-Friedlander theorem is a example of a theorem giving conditions under which homotopy pullbacks commute with geometric realization. See also [Rez14].

geometric realization we get a homotopy cartesian square

$$\begin{array}{ccc} B\mathcal{M} & \longrightarrow & BCob_{D,n-1,n-1}^{\theta,\bar{A}}[2n] \\ \downarrow & & \downarrow \\ * & \longrightarrow & ||[p] \mapsto (N_0Cob_{D,n-1,n-1}^{\theta,\bar{A}}[2n])^{p+1}|| \end{array}$$

with bottom right-hand corner contractible with an extra degeneracy argument.

Thus  $BCob_{D,n-1,n-1}^{\theta,\bar{A}}[2n]$  is weakly equivalent to classifying space of the full subcategory on the single object  $(S^{2n-1}, \ell_{\partial})$ . That is, we take  $\mathcal{M}$  to be endomorphism monoid of  $(S^{2n-1}, \ell_{\partial})$  in  $BCob_{D,n-1,n-1}^{\theta,\bar{A}}[2n]$ , and have a weak equivalence

$$\Omega B\mathcal{M} \simeq BCob_{D,n-1,n-1}^{\theta,\bar{A}}[2n].$$

We shall identify the homotopy type of  $\mathcal{M}$ . By scaling the  $t$ -coordinate of  $(t, W)$  this is the space of  $\theta$ -manifolds  $(W, \ell)$  in  $[0, 1] \times \mathbb{R}^{\infty-1}$  with the following properties:

- $(W, \ell) \cap (\{i\} \times \mathbb{R}^{\infty-1}) = (S^{2n-1}, \ell_{\partial})$  for  $i \in \{0, 1\}$ ,
- $(W, \ell) \cap (\mathbb{R} \times (-\infty, 0] \times \mathbb{R}^{\infty-2}) = (\mathbb{R} \times D^{2n-1}, \mathbb{R} \times \ell_{\partial})$ , and
- $W$  is  $(n-1)$ -connected.

By an argument as in Section 35.1, the spaces of  $\theta$ -structure are contractible if they are non-empty, so this weakly equivalent to

$$\bigsqcup_{[W]} B\text{Diff}_{\partial}(W),$$

where  $W$  ranges over all  $(n-1)$ -connected manifolds with boundary  $\partial W \cong S^{2n-1}$  whose tangent bundle is trivializable over the  $n$ -skeleton. The monoid structure coming from composition is given by boundary connected sum along the top hemispheres  $D^{2n-1} \subset S^{2n-1}$ . Thus using the group completion theorem we have that

$$H_* \left( \bigsqcup_{[W]} B\text{Diff}_{\partial}(W) \right) [\pi_0]^{-1} \cong H_*(\Omega_0 B\mathcal{M}).$$

There can be more diffeomorphism classes of manifolds  $W$  than just those of the  $W_{g,1}$ ; though their homotopy theory says that  $W \simeq W_{g,1}$ , by smoothing theory we can still change the smooth structure on a disk. Thus, up to elements that are already invertible we only need to invert  $W_{1,1}$ . We conclude that

$$H_* \left( \bigsqcup_{[W]} B\text{Diff}_{\partial}(W) \right) [W_{1,1}]^{-1} \cong H_*(\Omega^{\infty} MT\theta),$$

and restricting to the path-components of  $W_{g,1}$ , we obtain Theorem 35.2.2. We shall now outline the steps proving that all inclusions (35.1) induce a weak equivalence upon taking classifying spaces.

Creating a standard strip

We start by proving that  $BCob_D^\theta[2n, N] \hookrightarrow BCob^\theta[2n, N]$  is a weak equivalence for  $N \geq 2n + 1$ . It is done by comparing both sides to a space of  $\theta$ -manifolds in  $\mathbb{R} \times \mathbb{R}^N$ . Like in the first step of the proof of Barratt-Priddy-Quillen-Segal and Galatius-Madsen-Tillmann-Weiss theorems, there is a commutative diagram

$$\begin{array}{ccc}
 BCob_D^\theta[2n, N] & \longrightarrow & BCob^\theta[2n, N] \\
 \downarrow \simeq & & \downarrow \simeq \\
 \psi_{a,D}^\theta(N, 1) & \xrightarrow{\iota} & \psi_a^\theta(N, 1)
 \end{array} \tag{35.2}$$

with vertical maps weak equivalences, and  $\psi_{a,D}^\theta(N, 1)$  the subspace of  $\psi_a^\theta(N, 1)$  consisting of  $(W, \ell)$  such that  $(W, \ell) \cap (\mathbb{R} \times (-\infty, 0] \times \mathbb{R}^{N-2}) = (\mathbb{R} \times D^{2n-1}, \mathbb{R} \times \ell_\partial|_{D^{2n-1}})$ . There is a map  $\rho: \psi_a^\theta(N, 1) \rightarrow \psi_{a,D}^\theta(N, 1)$  by taking a diffeomorphism of  $\mathbb{R} \times \mathbb{R} \times \mathbb{R}^{N-2}$  onto  $\mathbb{R} \times (2, \infty) \times \mathbb{R}^{N-2}$  coming from an orientation-preserving diffeomorphism  $\mathbb{R} \rightarrow (2, \infty)$ , and adding a “tube”  $(\mathbb{R} \times S^{2n-1}, \mathbb{R} \times \ell_\partial)$ .

The identity on  $\psi_a^\theta(N, 1)$  is homotopic to the map  $\iota \circ \rho$  by sliding  $W$  up and sliding in a tube. This uses that there exists a  $\theta$ -structure on  $D^{2n}$  extending  $\ell_\partial$  on its boundary  $S^{2n-1}$ . A preferred choice is by rotating  $\ell_\partial|_{D^{2n-1}}$  around  $\partial D^{2n-1}$  (by uniqueness we may assume that the  $\theta$ -structure on  $S^{2n-1}$  is the restriction of this one). The map  $\rho \circ \iota$  is homotopic to the identity by connecting up the strip and the tube, which has a  $\theta$ -structure by rotating  $D^{2n-1}$  in the “other direction.” See Figure 35.1. Thus the bottom horizontal map in (35.2) is a homotopy equivalence and hence the horizontal map is a weak equivalence.

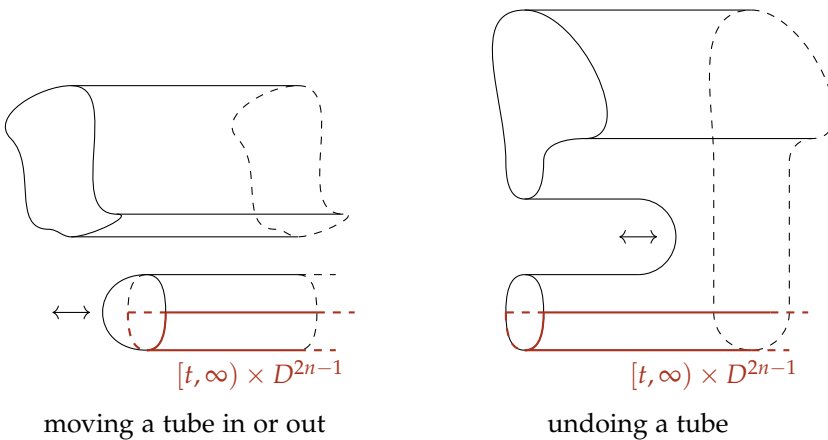

Figure 35.1: The “sliding in a tube” and “undoing a tube” homotopies



### Surgery on morphisms

Our next goal is to make the morphisms highly-connected relative to their outgoing boundary. This is done by induction over  $k$ , i.e. we prove all inclusions

$$\text{Cob}_{D,n-1}^\theta[2n, N] \hookrightarrow \dots \hookrightarrow \text{Cob}_{D,0}^\theta[2n, N] \hookrightarrow \text{Cob}_{D,-1}^\theta[2n, N] = \text{Cob}_D^\theta[2n, N]$$

induces weak equivalences upon taking classifying spaces as  $N \rightarrow \infty$ .

The following is a special case of Theorem 3.1 of [GRW14]:

**Theorem 35.3.1.** *The inclusion  $\text{Cob}_{D,k}^\theta[2n, N] \rightarrow \text{Cob}_{D,k-1}^\theta[2n, N]$  induces a weak equivalence on classifying spaces if (i)  $k \leq n - 1$ , and (ii)  $k + 1 + 2n < N$ .*

Given a morphism  $W|_{[0,t]}$ , an element of the relative homotopy group  $\pi_k(W|_{[0,t]}, W|_t)$  for  $k \leq n - 1$  can be killed by surgery as long as we can represent it by an embedded sphere with trivial normal bundle. But condition (i) in 35.3.1 means that we can arrange any map to be an embedding by transversality, while the  $\theta$ -structure takes care of the normal bundle. To implement this surgery in the classifying space, we replace  $B\text{Cob}_{D,k-1}^\theta[2n, N]$  by the geometric realization semi-simplicial space  $X_{\bullet}^{k,N}$  with  $p$ -simplices given by elements of  $\psi_{d,D}^\theta(N, 1)$  with intervals  $(a_i - \epsilon, a_i + \epsilon_i)$  such that for each pair of regular values  $t < t' \in \cup_i (a_i - \epsilon, a_i + \epsilon_i)$ , the bordism  $W|_{[t,t']}$  is  $k$ -connected relative to its outgoing boundary. In this space we can do a surgery move as in Figure 35.2 (though it needs to be modified to get the  $\theta$ -structures to work out, see Figure 3 of [GRW14]). This can be embedded in  $\mathbb{R}^N$  under condition (ii) of Theorem 35.3.1.

Of course there is no canonical choice of the surgery data that will make the morphisms in  $N_p$   $k$ -connected rel outgoing boundary. However, one may define a semi-simplicial space whose  $q$ -simplices contain  $q + 1$  pieces of surgery data and show this is weakly contractible. Using more than one piece of surgery data is fine: we may “overkill” relative homotopy groups, all this does is add some more relative homotopy in degree  $k + 1$ .

### Surgery on objects

After making the morphisms  $(n - 1)$ -connected relative to the outgoing boundary, we make the objects highly-connected by induction over  $l$ , i.e. we prove all inclusions

$$\text{Cob}_{D,n-1,n-1}^\theta[2n, N] \hookrightarrow \dots \hookrightarrow \text{Cob}_{D,n-1,0}^\theta[2n, N] \hookrightarrow \text{Cob}_{D,n-1,-1}^\theta[2n, N] = \text{Cob}_{D,n-1}^\theta[2n, N]$$

induces weak equivalences upon taking classifying spaces as  $N \rightarrow \infty$ .

The left-most step — surgery in the middle dimension — will be

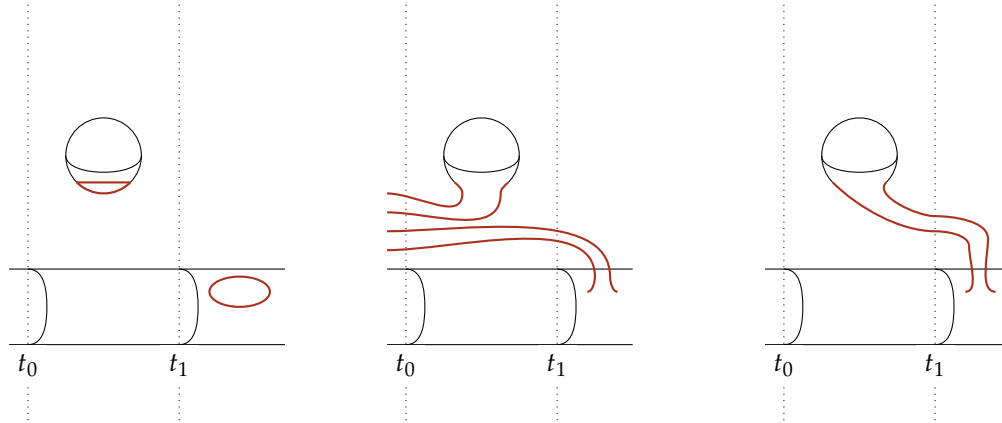

Figure 35.2: A surgery move in the case  $k = 0$ , i.e. making morphisms path-connected relative to the outgoing boundary when  $2n = 2$ .

harder than the other ones so we have two theorems, which are special cases of Theorems 4.1 and 5.2 of [GRW14].

**Theorem 35.3.2.** *The inclusion  $\text{Cob}_{D,k,l}^\theta[2n, N] \hookrightarrow \text{Cob}_{D,k,l-1}^\theta[2n, N]$  induces a weak equivalence on classifying space if  $2(l+1) < 2n$ ,  $l \leq k$ ,  $l \leq 2n - k - 2$ , and  $l + 2 + 2n < N$ .*

**Theorem 35.3.3.** *The inclusion  $\text{Cob}_{D,n-1,n-1}^\theta[2n, N] \hookrightarrow \text{Cob}_{D,n-1,n-2}^\theta[2n, N]$  induces a weak equivalence on classifying space if  $2n \geq 6$  and  $3n + 1 < N$ .*

The idea is similar as before; using surgery moves indexed by weakly contractible spaces of surgery data to increase connectivity of the objects. The connectivity of the morphisms is necessary, providing the existence of paths for the surgery moves.

## 36

### *The Weiss fiber sequence*

Having given the outline of the Galatius-Randal-Williams theorem  $H_*(B\text{Diff}_\partial(W_{g,1})) \cong H_*(\Omega_0^\infty MT\theta)$  for  $* \leq \frac{g-3}{2}$ , we will use this to get information about  $H_*(B\text{Diff}_\partial(D^{2n}))$ . This involves thinking of diffeomorphisms of a disk as “the difference” between diffeomorphisms and a space of self-embeddings. In the next lecture we will study these self-embeddings using embedding calculus. The ideas are due to Weiss [Wei15], and appeared in a slightly different form in [Kup17].

#### 36.1 *Monoids of self-embeddings*

##### *A first definition*

Let us fix a  $n$ -dimensional smooth manifold  $M$  with boundary  $\partial M$ . Let us also fix a codimension zero submanifold  $K \subset \partial M$ . Then let  $K^c := \partial M \setminus K$ , an open submanifold of  $\partial M$ . We shall denote  $\bar{M} := M \cup \partial M \times [0, 1]$ , the union taken along  $\partial M \subset M$  and  $\partial M \times \{0\} \times M \times [0, 1]$ .

**Definition 36.1.1.** Let  $\text{Emb}_K(M)$  be the space of embeddings  $M \hookrightarrow \bar{M}$  with image in  $M \setminus K^c \subset \bar{M}$  and fixing  $K \subset \partial M \times \{0\} \subset \bar{M}$ .

Note that such embeddings are really a map  $M \rightarrow M$  (though we used the above definition to avoid discussions about boundary conditions) and may be composed. This gives  $\text{Emb}_K(M)$  the structure of a (non)-unital monoid, though it has a unit up to homotopy.

##### *The complement*

We can extract a manifold with corners out of  $\varphi \in \text{Emb}_K(M)$ :

$$C(\varphi) := \bar{M} \setminus (\text{im}(\varphi) \cup K \times [0, 1]),$$

whose boundary is canonically identified with  $\partial(K^c \times [0, 1])$ .

Let  $\mathcal{C}_K$  denote the set of diffeomorphism classes of  $n$ -dimensional manifolds with boundary identified with  $\partial(K^c \times [0, 1])$ . Given  $W, W' \in$

$\mathcal{C}_K$ , we may form  $W \square W'$  by identifying  $K^c \times \{1\} \subset W$  with  $K^c \times \{0\} \subset W'$  and identifying  $\partial(K^c \times [0, 2])$  with  $\partial(K^c \times [0, 1])$  by rescaling the second term by  $1/2$ . This is associative and has unit  $K^c \times [0, 1]$ .

**Lemma 36.1.2.** *We have that  $C(\varphi \circ \psi) \cong C(\varphi) \square C(\psi)$ .*

*Proof.* For  $\epsilon > 0$  small enough, we can find an extension of  $\varphi$  to  $\tilde{\varphi}: M \cup M \times [0, \epsilon]$  that is the identity on  $K \times [0, \epsilon]$ . Then  $C(\tilde{\varphi}) := M \setminus (\text{im}(\tilde{\varphi}) \cup K \times [0, 1])$  is clearly diffeomorphic to  $C(\varphi)$  by moving along the collar.

Furthermore,  $C(\psi)$  is clearly diffeomorphic to  $C_\epsilon(\psi) := M \cup \partial M \times [0, \epsilon] \setminus (\text{im}(\psi) \cup K \times [0, \epsilon])$ . The identification

$$C(\varphi \circ \psi) \cong \tilde{\varphi}(C_\epsilon(\psi)) \square C(\tilde{\varphi}) \cong C(\varphi) \square C(\psi),$$

proves the desired equation in  $\mathcal{C}_K$ , see Figure 36.1. □

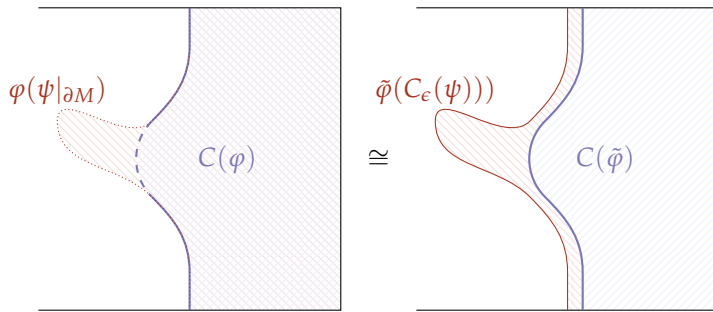

Figure 36.1: A diagrammatic picture explaining Lemma 36.1.2.

This means that there is a homomorphism from  $\text{Emb}_K(M)$  to the monoid  $\mathcal{C}_K$ .

**Definition 36.1.3.** Let  $\mathcal{C} \subset \mathcal{C}_K$  be a submonoid, then  $\text{Emb}_K^{\mathcal{C}}(M)$  denote the submonoid of  $\text{Emb}_K(M)$  of the connected components mapping to  $\mathcal{C}$ .

Which elements of  $\mathcal{C}_K$  lie in the image of  $\text{Emb}_K(M)$ ? A relative  $h$ -cobordism between two manifolds with boundary  $V, V'$  with  $\partial V = L = \partial V'$  is a manifold with corners  $W$  with  $\partial W = V \cup V' \cup L \times [0, 1]$ . Below we shall have  $V = K^c = V'$  and  $L = \partial K^c$ .

**Lemma 36.1.4.** *If  $K^c$  is simply-connected and  $\varphi$  is homotopy equivalence, then we have that  $C(\varphi)$  is a relative  $h$ -cobordism on  $K^c$ .*

*Proof.* It suffices to prove that both inclusions of  $K^c \hookrightarrow C(\varphi)$  are weak equivalences. Let us assume for convenience that  $K^c$  is path-connected, applying Siefert-van Kampen to the pushout

$$\begin{array}{ccc} K^c \times \{0\} & \longrightarrow & C(\varphi) \\ \downarrow & & \downarrow \\ \text{im}(\varphi) \cong M & \longrightarrow & M \cup K^c \times [0, 1] \end{array}$$

gives the pushout diagram of groups

$$\begin{array}{ccc} \pi_1(K^c \times \{0\}) \cong 0 & \longrightarrow & \pi_1(C(\varphi)) \\ \downarrow & & \downarrow \\ \pi_1(\text{im}(\varphi)) & \xrightarrow{\cong} & \pi_1(M \cup K^c \times [0, 1]), \end{array}$$

and we conclude that the map  $\pi_1(M) \rightarrow \pi_1(M) * \pi_1(C(\varphi))$  induced by an isomorphism of  $\pi_1(M)$  and the inclusion onto the first term is an isomorphism, and hence  $\pi_1(C(\varphi)) = 0$ , so that  $\pi_1(K^c \times \{0\}) \rightarrow \pi_1(C(\varphi))$  is an isomorphism. It then also follows that the  $\pi_1(K^c \times \{1\}) \rightarrow \pi_1(C(\varphi))$  is an isomorphism.

Then we consider homology. By excision, we have that

$$H_*(C(\varphi), K^c \times \{0\}) \cong H_*(M \cup K^c \times [0, 1], \text{im}(\varphi))$$

and the right hand side vanishes since  $\varphi$  was assumed a homotopy equivalence. By Poincaré duality we also get that  $H_*(C(\varphi), K^c \times \{1\}) = 0$ .  $\square$

### 36.2 Self-embeddings of $W_{g,1}$

We shall soon specialize to  $W_{g,1}$ , but first prove that it is quite common that an embedding is a homotopy equivalence.

**Lemma 36.2.1.** *Let  $M$  be the complement of the interior disk  $D^n$  in a simply-connected closed manifold  $N$  with torsion-free homology groups. Any embedding  $\psi: M \hookrightarrow M$  is a homotopy equivalence.*

*Proof.* We claim that  $\psi_*$  is injective; this follows from the fact that the intersection product between degrees  $i$  and  $n - i$  (for  $i > 0$ ) is non-degenerate and preserved by  $\psi_*$  up to sign  $\epsilon$ . Thus, if we suppose that for  $i > 0$  and  $x \in H_i(M)$  is non-zero, take  $y \in H_{n-i}(M)$  such that  $x \cdot y \neq 0$ , then  $\psi_*(x) \cdot \psi_*(y) \neq 0$  as well and hence  $\psi_*(x) \neq 0$ .

We next claim that  $\psi_*$  is surjective. By counting dimensions,  $\psi_*$  is surjective after tensoring with  $\mathbb{Q}$ . Take a generating set  $x_1, \dots, x_n$  of  $H_i(M)$  such that there exist  $y_1, \dots, y_n \in H_{n-i}(M)$  such that  $x_i \cdot y_j = \delta_{ij}$ . Then consider  $z \in H_i(M)$ , and write  $z - \sum_i \epsilon(z \cdot \psi_*(y_i)) \psi_*(x_i)$ . We claim that this is 0 in  $H_i(M; \mathbb{Q})$ ; this follows since the  $-\cdot \psi(y_i)$  are a basis of  $H_i(M; \mathbb{Q})^\vee$ . But  $H_i(M) \hookrightarrow H_i(M; \mathbb{Q})$ , so  $\psi_*$  is surjective.

Thus  $\psi_*$  is a homology isomorphism and by Whitehead's theorem it is a homology equivalence.  $\square$

Let us now take  $M = W_{g,1}$  and  $K = D_-^{2n-1} \subset S^{2n-1} = \partial W_{g,1}$  the bottom hemisphere. Then by Lemma's 36.1.4 and 36.2.1, if  $n \geq 3$ , we may use the  $h$ -cobordism theorem to conclude that  $C(\varphi)$  is homeomorphic to  $D_-^{2n-1} \times [0, 1]$ . Thus the image of  $\text{Emb}_{D_-^{2n-1}}(W_{g,1})$

lies in the subset  $\Theta$  of diffeomorphism classes of  $2n$ -dimensional manifolds with boundary identified with  $\partial(D^{2n-1} \times [0, 1])$  that are homeomorphic to  $D^{2n-1} \times [0, 1]$  rel boundary. Let  $\Theta_0 \subset \Theta$  be the class of  $D^{2n-1} \times [0, 1]$  rel boundary. The embedding space of interest will be  $\text{Emb}_{D^{2n-1}}^{\Theta_0}(W_{g,1})$ .

**Remark 36.2.2.** We shall give a few different interpretations of these spaces of self-embeddings.

Firstly,  $\text{Emb}_{D^{2n-1}}^{\Theta_0}(W_{g,1})$  may be thought of as those isotopy classes of embeddings  $\bar{\alpha}$  are isotopic to a diffeomorphism. Secondly, Weiss proved that  $\text{Emb}_{D^{2n-1}}^{\Theta}(W_{g,1}) \simeq \text{Diff}_{\partial}(W_{g,1} \setminus \{*\})$  for  $* \in \partial W_{g,1}$ . Thirdly,  $\text{Emb}_{D^{2n-1}}^{\Theta}(W_{g,1})$  may be thought of as homeomorphisms of  $W_{g,1}$  with a lift of its (topological microbundle) differential to a linear map over the  $n$ -skeleton.

### 36.3 The Weiss fiber sequence

A minor defect of our construction is that there is no monoid maps from  $\text{Diff}_{\partial}(W_{g,1})$  to either model. Instead, we shall use moduli spaces of manifolds to produce a map

$$B\text{Diff}_{\partial}(W_{g,1}) \rightarrow B\text{Emb}_{D^{2n-1}}^0(\bar{W}_{g,1})$$

up to homotopy.

#### A different model

We shall first give a different model for this space of self-embeddings. To do so, we introduce  $\bar{W}_{g,1}$ . These are defined by taking  $\bar{W} := D_+^{2n-1} \times [0, 1] \# (S^n \times S^n) \subset [0, 1] \times \mathbb{R}^{\infty}$  and letting  $\bar{W}_{g,1} = D_+^{2n-1} \times [0, 1] \cup \bigsqcup_{i=1}^g (\bar{W} + i \cdot e_1)$ . Thus  $\partial \bar{W}_{g,1} \cong D_+^{2n-1} \times \{0, 1\} \cup S^{2n-2} \times [0, g+1]$ .

**Definition 36.3.1.** Let  $\text{Emb}_{D_+^{2n-1}}(\bar{W}_{g,1})$  be the space of embeddings

$\varphi: \bar{W}_{g,1} \hookrightarrow \bar{W}_{g,1}$  with following properties:

- (i)  $\varphi$  is the identity on  $D_+^{2n-1} \times \{0\}$ ,
- (ii)  $\varphi$  maps  $\text{int}(D_+^{2n-1}) \times \{g+1\}$  into the interior of  $\bar{W}_{g,1}$ ,
- (iii)  $\varphi$  is given by  $\text{id} \times \text{scaling}$  on  $S^{2n-2} \times [0, g+1]$  (necessarily the scaling is by a number  $< 1$ ).

This is clearly a monoid under composition, and we let  $\text{Emb}_{D^{2n-1}}^0(\bar{W}_{g,1})$  be the subspace of embeddings such that the closure of  $\bar{W}_{g,1} \setminus \text{im}(\varphi)$  is diffeomorphic to  $D^{2n-1} \times [0, 1]$  rel boundary up to rescaling in the second term. The following is an annoying, essentially following from the existence of inclusions  $W_{g,1} \hookrightarrow \bar{W}_{g,1}$  and  $\bar{W}_{g,1} \hookrightarrow W_{g,1}$ .

**Lemma 36.3.2.** We have that  $\text{Emb}_{D_+^{2n-1}}^0(\bar{W}_{g,1}) \simeq \text{Emb}_{D_-^{2n-1}}^{\Theta_0}(W_{g,1})$ .

### Moduli spaces of manifold models

We shall give a geometric model for  $B\text{Diff}_\partial(W_{g,1})$ , which is similar to the monoid  $\mathcal{M}$  which appeared at the end the last lecture, without the  $\theta$ -structures. To define it, we pick an embedding of  $S^{2n-1}$  into  $\mathbb{R} \times \mathbb{R}^\infty$  whose intersection with  $(-\infty, 0] \times \mathbb{R}^\infty$  is  $D_-^{2n-1}$ .

**Definition 36.3.3.** Let  $\mathcal{M}^g(S^{2n-1})$  be given by the space of pairs  $(t, W) \in [0, \infty) \times \psi_{2n}(\infty, 1)$  that satisfy

- (i)  $W|_{(-\infty, 0]} = (-\infty, 0] \times S^{2n-1}$  and  $W|_{[t, \infty)} = [0, \infty) \times S^{2n-1}$ .
- (ii)  $W \cap (\mathbb{R} \times (-\infty, 0] \times \mathbb{R}^\infty) = \mathbb{R} \times D_-^{2n-1}$ .
- (iii) We have  $t > 0$  if  $g > 0$ .
- (iv) If  $t > 0$ ,  $W|_{[0, t]} \setminus ([0, t] \times \text{int}(D^{2n-1}))$  is diffeomorphic to  $\bar{W}_{g,1}$  rel boundary up to rescaling  $[0, g+1]$  to  $[0, t]$ .

Note that the space  $\mathcal{M}^0(S^{2n-1})$  is a unital monoid under the operation  $(t, W) \boxplus (t', W') = (t + t', W'')$  with  $W''$  given by  $W'' \cap ((-\infty, t] \times \mathbb{R}^\infty) = W \cap ((-\infty, t] \times \mathbb{R}^\infty)$  and  $W'' \cap ([t, \infty) \times \mathbb{R}^\infty) = W' \cap ([t, \infty) \times \mathbb{R}^\infty)$ , with unit given by  $(0, \mathbb{R} \times S^{2n-1})$ . The space  $\mathcal{M}^g(S^{2n-1})$  is a right  $\mathcal{M}^0(S^{2n-1})$ -module.

**Lemma 36.3.4.** For each  $g \geq 0$ ,  $\mathcal{M}^g(S^{2n-1}) \simeq B\text{Diff}_\partial(W_{g,1})$  and the operation  $\boxplus$  is homotopic to boundary connected sum.

*Proof.* By scaling we may deformation retract  $\mathcal{M}^g(S^{2n-1})$  onto the subspace with  $t = g + 1$ . This is homeomorphic to the quotient of the space of embeddings of  $\bar{W}_{g,1}$  into  $[0, g+1] \times [0, \infty) \times \mathbb{R}^\infty$  by the diffeomorphisms of  $\bar{W}_{g,1}$  fixing  $\partial\bar{W}_{g,1}$  pointwise. Since this is an action with local slices, this quotient is a model for  $B\text{Diff}_\partial(W_{g,1})$ . Under this identification,  $\boxplus$  indeed corresponds to boundary connected sum.  $\square$

### The fiber sequence

Our goal is to compute  $\mathcal{M}^g(S^{2n-1}) // \mathcal{M}^0(S^{2n-1})$ , which fits into a fiber sequence

$$\mathcal{M}^g(S^{2n-1}) \longrightarrow \mathcal{M}^g(S^{2n-1}) // \mathcal{M}^0(S^{2n-1}) \longrightarrow * // \mathcal{M}^0(S^{2n-1}),$$

since  $\mathcal{M}^0(S^{2n-1})$  is path-connected. This is a consequence of the following general statement:

**Lemma 36.3.5.** Let  $\mathbf{A}$  be a unital topological monoid and  $\mathbf{M}$  a right  $\mathbf{A}$ -module. Then if  $\mathbf{M}$  is group-like, there is a fiber sequence

$$\mathbf{M} \rightarrow \mathbf{M} // \mathbf{A} \rightarrow * // \mathbf{A}.$$

*Proof.* This is a consequence of a result of Segal we used before; if  $E_\bullet \rightarrow B_\bullet$  is a map of semi-simplicial spaces such that for each injective  $\theta: [q] \rightarrow [p]$  in  $\Delta$  we have that

$$\begin{array}{ccc} E_p & \xrightarrow{\theta^*} & E_q \\ \downarrow & & \downarrow \\ B_p & \longrightarrow & B_q \end{array}$$

homotopy cartesian, then so is

$$\begin{array}{ccc} E_0 & \xrightarrow{\theta^*} & ||E_\bullet|| \\ \downarrow & & \downarrow \\ B_0 & \longrightarrow & ||B_\bullet||. \end{array}$$

Apply this to  $E_\bullet = B_\bullet(\mathbf{M}, \mathbf{A}, *)$  and  $B_\bullet = B_\bullet(*, \mathbf{A}, *)$  and the map given by projecting away  $\mathbf{M}$ . Since a composite of homotopy cartesian square is homotopy cartesian, we may check  $d_i$  only. Since products preserve homotopy cartesianness, we may reduce to checking that the map  $(\text{act}, \pi_2): \mathbf{M} \times \mathbf{A} \rightarrow \mathbf{M} \times \mathbf{A}$  is a weak equivalence. By fibering over  $\mathbf{A}$ , it suffices to check that for each  $a \in \mathbf{A}$  acting by  $a$  is a weak equivalence on  $\mathbf{M}$ . Then the group-like property allows us to reduce to the identity component, and it suffices to check on a single element; for the identity it is obvious,  $\square$

To compute the middle term, we shall write down a semi-simplicial resolution of  $X_\bullet$  of  $\mathcal{M}^g(S^{2n-1})$  for  $g > 0$ .

**Definition 36.3.6.** Let  $g > 0$ , then the semi-simplicial space  $X_\bullet$  has  $p$ -simplices  $X_p$  given by the data of

- (a)  $(t, W) \in \mathcal{M}^g(S^{2n-1})$ ,
- (b) an embedding  $\varphi_p: \bar{W}_{g,1} \hookrightarrow W|_{[0,t]}$  with following properties:
  - (i)  $\varphi_p$  is the identity on  $D_+^{2n-1} \times \{0\}$ ,
  - (ii)  $\varphi_p$  maps  $\text{int}(D_+^{2n-1}) \times \{g+1\}$  into the interior of  $W|_{[0,t]}$ ,
  - (iii)  $\varphi_p$  is given by  $\text{id} \times \text{scaling}$  on  $S^{2n-2} \times [0,t]$  (necessarily the scaling is by a number  $< \frac{t}{g+1}$ ),
  - (iv) the closure of  $W|_{[0,t]} \setminus \text{im}(\varphi_p)$  is diffeomorphic to  $D_+^{2n-1} \times [0,1]$  rel boundary up to rescaling in the second term.
- (c) a  $p$ -tuple of embeddings  $\varphi_i: \bar{W}_{g,1} \hookrightarrow \bar{W}_{g,1}$  in  $\text{Emb}_{D_+^{2n-1}}^0(\bar{W}_{g,1})$  for  $0 \leq i \leq p-1$ .

The face maps compose or forget embeddings, and the augmentation forgets all embeddings.

This should remind the reader of a mix of  $\mathcal{M}^g(S^{2n-1})$  with

$$B_\bullet(*, \text{Emb}_{D_+^{2n-1}}^0(\bar{W}_{g,1}), \text{Emb}_{D_+^{2n-1}}^0(\bar{W}_{g,1})),$$



which is weakly contractible by an extra degeneracy argument:

**Lemma 36.3.7.** *If  $n \neq 2$ , the map  $\epsilon: ||X_\bullet|| \rightarrow \mathcal{M}^g(S^{2n-1})$  is a weak equivalence.*

*Proof.* By the isotopy extension theorem, the map  $\epsilon$  is a fiber bundle and thus it suffices to prove that the fibers are weakly contractible. Given a continuous map  $S^i \rightarrow \epsilon^{-1}(W, t)$  there exists an  $\psi: \bar{W}_{g,1} \rightarrow W|_{[0,t]}$  satisfying the properties in (b), whose image contains all these embeddings and whose complement is diffeomorphic to a disk. This may be used to cone off the continuous map, by letting the other embeddings be determined uniquely as factoring over  $\psi$ . These have the correct complement, since the set of smooth structure on a disk forms a groups under boundary connected sum.  $\square$

We can apply  $- \parallel \mathcal{M}^0(S^{2n-1})$  to get a semi-simplicial resolution for  $\mathcal{M}^g(S^{2n-1}) \parallel \mathcal{M}^0(S^{2n-1})$ . There is semi-simplicial map

$$X_\bullet \parallel \mathcal{M}^0(S^{2n-1}) \rightarrow N_\bullet \text{Emb}_{D_+^{2n-1}}^0(W_{g,1})$$

given by remembering only the  $p$ -tuple of embeddings.

**Lemma 36.3.8.** *For each  $p \geq 0$ , the map  $X_p \parallel \mathcal{M}^0(S^{2n-1}) \rightarrow N_p \text{Emb}_{D_+^{2n-1}}^0(W_{g,1})$  is a weak equivalence.*

*Proof.* By contractibility of spaces of embeddings into infinite-dimensional Euclidean spaces, we may assume that the image of  $\varphi_p$  is exactly  $\bar{W}_{g,1}$ . We may similarly assume that the complement of  $W|_{[0,t]}$  lies outside  $[0, g+1] \times \mathbb{R}^\infty$ . This subspace of  $X_p \parallel \mathcal{M}^0(S^{2n-1})$  is homeomorphic to  $N_p \text{Emb}_{D_+^{2n-1}}^0(W_{g,1}) \times (\mathcal{M}^0(S^{2n-1}) \parallel \mathcal{M}^0(S^{2n-1}))$ , and the latter term is weakly contractible.  $\square$

The conclusion is a zigzag of weak equivalences

$$\begin{array}{ccc} & X_\bullet \parallel \mathcal{M}^0(S^{2n-1}) \parallel & \\ & \swarrow \simeq & \searrow \simeq \\ ||N_\bullet \text{Emb}_{D_+^{2n-1}}^0(W_{g,1})|| & & \mathcal{M}^g(S^{2n-1}) \parallel \mathcal{M}^0(S^{2n-1}) \\ \downarrow \simeq & & \downarrow \simeq \\ B\text{Emb}_{D_+^{2n-1}}^0(W_{g,1}) & & B\text{Diff}_\partial(W_{g,1}) \parallel B\text{Diff}_\partial(D^{2n}), \end{array}$$

and the map  $B\text{Diff}_\partial(W_{g,1}) \rightarrow B\text{Emb}_{D_+^{2n-1}}^0(\bar{W}_{g,1})$  is determined by the inclusion

$$B\text{Diff}_\partial(W_{g,1}) \rightarrow B\text{Diff}_\partial(W_{g,1}) \parallel B\text{Diff}_\partial(D^{2n}),$$

which fits into a fiber sequence

$$B\text{Diff}_\partial(W_{g,1}) \rightarrow B\text{Emb}_{D_+^{2n-1}}^0(\bar{W}_{g,1}) \rightarrow * // B\text{Diff}_\partial(D^{2n}).$$

Since  $B\text{Diff}_\partial(D^{2n})$  is path-connected, it may be recovered from  $* // B\text{Diff}_\partial(D^{2n})$  by taking based loops.

# 37

## Embedding calculus

In the last lecture we saw there is a fiber sequence

$$B\text{Diff}_\partial(W_{g,1}) \longrightarrow B\text{Emb}_{D^{2n-1}}^{\text{O}_0}(W_{g,1}) \longrightarrow B^2\text{Diff}_\partial(D^{2n}).$$

Today we shall explain how to study the middle term using embedding calculus. The main reference is [BdBW13], but see also [Weig9] for more explicit results.

Takeaways:

- Studying embeddings through their restrictions to embedded  $\mathbb{R}^n$ 's in the domain recovers under mild conditions the entire homotopy type of the space of embeddings.
- Filtering by the number of  $\mathbb{R}^n$ 's gives a tower which is remarkably computable.

### 37.1 Embeddings and immersions

There is a slogan that embedding calculus is the pointillistic study of manifolds. As a motivation we shall give an example of what a first naive attempt at such a theory can see.

For the moment, let  $M$  and  $N$  be  $n$ -dimensional manifolds with empty boundary. How does one study the space of embeddings  $\text{Emb}(M, N)$ ? A good strategy would be to precompose with an embedding  $L \hookrightarrow M$  for  $L$  so that one understands the embeddings of  $L$  into a  $n$ -dimensional well. We have only done this for one example of  $L$ ;  $L = \bigsqcup_k \mathbb{R}^n$ . In that case we have seen that  $\text{Emb}(\bigsqcup_k \mathbb{R}^n, N)$  fits into a pullback diagram

$$\begin{array}{ccc} \text{Emb}(\bigsqcup_k \mathbb{R}^n, N) & \longrightarrow & \text{Fr}^{\text{GL}}(TN)^k \\ \downarrow & & \downarrow \\ \text{Emb}(\bigsqcup_k *, N) \simeq \text{Conf}_k(M) & \longrightarrow & M^k \end{array}$$

where we shall use  $\text{Conf}_k(M)$  as shorthand for the ordered configuration space of  $k$  particles in  $N$ .

There is no canonical choice of  $\bigsqcup_k \mathbb{R}^n \hookrightarrow M$  to restrict along. The strategy is to take all choices. As a first attempt we might try to extract information out of the composition map

$$\text{Emb}\left(\bigsqcup_k \mathbb{R}^n, M\right) \times \text{Emb}(M, N) \rightarrow \text{Emb}\left(\bigsqcup_k \mathbb{R}^n, N\right).$$

This is not a bad idea. In the case  $k = 1$ , we get a map

$$\mathrm{Fr}^{\mathrm{GL}}(TM) \times \mathrm{Emb}(M, N) \rightarrow \mathrm{Fr}^{\mathrm{GL}}(TN),$$

and upon adjoining the first term in the domain over, we get a map

$$\mathrm{Emb}(M, N) \rightarrow \mathrm{Map}(\mathrm{Fr}^{\mathrm{GL}}(TM), \mathrm{Fr}^{\mathrm{GL}}(TN)).$$

But in fact we land in a smaller subspace of the target: the space  $\mathrm{Bun}(TM, TN)$  of bundle maps, i.e.  $TM \rightarrow TN$  that map each fiber linearly onto a fiber. This map is essentially the derivative. We can complete it to a commutative diagram

$$\begin{array}{ccc} \mathrm{Emb}(M, N) & \xrightarrow{\quad\quad\quad} & \mathrm{Map}(\mathrm{Fr}^{\mathrm{GL}}(TM), \mathrm{Fr}^{\mathrm{GL}}(TN)) \\ \downarrow & \searrow^D & \nearrow \\ \mathrm{Imm}(M, N) & \xrightarrow{D} & \mathrm{Bun}(TM, TN) \end{array}$$

with the map  $\mathrm{Imm}(M, N) \rightarrow \mathrm{Bun}(TM, TN)$  being a weak equivalence if  $M$  has no compact component, by Smale-Hirsch [[Sma59a](#), [Las70a](#)].

One way wonder about the difference between  $\mathrm{Emb}(*, M)$  and  $\mathrm{Emb}(\mathbb{R}^n, M)$ . The latter would give rise to the map  $\mathrm{Emb}(M, N) \rightarrow \mathrm{Map}(M, N)$  remembering that an embedding is in particular a continuous map. There are examples of manifolds where no immersion exists in a homotopy class of continuous maps (e.g. the identity homotopy class of the Möbius strip into  $S^1 \times \mathbb{R}$ ), so remembering the underlying immersion instead of the underlying continuous map certainly captures more information.

## 37.2 Manifold calculus

We shall explain the outline of a theory which, when applied to  $\mathrm{Emb}(-, N)$ , produces embedding calculus. This is called *manifold calculus*, and our discussion shall follow [[BdBW13](#)]. There are other approaches to embedding calculus; a more classical one restricts attention to a single manifold and uses the (discrete) poset  $\mathcal{O}(M)$  of open subsets diffeomorphic to a disjoint union of disks in place of  $\mathrm{Disk}_n$ , [[Wei99](#)]. A more modern one studies functors out of an  $\infty$ -category of configuration, [[BdBW15](#)].

### Setting up manifold calculus

If we reflect composition maps, we realize that if we consider them for each  $k$  individually we are forgetting that there are compatibilities between them. This can neatly encoded by thinking of  $\mathrm{Emb}(-, N)$  as an invariant presheaf on smooth  $n$ -manifolds.

That is, we can define the topologically-enriched category  $\text{Mfd}_n$  with objects  $n$ -dimensional manifolds  $M$  with empty boundary, and morphism spaces from  $M$  to  $M'$  given by the space of embeddings  $\text{Emb}(M, M')$ . Then an *invariant presheaf on smooth  $n$ -manifolds* is a continuous functor  $\text{Mfd}_n^{\text{op}} \rightarrow \text{Spaces}$ , and  $\text{Emb}(-, N)$  is indeed such a continuous functor.

Embedding calculus proposes to study  $\text{Emb}(-, N)$  by its restriction to the subcategory  $\text{Disk}_n$ , the full subcategory on those objects diffeomorphic to  $\bigsqcup_k \mathbb{R}^n$  for some  $k \geq 0$ , or the even smaller subcategories  $\text{Disk}_n^{\leq k}$  where all objects are diffeomorphic to  $\bigsqcup_{k'} \mathbb{R}^n$  for  $k' \leq k$ . Denote the inclusions  $\text{Disk}_n^{\leq k} \hookrightarrow \text{Mfd}_n$  by  $\iota_k$  and  $\text{Disk}_n \hookrightarrow \text{Mfd}_n$  by  $\iota$ . Then there are restriction functors  $\iota_k^*$  and  $\iota^*$ . These admit right adjoint functors  $(\iota_k)_!$  and  $\iota_!$  given by right Kan extension. One can then either use the projective model structures on these presheaf categories, or  $\infty$ -categories, to construct derived functors of these right Kan extensions.

**Definition 37.2.1.** The  $k$ th Taylor approximation  $\mathcal{T}_k(F)$  of  $F \in \text{Fun}(\text{Mfd}_n, \text{Spaces})$  is the homotopy right Kan extension along  $\iota_k$  of its restriction to  $\text{Disk}_n^{\leq k}$ .

A right Kan extension is a limit, and using the Bousfield-Kan formula for enriched homotopy limits, one finds the following formula for this extension (assuming that values of  $F$  are fibrant): on  $M \in \text{Mfd}_n$ , it is the totalization of the cosimplicial spaces with  $p$ -cosimplices given by

$$\prod_{U_0, \dots, U_p \in \text{ob}(\text{Disk}_n^{\leq k})} \text{Map} \left( \prod_{i=0}^p \text{Emb}(U_i, U_{i+1}) \times \text{Emb}(U_p, M), F(U_0) \right). \quad (37.1)$$

This explicit construction, or the homotopy universal property of homotopy right Kan extension, has several formal consequences:

- There is a homotopy unique sequence of maps

$$\begin{array}{c} F \\ \downarrow \searrow \swarrow \\ \mathcal{T}_0(F) \longleftarrow \mathcal{T}_1(F) \longleftarrow \mathcal{T}_2(F) \longleftarrow \dots \end{array} \quad (37.2)$$

whose homotopy limit  $\mathcal{T}_\infty(F)$  may also be described as the homotopy right Kan extension along  $\iota$  of the restriction  $F$  to  $\text{Disk}_n$ .

- A natural transformation  $\eta: F \rightarrow G$  of functors  $\text{Mfd}_n^{\text{op}} \rightarrow \text{Spaces}$  induces a weak equivalence on all  $M \in \text{Disk}_n^{\leq k}$  if and only if  $\mathcal{T}_k(F) \simeq \mathcal{T}_k(G)$ .
- We have that  $\mathcal{T}_k \mathcal{T}_{k'}(F) = \mathcal{T}_{\min(k, k')}(F)$ .

**Definition 37.2.2.** The tower (37.2) is called the Taylor tower of  $F$ , the  $\mathcal{T}_k(F)$  the  $k$ th Taylor approximation and  $\mathcal{T}_\infty(F)$  the limit of the Taylor tower.

### Alternative perspectives

Let us outline a few alternative perspectives on manifold calculus.

- An alternative construction of  $\mathcal{T}_k(F)$  is as the homotopy sheafification with respect to the Grothendieck topology on  $\text{Mfd}_n$  generated by those open covers that contain each  $k$ -tuple of points in  $M$ , [?]. For  $k = 1$ , this is just a homotopy sheaf with respect to the ordinary Grothendieck topology.
- A second alternative construction of  $\mathcal{T}_k(F)$  uses that  $\text{Disk}_n$  is the PROP constructed out of the operad  $E_n^{\text{GL}}$  with  $k$ -ary operations  $\text{Emb}_k(\bigsqcup_k \mathbb{R}^n, \mathbb{R}^n)$  (historically called the framed little  $n$ -disks operad, you should *not* use this terminology, because it is extremely confusing). This exhibits  $\text{Fun}(\text{Disk}_n, \text{Spaces})$  as the category of right  $E_n^{\text{GL}}$ -modules. Any manifold  $M$  gives rise to a right  $E_n^{\text{GL}}$ -module  $\text{Emb}(-, M)$  and  $\mathcal{T}_\infty(F)(M)$  is the derived mapping space of  $E_n^{\text{GL}}$ -modules from  $\text{Emb}(-, M)$  to  $F$ . To get the  $k$ th Taylor approximations, one uses that there is a truncated operad  $E_n^{\text{GL}, \leq k}$  (which lives in symmetric sequences on finite sets of cardinality  $\leq k$ ), and take the derived mapping spaces of  $E_n^{\text{GL}, \leq k}$ -modules from  $\text{Emb}(-, M) \rightarrow F$ .
- We can also interpret manifold calculus through the point of view of *factorization cohomology*. This is a functor  $\int^- C: \text{Mfd}_n^{\text{op}} \rightarrow \text{Spaces}$  taking as input an  $E_n^{\text{GL}}$ -coalgebra  $C$  in the symmetric monoidal category  $(\text{Spaces}, \times, *)$ . Such a coalgebra is simply the symmetric monoidal right  $E_n^{\text{GL}}$ -modules, i.e. takes disjoint union to product (just like algebras over an operad  $\mathcal{O}$  are the symmetric monoidal left  $\mathcal{O}$ -modules). In  $\text{Spaces}$  this theory collapses to some extent, as  $E_n^{\text{GL}}$ -coalgebras are just spaces with  $\text{GL}_n(\mathbb{R})$ -action (since every space has a canonical  $E_\infty$ -coalgebra structure from the diagonal). However, the construction does not require the input to be symmetric monoidal, one can equally well take factorization cohomology of right  $E_n^{\text{GL}}$ -comodules; the result is exactly  $\mathcal{T}_\infty(F)$ . From this perspective, the Taylor tower is just the cardinality filtration.

### First examples

Let us first produce some examples of linear functors, i.e. those  $F: \text{Mfd}_n^{\text{op}} \rightarrow \text{Spaces}$  such that  $F \rightarrow \mathcal{T}_1(F)$  is a natural weak equivalence. If  $F$  satisfies  $F(\emptyset) \simeq *$ , then  $F$  is said to be *reduced*. In this case, inspection of equation (37.1) or the homotopy universal property

implies that

$$\mathcal{T}_1(F)(M) \simeq \text{Map}(\text{Fr}^{\text{GL}}(TM), F(\mathbb{R}^n))^{h\text{GL}_n(\mathbb{R})}.$$

Since the action of  $\text{GL}_n(\mathbb{R})$  on  $\text{Fr}^{\text{GL}}(TM)$  is free, we may replace this with the actual equivariant maps and obtain instead.

$$\text{Map}(\text{Fr}^{\text{GL}}(TM), F(\mathbb{R}^n))^{\text{GL}_n(\mathbb{R})} = \Gamma(M, \text{Fr}^{\text{GL}}(TM) \times_{mr\text{GL}_n(\mathbb{R})} F(\mathbb{R}^n)).$$

In particular, if  $F = \text{Map}(-, X)$  it is linear: this is simply the case  $F(\mathbb{R}^n) = X$  with trivial  $\text{GL}_n(\mathbb{R})$ -action.

**Remark 37.2.3.** This may be used to justify a claim in the smoothing theory part; if one can show that flexible invariant sheaf on topological  $n$ -manifolds is a linear functor in a topological manifold setting, then it is weakly equivalent to a spaces of sections. In fact, a sheaf satisfying an  $h$ -principle — at least in the sense that we defined it — is the same as being a linear functor, that is, also being a homotopy sheaf.

### 37.3 Embedding calculus

We shall now apply the previous discussion to  $F = \text{Emb}(-, N)$ .

#### *The 0th and 1st Taylor approximations*

We can use this to compute  $\mathcal{T}_1(F)$  for  $F = \text{Emb}(-, N)$ . Note in this case  $\mathcal{T}_0(F) = \text{Emb}(\emptyset, N) = *$ , i.e.  $F$  is *reduced*). Then there is a natural transformation  $\text{Emb}(-, N) \rightarrow \text{Imm}(-, N)$ , and by Smale-Hirsch the latter is naturally weakly equivalent to  $\text{Bun}(T-, TN)$ , which is isomorphic to  $\Gamma(M, \text{Fr}^{\text{GL}}(TM) \times_{mr\text{GL}_n(\mathbb{R})} \text{Fr}^{\text{GL}}(TN))$  and thus linear. The values on  $\mathbb{R}^n$  of this natural transformation is given by

$$\text{Emb}(\mathbb{R}^n, \mathbb{R}^n) \rightarrow \text{Imm}(\mathbb{R}^n, \mathbb{R}^n),$$

which is a weak equivalence by shrinking the domain, and in fact both sides are weakly equivalent to  $\text{GL}_n(\mathbb{R})$ . We conclude that

**Lemma 37.3.1.** *We have that  $\mathcal{T}_1(\text{Emb}(-, M)) \simeq \text{Imm}(-, M)$ .*

Of course, we could also have reasoned in the other direction and used the formula in Section 37.2.

#### *Making the rest of the tower useful*

To make the tower (37.2) useful in the case  $F = \text{Emb}(-, N)$ , one needs to know two things:

- (1) What are the differences between the stages?

(2) What does the tower converge to?

We start by answering the first question. Given an element  $f_0 \in \text{Emb}(M, N)$  (usually the identity), Weiss computed the homotopy fiber of  $\mathcal{T}_k(F) \rightarrow \mathcal{T}_{k-1}(F)$  over the image of  $f_0$  as follows. There is a number of bundles over  $\text{Conf}_k(M) := \text{Emb}(\{1, \dots, k\}, M)$ . For each subset  $S \subset \{1, \dots, k\}$  we may take  $\text{Emb}(S, N)$  (note all these bundles are trivial). These form a cubical diagram

$$\begin{array}{c} \text{Subset}(\{1, \dots, k\})^{\text{op}} \rightarrow \text{Spaces} \\ S \mapsto \text{Emb}(S, N) \end{array}$$

over  $\text{Conf}_k(M)$ . These spaces in this diagram have compatible canonical sections  $\sigma_S$  given on  $(x_1, \dots, x_k) \in \text{Emb}(\{1, \dots, k\}, M)$  by the embedding sending  $s \in S$  to  $f_0(x_s)$ , so we might as well consider it as a diagram of pointed spaces. On a cubical diagram  $F: \text{Subset}(\{1, \dots, k\})^{\text{op}} \rightarrow \text{Spaces}_*$  of pointed spaces there is a natural operation called “total homotopy fiber”: this is the homotopy fiber of the map from the corner to the homotopy limit of the punctured cube

$$F(\{1, \dots, k\}) \rightarrow \underset{S \in \text{Subset}(\{1, \dots, k\})^{\text{op}} \setminus \{1, \dots, k\}}{\text{holim}} F(S).$$

This may also be computed by taking iterated homotopy fibers.

This is a pointed space again, so applying  $\text{tohofib}$  fiberwise to the cubical diagram, we get a space  $\text{tohofib}_S \text{Emb}(S, N)$  over  $\text{Emb}(\{1, \dots, k\}, M)$ . There is an  $\mathfrak{S}_k$ -action on the base, which extends to an action on the total space that preserves the fiberwise base point. Thus we can take the quotient by  $\mathfrak{S}_k$  to get a bundle  $\text{tohofib}_k$  over  $C_k(M) = \text{Conf}_k(M) / \mathfrak{S}_k$  with section which we denote  $f_0$ .

**Theorem 37.3.2** (Weiss). *There is a weak equivalence between  $\text{hofib}(\mathcal{T}_k(F) \rightarrow \mathcal{T}_{k-1}(F), f_0)$  and the subspace of  $\Gamma(C_k(M), \text{tohofib}_k)$  of sections are equal to  $f_0$  near the fat diagonal.*

For the second question, it is helpful to extend to manifolds with boundary. Such an extension is unique up to homotopy (it will always be true that  $F(M) \simeq F(\text{int}(M))$ ), and we may have worked with such manifolds from the start. We will just say that work of Goodwillie and Klein [GK15] implies that the Taylor tower for  $\text{Emb}(-, N)$  converges when evaluated on those  $M$  which admit a finite handle decomposition with handles of dimension  $< n - 2$  [GW99].



## *Finiteness results for diffeomorphisms of disks*

We shall combine the results of the previous two sections to prove that each homotopy group  $\pi_i(\text{Diff}_\partial(D^{2n}))$  is finitely generated for  $2n \geq 6$ .

### *38.1 Finiteness for embeddings*

We start by proving some results about the monoid of embeddings  $\text{Emb}_{D^{2n-1}}^{\Theta_0}(W_{g,1})$ , which we shall shorten to  $\text{Emb}(W_{g,1})$ . We will do this by independently considering its path components and identity component. This suffices, since  $\pi_0$  is a group by our identification of it with various groups of diffeomorphisms and homeomorphisms, and hence all components are homotopy equivalent.

#### *The group of path components*

Firstly, we note that the fiber sequence

$$B\text{Diff}_\partial(W_{g,1}) \rightarrow B\text{Emb}(W_{g,1}) \rightarrow B^2\text{Diff}_\partial(D^{2n})$$

implies that there is a short exact sequence of groups

$$\Theta_{2n+1} \rightarrow \pi_0(\text{Diff}_\partial(W_{g,1})) \rightarrow \pi_0(\text{Emb}(W_{g,1})) \rightarrow 0.$$

We shall use this to prove that  $\pi_0(\text{Emb}(W_{g,1}))$  has the following property:

**Definition 38.1.1.** We say that a group  $G$  is of *homologically finite type* if for all  $\mathbb{Z}[G]$ -modules  $M$  that are finitely generated as abelian groups, for each  $i \geq 0$  the homology group  $H_i(BG; M)$  is a finitely generated abelian group.

**Lemma 38.1.2.** *In a short sequence*

$$1 \rightarrow H \rightarrow G \rightarrow G' \rightarrow 1,$$

*if  $G$  is homologically finite type and  $H$  is finite, then  $G'$  is also homologically finite type.*

Takeaways:

- By combining information about embeddings and diffeomorphisms of a fixed manifold, in our case  $W_{g,1}$ , we can learn something about diffeomorphisms of disks.
- We may avoid the limitations of homological stability by letting  $g \rightarrow \infty$ .
- The sources of finiteness for embeddings are embedding calculus and a result of Sullivan that mapping class groups of high-dimensional simply-connected manifolds are arithmetic groups.

*Proof.* There is a local coefficient Serre spectral sequence

$$E_{pq}^2 = H_p(BG'; H_q(BH; M)) \Rightarrow H_{p+q}(BG; M).$$

By assumption the target is finitely generated in each degree. We need to prove that the  $q = 0$  row is finitely generated in each degree. To do so we prove by induction over  $p$  the stronger statement that for all  $M'$  that are finitely generated as abelian groups, for all  $p' \leq p$  the groups  $H_{p'}(BG'; M')$  are finitely generated. The initial case  $p = 0$  follows by taking  $M' = M$  in the above spectral sequence and looking at  $E_{00}^2 = H_0(BG'; M')$  (which uses that  $H$  acts trivially on  $M$ , so that  $H_0(BH; M) = M_H = M$ ). No differential goes into it or out of it, and it converges to a finitely generated group, so it is finitely generated.

Let us next prove the induction step, and assume the case  $p - 1$ . Then first  $p$  columns, i.e. the 0th to  $(p - 1)$ st, consists of finitely generated groups because  $H$  being finite implies  $H_q(BH) \otimes M'$  is finitely generated as an abelian group. Then the entry  $E_{p0}^2 = H_p(BG; M')$  can only have differentials to finitely generated abelian groups, and has to converge to a finitely generated abelian group. Hence  $H_p(BG; M')$  has to be finitely generated as well.  $\square$

Hence it suffices to prove that the mapping class group  $\pi_0(\text{Diff}_\partial(W_{g,1}))$  is of homologically finite type. This is a consequence of the following theorem of Sullivan, proven using surgery theory and rational homotopy theory [Sul77]:

**Theorem 38.1.3** (Sullivan). *If  $M$  is a closed simply-connected smooth manifold of dimension  $n \geq 5$ , then  $\pi_0(\text{Diff}(M))$  is an arithmetic group.*

For us an *arithmetic group* is a group  $\Gamma$  such that there exists an algebraic group  $G$  over  $\mathbb{Q}$ , i.e.  $G \subset \text{GL}_n(\mathbb{Q})$  defined by polynomial equations in its entries, such that there is a finite index group of  $\Gamma$  which is isomorphic to  $G \cap \text{GL}_n(\mathbb{Z})$ .

Borel and Serre proved there is a finite index subgroup  $\Gamma'$  of  $\Gamma$  which acts freely on a manifold with boundary, the Borel-Serre compactification, such that the quotient is a compact manifold with boundary [Ser79]. This gives a finite free  $\mathbb{Z}[\Gamma']$ -module resolution of  $\mathbb{Z}$ , which allows one to compute  $H_*(B\Gamma'; M')$  for  $M'$  finitely generated as an abelian group, using a chain complex that consists of finitely generated abelian groups. Hence it is of homologically finite type. To deduce the same for  $\Gamma$ , we need the following lemma (compare to Lemma 38.1.2).

**Lemma 38.1.4.** *If  $H \subset G$  has finite index, then  $G$  is of homologically finite type if and only if  $H$  is.*

We conclude the following:

**Theorem 38.1.5** (Borel-Serre). *An arithmetic group is homologically finite type.*

**Corollary 38.1.6.** *If  $M$  is a closed simply-connected smooth manifold of dimension  $n \geq 5$ , then  $\pi_0(\text{Diff}(M))$  is of homologically finite type.*

The manifold  $W_{g,1}$  is not closed, but using  $W_g := \#_g(S^n \times S^n)$ , we have a fiber sequence

$$\text{Emb}(D^{2n}, W_g) \rightarrow B\text{Diff}_\partial(W_{g,1}) \rightarrow B\text{Diff}_\partial(W_g).$$

We saw before that  $\text{Emb}(D^{2n}, W_g) \simeq \text{Fr}^{\text{GL}}(TW_g)$ , which fits into a fiber sequence

$$O(2n) \rightarrow \text{Fr}^{\text{GL}}(TW_g) \rightarrow W_{g,1},$$

so that we may conclude that  $\pi_0(\text{Fr}^{\text{GL}}(TW_g)) \cong \mathbb{Z}/2\mathbb{Z} \cong \pi_1(\text{Fr}^{\text{GL}}(TW_g))$ .

Thus  $\pi_0(\text{Diff}_\partial(W_{g,1}))$  differs from  $\pi_0(\text{Diff}_\partial(W_g))$  by finite groups, and hence is also of homologically finite type. We may then conclude that:

**Corollary 38.1.7.** *We have that  $\pi_0(\text{Emb}(W_{g,1}))$  is of homologically finite type.*

*The identity component*

We shall study the identity component  $\text{Emb}_{\text{id}}(W_{g,1})$  of embeddings  $W_{g,1} \hookrightarrow W_{g,1} \text{ rel } D_-^{2n-1}$  using embedding calculus. We saw before that there is a tower

$$\begin{array}{ccc} \vdots & & \\ \downarrow & & \\ T_3 & \longleftarrow & \Gamma(C_3(W_{g,1}), \text{tohofib}_3 \text{ rel fat diagonal and } D_-^{2n-1}) \\ \swarrow & \downarrow & \\ & T_2 & \longleftarrow \Gamma(C_2(W_{g,1}), \text{tohofib}_2 \text{ rel fat diagonal and } D_-^{2n-1}) \\ \swarrow & \downarrow & \\ \text{Emb}_{\text{id}}(W_{g,1}) & \longrightarrow & T_1 \xrightarrow{\cong} \text{Bun}_{D_-^{2n-1}, \text{id}}(TW_{g,1}, TW_{g,1}). \end{array}$$

This converges since the handle dimension of the source  $W_{g,1} \text{ rel } D_-^{2n-1}$  is  $n$ , while the target  $W_{g,1}$  is  $2n$ -dimensional, and  $2n - n > 2$  if  $n \geq 3$ . We shall use this to prove that  $\text{Emb}_{\text{id}}(W_{g,1})$  has homotopy groups which are finitely generated abelian groups in each degree (since it is a path-connected  $H$ -space,  $\pi_1$  is abelian).

For the first Taylor approximation, we note that the bundle maps fit into a fiber sequence

$$\text{Map}_*(W_{g,1}, O(2n)) \rightarrow \text{Bun}_{D_-^{2n-1}, \text{id}}(TW_{g,1}, TW_{g,1}) \rightarrow \text{Map}_*(W_{g,1}, W_{g,1}),$$

and the fiber and base may be identified by  $\prod_{2g} \Omega^n(O(2n))$  and  $\prod_{2g} \Omega^n(W_{g,1})$ , so that it easily follows from the long exact sequence of homotopy groups that the identity components of the space of bundle maps are finitely generated abelian groups in each degree.

By the Goodwillie-Klein estimates [GK15] that went into proving the tower converges, the layers given by section spaces, become more highly connected as the number of particles goes to infinity. This simply follows by connectivity estimates on the total homotopy fiber. Thus it suffices to show that the section spaces also have finitely generated homotopy groups in each degree. This is a similar argument; the fibers have finitely generated homotopy groups by using the iterated homotopy fiber formula and using that configuration spaces are homotopy equivalent to finite CW complexes and hence have finitely generated homotopy groups. Then one does an induction over the number of cells in the base.

**Proposition 38.1.8.** *We have that  $\pi_i(\text{Emb}_{\text{id}}(W_{g,1}))$  is a finitely generated abelian group for all  $i \geq 1$ .*

By a Serre class argument, we then also have that  $H_*(\text{Emb}_{\text{id}}(W_{g,1}))$  is a finitely generated abelian group in each degree. From the geometric spectral sequence the same is true for  $H_*(B\text{Emb}_{\text{id}}(W_{g,1}))$ .

### *The classifying space of embeddings*

Now we combine our results on the path components and the identity components. There is a fiber sequence

$$B\text{Emb}_{\text{id}}(W_{g,1}) \rightarrow B\text{Emb}(W_{g,1}) \rightarrow B\pi_0(\text{Emb}(W_{g,1}))$$

and by the Serre spectral sequence, the homology of the total space may be computed by

$$E_{pq}^2 = H_p(B\pi_0(\text{Emb}(W_{g,1})); H_q(B\text{Emb}_{\text{id}}(W_{g,1}))) \Rightarrow H_{p+q}(B\text{Emb}(W_{g,1}))$$

and since the  $\pi_0(\text{Emb}(W_{g,1}))$  is of homologically finite type, while each  $H_q(B\text{Emb}_{\text{id}}(W_{g,1}))$  is a finitely generated abelian group. This means that each entry on the  $E^2$ -page is a finitely generated abelian group, and hence so is  $H_{p+q}(B\text{Emb}(W_{g,1}))$ .

**Theorem 38.1.9.** *We have that  $H_*(B\text{Emb}(W_{g,1}))$  is finitely generated in each degree.*

### 38.2 *Diffeomorphisms of disks*

Consider the Serre spectral sequence for

$$B\text{Diff}_{\partial}(W_{g,1}) \rightarrow B\text{Emb}(W_{g,1}) \rightarrow B^2\text{Diff}_{\partial}(D^{2n}),$$

which is given by

$$E_{pq}^2 = H_p(B^2\text{Diff}_\partial(D^{2n}), H_q(B\text{Diff}_\partial(W_{g,1}))) \Rightarrow H_{p+q}(B\text{Emb}(W_{g,1})),$$

where we note that the coefficients are trivial since the base is simply-connected.

By the Galatius-Randal-Williams theorems, we have that  $H_q(B\text{Diff}_\partial(W_{g,1}))$  is equal to  $H_q(\Omega^\infty MT\theta)$  for  $q \leq \frac{g-3}{2}$ . This is finitely generated. On other hand, the spectral sequence converges to finitely generated abelian groups by Theorem 38.1.9. Then a similar argument to Lemma 38.1.2 tells us that  $H_p(B^2\text{Diff}_\partial(D^{2n}))$  is finitely generated for  $p \leq \frac{g-3}{2}$ . But  $g$  was arbitrary so  $H_*(B^2\text{Diff}_\partial(D^{2n}))$  is finitely generated in each degree. By a Serre classes argument, the same is true for the homotopy groups. This is the result we have been working towards the last couple of lectures [Kup17].

**Theorem 38.2.1 (K.).** *We have that  $\pi_i(\text{Diff}_\partial(D^{2n}))$  is finitely generated for  $i \geq 0$  and  $n \geq 3$ .*

**Remark 38.2.2.** The same is true for odd-dimensional disks as long as the dimension is not 5, 7, by using results of Botvinnik-Perlmutter in place of Galatius-Randal-Williams, [Per15, BP15].



# Bibliography

- [AGZV12] V. I. Arnold, S. M. Gusein-Zade, and A. N. Varchenko, *Singularities of differentiable maps. Volume 1*, Modern Birkhäuser Classics, Birkhäuser/Springer, New York, 2012, Classification of critical points, caustics and wave fronts, Translated from the Russian by Ian Porteous based on a previous translation by Mark Reynolds, Reprint of the 1985 edition. MR 2896292 105
- [BdBW13] Pedro Boavida de Brito and Michael Weiss, *Manifold calculus and homotopy sheaves*, Homology Homotopy Appl. **15** (2013), no. 2, 361–383. MR 3138384 18, 307, 308
- [BdBW15] Pedro Boavida de Brito and Michael S. Weiss, *Spaces of smooth embeddings and configuration categories*, preprint (2015), <http://arxiv.org/abs/1502.01640>. 308
- [BL74] Dan Burghilea and Richard Lashof, *The homotopy type of the space of diffeomorphisms. I, II*, Trans. Amer. Math. Soc. **196** (1974), 1–36; *ibid.* 196 (1974), 37–50. MR 0356103 (50 #8574) 17
- [BMS67] H. Bass, J. Milnor, and J.-P. Serre, *Solution of the congruence subgroup problem for  $SL_n$  ( $n \geq 3$ ) and  $Sp_{2n}$  ( $n \geq 2$ )*, no. 33, 1967. MR 0244257 139
- [Bor74] Armand Borel, *Stable real cohomology of arithmetic groups*, Ann. Sci. École Norm. Sup. (4) **7** (1974), 235–272 (1975). MR 0387496 (52 #8338) 17, 194
- [Bou98] Nicolas Bourbaki, *Commutative algebra. Chapters 1–7*, Elements of Mathematics (Berlin), Springer-Verlag, Berlin, 1998, Translated from the French, Reprint of the 1989 English translation. MR 1727221 158
- [BP72] Michael Barratt and Stewart Priddy, *On the homology of non-connected monoids and their associated groups*, Comment. Math. Helv. **47** (1972), 1–14. MR 0314940 251

- [BP15] Boris Botvinnik and Nathan Perlmutter, *Stable moduli spaces of high dimensional handlebodies*, preprint (2015), <http://arxiv.org/abs/1509.03359>. 18, 317
- [Bur79] D. Burghelea, *The rational homotopy groups of  $\text{Diff}(M)$  and  $\text{Homeo}(M^n)$  in the stability range*, Algebraic topology, Aarhus 1978 (Proc. Sympos., Univ. Aarhus, Aarhus, 1978), Lecture Notes in Math., vol. 763, Springer, Berlin, 1979, pp. 604–626. MR 561241 (81d:57029) 201
- [Cas86] Andrew J. Casson, *Three lectures on new-infinite constructions in 4-dimensional manifolds*, À la recherche de la topologie perdue, Progr. Math., vol. 62, Birkhäuser Boston, Boston, MA, 1986, With an appendix by L. Siebenmann, pp. 201–244. MR 900253 143
- [CC00] Alberto Candel and Lawrence Conlon, *Foliations. I*, Graduate Studies in Mathematics, vol. 23, American Mathematical Society, Providence, RI, 2000. MR 1732868 61
- [Cer68] Jean Cerf, *Sur les difféomorphismes de la sphère de dimension trois ( $\Gamma_4 = 0$ )*, Lecture Notes in Mathematics, No. 53, Springer-Verlag, Berlin-New York, 1968. MR 0229250 79, 87
- [Cer70] ———, *La stratification naturelle des espaces de fonctions différentiables réelles et le théorème de la pseudo-isotopie*, Inst. Hautes Études Sci. Publ. Math. (1970), no. 39, 5–173. MR 0292089 (45 #1176) 185
- [DK04] J. J. Duistermaat and J. A. C. Kolk, *Multidimensional real analysis. I. Differentiation*, Cambridge Studies in Advanced Mathematics, vol. 86, Cambridge University Press, Cambridge, 2004, Translated from the Dutch by J. P. van Braam Houckgeest. MR 2121976 110
- [DK10] ———, *Distributions, Cornerstones*, Birkhäuser Boston, Inc., Boston, MA, 2010, Theory and applications, Translated from the Dutch by J. P. van Braam Houckgeest. MR 2680692 51
- [Dol62] Albrecht Dold, *Decomposition theorems for  $S(n)$ -complexes*, Ann. of Math. (2) 75 (1962), 8–16. MR 0137113 (25 #569) 249
- [EE67] C. J. Earle and J. Eells, *The diffeomorphism group of a compact Riemann surface*, Bull. Amer. Math. Soc. 73 (1967), 557–559. MR 0212840 84



- [EE69] Clifford J. Earle and James Eells, *A fibre bundle description of Teichmüller theory*, J. Differential Geometry **3** (1969), 19–43. MR 0276999 59
- [EK71] Robert D. Edwards and Robion C. Kirby, *Deformations of spaces of imbeddings*, Ann. Math. (2) **93** (1971), 63–88. MR 0283802 207, 211, 217, 227
- [EM88] Clifford J. Earle and Curt McMullen, *Quasiconformal isotopies*, Holomorphic functions and moduli, Vol. I (Berkeley, CA, 1986), Math. Sci. Res. Inst. Publ., vol. 10, Springer, New York, 1988, pp. 143–154. MR 955816 59
- [FH78] F. T. Farrell and W. C. Hsiang, *On the rational homotopy groups of the diffeomorphism groups of discs, spheres and aspherical manifolds*, Algebraic and geometric topology (Proc. Sympos. Pure Math., Stanford Univ., Stanford, Calif., 1976), Part 1, Proc. Sympos. Pure Math., XXXII, Amer. Math. Soc., Providence, R.I., 1978, pp. 325–337. MR 520509 (80g:57043) 17, 193, 201
- [FM12] Benson Farb and Dan Margalit, *A primer on mapping class groups*, Princeton Mathematical Series, vol. 49, Princeton University Press, Princeton, NJ, 2012. MR 2850125 (2012h:57032) 85
- [FQ90] Michael H. Freedman and Frank Quinn, *Topology of 4-manifolds*, Princeton Mathematical Series, vol. 39, Princeton University Press, Princeton, NJ, 1990. MR 1201584 119, 148, 210, 218, 267
- [Gal11] Søren Galatius, *Stable homology of automorphism groups of free groups*, Ann. of Math. (2) **173** (2011), no. 2, 705–768. MR 2784914 (2012c:20149) 251
- [Gei17] Hansjörg Geiges, *Isotopies vis-à-vis level-preserving embeddings*, <https://arxiv.org/abs/1708.09703>, 2017. 68
- [GJ09] Paul G. Goerss and John F. Jardine, *Simplicial homotopy theory*, Modern Birkhäuser Classics, Birkhäuser Verlag, Basel, 2009, Reprint of the 1999 edition [MR1711612]. MR 2840650 54, 55, 70, 169, 294
- [GK15] Thomas G. Goodwillie and John R. Klein, *Multiple disjunction for spaces of smooth embeddings*, J. Topol. **8** (2015), no. 3, 651–674. MR 3394312 312, 316

- [Goo85] Thomas G. Goodwillie, *Cyclic homology, derivations, and the free loop space*, *Topology* **24** (1985), no. 2, 187–215. MR 793184 [173](#)
- [Gra73] André Gramain, *Le type d'homotopie du groupe des difféomorphismes d'une surface compacte*, *Ann. Sci. École Norm. Sup. (4)* **6** (1973), 53–66. MR 0326773 (48 #5116) [59](#), [79](#)
- [Gra89] Matthew A. Grayson, *Shortening embedded curves*, *Ann. of Math. (2)* **129** (1989), no. 1, 71–111. MR 979601 (90a:53050) [59](#)
- [Gro86] Mikhael Gromov, *Partial differential relations*, *Ergebnisse der Mathematik und ihrer Grenzgebiete (3) [Results in Mathematics and Related Areas (3)]*, vol. 9, Springer-Verlag, Berlin, 1986. MR 864505 (90a:58201) [18](#), [236](#)
- [GRW10] Søren Galatius and Oscar Randal-Williams, *Monoids of moduli spaces of manifolds*, *Geom. Topol.* **14** (2010), no. 3, 1243–1302. MR 2653727 [251](#), [260](#), [277](#), [279](#), [285](#)
- [GRW14] Søren Galatius and Oscar Randal-Williams, *Stable moduli spaces of high-dimensional manifolds*, *Acta Math.* **212** (2014), no. 2, 257–377. MR 3207759 [18](#), [289](#), [292](#), [293](#), [297](#), [298](#)
- [GRW18] Søren Galatius and Oscar Randal-Williams, *Homological stability for moduli spaces of high dimensional manifolds. I*, *J. Amer. Math. Soc.* **31** (2018), no. 1, 215–264. MR 3718454 [18](#), [265](#), [274](#)
- [GTMW09] Søren Galatius, Ulrike Tillmann, Ib Madsen, and Michael Weiss, *The homotopy type of the cobordism category*, *Acta Math.* **202** (2009), no. 2, 195–239. MR 2506750 (2011c:55022) [18](#), [251](#), [277](#), [283](#)
- [GW99] Thomas G. Goodwillie and Michael Weiss, *Embeddings from the point of view of immersion theory. II*, *Geom. Topol.* **3** (1999), 103–118 (electronic). MR 1694808 [312](#)
- [GZ10] Hansjörg Geiges and Kai Zehmisch, *Eliashberg's proof of Cerf's theorem*, *J. Topol. Anal.* **2** (2010), no. 4, 543–579. MR 2748217 [87](#)
- [Har85] John L. Harer, *Stability of the homology of the mapping class groups of orientable surfaces*, *Ann. of Math. (2)* **121** (1985), no. 2, 215–249. MR 786348 (87f:57009) [266](#)
- [Hat] Allen Hatcher, *Spaces of incompressible surfaces*, <https://www.math.cornell.edu/~hatcher/Papers/emb.pdf>. [93](#)

- [Hat76] ———, *Homeomorphisms of sufficiently large  $P^2$ -irreducible 3-manifolds*, *Topology* **15** (1976), no. 4, 343–347. MR 0420620 (54 #8633) [92](#), [93](#)
- [Hat78] A. E. Hatcher, *Concordance spaces, higher simple-homotopy theory, and applications*, *Algebraic and geometric topology* (Proc. Sympos. Pure Math., Stanford Univ., Stanford, Calif., 1976), Part 1, Proc. Sympos. Pure Math., XXXII, Amer. Math. Soc., Providence, R.I., 1978, pp. 3–21. MR 520490 (80f:57014) [165](#), [193](#), [196](#), [199](#)
- [Hat83] Allen E. Hatcher, *A proof of the Smale conjecture*,  $\text{Diff}(S^3) \simeq \text{O}(4)$ , *Ann. of Math. (2)* **117** (1983), no. 3, 553–607. MR 701256 (85c:57008) [16](#), [59](#), [87](#)
- [Hato7] Allen Hatcher, *Notes on basic 3-manifold topology*, <https://www.math.cornell.edu/~hatcher/3M/3Mfds.pdf>, 2007. [91](#)
- [Hat11] ———, *An exposition of the Madsen-Weiss theorem*, <http://www.math.cornell.edu/~hatcher/Papers/MW.pdf>, 2011. [79](#), [251](#), [277](#)
- [Hemo04] John Hempel, *3-manifolds*, AMS Chelsea Publishing, Providence, RI, 2004, Reprint of the 1976 original. MR 2098385 [92](#)
- [Hir94] Morris W. Hirsch, *Differential topology*, Graduate Texts in Mathematics, vol. 33, Springer-Verlag, New York, 1994, Corrected reprint of the 1976 original. MR 1336822 [25](#), [33](#), [39](#), [44](#), [49](#), [52](#), [67](#)
- [Hud66] John F. P. Hudson, *Extending piecewise-linear isotopies*, *Proc. London Math. Soc. (3)* **16** (1966), 651–668. MR 0202147 [227](#)
- [Hus94] Dale Husemoller, *Fibre bundles*, third ed., Graduate Texts in Mathematics, vol. 20, Springer-Verlag, New York, 1994. MR 1249482 [223](#), [224](#)
- [HW73] Allen Hatcher and John Wagoner, *Pseudo-isotopies of compact manifolds*, Société Mathématique de France, Paris, 1973, With English and French prefaces, Astérisque, No. 6. MR 0353337 [175](#), [177](#), [183](#)
- [Igu84] Kiyoshi Igusa, *What happens to Hatcher and Wagoner's formulas for  $\pi_0 C(M)$  when the first Postnikov invariant of  $M$  is nontrivial?*, *Algebraic K-theory, number theory*,

- geometry and analysis (Bielefeld, 1982), Lecture Notes in Math., vol. 1046, Springer, Berlin, 1984, pp. 104–172. MR 750679 175, 177, 183
- [Igu88] ———, *The stability theorem for smooth pseudoisotopies*, *K-Theory* **2** (1988), no. 1-2, vi+355. MR 972368 (90d:57035) 17, 174
- [Iva76] N. V. Ivanov, *Groups of diffeomorphisms of Waldhausen manifolds*, *Zap. Naučn. Sem. Leningrad. Otdel. Mat. Inst. Steklov. (LOMI)* **66** (1976), 172–176, 209, *Studies in topology, II*. MR 0448370 92
- [Jah10] Bjørn Jahren, *Pseudoisotopies and the Bökstedt trace*, *Geom. Dedicata* **148** (2010), 245–261. MR 2721626 177, 183
- [Jan16] Mikala Jansen, *Stable real cohomology of  $SL_n(\mathbb{Z})$* , 2016, <http://www.math.ku.dk/english/research/tfa/top/paststudents/jansen.msthesis.2016.pdf>. 194
- [Kie87] R. W. Kieboom, *A pullback theorem for cofibrations*, *Manuscripta Math.* **58** (1987), no. 3, 381–384. MR 893162
- [Kis64] J. M. Kister, *Microbundles are fibre bundles*, *Ann. of Math. (2)* **80** (1964), 190–199. MR 0180986 (31 #5216) 208, 216
- [KL66] N. H. Kuiper and R. K. Lashof, *Microbundles and bundles. II. Semisimplicial theory*, *Invent. Math.* **1** (1966), 243–259. MR 0216507 (35 #7340) 212
- [KM63] Michel A. Kervaire and John W. Milnor, *Groups of homotopy spheres. I*, *Ann. of Math. (2)* **77** (1963), 504–537. MR 0148075 (26 #5584) 17, 141, 189, 196
- [Kos93] Antoni A. Kosinski, *Differential manifolds*, *Pure and Applied Mathematics*, vol. 138, Academic Press, Inc., Boston, MA, 1993. MR 1190010 97, 101, 116, 121, 135
- [KS77] Robion C. Kirby and Laurence C. Siebenmann, *Foundational essays on topological manifolds, smoothings, and triangulations*, Princeton University Press, Princeton, N.J.; University of Tokyo Press, Tokyo, 1977, With notes by John Milnor and Michael Atiyah, *Annals of Mathematics Studies*, No. 88. MR 0645390 (58 #31082) 18, 102, 205, 208, 209, 210, 219, 220, 221, 222, 223, 238
- [Kup17] Alexander Kupers, *Some finiteness results for groups of automorphisms of manifolds*, preprint (2017), <https://arxiv.org/abs/1612.09475>. 18, 299, 317

- [Lö2] Wolfgang Lück, *A basic introduction to surgery theory*, Topology of high-dimensional manifolds, No. 1, 2 (Trieste, 2001), ICTP Lect. Notes, vol. 9, Abdus Salam Int. Cent. Theoret. Phys., Trieste, 2002, pp. 1–224. MR 1937016 [121](#), [127](#), [135](#), [139](#)
- [Lac96] M. Lackenby, *The Whitney trick*, Topology Appl. **71** (1996), no. 2, 115–118. MR 1399550 [147](#)
- [Las70a] R. Lashof, *The immersion approach to triangulation and smoothing. I. Lees' immersion theorem*, Proc. Advanced Study Inst. on Algebraic Topology (Aarhus, 1970), Vol. II, Mat. Inst., Aarhus Univ., Aarhus, 1970, pp. 282–322. MR 0276976 [238](#), [308](#)
- [Las70b] ———, *The immersion approach to triangulation and smoothing. II. Triangulations and smoothings*, Proc. Advanced Study Inst. on Algebraic Topology (Aarhus, 1970), Vol. II, Mat. Inst., Aarhus Univ., Aarhus, 1970, pp. 323–355. MR 0276977 [238](#)
- [Las76] ———, *Embedding spaces*, Illinois J. Math. **20** (1976), no. 1, 144–154. MR 0388403 (52 #9239) [217](#)
- [Levo8] Marc Levine, *Motivic homotopy theory*, Milan J. Math. **76** (2008), 165–199. MR 2465990 [159](#)
- [Lew82] L. Gaunce Lewis, Jr., *When is the natural map  $X \rightarrow \Omega\Sigma X$  a cofibration?*, Trans. Amer. Math. Soc. **273** (1982), no. 1, 147–155. MR 664034 (83i:55008) [256](#)
- [Lil73] Joachim Lillig, *A union theorem for cofibrations*, Arch. Math. (Basel) **24** (1973), 410–415. MR 0334193 [256](#)
- [McC01] John McCleary, *A user's guide to spectral sequences*, second ed., Cambridge Studies in Advanced Mathematics, vol. 58, Cambridge University Press, Cambridge, 2001. MR 1793722 (2002c:55027) [197](#)
- [Mil56] John Milnor, *On manifolds homeomorphic to the 7-sphere*, Ann. of Math. (2) **64** (1956), 399–405. MR 0082103 [141](#)
- [Mil59] ———, *On spaces having the homotopy type of a CW-complex*, Trans. Amer. Math. Soc. **90** (1959), 272–280. MR 0100267 [119](#)
- [Mil63] J. Milnor, *Morse theory*, Based on lecture notes by M. Spivak and R. Wells. Annals of Mathematics Studies, No. 51, Princeton University Press, Princeton, N.J., 1963. MR 0163331 [39](#), [40](#), [107](#), [110](#), [113](#), [116](#)

- [Mil64] ———, *Microbundles. I*, *Topology* 3 (1964), no. suppl. 1, 53–80. MR 0161346 (28 #4553b) 215, 216
- [Mil65] John Milnor, *Lectures on the h-cobordism theorem*, Notes by L. Siebenmann and J. Sondow, Princeton University Press, Princeton, N.J., 1965. MR 0190942 (32 #8352) 16, 121, 127, 135, 143
- [Mil84] J. Milnor, *Remarks on infinite-dimensional Lie groups*, *Relativity, groups and topology, II* (Les Houches, 1983), North-Holland, Amsterdam, 1984, pp. 1007–1057. MR 830252 41
- [Mil97] John W. Milnor, *Topology from the differentiable viewpoint*, Princeton Landmarks in Mathematics, Princeton University Press, Princeton, NJ, 1997, Based on notes by David W. Weaver, Revised reprint of the 1965 original. MR 1487640 97, 98, 107, 113
- [MLM94] Saunders Mac Lane and Ieke Moerdijk, *Sheaves in geometry and logic*, Universitext, Springer-Verlag, New York, 1994, A first introduction to topos theory, Corrected reprint of the 1992 edition. MR 1300636 21
- [Moi77] Edwin E. Moise, *Geometric topology in dimensions 2 and 3*, Springer-Verlag, New York-Heidelberg, 1977, Graduate Texts in Mathematics, Vol. 47. MR 0488059 16, 207
- [MP15] Jeremy Miller and Martin Palmer, *A twisted homology fibration criterion and the twisted group-completion theorem*, *Q. J. Math.* 66 (2015), no. 1, 265–284. MR 3356291 164
- [MS76] D. McDuff and G. Segal, *Homology fibrations and the “group-completion” theorem*, *Invent. Math.* 31 (1975/76), no. 3, 279–284. MR 0402733 (53 #6547) 157, 162, 292
- [Neu77] Lee P. Neuwirth, *Review: Dale Rolfsen, knots and links*, *Bull. Amer. Math. Soc.* 83 (1977), no. 5, 931–935. 69
- [Pal60] Richard S. Palais, *Extending diffeomorphisms*, *Proc. Amer. Math. Soc.* 11 (1960), 274–277. MR 0117741 76
- [Per15] Nathan Perlmutter, *Homological stability for diffeomorphism groups of high dimensional handlebodies*, preprint (2015), <http://arxiv.org/abs/1510.02571>. 18, 317
- [Pra15] Dipendra Prasad, *Notes on central extensions*, <https://arxiv.org/abs/1502.02140>, 2015. 186

- [Qui] D. Quillen, *Notebooks*, <https://www.claymath.org/publications/quillen-notebooks>. 245
- [Rad24] T Radó, *Über den Begriff der Riemannschen Fläche*, Acta Univ. Szeged **2** (1924), 101–121. 207
- [Rez14] Charles Rezk, *When are homotopy colimits compatible with homotopy pullback?*, preprint (2014), <http://www.math.uiuc.edu/~rezk/i-hate-the-pi-star-kan-condition.pdf>. 294
- [Rol76] Dale Rolfsen, *Knots and links*, Publish or Perish, Inc., Berkeley, Calif., 1976, Mathematics Lecture Series, No. 7. MR 0515288 69
- [RS67] C. P. Rourke and B. J. Sanderson, *An embedding without a normal microbundle*, Invent. Math. **3** (1967), 293–299. MR 0222904 101, 218, 219
- [RW13] Oscar Randal-Williams, ‘Group-completion’, *local coefficient systems and perfection*, Q. J. Math. **64** (2013), no. 3, 795–803. MR 3094500 164
- [RW15] ———, *An upper bound for the concordance stable range*, preprint (2015), <http://arxiv.org/abs/1511.08557>. 194
- [RWW17] Oscar Randal-Williams and Nathalie Wahl, *Homological stability for automorphism groups*, Adv. Math. **318** (2017), 534–626. MR 3689750 245
- [Sco05] Alexandru Scorpan, *The wild world of 4-manifolds*, American Mathematical Society, Providence, RI, 2005. MR 2136212 143, 151
- [Seg73] Graeme Segal, *Configuration-spaces and iterated loop-spaces*, Invent. Math. **21** (1973), 213–221. MR 0331377 251
- [Seg74] ———, *Categories and cohomology theories*, Topology **13** (1974), 293–312. MR 0353298 (50 #5782) 157, 159, 256
- [Ser79] J.-P. Serre, *Arithmetic groups*, Homological group theory (Proc. Sympos., Durham, 1977), London Math. Soc. Lecture Note Ser., vol. 36, Cambridge Univ. Press, Cambridge-New York, 1979, pp. 105–136. MR 564421 314
- [Sie65] Laurence Carl Siebenmann, *THE OBSTRUCTION TO FINDING A BOUNDARY FOR AN OPEN MANIFOLD OF DIMENSION GREATER THAN FIVE*, ProQuest LLC, Ann Arbor, MI, 1965, Thesis (Ph.D.)–Princeton University. MR 2615648 230

- [Sie72] L. C. Siebenmann, *Deformation of homeomorphisms on stratified sets. I, II*, Comment. Math. Helv. **47** (1972), 123–136; *ibid.* **47** (1972), 137–163. MR 0319207 [69](#), [225](#)
- [Sma59a] Stephen Smale, *The classification of immersions of spheres in Euclidean spaces*, Ann. of Math. (2) **69** (1959), 327–344. MR 0105117 (21 #3862) [267](#), [308](#)
- [Sma59b] ———, *Diffeomorphisms of the 2-sphere*, Proc. Amer. Math. Soc. **10** (1959), 621–626. MR 0112149 (22 #3004) [16](#), [59](#), [77](#)
- [Sma61] ———, *Generalized Poincaré’s conjecture in dimensions greater than four*, Ann. of Math. (2) **74** (1961), 391–406. MR 0137124 [16](#), [135](#), [139](#)
- [Sul77] Dennis Sullivan, *Infinitesimal computations in topology*, Inst. Hautes Études Sci. Publ. Math. (1977), no. 47, 269–331 (1978). MR 0646078 (58 #31119) [314](#)
- [Wah13] Nathalie Wahl, *Homological stability for mapping class groups of surfaces*, Handbook of moduli. Vol. III, Adv. Lect. Math. (ALM), vol. 26, Int. Press, Somerville, MA, 2013, pp. 547–583. MR 3135444 [266](#)
- [Wal68] Friedhelm Waldhausen, *On irreducible 3-manifolds which are sufficiently large*, Ann. of Math. (2) **87** (1968), 56–88. MR 0224099 [92](#)
- [Wal78] ———, *Algebraic K-theory of topological spaces. I*, Algebraic and geometric topology (Proc. Sympos. Pure Math., Stanford Univ., Stanford, Calif., 1976), Part 1, Proc. Sympos. Pure Math., XXXII, Amer. Math. Soc., Providence, R.I., 1978, pp. 35–60. MR 520492 [177](#), [179](#), [182](#)
- [Wal82] ———, *Algebraic K-theory of spaces, a manifold approach*, Current trends in algebraic topology, Part 1 (London, Ont., 1981), CMS Conf. Proc., vol. 2, Amer. Math. Soc., Providence, R.I., 1982, pp. 141–184. MR 686115 [241](#)
- [Wal85] ———, *Algebraic K-theory of spaces*, Algebraic and geometric topology (New Brunswick, N.J., 1983), Lecture Notes in Math., vol. 1126, Springer, Berlin, 1985, pp. 318–419. MR 802796 (86m:18011) [165](#), [170](#), [194](#)
- [Wal99] C. T. C. Wall, *Surgery on compact manifolds*, second ed., Mathematical Surveys and Monographs, vol. 69, American Mathematical Society, Providence, RI, 1999, Edited and with a foreword by A. A. Ranicki. MR 1687388 [267](#)



- [Wal16] ———, *Differential topology*, Cambridge Studies in Advanced Mathematics, vol. 156, Cambridge University Press, Cambridge, 2016. MR 3558600 25, 33, 36, 39, 43, 60, 67, 68, 70, 97, 98, 105, 107, 113, 118, 121, 135
- [Wei99] Michael Weiss, *Embeddings from the point of view of immersion theory. I*, *Geom. Topol.* 3 (1999), 67–101 (electronic). MR 1694812 (2000c:57055a) 18, 307, 308
- [Wei05] ———, *What does the classifying space of a category classify?*, *Homology Homotopy Appl.* 7 (2005), no. 1, 185–195. MR 2175298 (2007d:57059) 253
- [Wei13] Charles A. Weibel, *The K-book*, Graduate Studies in Mathematics, vol. 145, American Mathematical Society, Providence, RI, 2013, An introduction to algebraic K-theory. MR 3076731 157, 158, 164, 165, 168, 171, 186
- [Wei15] Michael Weiss, *Dalian notes on Pontryagin classes*, preprint (2015), <http://arxiv.org/abs/1507.00153>. 18, 299
- [WJR13a] Friedhelm Waldhausen, Bjørn Jahren, and John Rognes, *Spaces of PL manifolds and categories of simple maps*, *Annals of Mathematics Studies*, vol. 186, Princeton University Press, Princeton, NJ, 2013. MR 3202834 174, 175
- [WJR13b] Friedhelm Waldhausen, Bjørn Jahren, and John Rognes, *Spaces of PL manifolds and categories of simple maps*, *Annals of Mathematics Studies*, vol. 186, Princeton University Press, Princeton, NJ, 2013. MR 3202834 17