

Люди
науки

С. В. ЖИТОМИРСКИЙ

АРХИМЕД

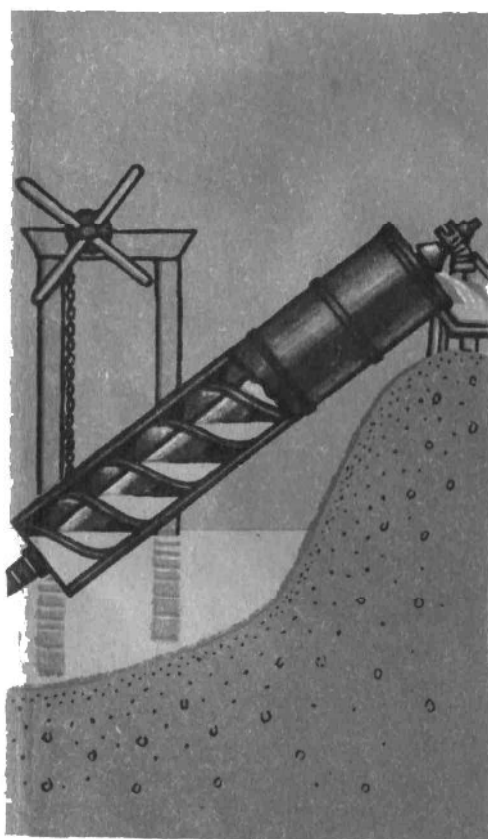

:

. :

. - .:

, 1981.

	2
1	3
2	-	11
3	-	20
4	35
5	-	45
6	61
	68
	69
	72

,

,

.

.

,

,

,

,

,

.

.

"

"

,

"

"

,

.

,

,

.

.

:"

"

1

212 . . .

XII . . .

75 . . .

- 287 . . .

I . . .

I . . .



?

(201...120 . . .),

76 . . .

136 ,

I . . .

(

),

"

".

"

"

:

"

;

,

(

)

".

, I . . .

(

).

()

" -

:"

!"

..."

- "

",

"

"

"

"

.

"

"

"

"

,

,

"

"

"

,

"

",

(?)

"

"

("

"),

III

?

(3-

)

" " () ,

287 .. ,

!

, . , .

" " (,) .

: " , " ,

, ; , , " .

?

(),

5...10

(,) , " ") .

415...413

409

405

(316...289 . . .).

(

).

:"



, ...
 - (),
 ,
 , : -
 (), - ()...
 , ;
 ,
 ;
 , (),
 () - ;
 ,
 . ();
 () .
 - () ,
 ;
 , - (), - () ,
 ()".

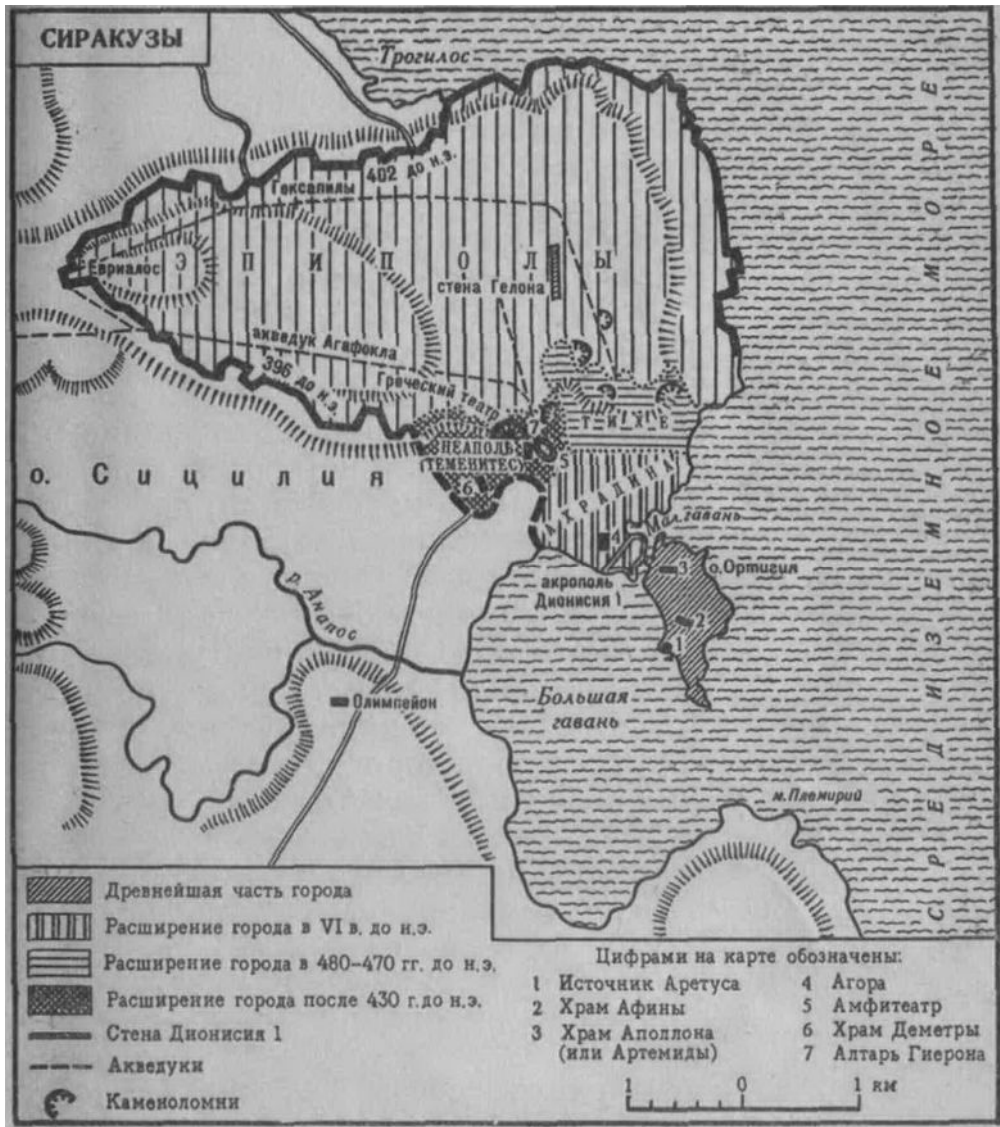

2-

54 ..."

(384...322 .

. .)

，
() 。

，
“ ”

：“ ” “ ” ， “ ” “ ” “ ” “ ”

“ ” “ ” I . . . “ ”
III . . . () 。

， . . .

“ ” () . “ ”
() ，

“ ” .
：“ ” . . .

“ ”

(. 1) : “ ”
CD ，

CD

ABCD

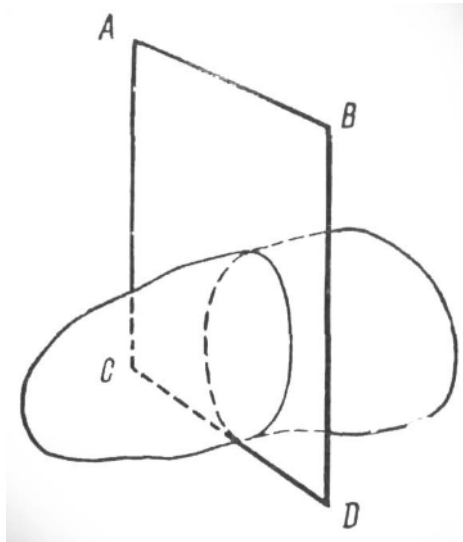

. I.

"

.

,

.

.

"

"

.

:

"

:

1.

,

,

.

2.

-

-

,

,

,

".

,

.

,

,

.

,

,

:

1. "

,

".

2. "

,

,

".

,

,

,

.

,

,

,

.

(

),

"

"

(

,

).

,

,

,

.

"

"

XI

"

"

:"

-

,

:"

,

,

!"

,

:"

,

,

,

" " "

5:1,

1000 (25),
(160

5 (125)".
4),

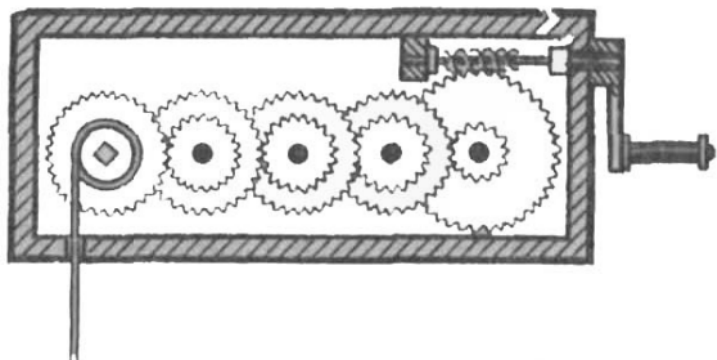

.2

(.)

5 .

12 ,

1:5 (),

125, - 3125, 390 625;

1 220 703 125!

25 .

390 625;

1 220 703 125!

"

?

(),

" -

:"

(0,547),

(- , 0,534),

"

(

).

- "

"

"

()

"

"

:"

;

;

;

;

"

"

"

"

"

1800

IX

"

"

(1545...1607),

(1530...1590).

(1548...1620).

(201...120 . . .).

XII .,

20

100

40

1.

2.

3.

4.

).

" "

: " ()

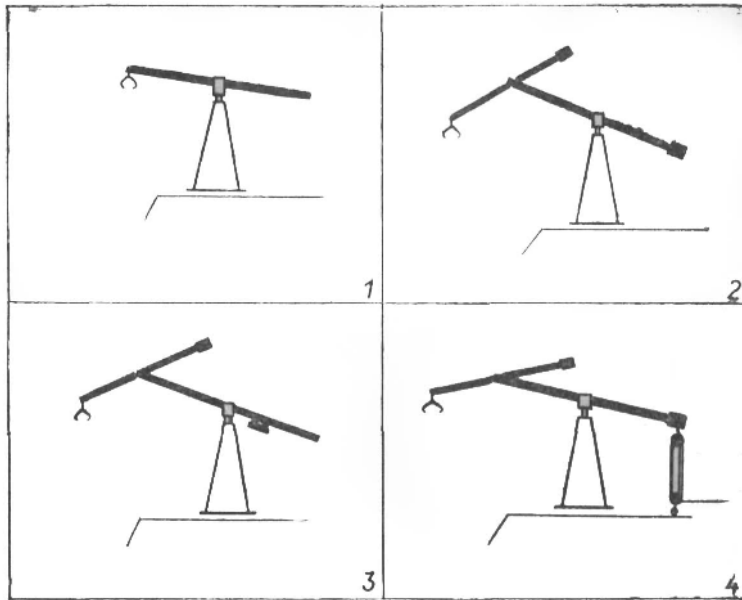

.3

. 2

: 1 -

; 2 -

(").

3

4

: " ...

" -

" " " "

" " " "

" " " "

:

,

-

" " " "

" " " "

!

" " " " " ,
" " , " " ()
). - ,
.
 , ,
 , (),
(,) ().
80 100 200
, 200 ;
 , 500 350...400 .
 , " " .
 , (,
).
 ,
(.)
 ,
 ,
10...15 , 10% .
 , 12
, 180 , 0,5,
30 .

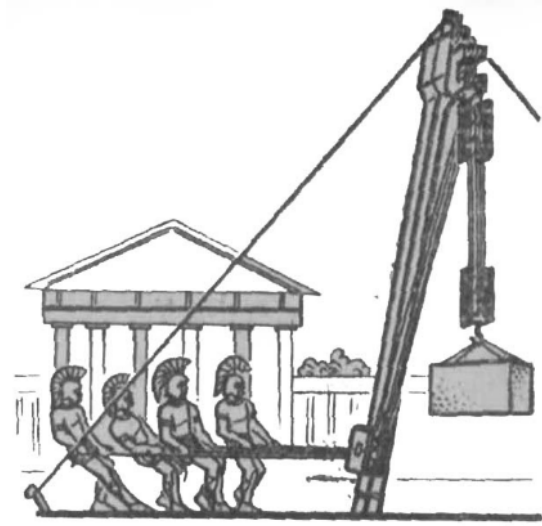

.4

(.)

'

:"

'

'

'

'

'

'

'

:"

'

:"

:"

:"

:"

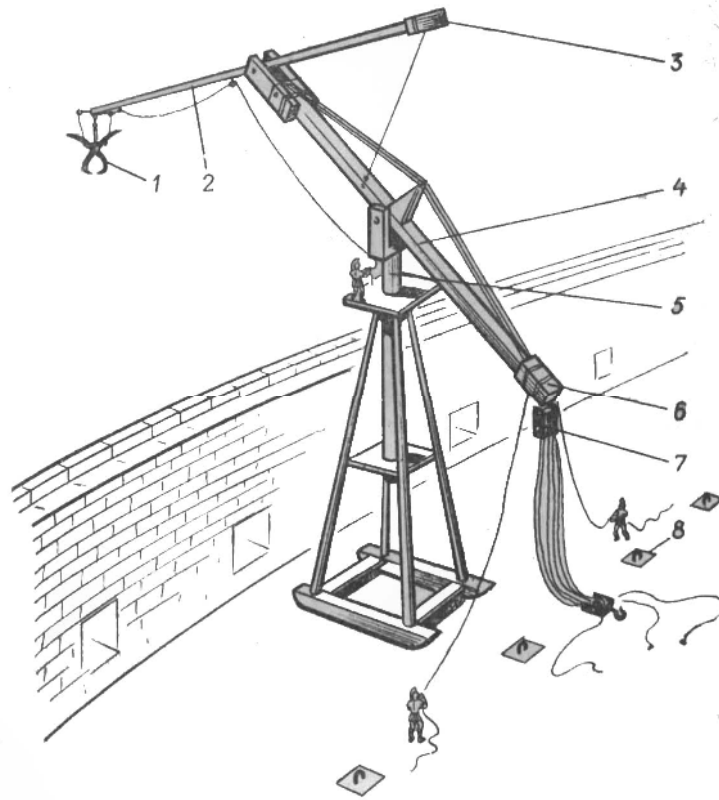

.5 ():
1 – “ ”, 2 – , 3 – , 4 –
, 5 – , 6 – , 7 – , 8 – .
“ ” – ,
“ ” , “ ”
“ ” , “ ” , “ ”
“ ” 7. “ ” 1,
“ ” 2 3.
4 – 5. , 3
“ ”
“ ” 6.
“ ”
1540 . ,
“ ”

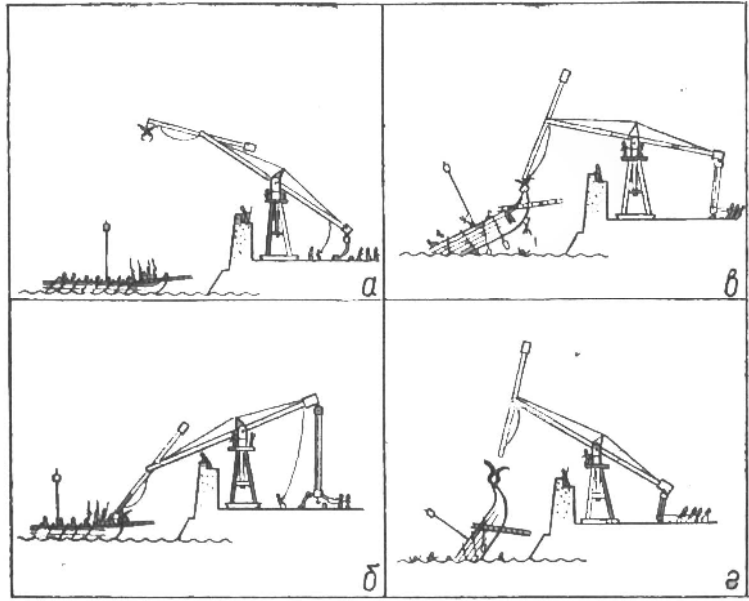

.б

:

) , ,) ,) ,) " " - :

" " , , " : " , !" - , , - " .

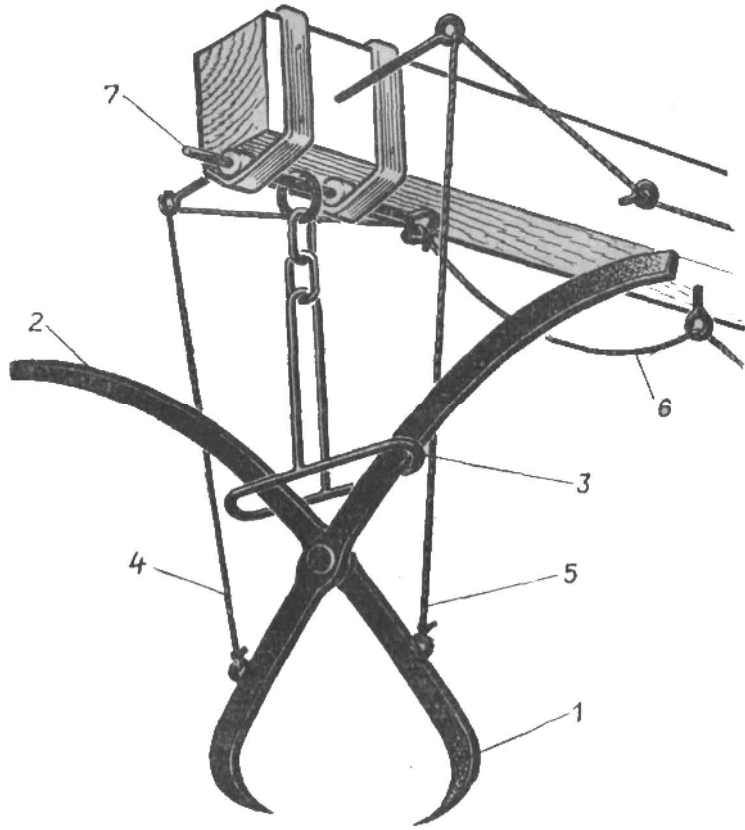

7 “ ”; 1 — , 2 — “ ”,
3 — , 4, 5, 6 — , 7 — .

(“ ”)

IX

“ ”

: ”

”

,

”

”

-

,

,

,

...
... 27 ...
...
" " "
"
()
:
" "
()
()
)
" "
()
)
" "
()
" "
" "
()
)
" "
()
" "
()
" "
()
" "
()

II

...
" "
" "
" ...
()
" "
" "

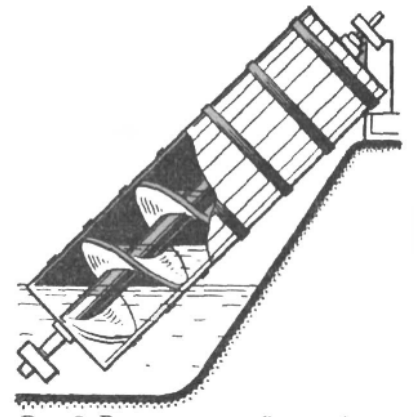

.8.

()

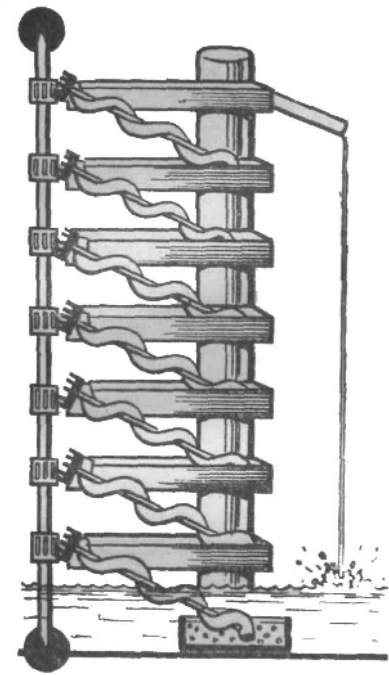

.9.

(
, 1550 .)

“ (1913 .) : ” ?

“ 1970 .: ”

”

XVII .

. .) (I . . .). : (II . . .), (I .

II . . .

”

” ”

，
："
"。

，
，
，
II . . .

"
"。

VI .

，
，
："
，
（
），
"。

：“

24

...
..."

"

"

"

"。

，
，
—
，
，
，
。

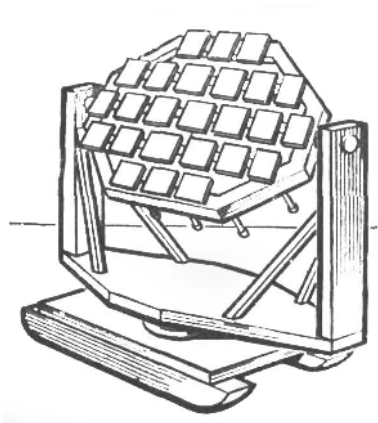

.10.

() "

:"

"

" "

)

XII

" : "

" "

,

,

,

,

,

,

,

,

,

,

,

,

,

,

,

:

?

,

,

,

-

,

,

,

,

,

.

.

.

,

,

,

,

1674

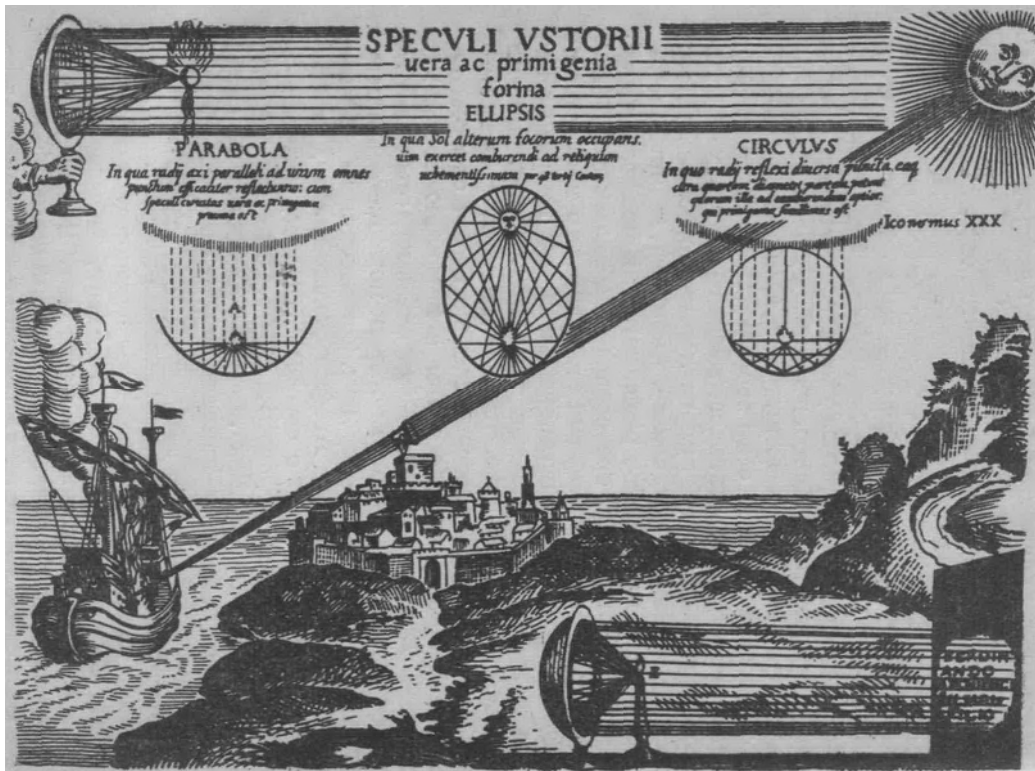

(, 1671 .)

(1596...1650)

" "

32'

32'

32',

" "

,

()

.

"

,

,

,

...

,

,

...

,

,

"

,

32'

0,01,

"

"

.

: "

,

,

;

,

,

,

,

,

,

"

XVIII .

.

,

.

,

110

"

"

, 1747 .

- "

"

.

"

"

,

"

"

,

.

,

.

.

: "

,

...

,

,

,

"

: "

,

;

40

;

,

...

24

.

,

,

,

.

,

,

.

,

,

,

;

,

...

15

...

,

,

,

,

576 225.

,

,

,

"

240

" " 2 (66).

216 (71 !),

" , - , -

30 (10). "

- : -

...

" "

"

;

13

50

168

16,2 21,5 ; 5,85 2.

:" 23 1747

40 66

...

20°

112

138

;

10

150 128

;

11 , 20

12 , 21

, 117

- 6 7

" "

" ;

". (1739 .)

1741 .

11

1747 .

"

()

1973 .

" "

:

()

91 50 .

50

"

?

?

60.



"?

(50...100

) -

?

:"

"

"?

5

(70...147)

III

" " " " " "

, , .

" " _ (, ,).

" , - , -

, , , ...

, , , ,

, ... , ...

... " ?

,

.

VII...VI . . . , .

,

, " "

,

V . . .

.

,

,

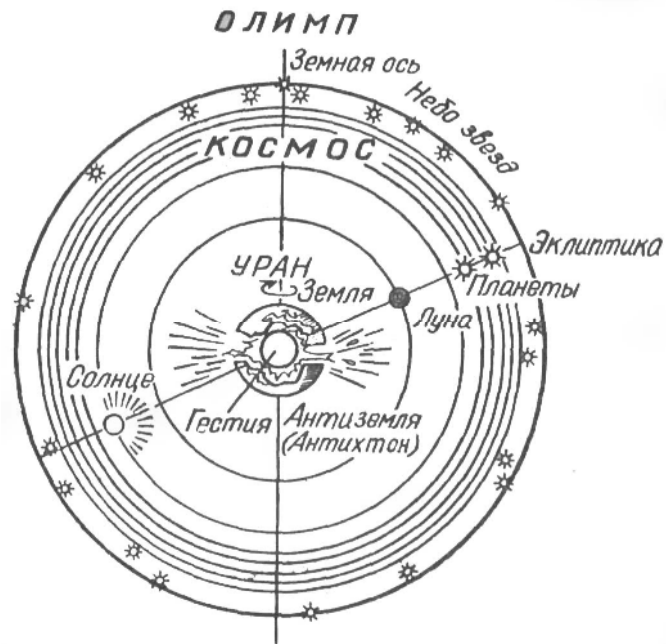

.II.

(V . . .)

V . . .

(408...355

. . .).

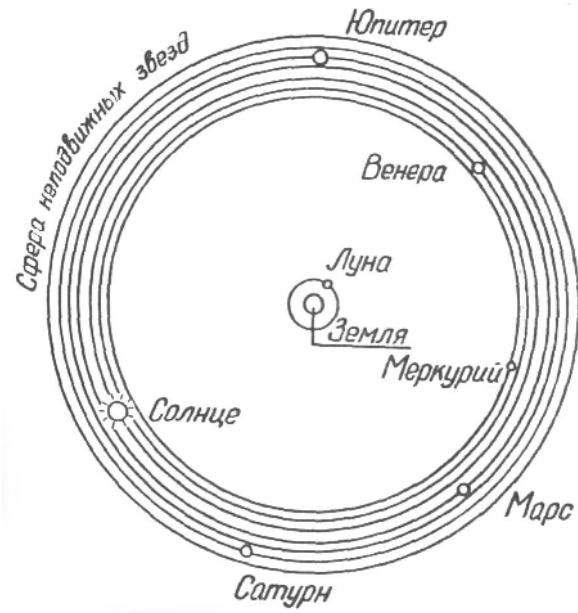

.12.

(408-355 . . .)

(388...315 . . .)

(22°,

- 46°),

(310...250 . . .).

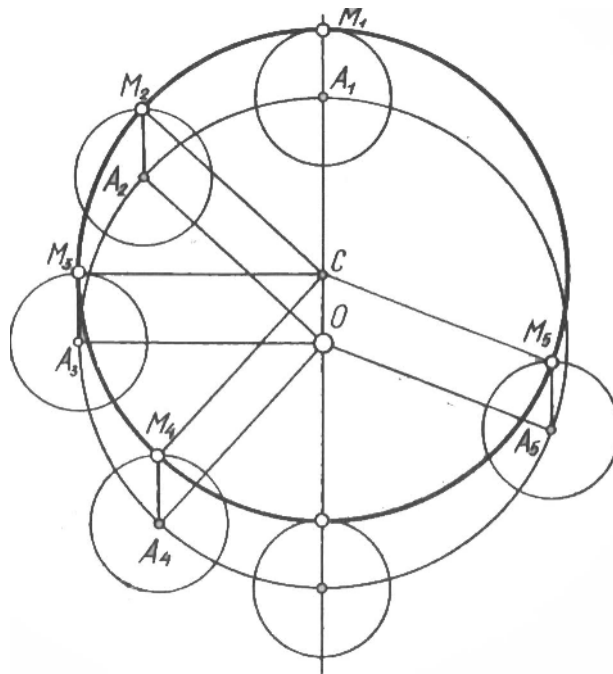

. 13.

" "

()

(262 – 200 . . .),

(. . .),

(. 13).

(. 14).

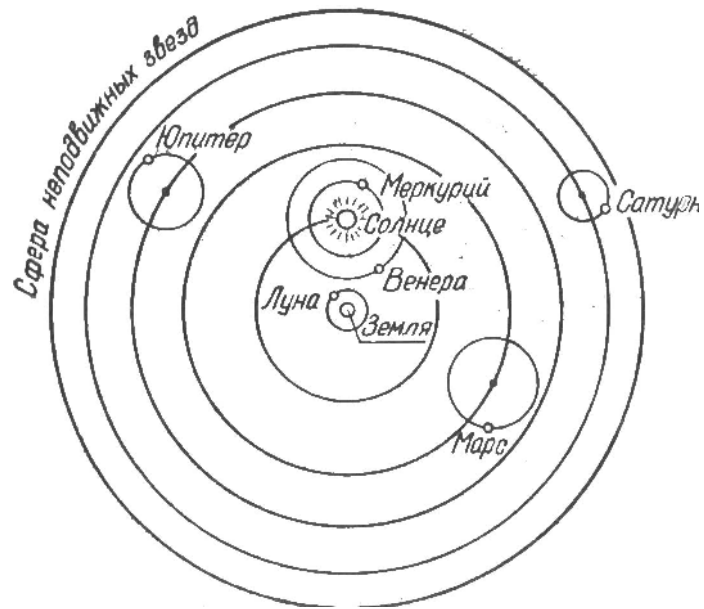

. 14.

,

," "

,"

," "

,"

,"

,"

:"

," "

,"

," "

,"

,"

,"

,"

,"

,"

:"

,"

,"

,"

,"

:"

554 4130 (1 = 150...190 . - . .);

- 5026 2065 ; - 2027 2065

..." (.).

" " " .

4731 , ,

" " ...

(.)

" (= 2027),
(l)

(n = 4),

(a = 554)

d = 5081.

= 5640

$$\sqrt{A^2 - c^2} \sim l$$

$$\sqrt{5640^2 - 2027^2} \sim 5264$$

5269.

5

1 21°,

(. 15).

()

()

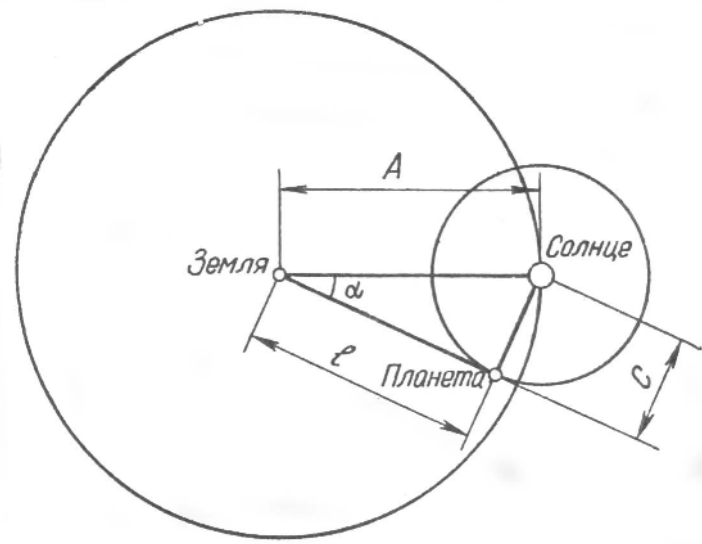

. 15.

"

" (.16).

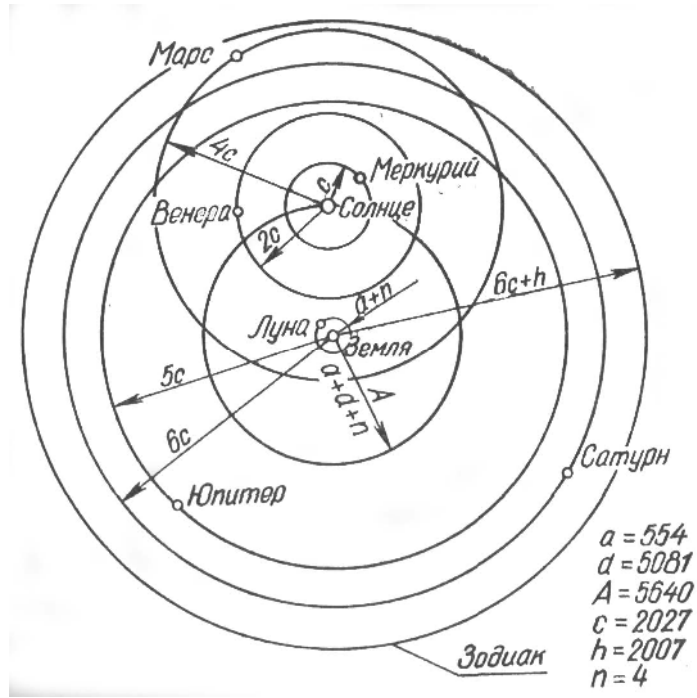

. 16.

(

).

1:2:4.

(

)

0,36 (

0,39,

8%),

0,72 (

),

1,44 (

1,52,

5%).

’
.
.
I . . .
" " : "
,
.
...
" "
,
" "
,
,
,
,
,
...
... , - , - ,
,
; ;
.
’
,
.
... "
III . . . -
,
: "
,
,
,
;
,
,
... "
V . . .
,
,
.

(

600

!):

,

,

-

.

,

,

.

,

,

.

,

,

.

.

,

"

"

,

,

,

"

"

"

"

,

.

.

,

,

,

-

12

.

,

,

.

"

"

-

(

,

).

,

(

),

,

.

.

,

,

.

.

,

(

,

,

-

,

-

..),

,

.

.

,

.

,

-

;

,

.

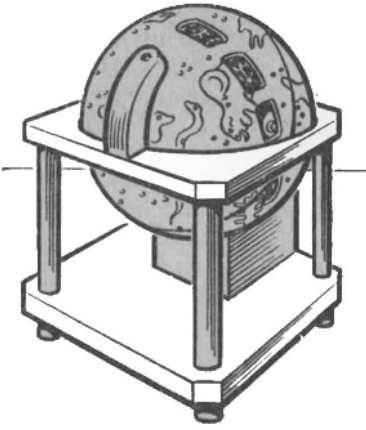

17.

()

1/27

12,5

XIX

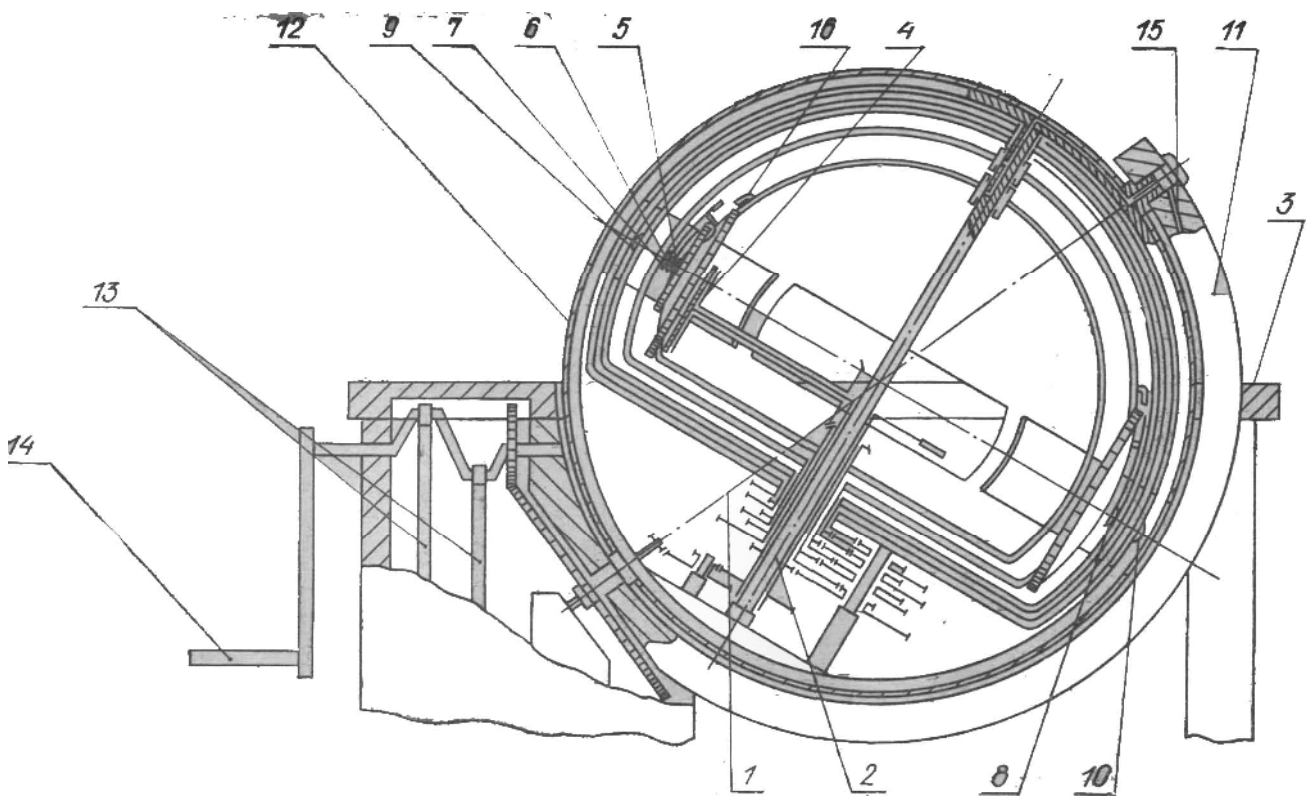

.18.

:

1 - , 2 - , 3 - , 4 - " , 5 - " , 6 - " 7 -
 " , 8 - " , 9 - " , 10 - " , 11 - , 12 -
 , 13 - , 14 - , 15 - , 16 -

" " (), I . . .
 1900 .

" "

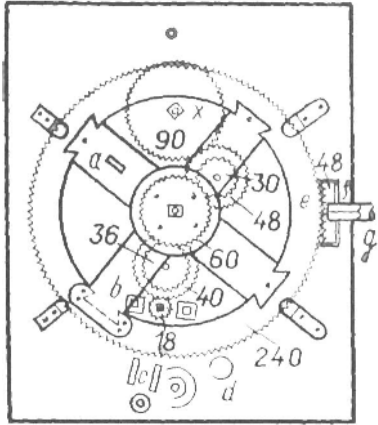

. 19.

()

()

, 3,1408,

, 3,1428.

?

(

3).

6

XXIV

" "

215 .

2-

:"

!

, " " ,
 . . .
 , , ,
 , , ,
 , , ,
 " , , - , -
 , -
 . ,
 , ()
 , - :
 , , ,
 . , , ,
 ... , , ,
 , , , - , , ,
 , , ,
 , ...
 " " ,
 , , ,
 , , ,
 , , ,
 : , , ,
 - - , , ,
 , , ,
 . , , ,
 , , ,
 , , ,
 ... ,
 ...

" ...

, -

, -

,

,

.

,

,

,

,

,

-

,

,

...

,

,

,

,

.

,

,

,

,

,

,

.

,

...

:

.

.

"

,

.

,

-

.

"

, -

, -

-

, -

,

.

,

,

...

,

,

-

-

:

.

,

.

(

),

,

,

,

.

,

,

-

, -

,

"

.

,

:

"

,

"

,

.

:

"

, -

, -

,

...

"

,

,

,

.

:

"

, -

, -

,

,

,



()

"

"

"

"

"

"

" (

)

"

" (

)

() .

(

),

(

),

(

),

(

).

(361 – 289 . .) -

317 .

215 – 214 .

214 .

VI .;

2-

214 – 212 . . .

II .,

(. 320 – 250 . .) -

(384 – 322 . .) -

(.) .

(428 – 365 . .) -

(1530 – 1590) -

(973 - . 1050) -

(1707 – 1788) -

I . . .;

(. 131 – 200) -

(1564 – 1642) -

(246 – 183 . .) -

(. 390 – 315 . .) -

I .,

II (. 305 – 215 . .) -

(230 – 214 . .) -

II,

2-

214 . . .;

212 . . .

; 215 . . . -

; 214 . . .

212 . . .

(180 – 125 . .) - ;
 , , (.).
 (1596 – 1650) - ; " "
 (. . 460 – 370
 . .) - ; I
 (. . 432 – 362 . .) - ; 406 . . . - .
 - I . . . ;
 , , .
 - , ,
 (. . 330 – 375) - ,
 (408 – 355 . .) -
 , , , . . - XII .
 .
 - II . ;
 , ;
 , (1501 – 1576) -
 ; ,
 V . ; ,
 ;
 (59 – 17) - , " " ,

 (. . 120 – 180) - - ;

 - 2- ; 214 . .
 , 212
 (III – IV . .) - , " ,
 " , ; ,
 ,
 - VI

 (202 – 122 . .) - , ; " "
 "
 (427 – 348 . .) - , ,
 (.) .

(50 – 120) - ,
; .
(70 – 147) - ,
.
III (284 – 221 . .) - 246 . ;
, -
, II (308 – 246 . .).
- ,
.
(1548 – 1620) – , " ;
";
() -
; 288 . . . ; "
";
.
- ; ,
.
(1048 – 1131) - ;
, .
- XII . ;
.
(106 – 43 . .) - ;
;
.
- ; 214 . . .
.
(256 – 194 . .) - , , ;
, .

1. . . . , 1962.
2. . . . , 1957.
3. . . . – , 1974, 10, .84-89.
4. . . . , 1945.
5. . . . , 1980.