

CENTRO DE ASTROBIOLOGÍA

ASSOCIATED TO NASA ASTROBIOLOGY INSTITUTE

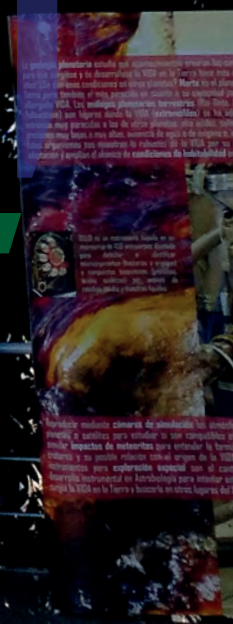

ASTROBIOLOGY

Understanding the origin and evolution of life along the history of the Universe

- How, where and when did life emerge?
- How did it evolve towards intelligence and consciousness?
- What is the future of life on Earth and beyond?

The Center for Astrobiology (CAB) was founded in 1999 as a joint Center of the National Research Council (CSIC) and the National Institute for Aerospace Technology (INTA). CAB became the first institution outside the United States to be associated with the NASA Astrobiology Institute (NAI) – formally becoming an Associate Partner in 2000.

CAB is organized in four Departments, with the following research lines:

ASTROPHYSICS | Formation and evolution of the interstellar medium, stars and planets. Searching for exoplanets.

MOLECULAR EVOLUTION | Origin, evolution and adaptation of life. From prebiotic chemistry to the microbial diversity and the metabolisms in extreme environments. The fingerprints of life and how to find them.

PLANETOLOGY AND HABITABILITY | Characterization and evolution of potential habitable environments in the Solar System. Extreme environments on Earth as analogues. Planetary atmospheres.

ADVANCED INSTRUMENTATION | Development of instrumentation for simulation, planetary exploration, remote observation. Mars and Icy Worlds exploration.

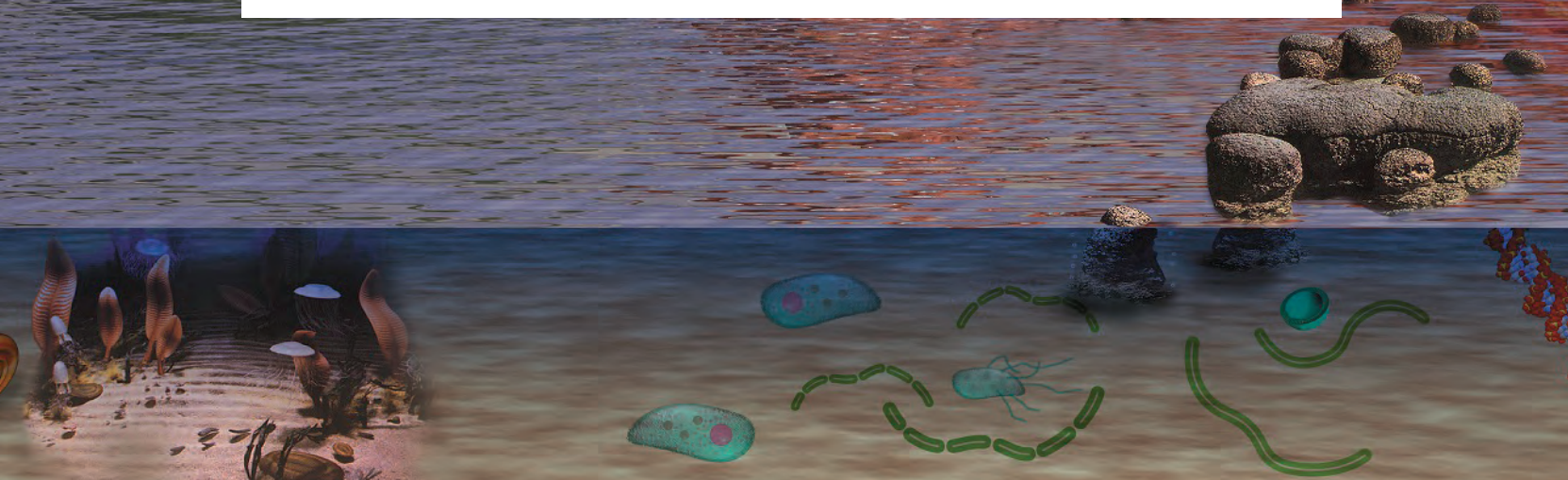

INSTRUMENTS AND ACTIVITIES



2



5

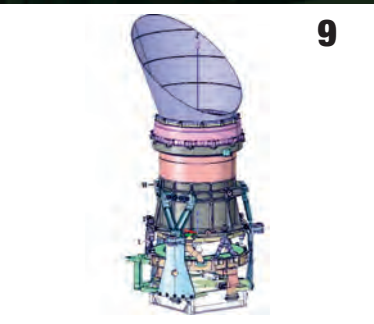

9

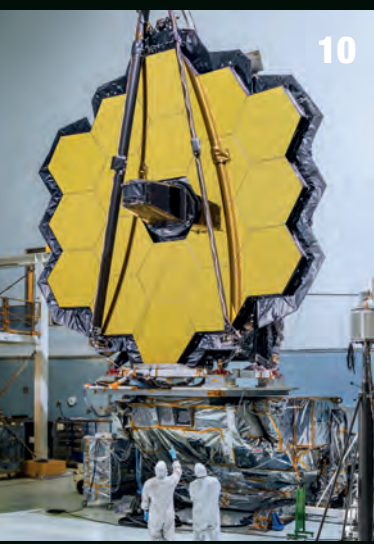

10



11

1 MEDA (Mars Environmental Dynamics Analyzer) is an instrument for the NASA's Mars 2020 rover. The goal is to characterize the Martian low atmosphere and dust properties by measuring atmospheric parameters as wind speed/direction, pressure, relative humidity, air & ground temperature, and UV, visible, and IR radiations.

1



2 TWINS (Temperature and Wind sensors for InSight mission) is an improved REMS based instrument for the NASA's InSight lander mission to Mars.

3 ExoMars RLS (Raman Laser Spectrometer) is an instrument for the ESA's ExoMars rover. RLS is designed for the identification and characterization of minerals and biomarkers. The spectral information is characteristic of the molecular structure and allows the identification and characterization of the Martian molecules and minerals in a non-destructive way.



3

4 IPBSL (Iberian Pyrite Belt Subsurface Life) is a drilling project (more than 600 m depth) in Río Tinto (Spain) to study the deep subsurface microbiology.

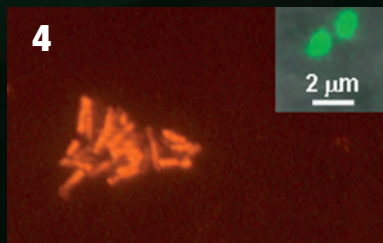

4

5 MOONWALK is a European project whose aim is the development and testing technologies and training procedures focused on astronaut-robot cooperation in Extra-Vehicular Activities (EVA) on planetary surfaces for future human missions to the Moon and Mars.

6 SOLID (Signs Of Life Detector) is an antibody microarray-based instrument, designed and built for the detection and identification of microbes and biochemical compounds by in situ analysis of solid (soil, ground rocks or ice) and liquid samples.



6

7 ISAC (InterStellar Astrochemistry Chamber) is a simulation chamber to study the chemistry associated to interstellar dust through spectroscopic techniques.



7

8 MIXS (Mercury Imaging X-ray Spectrograph) for Europe's BepiColombo mission to Mercury. It will set off in 2018 on a journey to the smallest and least explored terrestrial planet in our Solar System.

9 PLATO (Planetary Transits and Oscillations of stars) is the third medium-class mission in ESA's Cosmic Vision program. Its objective is to find and study a large number of extrasolar planetary systems, with emphasis on the properties of terrestrial planets in the habitable zone around solar-like stars.

10 Contribution to the instrumentation of JWST (James Webb Space Telescope), the world's most advanced astronomical observatory. It will study every phase in the history of our Universe, ranging from the first luminous glows after the Big Bang, to the formation of solar systems.

11 Contribution to the instrumentation of ELT (Extremely Large Telescope) astronomical observatory. It will be the world's largest optical/near-infrared extremely large telescope (European Southern Observatory-ESO, in Atacama, Chile). The ELT will allow, among other studies, the detection of water and organic molecules in protoplanetary disks around stars.

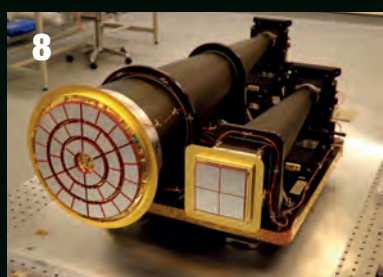

8

The origin of the elements and molecules

ASTROPHYSICS DEPARTMENT

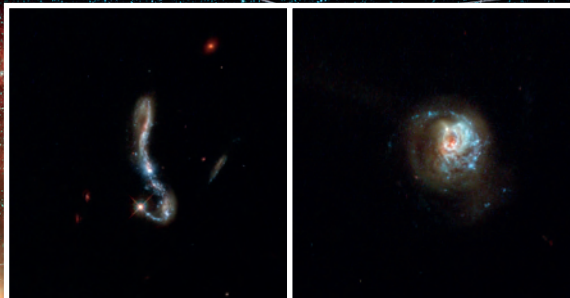
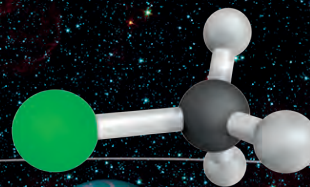

Throughout the history of the Universe, generations of stars have created in their interior all the heavy elements that we know. The atoms of these chemical elements formed molecules, dust grains and ice sheets in the interstellar and intergalactic medium to condense into planetary systems with rocky planets. Liquid water, as on the Earth, allowed the conditions in which life arose more than 3.5 billion years ago and must have been repeated in a large number of planetary systems.

We investigate key processes that were necessary for the appearance and evolution of life in the Universe such as: the formation of chemical elements in the interior of the stars and the formation and evolution of the galaxies that house them, processes of planet formation around new stars, the formation and evolution of chemical compounds of a range of complexity in interstellar space, or the search for new extrasolar planets.

RESEARCH GROUPS:

- Formation and Evolution of Stars, Brown Dwarfs and Planets
- Formation and Evolution of Galaxies
- Interstellar and Circumstellar Medium
- Virtual Observatory Group: Scientific exploitation of astronomical archives

From molecules to life

MOLECULAR EVOLUTION DEPARTMENT

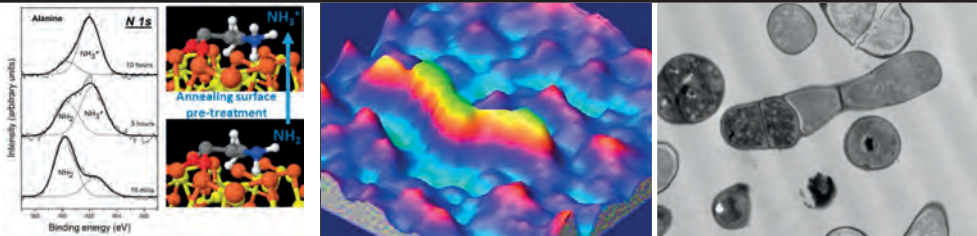

Life can be considered as a consequence of the evolution of matter and energy in the Universe. Regardless of where it originated, there are key questions to be answered: What was the prebiotic chemistry that led to the first complex polymers? How did the different molecular species behave and persist? How did they replicate and acquire information storage capability? How did they evolve and adapt to the environment? How did microbes adapt to extreme environments? How can we distinguish and detect true biomolecules (molecular biomarkers) from other non-biological organic molecules?

These and other questions constitute the scientific basis of the Department, which organizes its research strategy on three fundamental lines: Prebiotic Chemistry, Molecular Evolution, and Molecular Mechanisms of Biological Adaptation.

RESEARCH GROUPS:

- Prebiotic Chemistry
- Molecular Evolution, RNA World and Biosensors
- Molecular Mechanisms of Biological Adaptation
- Experimental Evolution Studies with Viruses and Microorganisms
- Microbial Biodiversity
- Biomolecules in Planetary Exploration



Understanding the key processes operating at planetary scales are essential to evaluate potential present or past habitats, like the geological characterization of environments and extreme paleoenvironments of planetary interest, meteoritic impacts and their relevance for life, geological processes that mark the evolution of planetary objects (craterization, biogeochemical evolution, hydrothermalism and cryomagmatic evolution), preservation of biosignatures in the geological record, or thermodynamic aspects and modeling of planetary atmospheres.

The limits of life

PLANETOLOGY AND HABITABILITY DEPARTMENT

Three main lines of research: planetary geology and atmospheres, extreme environments as habitats of astrobiological interest, and exploration of Mars and the Jupiter and Saturn icy moons containing interior liquid water oceans such as Europa and Enceladus.

RESEARCH GROUPS:

- Planetary Geology and Atmospheres
- Habitability and Extreme Environments



Micro-habitats in the rocks

Technology for space exploration

ADVANCED INSTRUMENTATION DEPARTMENT

Experimentation and simulation play a fundamental role in the accomplishment of the different research lines in the Center. In many cases they are carried out in the laboratory, in others during field campaigns by studying natural processes, and in other cases in space, either by remote observation or by in situ analysis and measurements on the surface of planetary bodies.

The main objective of the Department is to develop and test new concepts and designs, as well as to implement special platforms, or build new instruments to fulfill the requirements of experimental and simulation investigations, such as planetary simulation chambers.

The Department leads the environmental monitoring station (REMS) now operating on Mars, on board of NASA's rover Curiosity, as well as the development and construction of MEDA, the new environmental suite of instruments for NASA's Mars 2020 mission.

RESEARCH GROUPS:

- Space Instrumentation Group

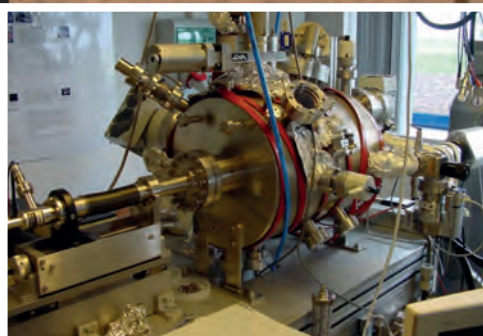
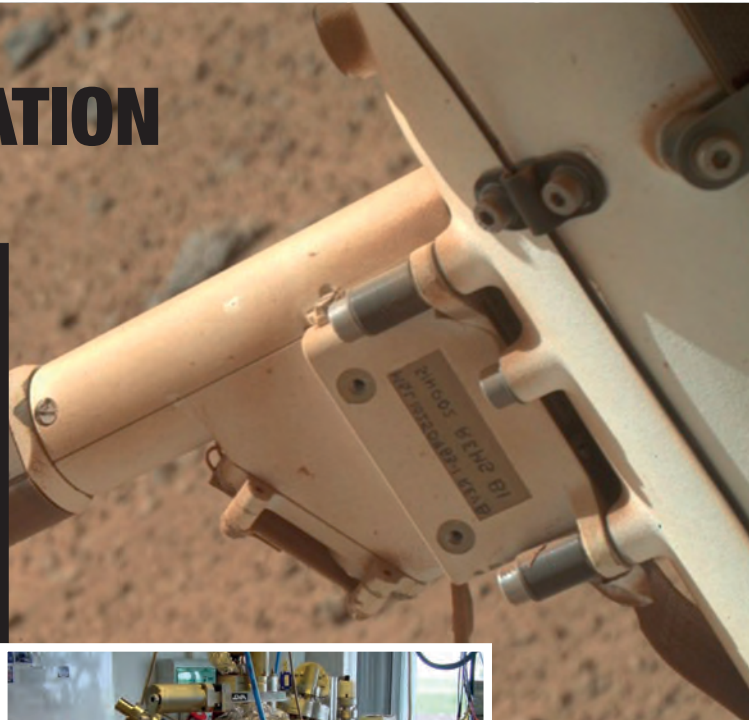

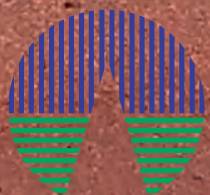

CENTRO DE ASTROBIOLOGÍA
ASSOCIATED TO NASA ASTROBIOLOGY INSTITUTE

Carretera de Ajalvir, km 4
28850 Torrejón de Ardoz (Madrid)

www.cab.inta-csic.es

