

Congratulations, you and your Mac mini
were made for each other.

Contents

Chapter 1: Ready, Set Up, Go

- 7 Working with Mac OS X Server
- 8 What's in the Box
- 9 Setting Up Your Mac mini
- 16 Setting Up DVD or CD Sharing
- 17 Getting Additional Information onto Your Mac mini
- 20 Putting Your Mac mini to Sleep or Shutting It Down

Chapter 2: Life with Your Mac mini

- 24 What's on the Front of Your Mac mini
- 26 What's on the Back of Your Mac mini
- 28 Using the Apple Remote
- 30 Getting Answers

Chapter 3: Problem, Meet Solution

- 36 Problems That Prevent You from Using Your Mac mini
- 38 Reinstalling Software Using Remote Install Mac OS X
- 41 Other Problems
- 42 Using Apple Server Diagnostics
- 42 Problems with Your Internet Connection

- 45 Problems with AirPort Extreme Wireless Communication
- 46 Keeping Your Software Up to Date
- 46 Learning More, Service, and Support
- 50 Locating Your Product Serial Number

Chapter 4: Last, but Not Least

- 53 Important Safety Information
- 56 Important Handling Information
- 57 Understanding Ergonomics
- 60 Apple and the Environment
- 61 Regulatory Compliance Information

Looking for Something?

- 66 Index

1

Ready, Set Up, Go

www.apple.com/macmini

Mac Help  Server Assistant

Your Mac mini is designed so that you can easily set it up and start using it right away. If you've never used a Mac mini or are new to Mac computers, read this section for instructions about getting started.

Important: Read all the installation instructions and the safety information starting on page 53 before you plug your Mac mini into a power outlet.

If you're an experienced user, you may already know enough to get started. Be sure to look over the information in Chapter 2, "Life with Your Mac mini," to find out about the features of your Mac mini.

Answers to many questions can be found on your Mac mini in Mac Help. For information about Mac Help, see "Getting Answers" on page 30.

Working with Mac OS X Server

As soon as you set up your Mac mini, it's ready to host all of the services provided by Mac OS X Server. For information about configuring and using Mac OS X Server, see *Mac OS X Server: Getting Started* on the *Admin Tools* CD. To learn more about the server software, see the full set of documentation on the Apple Server Resources website at www.apple.com/server/macosx/resources.

What's in the Box

Your Mac mini comes with the following components:

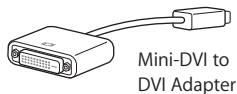

Mini-DVI to
DVI Adapter



AC cord

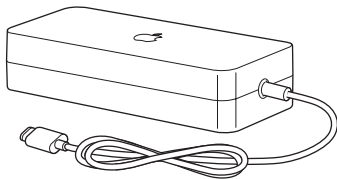

Power adapter

Before you set up your Mac mini, remove the protective film from the outside of your computer and power adapter. Follow the steps on the next several pages to set up.

Important: Don't place anything on top of your Mac mini. Objects placed on top may interfere with the AirPort or Bluetooth® wireless signal.

Setting Up Your Mac mini

Position your Mac mini so that it's right side up or on its side, but not upside down. Use the power adapter that came with your Mac mini; other power adapters may not work.

Step 1: Plug the AC cord into the power adapter, plug the cord from the power adapter into your Mac mini, and then plug the power adapter into a grounded power outlet.

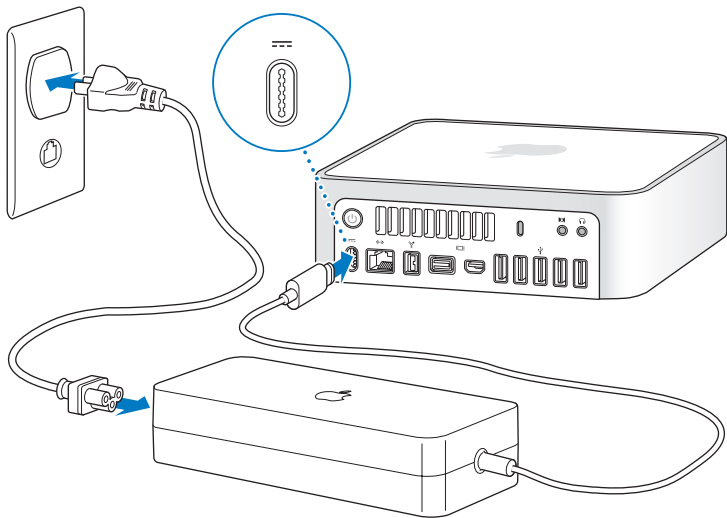

Step 2: To access the Internet or a network, connect one end of an Ethernet cable to your Mac mini and the other end to a cable modem, DSL modem, or network.

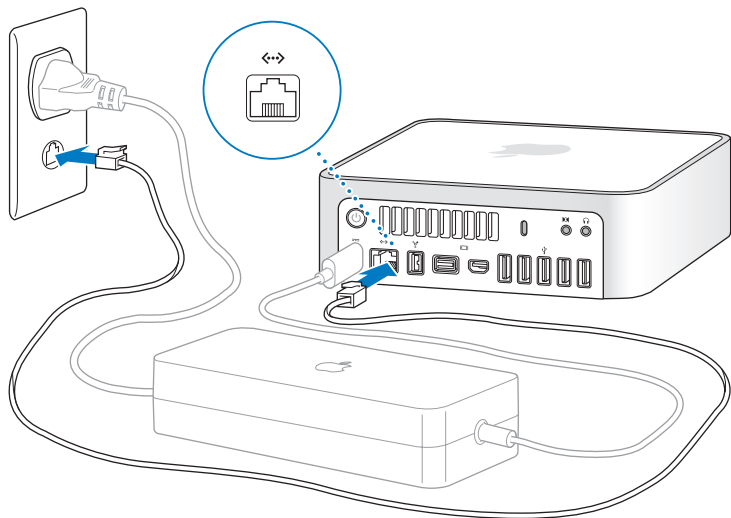

Your Mac mini comes with AirPort Extreme technology for wireless networking. For information about setting up a wireless connection, choose Help > Mac Help, and search for “AirPort.”

Step 3: Connect the USB cable from your keyboard and mouse.

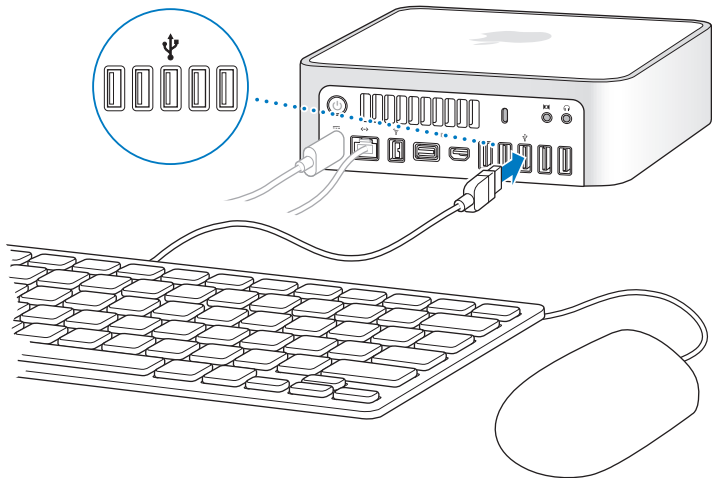

Your Mac mini doesn't come with a keyboard or a mouse, but you can use almost any USB keyboard and mouse. If your keyboard has a USB (⌘) port, plug your mouse into the USB port on the keyboard. If it doesn't, plug the mouse into a USB (⌘) port on the back of your Mac mini.

You can use Keyboard preferences to change the behavior of the Caps Lock, Control, Option, and Command (⌘) modifier keys. To open Keyboard preferences, choose Apple () > System Preferences, click Keyboard, then click Modifier Keys and follow the onscreen instructions.

If you use a USB keyboard that isn't specifically designed for the Mac OS, it may not have a Command (⌘) or Option modifier key, which are standard on Apple keyboards. If you have a keyboard from another manufacturer:

- The Windows key (the icon on the key looks like a Windows logo) is equivalent to the Command (⌘) modifier key on an Apple keyboard.
- The Alt key is equivalent to the Option modifier key on an Apple keyboard.

Using a USB mouse or keyboard from another manufacturer may require software drivers. Check the manufacturer's website for the latest software drivers.

Using a Wireless Keyboard or Mouse

If you purchased an Apple Wireless Keyboard or Mouse with your Mac mini, follow the instructions that came with the keyboard and mouse to set them up with your Mac mini.

Step 4: Connect a display cable to the Mini-DVI port or Mini DisplayPort.

Your Mac mini doesn't come with a display. You can connect a display that has:

- A Mini DisplayPort connector. Connect directly to the Mini DisplayPort.
- A DVI connector. Use the Mini-DVI to DVI Adapter that came with your Mac mini to connect to the Mini-DVI port.
- A VGA connector. Use the Mini-DVI to VGA Adapter to connect to the Mini-DVI port or the Mini DisplayPort to VGA Adapter to connect to the Mini DisplayPort. Adapters are available at www.apple.com/store or your local Apple Store.

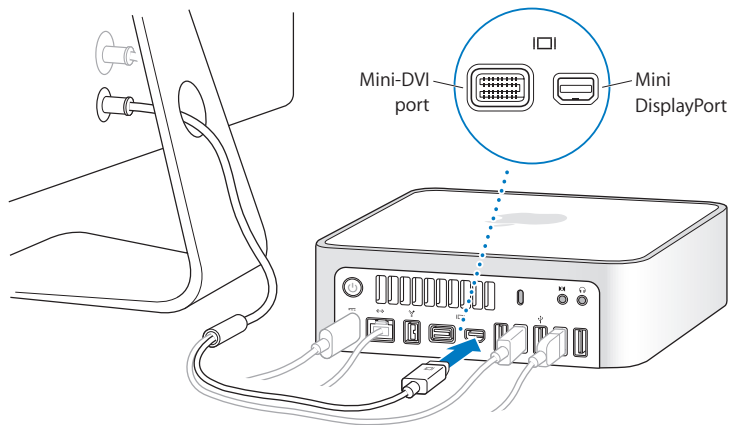

Step 5: Press the power (⏻) button on the back to turn on your Mac mini.

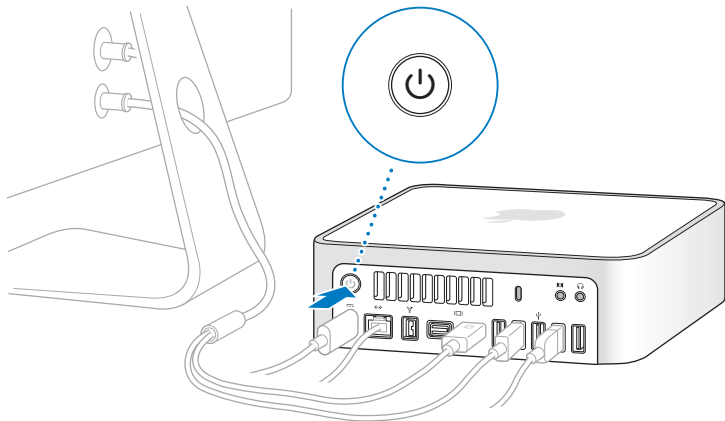

Step 6: Configure your Mac mini with Mac OS X Server Assistant.

The first time you turn on your Mac mini, Mac OS X Server Assistant asks for some basic information that Mac OS X Server needs in order to start up and connect to the network. Be ready to provide the following information the first time you turn on your Mac mini:

- A server administrator account name and password.
- Your Mac OS X Server software serial number.
- Detailed network settings, including IP address, subnet mask, and DNS servers.

- Whether you'll create user and group accounts on your Mac mini, or use accounts from an existing directory service.

For a list of information needed to fully configure your Mac mini using Server Assistant, see *Mac OS X Server: Installation and Setup Worksheet* on the *Mac OS X Server Install DVD* or on the Apple Server Resources website at www.apple.com/server/macosx/resources.

If you already have a Mac with Mac OS X Server version 10.4, 10.5, or 10.6, Server Assistant can help you automatically transfer system settings, service settings, user accounts, files, applications, and other information from your previous Mac to your Mac mini. Use an Ethernet, FireWire, or a wireless connection to transfer information.

For information about working with the services in Mac OS X Server, see the *Mac OS X Server: Getting Started* guide that was included with your Mac mini. For detailed information about Mac OS X Server, go to www.apple.com/server/macosx/resources.

Step 7: Customize your desktop and set your preferences.

You can easily make your desktop look the way you want using System Preferences, your command center for most settings on your Mac mini. Choose Apple () > System Preferences from the menu bar, or click the System Preferences icon in the Dock. For more information, open Mac Help and search for "System Preferences" or for the specific preference you want to change.

Setting Up DVD or CD Sharing

You can use DVD or CD sharing to partner with another Mac or Windows computer that has an optical disc drive and is on the same wired or wireless network. Use this other computer to:

- Share the contents of DVDs or CDs or install applications (see “Sharing Discs with DVD or CD Sharing” on page 17)
- Remotely install Mac OS X Server (see “Reinstalling Software Using Remote Install Mac OS X” on page 38) or use Disk Utility (see “Using Disk Utility” on page 40)

The computer with the optical drive can be a Mac with Mac OS X v10.4.11 or later, or a Windows XP or Windows Vista computer. If the Mac has Mac OS X v10.5.5 or later, DVD or CD Sharing is already installed. You can partner with more than one other computer.

If the other computer is a Windows computer or a Mac with a Mac OS X version earlier than 10.5.5, insert the *Mac OS X Install DVD* that came with your Mac mini to install the DVD or CD Sharing Setup, which includes software for DVD or CD Sharing, Migration Assistant, and Remote Install Mac OS X:

- If the other computer is a Windows computer, choose “DVD or CD Sharing” from the Install Assistant that starts automatically.
- If the other computer is a Mac, double-click the DVD or CD Sharing Setup package on the *Mac OS X Install DVD*.

Important: After you install the DVD or CD Sharing Setup package on your other Mac, make sure you have the latest software by choosing Apple (🍏) > Software Update. Install any available Mac OS X updates.

Getting Additional Information onto Your Mac mini

If you want to install third-party applications from a DVD or CD, you can install applications onto your Mac mini or share information using the optical disc drive on another Mac or Windows computer (if DVD or CD Sharing is set up and enabled). Read the next section for more information.

Sharing Discs with DVD or CD Sharing

You can enable DVD or CD Sharing on a Mac or Windows computer to use the Remote Disc feature of your Mac mini. Remote Disc allows you to share the discs you insert into the optical disc drive of the other computer. Some discs, such as DVD movies and game discs, may be copy-protected and therefore unusable through DVD or CD Sharing.

Make sure DVD or CD Sharing is enabled on any Mac or Windows computer you want to partner with. For information, see page 16.

To enable DVD or CD Sharing, if your other computer is a Mac:

- 1 Make sure the other Mac and your Mac mini are on the same wireless network. Check the AirPort (📶) status icon in the menu bar to see what network you're connected to.

2 On the other Mac, choose Apple (🍏) > System Preferences and then open Sharing.

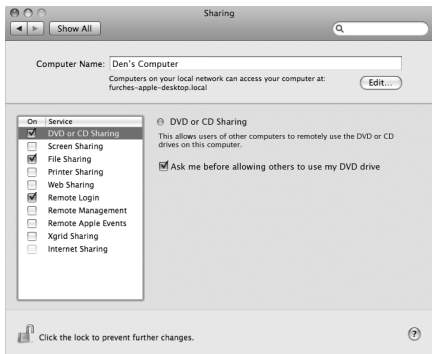

3 In the Sharing panel, select “DVD or CD Sharing” in the Service list. If you want other users to request permission to share a DVD or CD, select “Ask me before allowing others to use my DVD drive.”

To enable DVD or CD Sharing, if your other computer is a Windows computer:

1 Make sure your Mac mini and the Windows computer are on the same wireless network.

- 2 On the Windows computer, open the DVD or CD Sharing control panel.

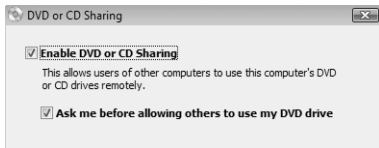

- 3 Select “Enable DVD or CD Sharing.” If you want other users to request permission to share a DVD or CD, select “Ask me before allowing others to use my DVD drive.”

To use a shared DVD or CD:

- 1 On the other computer, insert a DVD or CD into the optical disc drive.
- 2 On your Mac mini, select the Remote Disc when it appears under Devices in the Finder sidebar. If you see the “Ask to use” button, click it.



- 3 On the other computer, when prompted, click Accept to allow your Mac mini to use the DVD or CD.
- 4 On your Mac mini, use the disc as you normally would once it becomes available.

If you try to shut down the other computer or eject the shared DVD or CD while your Mac mini is using it, you'll see a message telling you that the disc is in use. To proceed, click Continue.

Putting Your Mac mini to Sleep or Shutting It Down

When you finish working with your Mac mini, you can put it to sleep or shut it down.

Putting Your Mac mini to Sleep

If you'll be away from your Mac mini for less than a few days, put it to sleep. When your Mac mini is in sleep, the display's screen is dark. You can quickly wake your Mac mini and bypass the startup process.

To put your Mac mini to sleep, do one of the following:

- Choose Apple () > Sleep from the menu bar.
- Press the power (⏻) button on the back of your Mac mini.
- Choose Apple () > System Preferences, click Energy Saver, and set a sleep timer.
- Press and hold the Play/Pause (⏮) button on the optional Apple Remote for 3 seconds.

To wake your Mac mini, press any key on the keyboard or any button on the optional Apple Remote. When your Mac mini wakes from sleep, your applications, documents, and computer settings are exactly as you left them.

Shutting Down Your Mac mini

If you won't be using your Mac mini for more than a few days, shut it down. Choose Apple () > Shut Down. To turn your Mac mini on again, press the power (⏻) button.

NOTICE: Shut down your Mac mini before moving it. Moving your Mac mini while the hard disk is spinning can damage the hard disk, causing loss of data or an inability to start up from the hard disk.

2

Life with Your Mac mini

www.apple.com/server/macosx

Mac Help  server

Read on for an overview of the features and ports of your Mac mini.

The Apple website at www.apple.com links you to the latest Apple news, free downloads, and online catalogs of software and hardware for your Mac mini.

You can also find the manuals for many Apple products and technical support for all Apple products on the Apple Support website at www.apple.com/support.

What's on the Front of Your Mac mini

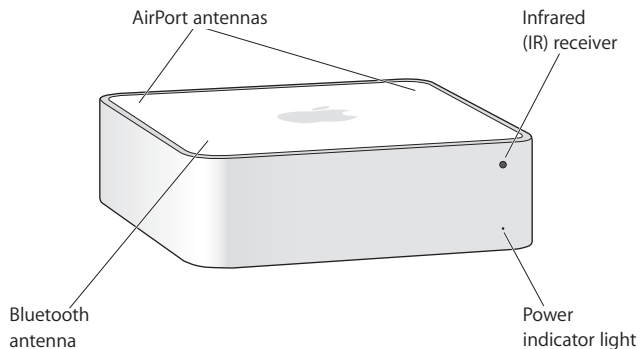

**AirPort Extreme wireless technology (inside)**

Connect to a wireless network using built-in AirPort Extreme technology. To avoid interference, keep the area around the AirPort antennas free from obstruction.

Built-in infrared (IR) receiver

Use an optional Apple Remote (available separately) with the IR receiver to control Front Row and Keynote on your Mac mini from up to 30 feet (9.1 meters) away.

Power indicator light

A steady white light indicates your Mac mini is on; a pulsing light indicates it's in sleep.

**Bluetooth wireless technology (inside)**

Connect wireless devices, such as Bluetooth mobile phones, PDAs, printers, and the Apple Wireless Keyboard and Mouse (you can purchase the Apple Wireless Keyboard and Mouse at www.apple.com/store or your local Apple Store).

Note: Display adapters and other accessories for your Mac mini are sold separately at www.apple.com/store or your local Apple Store.

What's on the Back of Your Mac mini

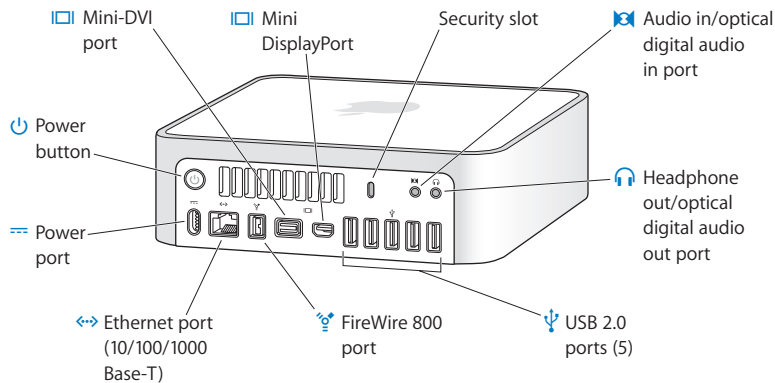

**Mini-DVI port**

Use the included Mini-DVI to DVI Adapter to connect to a DVI display or a TV.

**Mini DisplayPort**

Connect a display that uses a Mini DisplayPort connector.

Security slot

Attach a lock and cable (available separately) to discourage theft.

**Audio in/optical digital audio in port**

Connect a line-level microphone or digital audio equipment.

**Headphone out/optical digital audio out port**

Connect headphones, external powered speakers, or digital audio equipment.

**Five high-speed USB (Universal Serial Bus) 2.0 ports**

Connect an iPod, iPhone, mouse, keyboard, printer, disk drive, digital camera, joystick, external USB modem, and more. You can also connect USB 1.1 devices.

**One FireWire 800 port**

Connect high-speed external devices, such as digital video cameras and storage devices.

**Ethernet port**

Connect to a high-speed 10/100/1000Base-T Ethernet network, a DSL or cable modem, or another computer. The Ethernet port automatically detects Ethernet devices and doesn't require an Ethernet crossover cable.

**Power port**

Connect the power cord from the power adapter.

**Power button**

Turn your Mac mini on or off, or put it to sleep. Press and hold to reset during troubleshooting.

Using the Apple Remote

With the optional Apple Remote you can play music from your iTunes music library, watch photo slideshows and QuickTime movie trailers, play a DVD with DVD Player, and more—all from across the room.

Your Apple Remote can:

- Navigate in iTunes or DVD Player.
- Put to sleep or wake your Mac mini.

To use your Apple Remote:

- Press the Play/Pause (▶⏸) button to play or pause a song, slideshow, or movie.
- Press the Next/Fast-forward (▶▶) or Previous/Rewind (◀◀) button to skip to the next or previous song in your iTunes library or the next or previous chapter in a DVD movie.
- Hold down the Next/Fast-forward (▶▶) or Previous/Rewind (◀◀) button to fast-forward or rewind within a song or a movie.
- Press the Volume Up (+) or Volume Down (–) button to adjust the volume.

Pairing Your Apple Remote

If you have multiple computers or other devices with built-in IR receivers in a room (for example, more than one Mac mini in a home office or lab), you can “pair” your Apple Remote with a specific computer or device. Pairing sets up the receiving computer or device so it’s controlled by only one remote.

To pair your Apple Remote with your Mac mini:

- 1 Move very close to your Mac mini (within 3 to 4 inches or 8 to 10 cm).
- 2 Point the Apple Remote at the front of your Mac mini.
- 3 Press and hold the Next/Fast-forward (▶▶) and Menu (MENU) buttons simultaneously for 5 seconds.

When you've successfully paired your Apple Remote with your Mac mini, a chainlink (⌘) symbol appears onscreen.

To delete a pairing between your Apple Remote and your Mac mini:

- 1 Choose Apple (🍏) > System Preferences from the menu bar.
- 2 Click Security, and then click Unpair.

Turning Off IR Reception

You can use Security preferences to turn IR reception on or off.

To turn off IR reception:

- Choose Apple (🍏) > System Preferences from the menu bar and click Security.
- Select the “Disable remote control infrared receiver” checkbox.

Getting Answers

More information about using your Mac mini is available in Mac Help on your computer, and on the Internet at www.apple.com/support.

To open Mac Help:

- 1 Click the Finder icon in the Dock (the bar of icons along the edge of the screen).
- 2 Click the Help menu in the menu bar and do one of the following:
 - a Type a question or term in the Search field, and select a topic from the list of results or select Show All Results to see all topics.
 - b Choose Mac Help to open the Mac Help window, where you can browse topics or type a search question.

More Information

For more information about using your Mac mini, see the following:

To learn about	See
Troubleshooting Mac mini if you have a problem	Chapter 3, "Problem, Meet Solution," on page 33.
Finding service and support for your Mac mini	"Learning More, Service, and Support" on page 46 or go to the Mac mini Support site at www.apple.com/support/macmini .
Using Mac OS X Server	The Mac OS X Server site at www.apple.com/server/macosx . Or search for "Mac OS X Server" in Mac Help.
Moving from a PC to a Mac	"Why you'll love a Mac" at www.apple.com/getamac/whymac .
Changing System Preferences	System Preferences by choosing Apple () > System Preferences. Or search for "system preferences" in Mac Help.

To learn about	See
Using AirPort Extreme wireless technology	The AirPort Support page at www.apple.com/support/airport . Or open Mac Help and search for "AirPort."
Using Bluetooth wireless technology	Mac Help and search for "Bluetooth." Or go to the Bluetooth Support page at www.apple.com/support/bluetooth .
Connecting a printer	Mac Help and search for "printing."
FireWire and USB connections	Mac Help and search for "FireWire" or "USB."
Connecting to the Internet	Mac Help and search for "Internet."
Using a display	Mac Help and search for "display."
Connecting a TV	The Mac mini site at www.apple.com/macmini/accessories.html .
Apple Remote	Mac Help and search for "remote."
Front Row	Mac Help and search for "Front Row."
Specifications	The Specifications page at www.apple.com/support/specs . Or open System Profiler by choosing Apple () > About This Mac from the menu bar, and then clicking More Info.
Apple news, free downloads, and online catalogs of software and hardware	The Apple site at www.apple.com .
Instructions, technical support, and manuals for Apple products	The Apple Support site at www.apple.com/support .

3

Problem, Meet Solution

www.apple.com/support

Mac Help  help

Occasionally, you may have problems while working with your Mac mini. Read on for troubleshooting tips to try when you have a problem. You can also find more troubleshooting information in Mac Help or on the Mac mini Service & Support website at www.apple.com/support/macmini.

If you experience a problem working with your Mac mini, there's usually a simple and quick solution. If you encounter a problem, try to make a note of what you did before the problem occurred. This can help you narrow down the possible causes of the problem and then find the answers you need. Things to note include:

- The applications you were using when the problem occurred. Problems that occur only with a specific application may indicate that the application is not compatible with the Mac OS Server version installed on your computer.
- Any software that you recently installed.
- Any new hardware (such as a peripheral) that you connected.

WARNING: Do not attempt to open your Mac mini. If your Mac mini needs service, see “Learning More, Service, and Support” on page 46 for information about how to contact an Apple Authorized Service Provider or Apple for service. Your Mac mini doesn't have any user-serviceable parts.

Problems That Prevent You from Using Your Mac mini

If your computer won't respond or the pointer won't move

- Make sure the mouse and keyboard are connected. Unplug and then plug in the connectors, making sure they are secure.
- If the problem persists, try to force problem applications to quit. On an Apple keyboard, hold down the Option and Command (⌘) keys and then press the Esc key. On other keyboards, hold down the Windows and Alt keys and then press the Esc key. If a dialog appears, select the frozen application and click Force Quit. Then save your work in any open applications and restart your Mac mini to be sure the problem is entirely cleared up.
- Press and hold the power (⏻) button on the back of your Mac mini for five seconds to shut down your computer.
- Unplug the power cord from your Mac mini. Then plug the power cord back in and press the power (⏻) button to turn your Mac mini on.

If the problem reoccurs when you use a particular application, check with the application's manufacturer to see if the application is compatible with your computer.

For support and contact information about the software that came with your computer, go to www.apple.com/guide or to the manufacturer's website.

If the problem occurs frequently, try reinstalling your system software (see "Reinstalling Software Using Remote Install Mac OS X" on page 38).

If your Mac mini freezes during startup or you see a flashing question mark

- Wait a few seconds. If your Mac mini doesn't start up after a delay, shut down your Mac mini by pressing and holding the power (⏻) button for about 5 seconds, until it shuts down. Then hold down the Option key and press the power (⏻) button again to start up your computer. Keep holding down the Option key until your Mac mini starts up, then click the arrow under the icon of the hard disk you want to use as your startup disk.
- After your Mac mini starts up, open System Preferences and click Startup Disk. Select a local Mac OS X Server System folder.
- If the problem occurs frequently, you may need to reinstall your system software (see "Reinstalling Software Using Remote Install Mac OS X" on page 38).

If your Mac mini doesn't turn on or start up

- Make sure the power cord is plugged into your Mac mini and into a functioning power outlet, and the power cord is plugged into the power adapter.
- Press the power (⏻) button and immediately hold down the Command (⌘), Option, P, and R keys on an Apple keyboard until you hear the startup sound a second time. This resets the parameter RAM (PRAM). On other keyboards, press the power (⏻) button and immediately hold down the Windows, Alt, P, and R keys.
- Unplug the power cord and wait at least 30 seconds. Plug the power cord back in and press the power (⏻) button again to start up your Mac mini.
- If you still can't start up your Mac mini, see "Learning More, Service, and Support" on page 46 for information about contacting Apple for service.

Reinstalling Software Using Remote Install Mac OS X

Use Remote Install Mac OS X on a partner computer whose optical disc drive you want to share, when you want to do any of the following tasks on your Mac mini:

- Reinstall Mac OS X Server and other software that came with your Mac mini
- Reset your password
- Use Disk Utility to repair the Mac mini hard disk

Instructions for installing the DVD or CD Sharing Setup software are on page 16.

To use Remote Install Mac OS X:

- 1 Insert the *Mac OS X Server Install DVD* into the optical disc drive of the other computer.
- 2 If the other computer is a Mac, open `/Applications/Utilities/Remote Install Mac OS X`. (Unless the other Mac already has Mac OS X v10.5.5, you might need to install this application.) On Windows, choose “Remote Install Mac OS X” from the Install Assistant.

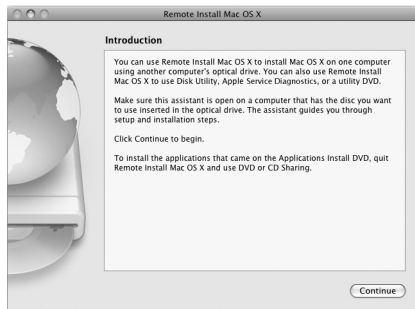

- 3 Read the introduction and click Continue.
- 4 Select the installation disc you want to use, and click Continue.
- 5 Select a network connection: AirPort, if you're using an AirPort network, or Ethernet, if the other computer is on an Ethernet network. Click Continue.
- 6 Restart your Mac mini and hold down the Option key as it starts up, until you see a list of available startup disks.
- 7 Choose a startup disk.
- 8 Click Continue in Remote Install Mac OS X.
- 9 If you chose AirPort as your network in step 5, on your Mac mini choose your AirPort network from the pop-up list.
If the network is secure, you are prompted for a password. You can enter a private network name by choosing the ellipsis (...) and typing the name.
- 10 If you chose AirPort as your network in step 5, when you see the AirPort status icon indicating signal strength, click Continue in Remote Install Mac OS X.
- 11 On your Mac mini, click the arrow button beneath the installer icon and then do one of the following:
 - If you forgot your password and need to reset it, go to "Resetting Your Password" below.
 - If you want to run Disk Utility, go to "Using Disk Utility" on page 40.

Resetting Your Password

You can reset your administrator password and passwords for all other accounts.

To reset your password, using a partner computer and Remote Install Mac OS X:

- 1 Follow the procedure for using Remote Install Mac OS X beginning on page 38.
- 2 Click Continue in Remote Install Mac OS X.
- 3 On your Mac mini, choose Utilities > Reset Password from the menu bar and follow the onscreen instructions. When you finish, quit Mac OS X Installer.
- 4 On the other computer, click Quit to exit Remote Install Mac OS X.

Using Disk Utility

When you need to repair, verify, or erase your Mac mini hard disk, use Disk Utility by sharing the optical disc drive of another computer.

To use Disk Utility from a partner computer:

- 1 Follow the procedure for using Remote Install Mac OS X beginning on page 38.
- 2 Click Continue in Remote Install Mac OS X.
- 3 On your Mac mini, choose Installer > Open Disk Utility and then follow the instructions in the First Aid pane to see if Disk Utility can repair the disk. When you finish, quit Mac OS X Installer on your Mac mini.
- 4 On the other computer, click Quit to exit Remote Install Mac OS X.

If using Disk Utility doesn't help, try reinstalling your computer's system software. See "Reinstalling Software Using Remote Install Mac OS X" on page 38.

Other Problems

If you have a problem with an application

For problems with software from a manufacturer other than Apple, contact the manufacturer. Software manufacturers often provide updates to their software on their websites.

You can set your Mac mini to check for and install the latest Apple software automatically using the Software Update pane of System Preferences. For more information, choose Help > Mac Help and search for “software update.”

If you have a problem using your Mac mini or working with Mac OS X Server

- If the answers to your questions aren't in this guide, look in Mac Help for instructions and troubleshooting information. Choose Help > Mac Help.
- Check the Apple Support website at www.apple.com/support/macosxserver for the latest troubleshooting information and software updates.

If your date and time settings get lost repeatedly

- You may need to have the internal backup battery replaced. For information about contacting Apple for service, see “Learning More, Service, and Support” on page 46.

Using Apple Server Diagnostics

If you suspect a problem with your Mac mini hardware, use Apple Server Diagnostics to help determine if there's a problem with one of the computer's components.

To use Apple Server Diagnostics:

- 1 Disconnect all external devices from your Mac mini, except the keyboard and mouse. If you have an Ethernet cable connected, disconnect it.
- 2 Restart your Mac mini while holding down the D key.
- 3 When the Apple Server Diagnostics chooser screen appears, select the language you want to use.
- 4 Press the Return key or click the right arrow button.
- 5 When the Apple Server Diagnostics main screen appears (after about 45 seconds), follow the onscreen instructions.
- 6 If Apple Server Diagnostics detects a problem, it displays an error code. Make a note of the error code before pursuing support options. If Apple Server Diagnostics doesn't detect a hardware failure, the problem may be software-related.

For more information, see the Apple Server Diagnostics documentation on the *Admin Tools* CD.

Problems with Your Internet Connection

Your Mac mini has the Setup Assistant application to help walk you through setting up an Internet connection. Open System Preferences and click Network. Click the "Assist me" button to open Network Setup Assistant.

If you have trouble with your Internet connection, you can try the steps in this section for your type of connection or you can use Network Diagnostics.

To use Network Diagnostics:

- 1 Choose Apple (🍏) > System Preferences.
- 2 Click Network and then click “Assist me.”
- 3 Click Diagnostics to open Network Diagnostics.
- 4 Follow the onscreen instructions.

If Network Diagnostics can't resolve the problem, there may be a problem with the Internet service provider (ISP) you are trying to connect to, with an external device you are using to connect to your ISP, or with the server you are trying to access. You can try the steps in the following sections.

Cable Modem, DSL Modem, and LAN Internet Connections

Make sure all modem cables are firmly plugged in, including the modem power cord, the cable from the modem to the computer, and the cable from the modem to the wall jack. Also check the cables and power supplies to any Ethernet hubs or routers.

Turn the modem off and on and reset the modem hardware

Turn off your DSL or cable modem for a few minutes, and then turn it back on. Some ISPs recommend that you unplug the modem's power cord. If your modem has a reset button, you can press it either before or after you turn the power off and on.

Important: Instructions that refer to modems do not apply to LAN users. LAN users might have hubs, switches, routers, or connection pods that cable and DSL modem users do not have. LAN users should contact their network administrator rather than an ISP.

PPPoE Connections

If you are unable to connect to your ISP using PPPoE (Point to Point Protocol over Ethernet), make sure you have entered the correct information in Network preferences.

To enter PPPoE settings:

- 1 Choose Apple (🍏) > System Preferences.
- 2 Click Network.
- 3 Click Add (+) at the bottom of the network connection services list, and choose PPPoE from the Interface pop-up menu.
- 4 Choose an interface for the PPPoE service from the Ethernet pop-up menu.
Choose Ethernet if you are connecting to a wired network, or AirPort if you are connecting to a wireless network.
- 5 Enter the information you received from your service provider, such as the account name, password, and PPPoE service name (if your service provider requires it).
- 6 Click Apply to make the settings active.

Network Connections

Make sure the Ethernet cable is plugged into your Mac mini and into the network. Check the cables and power supplies to your Ethernet hubs and routers.

If you have two or more computers sharing an Internet connection, be sure that your network is set up properly. You need to know whether your ISP provides only one IP address or multiple IP addresses, one for each computer.

If only one IP address is provided, then you must have a router capable of sharing the connection, also known as network address translation (NAT) or “IP masquerading.” For setup information, check the documentation provided with your router or ask the person who set up your network. The AirPort Base Station can be used to share one IP address among multiple computers. For information about using an AirPort Base Station, check Mac Help or visit the AirPort Extreme website at www.apple.com/support/airport.

If you can't resolve the issue using these steps, contact your ISP or network administrator.

Problems with AirPort Extreme Wireless Communication

If you have trouble using AirPort Extreme wireless communication:

- Make sure the computer or network you are trying to connect to is running and has a wireless access point.
- Make sure you have properly configured the software according to the instructions that came with your base station or access point.
- Make sure you are within antenna range of the other computer or the network's access point. Nearby electronic devices or metal structures can interfere with wireless communication and reduce this range. Repositioning or rotating the computer might improve reception.
- Check the AirPort (📶) status menu in the menu bar. Up to four bars appear, indicating signal strength. If the signal strength is weak, try changing your location.

- See AirPort Help (choose Help > Mac Help, and then choose Library > AirPort Help from the menu bar). Also see the instructions that came with the wireless device for more information.

Keeping Your Software Up to Date

You can connect to the Internet and automatically download and install the latest free software versions, drivers, and other enhancements from Apple.

When you are connected to the Internet, Software Update checks to see if any updates are available for your computer. You can set your Mac mini to check for updates periodically, and then you can download and install updated software.

To check for updated software:

- 1 Choose Apple () > System Preferences.
- 2 Click the Software Update icon and follow the instructions on the screen.
 - Search for “Software Update” in Mac Help for more information.
 - Go to www.apple.com/server/macosx for the latest information about Mac OS X Server.

Learning More, Service, and Support

Your Mac mini does not have any user-serviceable parts. If you need service, take your Mac mini to an Apple Authorized Service Provider or contact Apple for service. You can find more information about your Mac mini through online resources, onscreen help, System Profiler, or Apple Hardware Test.

If you want additional memory installed, contact an Apple Authorized Service Provider or an Apple Store retail location.

Online Resources

For online service and support information, go to www.apple.com/support. Choose your country from the pop-up menu. You can search the AppleCare Knowledge Base, check for software updates, or get help from Apple's discussion forums.

Onscreen Help

You can often find answers to your questions, as well as instructions and troubleshooting information, in Mac Help. Choose Help > Mac Help.

System Profiler

To get information about your Mac mini, use System Profiler. System Profiler shows you which hardware and software is installed, the serial number and operating system version, how much memory is installed, and more. To open System Profiler, choose Apple () > About This Mac from the menu bar and then click More Info.

AppleCare Service and Support

Your Mac mini comes with 90 days of technical support and one year of hardware repair warranty coverage at an Apple Store retail location or an Apple-authorized repair center, such as an Apple Authorized Service Provider (AASP). You can extend your coverage by purchasing the AppleCare Protection Plan. For information, visit www.apple.com/support/products or visit the website address for your country listed in the table.

Apple also offers expert support for Mac OS X Server. Beyond the scope of the complimentary 90-day support, these products offer assistance with in-depth technical issues for one full year.

Mac OS X Server Software Support delivers consultative telephone¹ and email² support for networking and workflow issues in Mac OS X Server environments, including support for command-line tools and mixed-platform integration.³ Mac OS X Server Software Support also includes all of the features of AppleCare Help Desk Support, described below. Choose from three levels of support—Select, Preferred, and Alliance.

AppleCare Help Desk Support gives you a year of expertise for your internal help desk. This product provides priority telephone¹ and email² support to two designated contacts in your organization. Covered products include Apple Remote Desktop, Final Cut Studio, Final Cut Server, Aperture, Logic Studio, Mac OS, and the graphical user interface in Mac OS X Server. You also receive a subscription to AppleCare Help Desk Tools, a library of Mac OS installation and hardware diagnostic discs that are updated quarterly.

¹Telephone numbers and hours of operation may vary and are subject to change; local telephone fees may apply.

²Access to web-based resources requires the use of a compatible Internet service provider; fees may apply.

³Details on support coverage and eligible Apple technologies are described in the Mac OS X Server Software Support and AppleCare Help Desk Support plans at:
www.apple.com/support/products/macosxserver_sw_supt.html
www.apple.com/support/products/helpdesk.html

If you need assistance, AppleCare telephone support representatives can help you with installing and opening applications, and basic troubleshooting. Call the support center number nearest you (the first 90 days are complimentary). Have the purchase date and your Mac mini serial number ready when you call.

Note: Your 90 days of complimentary telephone support begins on the date of purchase and telephone fees may apply.

Country	Phone	Website
United States	1-800-275-2273	www.apple.com/support
Australia	(61) 1-300-321-456	www.apple.com/au/support
Canada (English) (French)	1-800-263-3394	www.apple.com/ca/support www.apple.com/ca/fr/support
Ireland	(353) 1850 946 191	www.apple.com/ie/support
New Zealand	00800-7666-7666	www.apple.com/nz/support
United Kingdom	0844 209 0611	www.apple.com/uk/support

Telephone numbers are subject to change, and local and national telephone rates may apply. A complete list is available on the web:

www.apple.com/contact/phone_contacts.html

Locating Your Product Serial Number

Use any of these methods to find your Mac mini serial number:

- Choose Apple (🍏) from the menu bar and then choose About This Mac. Click the version number beneath the words “Mac OS X Server” to cycle through the Mac OS X Server version number, the build version, and the serial number.
- Open System Profiler (in /Applications/Utilities/) and click Hardware.
- Look on the bottom of your Mac mini.

4

Last, but Not Least

www.apple.com/environment

Mac Help  ergonomics

For your safety and that of your equipment, follow these rules for handling and cleaning your Mac mini and for working more comfortably. Keep these instructions handy for reference by you and others.

NOTICE: Incorrect storage or use of your computer may void the manufacturer's warranty.

Important Safety Information

WARNING: Failure to follow these safety instructions could result in fire, electric shock, or other injury or damage.

Proper handling Set up your Mac mini on a stable work surface that allows for adequate air circulation under and around the computer. Do not operate your Mac mini on a pillow or other soft material, as the material can block the airflow vents. Never push objects into the ventilation openings.

Water and wet locations Keep your Mac mini away from sources of liquid, such as drinks, washbasins, bathtubs, shower stalls, and so on. Protect your Mac mini from dampness or wet weather, such as rain, snow, and fog.

Power adapter Follow these guidelines for using the power adapter:

- Make sure you push the power plugs snugly into the power adapter, your computer, and the power outlet.
- Always leave space around the power adapter and use your Mac mini in a location where airflow around the power adapter is not obstructed.

- Use the power adapter that came with your computer. Your Mac mini uses a 110 watt power adapter.
- The only way to disconnect power completely is to unplug the power cord. Make sure you pull the plug, not the cord.

WARNING: It is normal for the power adapter to get warm during use. Always allow adequate ventilation and avoid prolonged contact.

Disconnect the power adapter and disconnect any other cables if any of the following conditions exist:

- You want to clean your Mac mini (use only the recommended procedure described on page 57).
- The power cord or plug becomes frayed or otherwise damaged.
- Your Mac mini or power adapter is exposed to rain, excessive moisture, or liquid spilled into the case.
- Your Mac mini or power adapter has been dropped or damaged, or you suspect that service or repair is required.

Power specifications:

- *Frequency:* 50 to 60 Hz
- *Line Voltage:* 100 to 240 V AC

Hearing damage Permanent hearing loss may occur if earbuds or headphones are used at high volume. You can adapt over time to a higher volume of sound that may sound normal but can be damaging to your hearing. If you experience ringing in your ears or muffled speech, stop listening and have your hearing checked. The louder the volume, the less time is required before your hearing could be affected. Hearing experts suggest that to protect your hearing:

- Limit the amount of time you use earbuds or headphones at high volume.
- Avoid turning up the volume to block out noisy surroundings.
- Turn the volume down if you can't hear people speaking near you.

High-risk activities This computer system is not intended for use in the operation of nuclear facilities, aircraft navigation or communications systems, air traffic control systems, or for any other uses where the failure of the computer system could lead to death, personal injury, or severe environmental damage.

WARNING: Making adjustments or performing procedures other than those specified in your equipment's manual may result in hazardous radiation exposure.

Important: Electrical equipment may be hazardous if misused. Operation of this product, or similar products, must always be supervised by an adult. Do not allow children access to the interior of any electrical product and do not permit them to handle any cables.

WARNING: Never push objects of any kind into this product through the ventilation openings in the case. Doing so may be dangerous and damage your computer.

Do Not Make Repairs Yourself

Your Mac mini doesn't have any user-serviceable parts. Do not attempt to open your Mac mini. If your Mac mini needs service, consult the service and support information that came with your computer for instructions about how to contact an Apple Authorized Service Provider or Apple for service.

If you open your Mac mini or install items, you risk damaging your equipment, and such damage isn't covered by the limited warranty on your Mac mini.

Important Handling Information

NOTICE: Failure to follow these handling instructions could result in damage to your Mac mini or other property.

Operating environment Operating your Mac mini outside these ranges may affect performance:

- *Operating temperature:* 50° to 95° F (10° to 35° C)
- *Storage temperature:* -40° to 116° F (-40° to 47° C)
- *Relative humidity:* 5% to 95% (noncondensing)
- *Maximum operating altitude:* 10,000 feet (3048 meters)

Turning on your Mac mini Never turn on your Mac mini unless all of its internal and external parts are in place. Operating the computer when parts are missing may be dangerous and may damage your computer.

Carrying your Mac mini Before you lift or reposition your Mac mini, shut it down and disconnect all cables and cords connected to it. If you carry your Mac mini in a bag or briefcase, make sure that there are no loose items (such as paper clips or coins) that could accidentally get inside the computer through vent openings or the optical drive slot or get stuck inside a port.

Using connectors and ports Never force a connector into a port. When connecting a device, make sure the port is free of debris, that the connector matches the port, and that you have positioned the connector correctly in relation to the port.

Storing your Mac mini If you are going to store your Mac mini for an extended period of time, keep it in a cool location (ideally, 71° F or 22° C).

Cleaning your Mac mini When cleaning the outside of your Mac mini and its components, first shut down your Mac mini and unplug the power adapter. Then use a damp, soft, lint-free cloth to clean the computer's exterior. Avoid getting moisture in any openings. Do not spray liquid directly on the computer. Do not use aerosol sprays, solvents, or abrasives that might damage the finish.

Understanding Ergonomics

Here are some tips for setting up a healthy work environment.

Keyboard

When you use the keyboard, your shoulders should be relaxed. Your upper arm and forearm should form an approximate right angle, with your wrist and hand in roughly a straight line.

Change hand positions often to avoid fatigue. Some computer users might develop discomfort in their hands, wrists, or arms after intensive work without breaks. If you begin to develop chronic pain or discomfort in your hands, wrists, or arms, consult a qualified health specialist.

Mouse

Position the mouse at the same height as the keyboard and within a comfortable reach.

Chair

An adjustable chair that provides firm, comfortable support is best. Adjust the height of the chair so your thighs are horizontal and your feet are flat on the floor. The back of the chair should support your lower back (lumbar region). Follow the manufacturer's instructions for adjusting the backrest to fit your body properly.

You might have to raise your chair so that your forearms and hands are at the proper angle to the keyboard. If this makes it impossible to rest your feet flat on the floor, use a footrest with adjustable height and tilt to make up for any gap between the floor and your feet. Or you can lower the desktop to eliminate the need for a footrest. Another option is to use a desk with a keyboard tray that's lower than the regular work surface.

Display

Arrange the display so that the top of the screen is slightly below eye level when you're sitting at the keyboard. The best distance from your eyes to the screen is up to you, although most people seem to prefer 18 to 28 inches (45 to 70 cm).

Position the display to minimize glare and reflections on the screen from overhead lights and nearby windows. If possible, use a tiltable display stand. The stand lets you set the display at the best angle for viewing, helping to reduce or eliminate glare from lighting sources you can't move.

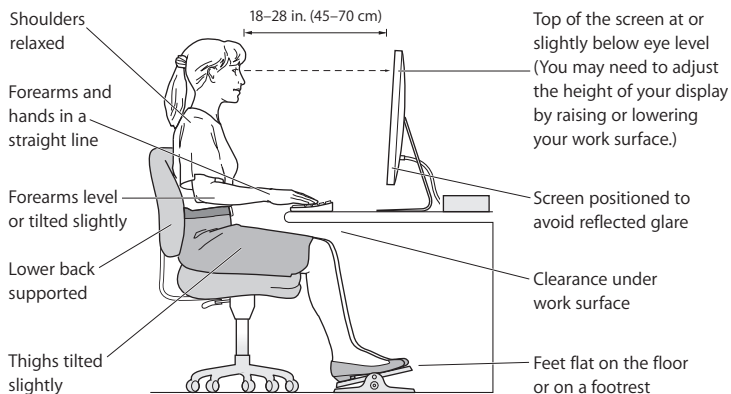

More information about ergonomics is available on the web:

www.apple.com/about/ergonomics

Apple and the Environment

Apple Inc. recognizes its responsibility to minimize the environmental impact of its operations and products.

More information is available on the web:

www.apple.com/environment

Regulatory Compliance Information

Compliance Statement

This device complies with part 15 of the FCC rules.

Operation is subject to the following two conditions:

- (1) This device may not cause harmful interference, and
- (2) this device must accept any interference received, including interference that may cause undesired operation. See instructions if interference to radio or television reception is suspected.

L'utilisation de ce dispositif est autorisée seulement aux conditions suivantes: (1) il ne doit pas produire de brouillage et (2) l'utilisateur du dispositif doit être prêt à accepter tout brouillage radioélectrique reçu, même si ce brouillage est susceptible de compromettre le fonctionnement du dispositif.

Radio and Television Interference

This computer equipment generates, uses, and can radiate radio-frequency energy. If it is not installed and used properly—that is, in strict accordance with Apple's instructions—it may cause interference with radio and television reception.

This equipment has been tested and found to comply with the limits for a Class B digital device in accordance with the specifications in Part 15 of FCC rules. These specifications are designed to provide reasonable protection against such interference in a residential installation. However, there is no guarantee that interference will not occur in a particular installation.

You can determine whether your computer system is causing interference by turning it off. If the interference stops, it was probably caused by the computer or one of the peripheral devices.

If your computer system does cause interference to radio or television reception, try to correct the interference by using one or more of the following measures:

- Turn the television or radio antenna until the interference stops.
- Move the computer to one side or the other of the television or radio.
- Move the computer farther away from the television or radio.
- Plug the computer into an outlet that is on a different circuit from the television or radio. (That is, make certain the computer and the television or radio are on circuits controlled by different circuit breakers or fuses.)

If necessary, consult an Apple Authorized Service Provider or Apple. See the service and support information that came with your Apple product. Or consult an experienced radio/television technician for additional suggestions.

Important: Changes or modifications to this product not authorized by Apple Inc. could void the EMC compliance and negate your authority to operate the product.

This product has demonstrated EMC compliance under conditions that included the use of compliant peripheral devices and shielded cables (including Ethernet network cables) between system components. It is important that you use compliant peripheral devices and shielded cables between system components to reduce the possibility of causing interference to radios, television sets, and other electronic devices.

Responsible party (contact for FCC matters only):

Apple Inc. Corporate Compliance
1 Infinite Loop, MS 26-A
Cupertino, CA 95014

Wireless Radio Use

This device is restricted to indoor use when operating in the 5.15 to 5.25 GHz frequency band.

Cet appareil doit être utilisé à l'intérieur.

Exposure to Radio Frequency Energy

The radiated output power of the AirPort Extreme technology is below the FCC and EU radio frequency exposure limits. Nevertheless, it is advised to use the wireless equipment in such a manner that the potential for human contact during normal operation is minimized.

FCC Bluetooth Wireless Compliance

The antenna used with this transmitter must not be colocated or operated in conjunction with any other antenna or transmitter subject to the conditions of the FCC Grant.

Bluetooth Industry Canada Statement

This Class B device meets all requirements of the Canadian interference-causing equipment regulations.

Cet appareil numérique de la Class B respecte toutes les exigences du Règlement sur le matériel brouilleur du Canada.

Industry Canada Statement

Complies with the Canadian ICES-003 Class B specifications. Cet appareil numérique de la classe B est conforme à la norme NMB-003 du Canada. This device complies with RSS 210 of Industry Canada.

Bluetooth Europe—EU Declaration of Conformity

This wireless device complies with the R&TTE Directive.

Europe—EU Declaration of Conformity

See www.apple.com/euro/compliance.

Korea Warning Statement

"당해 무선설비는 운용 중 전파혼신 가능성이 있음"
"이 기기는 인명안전과 관련된 서비스에 사용할 수 없습니다"

B급 기기(가정용 방송통신기기)

이 기기는 가정용(B급)으로 전자파적합등록을 한 기기로서 주로 가정에서 사용하는 것을 목적으로 하며, 모든 지역에서 사용할 수 있습니다.

Singapore Wireless Certification

Complies with
IDA Standards
DB00063

Taiwan Wireless Statements

無線設備的警告聲明

經型式認證合格之低功率射頻電機，非經許可，公司、商號或使用者均不得擅自變更頻率、加大功率或變更原設計之特性及功能。低功率射頻電機之使用不得影響飛航安全及干擾合法通信；經發現有干擾現象時，應立即停用，並改善至無干擾時方得繼續使用。前項合法通信指依電信法規定作業之無線電通信。低功率射頻電機須忍受合法通信或工業、科學及醫療用電波輻射性電機設備之干擾。

如有這 頻率:

於 5.25GHz 至 5.35GHz 區域內操作之
無線設備的警告聲明

工作頻率 5.250 ~ 5.350GHz 該頻段限於室內使用。

Taiwan Class B Statement

Class B 設備の警告聲明
NIL

VCCI Class B Statement

情報処理装置等電波障害自主規制について

この装置は、情報処理装置等電波障害自主規制協議会 (VCCI) の基準に基づくクラス B 情報技術装置です。この装置は家庭環境で使用されることを目的としていますが、この装置がラジオやテレビジョン受信機に近接して使用されると、受信障害を引き起こすことがあります。

取扱説明書に従って正しい取扱をしてください。

External USB Modem Information

When connecting your Mac mini to the phone line using an external USB modem, refer to the telecommunications agency information in the documentation that came with your modem.

ENERGY STAR® Compliance



As an ENERGY STAR® partner, Apple has determined that standard configurations of this product meet the ENERGY STAR® guidelines for energy efficiency. The ENERGY STAR® program is a partnership with electronic equipment manufacturers to promote energy-efficient products. Reducing energy consumption of products saves money and helps conserve valuable resources.

This computer is shipped with power management enabled with the computer set to sleep after 10 minutes of user inactivity. To wake your computer, click the mouse or trackpad button or press any key on the keyboard.

For more information about ENERGY STAR®, visit:
www.energystar.gov

中国

有毒或 有害物质	零部件		
	电路板	附件	电源适配器
铅 (Pb)	X	X	X
汞 (Hg)	O	O	O
镉 (Cd)	O	O	O
六价铬 (Cr, VI)	O	O	O
多溴联苯 (PBB)	O	O	O
多溴二苯醚 (PBDE)	O	O	O

O: 表示该有毒有害物质在该部件所有均质材料中的含量均在 SJ/T 11363-2006 规定的限量要求以下。

X: 表示该有毒有害物质至少在该部件的某一均质材料中的含量超出 SJ/T 11363-2006 规定的限量要求。

根据中国电子行业标准 SJ/T11364-2006 和相关的中国政府法规, 本产品及其某些内部或外部组件上可能带有环保使用期限标识。取决于组件和组件制造商, 产品及其组件上的使用期限标识可能有所不同。组件上的使用期限标识优先于产品上任何与之相冲突的或不同的环保使用期限标识。

Disposal and Recycling Information



This symbol indicates that your product must be disposed of properly according to local laws and regulations. When your product reaches its end of life, contact Apple or your local authorities to learn about recycling options.

For information about Apple's recycling program, go to www.apple.com/environment/recycling.

Battery Disposal Information

Dispose of batteries according to your local environmental laws and guidelines.

Deutschland: Dieses Gerät enthält Batterien. Bitte nicht in den Hausmüll werfen. Entsorgen Sie dieses Gerätes am Ende seines Lebenszyklus entsprechend der maßgeblichen gesetzlichen Regelungen.

Nederlands: Gebruikte batterijen kunnen worden ingeleverd bij de chemokar of in een speciale batterijcontainer voor klein chemisch afval (kca) worden gedeponeerd.



Taiwan:



廢電池請回收

European Union—Disposal Information



The symbol above means that according to local laws and regulations your product should be disposed of separately from household waste. When this product reaches its end of life, take it to a collection point designated by local authorities. Some collection points accept products for free. The separate collection and recycling of your product at the time of disposal will help conserve natural resources and ensure that it is recycled in a manner that protects human health and the environment.

Looking for Something?

Index

A

adapters

- Mini DisplayPort to VGA Adapter 13
- Mini-DVI to DVI Adapter 13
- Mini-DVI to VGA Adapter 13

AirPort Extreme

- antenna 25
- overview 25
- problems 45
- using 31

AppleCare

- Protection Plan 47
- support information 47

Apple Remote 31

- buttons 28
- using 28

Apple Server Diagnostics 42

applications

- Force Quit 36
- Front Row 25, 31
- Keynote 25
- troubleshooting 41

assistants

- Network Setup Assistant 42

- Server Assistant 14

audio in port 27

audio out port 27

B

battery disposal 64

Bluetooth technology

- overview 25
- wireless signal 8

button, power 14

C

cable modem 10

carrying your computer 57

chair 58

changing

- the desktop 15
- password 40
- System Preferences 15

computer

- cleaning 57
- turning on 14

connecting

- a display 13, 27
- a keyboard 11
- a mouse 11
- an Ethernet cable 10
- audio equipment 27
- cable modem 10

DSL modem 10

FireWire devices 27

headphones 27

the power cord 9

to a network 10

USB devices 27

D

date and time settings 41

desktop, customizing 15

Disk Utility 40

display 13, 58

Dock 30

downloading software 46

DSL modem 10

DVD or CD Sharing 16, 17, 18

DVI display 13

E

environment 60

erasing a disk 40

ergonomics 57

Ethernet port 27

external USB modem 27, 63

F

features 24, 26

Finder 30

FireWire
connections 31
port 27
flashing question mark 37
Force Quit, an application 36
Front Row application 25, 31

H

hand positions 57
headphone port 27

I

infrared
turning off reception 29
infrared receiver 25
installation instructions 7
installing
applications 41
installing DVD or CD
Sharing 16

Internet
connecting 10
connection problems 42

IP

address sharing 44
masquerading 45

K

keyboard
ergonomics 12
ergonomics 57
Keyboard preferences 12

USB ports 11, 12
wireless 12
Keynote application 25

M

Mac Help 15, 30, 35, 47
Mac mini features 24, 26
Mac OS X Server website 30
Mini DisplayPort 13, 27
Mini-DVI port 13, 27
Mini-DVI to DVI Adapter 13
Mini-DVI to VGA Adapter 13
modem
cable 27
DSL 27
external USB 27, 63

mouse

connecting 11
ergonomics 58
USB connection 12, 27
wireless 12

N

network 10
address translation
(NAT) 45
connections 44
diagnostics 43
setup assistant 42
wireless 10
number, serial 50

O

online resources 47
onscreen help 47
operating environment 56
optical digital
audio in 27
audio out 27
optical disc sharing. *See* DVD or
CD Sharing

P

parameter RAM, resetting 37
partner computer
Disk Utility 40
DVD or CD Sharing 16
installing Mac OS X 38
resetting your password 40
password, resetting 40
ports
audio in 27
audio out 27
Ethernet 27
FireWire 800 72
headphone 27
power 27
USB 11, 27
video 13, 27
power adapter
plugging in 53
port 9
power button 14, 27

- power indicator light 25
- power socket 27
- power specifications 54
- PPPoE connections 44
- problems
 - See troubleshooting
- product serial number 50

Q

- question mark, flashing 37

R

- remote
 - delete pairing 28
 - overview 28
 - pairing 28
 - turning off IR reception 29
 - using 28
- Remote Disc 17, 19
- Remote Install Mac OS X
 - Disk Utility 40
 - installing Mac OS X 38
 - resetting your password 40
- repairing a disk 40
- repairs 56
- resetting parameter RAM (PRAM) 37
- resetting your password 40

S

- safety
 - important information 53

- power adapter 53
- security slot 27
- serial number, finding 50
- Server Assistant 14
- service and support 46
- setting up
 - display 13
 - Ethernet 10
 - power adapter 9
 - your computer 9
- Setup Assistant 42
- shared optical disc 17, 18
- sharing files 17, 18
- shutting down your computer 20
- signal
 - AirPort Extreme 8
 - Bluetooth wireless 8
- sleep 20
- software
 - updating 46
- speakers 27
- specifications
 - information about 31
 - operating environment 56
 - power 54
- storing your computer 57
- support 23
- support and service 46
- System Preferences
 - customizing the desktop 16

- Energy Saver 20
- Keyboard 12
- Software Update 41, 46
- Startup Disk 37
- turning off IR reception 29
- System Profiler 47

T

- telephone support 49
- troubleshooting
 - AirPort problems 45
 - AppleCare 49
 - application problems 41
 - computer freezes 37
 - computer won't respond 36
 - computer won't turn on 37
 - date and time settings 41
 - force quit an application 36
 - Internet connection 42
 - PPPoE connections 44
 - resetting PRAM 37
 - service and support 46
 - using Mac Help 47
- turning on your Mac mini 14
- typing position 57

U

- updating software 46
- USB
 - connections 31
 - ports 27

V

verifying a disk 40
VGA display 13
video port 27

W

wireless
 AirPort Extreme 25
 Bluetooth technology 8, 25
 keyboard 12
 mouse 12
 networking 10

 Apple Inc.

© 2009 Apple Inc. All rights reserved.

Under the copyright laws, this manual may not be copied, in whole or in part, without the written consent of Apple.

The Apple logo is a trademark of Apple Inc., registered in the U.S. and other countries. Use of the “keyboard” Apple logo (Option-Shift-K) for commercial purposes without the prior written consent of Apple may constitute trademark infringement and unfair competition in violation of federal and state laws.

Every effort has been made to ensure that the information in this manual is accurate. Apple is not responsible for printing or clerical errors.

Apple

1 Infinite Loop
Cupertino, CA 95014
408-996-1010
www.apple.com

Apple, the Apple logo, AirPort, AirPort Extreme, FireWire, iPod, iTunes, Keynote, Mac, Mac OS, and QuickTime are trademarks of Apple Inc., registered in the U.S. and other countries.

Aperture, Apple Remote Desktop, Final Cut Studio, Finder, the FireWire logo, iPhone, and Logic Studio are trademarks of Apple Inc.

AppleCare and Apple Store are service marks of Apple Inc., registered in the U.S. and other countries.

ENERGY STAR® is a U.S. registered trademark.

The Bluetooth® word mark and logos are registered trademarks owned by Bluetooth SIG, Inc. and any use of such marks by Apple is under license.

Other company and product names mentioned herein may be trademarks of their respective companies. Mention of third-party products is for informational purposes only and constitutes neither an endorsement nor a recommendation. Apple assumes no responsibility with regard to the performance or use of these products.

Manufactured under license from Dolby Laboratories. “Dolby,” “Pro Logic,” and the double-D symbol are trademarks of Dolby Laboratories. Confidential Unpublished Works, © 1992–1997 Dolby Laboratories, Inc. All rights reserved.

The product described in this manual incorporates copyright protection technology that is protected by method claims of certain U.S. patents and other intellectual property rights owned by Macrovision Corporation and other rights owners. Use of this copyright protection technology must be authorized by Macrovision Corporation and is intended for home and other limited viewing uses only unless otherwise authorized by Macrovision Corporation. Reverse engineering or disassembly is prohibited.

Apparatus Claims of U.S. Patent Nos. 4,631,603, 4,577,216, 4,819,098 and 4,907,093 licensed for limited viewing uses only.

Simultaneously published in the United States and Canada.

