



TECHNICAL SUMMARY

XLED-PS-9 / XLED-PS-9-C

X-LED Power Supply

XLED-PS-9 / XED-PS-9-C



LUNA-RJ (X-LED version)



The MADRIX LUNA-RJ reliably distributes DMX512 data over long or short distances using Ethernet network or USB. Its sync mode makes sure that lighting effects look their best on the LEDs.

Art-Net / Streaming ACN / USB:

Art-Net or Streaming ACN data is directly converted to DMX512. Optimize and decentralize cabling to cover any distance to the device using Ethernet network. Any small or large project greatly benefits from dependable data distribution and efficient operation. Use any compatible software or hardware controller. In addition, simply connect to MADRIX 5 over USB.

3 DMX-OUT:

3 RJ45 ports (female) distribute the equal number of DMX universes per unit. Simply use several units at the same time for larger projects.

Sync Mode:

MADRIX 5 and MADRIX hardware allow you to synchronize Art-Net data for all output ports and even across multiple devices to get an optimal image on the LEDs without visual interruptions.

Easy Configuration:

MADRIX LUNA-RJ offers powerful features, especially in combination with MADRIX 5. Take full advantage of pixel mapping and voxel mapping. The installation of the device is still quick and easy.

3rd-Party Controllers:

MADRIX LUNA-RJ complies with the official protocol specifications and can be used as a regular node with your other consoles, controllers, or software solutions.

Quality Design:

They feature a fanless, noiseless, low-energy design, in our metal case. 4 indicators quickly show the status of a device.

Special Notes:

The device is ready within seconds after startup. HTP merging is automatically available for two Ethernet sources. Firmware is upgradable for future enhancements. Access and change the specific device settings using the built-in web configuration page.

Bandwidth:

As a receiving unit, the 100 MBit/s RJ45 Ethernet connection is more than enough. For large projects we recommend to use Art-Net and 1 GBit/s for the network switch and network card. For the sender of all the data, the higher bandwidth is required. Art-Net data is normally sent in broadcast mode where all receivers get all the data, however with MADRIX 5, we also support unicast with the Direct IP mode to just sent the required data to each single unit. In all cases, MADRIX LUNA provides the performance you need.

X-LED Power Supply

XLED-PS-9 / XED-PS-9-C

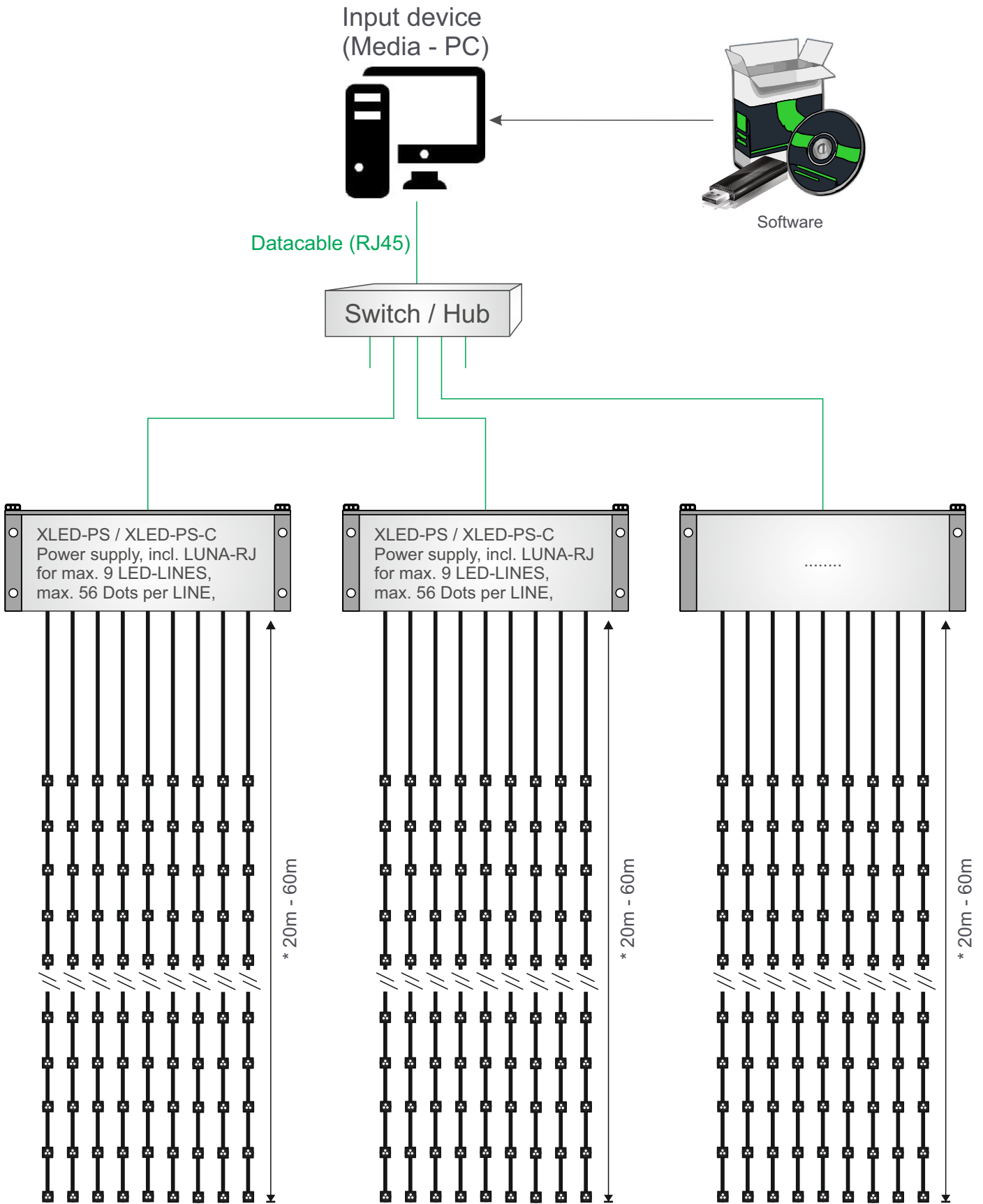

* LED Line configuration, please see X-LED LINE - Technical summary.

Stand-alone playback unit



Stand-Alone Playback:

Independently run the most sophisticated light shows from this energy-efficient playback unit via Art-Net or Streaming ACN. Easily control up to **8** or **32 universes** per device.

Live Recording:

Record any Art-Net or Streaming ACN network stream onto the inserted memory card. Unlike any other solution, recording a beautiful light show with MADRIX 5 is as easy as pressing record and play.

Central Hub:

Simply connect compatible MADRIX hardware interfaces or third-party nodes to provide the correct output for your lighting fixtures.

Time-Controlled Shows:

Run scenes automatically with the help of the internal clock as well as the available sunrise and sunset timers.

Master-Slave Synchronization & Scalability:

Manage large projects simply by connecting several units. The entire group is automatically synchronized across all DMX universes for flawless and uninterrupted playback.

Web Configuration:

Use the built-in web configuration page to access and change specific device settings, such as the important IP address, subnet mask, playlist settings, and much more.

Live Control:

Encased in a non-conductive design for DIN rails or wall mounting, 8 on-device buttons allow for quick playback and recording control. You can also directly adjust the overall speed and intensity.

Remote Control:

Trigger MADRIX AURA via HTTP commands and the built-in web server or use Art-Net/sACN. You can even add MADRIX ORION for interactive installations.

X-LED Power Supply

XLED-PS-9 / XED-PS-9-C

Stand-alone



Datacable (RJ45)

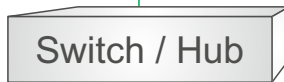

Stand-Alone Playback:
Independently run the most sophisticated light shows from this energy-efficient playback unit via Art-Net or Streaming ACN.
Easily control up to **8** or **32 universes** per device.

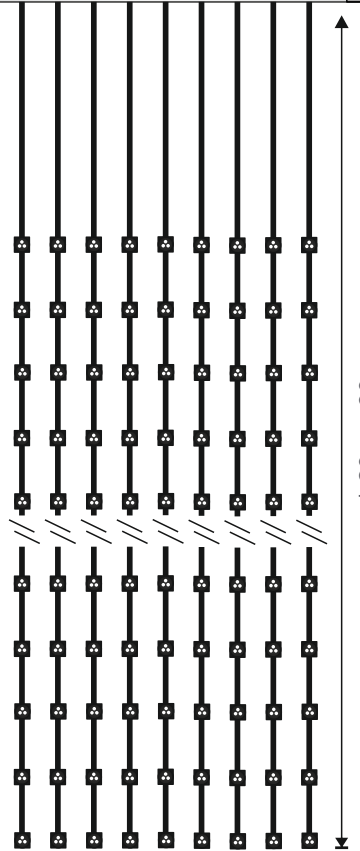
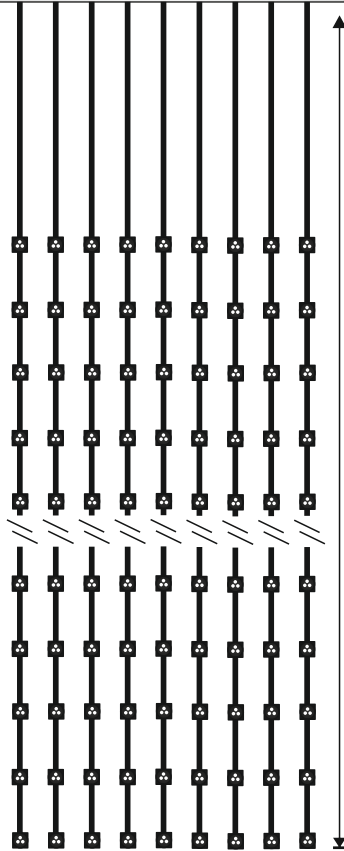
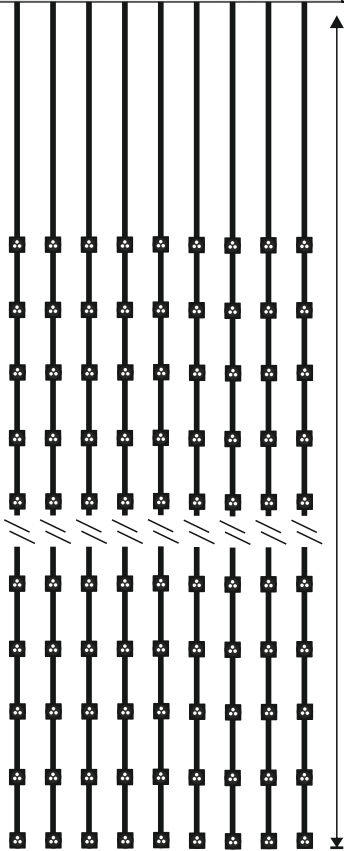
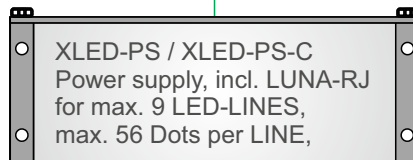
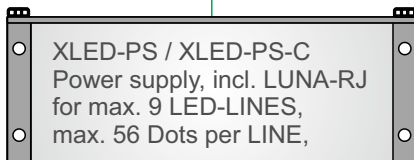

* LED Line configuration, please see X-LED LINE - Technical summary.

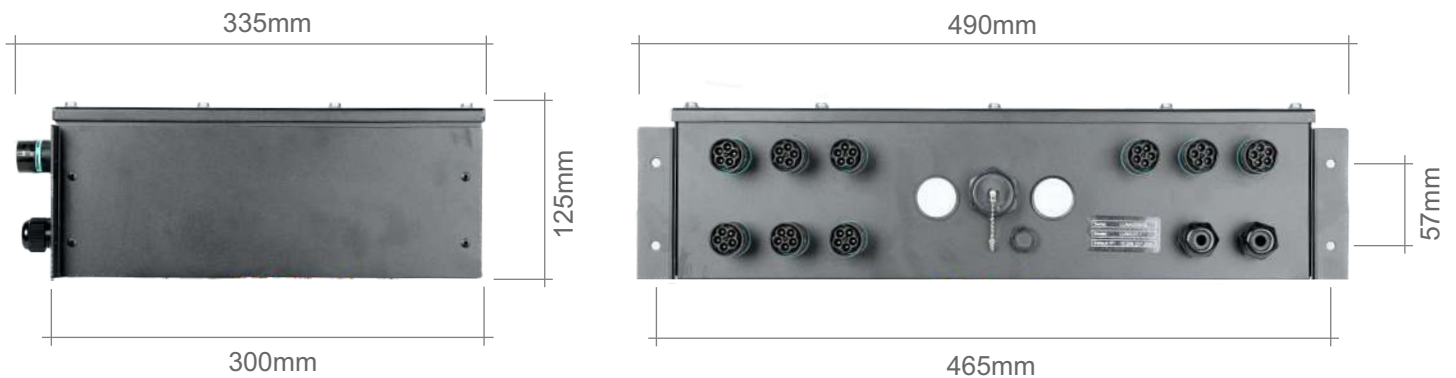

Connector groups	3 x 3 groups
Connector secondary	max. 56 Dots per group
Fuses	5 fuses (per DMX-splitter)
Voltage range	90 - 305 VAC (L/N/PE max. 4mm ²) 127 - 431 VDC (L/N/PE max. 4mm ²)
Rated power	3x 300 Watt
Rated current	3x 15 A
Frequency	50-60 Hz
PF	> 0,94
Voltage adj. range	17 VDC - 22 VDC (per DMX-splitter / Group)
Current adj. range	7.5 A - 15 A (per DMX-splitter / Group)
Inrush current	COLD START 3x 70 A at 230 VAC
Operating temperature	-20°C to +50°C
Protection level	IP65 - outdoor rated
Size	W: 490mm (465mm) D: 300mm H: 127mm
Network connection	Art-Net
Control	3 x DMX512A
Housing	Aluminum, black or grey powder coated
Operating features	Power In
Mounting options	Wall mounting, horizontal, vertical, L-profil



Electrification

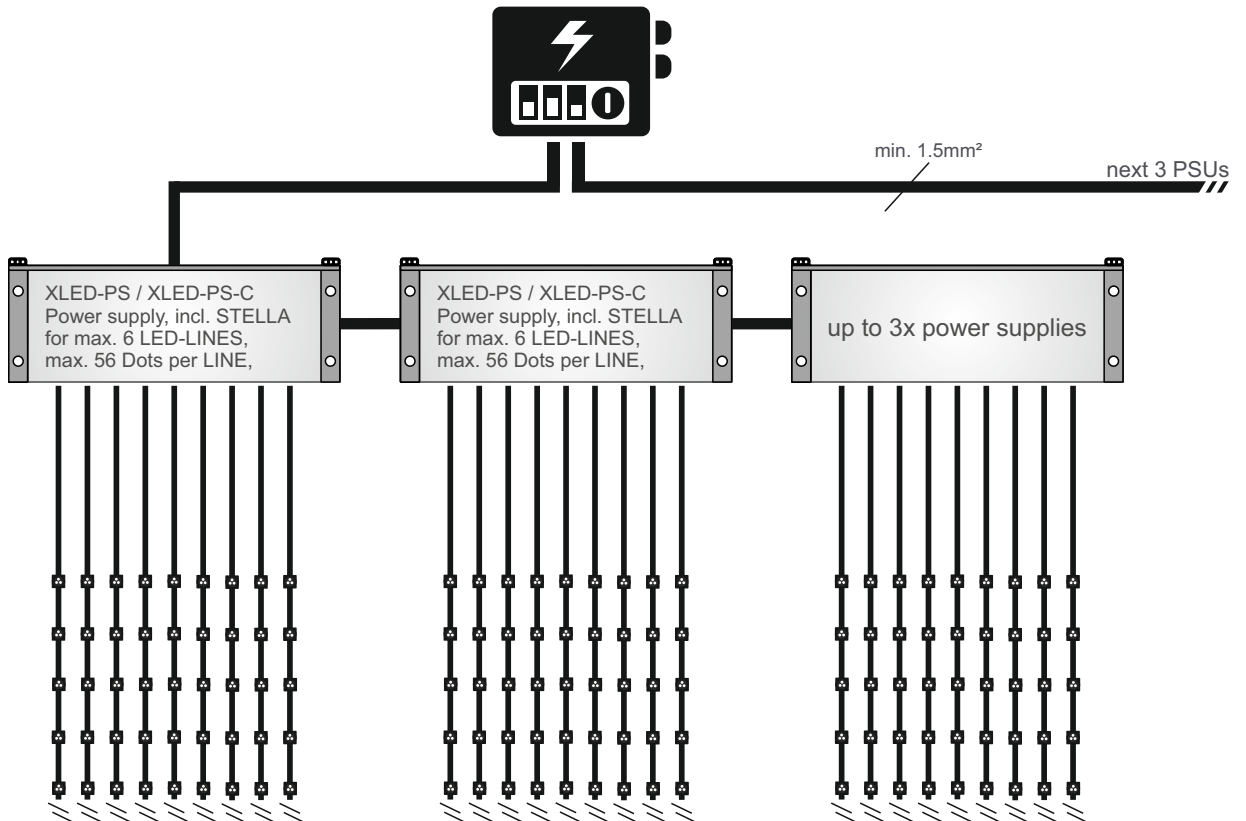
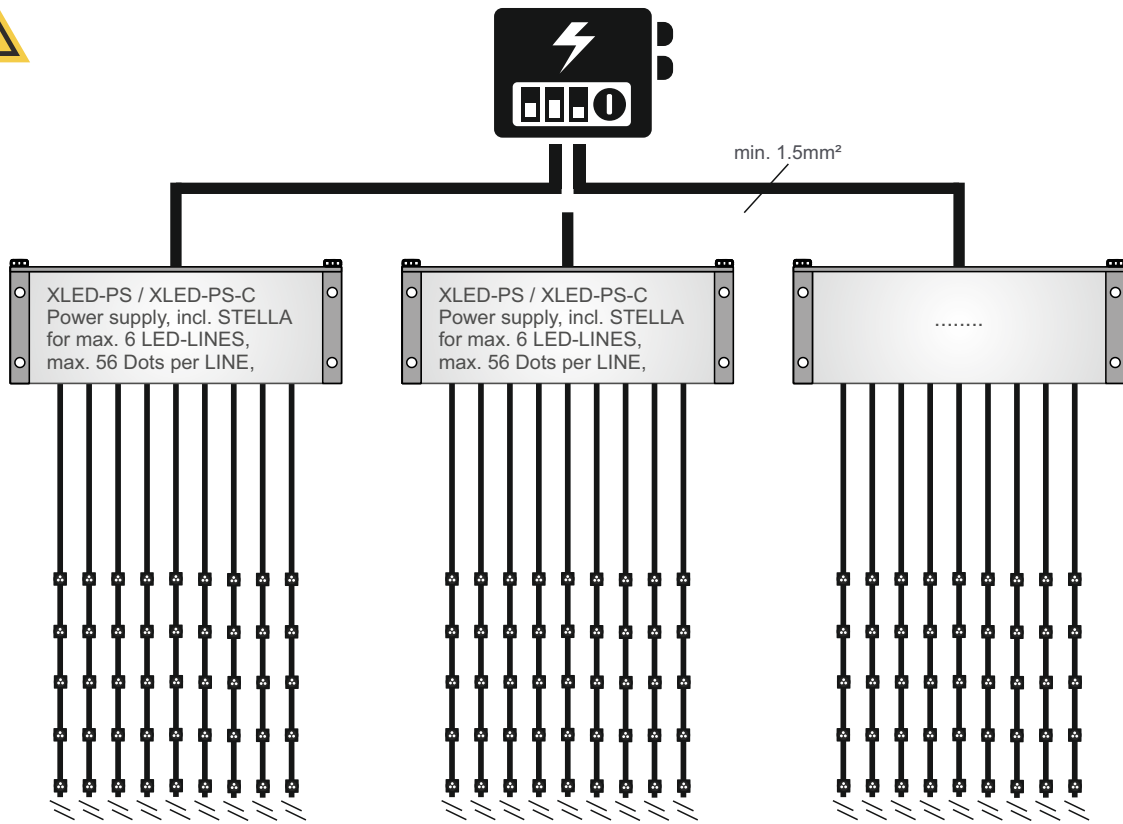

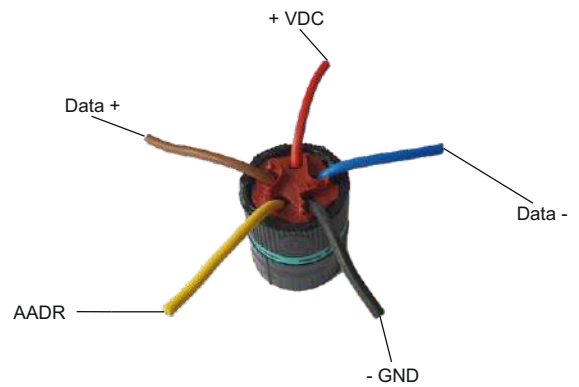
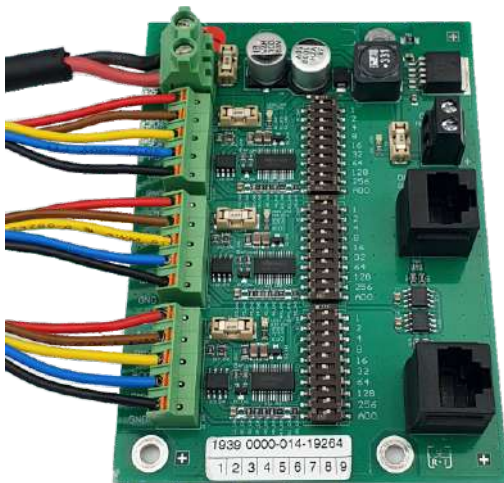
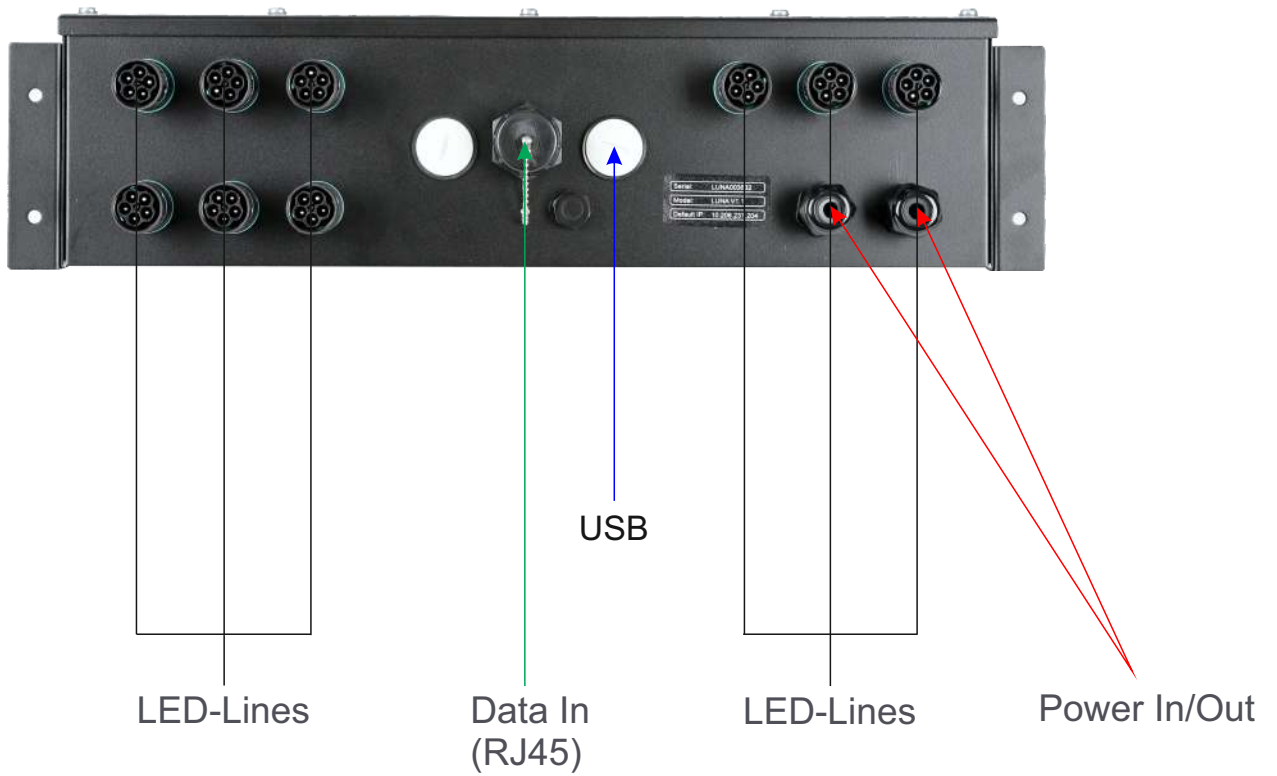

Wiring

- ① (+ marked in white) +12VDC
- ② Data +
- ③ AADR
- ④ Data -
- ⑤ GND

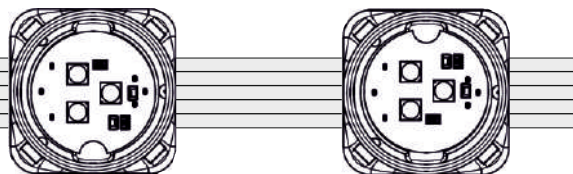

SERVICING AND MAINTENANCE

Clean device from dirt and residue regularly. Use solvent-free cleaning agents only and do not employ aggressive chemicals or high pressure , cleaner. Operate device only after complete drying.

CUSTOMER SERVICE



Please check all trouble-shooting measures given in this operating manual.
For any further questions please contact our hotline.

Tel: +49 (0) 7162/948 150 300 | Fax: +49 (0) 7162/948 150 305

MANUFACTURER



Carl Stahl ARC GmbH
Siemensstraße 2
D-73079 Süssen

x-led@carlstahl-arc.com
www.x-led.de

CONFORMITY

Our devices are certified according to the following European and American Standards

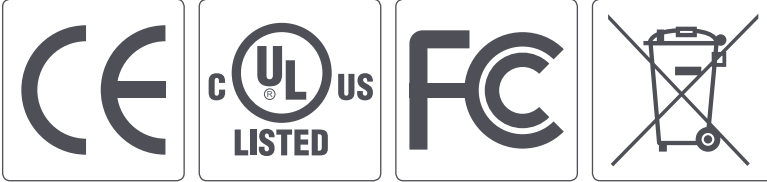

NOTE:

This equipment has been tested and found to comply with the limits for a class a digital device, pursuant to part 15 of the FCC rules. These limits are designed to provide reasonable protection against harmful interference when the equipment is operated in a commercial environment. This equipment generates, uses, and can radiate radio frequency energy and, if not installed and used in accordance with the instruction manual, may cause harmful interference to radio communications. Operation of these equipment in a residential area is likely to cause harmful interference in which case the user will be required to correct the interference at his own expense.

„This Class (A) digital apparatus complies with Canadian ICES-003”

COPYRIGHT:

©Carl Stahl ARC GmbH. All rights reserved.

Specifications are subject to change without notice.

No representation or warranty as to the accuracy or completeness of the information included herein is given and any liability for any action in reliance thereon is disclaimed.

All trademarks are owned by Carl Stahl ARC GmbH or their respective owners.

WARRANTY:

We provide for our LED-Dots (XLED-DOT-...-...), LED-Lines (XLED-LINE-...-...) and power supply units (XLED-PS-...-...) a warranty of 5 years.

Any other system related products (e.g. products from other manufacturers) are covered by their standard warranty.

Within the warranty period a failure rate of 3 % could occur. This failure rate is no claim for warranty.

Any visual changes due to UV, salt or other environmental impacts, which doesn't effect the functional behavior of the product, aren't covered in this warranty.

We advise to order a corresponding number of spare parts. For professional replacement we provide a training by our specialists.

Requirement for our warranty is the compliance with our installation and maintenance guidelines.

Due to side and application conditions problems can occur, which are not covered by the warranty, except they were named specifically by the client in advance. The installation has to be made by trained and skilled workers.

For all further conditions and claims our General Sales and Planning Terms are valid. They are available for Download on our website.

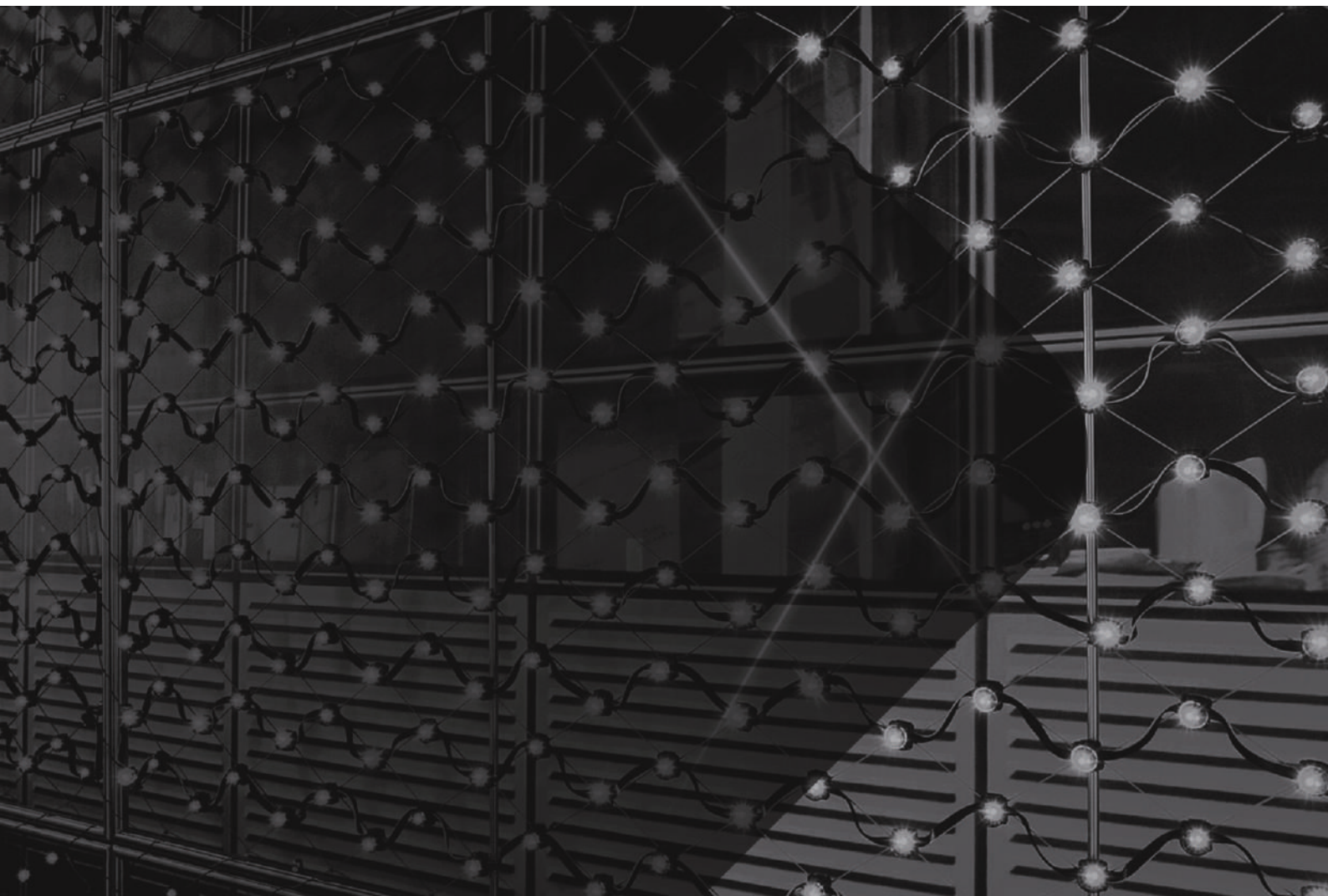

CARL STAHL ARC GMBH
Siemensstraße 2
D-73079 Süssen

Fon +49 (0) 7162 / 948 150 300
Fax +49 (0) 7162 / 948 150 305

x-led@carlstahl-arc.de
www.x-led.de