

# Energy Efficiency Indicators: Fundamentals on Statistics

*residential  
services  
industry  
transport*



# Energy Efficiency Indicators: Fundamentals on Statistics

Energy efficiency is high on the political agenda as governments seek to reduce wasteful energy consumption, strengthen energy security and cut greenhouse gas emissions. Referred to as the “hidden” or “first fuel,” improved efficiency seems an obvious policy choice since it usually pays back on the investment and is readily available. However, the lack of data for developing proper indicators to measure energy efficiency often prevents countries from transforming declarations into actions. Without data and indicators, it is also difficult to optimise energy efficiency policies and monitor progress and failures.

Inadequate expertise and know-how are often put forward to explain the lack of data and indicators. However, surveying, metering and modelling practices exist all around the world. Making these practices available to all is precisely the main objective of this manual, together with identifying the main sectoral indicators and the data needed to develop these indicators. To tackle policy challenges in the energy sector, statistics are essential.

This manual, together with its companion document, *Energy Efficiency Indicators: Essentials for Policy Making*, has been developed as a starting point towards enabling policy makers to understand where greater efficiency is needed, to implement appropriate policies and to measure their impact. The ultimate goal is to make improved energy efficiency not only a concept but a reality.

# Energy Efficiency Indicators: Fundamentals on Statistics

## INTERNATIONAL ENERGY AGENCY

The International Energy Agency (IEA), an autonomous agency, was established in November 1974. Its primary mandate was – and is – two-fold: to promote energy security amongst its member countries through collective response to physical disruptions in oil supply, and provide authoritative research and analysis on ways to ensure reliable, affordable and clean energy for its 29 member countries and beyond. The IEA carries out a comprehensive programme of energy co-operation among its member countries, each of which is obliged to hold oil stocks equivalent to 90 days of its net imports. The Agency's aims include the following objectives:

- Secure member countries' access to reliable and ample supplies of all forms of energy; in particular, through maintaining effective emergency response capabilities in case of oil supply disruptions.
- Promote sustainable energy policies that spur economic growth and environmental protection in a global context – particularly in terms of reducing greenhouse-gas emissions that contribute to climate change.
  - Improve transparency of international markets through collection and analysis of energy data.
    - Support global collaboration on energy technology to secure future energy supplies and mitigate their environmental impact, including through improved energy efficiency and development and deployment of low-carbon technologies.
    - Find solutions to global energy challenges through engagement and dialogue with non-member countries, industry, international organisations and other stakeholders.

IEA member countries:

Australia  
Austria  
Belgium  
Canada  
Czech Republic  
Denmark  
Estonia  
Finland  
France  
Germany  
Greece  
Hungary  
Ireland  
Italy  
Japan  
Korea (Republic of)  
Luxembourg  
Netherlands  
New Zealand  
Norway  
Poland  
Portugal  
Slovak Republic  
Spain  
Sweden  
Switzerland  
Turkey  
United Kingdom  
United States



© OECD/IEA, 2014

International Energy Agency  
9 rue de la Fédération  
75739 Paris Cedex 15, France

[www.iea.org](http://www.iea.org)

Please note that this publication is subject to specific restrictions that limit its use and distribution.

The terms and conditions are available online at <http://www.iea.org/termsandconditionsuseandcopyright/>

The European Commission also participates in the work of the IEA.



# Foreword

Energy efficiency is high on the political agenda. There are very few countries that have not set goals to be less energy-intensive, to consume less energy and to decrease their carbon dioxide emissions.

If the world wants to avoid a temperature increase of 5 or 6 degrees Celsius by the end of the century, then ambitious programmes of energy efficiency have to be launched in all sectors and in all countries. In the first edition of its *Energy Efficiency Market Report*, the International Energy Agency (IEA) rightly raises the status of energy efficiency from a hidden fuel to “our first fuel”. This is in line with analyses from the *World Energy Outlook* and the *Energy Technology Perspectives* reports, which both show that around 40% of tomorrow’s energy should in fact come from gains in energy efficiency.

However, actions do not always follow intentions, and despite the strong consensus behind energy efficiency, numbers show that the impact of energy efficiency on demand has fallen by half over the last 20 years compared with the previous 20 years.

There are several reasons that could explain the gap between declarations and actions, but one of the biggest reasons is the lack of proper data to build proper indicators. How many countries, for instance, know how much energy households use for appliances, how much offices use for heating or trucks for transporting goods? And it is not only the energy consumption that they do not know, but it is also the corresponding activity data (number of appliances, floor area or tonne-kilometres) which are not known.

With no data there are no indicators, and with no indicators there is an obvious difficulty, if not an impossibility, in making a robust assessment of a situation. Thus, this shortfall of information leads to difficulties for optimising measures and policies, and for closely monitoring progress and failures.

Inadequate resources, expertise, know-how and practices are often put forward to explain the lack of data and indicators. However, surveying, metering and modelling practices exist all around the world. It is just a matter of taking the time to look at these practices and to make them available to all.

This is exactly the purpose of this manual. After identifying the most common indicators, the manual provides more than 160 practices used all around the world for collecting the data needed to build these indicators.

The practices encompass the main methodologies used for collecting data: sharing experiences and establishing contacts and links among users and countries are the two underlying objectives of the manual.

In 2005, the IEA together with Eurostat launched its *Energy Statistics Manual*. This turned out to be a major success with tens of thousands of copies disseminated all around the world in ten different languages. It is my sincere hope that this manual will enjoy the same success. If thousands of statisticians, analysts and policy makers read and use this manual, this will translate into more and better data, robust indicators, and optimised policies and actions, and at the end of the day, in massive energy efficiency gains across all sectors and all countries.

The manual is complemented by a companion document *Energy Efficiency Indicators: Essentials for Policy Making*. While the *Energy Efficiency Indicators: Fundamentals on Statistics* focuses on what data to use and how to collect them, the other report is aimed at providing energy analysts and policy makers with tools needed to determine the priority areas for the development of indicators and how to select and develop the data and indicators that will best support energy efficiency policy.

The challenge to reduce energy consumption is enormous and challenging. It can be tackled only if we all act together and if we share practices and experiences. This is why I am particularly appreciative to all those who have kindly agreed to share their practices. A great start for more co-operation.

People often say that everything starts with statistics. Let's hope that this statistics manual will constitute a starting point towards making energy efficiency not only a concept but a reality.

This report is published under my authority as Executive Director of the IEA.

**Maria van der Hoeven**

Executive Director  
International Energy Agency

# Acknowledgements

This Manual was prepared by the Energy Data Centre of the International Energy Agency in co-operation with the IEA Energy Technology Policy Division.

The manual was designed and directed by **Jean-Yves Garnier**, Head of the Energy Data Centre. **Roberta Quadrelli** was responsible for the overall management and for bringing the manual to completion. **Anna Zyzniewski** largely contributed to the initial development of the manual especially in organising the survey on good and best practices. **Taejin Park** was instrumental in the finalisation phase of the manual.

Although it is difficult to list all those who have contributed to the publication, special acknowledgments go to **Paolo Canfora**, **Davide d'Ambrosio**, **Mieke Reece** and **Robert Schnapp** from the Energy Data Centre, and **François Cuenot**, **Emer Dennehy**, **Jean-François Gagné**, **Cecilia Tam** and **Nathalie Trudeau** from the Energy Technology Policy Division; **Robert Tromop** from the Energy Efficiency and Environment Division; and **Mario Barreto** from the International Transport Forum.

At its early stage and all along its development, the manual benefitted from the support and guidance from the ODYSSE-MURE network, especially from **Didier Bosseboeuf** and **Bruno Lapillonne**.

Special thanks are given to **Sharon Burghgraeve** for the enormous amount of work and patience she dedicated to formatting, reformatting and re-reformatting the document; to **Erin Crum** and **Cheryl Haines** for their sharp eyes in the final editing; and to the IEA Communication and Information Office, especially **Muriel Custodio**, **Rebecca Gagen**, and **Bertrand Sadin** for bringing the document to life.

The IEA Secretariat would also like to acknowledge the indirect contribution of all the participants in the three workshops which paved the way to the preparation of the manual as well as of all the people in administrations, organisations and companies who sent us comments and examples of the practices they use in collecting statistics for building energy efficiency indicators for any specific sector. Without their invaluable support, the *Energy Efficiency Indicators: Fundamentals on Statistics* manual could not be put together.



# Table of Contents

## 1 Introduction

1. Why a manual? .....13
2. Overall concept of the manual.....14
3. The Annex on collection of practices.....14
4. A more general use of the manual.....15

## 2 What are Energy Efficiency Indicators?

1. Indicators.....17
2. Energy efficiency .....17
3. Energy efficiency indicators.....18
4. And then, what to do with the indicators.....19

## 3 How to Collect the Data for Energy Efficiency Indicators?

1. Two basic principles.....21
2. What sectors and end uses to consider.....22
3. How to collect data? .....28

## 4 Collecting What and How for the Residential Sector

1. What does the residential sector mean and cover? .....35
2. Why is the residential sector important? .....38
3. What are the main end uses driving consumption of the sector? ..... 40
4. What are the most frequently used indicators? .....44
5. The data behind the indicators.....52
6. How to collect data? ..... 57

## 5 Collecting What and How for the Services Sector

1. What does the services sector mean and cover?.....69
2. Why is the services sector important?.....70
3. What are the main end uses driving consumption of the sector? ..... 73



4. What are the most frequently used indicators?.....	75
5. The data behind the indicators.....	81
6. How to collect data?.....	86

## **6 Collecting What and How for the Industry Sector**

1. What does the industry sector mean and cover? .....	97
2. Why is the industry sector important? .....	98
3. What are the main sub-sectors driving industry consumption?.....	101
4. What are the most frequently used indicators?.....	105
5. The data behind the indicators.....	108
6. How to collect data?.....	112

## **7 Collecting What and How for the Transport Sector**

1. What does the transport sector mean and cover? .....	123
2. Why is the transport sector important?.....	125
3. What are the main sub-sectors and modes driving transport consumption? .....	128
4. What are the most frequently used indicators?.....	133
5. The data behind the indicators.....	138
6. How to collect data?.....	143

## **8 Validating the Data**

1. Why is data validation important?.....	157
2. What are the main data validation criteria? .....	157
3. How should data be validated for each end-use sector? .....	159

## **9 Disseminating the Data**

1. Why is dissemination important? .....	169
2. What are the basic principles to follow? .....	170
3. What means of dissemination should be used? .....	171
4. Selected examples of dissemination practices .....	172



## Annexes

Annex A	
Abbreviations, acronyms and units of measure.....	185
Annex B	
Definitions of sectors.....	187
Annex C	
Temperature correction and heating degree days.....	189
Annex D	
Collection of country practices.....	191
Annex E	
References.....	381
Annex F	
Country notes .....	383

# List of figures .....

Figure 3.1	Breakdown of total final consumption by sector for two hypothetical countries.....	21
Figure 3.2	Breakdown of industry and transport energy consumption by sub-sector for two hypothetical countries .....	22
Figure 3.3	Shares of sectors in total final consumption for the world (1973 and 2011) .....	24
Figure 3.4	Schematic disaggregation of total final consumption into sectors and sub-sectors or end uses.....	25
Figure 3.5	Schematic representation of the IEA energy indicators pyramid .....	26
Figure 3.6	Trade-off between survey and census .....	30
Figure 3.7	Schematics of a transport model: Sources, output and validation ....	34
Figure 4.1	Share of the residential sector in the world total final consumption for selected energy sources (2011) .....	37
Figure 4.2	Share of the residential sector in the world total final consumption of selected countries (2011) .....	38
Figure 4.3	Share of various energy sources in the world residential energy consumption .....	39
Figure 4.4	Breakdown of residential consumption by end use in 2010 for 20 selected OECD countries .....	42
Figure 4.5	Pyramid of residential indicators.....	45
Figure 4.6	Pyramid of residential space heating indicators .....	46
Figure 4.7	Pyramid of residential space cooling indicators .....	47
Figure 4.8	Pyramid of residential water heating indicators .....	48
Figure 4.9	Pyramid of residential lighting indicators.....	49
Figure 4.10	Pyramid of residential cooking indicators .....	49
Figure 4.11	Pyramid of residential appliances indicators.....	50
Figure 4.12	Aggregated flow chart of the energy consumption data needed for energy efficiency indicators for residential.....	53
Figure 4.13	Aggregated flow chart of the main activity data needed for energy efficiency indicators for residential.....	55
Figure 5.1	Share of the services sector in the total final consumption of selected countries (2011) .....	71
Figure 5.2	Share of the services sector in the world total final consumption for selected energy sources (2011) .....	72
Figure 5.3	Share of various energy sources in the world services energy consumption .....	73
Figure 5.4	Breakdown of the services consumption by end use for a selection of five OECD countries .....	74
Figure 5.5	Pyramid of services indicators .....	76
Figure 5.6	Pyramid of services space heating indicators.....	77
Figure 5.7	Pyramid of services space cooling indicators .....	78
Figure 5.8	Pyramid of services water heating indicators .....	79
Figure 5.9	Pyramid of services lighting indicators.....	80
Figure 5.10	Pyramid of services other equipment indicators .....	81
Figure 5.11	Aggregated flow chart of the energy consumption data needed for energy efficiency indicators for services.....	83
Figure 5.12	Aggregated flow chart of the main activity data needed for energy efficiency indicators for services.....	85

Figure 6.1	Share of the industry sector in the world total final consumption of selected countries (2011) .....	99
Figure 6.2	Shares of various energy sources in the world total industry sector consumption .....	100
Figure 6.3	Share of the industry sector in the world total final consumption for selected energy sources (2011) .....	100
Figure 6.4	Breakdown of the 2011 industry consumption by sub-sector for the world and OECD .....	101
Figure 6.5	Pyramid of industry indicators .....	106
Figure 6.6	Pyramid of industry sub-sectors indicators .....	109
Figure 6.7	Aggregated flow chart of the energy consumption data needed for energy efficiency indicators for industry .....	109
Figure 6.8	Aggregated flow chart of the main activity data needed for energy efficiency indicators for industry .....	110
Figure 7.1	Share of the transport sector in the total final consumption of selected countries (2011) .....	126
Figure 7.2	Share of the transport sector in the world total final consumption for selected energy sources (2011) .....	127
Figure 7.3	Share of the various sources in the world transport energy consumption .....	128
Figure 7.4	Energy consumption by sub-sector for the world total transport consumption .....	131
Figure 7.5	Energy consumption by sub-sector and mode/vehicle type for passenger transport and freight transport (for a total of 23 OECD countries, 2010) .....	132
Figure 7.6	Energy consumption by energy source for passenger transport and freight transport (for a total of 23 OECD countries, 2010). ....	132
Figure 7.7	Pyramid of transport indicators .....	134
Figure 7.8	Pyramid of passenger transport indicators .....	135
Figure 7.9	Pyramid of freight transport indicators .....	136
Figure 7.10	Aggregated flow chart of the energy consumption data needed for energy efficiency indicators for transport .....	139
Figure 7.11	Aggregated flow chart of the main activity data needed for energy efficiency indicators for transport .....	140
Figure 7.12	Schematics of a transport model .....	154
Figure 8.1	Energy consumption for an industry sub-sector of a country, based on the energy balance submission to the IEA and on the energy efficiency submission .....	159
Figure 8.2	Share of space heating in the residential sector energy consumption for 20 selected OECD countries in 2010 .....	161
Figure 8.3	Share of total appliances within the residential energy consumption for 20 selected OECD countries in 2010 .....	161
Figure 8.4	Ranges of intensities per value added for selected industrial sub-sectors for 23 OECD countries in 2010 (based on constant 2005 USD at purchasing power parity) .....	165
Figure 8.5	Ranges of intensities per unit of physical output for selected industrial sub-sectors for 15, 24 and 11 OECD countries in 2010 .....	165
Figure 8.6	Ranges of reported energy consumption per pkm and tkm for passenger and freight transport, for 20 selected OECD countries .....	168
Figure D.1	How to read a practice template .....	191

## List of tables .....

Table 3.1	Pros and cons of using administrative data sources .....	29
Table 3.2	Pros and cons of using surveying.....	31
Table 3.3	Pros and cons of using measuring.....	32
Table 3.4	Pros and cons of using modelling.....	33
Table 4.1	Summary list of the most common indicators for the residential sector .....	51
Table 4.2	Summary of the main data needed for residential indicators and examples of possible sources and methodologies.....	58
Table 5.1	Examples of categories within the services sector and respective units of activity.....	76
Table 5.2	Summary list of the most common indicators for services.....	82
Table 5.3	Summary of the main variables needed for services indicators and examples of possible sources and methodologies.....	87
Table 6.1	Examples of typical processes or product types for selected industry sub-sectors .....	104
Table 6.2	Summary list of the most common indicators for industry sector data.....	108
Table 6.3	Summary of variables needed for industry indicators and examples of possible sources and methodologies.....	112
Table 7.1	Selected modes/vehicle types by segment and sub-sector .....	129
Table 7.2	Summary list of the most common indicators for transport.....	138
Table 7.3	Summary of the main data needed for transport indicators and examples of possible sources and methodologies.....	144
Table 7.4	Schematic description of selected road data collection methodologies .....	155
Table 8.1	Observed ranges of average UEC for selected appliances for a selection of 14 OECD countries .....	162
Table 8.2	Ranges of reported load and distance travelled per year for a group of 20 OECD countries in 2010.....	167
Table B.1	Correspondence of sectors to ISIC Revision 4.....	187

## List of boxes .....

Box 2.1	“Take the stairs – be more efficient” .....	18
Box 2.2	Is energy intensity an energy efficiency indicator?.....	19
Box 3.1	What is an energy balance?.....	23
Box 3.2	The IEA collection of data for energy efficiency indicators .....	27
Box 5.1	Selected international sources for the building sector.....	88
Box 5.2	Selected international sources for macroeconomic data.....	89
Box 6.1	Selected international sources for industry data .....	114
Box 6.2	Industry benchmarking .....	120
Box 7.1	Calculations of transport activity data .....	141
Box 7.2	Selected international sources for transport data .....	147
Box 7.3	A transport modelling example: The IEA Mobility Model (MoMo) ...	154
Box 7.4	Focus on road: Summary of key data collection methodologies.....	155
Box 9.1	Messages should be short but clear .....	171
Box C.1	Possible sources for weather data .....	190



## 1 Why a manual?

In 2005, the International Energy Agency (IEA) in co-operation with Eurostat launched its *Energy Statistics Manual* for helping statisticians to better understand the fundamentals of energy statistics and to facilitate the preparation of annual energy questionnaires. In fact, the manual was an answer to several issues, including the fast turnover of staff in offices and ministries in charge of energy statistics and the need to quickly bring up to speed newcomers in the field.

The success of the manual went way beyond the initial expectation, and tens of thousands of copies of the manual in ten languages were disseminated all around the world. This certainly actively contributed to an improvement in the quality of energy statistics worldwide.

Four years later, at the 2009 IEA Ministerial Meeting, ministers agreed to launch a new annual questionnaire dedicated to statistics needed to develop energy efficiency indicators. Since then, the IEA has collected energy efficiency statistics from member countries of the Organisation for Economic Co-operation and Development (OECD) on an annual basis. The data are then used for developing indicators and for feeding analyses, such as in the annual *Energy Efficiency Market Report* that the IEA launched in 2013.

The quality and the coverage of the questionnaires received by the IEA are improving over the years; however, there is a growing request from statisticians and analysts in the countries for guidance on what data to collect for what indicators, and more importantly on how to best collect these data.

As a follow-up to this request, the IEA embarked on a global survey to collect a maximum number of good and best practices on how countries are collecting statistics to develop indicators. The participation of countries and organisations was massive; this led to a library of more than 200 interesting practices covering surveys, metering or modelling on the residential, services, industry and transport sectors in all parts of the world.

The spontaneous participation and the encouragement of countries were decisive elements prompting the IEA to start working on a manual on statistics for energy efficiency indicators. However, in the same line as for the *Energy Statistics Manual*, the IEA wanted to make this new manual as useful and as user-friendly as possible. In other words, there was no rush, but a priority was a good understanding of the needs of potential users before moving on to the preparation of a document that would meet these needs. This is why the IEA convened two workshops in order to get a better feel for the expectations of potential users.

Therefore, regarding the question, “Why a manual?” there is not one answer but several: a strong request from countries; an absence of any other manuals covering this specific topic; a need for guidance for collecting proper data; a vehicle to share and learn practices; and a link between people who already have experience and people who are looking to gain it.

## **2** Overall concept of the manual

In line with both the *Energy Statistics Manual* approach and the search for simplicity, the manual is written in a question-and-answer format. The points developed are introduced with basic questions, such as “What does the residential sector mean and cover?”; “What are the main end uses driving consumption of the sector?”; “What are the most frequently used indicators?”; and “What means of dissemination should be used?”

Answers are given in simple terms and are illustrated by graphs, charts and tables.

The manual contains nine chapters. After a short introduction, the second chapter explains what energy efficiency indicators are and the third one gives general principles related to the collection of data for indicators. The next four chapters each deal with one specific sector (residential, services, industry and transport). The next chapter addresses validation of data and the last chapter discusses the importance of a good dissemination mechanism for data and indicators. Several annexes are also included.

For the four chapters dedicated to the sectors, the structure is identical: they start with the definition and the importance of the sector, then continue with main sectoral end uses and associated indicators, and end with an extensive description of the corresponding data and the mechanisms used for collecting those data.

## **3** The Annex on collection of practices

If the value of the manual lies in the definition of the main energy efficiency indicators for each sector and the corresponding data, additional benefit come in the practices used by countries for collecting those data. The practices are summarised in the sectoral chapters but are detailed one by one in the Annex D on data collection practices. In fact, Annex D represents half of the overall manual in terms of pages; this shows the importance of these practices.

Each practice is presented using a single unified format, which should allow the readers to easily understand the template and to make comparisons between practices. They are presented by sector (residential, services, industry and transport) and by methodology of collection (administrative sources, surveys, metering and modelling).

Each practice contains a short background (name, country, purpose), detailed information on the data collected, the frequency and the people in charge, and ends with notes and comments on challenges, areas for improvement, and, when available, a list of associated documents accessible for further information.

Practices were collected through an extensive consultation with countries, both OECD and non-OECD. The different levels of detail and data disaggregation among practices reflect the different development of data collection for energy efficiency indicators across countries.

## **4** A more general use of the manual

The manual is primarily intended for people in charge of collecting statistics to develop energy efficiency indicators; by the same token it is also intended for analysts developing these indicators.

In fact, by avoiding technical jargon as much as possible and by keeping the text and structure as simple as possible, the manual could and should also be used by many other interested individuals (academia, policy makers, etc.) to get a first introduction on what is needed to build energy efficiency indicators.

It is the aim of the IEA for the manual to facilitate the understanding of the basic data needs to develop meaningful indicators, and more importantly of how other countries have managed to collect this information. We also hope that the manual will whet the appetite of many to embark on energy efficiency indicators programmes designed to optimise actions and policies for reducing consumption.

We are aware that this manual will not provide answers to all questions. This is why your comments are welcome, so that we can, in a future edition or in an electronic edition, further improve the content and complement it by addressing the most frequent questions. Comments and suggestions can be sent to the IEA at the following email address: [energyindicators@iea.org](mailto:energyindicators@iea.org).



# What Are Energy Efficiency Indicators?

## 1 Indicators

An English dictionary defines “indicator” in many ways, depending on if it is related to engineering, chemistry, life or sciences. In very simple words, one could say that an indicator is something that provides an indication; in a little more sophisticated terms, an indicator could be any of various statistical values that together provide an indication.

This leads to a debate among experts, because some will consider an absolute value to be an indicator, while others will think that only ratios or other compound values could classify as indicators.

In this manual, even if most of the time indicators will refer to ratios (energy consumption per tonne of cement, for instance), some of the most aggregated indicators could also be absolute values. For instance, the overall energy consumption of the residential sector is such an indicator; if the number is big, this would indicate that the consumption is large and therefore there is a need to carefully look at the importance of this sector compared, for example, with the services sector, which may have consumption in absolute terms 20 times lower than the residential one.

Indicators can then be expressed in energy units (consumption of a sector or of an end use) as well as in ratio terms (litres per 100 kilometres, kilowatt hours [kWh] per tonne of paper). They could also be expressed in percentage: share of the industry sector in total energy consumption, percentage of houses having access to electricity.

## 2 Energy efficiency

The second term to define in the overall concept of energy efficiency indicators is the term “energy efficiency”. Though the expression is intuitive, writing a clear definition is extremely complex.

In fact, it is often easier to define more (or less) energy efficient than energy efficiency itself. For instance, something is more energy efficient if it delivers more services for the same energy input, or the same services for less energy input. For example, when a compact fluorescent light bulb (CFL) uses less energy than an incandescent bulb to produce the same amount of light, the CFL is considered to be more energy efficient.

People can define energy efficiency using one of two perspectives: a service perspective or a mechanistic perspective. This is best illustrated in Box 2.1, taken from the US Energy Information Administration (EIA).

Although a precise definition for energy efficiency is not fundamental for working on energy efficiency indicators and for the rest of the manual, what is provided by the Lawrence Berkeley National Laboratory seems to be an accepted definition: energy efficiency is “using less energy to provide the same service”.



### Box 2.1 • “Take the stairs – be more efficient”

Person A interprets the sign as the “true” definition of energy efficiency. To Person A, the elevator is not being used. They are still getting to where they want to go and are using less energy in doing so.

Person B considers the fact that they are not getting to where they are going with the same ease. They do not believe that they are being energy efficient, but instead they believe that they are “conserving energy” at a reduced level of service – they have to walk instead of ride.

When it comes to trying to define “to be energy efficient” or “energy efficiency”, there does not seem to be a single commonly accepted definition of energy efficiency. Along the lines of Person B’s thinking, it is generally thought that an increase in energy efficiency is when either energy inputs are reduced for a given level of service, or there are increased or enhanced services for a given amount of energy inputs.

## 3 Energy efficiency indicators

Strangely enough, with the difficulties encountered in properly defining the terms “indicator” and “energy efficiency”, there are fewer problems in defining the concept of energy efficiency indicators. They are, in general, indicators that will help demonstrate if one thing is more energy efficient than another.

For instance, is this car more energy efficient than that one in terms of fuel use per 100 kilometres? Is the energy heating consumption per floor area of the residential sector lower or higher this year than last year, or ten years ago? Is the energy consumption per tonne of cement lower or higher in country A compared with country B?

Energy efficiency indicators can be very aggregated (for instance, total appliances energy consumption per appliance) or disaggregated (for instance, average heating consumption per floor area of single houses using natural gas for heating). They are usually composed of an energy consumption as numerator and an activity data as denominator. There are some exceptions, such as the “energy” consumption of cars, which can be expressed in volume (litres, gallons) and not converted into energy units.

Energy consumption can be expressed in various units (kWh, joule, tonnes of oil equivalent, etc.), while activity data cover a wide range of activities: production of cement, floor area, passenger-kilometres, employees, etc., expressed in as many units as activities (tonnes, square metres, kilometres, number of employees, etc.).

This introductory chapter will not go into more details regarding these definitions since each sectoral chapter will explain, using a pyramidal approach, what indicators are considered for each particular sector and why they are considered.

### Box 2.2 • Is energy intensity an energy efficiency indicator?

Energy intensity of a country is often used as an energy efficiency indicator for that country. There are reasons for that, the main reason being that intensity is easily available since it is the ratio of the total primary energy supply (TPES) divided by the gross domestic product (GDP) of the country.

As a consequence, since TPES and GDP are numbers that are readily available for any country, the energy intensity is often used as a proxy for energy efficiency. This is a mistake, however, since a given country with a low energy intensity does not necessarily have high efficiency. For instance, a small service-based country with a mild climate would certainly have a much lower intensity than a large industry-based country in a very cold climate, even if energy is more efficiently consumed in this country than in the first.

Efficiency is a contributing factor in intensity, but many other elements – often more significant – also need to be considered. These include: the structure of the economy (presence of large energy-consuming industries, for instance); the size of the country (higher demand from the transport sector); the climate (higher demand for heating or cooling); and the exchange rate.

## 4 And then, what to do with the indicators?

Collecting data and developing indicators should not be seen as an end in itself but more as a beginning for further use. As mentioned earlier, data should be collected and indicators developed only if they can be used widely and efficiently.

Though this manual includes a chapter on dissemination, it does not address the development and the use of indicators by analysts and policy makers to set energy efficiency targets and track their progress. This is the purpose of a companion manual, namely the *Energy Efficiency Indicators: Essentials for Policy Making*, also prepared by the IEA. The two manuals complement each other and should constitute the basis for all statisticians, analysts and policy makers in their work towards sound energy efficiency policies and actions.



# How to Collect Data for Energy Efficiency Indicators?

## 1 Two basic principles

In statistics, there is a **general principle**: do not collect statistics for the sake of collecting statistics; collect only what is necessary. Indeed, collecting any statistics has a cost.

However, not having proper data could lead to wrong policy decisions and actions, and, as a consequence, to even higher costs. So, once again, limit collecting to what is needed, but collect it.

The immediate underlying question is then: what are the needs? There is not one unique answer to this question since the needs depend on the situation of the given country. This is true for any type of statistic, and especially for energy statistics. However this is even more important for statistics on energy efficiency indicators, because the cost of collecting energy and activity data at a very detailed level might be high.

One of the possible starting points to identify priorities is the breakdown of final energy consumption by sector. Usually this information can be easily extracted from the energy balance of a country. Figure 3.1 provides two examples (Countries A and B) of a different energy consumption breakdown.

**Figure 3.1** • Breakdown of total final consumption by sector for two hypothetical countries

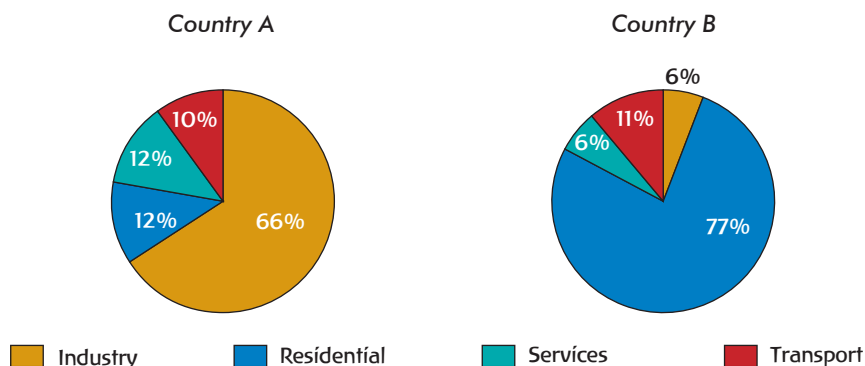

In the case of Country A, two-thirds of final consumption is in the industry sector. Therefore it seems apparent that the first sector to look at for energy savings is industry. In the case of Country B, the residential sector appears to be the priority sector to consider for potential energy savings. However, even if the use of the breakdown gives a first indication for prioritising the work on data collection, there could be other specificities to consider before starting data collection.

The more detailed the data available, the better it is, since it narrows down the search for data to sub-sectors instead of sector level. As above, an energy balance (if disaggregated at the sub-sector level) can help determine which sub-sectors should get priority. Figure 3.2 gives two examples of such breakdown for Countries C and D.

**Figure 3.2 • Breakdown of industry and transport energy consumption by sub-sector for two hypothetical countries**

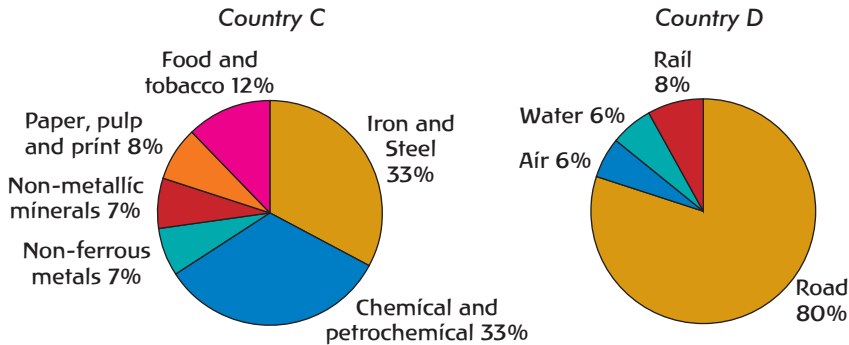

In the case of Country C, the iron and steel and chemical and petrochemical sub-sectors each account for a third of the overall industry consumption, so it is likely that these two sub-sectors should be the first to be assessed for potential energy savings – bearing in mind of course that country specific priorities need to be considered. In the case of Country D, road transport makes up the largest part of transport consumption, so this sub-sector should be considered a priority.

The **second principle** is to identify which data already exist before embarking on a costly collection programme. By experience, there is often a wealth of information in unfamiliar places. This is for example the case for detailed activity transport data (passenger-kilometres), which are often unknown to people working on energy statistics but which are available from the ministry of transport. This will be addressed further in the text, in the section on how to collect data.

Once data needs are established, a further assessment will evaluate what resources are needed, including human resources, the overall costs of data collection, and potential barriers that may prevent or delay the success of the project. A number of questions will need to be addressed. Will the project involve collection of new data? If so, what data will need to be collected? How often? Will the existing data being easily accessible? Who will be in charge of the data collection? Will the work be carried out by internal staff or with the help of external consultants?

## 2 What sectors and end uses to consider?

As mentioned above, in order to limit costs, the development of energy efficiency indicators should target priority sectors and end uses. Therefore, it is recommended to make an initial assessment based on the available information on energy consumption patterns in the country and the type of policy questions that need to be answered.

### Box 3.1 • What is an energy balance?

An energy balance is a framework to compile data on all energy products entering, exiting and used within a given country during a reference period (e.g. a year). An energy balance expresses all data in a common energy unit, which makes it possible to define a “total” product.

The purposes of compiling an energy balance starting from the various commodity balances are numerous; they are to: 1) provide a comprehensive overview of the energy profile of a country, to monitor energy security, energy markets, relevant policy goals and to formulate adequate energy policies; 2) provide the basis for aggregate socio-economic indicators, as well as for estimates of CO<sub>2</sub> emissions; 3) compare different reference periods and different countries; 4) provide a tool to ensure completeness, consistency and comparability of basic statistics; 5) calculate efficiencies of transformation processes, as well as relative shares of different sectors or products in the country’s total supply or consumption.

An energy balance generally takes the form of a matrix of products and flows, with varying levels of disaggregation, although graphical formats also exist (e.g. Sankey diagram). For a methodological discussion on how to compute energy balances, please refer to IEA (2005).

Within a balance, the total final consumption is disaggregated into sectors, like industry, transport, residential, services and others. However, the level of disaggregation of such energy data is not enough to monitor energy efficiency, as no information is given for example on the residential or services end uses, nor on the transport vehicle types or segments. The energy balance will therefore be useful to assess the largest consuming sectors within a country where the energy saving potential will have more impact, before starting more detailed collection programmes on data for energy efficiency indicators.

As a starting point, energy balances should be used for an overview of the country’s consumption, as they are available in almost every country. Even if final consumption is broken down only into aggregated sectors, energy balances contain useful information for understanding the structure and the evolution of energy consumption; for example, how energy consumption in the residential sector evolved over time. This is why the manual is structured around the main four sectors of total final consumption (TFC), as defined in the International Energy Agency (IEA) (and other organisations) energy balances, namely: residential, services, transport (both passenger and freight) and industry. Each end-use sector will be discussed in a dedicated chapter.

Based on the IEA energy balances for the world, Figure 3.3 shows the shares of the various sectors within the world TFC, and how they evolved over time. Although these shares vary greatly by country – as discussed in the sectoral chapters – industry,

transport and residential are the largest end-use sectors globally, with the share of transport increasing over time at the expense of industry, and the share of residential remaining stable.

**Figure 3.3 • Shares of sectors in total final consumption for the world (1973 and 2011)**

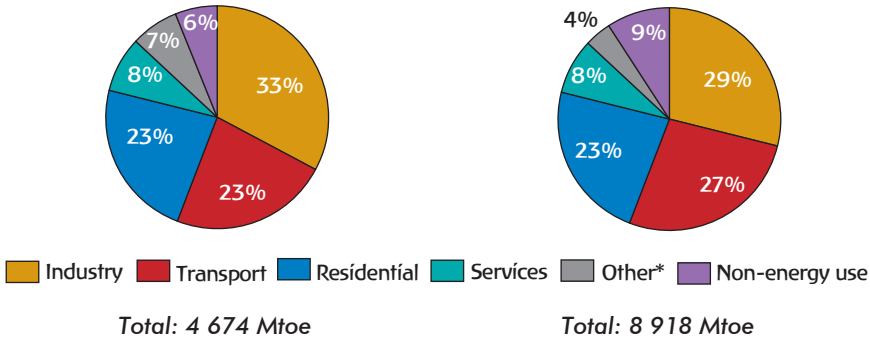

\* Other includes agriculture/forestry, fishing, non-specified.

Note: unless otherwise indicated, all tables and figures in this chapter derive from IEA data and analysis.

On a country level, this type of information is certainly relevant to quickly understand aggregated energy consumption patterns, and can be used to produce macroeconomic indicators – such as total residential consumption per capita – which are useful for monitoring high-level trends of energy consumption. However, such aggregated data are very rarely meaningful in monitoring energy efficiency trends, since they can give only a broad overview that is not focused enough for policy, actions and measures. To build energy efficiency indicators, it is therefore necessary to disaggregate data further, and to understand which sub-sectors or end uses drive energy consumption within each of the sectors. For example, in a cold country, the most important end use within residential energy consumption may be space heating, while in a warm country, it could be cooling.

Even if in some cases the breakdown of sectoral consumption depends of local specificities (for instance, water pumping/lifting in some countries, or agriculture in others), most of the time there is a commonly agreed disaggregation into sub-sectors and end uses that encompasses the largest part of final consumption. Figure 3.4 illustrates the disaggregation of sectors into sub-sectors or end uses adopted in this manual for energy efficiency indicators. The end uses of residential include space heating, space cooling, water heating, lighting, cooking and appliances, and the disaggregation of the services sector is similar, except for other equipment which includes cooking, appliances and many more end uses. For industry, the sector is subdivided into sub-sectors, such as iron and steel, chemical and petrochemical, etc. Transport, consisting of passenger and freight, is divided into sub-sectors (road, rail, air and water), and then into modes/vehicle types, such as cars, trains, ships, etc. The column “Other” includes categories of TFC that are not covered in the manual, as they are less relevant for energy efficiency indicators or there are currently scarce data. Annex B provides a description of the boundaries of each sector, relating them to the International Standard Industrial Classification of all Economic Activities of the United Nations.

**Figure 3.4** • Schematic disaggregation of total final consumption into sectors and sub-sectors or end uses

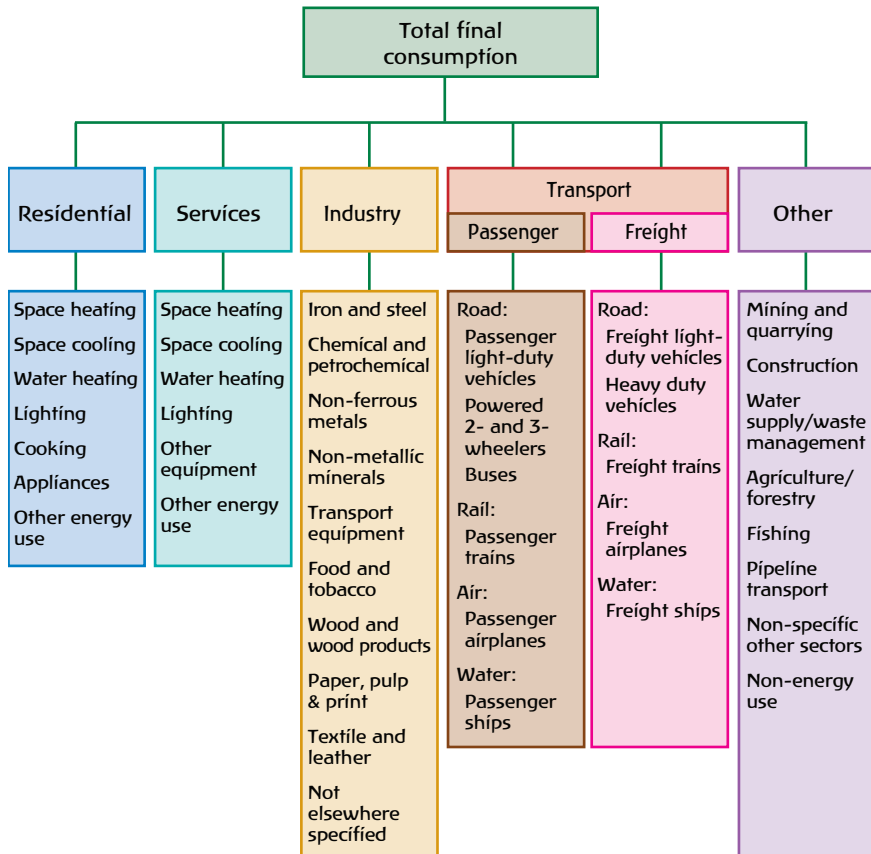

## Questions and Answers

### Q1. What is included under “Other” in the sectoral disaggregation of TFC?

As shown in Figure 3.4, in this manual “other” groups all the sub-sectors of total final consumption that are not included in the main four sectors (residential, services, industry and transport). For the purpose of energy efficiency indicators, “industry” covers only manufacturing; as a consequence, mining and quarrying as well as construction are not included in industry but in “other”. “Other” also covers the non-energy use of fuels across sectors; agriculture and forestry; fishing; water supply; pipeline transport and non-specified other sectors.



## Q2. Why is non-energy use excluded from energy efficiency indicators?

*For the purpose of energy efficiency indicators, the focus is on the efficiency of energy use in the process of production, so consumption excludes non-energy use of fuels. Of course, when more broadly assessing the potential for energy savings, the use of fuels as feedstock should also be analysed, as it may represent a large fraction of the total consumption especially for some sub-sectors, such as the chemical and petrochemical industry.*

## How to organise indicators into a hierarchy? .....

Indicators built to understand trends in the consumption of a sub-sector or an end use could be more or less aggregated and sophisticated based on data availability. The indicators proposed in this manual are presented for each sector and then for each sub-sector or end use following a “pyramidal approach”, from the most aggregated level down to the most disaggregated one. The key general concept is illustrated in Figure 3.5.

**Figure 3.5 • Schematic representation of the IEA energy indicators pyramid**

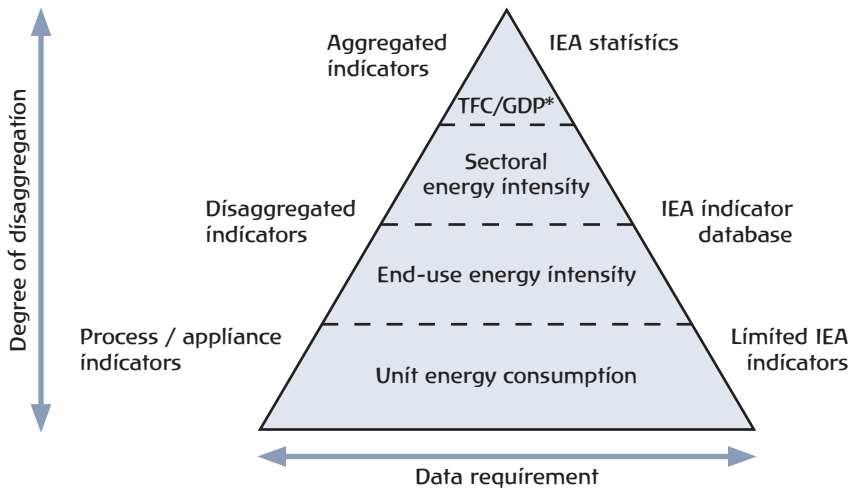

\* Gross Domestic Product

The degree of disaggregation chosen affects the data collection requirements. For example, sectoral level indicators, such as total industry consumption per total industry value added, can be relatively easily derived from energy balances and other macroeconomic data. The information that they provide is not specific enough to monitor energy efficiency, but can still be used for an initial assessment of trends in

energy consumption by sector and for cross-country comparisons. Such indicators are included in this manual, under the general category of “energy indicators”.

Indicators of “energy efficiency” require instead more disaggregated information. Generally, energy efficiency indicators are intensities, presented as a ratio between energy consumption (measured in energy units) and activity data (measured in physical units).

$$\text{Energy efficiency indicator} = \frac{\text{Energy consumption}}{\text{Activity data}}$$

Energy efficiency indicators are computed at the end-use or sub-sectoral level, or at an even more disaggregated level, the unit energy consumption level. For example, within the residential sector, space heating energy consumption per floor area is an energy efficiency indicator at the end-use level, and energy consumption per unit of appliance is an energy efficiency indicator at the unit consumption level.

### Box 3.2 • The IEA collection of data for energy efficiency indicators

In 2009, IEA Members committed to collect energy efficiency indicators data through a new annual questionnaire (the “IEA energy efficiency indicators template” shown below). The template collects energy consumption and activity data for various end-uses, sub-sectors and modes/vehicle types across the four sectors: residential, services, industry and transport.

The IEA data collection started soon afterwards and is still at its early development stages, with quality and coverage variable across Members, but regularly improving.

The template is available online at the IEA energy efficiency statistics web page: [www.iea.org/statistics/topics/energyefficiency/](http://www.iea.org/statistics/topics/energyefficiency/).

Energy Efficiency Indicators Template		
country name		
<b>COUNTRY DATA SECTION (to be reviewed and updated)</b>		
MACRO ECONOMIC DATA	Macro economic and activity data	>>
COMMODITIES	Production outputs from selected energy-consuming industries	>>
INDUSTRY	Energy consumption by ISIC categories	>>
SERVICES	Energy consumption by end-uses in the services sector	>>
RESIDENTIAL	Household energy consumption by end-uses and selected appliances data	>>
TRANSPORT	Energy and activity data for passenger and freight transport	>>
<b>IEA DATA and AGGREGATE INDICATORS</b>		
ELECTRICITY GENERATION	Electricity generation from combustible fuels and efficiencies	>>
BASIC INDICATORS	Predetermined set of aggregate energy and activity indicators	>>
<b>SUPPORT TOOLS</b>		
USER REMARKS	To incorporate comments associated to the data from the individual sheets	>>
DATA COVERAGE	Generates a graphical summary of data coverage (completed vs. expected)	>>
SINGLE INDICATOR GRAPHS	To generate a graph for one energy indicator	>>
MULTIPLE INDICATORS GRAPHS	To generate a graph comparing trends from multiple indicators	>>
CONSISTENCY CHECKS	To run the integrated consistency checks	>>

If you have any questions or need assistance with this questionnaire visit the dedicated website <http://indicators.iea.org>  
 username: indicators  
 password: efficiency  
 or write to [energyindicators@iea.org](mailto:energyindicators@iea.org)

Trends in energy efficiency indicators, driven by policies, technological progress, structural changes or behavioural changes, will in turn impact the aggregated energy indicators shown at higher level in the pyramids.

In this manual, pyramids of indicators are presented for each end-use sector, and within each sector for each end use or sub-sector. For example, for the residential sector, one pyramid will present a set of sectoral level indicators, and six pyramids will present sets of end-use level indicators. Not all indicators for all sectors are relevant to all countries. The level of desired detail for indicators will depend on existing resources, existing data, country specificities and key policy priorities. Still, a recommended indicator is presented for each end use with a smiley face, for countries wanting to develop particularly meaningful energy efficiency indicators for that end use.

### 3 How to collect data?

Once the set of priority indicators is defined, the corresponding energy consumption and activity data need to be identified and then collected. Some data are easier to collect than others; this is true for both energy consumption and activity data. It is crucial in any case to choose an optimal strategy for data collection, given the country-specific situation. Examples of practices from countries with similar circumstances could also help to identify data requirements and possible approaches to data collection. Annex D in this manual includes a large number of country practices for data collection across the various end-use sectors.

Before launching any new data collection, it is essential to make a broad review of existing data for both energy consumption and activity data. The review should include every single potential source of information and all administrations and non-governmental associations (ministry of energy, statistics office, ministry of transport, chamber of commerce, industry association, etc.). There is indeed in every country a huge amount of data that energy statisticians are unaware of that, when identified, could constitute a good basis to develop some energy efficiency indicators and could reduce the overall cost of a programme by avoiding duplication of expensive data collection projects.

In general, the different methodologies used to collect energy consumption and activity data across end-use sectors can be grouped into four main categories: administrative sources, surveying, measuring (also called metering) and modelling. All categories have strengths and weaknesses, and countries often combine some of them (administrative sources and modelling, for example) to build complete sets of indicators. A brief introduction of each methodology group follows; more detailed sector-specific descriptions for the residential, services, industry and transport sectors, based on the country practices received by the IEA and summarised in Annex D, are presented in the next four sectoral chapters.

#### Administrative sources .....

Administrative sources are those that already collect relevant data, either for energy efficiency indicators or, very often, for other purposes. As mentioned, before starting a new data collection, it is essential to preliminarily assess what relevant data are already available, from both government and other organisations. This will prevent duplication of efforts and more quickly identify where data gaps are.

Government sources, including national governments but also state-level and local governments, such as municipalities, generally collect a lot of information that could be useful to develop energy and energy efficiency indicators. For example, national agencies and statistics offices collect various macroeconomic data such as population, GDP and industry value added; tax agencies collect valuable population and industry data, etc. Among non-governmental organisations, industry associations generally gather detailed sector-specific information, although sometimes confidential; distribution companies tracking shipments could provide information on the penetration of certain equipment; car manufacturers would record the number of new vehicles sold every year while vehicle registers would track activity data for the national vehicle stock, etc.

To get such information from other organisations, sometimes data must be purchased, or a Memorandum of Understanding must be established. In any case, a certain level of effort is required to establish a working procedure for data-sharing across organisations. However, using administrative sources means that the costs of a specific new data collection project will be avoided. Table 3.1 briefly summarises advantages and disadvantages of using administrative sources.

**Table 3.1 • Pros and cons of using administrative data sources**

Pros	Cons
<ul style="list-style-type: none"> <li>• Avoid cost of a new data collection process</li> <li>• Relatively quick availability</li> <li>• Increased synergy between institutions</li> <li>• Raise profile and interest of energy efficiency among various services</li> </ul>	<ul style="list-style-type: none"> <li>• Boundary issues: potential mismatch between definitions and target populations of existing data and data needed</li> <li>• Challenges in establishing and maintaining communication with the source organisation</li> <li>• Potential costs (direct and indirect, such as purchase data, or establish agreements, change data formats, etc.)</li> <li>• Time investment in search for data sources</li> </ul>

## Surveying .....

A survey is a method for collecting data through a set of questions from a sample of the population that needs to be studied, for example households, vehicle owners, members of an industry association, etc. A survey process can be organised around a number of steps, such as preliminary design, testing phase, implementation and data collection and final analysis of results. The literature covering theoretical aspects of surveying is very broad<sup>1</sup>; this manual highlights only key aspects of surveys, with focus on those for data for energy efficiency indicators.

At the outset of the survey design, clear objectives need to be defined. What policy needs will the information support? What information is needed? What population will be targeted? Will there be any legal requirement?

A well-designed questionnaire is essential to obtain responses of good quality. While minimising the burden on respondents, a good design should aim at collecting the most complete and accurate data, taking into account both the statistical requirements of data users and the characteristics of the respondent population. Before finalisation,

1. See for example the report UN (2005).

questionnaires should be reviewed internally and tested to ensure that instructions are clear. To ensure a successful response rate, questionnaires should ask only for essential information and questions should be formulated as simply as possible.

The success of a survey also depends on the representativeness of the sample chosen with respect to the target population of interest. Only a “census” covers the whole population, but it is not generally easy to implement. For example, while a national industry association can survey the whole population of its members, it would be much less feasible for a country to survey all the vehicle owners. Figure 3.6 shows that a census can deliver high levels of accuracy and detail, but also generally comes at a high cost in terms of money and time. A survey, on the other hand, is more cost-effective and takes less time, but results will be less accurate than those based on a census, as they could be affected by sampling errors.

**Figure 3.6 • Trade-off between survey and census**

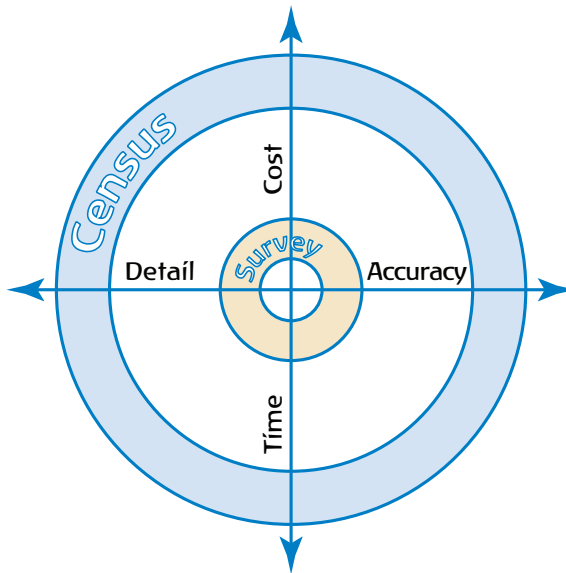

A key element in designing a sample-based survey is to properly stratify the sample, as only a correct stratification will make the sample nationally representative. Also, the sample size needs to be effective: a sample that is too large will not bring more benefits to the end results; on the other hand, a sample that is too small will not deliver reliable results. A survey can be distributed in a number of formats, and data can be collected in many ways, such as by telephone or in-person interviews, paper questionnaires sent by mail or internet-based questionnaires. Advanced tools for surveys include computer-assisted telephone interviews and computer-assisted personal interviews. In all relevant cases, training of interviewers plays an essential role in achieving consistent and unbiased results.

Surveys are generally performed regularly over time, every one to three or four years, to ensure continuity of the outcome. As surveys are repeated, organisations will typically become more efficient at delivering the results.

Table 3.2 briefly summarises advantages and disadvantages of using surveys. Of course, surveys alone may not be enough, and may need to be complemented by information derived from administrative sources, direct measurements or modelling studies.

**Table 3.2 • Pros and cons of using surveying**

Pros	Cons
<ul style="list-style-type: none"> <li>• Relatively cost-effective, given extensive information collected</li> <li>• Ad hoc design of items collected based on purpose</li> <li>• Representativeness/statistical significance</li> <li>• Overall, comprehensive and good quality information</li> </ul>	<ul style="list-style-type: none"> <li>• Potentially high absolute cost</li> <li>• Time consuming</li> <li>• Need for further estimation work (e.g. extrapolation between years)</li> <li>• Risk of incomplete responses, biases, sampling errors</li> <li>• Requirement of staff training</li> </ul>

## Questions and Answers

### Q3. How does one use existing surveys?

*Expanding existing surveys to gather additional information for energy efficiency indicators can be a less costly option than designing a new survey. For example, a few questions could be added to an existing national household survey to collect data on appliance diffusion and type, energy sources used and patterns of appliances energy consumption.*

### Q4. What is a panel survey?

*Panel surveys\* are methodologies of data collection based on a sample first drawn and then regularly interviewed in time. Over time, the respondents become more familiar with the questions and take less time to answer. The resulting databases are generally the basis for quantitative analyses of social and economic change. They represent good instruments at a relatively low cost if enough volunteers are involved in the project.*

### Q5. How does one address confidential issues in the design of a survey?

*Questionnaires may touch on sensitive or confidential information, and the way of posing such questions may influence the responses. Questionnaires should clearly state how confidential data are going to be protected, and how data will be treated and disseminated, to ensure that respondents feel comfortable in giving the most unbiased answers.*

\* See for example the European Community Household Panel (ECHP), available at: <http://epp.eurostat.ec.europa.eu/portal/page/portal/microdata/echp>

## Measuring .....

Direct measurements are the least-frequently-used method to collect data for energy efficiency indicators, mainly due to their high costs, which also imply that samples are generally small, and therefore rarely representative. Generally, the key driving factors for measurement costs are the cost of the individual equipment and the labour costs to set it up, to maintain it in good operational condition and to collect measurements. Additional costs, common to other data collection methodologies, include the costs of designing the sample, of analysing the data and of communicating the results. In the future, a decrease in equipment costs could provide greater opportunities for measuring initiatives.

Although based on small samples, measurements can shed light on important consumption patterns and can be used to estimate consumption of the different sectors and their end uses, for example as a complement to other methods of data collection. The advantage of undertaking small sampled measurement initiatives is to collect information that could not have been otherwise possible to obtain. For example, direct measurements can monitor the energy consumption of individual appliances or the temperature settings in different rooms within a household; the electricity consumption of a building ventilation system; the traffic activity by vehicle type of a specific road site or the energy consumption and the length of each individual journey for transport, etc. Since measurements are often made with meters (odometers for distance travelled, meters for electricity consumption, etc.), the term “metering” is often used instead of “measuring” when discussing the topic.

Measurements, for example those in the residential sector, generally involve the installation of several meters between the sockets and each of the main appliances, such as washing machines, dishwashers, computers and televisions, but also lighting fixtures, cooking devices, etc. Measurements are generally performed over a relatively short time, such as few weeks, although in some cases the equipment can be maintained for longer periods, such as a year. When meters are very simple, readings can be performed directly by the households themselves; otherwise, data are transmitted to a processing centre.

Beside the issues seen above, metering can suffer from a “spying” image, especially in the residential sector, where measuring each appliance’s consumption on a real-time basis could be seen as a breach of privacy.

Measurements are often privileged in the case of energy audits (industry, buildings, etc.) when there is a need of detailed information rather than for efficiency indicators. Only direct measurement initiatives can provide information on how efficient individual pieces of equipment are, how much energy they consume in standby, how much each end use contributes to the total energy consumption and how the overall consumption patterns vary over time. This type of knowledge can much better inform decision makers so that they can plan well-founded actions to reduce energy consumption. It can also support demand-side management strategies and, for electricity, allow more rigorous planning of the generating capacity and of the power of transmission and distribution systems, especially in rural areas. Results from measurements are also beneficial directly to users, to understand how they use energy and to increase their awareness of the potential energy savings that could be derived from behavioural changes.

**Table 3.3 • Pros and cons of using measuring**

Pros	Cons
<ul style="list-style-type: none"> <li>• Provides actual energy consumption at end-use or equipment level</li> <li>• High accuracy of data collected</li> <li>• Can shed light on actual behavioural patterns</li> <li>• Can be a key complement to other methodologies</li> </ul>	<ul style="list-style-type: none"> <li>• High cost of equipment</li> <li>• Small sample of population and time/lack of representativeness</li> <li>• Possible malfunctioning of equipment</li> <li>• Difficulties in finding volunteers</li> </ul>

## Modelling .....

Modelling is an integral part of the process to estimate energy consumption across end-use sectors, either by itself or to complement results from another method, such as for example a survey or administrative sources. Based on input data and on a number of assumptions, a model produces a set of output data, such as energy consumption or greenhouse gas emissions at the sectoral or sub-sectoral level; or activity data, such as diffusion of a given appliance within the residential sector. Models are also essential for consolidating historical time series on end uses, and can also be used to build energy projections and scenarios.

The key steps of modelling work include establishing the modelling framework, setting model assumptions, inputting data, running the model, validating its outcomes against data and analysing results. The quality of input data and the accuracy of assumptions will strongly impact the quality of the output. Many of the country practices collected by the IEA raise the issue of the lack of availability of good quality data across end-use sectors to effectively model energy consumption trends.

In most cases, models for energy efficiency indicators are bottom-up models, using either a statistical or an engineering approach. Bottom-up simply means that model inputs are disaggregated at end-use level. Engineering models can be more technical and include technology-level information such as life cycle and cost, and could even assume technology evolution. When sufficient end-use level information is lacking, modellers rely more on a top-down approach based on macro- and micro-economic elements, as well as studies and research linking various variables, such as disposable income and household spending and energy consumption. These models are usually regression-based econometric models and analyses.

All model results need to be validated against existing national data, such as energy balances or national energy statistics. For example, the modelled energy consumption of all vehicle types for passenger and freight transport needs to add up to the total transport energy consumption of the country energy balance.

Figure 3.7 shows an example of bottom-up modelling approach for the transport sector. The model, based on input for energy consumption and activity data taken from administrative sources, mobility surveys or measuring initiatives, produces separate estimates of passenger and freight energy consumption, after validating the total sectoral consumption against the national energy balance.



**Figure 3.7 • Schematics of a transport model: Sources, output and validation**

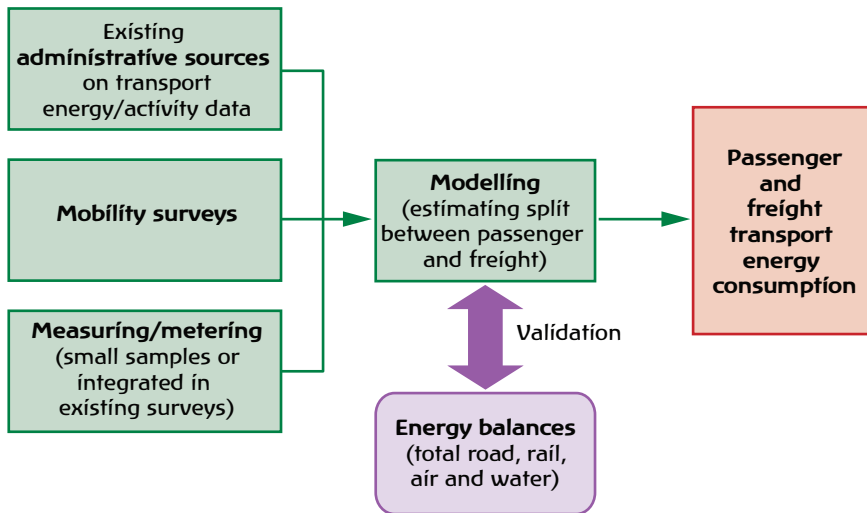

The time needed to build and properly calibrate a model can vary, depending on the complexity and on whether the model is developed based on an existing one or not – in which case the development phase only consists of an update based on custom assumptions and data. In general, the cost for modelling is largely a function of the cost of labour, and possibly of any cost of required input data.

**Table 3.4 • Pros and cons of using modelling**

Pros	Cons
<ul style="list-style-type: none"> <li>• Cost-effective</li> <li>• Designed based on purpose</li> <li>• Can consolidate data from multiple sources</li> <li>• Can provide estimates of variables that cannot be measured</li> <li>• Allows validation of bottom-up estimates against national energy statistics</li> </ul>	<ul style="list-style-type: none"> <li>• Relies on availability of input data</li> <li>• Depends on quality of input data</li> <li>• Depends on assumptions made</li> <li>• Transparency may be an issue</li> </ul>

# Collecting What and How for the Residential Sector

## 1 What does the residential sector mean and cover?

According to the United Nations *International Recommendations on Energy Statistics* UN (2013), a household is “a group of persons who share the same living accommodation, who pool some, or all, of their income and wealth, and who consume certain types of goods and services collectively, mainly housing and food”. The residential sector, also known as the households sector, is therefore a collective pool of all the households in a country. For the sake of clarity and parallelism with the terminology used for energy balances, the term “residential sector” will be used in this manual.

More concretely in terms of energy consumption, the residential sector includes all energy-using activities (i.e. heating, cooking, appliances, etc.) related to private dwellings where at least one person resides. A wide range of dwellings would qualify, ranging from a modern multi-storey apartment building in the centre of a megalopolis to a nomad tent in the middle of the desert.

It is important to note that the energy consumption associated with personal transport related to households should be reported in the transport sector. Therefore, daily commuting to and from work or to any other place in personal vehicles or on public transport should be captured under the transport sector and not in the residential sector.

### Questions and Answers:

#### Q1. Is there a difference between dwellings and households?

*Dwelling is what the United Nations refers to as the “housing unit”, a separate and independent place of abode intended for habitation by a single household. However, a housing unit (therefore a dwelling) may be occupied by one or more households. In terms of energy consumption, it is easier to collect the information for the dwelling as a whole than by household living in the same unit.*

#### Q2. What should be included in “total dwellings”?

**Total dwellings:** *Includes all dwellings in the residential sector: primary and secondary residences, regardless if they are occupied or not. However, dwellings under construction are excluded.*

**Total occupied dwellings:** Only primary residences are covered; unoccupied dwellings and secondary residences such as vacation homes and country houses are excluded.

### **Q3. Should vacant dwellings be included in the coverage of energy consumption of the residential sector?**

Every effort should be made to distinguish what portion of total dwellings in a country is vacant (secondary residences). Attention should be paid when vacant residences constitute more than 1% of the existing dwelling stock as this could impact the energy efficiency analysis of the occupied dwelling stock. Therefore activity data, such as occupied floor area, should be distinguished between primary and secondary residences as far as possible. Consequently, vacant dwellings should be excluded.

### **Q4. Is there a difference between dwellings and buildings?**

Yes; in the residential sector, a building could be composed of multiple residential dwellings where households reside. Note that the concept “building sector”, often used by analysts, includes residential and services sectors combined.

### **Q5. What about external buildings such as detached garages or sheds?**

Residential data should include all energy uses that occur within the boundaries of a household property. All activities related to stationary dwellings on a property should be accounted for. Such activities could include an external building that acts as a shed or garage, workshop, or external sleeping quarters.

### **Q6. How does one treat rooms that are used as offices in private dwellings?**

Some people use part of their dwelling to host professional activity: this is for instance the case of a doctor receiving patients in a practice inside his/her dwelling, or of a shopkeeper having his/her shop inside the dwelling. Technically speaking, any energy consumption for professional purpose should be excluded from the dwelling consumption. In most cases this is not easy to do since there is often only one electrical meter for both, or only one heating system for both. Depending on the relative weight of the professional consumption, the household consumption should be reduced at the pro rata of either the respective areas or occupancy.

## 2 Why is the residential sector important?

The residential sector accounts for about a quarter of global total final consumption (TFC). This share has remained stable over the last 35 years and will likely remain more or less the same in the future. However, this is only a global average and there is a wide disparity of the share of the residential sector among countries due to climate conditions, energy resource availability, energy infrastructure, income, economic structure and other country-specific conditions and preferences.

The two extremes in terms of share of residential energy consumption in TFC are, on the one hand, developing tropical countries with limited industry and services sectors, and on the other hand countries with no heating requirement and with an economy based on large service and/or industry sectors. The first set of countries relies mainly on biomass as the primary source of energy, mostly for cooking; the share of residential in TFC may often exceed 75%. While for the other countries mentioned, the residential energy consumption could account for less than 10% of TFC. This variation can be better seen in Figure 4.2, which shows the share of the residential sector in TFC for some selected countries. The shares are estimates from International Energy Agency (IEA) energy statistics and should be used with caution as a preliminary indication of the weight of the residential sector relative to the other sectors in each country, as some countries have difficulties separating consumption of the residential sector from the services sector for several end uses and energy forms.

While the share of the residential sector in TFC varies widely from country to country, so do the shares of the respective energy sources consumed in this sector. Globally, the residential sector consumes almost a quarter of world TFC, but it accounts for consumption of 74% of biomass, 30% of natural gas, 27% of electricity and only 6% of oil (Figure 4.1).

**Figure 4.1** • Share of the residential sector in the world total final consumption for selected energy sources (2011)

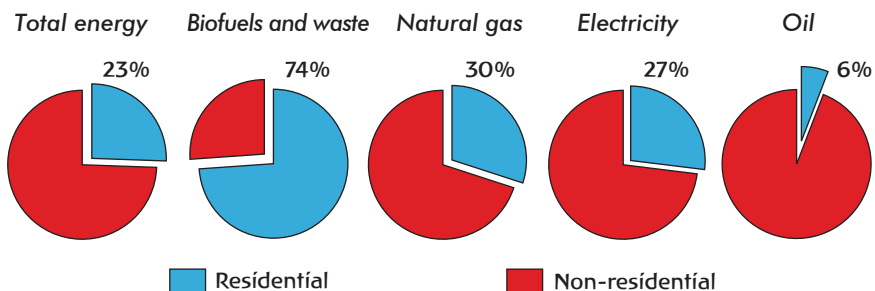

These average fuel shares are of course not representative for all the countries. For instance, households in developing tropical countries rely on biomass for more than 90% of their energy consumption, while it is rarely the main source of energy in nations where multiple and more modern sources of energy are available.

Figure 4.2 • Share of the residential sector in the world total final consumption of selected countries (2011)

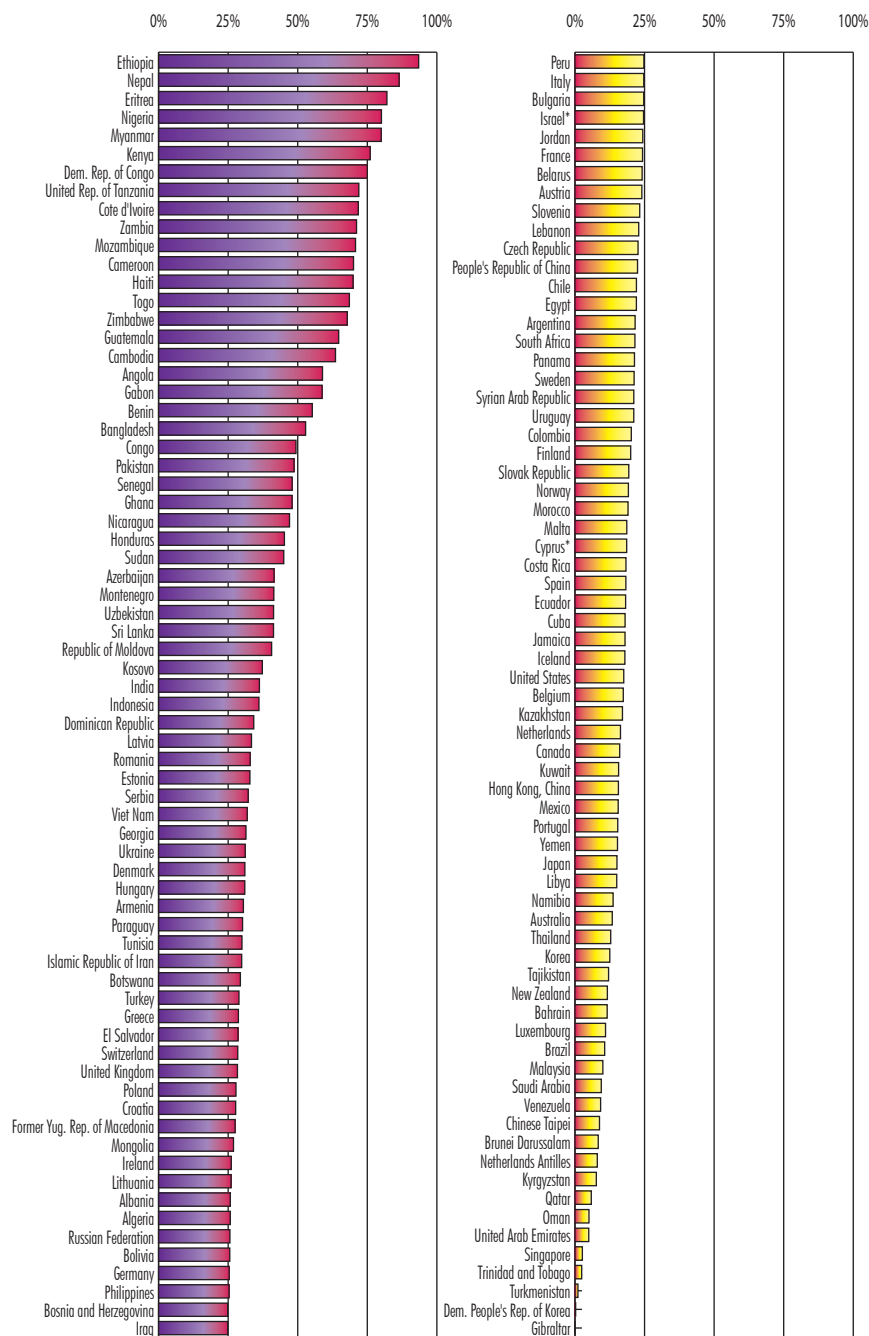

Note: unless otherwise indicated, all tables and figures in this chapter derive from IEA data and analysis.

\* See Annex F.

Similarly, electricity consumption in the residential sector can often account for more than 90% of TFC in countries where electricity is used for space heating and cooling, cooking, and water heating, while in countries with low electrification rates the share of electricity consumption may be very limited.

In 1973, solid biofuels (mainly fuelwood) accounted for a large part (44%) of the global energy mix followed by oil products (21%), natural gas (14%), coal (11%) and electricity (10%). Since then, the share of electricity has increased the most dramatically, reaching 26% in 2011; this is for several reasons: massive electrification programmes, penetration of electricity for space and water heating, and the development of the use of large and small appliances.

The share of natural gas has also increased, to 20%. The shares of both oil and coal have experienced a sharp decrease respectively to 10% and 4% in 2011. Although biofuels still have by far the largest share (40%) they also decreased in relative terms (Figure 4.3).

**Figure 4.3 • Share of various energy sources in world residential energy consumption**

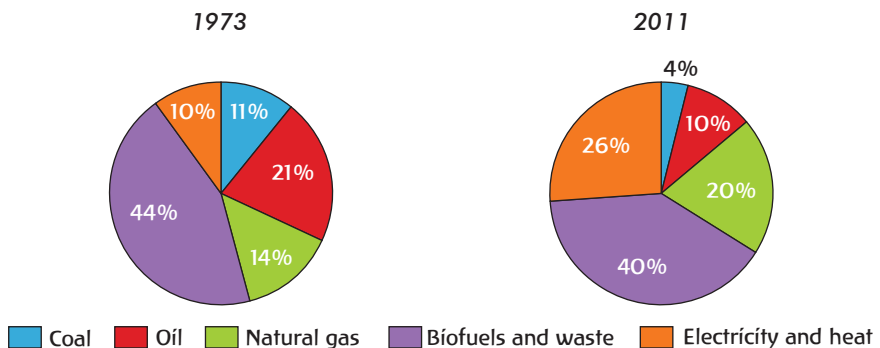

It is important for policy makers to recognise both the weight of the energy demand from the residential sector in a given country and the potential energy savings that could be achieved in the sector. Those savings could affect energy trade, security of supply, domestic resources, the standard of living of people and greenhouse gas emissions. For instance, imposing strict building codes, phasing out incandescent bulbs, banning appliances that do not meet minimum efficiency standards, subsidising certain equipment, applying taxes on particular practices and energy sources, and encouraging more efficient wood stoves could have a serious impact on overall energy consumption.

Although policy makers have a major role to play in impacting energy consumption of the sector, there are many other players that can influence energy consumption: the households themselves translate price signals into actions and changes in behaviour, utilities impact residential use on peak and load curve; manufacturers propose more efficient appliances; architects design more efficient buildings; and local communities avoid a desertification process in case of overuse of biomass.

## Questions and Answers:

### Q7. Can residential energy consumption in an energy balance differ from what is reported for energy efficiency indicators?

*The first section, “What does the residential sector mean and cover?”, mentions that energy efficiency indicators are usually calculated based on occupied dwellings. In an energy balance, however, residential consumption takes into account all dwellings. There could therefore be a difference between the two. Moreover, there may also be other potential differences between the two data sets, such as temperature correction based on heating and cooling degree days.*

## 3 What are the main end uses driving consumption of the sector?

Energy end uses in the residential sector can be broadly aggregated into six main categories: space heating, space cooling, water heating, cooking, lighting and appliances. Each of these six main end uses is briefly described below, though the list and descriptions are by no means exhaustive.

- **Space heating:** Heating spaces, especially for human comfort, can be achieved through many systems and fuels. Heating systems can broadly be separated into two types, namely central heating and dedicated area/room heating. Central heating systems can heat the entire dwelling; they include hot water and steam systems with radiators, floor or wall furnaces, district heating, heat pumps, etc. Area-dedicated heating systems can be divided into several categories: stand-alone electric heaters, fireplaces, and stand-alone stoves using oil products or other fuels, such as coal or wood. It is not rare to have households using a combination of several systems, such as electrical heaters to complement insufficient base central systems. Heating systems can generate heat using a number of energy sources such as electricity, natural gas, coal, fuel oil, liquefied petroleum gas (LPG), kerosene, biomass, and active or passive solar energy.
- **Space cooling:** Equipment used for cooling a living area can be divided into two broad categories: central cooling systems and room-dedicated systems. Central air conditioners feed into a duct system that could also be used by a central heating system. Wall air conditioners and split systems are used to cool a room. There are other possible cooling systems such as swamp coolers (or evaporative coolers), which cool air through evaporation of water; heat pumps that can be

used in reverse mode to cool the air; and district cooling. Most of the cooling systems in the residential sector run exclusively on electricity.

- **Water heating:** Heated water is used for showers, bathing, washing, etc. A number of tank-based or tankless systems can be used to heat the water. Water heating can be produced alone or in combination with space heating systems. The main energy sources used by water heating systems include natural gas, LPG, electricity, biomass and, increasingly, solar thermal energy in a growing number of countries. Residential water heating is also known as domestic hot water.
- **Lighting:** Interior or exterior lighting of dwellings is mainly powered by electricity. Incandescent lamps, which have been around for more than a century, are slowly being replaced by more efficient fixtures, e.g. fluorescent tubes, compact fluorescent lamps and LEDs (light-emitting diodes). More and more countries are passing regulations to phase out the use of incandescent bulbs. Households that do not have access to electricity still rely on traditional forms of lighting such as kerosene and LPG lamps, and sometimes even candles and flashlights. Moreover, off-grid solar applications for lighting may become more prominent in the future.
- **Cooking:** Meals can be prepared using a wide range of stoves, from advanced induction stoves to traditional three-stone stoves. A number of energy sources are used for cooking such as natural gas, electricity, biomass, LPG, kerosene and coal. Beside stoves, ovens are also included in the energy consumption for cooking. Cooking appliances such as toasters and microwave ovens, due to the difficulty in separating their respective consumption, are better reported under appliances.
- **Appliances:** Appliances encompass two main categories: large (or major) appliances (sometimes also called white appliances or white goods) and other (usually much smaller) appliances. Large appliances mainly include refrigerators, freezers, washing machines, clothes dryers and dishwashers. Other appliances include a wide range of appliances from electronic equipment such as TVs, computers, and audio and video equipment to vacuum cleaners, microwave ovens and irons. Almost all appliances are powered by electricity.

The absolute and relative levels of the shares of energy consumption for each of these end uses depend on country-specific circumstances and preferences. In countries with cold climates, space heating can represent a large share of total consumption while in developing tropical countries with abundant biomass and a low rate of electrification, cooking could account for the largest share of total energy demand.

Due to the lack of data on end use in many countries, it is not possible at this stage to give a representative world average share of the consumption for each end use. However, although it is far from being representative of the whole world, Figure 4.4 gives the breakdown of residential consumption by main end-use category for 20 member countries of the Organisation for Economic Co-operation and Development (OECD) for which end-use data are available. For this sample, heating accounts for about half of residential consumption, followed by domestic hot water and appliances.



**Figure 4.4 • Breakdown of residential consumption by end use in 2010 for 20 selected OECD countries**

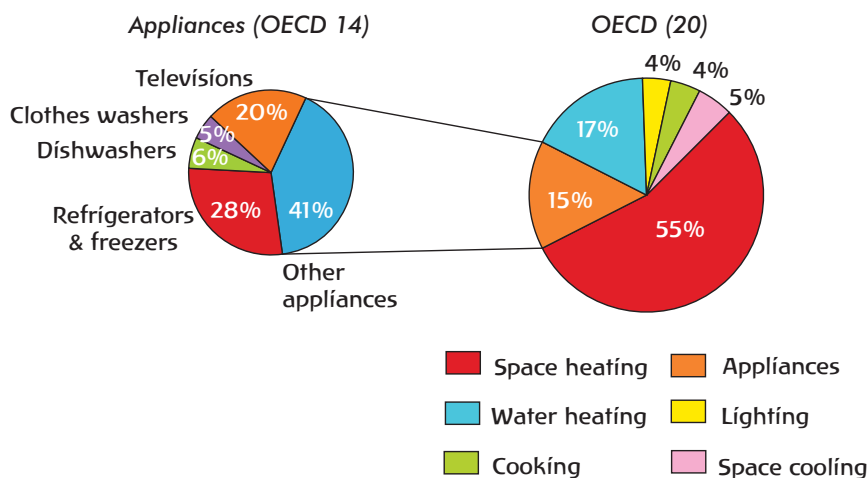

Note: The breakdown into individual appliances is available only for 14 countries.

It is interesting to note that while in the past large appliances accounted for the largest share of the overall consumption of appliances, it is now the “other appliances” that have the largest share in the appliances consumption of OECD countries. This is mainly due to the dramatic development of audio-video and computer equipment, other electronic devices, and small kitchen appliances, together with improvements in the energy efficiency of large appliances.

For comparison, a study by the World Business Council for Sustainable Development, WBCSD (2009), provides some useful figures related to the breakdown of end uses in the People’s Republic of China and in India. According to this study, in China, space heating accounted for 33% of the consumption of the sector, followed by lighting and appliances combined at 30%, water heating 25%, and cooking 12%. In India, cooking represented the main end use with 63%, followed by lighting and appliances 20%, water heating 10%, and space cooling 7%.

## Questions and Answers:

### Q8. How are specific types of equipment such as lawnmowers, snow blowers, etc. accounted for?

People may use many specific types of equipment in their dwellings that are difficult to classify under the main end uses listed previously. This is the case for instance for snow blowers, lawnmowers, outdoor heaters and many more, which would be included under “other energy use” within the residential sector

disaggregation of Figure 4.4. These are usually specific to some dwelling types (households with gardens) or to some regions (of cold or hot weather). As a consequence, and for the sake of comparison across categories and regions, these specific consumptions should not be taken into account in any of the main end uses. Nevertheless, for detailed comparisons, one might include this level of detail when developing indicators.

#### **Q9. Where should fans be included?**

Fans are often used, if not for cooling a dwelling, for giving a sensation of fresher or cooler air. In some dwellings, fans, especially ceiling fans, are the only way for “cooling down” the inside atmosphere. There is a potential debate whether to include them either in cooling or under appliances as an element of ventilation. However, in most cases they should be included under small appliances and not under cooling.

#### **Q10. Should heating water for swimming pools be included into water heating?**

As in the case of specific types of equipment, taking into account the generally low rate of swimming pools in the overall residential sector, the energy consumption for heating the water of a swimming pool should be excluded from total water heating energy consumption. This also applies to other types of equipment such as saunas or hot tubs.

#### **Q11. Where does one account for rice cookers (or similar types of equipment) extensively used for cooking in some regions?**

When a type of equipment leads to a large share of the energy consumption for cooking, as is the case for rice cookers in some regions, the consumption of this equipment should be included in the overall cooking consumption.

#### **Q12. Where should electricity used for charging the battery of an electric car be included?**

The energy consumption associated with personal transport related to households, including electric cars, should be reported in the transport sector and not in the residential sector.

## 4 What are the most frequently used indicators?

Depending on the availability of data, one can build very disaggregated indicators or stay at a level that is too aggregated to be meaningful in terms of efficiency analysis.

The most aggregated indicators include, for instance, the share of residential consumption in TFC and the overall residential consumption per capita, per dwelling or per floor area. If these indicators allow very rough comparisons (however often misleading) among countries and evolution over time, they cannot be assimilated to indicators of energy efficiency as such.

There are also aggregated indicators that can be used for specific purposes. For example the electrification rate of households in a country (total or broken down between urban and rural areas) can be used for feeding studies on electrification programmes. Another example is the rate of urban and rural households depending largely on biomass, which can be used for assessing energy poverty or measuring the impact on the local environment. But here again, these indicators cannot be considered energy efficiency indicators as such. Real energy efficiency indicators need more disaggregated energy and activity data to be meaningful, as described in the following paragraphs specific to each of the main six end uses identified above.

For each end use, indicators can be defined using a pyramidal approach: from an aggregated level (for instance, the share of space heating in total household consumption) to very disaggregated indicators (for example, space heating consumption for each type of heating system, per dwelling or per floor area). The “wider” the pyramid, the more detail that is required. Three levels have been used in this pyramidal approach, level 1 being the most aggregated one and level 3 the most disaggregated one. Moreover, for reasons of simplification, short three-character code names have been associated to each indicator to identify the end use and the level of the indicator.

Indicators starting with an **H** relate to **H**eating, with a **C** to **C**ooling, with a **W** to **W**ater heating, with an **L** to **L**ighting, with a **K** to **cooK**ing and with an **A** to **A**ppliances. The number that follows relates to the level of disaggregation, 1 being the most aggregated and 3 the most disaggregated. The main function of the third character, a letter, is to differentiate indicators for the same end use and same level. As an illustration, indicator (L2a) is an indicator of second (2) level of disaggregation for lighting (L) (in that particular case, lighting consumption per capita).

A seventh pyramid, presented as the first pyramid in the following section, can also be proposed for re-grouping the most aggregated indicators. As mentioned above, these indicators are not always associated with indicators of energy efficiency as such, but due to a lack of detailed data, they are often the only ones that can be built. They constitute a first step towards more detailed and meaningful indicators. They will start with the letter **R** and follow the same three-level classification as the six sectoral residential end uses.

For each end use, one indicator shows a smiley face (☺), meaning that indicator is the preferred and recommended indicator for this end use.

## Total residential sector .....

In most countries, consumption in the different sectors is part of an energy balance, so total energy consumption for each sector is often known, including consumption for the residential sector. Moreover, usually basic administrative sources such as a census can provide useful information in terms of basic activity data for the residential sector: population, number of dwellings, etc. Both sectoral energy consumption and basic activity data constitute the basis to develop the first and second levels of aggregated indicators for the residential sector.

**Figure 4.5 • Pyramid of residential\* indicators**

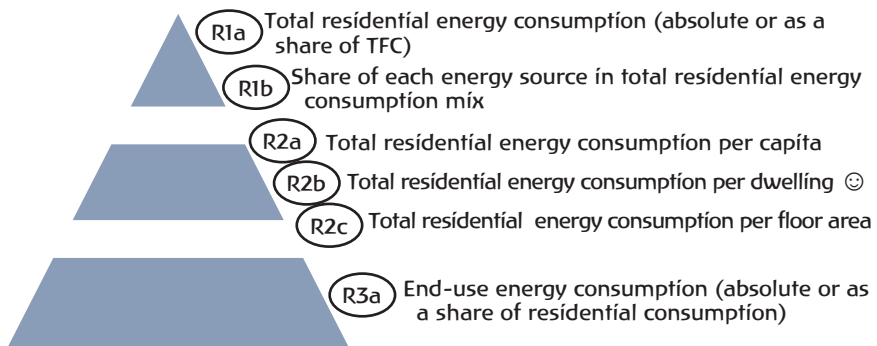

\*Note that this disaggregation applies to the total sector, as well as to each of the dwelling types (e.g. detached single-unit houses, semi-detached dwellings, etc.).

The simplest indicator, level 1, is the overall consumption of energy for the residential sector expressed either in absolute terms or in percentage of TFC (R1a). The share of the residential sector in TFC is useful to know in order to better appreciate the weight of the sector in the energy demand as discussed in section 2, “Why is the residential sector important?”. The second indicator of level 1 is the share of each energy source in the total residential consumption mix (R1b). These two indicators should not always be regarded as efficiency indicators but since, in some cases, they may be the only ones available they may be used when assessing sectoral energy policy.

The second level of indicators introduces ratios between total energy consumption and simple activity data: overall population (R2a), total number of dwellings (R2b) and when available total floor area (R2c). **Residential energy consumption per dwelling is the recommended indicator for the overall residential sector.**

The third level of indicators touches on the basic breakdown of the total residential consumption by end-use consumption in absolute terms or as a share (R3a). This is a useful indicator since it shows which end uses lead to the highest consumption in the sector.

Some countries sometimes go even further in the disaggregation of residential indicators; they, for instance, include indicators based on the construction year of dwellings or on the incomes of households. However, for the sake of simplification, they have not been considered in this manual.

## Space heating .....

Depending on the availability of data and the purpose of the indicators, there is a wide spectrum of indicators that can be built from space heating.

**Figure 4.6 • Pyramid of residential space heating indicators**

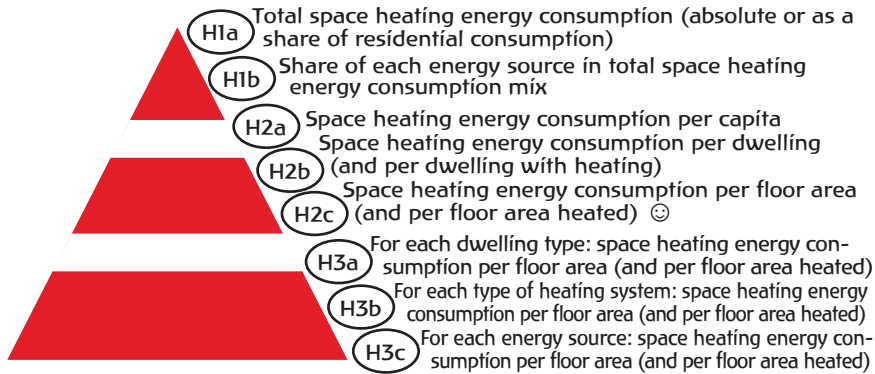

The simplest indicator of level 1 is the overall consumption of energy for heating in a country, expressed either in absolute terms or as a percentage of consumption of the sector (H1a). This is not really an indicator of energy efficiency, but it gives a first indication of the absolute and relative weight of space heating in total residential energy consumption. It could indicate the need to pay particular attention to space heating in terms of potential energy savings.

The second indicator of level 1 that can be used is the share of each respective fuel in the energy mix of the space heating consumption of the sector (H1b). Like the first indicator, it does not indicate efficiency but could be used when assessing energy policy for the sector.

The second level of indicators encompasses the space heating consumption per capita (H2a), per dwelling (H2b) and per floor area (H2c). If a large number of dwellings are not heated, indicators (H2b) and (H2c) are not meaningful enough and it is recommended to build similar indicators per dwelling heated, and per floor area heated. **The recommended indicator for space heating is space heating energy consumption per floor area heated.**

The indicator (H2c) can be further disaggregated by type of dwelling (H3a), by type of space heating system (H3b) and/or by energy source (H3c) in a third level.

Additional indicators, taking into account volume instead of area, thermal losses, efficiency of the heating system (with the introduction of the notion of useful energy), etc., could also be useful in specific cases such as thermal audits of buildings. However, since most of them refer more to the domain of building auditing than to energy efficiency indicators, they will not be considered in this manual.

*Note: Regardless of the level of indicators considered, it is recommended to adjust the space heating consumption for annual temperature variations in order to compare the situation for different years. The best way to make this adjustment is to use heating degree days (HDD) as explained in Annex C.*

## Space cooling .....

With the development of space cooling in houses and apartments over the last decade, energy efficiency indicators on cooling are becoming more and more important. However, they are more difficult to build than heating indicators due to a) the small share of houses with space cooling, b) the fact that usually only a few rooms are cooled in houses and not the whole area, c) the difficulty of isolating the consumption of electricity for cooling from the overall electricity consumption, and d) the irregular use of cooling over days and nights.

**Figure 4.7 • Pyramid of residential space cooling indicators**

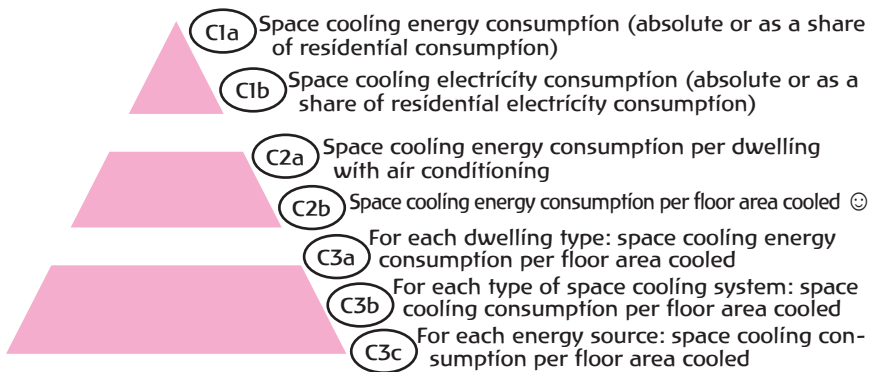

Indicators built to represent relative energy consumption for space cooling follow a similar structure to that presented for space heating. The highest-level indicator identifies the overall energy consumption for space cooling in a country, expressed either in absolute terms or in percentage of the consumption of the sector (C1a). The same reservations as for (H1a) apply to (C1a) in terms of meaningfulness of this indicator, though it is useful to assess the penetration of space cooling in the residential sector of a country. Since electricity is by far the main energy source used for cooling, the overall space cooling electricity consumption (expressed either in absolute values or as a share of total electricity consumption) is also a meaningful indicator (C1b).

Even though cooling consumption per dwelling is sometimes used as an indicator, it has not been retained in the pyramid because often the number of dwellings without cooling is much greater than the number of dwellings with cooling, making the indicator meaningless. As a consequence, the two level 2 indicators retained are the cooling consumption per dwelling with air conditioning (C2a) or even better the cooling consumption per floor area of dwellings with air conditioning (C2b). **Space cooling energy consumption per floor area cooled is the recommended indicator for cooling.**

There are three third-level indicators: space cooling consumption per floor area (or per floor area cooled) for each dwelling type (C3a), for each type of cooling system (C3b) and for each energy source (C3c). The indicator (C3c) is only mentioned for future use since currently most of the cooling systems operate on electricity. But penetration of gas systems, solar cooling or even district cooling (as in the services sector) is feasible in the foreseeable future.

Note: Similar to the need to apply HDD to energy used for heating homes, it is recommended to apply cooling degree days (CDD) to normalise the energy consumption pattern over time — i.e. reduce the effect of the weather changes.

## Water heating .....

As with heating (and with the same words of caution), the **first-level** indicators for water heating deal with total energy consumption of the end use (W1a) and the share of each energy source in the total residential water heating consumption mix (W1b).

**Figure 4.8 • Pyramid of residential water heating indicators**

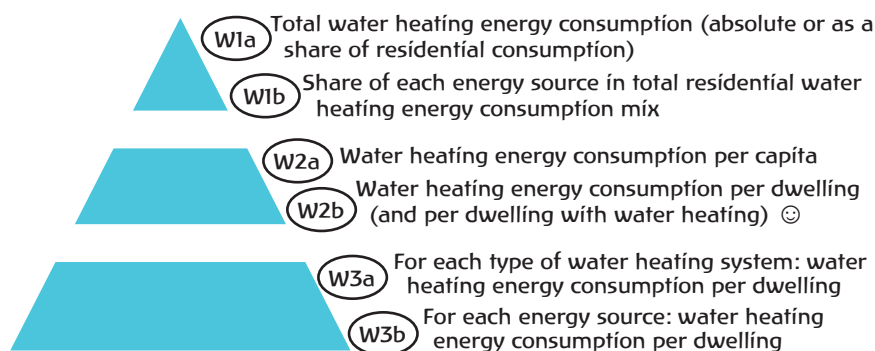

The middle section of the pyramid includes two indicators: the energy consumption for hot water per capita (W2a), and the energy consumption for hot water per dwelling (and per dwelling with water heating) (W2b). **The recommended indicator for water heating is energy consumption for water heating per dwelling (W2b).**

Third-level indicators include the water heating energy consumption per dwelling for each type of water heating system (W3a) and for each energy source (W3b).

## Lighting .....

The first-level indicators are similar to the ones described in space cooling: total energy consumption of the sector for lighting, either in absolute or in relative terms (L1a) and due to the importance of electricity in lighting, lighting electricity consumption also expressed in absolute terms and in relative terms (L1b).

The overall consumption can then be broken down into three level 2 indicators: lighting energy consumption per capita (L2a), per dwelling (L2b) and per floor area (L2c). **The recommended indicator for lighting is lighting energy consumption per occupied dwelling.**

When data on the types of dwelling are available, one can further build third-level indicators for each dwelling type covering lighting consumption per dwelling (L3a) or per floor area (L3b).

More detailed indicators could distinguish among different lighting technologies but they are rarely considered and used because of a lack of available data. As a consequence, they will not be included in this manual.

Figure 4.9 • Pyramid of residential lighting indicators

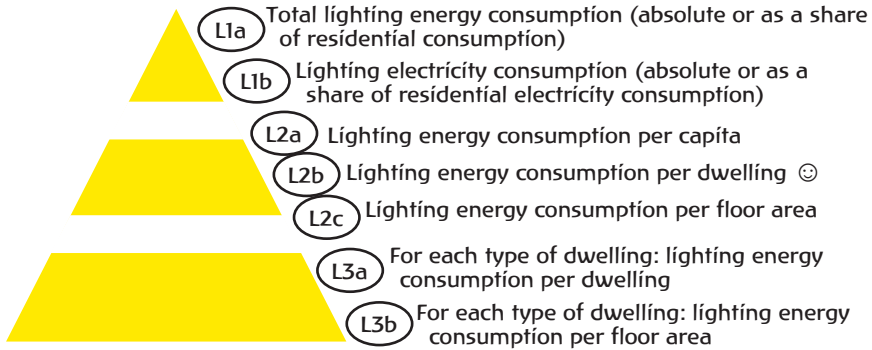

## Cooking .....

Although there are many indicators that can be built and used to assess energy used in cooking, only five indicators have been retained in this manual. The first two, at level 1, are the overall energy consumption for cooking expressed either in absolute terms or in percentage of the consumption of the sector (K1a) and the share of each energy source in the total cooking consumption mix (K1b). The same reservations as those formulated for the other end uses also apply to these indicators

Figure 4.10 • Pyramid of residential cooking indicators

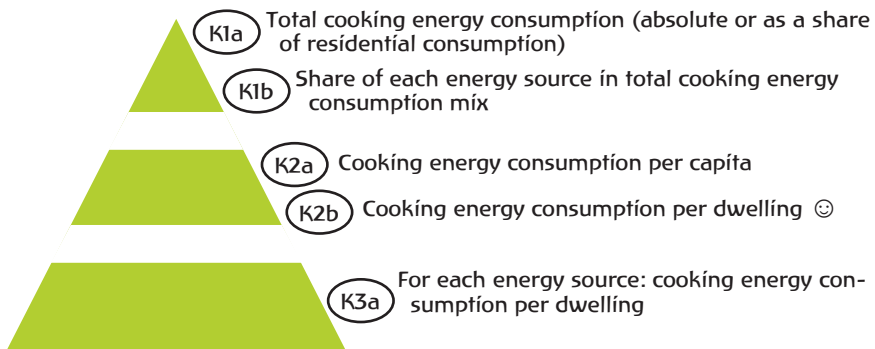

On level 2, two simple indicators show the average energy consumption for cooking per capita (K2a) and per dwelling (K2b). **Cooking energy consumption per dwelling is the recommended indicator for cooking.** The indicator at level 3 is similar to the preferred indicator but disaggregated by energy source (K3a): for instance, the total consumption of electricity for cooking divided by the number of dwellings using electricity for cooking.

There are other useful indicators that can be used especially in countries in which the overuse of fuelwood could lead to some desertification process. This is for instance the percentage of households using fuelwood or charcoal for cooking in rural and/or urban areas. This is also the rate of penetration of a certain energy form in the cooking energy mix in cities or in villages.



## Appliances

The top of the pyramid groups all the appliances into two indicators: the first one showing total energy use for appliances either in absolute value or in relative terms compared with total energy consumption of the residential sector (A1a); and the second one, as in the case of cooling and lighting, is the same indicator but just for electricity since electricity is almost the only energy source used for appliances (A1b). Although other energy sources for appliances exist, they are marginal. Appliance indicators presented here could also be developed for each type of large and small appliance in a household (for instance, overall consumption of refrigerators, TV sets, etc.).

Figure 4.11 • Pyramid of residential appliances indicators

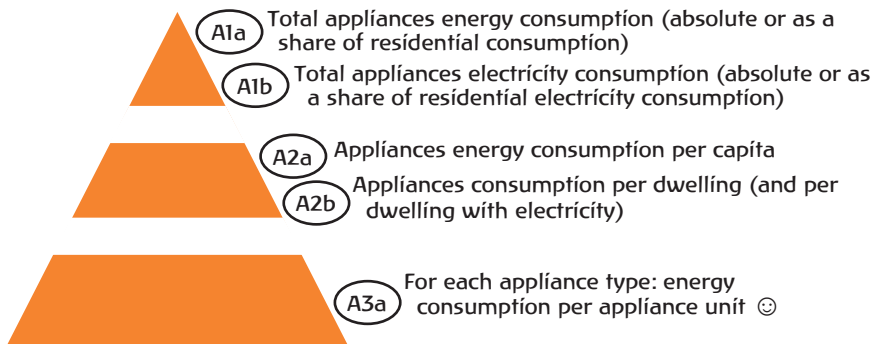

The middle level has a further breakdown to show the country's average energy consumption for total appliances (or for each different appliance type) per capita (A2a) and per dwelling (A2b) (including per dwelling with electricity).

The most detailed level is the average energy consumption by appliance unit for each appliance type (A3a). For example, in the case of refrigerators, it is the average consumption of a refrigerator in one year, which corresponds to the overall energy consumption of refrigerators in the country divided by the number of refrigerators. This type of indicator could facilitate identification of opportunities to further improve efficiency of the existing appliance stock. **Energy consumption per unit of appliance is the recommended indicator for appliances.**

Table 4.1 summarises the main indicators used for the residential sector excluding the indicators of level 1, which are not real indicators of energy efficiency or even of energy intensity; these indicators show only the absolute or relative importance of an end use in the sector mix or the total energy mix.

For each indicator of levels 2 and 3, the table gives the name, its coverage (overall or by specific type), the energy data, and the activity data to be used. The next-to-last column gives the code number for the indicator, and the last column uses a smiley face to note that the indicator is the preferred indicator for a particular end use.

Table 4.1 • Summary list of the most common indicators for the residential sector

Indicator	Coverage	Energy data	Activity data	Code	Recommendation indicator
Space heating energy consumption per capita	Overall	Total space heating energy consumption	Total population	H2a	
Space heating energy consumption per dwelling	Overall	Total space heating energy consumption	Total number of dwellings	H2b	
Space heating energy consumption per floor area (idem per floor area heated)	Overall	Total space heating energy consumption	Total floor area	H2c	☺
	By dwelling type	Space heating energy consumption of dwellings type A	Floor area of dwellings type A	H3a	
	By heating system	Space heating energy consumption of dwellings with system $\alpha$	Floor area of dwellings with heating system $\alpha$	H3b	
	By energy source	Space heating energy consumption of dwellings with energy source Z	Floor area of dwellings with energy source Z	H3c	
Space cooling energy consumption per dwelling with air conditioning (A/C)	Overall	Total space cooling energy consumption	Total number of dwellings with A/C	C2a	
Space cooling energy consumption per floor area of dwellings with A/C	Overall	Total space cooling energy consumption	Total floor area cooled	C2b	☺
	By dwelling type	Space cooling energy consumption of dwellings type A	Floor area cooled of dwellings type A with A/C	C3a	
	By type of cooling system	Space cooling energy consumption of dwellings with A/C system $\alpha$	Floor area cooled of dwellings with A/C system $\alpha$	C3b	
	By energy source	Space cooling energy consumption of dwellings with A/C system energy source Z	Floor area cooled of dwellings with A/C energy source Z	C3c	
Water heating energy consumption per capita	Overall	Total water heating energy consumption	Total population	W2a	
Water heating energy consumption per dwelling	Overall	Total water heating energy consumption	Total number of dwellings	W2b	☺
	By type of water heating system	Water heating energy consumption for dwellings with water heating system $\alpha$	Total number of dwellings with water heating system $\alpha$	W3a	
	By type of energy source	Water heating energy consumption for water heating systems with energy source Z	Total number of dwellings with systems with energy source Z	W3b	
Lighting energy consumption per capita	Overall	Total lighting energy consumption	Total population	L2a	
Lighting energy consumption per dwelling	Overall	Total lighting energy consumption	Total number of dwellings	L2b	☺
	By dwelling type	Lighting energy consumption of dwellings of type A	Number of dwellings of type A	L3a	
Lighting energy consumption per floor area	Overall	Total lighting energy consumption	Total floor area	L2c	
	By dwelling type	Lighting energy consumption of dwellings of type A	Total floor area of dwellings type A	L3b	
Cooking energy consumption per capita	Overall	Total cooking energy consumption	Total population	K2a	
Cooking energy consumption per dwelling	Overall	Total cooking energy consumption	Total number of dwellings	K2b	☺
	By energy source	Cooking energy consumption with cooking energy source Z	Number of dwellings with cooking energy source Z	K3a	
Appliances energy consumption per capita	Overall	Total appliances energy consumption	Total population	A2a	
Appliances energy consumption per dwelling	Overall	Total appliances energy consumption	Total number of dwellings	A2b	
Energy consumption per appliance unit	By appliance type	Energy consumption for all appliances of type A	Number of appliances of type A	A3a	☺

■ Heating ■ Cooling ■ Water heating ■ Lighting ■ Cooking ■ Appliances

## 5 The data behind the indicators

As mentioned earlier, a number of data elements are needed to build the basic residential energy efficiency indicators by relating energy data to activity data. Figure 4.12 highlights key energy consumption data needed to build the indicators described in the previous section. They include the various ways that energy is used in a dwelling, to heat, to cool, to cook, and more generally to live. The activity data (summarised in Figure 4.13) reflect information needed to develop average usage per person, per dwelling, per floor area and per appliance.

### The energy consumption data .....

#### Space heating consumption data

**Total space heating consumption:** This is the total energy consumption used for heating all occupied dwellings. It includes all types of energy sources (electricity, natural gas, biomass, etc.) used by all types of heating systems (central or individual) for all types of dwellings. This consumption is used as the numerator for the indicators (H2a), (H2b) and (H2c).

**Total space heating consumption for dwellings of type A:** This is the overall energy consumption for heating the dwellings of a certain type: detached single-unit houses, semi-detached dwellings, attached multi-unit houses, movable houses, etc. This consumption is used as the numerator for the indicator (H3a).

**Total space heating consumption for dwellings using heating systems of type  $\alpha$ :** This is the overall energy consumption for heating the dwellings using a certain type of heating system or equipment: central heating, district heating, stand-alone stoves, etc. This consumption is used as the numerator for the indicator (H3b).

**Total space heating consumption for dwellings using energy source Z for their heating:** This is the overall energy consumption for heating the dwellings that use energy source Z: electricity, natural gas, wood, coal, etc. This consumption is used as the numerator for the indicator (H3c).

#### Space cooling consumption data

**Total space cooling consumption:** This is the total energy consumption used for cooling all dwellings, at least those that have cooling systems. It covers all types of cooling systems (central or room-dedicated). This consumption is used as the numerator for the indicators (C2a) and (C2b).

**Total space cooling consumption for dwellings of type A:** This is the overall energy consumption for cooling the dwellings of a certain type: detached single-unit houses, semi-detached dwellings, attached multi-unit houses, movable houses, etc. This consumption is used as the numerator for the indicator (C3a).

**Total space cooling consumption for dwellings using cooling systems of type  $\alpha$ :** This is the overall energy consumption for cooling the dwellings using a certain type of cooling system or equipment: central cooling, room-dedicated (window, split system). This consumption is used as the numerator for the indicator (C3b).

Figure 4.12 • Aggregated flow chart of the energy consumption data needed for energy efficiency indicators for residential

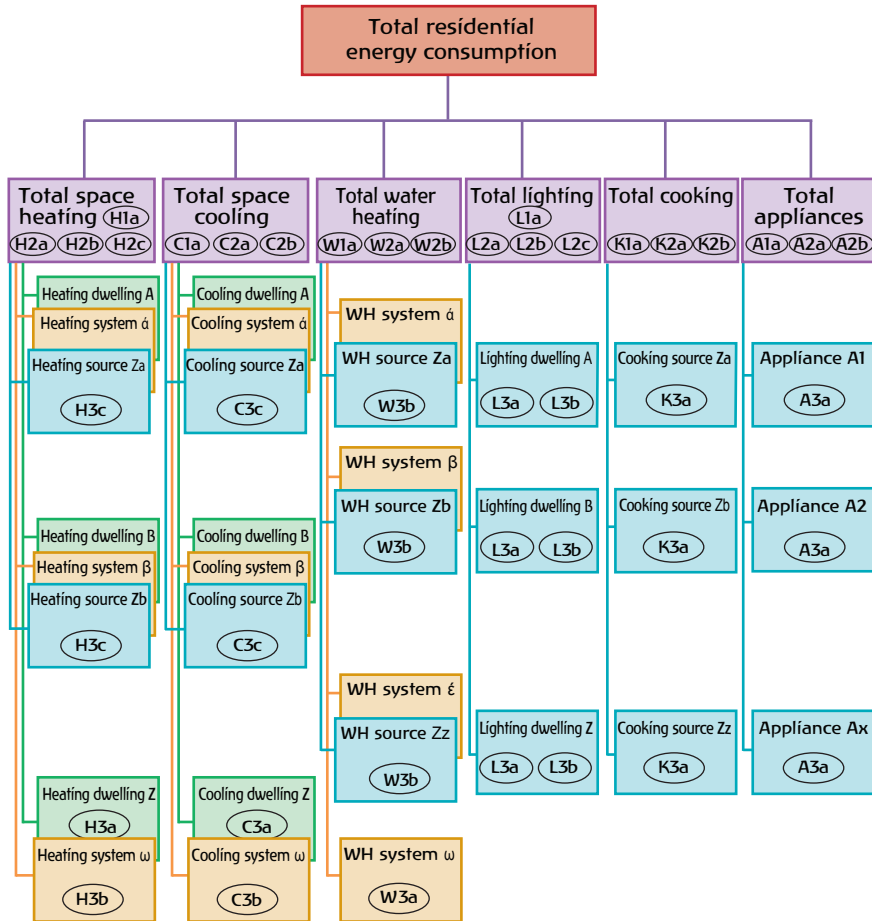

Note: "source" in the figure means "energy source".

**Total space cooling consumption for dwellings using energy source Z for their cooling:** This is the overall energy consumption for cooling the dwellings where the cooling system uses energy source Z. This consumption is used as the numerator for the indicator (C3c). The indicator (C3c) is mentioned only for future use, because currently most cooling systems operate on electricity; the penetration of gas systems, solar cooling or even district cooling could be foreseen in the future. This will also apply to the services sector.

## Water heating consumption data

**Total residential water heating consumption:** This is the total energy consumption used for water heating for all dwellings. It includes all types of energy (electricity, natural gas, biomass, solar, etc.) used by all types of water heating systems (individual or central). This consumption is used as the numerator for the indicators (W2a) and (W2b).

**Total residential water heating consumption for system of type  $\alpha$ :** This is the total energy consumption used for heating water for all dwellings using a certain type of water heating system: direct or indirect boiler systems, electrical water heating system, coupled with heating system, solar collectors, etc. This consumption is used as the numerator for the indicator (W3a).

**Total residential water heating consumption for dwellings using energy source Z:** This is the total energy consumption used for heating water for all dwellings using a certain type of energy source: electricity, natural gas, LPG, solar, etc. This consumption is used as numerator for the indicator (W3b).

## Lighting consumption data

**Total lighting consumption:** This is the total energy consumption used for lighting for all dwellings. It includes all types of energy (however, almost exclusively electricity) used by all types of lighting fixtures (incandescent bulbs, fluorescent tubes, compact devices, etc.). This consumption is used as the numerator for the indicators (L2a), (L2b) and (L2c).

**Total lighting consumption for dwellings of type A:** This is the overall energy consumption for lighting the dwellings of a certain type: detached single-unit houses, semi-detached dwellings, attached multi-unit houses, movable houses, etc. This consumption is used as the numerator for the indicators (L3a) and (L3b).

## Cooking consumption data

**Total cooking consumption:** This is the total energy consumption used for cooking by all households. It includes all types of energy (electricity, natural gas, LPG, biomass, etc.). This consumption is used as the numerator for the indicators (K2a) and (K2b).

**Total cooking consumption for households using energy source Z as the main energy source for cooking:** This is the total energy consumption used for cooking by all households using a certain type of energy as the main energy source: electricity, natural gas, LPG, kerosene, biomass, etc. This consumption is used as the numerator for the indicator (K3a).

## Appliances consumption data

**Total appliances energy consumption:** This is the total energy consumption used by all appliances by all households. It includes all types of appliances: large ones such as refrigerators and washing machines, and small ones such as TV sets, video equipment, mixers, vacuum cleaners, etc. This consumption is used as the numerator for the indicators (A2a) and (A2b).

**Total energy consumption for appliances of type  $\alpha$ :** This is the total energy consumption used by all appliances of a certain type: refrigerators, freezers, washing machines, dryers, TV sets, computers, audio and video equipment, microwaves, mixers, vacuum cleaners, etc. This consumption is used as the numerator for the indicator (A3a).

## The activity data .....

### Population

**Total population:** This is the total population of the country. It is used as a denominator for the indicators (H2a), (W2a), (L2a), (K2a) and (A2a).

### Number of dwellings

**Total number of dwellings:** This is the total number of occupied dwellings. It includes all types of dwellings: detached single-unit houses, semi-detached dwellings, attached multi-unit houses, movable houses, etc. This number is used as the denominator for the indicators (H2b), (W2b), (L2b), (K2b) and (A2b).

**Total number of dwellings of type A:** This is the total number of occupied dwellings of a certain type: detached single-unit houses, semi-detached dwellings, attached multi-unit houses, movable houses, etc. This number is used as the denominator for the indicator (L3a).

**Figure 4.13** • Aggregated flow chart of the main activity data needed for energy efficiency indicators for residential

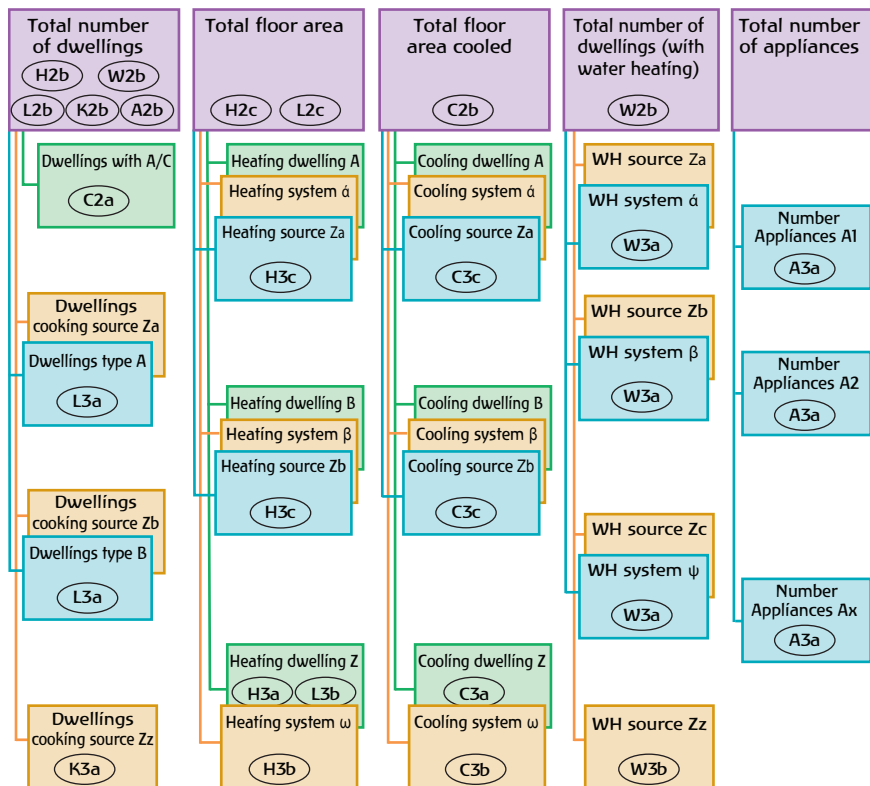

Note: total population used in (H2a), (W2a), (L2a), (K2a) and (A2a) is not shown in this figure.

**Total number of dwellings with cooling:** This is the total number of occupied dwellings having cooling system or equipment for cooling: central cooling, room-dedicated (window, split system). This number is used as the denominator for the indicator (C2a).

**Total number of dwellings with water heating:** This is the total number of occupied dwellings having domestic hot water systems: direct or indirect boiler systems, electrical water heating system, coupled with heating systems, solar collectors, etc. This number is used as the denominator for the indicator (W2b).

**Total number of dwellings with water heating system of type  $\alpha$ :** This is the total number of occupied dwellings using a certain water heating system: direct or indirect boiler systems, electrical water heating system, coupled with heating systems, solar collectors, etc. This number is used as the denominator for the indicator (W3a).

**Total number of dwellings using energy source Z for their water heating:** This is the total number of occupied dwellings using a type of energy for the production of their hot water: electricity, natural gas, LPG, solar, etc. This number is used as the denominator for the indicator (W3b).

**Total number of dwellings using energy source Z as the main energy source for cooking:** This is the total number of occupied dwellings using a certain type of energy as the main source for cooking: electricity, natural gas, LPG, kerosene, biomass, etc. This number is used as the denominator for the indicator (K3a).

## Floor area

**Total floor area:** This is the total floor area of all occupied dwellings. It includes all types of dwellings: detached single-unit houses, semi-detached dwellings, attached multi-houses, movable houses, etc. This number is used as the denominator for the indicators (H2c) and (L2c).

**Total floor area of dwellings of type A:** This is the total floor area of occupied dwellings of a certain type: detached single-unit houses, semi-detached dwellings, attached multi-houses, movable houses, etc. This number is used as the denominator for the indicators (H3a) and (L3b).

**Total floor area of dwellings using heating systems of type  $\alpha$ :** This is the total floor area of occupied dwellings using a certain type of heating system or equipment: central heating, district heating, stand-alone stoves, etc. This number is used as the denominator for the indicator (H3b).

**Total floor area of dwellings using energy source Z for their heating:** This is the total floor area of occupied dwellings using energy source Z for heating (electricity, natural gas, wood, coal, etc.). This number is used as the denominator for the indicator (H3c).

**Total floor area cooled of dwellings with air conditioning:** This is the total floor area of occupied dwellings having cooling systems or equipment: central cooling, room-dedicated (window, split system). This number is used as the denominator for the indicator (C2b).

**Total floor area cooled of dwellings of type A with air conditioning:** This is the total floor area of occupied dwellings of a certain type: detached single-unit houses, semi-detached dwellings, attached multi-houses, movable houses, etc. This number is used as the denominator for the indicator (C3a).

**Total floor area cooled of dwellings using cooling systems of type  $\alpha$ :** This is the total floor area of occupied dwellings using a certain type of cooling system or equipment for cooling: central cooling, room-dedicated (window, split system). This number is used as the denominator for the indicator (C3b).

**Total floor area cooled of dwellings using energy source Z for their cooling:** This is the total floor area of occupied dwellings with air conditioning using energy source Z for cooling the dwelling. This number is used as the denominator for the indicator (C3c). The indicator C3c is only mentioned for future use since currently most cooling systems operate on electricity; penetration of gas systems or even district cooling could be foreseen in the future. This will also apply to the services sector.

## Number of appliances

**Total number of appliances:** This is the total number of appliances in all occupied dwellings. It includes all types of appliances: large ones such as refrigerators and washing machines, and small ones such as TV sets, video equipment, mixers, vacuum cleaners, etc. This number is not used in this manual since an indicator showing the average energy consumption per appliance (all types mixed) is not really meaningful.

**Number of appliances of type  $\alpha$ :** This is the total number of appliances of a certain type: refrigerators, freezers, washing machines, dryers, TV sets, computers, audio and video equipment, microwaves, mixers, vacuum cleaners, etc. This number is used as the denominator for the indicator (A3a).

## 6 How to collect data?

Some data are easier to collect than others; this is true for both energy consumption and for activity data. For instance, it is certainly easier to derive with accuracy the heating consumption of a house using fuel oil only for heating purposes with no secondary heating systems, than it is to estimate the consumption of electricity used for lighting in a house in which electricity is used for many purposes such as heating, cooking, water heating, appliances and lighting. It is also easier to know the number of households that have access to electricity than the overall floor area that is heated in the residential sector.

There are four main methods for collecting energy consumption and activity data for the residential sector: administrative sources, surveying, measuring and modelling. The selection of a method depends on both indicators and data. They all have pros and cons, strengths and weaknesses, advantages and disadvantages. In fact, it appears that countries often combine several methods (survey and administrative sources, for instance) when developing proper indicators for the sector. A description of each of the four methods follows; the description uses for a large part the inputs received by the IEA when collecting information on good practices for collecting statistics for energy efficiency indicators. Complementary information on methodologies of data collection for the residential sector based on the experience of selected European countries can be found in the report Eurostat (2013).

Table 4.2 presents an overview of main sources and methodologies often used to collect the data needed to build the indicators presented in the previous section. Individual methodologies will be described in the rest of this section.



**Table 4.2 • Summary of the main data needed for residential indicators and examples of possible sources and methodologies**

Data	Source	Methodology
<b>Energy data</b>		
Total residential consumption	National energy balance	Administrative sources Modelling
Energy consumption by source	National energy balance Utilities	Administrative sources Modelling
<b>Activity data</b>		
Floor area	National statistics offices Real estate Regional governments Taxation registers	Administrative sources Surveys
Number of dwellings	Land registry National statistics offices	Administrative sources Surveys
Heating equipment	Building registers Manufacturers/Vendors Subsidy registers	Administrative sources
Number of appliances	Manufacturers National statistics offices	Administrative sources Surveys

## Administrative sources .....

Administrative data can be found in many places, not only from administrations but also from a variety of organisations, companies and structures that collect data for their own use. As markets are becoming more deregulated, more and more data come from non-governmental sources: utilities, appliance manufacturers associations, trade boards, etc.

**Purpose of collecting administrative data:** The main purpose of collecting data from administrative sources is to get reliable data readily available to complement the work on energy studies and analysis as well as on energy efficiency indicators. For instance, statisticians in charge of developing an energy balance for a country rely enormously on administrative sources: sales or deliveries of electricity and natural gas from utilities, imports and exports from customs offices, etc.

Analysts in charge of developing energy efficient indicators also heavily rely on administrative sources. Data are usually free, or if not at a cost that is often much less than if surveys had to be launched to collect them. Data are readily available and usually administrative data are available on a regular basis.

The administrative data are then used either directly as numerators or denominators of some basic indicators, or indirectly to feed a model, or to help in designing a survey sample. Data are also used to validate results from surveys, or from modelling and metering programmes.

**Sources:** There is a large variety of potential sources of administrative data depending on the needs. Sources include the census, customs offices, various ministries,

utilities, companies, appliance manufacturers associations, retailers, meteorological organisations, academia, and regional and international organisations.

**Data collected:** Two main categories of data can be collected from administrative sources: activity data and consumption data. Activity data cover a wide spectrum of data: number of dwellings; characteristics of the dwellings; floor area; population; types of heating, cooling and water heating systems; appliances, etc. Energy consumption data cover overall sales or deliveries of electricity, natural gas and other fuels to the residential sector.

To be complete, a third category of data could be collected but cannot directly be used as a numerator or a denominator of any indicator. This category includes data, such as HDD and CDD, that are used to support or refine the indicators analysis, as inputs to models, or to validate indicators derived from other methods.

**Cost associated with administrative data:** In most of the practices received by the IEA, data were collected from administrative sources at no additional charge. However, when there is no direct cost, indirect costs are incurred from a number of steps needed: researching the existing administrative sources, discussing the feasibility of the data's use with the organisations collecting them, setting up agreements for data transfer and use, and finally transferring the data to a format suitable for use, because many data from administrative sources come either on paper or in a format difficult to exploit. Moreover, administrative sources are not always free and, in some cases, the cost to buy administrative data can be quite high.

**Main challenges:** The first challenge is related to the time spent entering the administrative data in a proper format (mainly from paper to digital) before use. The transfer and processing phase can be even more complicated in some cases because of problems of definitions (what does a certain data set cover exactly?). Confidentiality can also be an issue: companies, organisations and boards often have a lot of information available but the data are sensitive or companies may not want to release them to keep competitive advantages. National statistics offices could also be bound by law to keep some data confidential (e.g. if it is easy to identify company-specific data).

## Surveying .....

Surveys seem to be the most popular method used by countries when collecting the data behind energy efficiency indicators for the residential sector. One-third of the practices received by the IEA for this study are mainly based on surveys. However, the number of responses received might not be large enough to formalise this conclusion, and therefore this result should be used with some caution.

The next paragraphs draw on the answers from the practices received by the IEA and summarise the main characteristics from the practices. A detailed presentation of each practice is available in Annex D.

**Survey purpose:** The main purpose of a survey is obviously to collect all the energy consumption and activity data necessary to build the energy efficiency indicators needed for a study, an assessment or a policy. In terms of energy consumption, surveys usually target both total energy consumption (in energy units) of a household, and energy consumption by equipment or by end use and by type of energy. When these data are not available or when there is a need to complement them, one of

the objectives of the survey is also to collect energy expenditure of the household. Consumption can then be estimated from expenditure.

In terms of activity data, surveys target physical characteristics of dwellings (e.g. floor area, type of dwelling, age of dwelling), appliance penetration (by type) within households, and household occupancy characteristics such as age and number of people living in the household, income, etc. More detailed questions (on construction material, for instance) can also be added to the main questions in order to have a better idea of the thermal performance of the building.

**Sample design:** According to the study, the stratified random approach (sampled according to certain characteristics) is the most popular method used to design a sample. This approach is the most costly one, but it results in the best representation of the national population. Panel use of repetitive respondents is the second-most-popular approach.

Samples are usually designed based on a number of sources. The most common sources include the national census, lists from tax agencies or other existing surveys (such as labour surveys) and even lists of telephone numbers.

**Sample size:** One could say the larger the better, however the cost associated with the survey often leads to an optimization of the size of the samples. Moreover, besides the cost, there are other elements to consider when designing the size of the sample: variety of dwelling types, variety of climatic zones, level of details of information to collect, etc. Based on the results of the IEA study, there are two main groups of survey size: large surveys between 20 000 and 70 000 dwellings surveyed, or smaller surveys with fewer than 5 000 dwellings. The ratio of sample size to overall population varies from a few percent to 30%. However the ratio is not always meaningful since for a given sample size the ratio is obviously smaller in larger countries: for instance, 20 000 dwellings surveyed over a total number of dwellings of 200 000 represents a 10% ratio. This does not mean that 20 000 dwellings surveyed over a total of 2 000 000 dwellings (1% ratio) would be ten times less meaningful.

**Frequency:** There is no magic number to determine the ideal frequency of surveying. It depends on several elements: dramatic changes on a year-to-year basis, cost, close monitoring of efficiency programmes, etc. In half of the practices received by the IEA, surveys were conducted almost equally every year, every two years or every three years. For the other half, the surveys were conducted on an irregular basis and in some cases had only been conducted once. In order to monitor long-period trends and to reach higher quality estimates, it would be ideal to carry out surveys on a cyclical basis. Simplified “aggregated” surveys conducted every year combined with “detailed” surveys every two to five years also constitute a good option.

**Incentive for the survey:** In almost all the practices received, the surveys are not mandatory. Surveys are conducted on a voluntary basis and there are no fines for the respondents who refuse to participate. In many cases, there are incentives for participating such as free maintenance of some energy equipment, free audits, gift coupons, energy brochures, magnets with survey logos and even in a few cases some monetary incentives.

**Survey respondents:** In almost all the cases, the respondents are the households themselves. Additional information can also be obtained from other sources such as utility companies.

**Response rate:** As is frequently the case for response rates, there is a wide variation. However, most of the response rates observed are above 50%, and some of them reach an impressive 100%. It appears that placing a high importance on collecting data directly from the respondents (in-house versus by mail or by phone) increases the response rate.

**Collection methods:** The most popular method is in-house visits. The second preferred method is computer-assisted or Internet-based personal interview. Other methods include telephone interviews and paper forms sent by mail.

**Time to complete a survey:** There is a wide variability in the time spent to complete a survey, with extremes at 5-10 minutes and 90-120 minutes. The time depends on the number of questions and level of information requested; it also increases if a small audit is conducted and if energy-saving recommendations are provided to the households. The average time observed is around 40 minutes.

**Elements collected:** The list of elements collected depends for a large part on the purpose of the survey, the information that is already available from other sources and the time allocated for completing a survey form. The list includes dwelling characteristics (type of dwelling, floor area, age of the building, energy efficiency-related renovations, renewable equipment), number of people in the households, income, energy consumption and expenditure on energy. The list also includes more energy end use-oriented information: heating and cooling systems, water heating systems, cooking, type of lighting and number of fixtures, and identification of the main appliances. Other information such as energy suppliers, building audits and personal car utilisation can also be collected.

**End uses collected:** In most cases, all the main end uses are covered by the survey: space heating, space cooling, water heating, lighting, cooking and appliances. The details of appliances data collected differ on a case-by-case basis: large or white appliances (refrigerator, freezer, washing machine, dishwasher, clothes dryer) are often collected; audio and video equipment as well as personal computers and other small appliances are also often included in the end uses covered.

**Energy sources:** All traditional sources of energy (electricity, natural gas, heating oil, coal, fuelwood) are usually considered. In some cases, information on solar equipment (panels for domestic hot water, photovoltaic panels for electricity production), geothermal equipment and heat pumps is also collected.

**Questionnaires:** There is a wide variety of questionnaires from very concise to very detailed, from paper to Internet-based. There is no sample good practice questionnaire in the paper copy of this manual; however, there are examples of questionnaires linked to some of the survey practices described in Annex D, which are available on Internet.

**Overall time for preparing and conducting a survey:** It is extremely difficult to give precise figures on the overall time spent for preparing and conducting a survey and for preparing and disseminating the results, since it can largely vary from survey to survey. However, as a very rough indication based on the information received, the design phase of the survey takes around 4 weeks (with extremes ranging from 2 to 20 weeks), the execution of the survey takes around 20 weeks (it obviously depends on the size of the sample and the number of interviewers, with extremes ranging from 2 to 56 weeks), the processing of the data takes around 10 weeks

(with extremes ranging from 2 to 32 weeks), and the publication phase takes around 4 weeks (with extremes ranging from 2 to 10).

**Costs associated with the survey:** It is even more difficult to give precise figures on the cost of the survey. The cost depends not only on the size of the sample, the level of questions and the means to collect the data, but also on the labour costs in a particular country. In very broad terms, a survey costs between USD 100 000 and USD 1 million. However, some of the surveys reported in Annex D cost 10 times less or 10 times more. To give a rough idea of the respective shares of each phase, the design phase represents 15% to 20% of the overall cost, the data collecting phase 40% to 50%, the processing-analysis-reporting phase 20% to 30% and the overall management of the project 10% to 20%.

**Main challenges faced in surveying:** Two main types of challenges can be encountered when conducting the surveys: on the one hand, issues with the responses, and on the other hand, issues with the staff conducting the interviews. In terms of responses, the challenges most often faced deal with quality of the responses, completeness of the survey and consistency of the answers. Regarding staffing, the challenges concern the overall skills of the people in charge of interviews, the difficulty in recruiting experienced people, lack of training, difficulties in retaining good project staff and in some cases bias from the interviewers.

**Possible improvements:** Similar to the challenges faced in surveying, improvements encompass two main corresponding areas: the survey itself and the staffing. Regarding the survey, there are two areas for improvement: the questionnaire could be refined by using a simple format, clear definitions and more limited choices for questions with multiple answers; and the samples could be improved by selecting better sources, making more rigorous selection criteria and in some cases increasing the size. Pilot surveys could be organised to test both questions and interviews.

As regards staffing, recruiting experienced interviewers and giving them proper training appear to be key to the success of a survey. Hiring experienced market research companies to undertake the survey is seen as a possible solution to staffing issues.

Other recommendations include having a hotline between staff on the field and supervisors for providing direct assistance, and using computer-assisted personal interview tools.

## Measuring .....

Measuring approaches involve collecting specific energy consumption data within a dwelling perimeter using proper meters and measuring equipment. These methods are often established to complement existing national household surveys or to feed energy models. Due to the high cost associated with undertaking field measurements, these methods usually are applied on a much smaller scale than surveys. Nevertheless, they represent the most accurate approach that can complement existing household surveys and fuel models with occupant behaviour and energy consumption data.

The following description is meant to illustrate measuring practices received by the IEA, based on a smaller sample of practices than for surveying. Nevertheless, a few commonalities can be drawn for future measuring initiatives.

**Measuring purpose:** There are two main reasons for conducting measuring activities. One is that metering outputs are used for complementing existing household surveys or for better calibrating existing models — the most common reason. The other is that metering can also be a stand-alone practice for specific purposes, such as better understanding the reason for the increase in residential electricity demand, or monitoring standby energy consumption of appliances, in support of policy tracking or development.

The primary objectives of metering-measuring practices are therefore to better understand residential energy consumption patterns and to monitor the behaviour patterns of household occupants. These patterns could be monitored on an hourly, daily or monthly basis. Even if measuring is more targeted toward electrical equipment and appliances, measuring is also used for other energy sources and uses such as biomass for cooking.

**Sample design:** The administrative and cost burden is the main reason behind the need to reduce the size of the sample as much as possible; metering is therefore done on a much smaller scale than surveys. The sample design is often based on a random sampling approach. While some efforts are made to make small samples fit the national stratification (including climatic zones and type of dwellings), it is often technically difficult to establish this stratification due to the small size of the samples.

As for surveys, samples are derived from a number of sources, such as respondents of existing household surveys, lists of addresses, lists of households from the energy suppliers, or lists of telephone numbers.

**Sample size:** The size and design approaches are intertwined in the design process of a metering exercise. The size of the sample is usually very limited due to the cost associated with purchasing the monitoring equipment, the hiring of technicians who need to properly install and calibrate the equipment, and the management to ensure proper monitoring during the monitoring stage. Sample sizes are often between 400 and 600 households; this usually represents less than 1% of total households.

**Frequency of measurements:** In many cases, measurement campaigns are not conducted on a regular basis. In some cases, however, metering can be conducted on an annual basis or at longer, but regular, intervals. Measurements should be spread over the year to ensure that the seasonal variability of the corresponding energy consumption is well captured.

**Household monitoring period:** The length of time that a household is monitored is driven by a number of factors. Besides the cost, one of the key factors is to best capture not only the daily utilisation pattern of household end uses but also seasonal patterns such as winter and summer. Depending on the purpose of the metering exercise, monitoring periods can widely vary, ranging from half a day to six years of continuous monitoring. As a consequence, the overall length of a project can also vary from a few months to a few years.

**Who took measurements and how:** Measurements are taken either by energy auditors or by households themselves. In fact, energy auditors or specialised technicians usually carry out an overall initial household assessment (type of dwelling, construction material, level of insulation, appliances) and then, once the electricity-consumption monitoring equipment is installed, household occupants take over the management of the measuring.

Measuring equipment often includes electricity meters since, in most cases, metering targets electricity consumption. However, the type of equipment used is not only limited to electrical equipment. An example is in countries that rely primarily on biomass for cooking, where basic weighing scales are used for estimating the consumption of fuelwood or charcoal.

**Energy end uses measured:** Appliances are the main targets for metering programmes in households. Measuring appliances allows a better understanding of energy consumption patterns: frequency, time and length at which they are operated, and the amount of energy consumed. The list could include a wide range of large appliances, audio-video equipment, and personal computers and small appliances. Besides appliances, other main end uses such as space heating, space cooling, water heating, lighting and cooking can also be monitored and measured.

**Energy sources being measured:** Because it is mostly consumption patterns of appliances that are being monitored, electricity is the main energy form measured. However, other energy sources such as natural gas and fuelwood can also be measured.

**Cost of measurements:** It is not easy to give precise figures for the cost of measurements, since the cost depends on many factors including the details of information to be collected, the cost of equipment and labour needed to install the equipment, the length of the measurement campaign and the number of households measured. As a first degree of estimation, the measuring cost could run anywhere from USD 150 to USD 2 500 per unit sampled. Consequently, it is equally difficult to give a meaningful estimate for the overall cost of a measuring programme; the cost may vary by a factor of 10 and range between USD 100 000 and USD 1 million.

**Main challenges:** There are a number of problems associated with undertaking measurement, ranging from gaining access to households for installing meters to having properly calibrated and functioning equipment.

Regarding access to households, auditors who have been asked to obtain measurements from a household may have difficulty entering the residence. When the equipment is installed, the quality and ability of auditors to properly calibrate them might be another difficulty.

Other challenges include the maintenance of the equipment, the large volume of data to be collected and the way data are transferred to a centralised system for processing.

**Recommendations:** A wide spectrum of recommendations can be taken from the practices received when preparing this manual. They range from the preparation of the sample to data transfer.

When designing the sample to be measured, even at a small scale, a key recommendation is to collect measurements based on a stratified random sampling approach integrating various elements such as climatic regions and types of dwellings.

Before investing in the metering equipment, it is important to compare a number of options and to ensure quality of the measurements by talking to others who have used the equipment and directly to the manufacturer. A quality control check should be established before measurements commence to ensure data are collected flaw-

lessly and are error-free. In order to collect lighting data, simple on/off detection equipment could be used as an economic alternative.

Once the equipment is installed, regular checks should be performed to ensure that it is operating properly. In areas where electricity is used for heating, outdoor temperatures should be collected each day of the metered period to determine the outdoor temperature impact on heating demand for a given household.

For data transfer, it is recommended that data are directly transferred from meters to a spreadsheet, a database or a model, to avoid hand-typing of the data and consequently potential errors.

**Key best practices:** Launching an information campaign ahead of field measurements facilitates the participation of households in a metering project. Campaigns can be run by various entities such as energy utilities, city halls or universities. To further ease participation, households can be offered a free audit to identify potential areas for energy savings as well as financial incentives.

In terms of data capture and transfer, wireless transfer to a centralised data centre at regular and short intervals smooths the processing of data. In the case of missing data, sophisticated interfaces can also provide estimates based on various elements and patterns.

## Modelling .....

Modelling can be seen as the cement between surveying, metering and administrative sources. Modelling often serves as a framework for consolidating different administrative and non-administrative sources such as surveys, tax-based information, sales data, dwelling construction and demolition data, technology efficiency assumptions, and HDD data. Models are used for a variety of objectives: estimating energy consumption patterns based on various assumptions and data; building load curves; estimating energy consumption over a day, week and year; comparing competing energy sources for specific end uses; or forecasting.

**The whole modelling process usually follows a four-step approach:** Firstly, developing the model's framework, then populating the model with data and assumptions, validating modelling results, and lastly analysing the model's outputs. Once a model has been developed and tested for many cycles, the first step is usually very limited when running a new cycle, except in case of additions, changes and new modules. Based on the practices received by the IEA, the next paragraphs summarise why countries and organisations use models, what types of models are used, inputs and outputs, challenges, and other useful information on modelling for households.

**Model purpose:** Models are mainly used to estimate energy consumption of households at the national level. Models can have more specific purposes such as estimating household energy consumption at the regional level, as well as estimating diffusion of appliances and building household energy load profiles. Models are essential for consolidating historical time series on end uses and can be used to build energy projections and scenarios.

**Model type:** In most of the cases, models are bottom-up, using either a statistical bottom-up or an engineering bottom-up approach. Bottom-up simply means that model inputs are disaggregated at the end-use level. Engineering bottom-up models



can be more technical and include technology-level information such as life cycle and cost, and could even assume technology evolution.

When sufficient end-use level information is lacking, modellers rely more on a top-down approach based on macro- and micro-economic elements as well as studies and research linking various variables, such as disposable income and household spending and energy consumption. These models are usually regression-based econometric models and analysis.

**Source of the model:** For bottom-up models, most models are custom-built and tailored to desired tasks, based or not on existing user-friendly software packages. For top-down models, models are usually based on existing econometric software. However, additional elements are often needed for running the model and later for the analysis.

**Validation of modelling outcome:** A majority of the outputs from modelling are usually validated against a reference data set. At the national level, validation of energy consumption trends is done against existing national energy statistics such as energy balances, energy sales data, and regional and national surveys and studies. The validation process with the national time series is essential since it often leads to a better calibration of the model.

**Cost and time:** The more sophisticated the model is, the longer it takes to develop it. The more data are needed, the longer it takes to gather and enter this information. As a consequence, it is extremely difficult to estimate the time for developing and running a modelling project. Based on information received from the IEA survey, the time to develop a model ranges anywhere between 2 and 50 weeks. Similarly, updating the modelling inputs and adding new assumptions also take anywhere between 2 and 45 weeks. The length for the verification and analysis process also dramatically varies according to the level of sophistication of models and inputs needed. Basic models could only require 1 to 2 weeks while large models could take much more, up to 40 weeks. As a consequence, there is a wide spectrum for overall modelling time periods: from one month to two years. As a general note, it seems that top-down and macroeconomic models that rely on existing macroeconomic software take much less time (around four weeks) for adjusting, running and processing.

It is equally difficult to provide an idea of the cost for developing and operating a modelling programme because it widely depends on the level of sophistication and details of the model itself as well as on the labour costs in a country. Furthermore, for several practices received, costs are not mentioned. Based on the information received, the cost could range between USD 800 per week and USD 6 000 per week.

**Frequency:** There are two types of modelling programmes in terms of frequency. The first group includes those carried out or updated on a regular basis every one to two or three years. In case of longer intervals than a year, the frequency could be linked to national household surveys, and modelling is used to make estimates for the in-between years. The second group includes modelling projects done only once for a specific purpose or without a regular cycle.

**Key model inputs:** Key model inputs vary depending on whether the model is a top-down model only, a bottom-up or a mix of both approaches. Inputs can be also driven by the availability of existing data from surveys and administrative sources.

When data are not readily available from existing national sources, they could be estimated from existing published documents such as technical journals or reports.

For pure top-down models, key inputs could include variables such as household occupancy, energy supply data and energy prices. Some macroeconomic variables such as household income, disposable income, demography, and CDD and HDD data could be also integrated.

On the other hand, a bottom-up model could include more detailed information such as the heating system used in a household including average efficiency rate, system of distribution, cooling system technology, water heating system, diffusion of household appliances by type of appliance, type of lighting, building type information such as distribution of building types by region and age, demolition and construction rates by region, household occupancy rates, and any macroeconomic variables.

**Key model outputs:** Modelling outputs closely follow the primary purpose of the modelling, which usually is to estimate household energy consumption at the national level together with the breakdown of end-use energy consumption. Outputs therefore include space heating and cooling, water heating, energy consumption of large appliances, electronic devices, and lighting. Some models go a step further and estimate seasonal energy requirements and energy demand based on regional energy requirements.

**Main challenges:** The biggest obstacle for developing a model is undoubtedly the lack of input data for the model. Closely linked to it, the second main obstacle is the challenge to make meaningful assumptions in the absence of data. Other challenges include a wide range of issues such as quality of available data, lack of good model documentation, oversimplification and multi-colinearity (i.e. two or more variables being highly correlated).

**Key best practices:** Modelling is a never-ending learning experience, so it is recommended to use the same model for a long period of time. The investment cost to first develop a model can be quite high; payback will therefore increase with the number of times and years a model is run. This does not mean that improvement cannot be made; on the contrary, a model is live and modifications, additions, new modules (geographical information system, for instance) and improvements are certainly a must for keeping track of changes, developments and new needs, for example potential renewable energy resources.



# Collecting What and How for the Services Sector

## 1 What does the services sector mean and cover?

The services sector refers to the “Commerce and Public Services” in the United Nations International Recommendations on Energy Statistics; it is also referred to as the tertiary sector. It covers a large number of economic activities, which can be private, public or a combination of the two. Activities are grouped into the following main categories: offices, retail space, public administration, health care, education, warehousing, food service and sales and lodging, arts, entertainment, and recreation. Each main category may cover a number of different subcategories, with different energy characteristics; for example, within food sales and lodging, restaurants and hotels should be treated separately, as they have different patterns of energy consumption for the various end uses. Annex B describes the boundaries of the services sector, as addressed in this manual, in relation with the International Standard Classification of all Economic Activities.

Key end uses of the services sector are space heating, space cooling, water heating, lighting and other equipment. They follow the same end-use breakdown as in the residential sector except for cooking. Across categories, the relative importance of the different end uses varies a lot. For example, hotels tend to use much more energy for water heating than offices, hospitals tend to use much more energy for space heating than warehouses, etc.

The heterogeneity of the sector is also linked to the large variety of buildings, from small grocery shops to skyscraper headquarters of multinational companies. Each building has a unique design, and the end uses provided in the services sector, such as heating and cooling, or lighting, are custom designed for most buildings, driven by local building code requirements. For energy efficiency purposes, the services and residential sectors are sometimes considered together to form the broader buildings sector.

As with the residential sector, consumption of transport activities related to services, such as municipal buses, intercity trains, or other transportation modes for transporting people and goods, should be excluded and reported under the transport sector. Also, energy consumption of military establishments is not included in the service sector indicators.

## Questions and Answers:

### Q1. *Is there a difference between the services sector and the buildings sector?*

*Yes, there is. For energy efficiency purposes, it is common to aggregate the consumption in buildings of the residential and services sectors together into what is called the buildings sector. Non-building consumption, such as street lighting, which is part of services, is not included in the buildings sector, but it is included in the services sector under “other energy use”, as shown in Figure 3.4.*

### Q2. *How does one account for vacant offices?*

*Efficiency indicators using floor area as activity data need to be computed based on the effectively occupied space. Due to fluctuations in economic activity, some office spaces may become vacant at certain times.*

*Some surveys of the building sector can provide such information, although they are not likely to be on an annual basis. One alternative approach could be to rely on national real estate agencies that keep track of vacancies within buildings.*

### Q3. *Where should offices in private buildings be included?*

*Some people use part of their dwelling to host a professional activity, for instance a doctor receiving patients in a practice inside his/her dwelling, or a shopkeeper whose shop is inside the dwelling. Technically speaking, any energy consumption for professional purposes should be excluded from the dwelling consumption and allocated to the services sector, in the relevant category. In most cases, this is not easy since there is often only one electrical meter, or the heating system is common to both activities. The service consumption should be estimated depending on the relative weight of the consumption for the professional activity, as a prorated consumption based either on the floor area or on the occupancy rate.*

## 2 Why is the services sector important?

Although in 2011 the services sector accounted for only 8% of the global total final consumption (TFC), its energy consumption grew over the last twenty years by around 40% in member countries of the Organisation for Economic Co-operation and Development (OECD) and more than doubled in the non-OECD countries.

The importance of the services sector varies a lot across countries, as shown in Figure 5.1, ranging from a few percent to up to 20% for most countries. As is the

**Figure 5.1 • Share of the services sector in the total final consumption of selected countries (2011)**

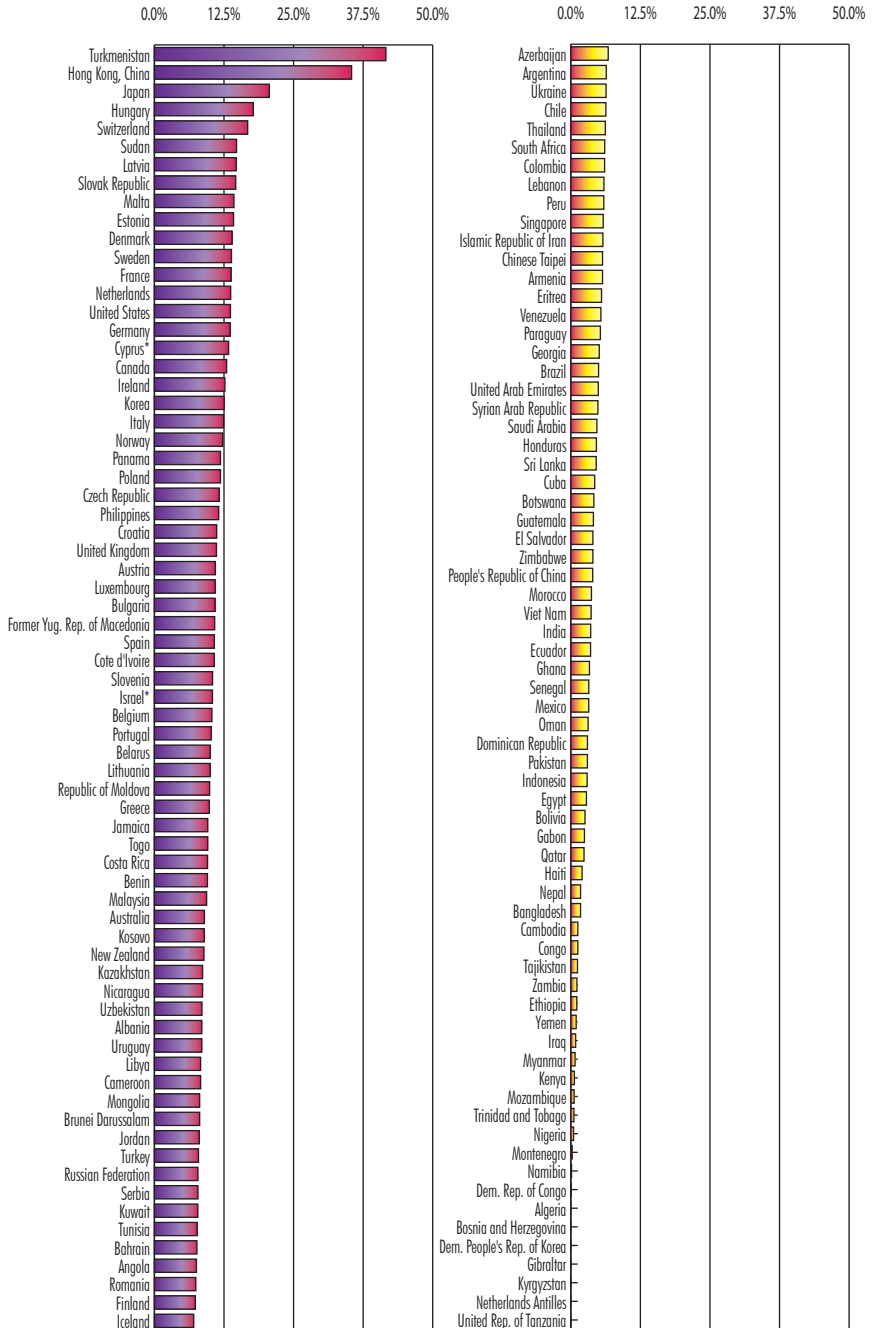

Note: unless otherwise indicated, all tables and figures in this chapter derive from IEA data and analysis.

\* See Annex F.

case in the residential sector, data quality varies across countries, and these data should be used with caution as a preliminary indication of the relative weight of services in TFC. Given their generally poor quality, data for services would greatly benefit from improvement even at the level of total consumption within energy balances. Often, consumption for services is not available or is aggregated with that of residential, as is visible here for the group of countries that show a share of 0%. Where more reliable data are available, the importance of the services sector varies from countries with a very structured service sector, such as Hong Kong, China (36%), to countries where the services sector accounts for only a few percent of final consumption as it is much less developed – or more informal – and/or the industry sector is well developed.

As the share of the services sector energy consumption in TFC varies widely from country to country, so do the respective shares of energy sources consumed in this sector. Globally, the services sector accounts for about 8% of the total final energy consumption, but it accounts for almost a quarter of electricity, 14% of natural gas and 3% of oil TFC. These shares are not representative of all countries. For example, in Hong Kong, China, where the sector is very developed, it accounts for about two-thirds of the electricity TFC, while in People's Republic of China, where industrial consumption of electricity is playing a much larger role, only 7% of electricity is used in the services sector. The services sector does not use natural gas in many countries, but accounts for about half of the gas TFC in Japan, about a quarter in the United States, and 17% in the European Union.

**Figure 5.2 • Share of the services sector in the world total final consumption for selected energy sources (2011)**

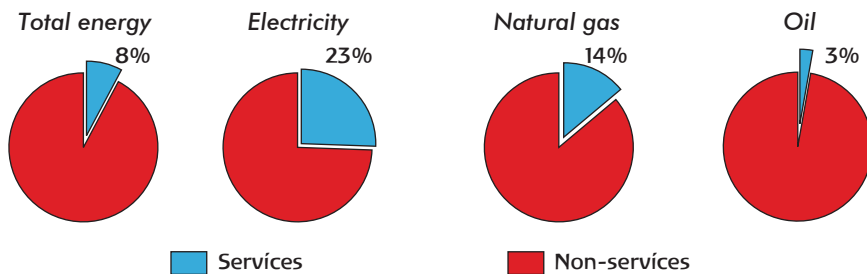

As shown in Figure 5.3, electricity has become the most important energy source for the services sector, accounting for half of its consumption in 2011, up from less than 20% in 1973. This mainly reflects the impact of the penetration of space cooling and electrical devices, such as lighting and office equipment in services buildings. Over the same period, reliance on oil products and coal has been significantly decreasing from nearly two-thirds to about one-sixth. It is expected that renewable sources will substantially increase their share in the future.

Energy use in services relates to a number of factors, such as the level of economic activity, geographic and climatic conditions, energy prices, and cultural factors. Understanding the services sector presents significant challenges due to the generally limited data coverage and the complexity of its heterogeneous building types and service categories. Therefore, the relative importance of the various activities and building types will have a direct impact on the overall consumption of the sector.

**Figure 5.3 • Share of various energy sources in the world services energy consumption**

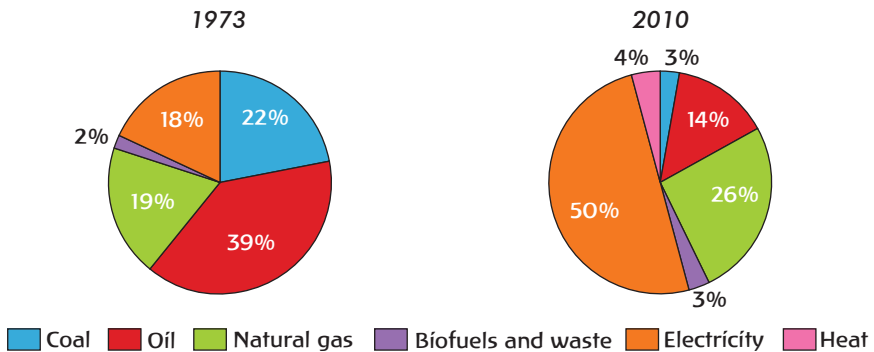

Due to gaps in data, the services energy consumption is currently often calculated as a residual, i.e. as the difference between total energy consumption and the combined consumption of other sectors, namely residential, industry and transport, for which generally better data exist. Strengthening data collection for this sector will help to identify potential areas to implement energy efficiency policies, which in the longer term would reduce energy demand, especially for electricity.

However, it is not only policy makers who should be interested in efficiency indicators in the services sector. As in the case of the residential sector, many other players can influence energy consumption in the sector: building owners and tenants to minimise their bills; architects designing more efficient buildings (or retrofitting older ones); energy service companies to maximise their profit in minimising energy consumption; and utilities to reduce the impact of services use on peak and load curves.

### 3 What are the main end uses driving the consumption of the sector?

As mentioned in the first section, the energy end uses in the services sector can be aggregated into five main categories: space heating, space cooling, water heating, lighting and other equipment. Each of these end uses is briefly described below, though the list and descriptions are by no means exhaustive.

- **Space heating:** Space heating systems can be central or distributed. Services buildings are often equipped with central heating, ventilation and air-conditioning (HVAC) systems that heat rooms based on forced air, floor heating, or water heating. Space heating technologies may include furnace systems, boiler systems, external district steam or hot water systems, geothermal devices, co-generation<sup>1</sup>, heat pumps, solar panels or greenhouses, etc. Heating systems may use a number of energy sources, such as electricity, natural gas, coal, fuel oil, liquefied petroleum gas (LPG), kerosene, biomass, and active or passive solar energy.
- **Space cooling:** Central or room-based cooling systems are used to regulate the indoor temperature in warmer months. Cooling systems include: packaged air-conditioning systems (which could also be used for heating), individual room

1. Co-generation refers to the combined production of heat and power.



air-conditioning units, heat pumps that cool the area by ejecting heat (or the reverse during the heating season), district chilled water, e.g. from a nearby body of water, and central chillers that produce chilled water to cool the air. Most of the cooling systems in the services sector run exclusively on electricity.

- **Water heating:** Hot water can be used for personal needs of building occupants, as well as for activity needs (e.g. in restaurants). Water is generally heated by boilers in a system that sometimes could also deliver space heating at the same time. The main energy sources used for water heating include natural gas, gas oil, LPG, biomass, electricity and increasingly, solar thermal energy.
- **Lighting:** Lighting is one of the key end uses of the services sector, and it is mainly powered by electricity. Interior and exterior lighting fixtures include: incandescent lighting, fluorescent lamps, high-intensity discharge lamps, compact fluorescent light bulbs, and solid state lighting, using semi-conducting materials such as light-emitting diodes (LEDs) and organic LEDs. Other energy sources, such as kerosene, are still used to provide lighting where access to electricity is limited. Their share is expected to decrease over time. New sources, such as solar photovoltaic panels, have begun to penetrate the market, and their share is expected to increase in time.
- **Other equipment:** Other equipment includes a large variety of end uses and varies depending on the type of business activity or service category. It may include office equipment (servers, printers, photocopiers, fax machines, lifts and other), commercial refrigerators, food preparation equipment, commercial laundry equipment, automated bank machines, etc.

Due to a lack of data for end uses in many countries, it is not possible at this stage to give a representative world average share for the consumption of each end use. However, although far from being representative for the world, Figure 5.4 gives the breakdown of the services consumption by main end-use category for five OECD countries for which end-use data are available; water heating is included in other end uses.

**Figure 5.4 • Breakdown of the services consumption by end use for a selection of five OECD countries\***

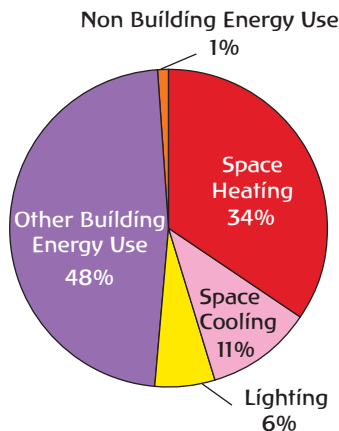

\* Selected countries based on data availability: France, Italy, Japan, Korea and New Zealand. The weight of Japan in total consumption of the five countries might impact the average respective end-use shares.

## 4 What are the most frequently used indicators?

Depending on the availability of data, one can build very disaggregated indicators, or stay at a level that is too aggregated to be meaningful for energy efficiency analysis. The most aggregated indicators include, for instance, the share of the services sector in TFC or the overall services consumption per value added or per floor area. If these indicators allow very rough comparisons among countries (however often misleading) and over time, they cannot be considered indicators of energy efficiency as such. For meaningful energy efficiency indicators, more disaggregated energy and activity data are needed, as described in the following section for each of the main five end uses identified earlier.

Similar to the residential sector, for the overall services sector, as well as for each of its end uses, indicators can be defined using a pyramidal approach from an aggregated level (for instance, the share of space heating in total services consumption) to very disaggregated indicators (for example, for each type of heating system, space heating consumption per floor area). The wider the pyramid, the more detail required. Three levels have been used in this pyramidal approach, level 1 being the most aggregated one, and level 3 being the most disaggregated one. Moreover, for reasons of simplification, short three-character code names have been given to each indicator to identify the end use and the level of the indicator.

Indicators starting with an **S** relate to the **S**ervices sector, with an **H** to **H**eating, with a **C** to **C**ooling, with an **L** to **L**ighting, with a **W** to **W**ater heating, and with an **E** to other **E**quipment. The number that follows relates to the level of disaggregation, 1 being the most aggregated and 3 the most disaggregated. The main function of the third character, a letter, is to differentiate indicators of same end use and same level. As an illustration, indicator (**L2b**) is an indicator of second (2) level of disaggregation for lighting (**L**) (in that particular case, lighting consumption per floor area). In the pyramids for each end use, the recommended indicator for that end use is shown with a smiley face (☺).

### Total services sector .....

As in the residential sector, the pyramid for the services sector is based on aggregated data, both for energy and for activity.

The most aggregated level refers to the overall consumption of energy for the services sector expressed either in absolute terms or in percentage of TFC (S1a), and to the share of each energy source in the total services consumption mix (S1b). These two indicators, although not intensities, provide a high-level picture of the sectoral consumption, and could allow a first comparison across countries.

At the intermediate level, level 2, the pyramid shows two indicators for the overall sector, computed by dividing the sectoral energy consumption, generally available at the national energy balance level, by value added (S2a) and floor area (S2b), respectively. These two indicators are of course largely influenced by the relative weights of the different categories within the sector. For example, wholesale trade buildings tend to have a smaller consumption per floor area than hotels; hospitals tend to have a larger consumption per value added than financial offices. Because

of the weight of heating and cooling, the consumption per floor area is also largely affected by weather and climate conditions.

**Figure 5.5 • Pyramid of services indicators**

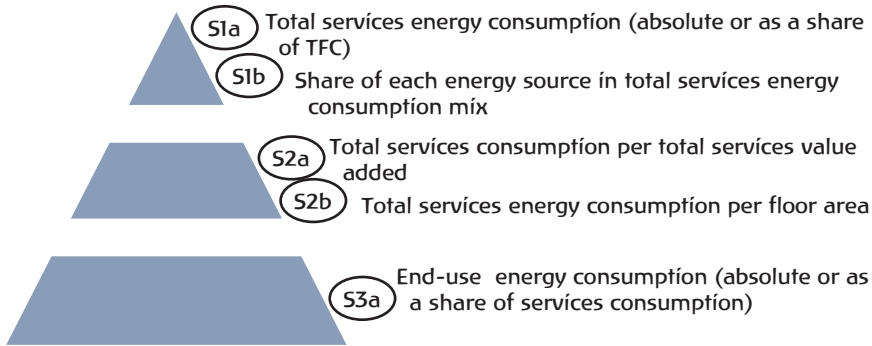

\* Note that this disaggregation applies to the total sector, as well as to each of the service categories (e.g. hotels, restaurants, hospitals, etc.).

The third level of the pyramid refers to the energy consumption of each end use, as a total or as a share of the service consumption (S3a). This third level corresponds to the top level of each of the various end-use pyramids described in the following sections.

This pyramid, presented for the services sector as a whole, could also be applied to each of the individual categories of the sector, such as hotels, restaurants, etc., taken independently. In this case, at the second level of the pyramid, a third indicator could be added: energy consumption per unit of activity of the given category. As shown in Table 1, units of activity vary across service categories. For example, for hotels they could be the number of nights. In this case, the three indicators at the second level would be the total consumption of hotels per floor area, per value added, and per number of nights.

Given the very different nature of the various categories, an analysis by category would provide more comprehensive and accurate information to assess the overall efficiency of the sector, and to identify the areas for possible efficiency improvements. The potential for such analysis is however mostly limited by a general lack of availability of the disaggregated data needed.

**Table 5.1 • Examples of categories within the services sector and respective units of activity**

Service category	Unit of activity
Schools	Number of students, number of occupants
Hospitals	Bed capacity, number of occupied beds
Hotels	Number of rooms, number of nights, number of employees, floor area
Restaurants	Number of meals
Offices	Number of employees, floor area
Retail	Number of employees, floor area

## Space heating

As with the residential sector, depending on the availability of data and on the purpose of the analysis, space heating can be described by a variety of indicators.

**Figure 5.6 • Pyramid of services space heating indicators**

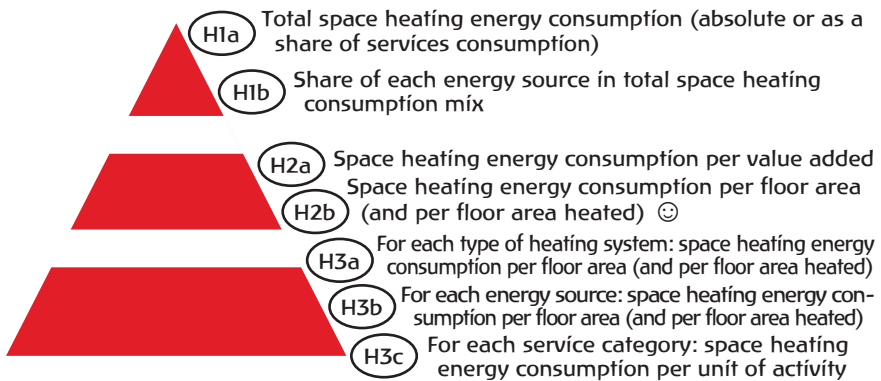

At the first level, the top-level indicator (H1a) is the overall consumption of services space heating, expressed either in absolute terms or in percentage of the total consumption of the sector. Even though this is not an indicator of efficiency, it does provide a first indication of the absolute and relative weight of space heating in the total services consumption. It can be used to assess whether space heating could be relevant in terms of potential energy savings.

The second indicator of level 1 (H1b) is the share of each energy source in the total heating consumption mix. Once again, even though not an actual indication of efficiency, this indicator describes the relative reliance on various fuels in heating energy consumption.

The second level shows two indicators of energy efficiency: space heating consumption per value added (H2a) and per floor area (H2b). If a significant number of buildings is not heated, it is recommended that the second indicator be built based on the floor area heated. **As in the residential sector, the recommended indicator is space heating consumption per floor area.**

At the third level is the space heating consumption per floor area for each type of heating system (H3a) and for each energy source (H3b), as well as the space heating consumption per unit of activity for each service category (H3c).

There could be other levels of indicators, beyond the scope of this manual due to their demand for further detail of data and low feasibility in the near term – for example, those based on the average age of buildings, reflecting the degree of penetration of new and more efficient structures in the building stock.

*Note: Regardless of the level of indicators considered, it is recommended to adjust the space heating consumption for annual temperature variations, to compare the situation for different years. The best way to make this adjustment is the use of heating degree days (HDD), as explained in Annex C.*

## Space cooling

With the development of space cooling in buildings, energy efficiency indicators on cooling are becoming more and more important. However, they present more challenges than those for space heating, mainly due to a) the difficulty of isolating the consumption of electricity for cooling from the overall electricity consumption, b) the intermittent use of cooling over days and nights, and c) the smaller share of buildings with space cooling.

The space cooling pyramid resembles that for space heating, with the difference that cooling is mainly powered by electricity, although district cooling from a number of sources may develop significantly in the future.

Figure 5.7 • Pyramid of services space cooling indicators

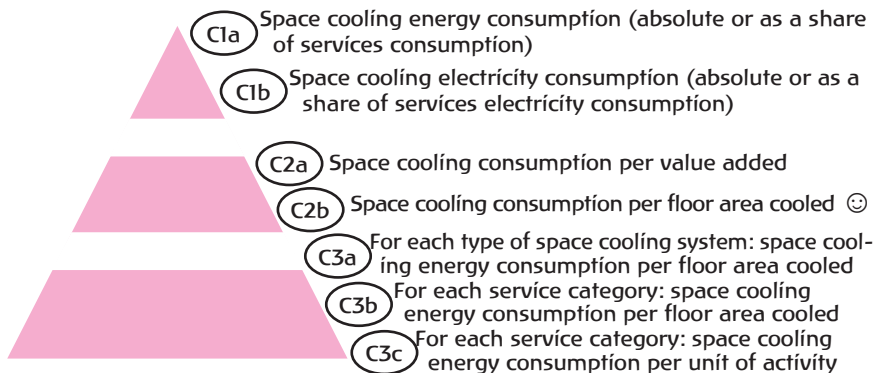

The top indicator of the first level (C1a) describes the overall consumption of services space cooling, expressed either in absolute terms or in percentage of the total consumption of the sector. Even though this is not an indicator of efficiency or intensity, it does provide a first indication of the absolute and relative weight of space cooling in the total services consumption, to assess whether space cooling could be relevant in terms of potential energy savings.

The second indicator of level 1 (C1b) is the overall space cooling electricity consumption (expressed either in absolute values or as a share of total services electricity consumption). It can be considered a meaningful indicator, as electricity is by far the main energy source used for cooling.

The second level shows two indicators of intensity based on space cooling consumption per value added (C2a) and per floor area cooled (C2b). **Similar to the residential sector, the preferred indicator is space cooling consumption per floor area cooled (C2b).**

As the information for space cooling per floor area cooled is very relevant, the third level offers the same indicator of space cooling consumption per floor area cooled, stratified according to two methods: for each type of cooling system (C3a) and for each service category (C3b). A third indicator (C3c) refers to the space cooling consumption per unit of activity for each service category. Another indicator, cooling consumption per floor area cooled for each energy source, could be developed in time if the penetration of gas systems, solar cooling or even district cooling becomes significant in the services sector.

Note: Similar to the need to apply a HDD correction for space heating, it is recommended to apply a cooling degree days (CDD) correction to normalise the space cooling energy consumption pattern over time by removing the effect of temperature variations. See Annex C.

## Water heating .....

Water heating needs may vary widely driven by the type of service category. For example, hospitals, hotels and food services are likely to use greater volumes of heated water than information-based services.

As with the previous end uses, the first level shows the energy consumption of water heating, absolute or as a share of the total services consumption (W1a), and the share of each energy source in it (W1b).

**Figure 5.8 • Pyramid of services water heating indicators**

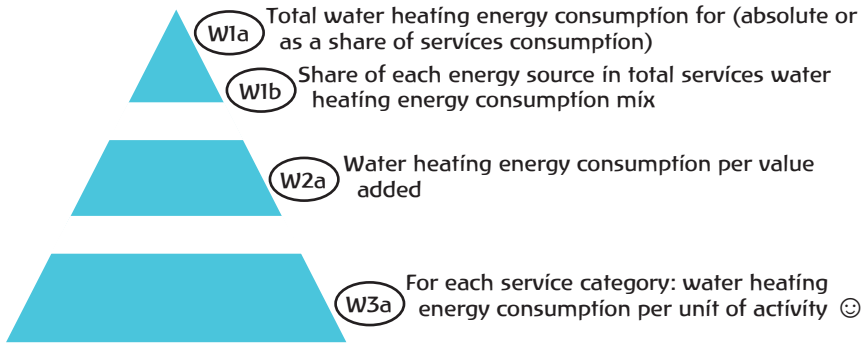

At the second level, the indicator shown is the water heating consumption per value added (W2a). Similarly to other end uses, an indicator of consumption per floor area could be computed also for water heating, although the value could be misleading. Therefore, that indicator is not proposed in this pyramid.

The third-level indicator is water heating consumption per unit of activity for each service category (W3a). For example, this would be water heating consumption per number of nights in hotels, or per number of beds in hospitals, etc. **Water heating consumption per unit of activity for each service category is the recommended indicator for water heating**, although it would require significant effort in data collection. It would be possible to also compute, at a further level of disaggregation, an indicator of energy consumption per unit of activity for each water heating system, such as direct or indirect boiler systems, solar collectors, etc., computed for each services category. This indicator would however require a very detailed level of information, so it is not included in the proposed pyramid.

## Lighting .....

The first level presents the total lighting consumption, in absolute terms or as a share of services consumption (L1a), and the lighting consumption as a share of the services electricity consumption (L1b), as lighting is mainly powered by electricity.

At the second level, two indicators of intensity are presented, based on lighting consumption per value added (L2a) and per floor area (L2b).

Figure 5.9 • Pyramid of services lighting indicators

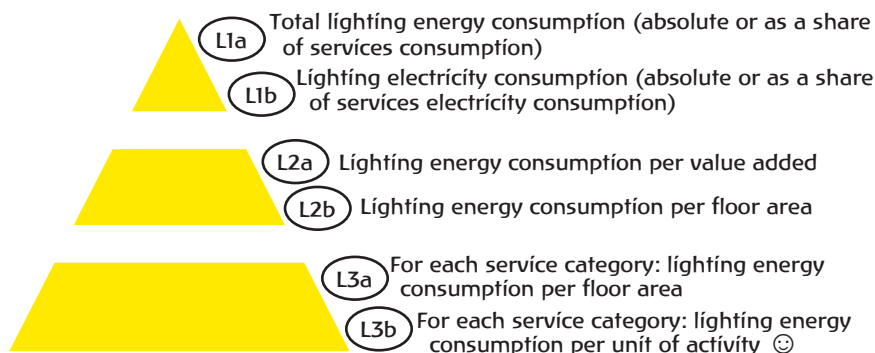

Similarly, the third level presents two indicators computed for each service category, as lighting consumption per floor area (L3a) and per unit of activity (L3b). **Lighting energy consumption per unit of activity for each service category is the recommended indicator for lighting**, although it would require significant effort in data collection.

## Questions and Answers:

### Q4. Where should street lighting be accounted for?

Although not included within the building sector, energy consumption for street lighting is included under the services sector (in the category “other energy use”, as shown in Figure 3.4). A set of indicators could be developed for street lighting separately from those for the end uses shown in the previous pyramids, for example relating energy consumption to the surface area lighted (including roads and parking lighting).

## Other equipment .....

Other equipment is very heterogeneous across categories. For instance, restaurants make limited use of computers but extensive use of fridges and ovens; offices use extensively computers and printers but very rarely ovens. The first level presents the total other equipment consumption, in absolute terms or as a share of services consumption (E1a), as well as the share of each energy source in the total other equipment mix (E1b).

At the second level, two indicators are presented, based on other equipment consumption per value added (E2a) and per floor area (E2b).

The third-level indicators are other equipment consumption per value added, for each service category (E3a) and other equipment consumption per unit of activity for each service category (E3b). As diffusion of the different types of equipment varies significantly across categories, (E3b) would include a number of very significant indicators,

such as the energy consumption of personal computers per number of employees for offices, or the energy consumption of refrigerators per unit meal served for restaurants, etc. **Consumption per unit of activity for each service category is the recommended indicator for other equipment**, since more aggregated indicators have a more limited meaning, given the heterogeneity of the sector. Of course, such level of detail would require significant effort in data collection that should be made only if the analysis indicates that other equipment represents a large share of total energy consumption.

**Figure 5.10 • Pyramid of services other equipment indicators**

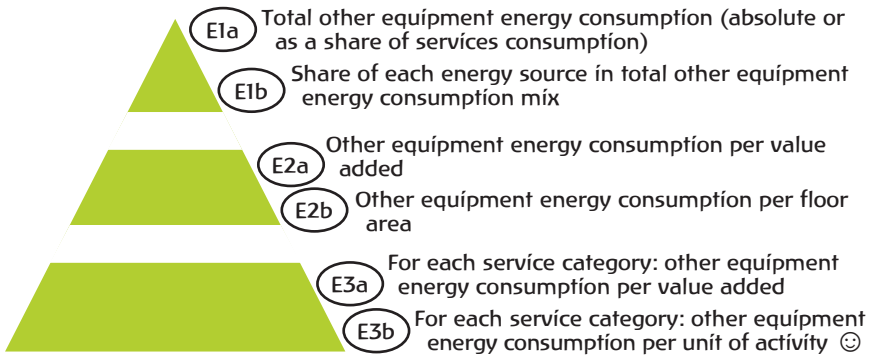

Table 5.2 summarises the main indicators used for the services sector excluding the indicators of level 1, which are not real indicators of energy efficiency or even of energy intensity; these indicators show only the absolute or relative importance of an end use in the sector mix or the total energy mix.

For each indicator of levels 2 and 3, the table gives the name, its coverage (overall or by specific type), the energy data, and the activity data to be used. The next-to-last column gives the code number for the indicator, and the last column uses a smiley face to note that the indicator is the preferred indicator for a particular end use.

## 5 The data behind the indicators

The key data needed for the indicators of the various levels presented in the previous sections are summarised in Figure 5.11, for energy consumption, and Figure 5.12, for activity data. For the overall sectoral pyramid, aggregated energy data can often be derived from a country’s energy balance, and aggregated activity data can come from a variety of sources, such as the census, etc. (Table 5.3). The key in establishing services indicators is to ensure that boundaries and definitions of energy and activity data match.

### The energy consumption data .....

#### Space heating consumption data

**Total space heating consumption:** This is the total energy used to heat all services buildings. It includes all types of energy (electricity, natural gas, biomass, etc.) and all types of heating systems (central or distributed). This consumption is used as numerator for the indicators (H2a) and (H2b).



Table 5.2 • Summary list of the most common indicators for services

Indicator	Coverage	Energy data	Activity data	Code	Recommended indicator
Space heating energy consumption per value added	Overall	Total heating energy consumption	Total value added	H2a	
Space heating energy consumption per floor area	Overall	Total heating energy consumption	Total floor area	H2b	☺
	By heating system	Heating energy consumption with system $\alpha$	Floor area heated with heating system $\alpha$	H3a	
	By energy source	Heating energy consumption with energy source Z	Floor area heated with energy source Z	H3b	
Space heating energy consumption per unit of activity	By service category	Heating energy consumption for service category A	Unit activity of service category A	H3c	
Space cooling energy consumption per value added	Overall	Total cooling energy consumption	Total value added	C2a	
Space cooling energy consumption per floor area cooled	Overall	Total cooling energy consumption	Total floor area cooled	C2b	☺
	By space cooling system	Cooling energy consumption by cooling system $\alpha$	Floor area with cooling system $\alpha$	C3a	
	By service category	Cooling energy consumption for service category A	Floor area cooled of service category A	C3b	
Space cooling energy consumption per unit of activity	By service category	Cooling energy consumption for service category A	Unit activity of service category A	C3c	
Water heating energy consumption per value added	Overall	Total water heating energy consumption	Total value added	W2a	
Water heating energy consumption per unit of activity	By service category	Water heating energy consumption for service category A	Unit activity of service category A	W3a	☺
Lighting energy consumption per value added	Overall	Total lighting energy consumption	Total value added	L2a	
Lighting energy consumption per floor area	Overall	Total lighting energy consumption	Total floor area	L2b	
	By service category	Lighting energy consumption for service category A	Floor area of service category A	L3a	
Lighting energy consumption per unit of activity	By service category	Lighting energy consumption for service category A	Unit activity of service category A	L3b	☺
Other equipment energy consumption per value added	Overall	Total other equipment energy consumption	Total value added	E2a	
	By service category	Other equipment energy consumption for service category A	Value added of service category A	E3a	
Other equipment energy consumption per floor area	Overall	Total other equipment energy consumption	Total floor area	E2b	
Other equipment energy consumption per unit of activity	By service category	Other equipment energy consumption for service category A	Unit activity of service category A	E3b	☺

■ Heating    ■ Cooling    ■ Water heating    ■ Lighting    ■ Other equipment

**Total space heating consumption using heating systems of type  $\alpha$ :** This is the total energy used to heat all services buildings using a certain type of heating system or equipment: central heating, district heating, etc. This consumption is used as a numerator for the indicator (H3a).

**Total space heating consumption for services using energy source Z for their heating:** This is the overall energy consumption for heating the services that use energy source Z: electricity, natural gas, wood, coal, etc. This consumption is used as the numerator for the indicator (H3b).

**Total space heating consumption for service category A:** This is the total energy used to heat all buildings for a certain service category: hotels, schools, restaurants, etc. This consumption is used as a numerator for the indicator (H3c).

**Figure 5.11 • Aggregated flow chart of the energy consumption data needed for energy efficiency indicators for services**

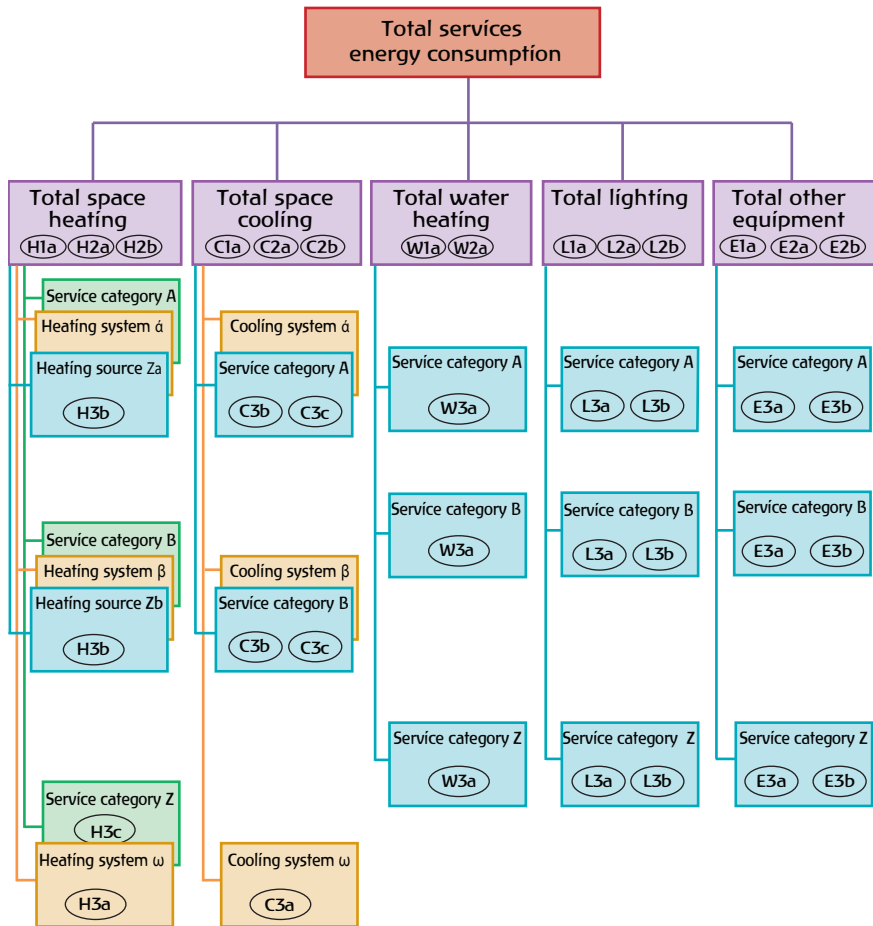

Note: "source" in the figure means "energy source".

## Space cooling consumption data

**Total space cooling consumption:** This is the total energy used to cool all services buildings that have cooling systems. It includes all energy sources (mostly electricity) and all types of cooling systems (central or distributed). This consumption is used as numerator for the indicators (C2a) and (C2b).

**Total space cooling consumption using cooling systems of type  $\alpha$ :** This is the total energy used to cool all services buildings using a certain type of cooling system or equipment: central or distributed. This consumption is used as a numerator for the indicator (C3a).

**Total space cooling consumption for service category A:** This is the total energy used to cool all buildings with air conditioning for a certain service category: hotels, schools, restaurants, etc. This consumption is used as a numerator for the indicators (C3b) and (C3c).

## Water heating consumption data

**Total water heating consumption:** This is the total energy used to heat water for all services buildings. It includes all types of energy (electricity, natural gas, biomass, etc.) and all types of water heating systems (central or distributed). This consumption is used as numerator for the indicator (W2a).

**Total water heating consumption for water heating systems of service category A:** This is the total energy used to heat water for a certain service category: hotels, schools, restaurants, etc. This consumption is used as a numerator for the indicator (W3a).

## Lighting consumption data

**Total lighting consumption:** This is the total energy used for lighting. It includes all energy sources (mostly electricity) and all types of lighting fixtures (incandescent bulbs, fluorescent tubes, etc.). This consumption is used as numerator for the indicators (L2a) and (L2b).

**Total lighting consumption for service category A:** This is the total energy used for lighting for a certain service category: hotels, schools, restaurants, etc. This consumption is used as numerator for the indicators (L3a) and (L3b).

## Other equipment consumption data

**Total other equipment consumption:** This is the total energy used for other equipment. It includes all types of equipment not included in other end uses. This consumption is used as numerator for the indicators (E2a) and (E2b).

**Total other equipment consumption for service category A:** This is the total energy used for other equipment for a certain service category: hotels, schools, restaurants, etc. This consumption is used as a numerator for the indicator (E3a) and (E3b).

## The activity data .....

### Value added<sup>2</sup>

**Total services value added:** This is the total value added for the services sector, representing the measure of the contribution of the services to the gross domestic product

2. For sources of value added and other macro-economic data, please refer to Box 5.2.

(GDP). It is used for indicators (H2a), (C2a), (W2a), (L2a) and (E2a). It is very important that the definition of boundaries for the total services value added matches that of the corresponding energy consumption data. It is generally recommended to use US dollars (USD) and purchasing power parities<sup>3</sup> (PPP) to make cross-country comparisons.

**Total value added of service category A:** This is the value added for a given services category representing the measure of the contribution of the category to the GDP. The service category's value added is useful only if an analysis can be conducted at the services category level; this means knowing the associated energy consumption as well as other activity data. It is used in indicator (E3a).

### Units of activity

**Unit of activity unit of service category A:** This is the relevant unit of service activity for each category, for example the number of nights for hotels. Examples of units of activity are shown in Table 5.1 for selected services categories. It is used as a denominator for the indicators (H3c), (C3c), (W3a), (L3b) and (E3b).

**Figure 5.12 • Aggregated flow chart of the main activity data needed for energy efficiency indicators for services**

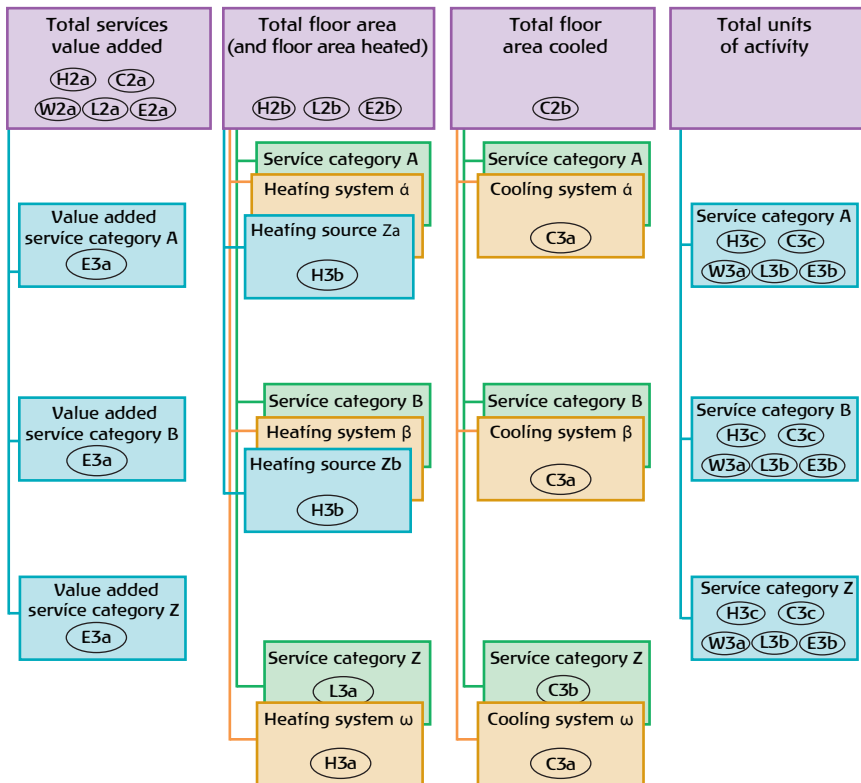

3. Purchasing power parities (PPPs) are the rates of currency conversion that equalise the purchasing power of different currencies by eliminating the differences in price levels between countries. In their simplest form, PPPs are simply price relatives which show the ratio of the prices in national currencies of the same goods or service in different countries.

## Floor area

**Total floor area:** This is the total floor area of all services buildings. It is used as denominator for the indicators (H2b), (L2b) and (E2b).

**Total floor area for buildings of service category A:** This is the total floor area of all buildings in a certain service category (e.g. all hotels, all restaurants, etc). It is used as denominator for the indicator (L3a).

**Total floor area heated:** This is the total heated floor area of all services buildings. It is used as denominator for the indicator (H2b). The heated floor area may include unoccupied areas such as parking spaces, kept at minimum temperatures to keep the infrastructure of the building operational.

**Total floor area for buildings using heating system of type  $\alpha$ :** This is the total floor area of all buildings using a certain heating system. It is used as denominator for the indicator (H3a).

**Total floor area of buildings using energy source Z:** This is the total number of occupied dwellings using a certain energy source for their heating systems. This number is used as the denominator for the indicator (H3b).

**Total floor area cooled for buildings with air conditioning:** This is the total floor area cooled of all services buildings that have cooling systems. It is used as denominator for the indicator (C2b).

**Total floor area for buildings using cooling system of type  $\alpha$ :** This is the total floor area of all buildings using a certain cooling system. It is used as denominator for the indicator (C3a).

**Total floor area cooled of buildings of service category A:** This is the total floor area of all services buildings of category A that have air conditioning. It is used as a denominator for indicator (C3b).

## 6 How to collect data?

Some data are easier to collect than others; this is true both for energy consumption and activity data. For instance, it is certainly easier to derive with accuracy the heating consumption of a building using fuel oil only for heating purposes with no secondary heating system than to estimate the consumption of electricity for a building in which electricity is used for a number of categories, such as space heating, lighting, water heating, other equipment, etc.

The four methodologies to collect energy consumption and activity data for the services sector are administrative sources, surveying, measuring and modelling. All methods have strengths and weaknesses, and it appears that countries often combine several methods (administrative sources and modelling, for example) to build proper indicators for the sector. A description of each methodology follows, mainly based on the submissions received by the IEA on existing practices for collecting statistics for energy efficiency indicators.

Table 5.3 presents an overview of main sources and methodologies often used to collect the data needed to build the indicators presented in the previous section. Individual methodologies will be described in the rest of this section.

**Table 5.3 • Summary of the main variables needed for services indicators and examples of possible sources and methodologies**

Data	Source	Methodology
<b>Energy Data</b>		
Total services consumption	National energy balance	Administrative sources Modelling
Service category consumption	Utilities	Administrative sources Modelling
<b>Activity data</b>		
Floor area	National statistics offices Regional governments Business taxation offices through national or regional networks Building permits offices National services sector surveys	Administrative sources    Surveys
Value added	National statistical office	Administrative sources
Unit of activity	National statistics offices Chambers of commerce, etc.	Administrative sources Surveys
Equipment	Manufacturers, Importers, etc.	Administrative sources Surveys

## Administrative sources .....

As in the residential sector, administrative sources, such as governments, utilities, international organisations and private companies, should be the first sources consulted to identify what data are already available and how those data could be best used. Tapping into those existing sources will generally lead to savings in time and costs. The following description of administrative data for the services sector is based on the submission of practices received by the IEA.

**Purpose of collecting administrative data:** Within the responses received by the IEA, countries noted that they heavily rely on administrative sources for the services sector. For example, countries rely on national accounts data to obtain value added information on the different service sector categories. Data can be used directly to compute indicators, or used to feed models and to help the design of survey samples.

**Sources:** IEA respondents identified a number of existing sources: government statistics offices, energy utilities (gas, electricity), manufacturers of equipment and international organisations. For energy consumption data across categories, most countries rely on energy utilities, which usually register sales at the category level due to the different pricing and coding systems for different end users. Countries can also rely on technical and scientific literature to find measurements or other references that could be adopted in their country.

**Data collected:** The two types of data that are collected to build indicators include activity and energy data, as listed in the previous section. Energy data would include

annual energy consumption by service category, often supplied by utilities such as electricity, natural gas or oil suppliers. Activity data would include value added, floor area, numbers of employees, number of nights, etc.

**Cost associated with administrative data:** Most of the respondents to the IEA survey noted that there was no fee associated with the data they needed to collect. However, when there is no direct cost, indirect costs are occurred from a number of steps needed: researching the existing administrative sources, discussing the data with the organisations collecting them to determine the feasibility of their use, setting up agreements for data transfer and use, and finally transferring the data to a format suitable for use.

**Main challenges:** Some of the most commonly faced challenges include the time-consuming process to collect and process information (e.g. paper to digital), definitional issues across sources, management of incomplete data, and time needed to establish a relationship with the organisation or service providing the data.

### **Box 5.1 • Selected international sources for the building sector**

Recent directives on energy performance standards in buildings have triggered collection of detailed buildings data in various countries, such as the European Union (EU) or the United States.

**The Buildings Performance Institute Europe\*** data hub includes technical data on the EU building stock (EU plus Norway and Switzerland) based on official statistics (i.e. national surveys, administrative data), research findings and expert estimations. Relevant data cover building stocks characteristics, energy consumption, as well as envelope performance.

**The US Department of Energy Buildings Performance Database\*\*** contains very detailed technical data on the characteristics and the performance of tens of thousands of existing buildings, for both the services and residential sectors across the United States.

\* Available online at: <http://www.bpie.eu/>.

\*\* Available online at: <https://bpd.lbl.gov/>.

## **Surveying** .....

Surveys are the most common methodology used to collect services data within the sample of practices submitted to the IEA. Surveys are performed for most of the service categories: office, retail space, health care, education, warehousing, food service, lodging, arts and entertainment. Of course, surveys alone may not be enough, and may need to be complemented by information derived from building energy audits or from modelling studies.

The next paragraphs summarise the main characteristics of surveys derived from the practices received by the IEA.

### Box 5.2 • Selected international sources for macroeconomic data

At the national level, macroeconomic data such as GDP, sectoral value added, population, etc. are generally available at statistics offices, central banks, ministries or research institutes. Selected international sources for such data are presented below.

The **Organisation for Economic Co-operation and Development**<sup>(1)</sup> collects data on GDP, value added by sector, PPPs, exchange rates, population, employment for its 34 member countries.

**Eurostat**<sup>(2)</sup> collects data on GDP, value added by sector, PPPs, exchange rates, population, household, employment for European Union countries.

The **International Monetary Fund**<sup>(3)</sup> provides global data on GDP, PPPs, exchange rates, population, employment.

The **United Nations**<sup>(4)</sup> provides global data on GDP, value added by sector, PPPs, exchange rates, population, employment.

The **World Bank**<sup>(5)</sup> collects global data on GDP, PPPs, exchange rates, population.

(1) Available online at: <http://stats.oecd.org/>.

(2) Available online at: <http://epp.eurostat.ec.europa.eu/portal/page/portal/statistics/themes>.

(3) Available online at: <http://www.imf.org/external/data.htm>.

(4) Available online at: <http://unstats.un.org/unsd/snaoma/Introduction.asp>.

(5) Available online at: [http://siteresources.worldbank.org/ICPEXT/Resources/ICP\\_2011.html](http://siteresources.worldbank.org/ICPEXT/Resources/ICP_2011.html).

**Survey purpose:** The key purposes of service sector surveys are to understand changes of energy consumption over time across activities; to collect information on the physical characteristics of buildings, such as floor area, occupancy rate, etc.; and to collect information on energy expenditures. Some countries carry out surveys to establish best practices in benchmarking energy efficiency class for the different sectors. For about half of the respondents, surveys are carried out to complement information from another type of data collection or estimation.

**Service categories covered:** Many countries, especially OECD countries, choose to collect data based on the national economic activity classification (e.g. ISIC, or NACE in Europe), while some countries collect data based on different classifications, such as the following two examples:

- 1) office, retail space, health care, education, warehousing, food sales/food services, lodging, arts and entertainment, multipurpose building;
- 2) office building, medical office building, elementary and/or secondary school, nursing and residential care facility, warehouse, hotel and motel, hospital, food and beverage stores, non-food retail stores, vacant, other.

It is recommended that countries adopt the ISIC classification if possible, especially if comparisons are then conducted across countries.



**Sample design:** The majority of respondents apply a stratified random sampling approach, with the number of stratification levels varying from one to more than 50. Stratification criteria include: service category, geographical location, climatic region, age and type of buildings, number of building occupants, etc.

Sources to select the sample include a list of addresses from administrations, chambers of commerce, tax agencies and business registers. In one innovative case, Google Earth™ and Streetview™ are used to identify services sector buildings and to improve the representativeness of the sample. The approach relied on local building code definitions together with a property roll (ID) number.

**Sample size:** The sample size of surveys ranged anywhere from 5 000 to 120 000, or between 0.1% to 100% of total number of buildings. The majority of the surveys were carried out with sample sizes of less than 10% of the total building population. From the submissions received the sample size was on average 5% of the total building population.

**Frequency:** Within the IEA sample, surveys in the services sector are carried out every one to four years, the majority being on an annual basis. Conducting surveys on a regular basis not only ensures continuity of data, but also enables improvement of data quality through a continued capacity-building effort.

**Legal status of the survey:** More than half of the surveys are mandatory under law, but only a few have associated fines in case of non-response. In a couple of instances, respondents to surveys were promised a report based on the study findings.

**Survey respondents:** In most instances, surveys were sent out to enterprises that in turn delegated a key contact for each building operated in their organisation. In some cases, additional information was collected to complement the survey results, for example from administrative sources, such as utility companies for electricity or natural gas sales to individual business establishments. If information on energy sales is included in the survey, contacting utilities could also be a way to cross-reference data and to obtain consumption information for the total sector, and not only for the sample being surveyed.

**Response rate:** Response rate varied anywhere from 20% to 100%, with an average of two-thirds and one case of 100%. In that successful case, the survey was carried out by a market research company that by contract had to fulfil quotas for each of the sub-sectors. First, businesses were contacted by telephone, based on the existing panel lists from the market research company, to identify the most appropriate individual to be interviewed, based on knowledge of energy consumption and physical building characteristics. Then, a computer-assisted personal interview approach was used to collect data.

**Collection methods:** Paper collection of the information was the most popular approach, followed by Internet-based collection and physical on-site visits. In some countries, respondents had the option to submit data either through paper or via Internet.

**Time to complete a survey:** For the respondents providing this information, it took anywhere from an estimated time of less than 10 minutes to 180 minutes to complete a survey, depending on its detail, and with an average of one hour.

**Elements collected:** Most surveys collected information by service sector category, with a focus on activity data, especially floor area, age of buildings, number of occupants, age and type of heating systems, type of cooling systems, and type of fuels used for the various end uses. Additional information included office equipment stock, type of lighting equipment and technology, and the type of renovations carried out in a building. In some cases, information was collected on energy expenditures, and utilities were contacted as a complement. Although direct energy consumption cannot be collected from these surveys, the physical characteristics of equipment together with overall consumption data can be used to estimate energy consumption of the equipment at the country level. Most of the information collected does not directly relate to the indicators proposed above, but is very relevant for a more detailed audit of the building sector.

**End uses covered:** Space heating, space cooling and water heating were the most frequently covered end uses, and for them data collected included age and type of heating systems, type of cooling systems, and type of fuels used.

**Energy sources:** All traditional sources of energy are considered in the surveys such as electricity, natural gas, heating oil, coal, LPG and biomass. In addition, in the services sector, it is important to consider district heating and heat recovery systems that can be utilised in buildings. Also, buildings rely more and more on solar thermal water heating applications, geothermal systems to cool and heat buildings, roof-installed solar panels to generate electricity and renewables in several other end uses.

**Overall time for preparing and conducting a survey:** The time required to fully develop and implement the survey varied considerably, from a minimum of three months to a maximum of four years for the most elaborate and data intensive surveys, with an average of over a year. The overall time depends on the resources required to run the project, the training requirements of the staff for data collection and post-processing, the detail of the data being collected, and the validation process to ensure data quality. As surveys are repeated, organisations will typically become more efficient at delivering the results.

**Costs associated with the survey:** The cost of a survey depends on the labour cost, the detail of the survey itself, the stratification levels and the sample size of the survey. As a consequence it might be difficult to give a precise cost estimate fitting all cases. However, based on cost estimates gathered from a few OECD countries, the cost of a national service sector survey can range from USD 128 000 to USD 8 million. Based on the practices submitted from the residential surveys, it is expected that the design phase represents 15% to 20% of the overall cost, the data collection phase 40% to 50%, the processing and reporting phase 20% to 30%, and the overall management of the project 10% to 20%.

**Main challenges faced in surveying:** Two-thirds of the respondents noted that the key challenges were low response rate, low response quality, and inconsistent responses. Incomplete surveys were reported by half of the respondents. Some other issues include the quality of the interviewing staff and the need to train them for the task. Another problem was the lack of clarity on the time period referred to in the survey, which could be avoided by clear instructions to the respondents.

**Possible improvements:** More than half of the respondents noted that quality of results could improve significantly by increasing the survey sample size. Other suggestions included adding in a personal interview, or a verification of the survey input, as well as an energy audit. Having clear definitions and instructions for each question is important to decrease the burden on respondents. An idea to incentivise responses could be to provide respondents with access to the energy data for their sector.

As mentioned, adding an in-person interview can increase accuracy of results, and energy audits could help verification of responses. Over time, ensuring that surveys are carried out at regular intervals is also key. Establishing and maintaining a good relationship with energy managers was also rated as an important practice.

## Questions and Answers:

### Q5. How should multi-service buildings be counted?

*Several countries responding to the IEA had examined the treatment of multipurpose spaces, when multiple service activities co-exist in the same building. Often, respondents of surveys are asked to estimate floor area for the primary activity of the building (e.g. defined as the activity occupying 75% of the gross area), then to identify a secondary activity and its floor area, and in some cases up to a third activity*

### Q6. Can services energy surveys be expanded to collect water information?

*Yes, even if it is not yet a common practice. Some countries have initiated the collection of data on water use in buildings together with energy consumption data. Such information is not only valuable to the national administrations, but also to local governments that need to plan resources and infrastructure for municipal water distribution.*

### Q7. Can services surveys be expanded to include transport data?

*Services surveys can also include a few more questions about vehicles owned and kilometres driven, to provide additional data on transport energy consumption. While transport is often not the main focus of the data collection for services buildings, the data collected can complement national transport surveys and help improve transport statistics and energy efficiency indicators. However, transport consumption should not be included within the services sector.*

## Measuring .....

Countries recognise the importance of undertaking measurements in the services sector to inform not only building owners about energy saving opportunities through audits, but also government on potential policy interventions. Measurements in the services sector are particularly intensive because of the heterogeneous nature of the services categories and of the types of buildings. However, in the absence of other data, even small sample measurements can be effective in making initial estimates.

The following paragraphs are based on the responses submitted to the IEA. Unfortunately, in the case of services measurements, the practices submitted were very few – which limits the general applicability of the findings reported here. The small number also shows that measuring is not yet a well-developed approach for energy efficiency indicators in the services sector.

**Measuring purpose:** Measuring is generally performed to assess energy consumption patterns, diffusion of equipment and efficiency of various systems (ventilation, heating and cooling), but also to complement information coming from a survey or a modelling study and to feed models and estimates. In fact, many of the survey practices submitted to the IEA stated that measurements, including those performed during audits, would be very important for verification of survey data.

**Service categories covered:** Based on the practices submitted to the IEA, measurements generally target particular service categories and the buildings where their activities take place, such as offices, retail space, health care, education, warehousing, food sales/food services, lodging, arts and entertainment, and multipurpose buildings.

**Sample design:** Samples are usually designed based on existing lists of buildings, key businesses and institutional establishments. Another option is a repeating panel of respondents previously involved in other initiatives. Given the generally small size of the sample, its design is usually based on a random selection, with attention paid to balance among service categories and geographic locations.

**Sample size:** Cost of measurements is generally high, due to the costs of equipment and of labour for setup, calibration and data collection. Therefore, the sample size is generally rather small (i.e. ranging from 400 to 2 500).

**Frequency of measurements:** There is no ideal frequency for undertaking measurement initiatives. In one case, measurements were conducted every year, each time for a different building type. In another case, measurements were carried out every three years along with the building survey cycle.

**Length of monitoring period:** Across measurement initiatives, the length of one monitoring period is variable, with a minimum of 1.5 days, to track the daily fluctuations, to a maximum of one week. Various measurement periods can be spread over one year to also track seasonal fluctuations of consumption. When the equipment cost is high, alternate measurements can be taken at different times across different sites.

**Who took measurements and how:** Measurements can be taken by energy auditors and building operators. In some instances, companies that supply energy can also play an active role in collecting measurements. For electricity consumption

data, existing meters and data loggers can be utilised. Other types of measuring equipment include gas meters, thermometers, flow meters, etc.

**Energy end uses covered:** The main end uses covered by measurements in the services sector are space heating, space cooling, water heating, lighting and other equipment (e.g. office equipment and ventilation). For each building, end-use information can be collected for a number of service categories operating there.

**Energy sources monitored:** In the few examples that were received in the IEA survey, respondents identified electricity as the primary energy source to be monitored, followed by natural gas, oil and other fuels.

**Cost of measurements:** As not enough information was submitted to provide an accurate estimate of services buildings measurements costs, the information presented for residential measurements could provide a useful initial estimate. The key driving factors are the cost of individual equipment and the labour costs to set up the equipment, collect measurements and address any technical difficulties during the monitoring period. Additional costs include the costs to design the sample, and to analyse and communicate data.

**Main challenges:** The major challenges were linked to the setup of equipment, often requiring more time than what originally was allocated. Respondents also noted quality problems of the data collected, and communication difficulties with occupants or key contacts in the buildings monitored.

**Recommendations:** The planning stage was crucial for the success of projects. For example, involving building owners from the planning stage allowed for improved design and expedited data collection. One respondent noted that having the same company repeatedly undertaking the measurements allowed for consistency of data, and for time savings in staff training every year. Over time, the mistakes were corrected and quality of data improved.

## Modelling .....

Modelling is an integral part of the process to estimate energy consumption by end use in the services sector, by itself, or to complement results from another methodology, such as for example a national survey. As modelling is based on input data and assumptions, the quality of input data and the accuracy of assumptions will strongly impact the quality of the output. The key steps of modelling work include establishing the modelling framework, setting model assumptions, inputting data, running the model, validating its outcomes against data and analysing results. The following paragraphs are based on the practices submitted to the IEA for services sector modelling.

**Model purpose:** Models are generally used to estimate energy consumption for the sector and for its different end uses, based, for example, on physical characteristics of equipment, equipment diffusion and typical energy use patterns. Just like for the residential sector, models can also be used to forecast, using historical time series and assumptions on macroeconomic factors.

**Service categories covered:** Most of the existing bottom-up models cover the different service categories listed previously.

**Model type:** The service sector models can apply a top-down approach, a bottom-up approach or a combination of the two. Top-down models rely on macroeconomic variables and energy price indicators to estimate the evolution of energy consumption in the services sector, based on historical price and income elasticities. By strongly relying on relationships developed such as on historical behaviour, they assume that such relationships are stable in time – which would require a relatively stable energy market. This approach could be useful to develop aggregate level indicators at each category level. The vast majority of models rely on a technology-based bottom-up approach, which could be simply a statistical representation of equipment stock flows and their associated energy rating, or a more sophisticated engineering model, with detailed technical parameters of equipment and performances.

**Source of the model:** Most models are custom-built, but some could be derived from existing models. Tapping into an existing model has the advantages of saving time and of potentially learning from other people using the same model. A top-down model could be easily built with existing statistical econometric software, while setting up a bottom-up model could be done using spreadsheet software (e.g. MS Excel™).

**Time required:** The key stages for a modelling study include developing the model; inputting data; calibrating it to national historical data; regularly updating the framework, its input and its assumptions; validating the model's results; and analysing the data. The time needed to build and properly calibrate the model can vary, depending on the complexity of the model and on whether the model is developed based on an existing one or not – in which case the development phase consists only of an update based on custom assumptions and data.

According to the IEA submissions, the time required to develop a model varied between one week and eight months; updating it with new data required between 1 week and 40 weeks; verifying and validating results required between 1 week and 30 weeks; processing the data, analysing scenarios and preparing reports required 1 week to 30 weeks. The overall modelling exercise could take anywhere from a few weeks to about two years. In general, top-down models tend to be set up much more quickly than bottom-up models.

**Cost:** The cost for modelling is largely a function of the cost of labour. For a top-down model (e.g. taking about four weeks of work), an average cost could be around USD 20 000. Bottom-up models could take from a few weeks to almost two years, and their corresponding cost would also vary greatly.

**Frequency:** Within the IEA sample, half of the services modelling practices are undertaken on an annual basis, while some were performed only once. Repeating the exercise in time would allow improvement of the existing framework.

**Key model inputs:** For top-down models, based on macroeconomic variables, input data are readily available in national accounts by service category. Bottom-up models rely on information such as total floor area of buildings, number of building occupants, type of heating systems and annual use of the different energy sources, total equipment stock, and diffusion rates in the different services categories. Such input information may derive from national surveys or from monitoring buildings. In

the absence of data, a number of assumptions would need to be developed in order to estimate energy consumption by the different end uses.

**Key model outputs:** While top-down models can estimate energy consumption only at the service category level, bottom-up models are used to estimate energy consumption of the various end uses: space heating, space cooling, water heating, lighting and energy needed for auxiliary equipment such as motors.

**Validation of modelling outcome:** Most models have their results validated against existing national data, such as energy balances, or national energy statistics or utility data.

**Main challenges:** Within the sample of submissions to the IEA, the most important challenge was the lack of input data – which implies that existing data collection practices in the services sector still need to improve coverage. Other challenges included quality control issues and proper definitions of model assumptions.

**Recommendations:** To ensure continuity of the results, it is recommended that modelling exercises be maintained over time. Useful options to be added could be the possibility to estimate the energy efficiency potential within the services sector, based on a set of existing technologies and their cost. Estimates on hidden costs and barriers to provide a risk management perspective before undertaking energy efficiency programs in buildings would also be valuable.

# Collecting What and How for the Industry Sector

## 1 What does the industry sector mean and cover?

For the purpose of energy efficiency indicators, the industry sector refers to the manufacture of finished goods and products, as listed under “manufacturing industries” within the United Nations International Recommendations on Energy Statistics (IRES). Industry excludes upstream power generation, refineries, and distribution of electricity, gas and water. Compared with the industry sector of the International Energy Agency (IEA) energy balances, it also excludes mining and quarrying of raw materials, as well as construction. Therefore, the industry sub-sectors considered for efficiency indicators are: iron and steel<sup>1</sup>; chemical and petrochemical; non-ferrous metals; non-metallic minerals; transport equipment; machinery; food and tobacco; paper, pulp and print; wood and wood products; textile and leather; and industry not elsewhere specified.

As shown in the IRES, each of these sub-sectors includes a number of economic activities, based on the general International Standard Industrial Classification of all Economic Activities (ISIC) classification. Annex B describes the boundaries of the industry sector, as addressed in this manual, in relation with the ISIC<sup>2</sup>.

In terms of energy consumption, the industry sector covers all energy-using activities across industries (to generate electricity and heat for production processes, and to operate facilities). It excludes all transport-related activities, for example energy consumption of a car fleet of a company, and all non-energy use of fuels, amounts that are not combusted but used as feedstocks, such as naphtha for plastics, natural gas for ammonia production, bitumen for roads, etc.

### Questions and Answers:

#### **Q1. Where does one allocate energy consumption of offices on an industrial site?**

*It is very difficult to separately obtain data on consumption of offices within industrial establishments where production occurs. Therefore, it is common practice to include that consumption within the industrial consumption. However, consumption of headquarter premises, dedicated only to office activities, should be allocated to the relevant category of the services sector.*

1. Note that for the purpose of energy efficiency indicators, the iron and steel sector also includes energy used and transformed within the associated transformation processes (i.e. coke ovens and blast furnaces); all non-energy use of fuels is excluded.

2. According to the United Nations Statistics Division there are 422 different classification systems in more than 118 countries globally and they include activity classifications, product classifications and expenditure classifications. However, many countries aim at aligning with international classifications such as the UN ISIC classification or the NACE classification (in Europe). For economic activities, the point of reference is the UN ISIC code, followed by the European NACE classification system for most countries in Europe. Although most countries are able to link their national classification system to international classifications, some deviations still exist and some sectors may be difficult to align for harmonisation or comparative purposes.



**Q2. How should multi-activity enterprises be counted?**

*Large enterprises may be engaged in various economic activities that belong to different industries. The IRES recommends in that case that the enterprise be broken into one or more establishments, provided that smaller and more homogeneous units can be identified for which energy may be meaningfully compiled.*

**Q3. Why are transport-related activities not included in industry?**

*Indicators of energy efficiency for industry focus on the efficiency of the industrial production processes. Therefore, fuels used for transport should not be included under industry. The analysis of transport efficiency can be made separately based on the overall activity data and energy consumption data of the transport sector.*

**Q4. Why is non-energy use of fuels excluded from energy efficiency indicators?**

*Amounts of fuels used as feedstocks are not relevant to monitor the efficiency of the energy use for a specific industrial process of production. However, such amounts may be relevant in a study on potential savings, as they represent significant fractions of the amounts of fuels delivered to industry, especially for the chemical and petrochemical sector.*

**2 Why is the industry sector important?**

Globally, industry accounts for over a quarter of total final energy consumption (TFC), down from about a third in 1973. As is the case with the other sectors, this share is very variable across countries, depending on the degree of industrial development and on the intensity of the industrial sector within the economy. Figure 6.1 shows the relative weight of industry within the total final consumption in 2011 for more than 130 countries, based on data collected by the International Energy Agency (IEA).

On the one hand, for a set of developing countries with a limited industry sector, industry could account for less than 10% of TFC; on the other hand, for countries with an economy based on a larger industrial sector the share could be larger than 30%. However, these data should be used with caution as a preliminary indication of the weight of the industry sector relative to other sectors in each country; for instance, some countries have difficulties providing comprehensive data by sector.

**Figure 6.1 • Share of the industry sector in the world total final consumption of selected countries (2011)**

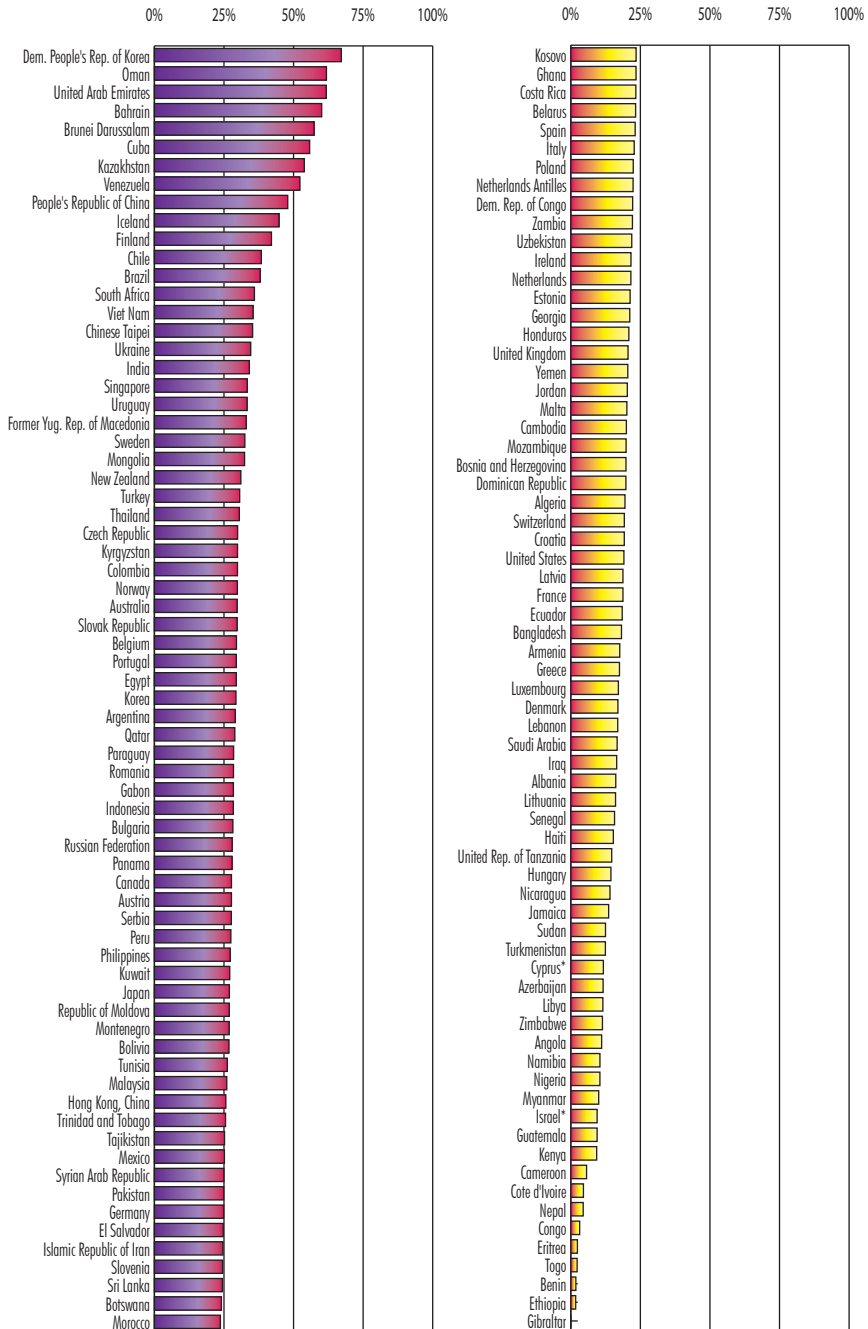

Note: unless otherwise indicated, all tables and figures in this chapter derive from IEA data and analysis.

\* See Annex F.

Globally, the largest energy sources for industrial consumption are coal (29%), electricity (26%) and, to a lesser extent, natural gas (20%). Oil, dominant in 1973 (29%), significantly decreased its share to 13% in 2011 (Figure 6.2), while coal increased its share to 29% over the years. Oil and electricity show two opposite trends: the oil share more than halved between 1973 and 2011, while the electricity share almost doubled over the same period. As in the residential and services sectors as well as for electricity generation, there is a strong will to reduce the share of oil in the industry sector. The use of electricity is growing quickly in industry because of the increase of electrical processes.

**Figure 6.2 • Shares of various energy sources in the world total industry sector consumption**

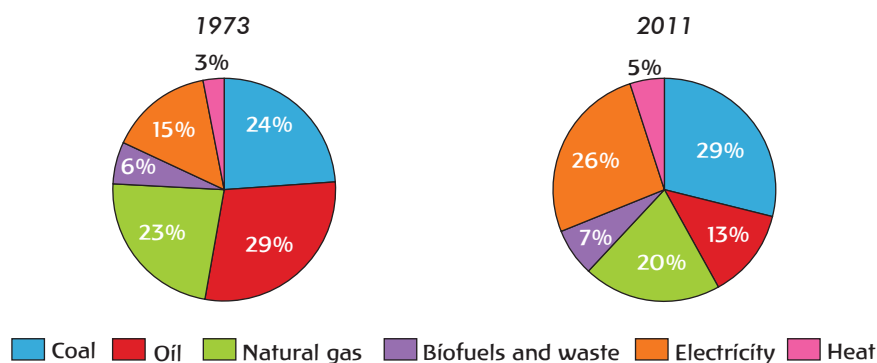

Of course, these shares vary a lot across countries, depending on their structures and natural endowments. For example, the shares of gas or coal can be much larger for countries with large availability of those energy sources. Coal is dominant in some Asian countries, while gas dominates the sectoral consumption in some Middle East countries, but also in Canada and the United States, among others.

**Figure 6.3 • Share of the industry sector in the world total final consumption for selected energy sources (2011)**

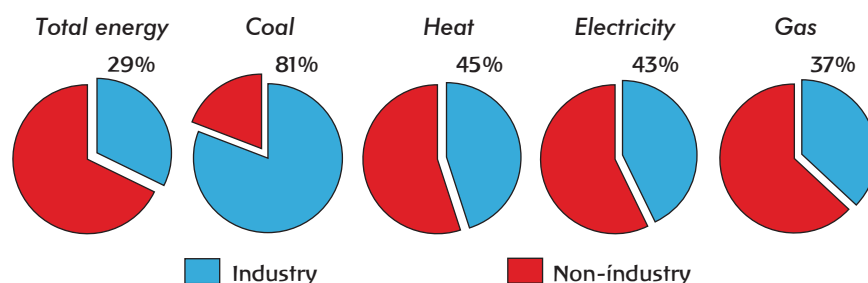

The industry sector accounts for over 80% of the global final consumption of coal, mainly driven by the iron and steel sub-sector; for over 40% of that of electricity and heat; and for about one-third of that of natural gas (Figure 6.3). These average fuel shares are of course not representative for all the countries. For instance, industry accounts for almost 70% of electricity final consumption in the People's Republic of China driven by electricity-intensive sub-sectors; and for over 70% of natural gas

final consumption in countries such as Brazil, Indonesia and Mexico. Industry accounts for lower shares of coal final consumption in countries where coal is also used in the residential sector, such as for example Ireland, Turkey and Poland.

Many large consuming industries (iron and steel, cement, etc.) have already engaged in energy-saving programmes, as energy often represents a large share of their cost of production. In order to be competitive, they therefore invest in low-consumption technologies. Moreover, legislation in terms of greenhouse gas (GHG) emissions as well as local pollution often pushes industry to be cleaner and more energy-concerned. Through stricter environment regulations, policy makers also have an essential role to play in reducing energy consumption in the sector. And, as in the case of the previous sectors, utilities and energy companies can also help industries promote energy efficiency measures and actions in order to reduce peak load.

### 3 What are the main sub-sectors driving industry consumption?

While for the residential and services sectors, energy efficiency indicators are computed for each end use, such as space heating, lighting, etc., for the industry sector they are computed on a sub-sectoral basis. This is because the main end use of an industry is the process of production itself, and large differences are observed across sub-sectors.

**Figure 6.4** • Breakdown of the 2011 industry consumption by sub-sector for the world and OECD

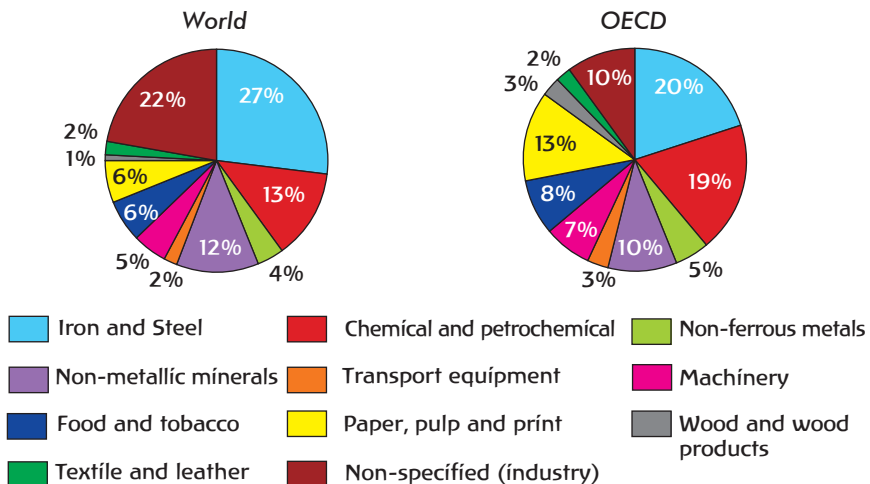

According to IEA data, and although about a quarter of industrial consumption cannot be allocated to any specific sector because of limitations in data, the largest consuming sectors are iron and steel; chemical and petrochemical; paper, pulp and print; non-metallic minerals (which includes cement production); and food and tobacco. Shares by sub-sector for world and member countries of the Organisation for Economic Co-operation and Development (OECD) are shown in Figure 6.4.

However, these shares may vary dramatically from country to country, depending on circumstances. It is therefore recommended to carefully examine the energy balance to identify key consuming sub-sectors. When prioritising industry data collection, most of the effort should be put into key consuming sub-sectors within each country.

A brief description of the sub-sectors, as listed at the beginning of the chapter, follows. Annex B provides a summary description of the various sub-sectors in terms of the ISIC classification.

Given the complexity of the industrial sector, monitoring energy efficiency across its sub-sectors requires a good understanding of the various technologies and processes involved. Therefore, for more technical descriptions of the sub-sectors, please refer to IEA (2007) and to the companion manual IEA (2014).

## Iron and steel .....

Iron and steel refers to manufacturing of basic iron and steel (ISIC Group 241), and casting of iron and steel (ISIC Class 2431), within the manufacture of basic metals (ISIC Division 24). Steel can be produced by two processes: from iron ore, or a combination of iron ore and scrap, using basic oxygen furnaces (BOF); or from recycled scrap products, using electric arc furnaces (EAF)<sup>3</sup>. The energy efficiency of an iron and steel plant is largely influenced by the type of process and by the amount of scrap in the input. For the purposes of energy indicators, the input to iron and steel also includes the consumption in coke ovens and blast furnaces, but should not include by-products of the process (e.g. coke oven gas, blast furnace gas and basic oxygen furnace gas) that are sold and not used on site. The iron and steel sub-sector heavily relies on coal and electricity as energy sources. In some cases, natural gas is used to produce direct-reduced iron (DRI), and also charcoal is used as input to the sub-sector.

## Chemical and petrochemical .....

Chemical and petrochemical refers to the manufacture of chemicals and chemical products, including fertilisers, plastic and synthetic rubber (ISIC Division 20), and of pharmaceuticals and medicinal chemical and botanical products (ISIC Division 21). This sub-sector uses significant amounts of fuels as feedstocks, e.g. oil to produce intermediate chemical products, such as ethylene, propylene, benzene, etc.; natural gas to produce ammonia, methanol and other products; and even biomass. However, the fuels used as feedstocks are not included in the energy efficiency indicators analysis.

Although this sub-sector is very complex in the number of products generated, a key common process is steam cracking of various feedstocks, with a varying range of energy intensities depending on the feedstock. This sub-sector largely relies on oil and natural gas, both as feedstocks and as energy sources. Other sources include electricity and in some cases, chemical heat.

## Non-ferrous metals .....

Non-ferrous metals refers to manufacturing of basic precious and other non-ferrous metals (ISIC group 242) and casting of non-ferrous metals, such as aluminium, copper, magnesium, titanium, zinc, etc. (ISIC Class 2432), within the manufacture of basic metals (ISIC Division 24). One of the largest energy consumers in the sub-

3. IEA (2005) and IEA (2007) provide schematic descriptions of the physical processes associated with the production of iron and steel.

sector is production of aluminium derived either from ores or from recycling from waste and scrap, heavily relying on electricity.

## Non-metallic minerals .....

Non-metallic minerals refers to the ISIC Division 23, including manufacture of glass and glass products and manufacture of non-metallic mineral products, such as ceramic products, tiles and baked clay products, cement and plaster. The largest energy consumer in the sub-sector is cement production, which comprises a very intensive process transforming raw feedstock (such as limestone) into “clinker”, and a less intensive process of mixing additives to clinker to form cement. Depending on the water content of the raw feedstock, the process of clinker production can be either “wet” or “dry” – the first being much more energy-intensive than the latter. In recent years, efforts have been made to phase out inefficient wet kilns and only use the more efficient dry process. One of the most efficient processes today is a five-six pre-heater/pre-calciner<sup>4</sup>. Cement production can also make use of clinker substitutes such as fly ash and steel slag.

## Transport equipment .....

Transport equipment refers to the manufacture of motor vehicles, trailers and semi-trailers (ISIC Division 29), and to the manufacture of other transport equipment, such as ships, aircrafts, railroad stock, etc. (ISIC Division 30).

## Machinery .....

Machinery refers to the manufacture of fabricated metal products (ISIC Division 25); of computer, electronic and optical products (ISIC Division 26); of electrical equipment (ISIC Division 27); and of machinery and equipment (ISIC Division 28).

## Food and tobacco .....

Food and tobacco refers to the manufacture of food products (ISIC Division 10), beverages (ISIC Division 11) and tobacco products (ISIC Division 12). This sector is especially heterogeneous: it covers a large number of different activities, such as processing meat, preserving fish, producing wine, manufacturing cigarettes, etc., with a huge variety of associated physical products.

## Wood and wood products .....

Wood and wood products refers to the manufacture of wood and products of wood and cork, except furniture, and the manufacturing of articles of straw and plaiting materials (ISIC Division 16).

## Paper, pulp and print .....

Paper, pulp and print refers to manufacture of paper and paper products (ISIC Division 17) and to printing and reproduction of recorded media, such as books,

4. The pre-heater is a series of vertical cyclones through which the raw meal is passed, coming into contact with swirling hot gases moving in the opposite direction. A kiln may have up to six stages of cyclones with higher temperatures obtained through increased heat recovery at each stage. The pre-calciner is a system which comes before the rotary kiln in the cement manufacturing process when most of the limestone calcination is accomplished, making the process more energy-efficient.

newspapers, etc. (ISIC Division 18). The largest energy consumer of the sub-sector is the production of pulp and paper, involving a number of processes such as chemical or mechanical pulping, paper recycling, and paper production. Production of pulp and paper generally uses significant amounts of biomass residues for its own energy needs. Stand-alone chemical pulp mills can also actually be net producers of energy.

## Textile and leather .....

Textile and leather refers to the manufacture of textiles (ISIC Division 13), the manufacture of wearing apparel (ISIC Division 14), and the manufacture of leather and related products (ISIC Division 15).

## Industry not elsewhere specified .....

Industry not elsewhere specified refers to manufacture of rubber and plastic products (ISIC Division 22), manufacture of furniture (ISIC Division 31), and other manufacturing (ISIC Division 32). This category is also often used to allocate consumption when the disaggregation is not available.

**Table 6.1 • Examples of typical processes or product types for selected industry sub-sectors**

Sub-sector	Processes/product types	Sub-product
Iron and steel	Basic Oxygen Furnace (BOF) Electric Arc Furnace (EAF) Direct Reduced Iron (DRI)	
Chemical and petrochemical	Ethylene Propylene Benzene, toluene, xylene (BTX) Ammonia Methanol Butadiene	
Non-ferrous metals	Aluminium Copper	Bauxite Alumina Primary Recycled
Non-metallic minerals	Cement  Clay brick and tile Building ceramics Glass Lime	Clinker (wet and dry) Cement
Pulp, paper and print	Pulp  Recovered paper Paper and paperboard	Chemical pulp Mechanical pulp  Household and sanitary paper Newsprint Printing, writing paper Wrapping, packaging paper, paperboard

The industry sector is very complex, and a detailed understanding of the various processes or product types would be necessary to monitor energy efficiency. Table 6.1 provides a list of selected processes and product types associated with the various industry sub-sectors, without intending to be exhaustive. The companion document IEA (2014) or IEA (2007) provide further information for the various sub-sectors.

## 4 What are the most frequently used indicators?

Depending on the availability of data, one can build very disaggregated indicators, or stay at a level that is too aggregated to be meaningful for efficiency analysis but still provides useful overall information on the sector. The most aggregated indicators include, for instance, the share of the industry sector in TFC, or the overall industry consumption per value added. Though these indicators allow very rough comparisons among countries (however often misleading) and a description of evolution over time, they cannot be considered indicators of energy efficiency as such. For meaningful energy efficiency indicators, more disaggregated energy and activity data are needed, as described in the following paragraphs for a generic industry sub-sector.

Similar to the other end-use sectors, for the overall industry sector, as well as for each of its sub-sectors, indicators can be defined using a pyramidal approach from an aggregated level (for instance, the share of a sub-sector in total industry consumption) to very disaggregated indicators (for example, for each type of product, consumption per physical output). The wider the pyramid, the more detail required. Three levels have been used in this pyramidal approach, level 1 being the most aggregated one, and level 3 being the most disaggregated one. Moreover, for reasons of simplification, short code names have been assigned to each indicator to identify the end use and the level of the indicator.

Indicators starting with an **I** relate to the Industry sector, and with an **IS** to a generic Industry Sub-sector – that could be iron and steel, aluminium, food, etc. The use of a second letter **S** differs from the other chapters, for which there was only one letter; this is due to the multiplicity of industry sub-sectors. The number that follows relates to the level of disaggregation, 1 being the most aggregated and 3 the most disaggregated. The main function of the third character, a letter, is to differentiate indicators of the same level. As an illustration, indicator (**IS2b**) is an indicator of the second level for a generic industry sub-sector (**IS**) (in that particular case, sub-sectoral energy consumption per value added).

### Total industry sector .....

Similar to those for residential and services sectors, the pyramid for the industry sector is based on aggregated data, both for energy and for activity.

The most aggregated level refers to the overall energy consumption of industry expressed either in absolute terms or as the share in TFC (I1a), and to the share of each energy source in the total industry consumption mix (I1b). These two indicators,



although not intensities, provide a high-level picture of the sectoral consumption, and could allow a first comparison across countries, as well as a preliminary assessment of the importance of the various sub-sectors and energy sources.

**Figure 6.5 • Pyramid of industry indicators**

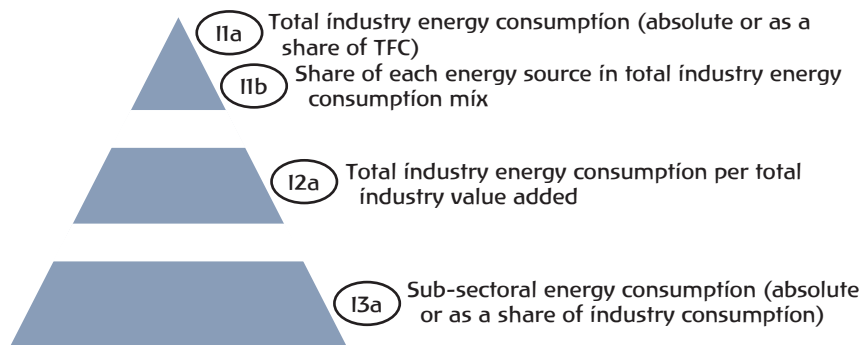

At the second level, the pyramid shows an intensity for the overall sector, computed by dividing energy consumption by value added (I2a). Although energy consumed in the sector is not strictly correlated to value added, this indicator can offer a first assessment of the overall intensity of the sector and its trends (e.g. industrial growth). It is of course largely influenced by the relative weights of different industrial sub-sectors – those with larger (e.g. iron) or smaller (e.g. gold) energy consumption per value added.

Because of the inhomogeneity of the physical output across industrial sub-sectors, an intensity per unit of physical output cannot be proposed at the overall industry level, but only at the sub-sectoral level, for those sub-sectors with a homogenous physical output. Only the value added can provide a common basis across sub-sectors for an initial assessment. It is important in this case to use value added in constant currency to avoid including a bias induced by fluctuations on the monetary market.

The third level of the pyramid refers to the energy consumption of each sub-sector, as a total or as a share of the industry consumption (I3a). This third level corresponds in fact to the top level of the generic sub-sectoral pyramid described in the following section.

For all the elements of this sectoral pyramid, the energy information can be easily derived from national energy balances, and the activity data from national accounts. However, one has to be very careful that definition and coverage of the sub-sectors are consistent in both energy and national accounts.

## Industrial sub-sectors .....

The following generic pyramid can be applied to each of the manufacturing sub-sectors, such as iron and steel, pulp and paper production, etc., to study their energy consumption patterns, once the relevant main output, processes and product types have been identified. **The preferred indicator for a given sub-sector is marked with a smiley face (☺).**

At the first level, the top indicator (IS1a) is the overall consumption of the sub-sector, expressed either in absolute terms or in percentage of the total industry sector consumption. This indicator describes absolute and relative weight of the given sub-sector within the industrial sector, offering a first assessment of the relevance of the sub-sector in terms of potential energy savings. The second indicator of level 1 (IS1b) is the share of each energy source in the total sub-sectoral consumption mix; once again, even though this indicator is not an intensity, it does describe the relative reliance on various energy sources in the sub-sectoral energy consumption.

**Figure 6.6 • Pyramid of industry sub-sectors indicators**

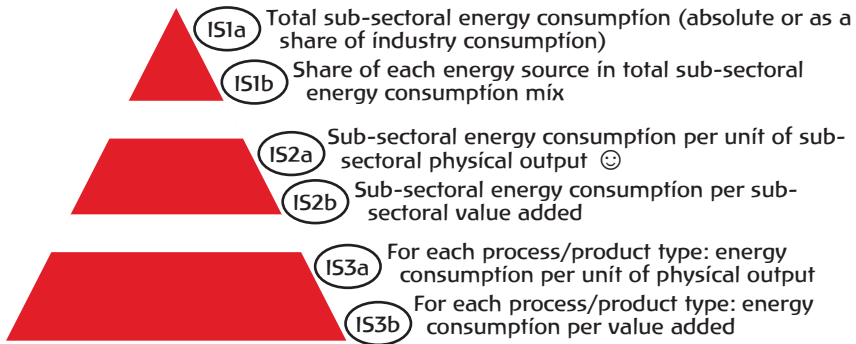

The second level proposes two indicators: consumption per unit of physical output (IS2a) and consumption per value added (IS2b). Note that (IS2a) is only meaningful when the output is homogeneous, for example crude steel. Some sub-sectors with heterogeneous production output, for example a petrochemical facility, may have to rely exclusively on the intensity per value added (IS2b), or move to the next level of disaggregation with data per individual type of product. **When relevant, the preferred indicator for a given sub-sector is energy consumption per unit of physical output.** A detailed knowledge of the technology or process used is essential to monitor the intensities of the various sub-sectors. Ranges for the most intensive sub-sectors, based on data collected by the IEA for selected countries, are provided as an indication within the discussion on data validation (Chapter 8).

At the third level, the two indicators proposed are the same as those of level 2, but referred to a specific production process or product type, instead of the sub-sector as a whole: consumption per unit of physical output (IS3a) and per value added (IS3b), for each sub-sectoral process or product type. For example, in the iron and steel sector, (IS2a) would be energy consumption per unit output of crude steel, while (IS3a) would comprise indicators such as consumption per unit of steel produced by BOF or consumption per unit of steel produced by EAF, etc. Such process-level indicators are of most interest to energy efficiency analyses. However, they are still limited by a general lack of availability of data, or by the difficulties in allocating energy consumption to specific physical output values, when outputs are heterogeneous in the same establishment. We should note that (IS3b) is only meaningful when a value added can be defined, which is more likely for a product type (e.g. ammonia) than for a process (e.g. dry cement). In any case, indicators based on physical output are always recommended for energy efficiency analyses.

Table 6.2 summarises the main indicators used for the industry sector excluding the indicators of level 1, which are not real indicators of energy efficiency or even of energy intensity; these indicators show only the absolute or relative importance of an end use in the sector mix or the total energy mix.

For each indicator of levels 2 and 3, the table gives the name, its coverage (overall or by specific type), the energy data, and the activity data to be used. The next-to-last column gives the code number for the indicator, and the last column uses a smiley face to note that the indicator is the preferred indicator for a particular end use.

**Table 6.2 • Summary list of the most common indicators for the industry sector data**

Indicator	Coverage	Energy data	Activity data	Code	Recommended indicator
Energy consumption per unit of physical output	Sub-sector	Total sub-sectoral energy consumption	Sub-sectoral physical output	IS2a	☺
	Process/product type	Process/product type energy consumption	Process/product type output	IS3a	
Energy consumption per unit of value added	Sub-sector	Total sub-sectoral energy consumption	Sub-sectoral value added	IS2b	
	Process/product type	Process/product type energy consumption	Process/product type value added	IS3b	

## 5 The data behind the indicators

The key data needed for the indicators of the various levels presented in the previous sections are summarised in Figures 6.7 and 6.8, respectively for energy consumption data and activity data. As for other end-use sectors, the key in establishing industry indicators is ensuring that boundaries and definitions for energy and activity data match.

### The energy consumption data .....

**Total industry sector energy consumption:** This is the total energy used by the industry sector as a whole, across all its sub-sectors. It includes all types of energy sources, primary and secondary, such as coal, electricity, oil products, natural gas, biofuels, waste, heat, renewable sources and waste, etc. Its absolute value corresponds to (I1a); it is used as a denominator in (I1b) and as a numerator in (I2a).

**Total industry sector energy consumption by energy source Z:** This is the total consumption of a given energy source for the industry sector as a whole, for example consumption of electricity across the various manufacturing sub-sectors. It is used to build the various shares described by (I1b).

**Figure 6.7** • Aggregated flow chart of the energy consumption data needed for energy efficiency indicators for industry

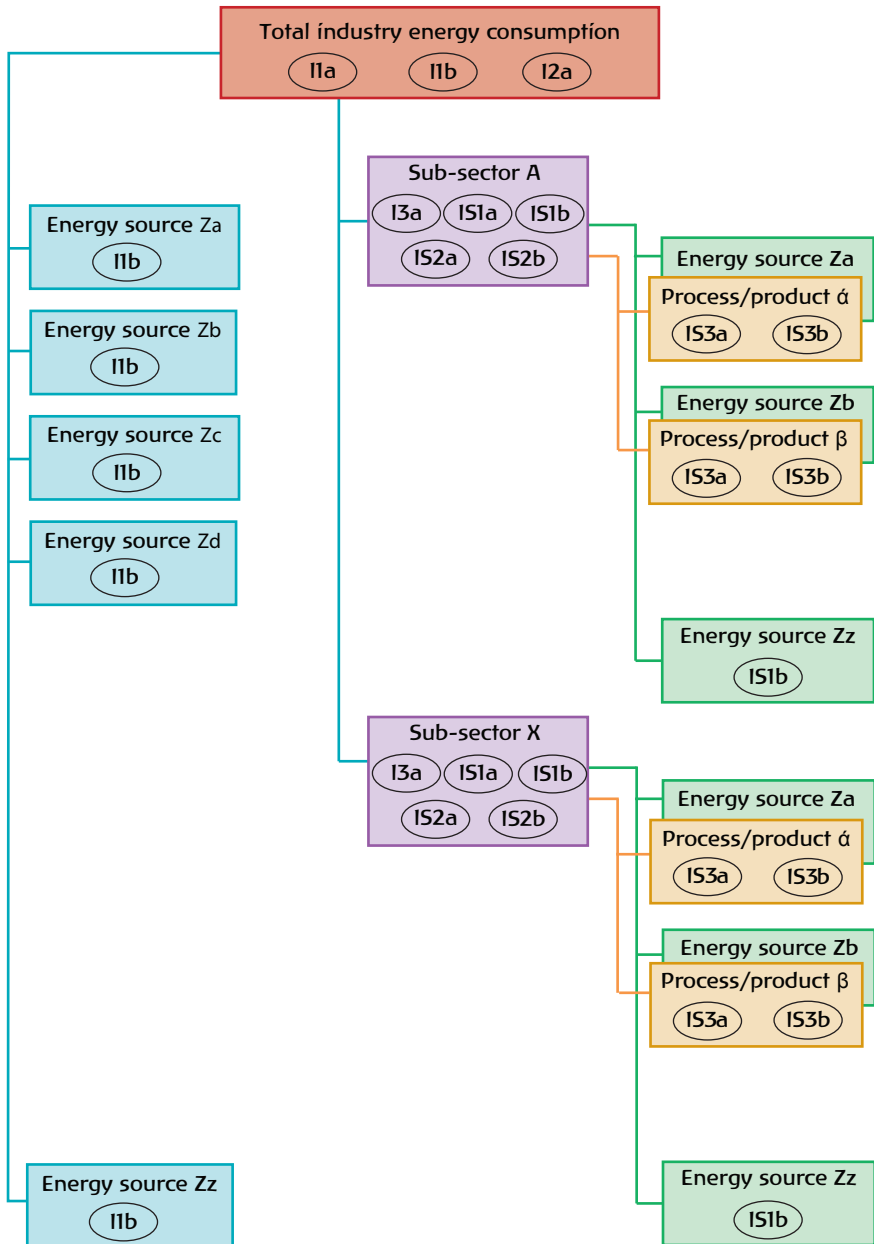

**Total industry sub-sector A energy consumption:** This is the total energy used by a given industry sub-sector, for example, iron and steel, food and tobacco, etc. It includes all energy sources. In the generic pyramid, it corresponds to (I3a); in any of the sub-sectoral pyramids, it corresponds to (IS1a) and it is used as a denominator for (IS1b), and as a numerator of (IS2a) and (IS2b).

**Energy consumption of the industry sub-sector A by energy source Z:** This is the total consumption of a given energy source for a given industry sub-sector, for example, consumption of coal in the iron and steel sub-sector. It is used as a numerator in (IS1b).

**Energy consumption of the sub-sectoral process/product type  $\alpha$ :** This is the total consumption of a given sub-sectoral process, for example, the BOF iron production within the iron and steel sub-sector, or the production of chemical pulp within the paper, pulp and print sub-sector. It includes all energy sources. It is used as a numerator in (IS3a) and (IS3b).

## The activity data .....

### Value added<sup>5</sup>

**Total industry value added:** This is the total value added for the industry sector, representing the measure of the contribution of the sector to the gross domestic product (GDP). It is used as a denominator for the indicator (I2a). It is very important that the definition of boundaries for the total manufacturing value added matches that of the corresponding energy consumption data. It is generally recommended to use US dollars (USD) and purchasing power parities (PPP)<sup>6</sup> to make cross-country comparisons.

**Value added of the industry sub-sector A:** This is the value added for a given industry sub-sector, representing the measure of the contribution of the sub-sector to the GDP. It is used as a denominator for the indicator (IS2b).

**Value added of the sub-sectoral process/product type  $\alpha$  of the industry sub-sector A:** This is the value added for a given industry sub-sectoral process/product type of the industry sub-sector A, representing the measure of the contribution of the product manufacture to the GDP. At this level of disaggregation, a value added can be defined more likely for a product type (e.g. ammonia, within the petrochemical sub-sector) than for a process (e.g. BOF iron). It is used as a denominator for the indicator (IS3b).

### Physical output

**Output of a sub-sector A:** This is the total physical production of a given sub-sector (e.g. the quantity of steel produced within the iron and steel sector), generally measured in volume or mass, depending on the product. This data is used as a denominator in (IS2a).

5. For sources of value added and other macro-economic data, please refer to Box 5.2 in the chapter on the services sector.

6. Purchasing power parities (PPPs) are the rates of currency conversion that equalise the purchasing power of different currencies by eliminating the differences in price levels between countries. In their simplest form, PPPs are simply price relatives which show the ratio of the prices in national currencies of the same goods or service in different countries.

**Figure 6.8** • Aggregated flow chart of the main activity data needed for energy efficiency indicators for industry

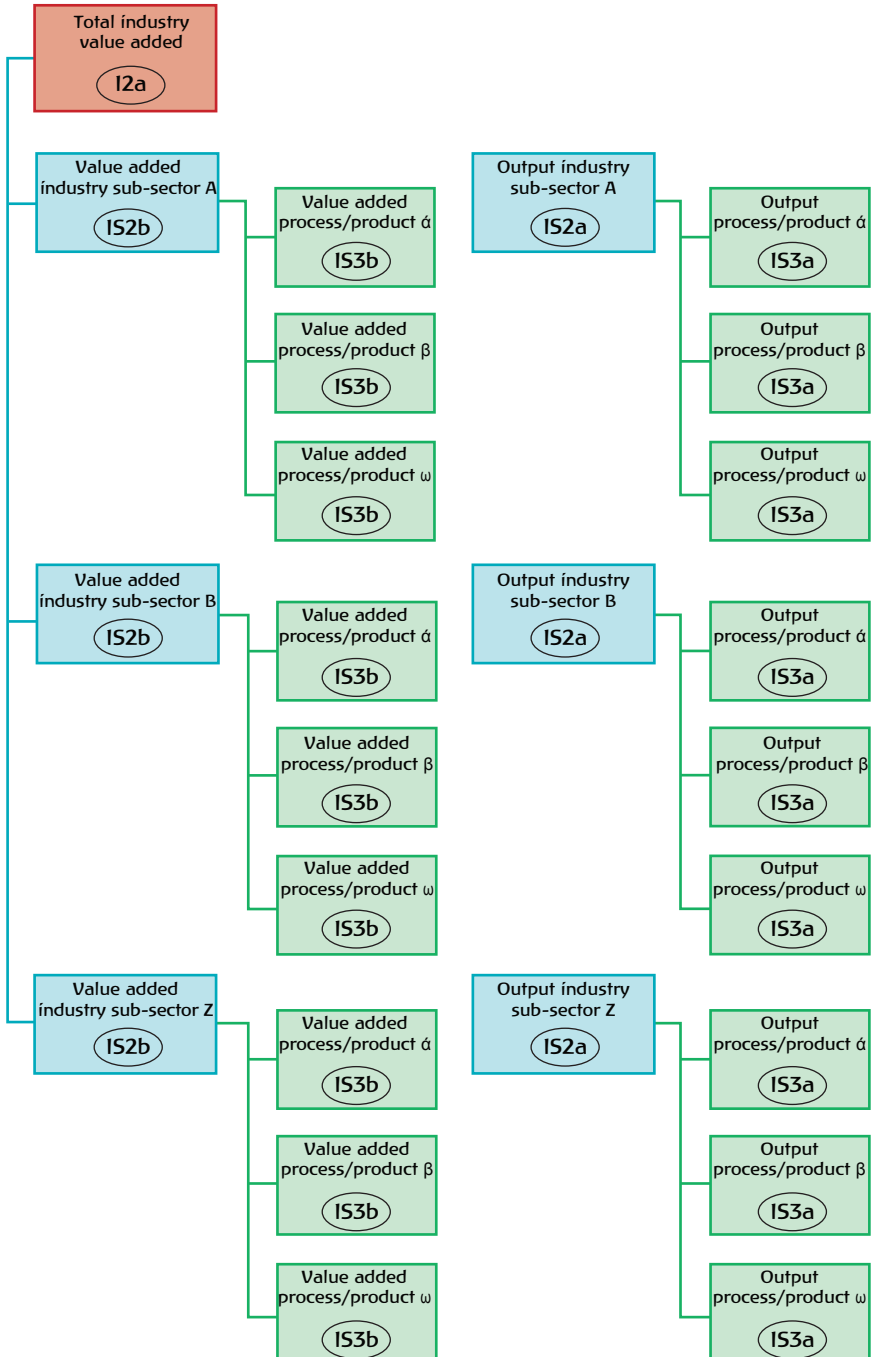

**Output of a sub-sectoral process/product type  $\alpha$  of the industry sub-sector A:**

This is the total physical production of a given sub-sectoral process or product type (e.g. the quantity of BOF steel within the iron and steel sub-sector, the quantity of ammonia within the petrochemical sub-sector, etc.), generally measured in volume or mass, depending on the product. This data is used as a denominator in (IS3a).

While Figure 6.8 shows the activity data needed for efficiency indicators at the sub-sectoral and process level, it should be emphasised once more that difficulties may arise if the output of a given sub-sector is not homogeneous and cannot be summed up. Only data referring to a specific process or physical output may be combined with respective energy consumption data to build meaningful energy efficiency indicators.

Table 6.3 presents an overview of main sources and methodologies often used to collect the data needed to build the indicators presented in the previous section. Individual methodologies will be described in the rest of this section.

**Table 6.3 • Summary of variables needed for industry indicators and examples of possible sources and methodologies**

Data	Source	Methodology
<b>Energy data</b>		
Total industry consumption	National energy balance	Administrative sources
Total sub-sectoral consumption	National energy balance Utilities	Administrative sources
Sub-sectoral process consumption	Manufacturers Industry associations*	Facility-level audit Measurements Surveys
<b>Activity data</b>		
Value added	National statistics offices National accounts International sources**	Administrative sources
Sub-sectoral production output	Manufacturers Industry associations*	Measurements Surveys
Process/product type output	Manufacturers Industry associations*	Facility-level audit Surveys
Equipment	Manufacturers Industry associations*	Administrative sources Surveys

\* Examples of industry associations are given in Box 6.1.

\*\* For example, the UN Industrial Development Organisation (UNIDO) International Yearbook of Industrial Statistics includes global estimates of value added, among a number of other variables, for ISIC economic activities, etc.

## 6 How to collect data?

Within the sample of submissions to the IEA, the most commonly used methodology to collect data for industry is national surveys. Models are often used to consolidate data and to extrapolate between survey years; in some cases, they are also used to estimate data for sectors that were under-represented or not included in surveys. For activity data, a number of countries rely on administrative sources.

The following sections describe the four methodologies for data collection, as applied to the industry sector, based on the submissions of practices received by the IEA.

## Administrative sources .....

Administrative data are already independently collected within the country, either from governmental bodies or from other national or international organisations. Many organisations rely on existing national surveys and energy statistics to estimate energy efficiency indicators.

The following description of administrative sources for the industry sector is based on the sample of practices received by the IEA. In addition, Box 6.1 lists selected national or international organisations that could provide useful information on industrial sub-sectors.

**Purpose of collecting administrative data:** Many organisations use existing administrative data, such as national energy statistics, to estimate energy consumption for the sector and its sub-sectors, and to compile energy balances. Others use such sources to additionally estimate intensity indicators, such as those per unit of physical output, or to estimate GHG emissions or performances, especially targeting one specific industrial sub-sector. In some cases, the collection of administrative data is driven by the need to monitor industry efficiency, when bound by national law. Administrative sources (e.g. national accounts statistics) are also used to collect value-added information.

**Data collected:** Data collected are mainly energy consumption data, often by energy source, for one or several sub-sectors. When the purpose is also to estimate indicators, the data collected include physical output.

**Sources:** Governmental offices and energy utilities are the most common sources. A number of sub-sectoral industry associations are an additional important source of national and global activity data. Examples include the International Aluminium Institute, the World Steel Association, the Cement Sustainability Initiative of the World Business Council, the Confederation of European Paper Industries.

**Cost associated with administrative data:** In most cases administrative data are available at no direct cost to organisations. Only two organisations noted that they needed to pay for the administrative data, and one noted the high cost to obtain industry data. Even if there is no direct cost, indirect costs derive from a number of steps needed: researching the existing sources, setting up agreements for data transfer and use, and transferring data to a format suitable for use.

**Main challenges:** One of the biggest challenges associated with the collection of administrative data is the time and effort to collect the data, including the need to develop relationships with the data providers, and to translate the data to a suitable format. Several respondents identified the definition of boundaries for some sub-sectors as an issue. Additional recurring problems are incomplete data and confidentiality.

## Surveying .....

Within the sample of practices submitted to the IEA, surveying is the most commonly used methodology for data collection in the industry sector. The following description is based on a sample of 29 submissions on industry surveying.



### Box 6.1 • Selected international sources for industry data

This section lists selected organisations that provide sub-sector industry data, at either the global, regional or country level. Data are collected from members, which are either companies or representatives of national industry associations or countries. This list is only indicative and by no means intends to be exhaustive.

#### **Chemical and petrochemical**

The **International Fertilizer Industry Association (IFA)** represents the global fertiliser industry with members from more than 85 countries. The collection of primary market data is among the IFA's principal missions. The IFA database contains historical production, trade and consumption statistics of nitrogen, phosphate and potash fertilisers by country/region<sup>(1)</sup>.

**Solomon Associates Inc.** set up the first widely used international benchmarking system for ethylene crackers in the 1990s. Companies that participate in the benchmark are requested to fill out a detailed survey on the performance of their units, including energy consumption, on a semi-annual basis. More than half of all world crackers participate in the survey, representing more than two-thirds of the total production capacity.

**IHS Chemical** is a private consulting firm that collects and maintains an extensive global database for five key chemical groups comprised of aromatics and fibres, olefins and derivatives, plastics and polymers, chloralkali and vinyls, and methanol and acetyls<sup>(2)</sup>.

#### **Iron and steel**

The **World Steel Association** is an international industry association covering 85% of the world's steel production. World Steel Statistics provides monthly and annual data on crude steel, BOF iron and DRI production<sup>(3)</sup>. The annual *Steel Statistical Yearbook* provides detailed country-level production statistics for a wide range of iron and steel products.

A number of regional associations also provide detailed production statistics for their region or country, including the **European Steel Association (Eurofer)**,<sup>(4)</sup> the **American Iron and Steel Institute**<sup>(5)</sup> and the **Japan Iron and Steel Federation**<sup>(6)</sup>.

#### **Cement**

The **Cement Sustainability Initiative (CSI)** is a global initiative made up of 24 major cement producers with operations in more than 100 countries. CSI manages the "Getting the Numbers Right" database of carbon dioxide (CO<sub>2</sub>) and energy performance information on the global cement industry<sup>(7)</sup>.

**Cembureau**, the European Cement Association, publishes the *World Statistical Review*, which provides information on cement production, imports, exports and total per capita consumption on a worldwide country basis<sup>(8)</sup>.

The **US Geological Survey** provides monthly and annual global cement production statistics<sup>(9)</sup>.

### **Pulp and paper**

The **Confederation of European Paper Industries** publishes annual key statistics for Europe compiled from national member associations. These statistics cover the production, consumption, exports, imports and energy use in the sector as well as recovery, trade and utilisation of recovered paper<sup>(10)</sup>.

The **UN Food and Agriculture Organization** compiles global statistics for annual production, import/export, consumption and production capacities for pulp and paper as well as data on the recovery, trade and utilisation of recovered paper<sup>(11)</sup>.

**RISI** maintains an extensive global pulp and paper mill database covering capacity, supply, demand, price, imports and exports, and production cost data<sup>(12)</sup>.

### **Aluminium**

The **International Aluminium Institute (IAI)** is an international industry association whose membership covers over 60% of global bauxite, alumina and aluminium production. IAI's statistical system provides regional production and capacity data for primary aluminium and alumina, as well as energy intensity and power consumption for primary aluminium smelting, energy intensity and fuel consumption for alumina refining, and statistics on fluoride emissions and perfluorocarbon emissions<sup>(13)</sup>.

(1) <http://www.fertilizer.org/ifa/ifadata/search>.

(2) <http://www.ihs.com/products/chemical/index.aspx>.

(3) <http://www.worldsteel.org/statistics/statistics-archive.html>.

(4) <http://www.eurofer.org/Facts%26Figures/Crude%20Steel%20Production/All%20Qualities.rpg>.

(5) <http://www.steel.org/en/About%20AISI/Statistics.aspx>.

(6) <http://www.jisf.or.jp/en/statistics/>.

(7) <http://www.wbcscement.org/index.php/key-issues/climate-protection/gnr-database>.

(8) <http://www.cembureau.be/world-statistical-review-2001-2010>.

(9) <http://minerals.usgs.gov/minerals/pubs/commodity/cement/>.

(10) <http://www.cepi.org/topics/statistics>.

(11) <http://faostat.fao.org/DesktopDefault.aspx?PageID=626&lang=en#ancor>.

(12) <http://www.risinfo.com/pages/product/pulp-paper/historical-data.jsp>.

(13) <http://www.world-aluminium.org/statistics/#data>.

**Survey purpose:** The key purpose of industry sector surveys is to track energy consumption over time, combined in many cases with tracking physical output, and computing GHG emissions. In some cases, surveys also serve to assess process efficiencies within the sector and to help countries to design and assess programmes and policies.

**Sub-sectors covered:** Most countries collect information on all industry sub-sectors, while some only target key sub-sectors, such as iron and steel, cement, aluminium, or pulp and paper.

**Sample design:** Countries collect industry data using a combination of industry census and sample-based surveying. Large sub-sectors having only a small number of facilities, such as pulp and paper, cement, aluminium, and iron and steel, can be surveyed using a census approach. For more heterogeneous sub-sectors, such as furniture or food, such an approach would be very cumbersome and costly. A stratified sample approach is more practical, but its drawback is the potential inclusion of sampling errors.

An appropriate design is required to choose a nationally representative sample. Industry associations tend to target all their members in data collection, as sharing annual activity and energy data is often one of the conditions of being a member. In sub-sectors including numerous facilities and heterogeneous outputs, the sample cut-off is generally decided based on number of employees, minimum volume of output, minimum average daily energy consumption or cumulated value added.

Sources to select the sample include lists of industry members, lists from tax agencies, other national surveys that already collect data from the same manufacturing sub-sector, and business registers.

**Sample size:** Sample sizes vary significantly across respondents, from up to 100 for surveys targeting one specific sub-sector, to several thousand (up to 150 000) for surveys targeting all manufacturing sub-sectors. In some cases the coverage was complete, while in others the coverage was based on a stratified sample. The sample size ranged from 1% to 100% of the target population, and averaged about one-third.

Countries need to establish early in the process the level of acceptable uncertainty arising from stratified surveys. Typically, a large sample size is correlated with lower error (high precision), but higher costs.

**Frequency:** The majority of the national industrial surveys that countries conduct occur on an annual basis. Some take place every two or three years. The regular frequency of the surveys ensures that trends in industry production and energy consumption are monitored closely.

**Incentives for the survey:** In more than half of the cases, surveys are mandatory. Within the mandatory surveys, only one-third carry penalties; other methods could include multiple reminders and individually pursuing respondents according to a given jurisdiction. In some instances non-cash incentives were provided to respondents, for example a promise of a final report including answers from all the respondents.

**Survey respondents:** In most cases responses came directly from operating facilities; in some cases from establishments (such as headquarters representing multiple facilities); in one case, from energy auditors.

**Response rate:** Response rate ranged anywhere between 20% and 100%, and was higher than 80% for more than half of the cases. Response rates tend to be higher with the involvement of industry associations, where all members participate and contribute with data reports.

**Collection methods:** In most instances there was an option to respond via paper format or via Internet/email. Although most surveys included paper forms as a tool for data collection, some surveys relied only on Internet-based methods. In addition, in a couple of cases, on-site, in-person interviews were added. Dedicated data collection Internet portals are gaining popularity over paper-based collection, due to the possibility of having automatic data checks and the opportunity to avoid human-based data entry errors.

**Time to complete a survey:** Depending on the number of questions, it took the respondents between 15 minutes and nine hours, with an average of two hours, to complete the survey. Additional time could be needed to gather all the necessary information in one place.

**Elements collected:** In all cases, data collection covered total energy consumption, and often consumption by key energy source. In several cases, collection also included production volumes, with the advantage of ensuring identical boundary definitions for energy and activity data to compute energy efficiency indicators where it is important to ensure that boundary definitions for energy and activity are overlapping. Other elements sometimes included were non-energy use (feedstock); energy use by different end uses, such as motors, boilers or lighting; and age of system equipment. Data collected were generally more detailed for surveys targeting one specific sub-sector and meant to analyse not only overall patterns of energy consumption, but also consumption at different stages in the process, intensities, process-related emissions, etc.

**Questionnaires – length and format:** Survey questionnaires have a variable length, from a couple of pages to more than 50 pages. Administrators need to always find the appropriate balance between length of questionnaire and depth of information collected, and respondent's burden. Some countries argued that questionnaires should be as short as possible to keep the burden response low. However, experience shows that an industrial survey of an average length of 50 pages can achieve an 80% response rate.

**Overall time for survey design, implementation and data processing:** The time spent on completing the survey process, a function of complexity, coverage and overall design, varied from about eight weeks to over four years, with an average of 36 weeks. The average lengths of the different phases were: 6 weeks for the design, 18 weeks for the implementation, 12 weeks for data processing, and 6 weeks for data publication.

**Costs associated with the survey:** In absolute terms, costs can vary from USD 10 000 to over USD 2 million. The cost is a reflection of the relative complexity and detail of data collected, and of the time of design and implementation of the survey. Costs are tightly linked with the labour needed, and vary largely across countries.

According to the approximate estimates of respondents within the sample of submissions received by the IEA, the implementation phase represented the largest share of the total cost, followed by data processing and by survey design.

**Main challenges faced in surveying:** The most commonly identified challenges for surveys were incomplete surveys, response quality, inconsistent responses and, to a lesser extent, a low response rate. Underlying reasons for poor quality were the lack of good understanding of terminology, energy market and industry in the staff; turnover in personnel; and more broadly, lack of resources needed to process and report data also on the respondent side.

It is essential to identify carefully the person responding to a survey, not only for continuity reasons, but also to ensure that the survey is filled out correctly. Also, ensuring that there is continuity in responses and proper documentation at the respondent's end will help in attaining higher quality in responses. In addition, survey frequency has an impact on data quality as one of the respondents noted that increasing the frequency to a two-year cycle would foster "continuity in institutional awareness and knowledge for both respondents and the staff".

**Possible improvements:** As mentioned, it is essential that staff members dealing with responses are familiar enough with terminology and energy markets to fill out the survey correctly. The shift away from paper to electronic format could also be instrumental in improving the response rate and quality of responses. The Internet interface, although representing an additional cost up front, may make the survey less costly in the long term, as errors or breaks in series could be detected immediately, and resources for data entry could be saved. Depending on the degree of complexity, such as cross-referencing of different data sources, such applications could rely on sophisticated custom systems or simply on spreadsheets with built-in macros.

Some other potential improvements include increasing sample size, conducting face-to-face interviews, increasing frequency of surveys to foster continuity and ensuring good communication with the various stakeholders involved, or simply emphasising up front the mandatory nature of the survey. Some respondents proposed the idea of a working group, with members from across interested organisations, such as ministries, research organisations and industry, to assess ways to improve the survey and quality of data collected.

## **Questions and Answers:**

### **Q5. Why would an Internet interface improve the overall survey quality?**

*Internet interfaces would ensure better quality of responses through built-in error and consistency checks; easier navigation for respondents; the possibility to have embedded calculations for respondent's reference; elimination of data keying errors and saving resources for the data entry task; and also, if enabled, real-time benchmarking with other respondents.*

## Measuring .....

Measuring in the industrial sector often occurs in the context of an energy audit. Energy audits are in-depth analysis and evaluation of energy use, for a number of purposes, such as optimising energy costs, controlling pollution or improving operating practices of a given system. They also represent effective ways to monitor and evaluate energy efficiency potentials at a given facility.

Beyond a simple plug-and-metering approach, energy auditing is a holistic analysis of a facility, including analysis of all energy inputs and outputs, usually carried out over an extended period of time by professionals, such as engineers, who understand in-depth how the industry sector works. In addition to measurements, energy auditors rely on a number of sources, such as energy bills, to collect data in a facility.

Within the sample of practices submitted to the IEA, only one practice covered measuring for industry, and specifically for the iron and steel sub-sector. The low rate of response may be due to confidentiality issues within the industry sector. The following sections, largely based on that practice, cannot be taken as a general description of the methodology, but can still be very relevant to countries designing a metering campaign.

**Measuring purpose:** The purpose of the metering exercise was to calculate the overall efficiency of a plant, and to optimise fuel utilisation within a facility, based on measurements of energy used at various stages in the process, as well as used as feedstock.

**Sample design and size:** The sample included all members of the iron and steel association, or all steel producers in Japan that agreed to submit data.

**Frequency:** This measurement exercise is carried out every year, although there was no information on the length of the monitoring period.

**Who took measurements and how:** Measurements were undertaken by energy auditors, with state-of-the-art measuring equipment, to collect high-quality data.

**Elements measured:** Data were collected for energy use at the different stages of production; for heat production and losses; for efficiency of combustion processes; for production output at various stages of a facility; and for non-energy use of feedstock.

**Energy sources monitored:** All energy sources were accounted for during the measuring exercise: oil and oil products, natural gas, coal, electricity purchased and self-generated, energy generated from renewable sources, biomass-based energy, and alternative sources such as industrial waste, plastic material and waste oil.

**Cost of measurements:** Measuring, or a facility-based energy audit, is likely the most expensive form of collecting data. It is therefore not very commonly used, despite the wealth of information that it can generate for saving energy.

**Recommendations:** Ensuring to take measurements based on the best available technology was highlighted as a major recommendation.

### Box 6.2 • Industry benchmarking

National average data do not account for variations in plant performance within a country. Therefore, benchmarking and/or auditing activities are needed to complement the indicators approach to better understand energy use in industry. Benchmarking is an approach used by a number of industries to evaluate the energy performance of their processes in relation to best practice, usually within their own industry. An overview of various industry benchmarking initiatives can be found in *Tracking Industrial Energy Efficiency and CO<sub>2</sub> Emissions* (IEA, 2007).

Detailed energy benchmarking studies are done on a regular basis in some industries, based on data provided by companies that operate plants. These studies are usually done on a global basis and individual plants are not identified for antitrust reasons. Usually, these studies are confidential and the benchmarking activities are often limited to the main producers in industrialised countries.

This can create a bias in favour of the more efficient plants, which overestimates the industry's average energy efficiency. Benchmarking generally focuses on plants based on the same industrial process and similar product quality. Benchmarking is therefore not suited to evaluate some improvement options such as process integration, feedstock substitution, recycling or energy recovery from waste materials. The same caveats apply for benchmarking and for indicators; the results are influenced by methodological choices. Important efforts are continuing in many industries to expand and improve international benchmarking.

## Modelling

As with the other sectors, modelling is an essential component in estimating energy data for the industry sector. It is used by itself, or as a complement to other data collection initiatives, primarily – but not only – to estimate energy consumption. The key steps of a modelling work include establishing the modelling framework, setting model assumptions, inputting data, running the model, validating its outcomes against data and analysing results. The following sections are based on the seven practices submitted to the IEA for industry sector modelling.

**Model purpose:** In the industry sector, models are used to estimate patterns of energy consumption, sometimes together with GHG emissions, for one or more key industry sub-sectors. Other purposes are to estimate more detailed indicators such as process efficiency at various stages of the production, or technology diffusion. When used as a complement to an existing survey, model studies can help reduce variations due to sampling errors. Models can also forecast energy consumption based on historical trends.

Some model works can be further expanded to include policy impact from potential carbon tax schemes or other regulatory measures. Model built with greater detail of

industrial process flows can be used to assess potential for fuel switching and technology evolution in a particular industrial sub-sector.

**Sub-sectors covered:** Model exercises cover all manufacturing sectors in many cases, although specific studies, especially performed by an industry association, can target only a key sub-sector.

**Model type:** As for the other sectors, modelling for industry can be based on a top-down approach, based on macroeconomic variables in the absence of detailed energy end-use data, or based on a bottom-up approach, when energy input and output flows into the different manufacturing sub-sectors are known. The majority of the practices submitted to the IEA rely on a bottom-up approach, to obtain a closer representation of the physical properties of the industry sector. In some cases, the bottom-up engineering model includes process-level detail and technology diffusion within key individual industry sub-sectors.

**Source of the model:** The majority of models are custom-built, but some could be derived from existing models. Tapping into an existing model has the advantages of saving time, and of potentially learning from other people using the same model. A top-down model could be easily built with existing statistical econometric software, while setting up a bottom-up model could be done using spreadsheet software.

**Validation of modelling outcome:** Most of the respondents validated their model outcomes against national energy statistics references such as the official national energy balances. In other cases, model studies were peer reviewed. Undertaking the modelling exercise on an annual basis, as done in several cases, would ensure continuity over time of up-to-date outcomes.

**Time required:** Developing of a robust model includes a number of steps, such as developing the model's framework, updating the model with input data and assumptions, verifying and validating results, and then analysing them. Depending on the complexity, the development of the model could range from one to nine months. These time frames were estimates based on a model already being there and having to do additional model modifications. Any additional changes to existing model and modifications could take anywhere from 2 weeks to 30 weeks. Similarly, based on the responses received, updating models with input data and new assumptions could take another 2 to 15 weeks. Verification and validation of the model against national energy statistics or energy balances was estimated to take three to five weeks. While the analysis portion was presented to take two to three weeks, this portion could take longer as it could be intertwined with the portion of updating data inputs and assumptions.

In addition, there could be follow-up maintenance costs such as a licence or consulting fees to continually keep the model up to date. The labour cost associated with building a desired model will make a difference on the final cost.

**Frequency:** National bodies undertaking industry modelling studies tend to update them on an annual basis. International associations or research centres may update them less frequently.

**Key model inputs:** Model input data and assumptions vary depending on the complexity of the model and on whether the model is top-down or bottom-up. Within industry modelling, it is common to use a combination of macroeconomic variables



with historical growth rate patterns of sectoral variables. Of course, assumptions on the sectoral future evolution are needed if the model also is used for projection purposes.

The most common inputs include historical production volumes of given industry sub-sectors, projected and historical industry growth rate, energy conversion factors, and industrial fuel consumption. Other inputs include historical energy prices, technology and process evolution and assumptions on technology and capacity, fuel switching capability, and industrial process flows.

**Key model outputs:** For most respondents, key model outputs were estimates of the total energy use for each industry sub-sector and associated GHG emissions. Models with the capability for projections went one step further to look at estimates of industry growth output and corresponding energy consumption. Bottom-up engineering models can also be used to assess detailed energy flows at various stages of the production process within a given sub-sector; these models can be also designed to study technology diffusion within the sub-sector.

**Main challenges:** Quality of a modelling result strictly relies on quality of input and assumptions. The key challenge identified by the majority of respondents is the lack of availability of input data. Respondents also noted quality control issues with existing input data, and challenges associated with data assumption and definitions. Lack of good modelling documentation was also noted, showing that documentation plays an integral role in the development of sound energy time-series data.

The lack of input data clearly implies the need to carry out national industry surveys on a regular basis. Without sustained reliable national data, it will be impossible to assess progress and potential for policy options.

**Key recommendations:** Some of the recommendations include designing procedures to estimate energy use for industry sub-sectors that were not covered by surveys because of the cut-off at the minimum number of employees. Other recommendations referred to increasing the detail of industry models to include information on investment costs and energy prices, higher technology detail for industry branches of interest, and information on the equipment life cycle, but also a robust treatment of uncertainties.

A more general key recommendation refers to the commitment from the organisation to allocate resources for ongoing modelling and modelling capacity. A model that produces good results could take as much as 15 years of teamwork and most-up-to-date technology updates.

# Collecting What and How for the Transport Sector

## 1 What does the transport sector mean and cover?

In the framework of energy balances and energy efficiency indicators, the transport sector covers the use of energy for transportation of people (passenger transport) and goods (freight transport) within any economic activity or end-use sectors (residential, services, etc.). Therefore, when addressing energy efficiency indicators, transport is not linked to any specific economic activity<sup>1</sup>. For example, energy consumption for transport consumption includes fuel use of private cars, company fleets, trains, trucks transporting goods, domestic ships and airplanes, etc.

For the purposes of energy efficiency indicators, the transport sector covers only transportation within national boundaries, excluding consumption for international aviation bunkers and international marine bunkers. Consumption in the transport sector also excludes fuels delivered for off-road use and stationary engines, as well as military consumption, pipeline transport and transport not elsewhere specified, even if these activities can be significant for some countries.

At the level of national energy balances, transport is generally disaggregated into four sub-sectors: road, rail, domestic aviation and domestic navigation. These four sub-sectors are also used for energy efficiency indicators. However, since energy efficiency indicators for transport focus exclusively on transportation within national boundaries, for sake of simplicity, domestic navigation can also be called water by analogy with road and rail, and domestic aviation can be called air. This is the terminology which will be used in this manual.

Moreover, in some analyses and publications, road, rail, air and water as well as the different vehicle types used in each case, are indifferently referred to as “modes” of transportation. For consistency across chapters, this manual uses the term “sub-sector” for the higher level of aggregation (e.g. road), and “mode/vehicle type” for the lower level of disaggregation (e.g. light-duty vehicles).

Each sub-sector is in fact characterised by a number of different modes/vehicle types. For example, road includes cars, sport utility vehicles (SUVs), personal light trucks, motorcycles and buses for passenger transport, and freight and commercial vehicles for freight transport. For each sub-sector, the distinction between the two different segments of passenger and freight transport is very important for the purposes of energy efficiency indicators, as very different factors drive the two segments. A more comprehensive scheme of segments, sub-sectors and types of vehicles is provided in Table 7.1, later in this chapter.

1. Following the UN International Recommendations on Energy Statistics (IRES), transport includes “consumption of fuels and electricity used to transport goods or persons between points of departure and destination within the national territory irrespective of the economic sector within which the activity occurs.”

## Questions and Answers

### **Q1. Does transport cover all modes of transportation?**

No, in energy efficiency analysis transportation covers only transport modes using commercial energy. As a consequence, cycling, walking or sailing, for instance, are not covered, even though these modes could represent sizeable activities in terms of passenger-kilometres (pkm).

### **Q2. What if consumption in the transport sector is double-counted in other economic sectors (e.g. residential, services)?**

As mentioned in the residential and the services chapters, the energy consumption of these sectors should not include any consumption related to transport in these sectors (daily commuting to and from work, etc.). Therefore, transport consumption should be exclusively reported in the transport sector.

### **Q3. Is energy consumption within railway stations, airports and ports included in transport?**

As only fuel consumed for transportation should be included within the transport sector, consumption in infrastructures, for example oil used for heating a station, a terminal, a warehouse, etc., should be excluded and reported under the relevant services categories. In addition, fuels used by airlines for their road vehicles should be excluded from aviation consumption.

### **Q4. Is international transport included in energy efficiency analyses?**

When transportation crosses national boundaries, it is very challenging to attribute energy consumption to a single country. Therefore, a country energy efficiency analysis considers only domestic transport. However, international transport is a significant contributor to global transport energy consumption and emissions. If an energy efficiency analysis were to be performed on international transport, the same type of indicators and approaches as those for domestic transport should be considered, for international aviation or marine transport, but also international railway or road transport. To this purpose, some international institutions collecting global information on activities by mode could be considered as relevant administrative sources. A short and not comprehensive list will be presented in Box 7.2.

### **Q5. What is “fuel tourism”? How does one deal with it?**

*The concept of “fuel tourism” refers to consumers from neighbouring countries crossing the borders to purchase fuel at a cheaper price, contributing significantly to the total national fuel sales. Generally due to significant price differentials, it has generally very visible effects in countries where domestic consumption is not very large. In these cases, national consumption statistics, based on fuel sales, would not match national transport activity data. Cross-border traffic estimation practices exist to adjust the data before computing energy efficiency indicators. An example of country practice described in the Handbook on Statistics on Road Traffic (UNECE, 2007) relies on counting vehicles crossing the border and interviewing drivers at service stations. Collection and comparison of price data across countries can also help to estimate the size of the phenomenon.*

### **Q6. How is cross-border traffic counted?**

*Data on energy consumption from energy balances include consumption of foreign vehicles on the territory and exclude consumption of national vehicles abroad. Conversely, activity data, when collected mainly through odometer readings or national surveys, include activity abroad for the national fleet and exclude foreign vehicle activity. Often, it is assumed that the two volumes compensate each other, but this assumption is not always correct. Cross-border traffic may be influenced by differences in level of income, prices, production and tourism between countries. In such cases, to have an exact match between energy and activity data for indicators, both kilometres travelled on national territory by foreign vehicles and kilometres travelled abroad by national vehicles would have to be estimated using other data sources, such as national or foreign statistics on tourism for passenger transport, or journey log studies for freight. However, such data do not always exist and when they exist they may not be harmonised from a country to another one.*

## **2 Why is the transport sector important?**

Globally, in 2011 the transport sector accounted for 27% of total final energy consumption (TFC), up from 23% in 1973, with almost three-quarters of its consumption due to road transport. Driven by increasing demand especially in non-member countries of the Organisation for Economic Co-operation and Development (OECD), transport is expected to maintain a very prominent role within global energy demand of the next few decades.

Figure 7.1 • Share of the transport sector in the total final consumption of selected countries (2011)

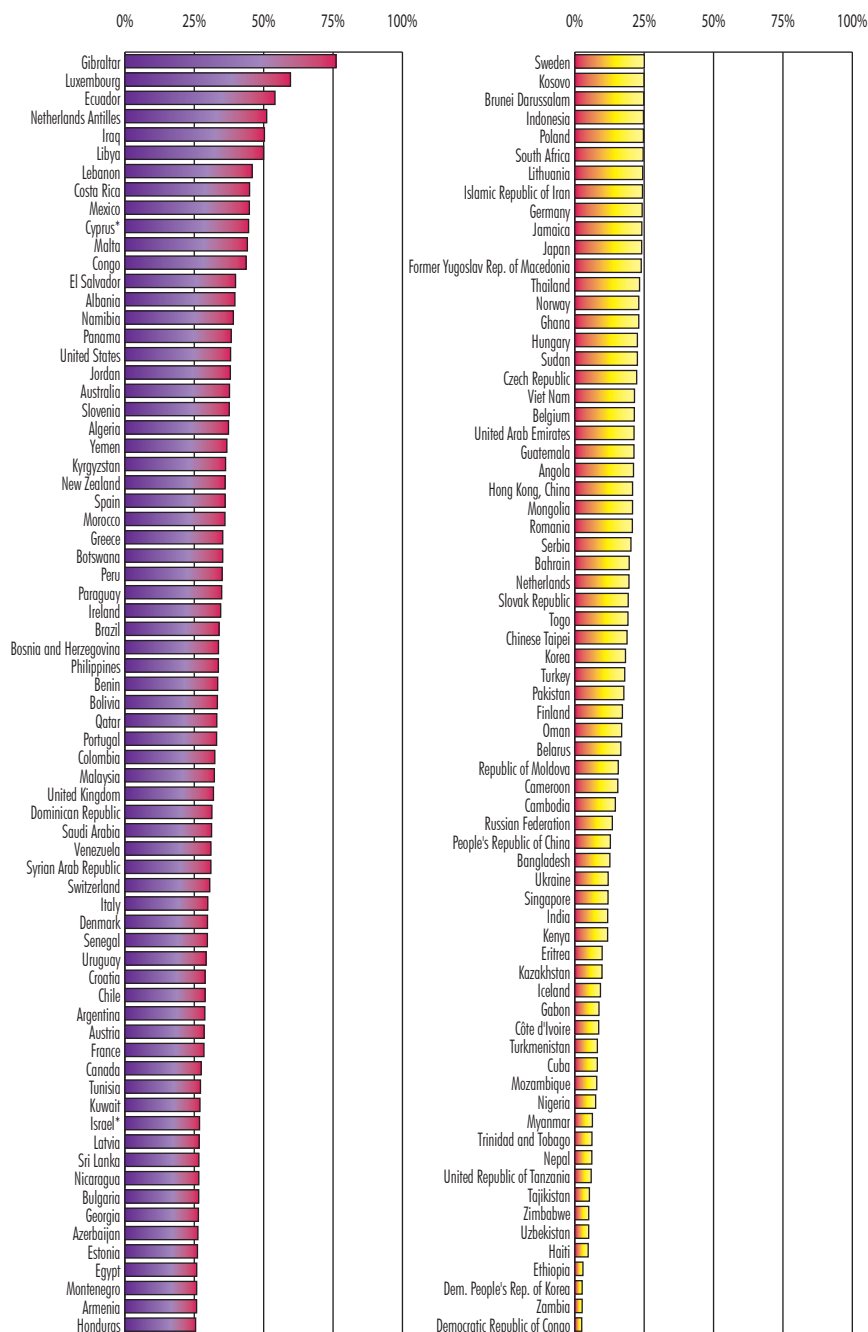

Note: unless otherwise indicated, all tables and figures in this chapter derive from IEA data and analysis.

\* See Annex F.

The importance of the transport sector within national TFC varies a lot across countries, as shown in Figure 7.1. Although transport accounts for over one-third of TFC in the majority of countries, the shares range from a few percent to over 50%. As with the other end-use sectors, data quality and coverage vary across countries, and these data should only be used with caution as a preliminary indication of the relative weight of transport in TFC. For instance, some countries may include international bunkers in domestic transport; others could have included consumption for transport in the residential or other sectors.

Several factors influence the share of the transport sector in TFC, including the size of the country, the density of population, the percentage of people living in large cities, gross domestic product (GDP) per capita, the number of cars per household, and the economic structure and the share of other sectors in TFC.

As the share of the transport sector energy consumption in TFC varies widely from country to country, so do the respective shares of energy sources consumed in the sector, as shown in Figure 7.2.

Globally, the transport sector accounts for 62% of final oil consumption, 5% of total biofuels and 2% of natural gas and electricity TFC. For biofuels, if the share of transport is “only” 5%, it is because of the weight of solid biofuels (mainly fuelwood in the residential sector) in TFC; in terms of liquid biofuels, the transport sector would represent 98% of global TFC.

**Figure 7.2 • Share of the transport sector in the world total final consumption for selected energy sources (2011)**

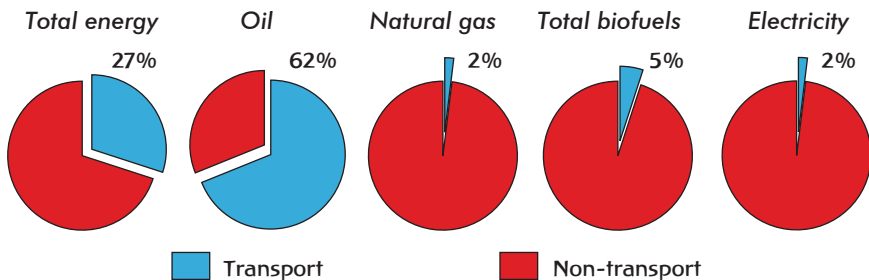

In terms of share of energy sources, there is still some variability among countries, although less than for other end-use sectors due to the generally large share of oil. For example, transport accounts for 73% of oil consumption in the United States, but only for 44% in Japan, where oil is also widely used in industry and other sectors. For natural gas, shares are relatively high in those countries with a large penetration of compressed natural gas (CNG) vehicles. The share for total biofuels can also vary a lot from country to country; it is particularly high for Brazil at 23%, due to the policy in place for boosting the use of bioethanol.

When looking at the share of each energy source in the consumption of the transport sector, as shown in Figure 7.3, oil has historically been the predominant energy source, with global shares higher than 90%. Conversely, transport drives global demand for oil, accounting for almost two-thirds of its final consumption. Examples of other sources, still covering small percentages of transport consumption, include electricity, liquid biofuels and CNG.

**Figure 7.3 • Share of the various sources in the world transport energy consumption**

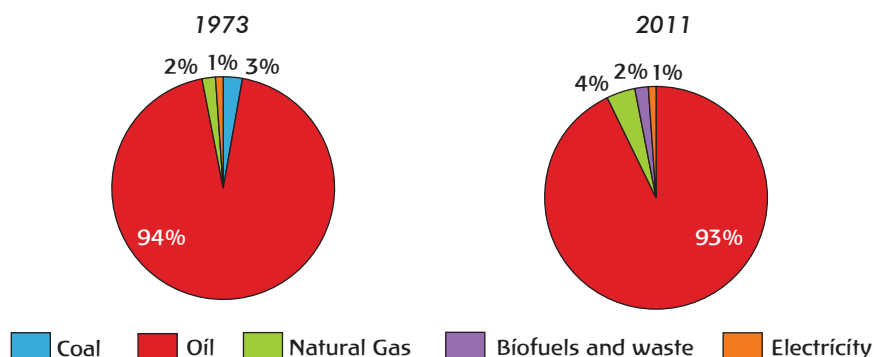

As mentioned above, unlike for other end-use sectors, the country-to-country variability of fuel shares is limited. The share of oil in transport energy consumption is in fact larger than 90% in the vast majority of countries. Some exceptions are Brazil (80%), because of the rather large consumption of biofuels in transport; and a number of countries with significant consumption of natural gas. In many countries, electricity also appears as energy source for transport, though only providing very little shares. The shares of the various sub-sectors in the total transport sector of course have impacts on the energy mix. For example, the development of electric cars and incentives given to freight transport by rail could further increase the share of electricity in the total transport energy mix.

As mentioned earlier, transport drives global demand for oil, accounting for almost two-thirds of its final consumption. In fact, taking into account the current stock of road vehicles, the transport sector is a captive market for oil and is more dependent on the global oil situation than any other end-use sector. As a consequence, policy makers know very well how important transport is in terms of energy policy. Besides policy makers, many other players can also influence the structure and the consumption of the sector: city planners, car manufacturers, households, transport companies, energy companies, etc

### 3 What are the main sub-sectors and modes driving transport consumption?

For the analysis of energy and efficiency trends, the transport sector is disaggregated into passenger and freight transport segments. For both segments, data are broken down by sub-sectors: road, rail, air and water, each of them characterised by a number of different modes/vehicle types. Generally, countries developing detailed indicators for road transport perform a disaggregation by vehicle type. The level of disaggregation depends on the structure of the road transport in each country; it also depends on the availability of data for different disaggregation and the resources available to develop data and indicators. For example, in Asian countries powered 2- and 3-wheelers are very popular vehicle types, while they represent only marginal shares in most Nordic countries. A possible disaggregation is presented schematically in Table 7.1

**Table 7.1 • Selected modes/vehicle types by segment and sub-sector**

Segment	Passenger	Freight
Sub-sector		
Road	Powered 2- to 4- wheelers Passenger light-duty vehicles (PLDVs) Buses	Freight light-duty vehicles Heavy-duty vehicles (HDV) Other
Rail	Passenger trains	Freight trains
Air	Passenger airplanes	Freight airplanes
Water	Passenger ships	Freight ships

For each vehicle type, a further disaggregation into fuel type can be performed, for example into gasoline and diesel (but biofuels, CNG and electricity are also possible) for cars; gasoline and diesel for light freight, electricity and diesel for trains, etc.

A more comprehensive description of vehicle types for the various sub-sectors is provided by the *Illustrated Glossary for Transport Statistics* (ITF, 2009), developed to promote harmonisation of transport-related terms and to assist countries in collecting activity data for transport.

## Passenger transport .....

**Road:** Passenger road transport includes the movement of passengers on roads within the national boundaries. Road vehicles include PLDVs – vehicles carrying up to eight persons, such as cars, minivans, SUVs and personal-use pickup trucks<sup>2</sup>; powered 2- to 4-wheeled road motor vehicles not exceeding 400 kilograms; and buses (mini-coaches, trolleybuses, minibuses and bus vehicles, designed to carry more than 24 passengers). Note that passenger cars cover a number of categories, such as taxis, hire cars, ambulances and motor homes. Globally, road dominates passenger transport. It heavily relies on oil products, mainly motor gasoline and gas/diesel oil, although other sources, such as biofuels, CNG and electricity, provide small contributions.

**Rail:** Passenger rail transport includes any movement of passengers through railway, on a given railway network, regional, urban or suburban, within the national boundaries. Passenger rail transport includes trains, metro vehicles and trams (streetcars). Rail transport can be powered by electricity, diesel or steam.

**Air:** Passenger air transport includes passenger airplanes, aircrafts configured for the transport of passengers, used for domestic travels. Airplanes mostly use jet kerosene (high-quality fuel suitable for compression ignition engines or turbine engines), but some models (spark-ignited internal combustion engines) could also use aviation gasoline, which covers about 2% of total aviation consumption.

**Water:** Passenger water transport covers the movement of passengers, by any kind of vessel, boat or ship, undertaken at sea, or on lakes and rivers, within the national

2. Note that in some countries pick-up trucks are reported either in passenger transport or freight transport according to their main use. In any case, it would be important to avoid double counting.



boundaries. International water transport is excluded from national totals, while inland waterways transport is included. Although the importance of sea travel for passengers has decreased due to aviation, sea travel is still effective for short trips and pleasure cruises. Globally, diesel oil is used for about two-thirds of consumption for domestic navigation, while residual fuel oil or heavy fuel oil is used for the other third. Motor gasoline also represents a small contribution to total water transport consumption.

## Freight transport .....

**Road:** Freight road transport covers the movement of goods within the national boundaries by road vehicles designed, exclusively or primarily, to carry goods: light-duty freight vehicles (vans and pickups), heavy-duty goods vehicles (trucks or lorries), road tractors, and agricultural tractors permitted to use roads open to public traffic. Trucks are responsible for the vast majority of fuel consumption in freight transport, which is mainly provided by gas/diesel oil. Light freight vehicles can use either gasoline or gas/diesel oil. There is also recent interest in liquefied natural gas as a freight transport, as well as compressed natural gas and biofuels.

**Rail:** Freight rail transport includes any movement of goods by railway vehicles on a given railway network, regional, urban or suburban, within the national boundaries. Rail transport can be powered by electricity, diesel or steam.

**Air:** Freight air transport covers the movement of goods by aircrafts configured for the transport of freight or mail, operating within the national boundaries. Airplanes mostly use jet kerosene (high-quality fuel suitable for compression ignition engines or turbine engines), but some models (spark-ignited internal combustion engines) could also use aviation gasoline.

**Water:** Freight water transport covers the movement of goods by any kind of vessel, boat, barge or ship, undertaken at sea, or over lakes and rivers, within the national boundaries. International water transport is excluded from national totals, although it has been the largest carrier of freight throughout recorded history. Globally, about two-thirds of consumption for domestic navigation comes from gas/diesel oil, while almost one-third comes from residual fuel oil or heavy fuel oil.

## Questions and Answers

### Q7. What is modal shift?

*A modal shift occurs when the shares in activity among different modes change, for example when in time more passengers decide to use trains instead of cars for their travels, or freight is moved through rail instead of trucks. A modal shift can also be considered as efficiency, as the transport system might be used more efficiently even though the specific vehicle efficiency may not have improved.*

### Q8. How should multiple-segment transport be accounted for?

Multiple-segment transport means that the same travel covers both passenger and freight transport. An example is when airplanes or trains carry passengers but also transport freight (including baggage and mail); another example is when passengers embark on a freight ship. It is advisable to split the energy consumption by segment based on the load, especially when the contributions of each segment to energy consumption are significant. This is the case of freight carried in passenger planes – a very significant share of the total air freight. However, those travels where one segment clearly dominates the total consumption should be included under the segment of the main purposes of the trip, i.e. classify transport as freight travel for a freight ship also carrying passengers.

Figure 7.4 shows the breakdown of total transport energy consumption by sub-sector for the world. Road dominates transport, with 90% of energy consumption for the sector, up from about 80% in 1973. Due to a lack of disaggregated data for passenger and freight consumption in many countries, it is not possible at this stage to provide world average shares by sub-sector for each of the two segments. As mentioned earlier, the two segments should however be analysed separately when data are available.

**Figure 7.4** • Energy consumption by sub-sector for the world total transport consumption\*

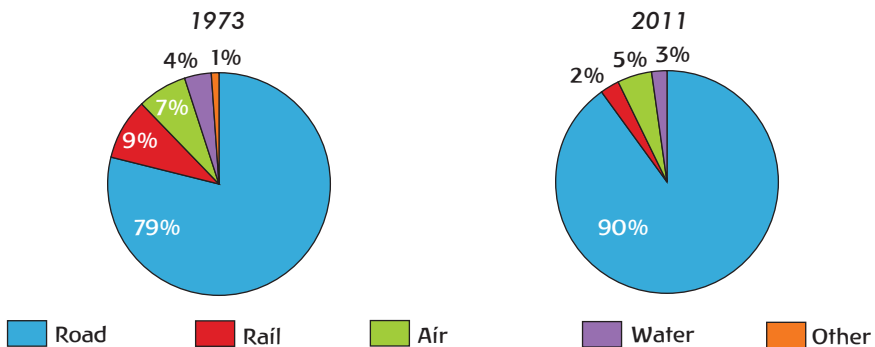

\* Excluding international transport.

Figure 7.5 gives the breakdown of the passenger and freight consumption by sub-sector for a set of OECD member countries for which disaggregated data are available. Road data are further disaggregated into vehicle types for passenger transport; for freight, road transport is dominated by heavy-duty vehicles (trucks). Passenger transport accounts for about two-thirds of transport consumption within OECD countries.

**Figure 7.5** • Energy consumption by sub-sector and mode/vehicle type for passenger transport and freight transport (for a total of 23 OECD countries, 2010)

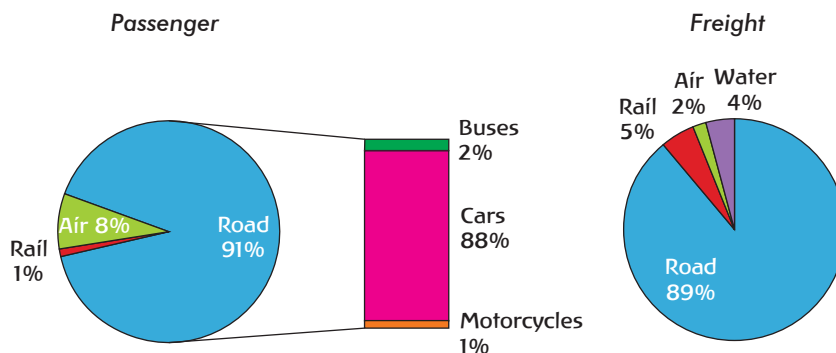

Globally, transport consumption is dominated by road transport (90%); this is also true when data are disaggregated into freight and passenger segments, for a sample of OECD countries. For passenger transport, light-duty vehicles, mainly cars, are dominant (88%), and air represents the second-most-important sub-sector (8%). For freight transport, heavy-duty vehicles are dominant (89%), followed by rail (5%) and water (4%).

If relevant data are available, a further disaggregation into type of energy used can also be conducted. This is the case for the sample of 23 OECD countries: Figure 7.6 shows that three-quarters of passenger transport relies on motor gasoline, while three-quarters of freight transport relies on diesel. These shares may change over time, however, as demonstrated by the significant increase in the use of diesel for cars, for example in Europe.

**Figure 7.6** • Energy consumption by energy source for passenger transport and freight transport (for a total of 23 OECD countries, 2010)

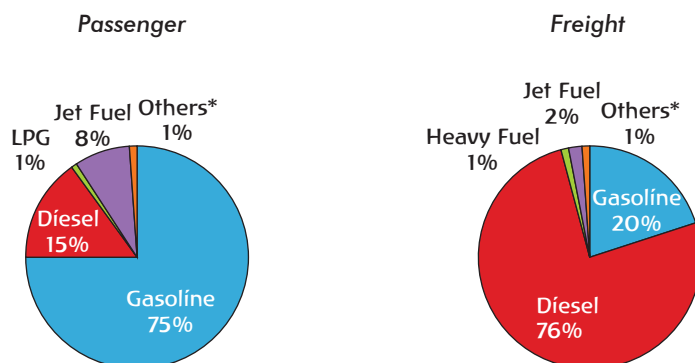

\* Others includes heavy fuel, natural gas, electricity and coal (passenger); and liquefied petroleum gas, natural gas, electricity and coal (freight).

## 4 What are the most frequently used indicators?

Depending on the availability of data, one can build very disaggregated indicators, or stay at a level that, although providing information on the sector, may be too aggregated to be meaningful for energy efficiency analysis.

The most aggregated indicators include, for instance, the share of the transport sector in TFC; the consumption of a given sub-sector, such as rail, road, water or air; or the consumption of a given segment, such as passenger or freight. While these indicators allow very rough comparisons over time among countries (however often misleading), they cannot be considered indicators of energy efficiency as such. For meaningful energy efficiency indicators, more disaggregated energy and activity data are needed, as described in the following paragraphs.

Similar to the other end-use sectors, for the overall transport sector, as well as for each of its segments, indicators can be defined using a pyramidal approach from an aggregated level (for instance, the share of passenger transport in total transport consumption) to very disaggregated indicators (for example, for each type of vehicle, consumption per pkm). The wider the pyramid, the more detail that is required. Three levels have been used in this pyramidal approach, level 1 being the most aggregated one, and level 3 being the most disaggregated one. Moreover, for reasons of simplification, short three-character code names have been given to each indicator to identify the end use and the level of the indicator.

Indicators starting with a **T** relate to the overall Transport sector (including both passenger and freight), those with a **P** to Passenger transport, those with an **F** to Freight transport. The number that follows relates to the level of disaggregation, 1 being the most aggregated and 3 the most disaggregated. The main function of the third character, a letter, is to differentiate indicators of same end use and same level. As an illustration, indicator (**P2b**) is an indicator of second-level for passenger transport – in that particular case, passenger transport consumption per vehicle-kilometre (vkm). **The preferred indicator for a given sub-sector is marked with a smiley face (☺).**

### Total transport sector .....

As with other end-use sectors, the pyramid for the transport sector is based on aggregated data, both for energy and for activity. For the transport sector as a whole, it is actually impossible to define an overall activity measure, as the two main transport segments, passengers and freight, are driven by very different dynamics. As a consequence, it is not possible to define any energy efficiency indicator at the overall sectoral level. All the indicators shown in the pyramid, without being energy efficiency indicators, can still provide useful aggregated information on the consumption in transport in the absence of more disaggregated data.

The most aggregated level, level 1, refers to the overall consumption of energy for the transport sector expressed either in absolute terms or in percentage of TFC (T1a), and to the share of each energy source in the total transport consumption mix (T1b). As transport is the main end use driving oil consumption, the third aggregated indicator refers to the transport oil consumption, either absolute or as a share of oil final

consumption (T1c). These three energy indicators provide a high-level picture of the sectoral consumption, and could allow a first comparison across countries.

**Figure 7.7 • Pyramid of transport indicators**

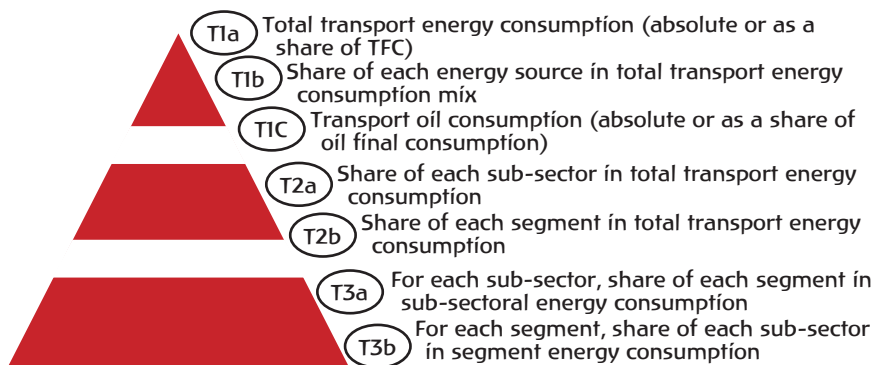

At the intermediate level, level 2, the pyramid shows two energy indicators: the share of each sub-sector in total transport consumption (T2a) and the share of each segment in total transport consumption (T2b). Data for (T2a), such as road, rail, air or water transport energy consumption, are generally available at the national energy balance level, while data for (T2b), such as passenger and freight consumption, are generally not.

The third level of the pyramid refers to two types of energy indicators. (T3a) expresses the shares of the two segments in the total energy consumption of each sub-sector. For example, it could indicate the share of passenger transport within road energy consumption, while (T3b) expresses the shares of the four sub-sectors in the total energy consumption of each segment. For example, it could indicate the share of rail in freight transport energy consumption.

As mentioned above, different driving factors are affecting consumption of the two transport segments. Therefore, it is advisable that energy efficiency indicators be definitely developed separately for passenger and freight transport, as discussed in the following sections.

## Passenger transport .....

Similar to other end-use sectors, depending on the availability of data and on the purpose of the analysis, passenger transport can be described by a variety of indicators.

At the most aggregated level, level 1, the top-level indicator (P1a) is the overall consumption of passenger transport, expressed either in absolute terms or in percentage of total consumption of the transport sector. Even though this is not an indicator of efficiency, this energy indicator does provide a first clue to the absolute and relative weight of passenger transport in the total transport consumption. It can be used to assess for example to what extent passenger transport could be relevant in terms of potential energy savings.

The second indicator of level 1 (P1b) is the share of each energy source in the total passenger transport consumption mix. Once again, even though not an actual indication of efficiency, this energy indicator describes the relative reliance on various fuels in the passenger transport energy consumption mix. As transport is the main end use driving oil consumption, the third indicator of level 1 (P1c) refers to the oil consumption for passenger transport, either absolute or as a share of total final oil consumption.

**Figure 7.8 • Pyramid of passenger transport indicators**

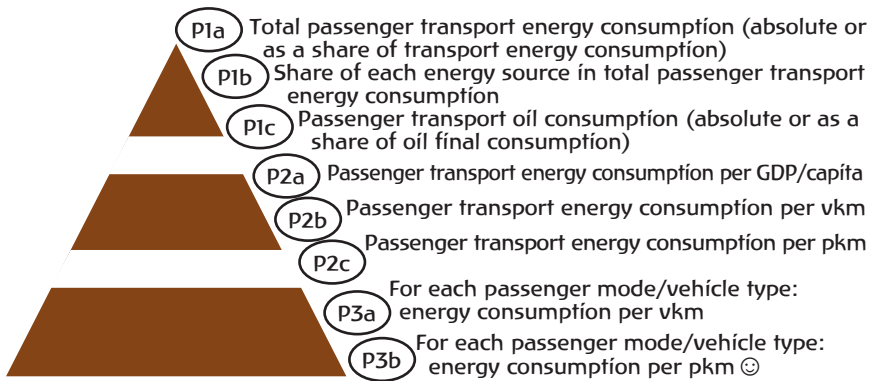

The intermediate level, level 2, proposes three indicators of intensity: passenger transport per GDP/capita (P2a), per vkm (P2b), and per pkm (P2c). (P2a), although very simple, is meaningful to assess trends over time or to compare countries with each other. Trends in GDP per capita are often used to estimate passenger transport trends in the absence of better data. (P2b) and (P2c) more closely relate to energy efficiency, as they are ratios between energy use and activity data, although at the aggregated segment level.

While the intensity per vkm relates to the specific vehicle efficiency, the intensity per pkm also depends on the “usage efficiency”: using one vehicle to move three people is more efficient than using three vehicles. Such indicator at the overall segment level may provide an overview of the impact of “modal shift”. Box 7.1 presents the calculation of vkm and pkm, starting from basic activity data such as vehicle stock and average occupancy of vehicles.

Ideally, efficiency indicators would need to be developed at the third level, with a further disaggregation by sub-sector and, if possible, passenger mode/vehicle type. In fact, the overall passenger intensities for a given country are influenced by both the intensities of each sub-sector and the share of each sub-sector in passenger transport.

At the third level, the pyramid proposes consumption per vkm (P3a) and per pkm (P3b), both computed for each sub-sector or mode/vehicle type. For example, while at the second level (P2b) represents the consumption per vkm for the overall passenger transport, (P3a) represents the consumption per vkm separately for road, rail, air and water passenger transport. While for rail, air and water, intensities by sub-sector are already useful to help develop transportation energy policies, for

road transport a further disaggregation by vehicle type is preferable (for example: light-duty vehicles, buses, powered 2- and 3-wheelers), as the relative share of these different types of vehicles could significantly impact the overall energy intensity for road. Light-duty vehicles, for example, generally have much higher intensities per pkm than buses or trains. **The recommended indicator for passenger transport is (P3b), energy consumption per pkm for each mode/vehicle type.**

As for the indicators at the second level, the intensity per pkm also takes into account the “usage efficiency”. For example, increased efficiency of aircraft engines impacts both intensities, but changes in average occupancy of airplanes only affect the pkm intensity.

## Freight transport .....

The pyramid for freight transport is similar to that for passenger transport.

**Figure 7.9 • Pyramid of freight transport indicators**

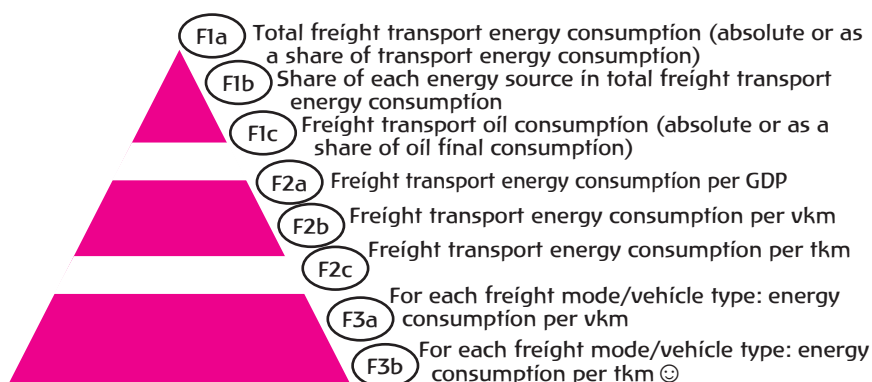

At the first level, the top-level indicator (F1a) is the overall consumption of freight transport, expressed either in absolute terms or in percentage of total consumption of the transport sector. Even though this is not an indicator of efficiency, it does provide a first indication of the absolute and relative weight of freight transport in total transport consumption. It can be used to assess for example to what extent freight transport could be relevant in terms of potential energy savings.

The second indicator of level 1 (F1b) is the share of each energy source in the total freight transport consumption mix. Once again, even though not an actual indication of efficiency, this indicator describes the relative reliance on various fuels in the freight transport energy consumption mix. As transport is the main end use driving oil consumption, the third indicator of level 1 (F1c) refers to the oil consumption for freight transport, either absolute or as a share of total final oil consumption.

The second level proposes three indicators of intensity: freight transport per GDP (F2a), per vkm (F2b), and per tonne-kilometre (tkm) (F2c). While for passenger transport (P2a) is computed on a GDP per capita basis, (F2a) is computed on a GDP basis, due to the strong overall correlation between the movement of raw materials, intermediary products and final consumer goods, with changes of economic

activity or GDP. To get a better indicator for this relationship, only the value added of goods that are transported should be taken into consideration. However, this level of information is rarely available. (F2a) is meaningful for assessing high-level trends or comparing countries with each other. This indicator, however, does not measure energy efficiency developments, as it does not take into account the relative importance of each sub-sector, and it is influenced by many factors, such as availability of infrastructure, type of goods moved, etc. The indicators (F2b) and (F2c) more closely relate to energy efficiency, as they are ratios between energy use and activity data, although at the aggregated segment level.

Ideally, efficiency indicators need to be developed at the third level, with a further disaggregation by sub-sector and mode/vehicle type. In fact, the overall freight intensities for a given country are influenced by both the intensities of each sub-sector and the share of each sub-sector in the freight transport.

**Table 7.2 • Summary list of the most common indicators for transport**

Indicator	Coverage	Energy data	Activity data	Code	Recommended indicator
Passenger transport energy consumption per GDP/capita	Overall	Total passenger transport energy consumption	GDP; Total population	P2a	
Passenger transport energy consumption per vehicle-kilometre	Overall	Total passenger transport energy consumption	Total number of passenger transport vkm	P2b	
	By mode / passenger vehicle type	Energy consumption of passenger transport by mode / vehicle type A	Number of vkm of passenger mode / vehicle type A	P3a	
Passenger transport energy consumption per passenger-kilometre	Overall	Total passenger transport energy consumption	Total number of pkm	P2c	
	By mode / passenger vehicle type	Energy consumption of passenger transport by mode / vehicle type A	Number of pkm of passenger mode / vehicle type A	P3b	☺
Freight transport energy consumption per GDP	Overall	Total freight transport energy consumption	GDP	F2a	
Freight transport energy consumption per vehicle-kilometre	Overall	Total freight transport energy consumption	Total number of freight transport vkm	F2b	
	By freight mode / vehicle type	Energy consumption of freight transport by mode / vehicle type $\alpha$	Number of vkm of freight mode / vehicle type $\alpha$	F3a	
Freight transport energy consumption per tonne-kilometre	Overall	Total freight transport energy consumption	Total number of tkm	F2c	
	By freight mode / vehicle type	Energy consumption of freight transport by freight mode / vehicle type $\alpha$	Number of tkm of freight mode / vehicle type $\alpha$	F3b	☺

■ Passenger ■ Freight

At the third level, the pyramid proposes consumption per vkm (F3a) and per tkm (F3b), both computed for each sub-sector or mode/vehicle type. For example, while at the second level (F2b) represents the consumption per vkm for the overall freight



transport, (F3a) represents the consumption per vkm separately for road, rail, air and water freight transport. Depending on the significance of this sub-sector, countries may want to disaggregate it into different modes/vehicle types. For example, for road, light-duty and heavy-duty vehicles, which could also be further disaggregated based on the weight (e.g. very heavy trucks tend to travel long distances, for example in North America).

For the purpose of energy efficiency indicators, tkm is the freight counterpart of the passenger pkm, and represents the most important activity data. **Therefore, the recommended indicator for passenger transport is (F3b), energy consumption per tkm for each freight mode/vehicle type.**

## 5 The data behind the indicators

The key data needed for the indicators at the various levels presented in the previous sections are summarised in Figures 7.10, for energy consumption, and 7.11, for activity data. For the overall sectoral pyramid, aggregated energy data can often be derived from a country's energy balance and aggregated activity data can come from a variety of sources, such as the census, etc. (see Table 7.3).

As with other end-use sectors, the key in establishing transport indicators is to ensure that boundaries and definitions match between energy and activity data. The fact that transportation activity data collection methods are not harmonised internationally implies potential challenges for international comparability of data.

### The energy consumption data .....

#### Passenger transport

**Total passenger transport energy consumption:** This is the total energy consumption for passenger transport. It is used as a numerator in (P1a), (P2a), (P2b) and (P2c) indicators, and as a denominator in (P1b).

**Total passenger transport energy consumption by energy source Z:** This is the total consumption of a given energy source for passenger transport, for example consumption of oil across the various passenger transport sub-sectors. It is used as a numerator in (P1b). For oil only, it is used as a numerator for (P1c).

**Total energy consumption for passenger transport sub-sector or mode/vehicle type A:** This is the total consumption of a given sub-sector for passenger transport, for example consumption in road, rail, air and water passenger transport. Consumption can be further disaggregated by mode/vehicle type, such as for light-duty vehicles for road. It is used as a numerator in (P3a) and (P3b).

#### Freight transport

**Total freight transport energy consumption:** This is the total energy consumption for freight transport. It is used as a numerator in (F1a), (F2a), (F2b) and (F2c) indicators, and as a denominator in (F1b).

**Total freight transport energy consumption by energy source Z:** This is the total consumption of a given energy source for freight transport, for example consumption of oil across the various freight transport sub-sectors. It is used as a numerator in (F1b). For oil only, it is used as a numerator for (F1c).

**Total energy consumption for freight transport mode/vehicle type A:** This is the total consumption of a given sub-sector for freight transport, for example consumption in road, rail, air and water freight transport. Consumption can be further disaggregated by mode/vehicle type, such as for heavy-duty vehicles for road. It is used as a numerator in (F3a) and (F3b).

**Figure 7.10** • Aggregated flow chart of the energy consumption data needed for energy efficiency indicators for transport

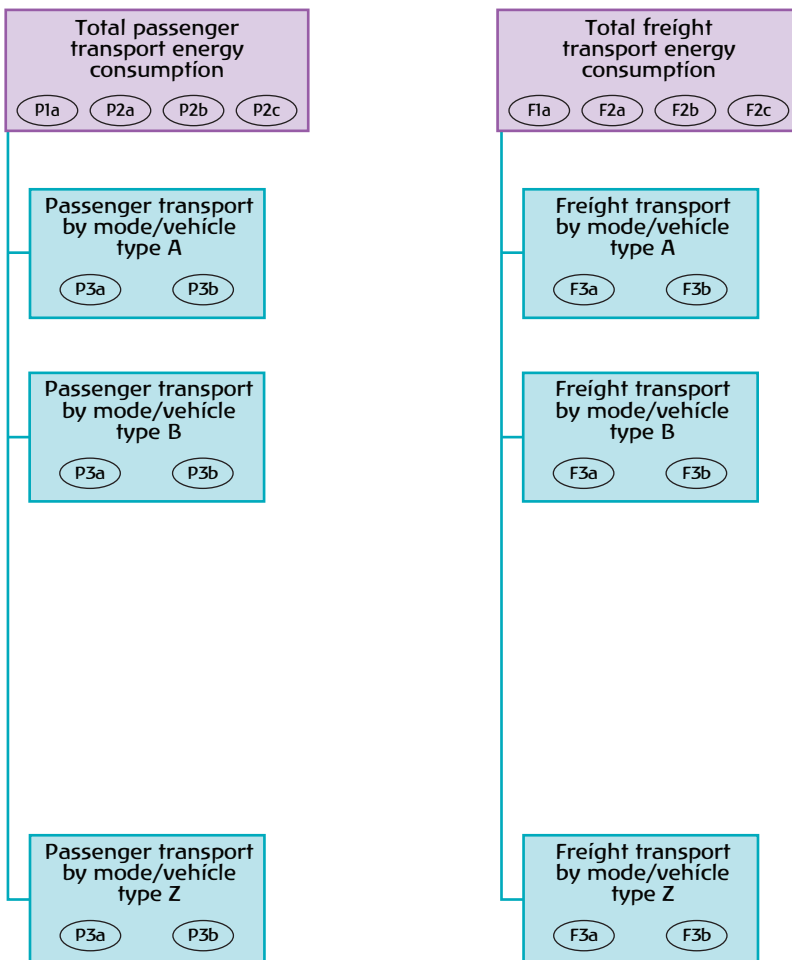

## The activity data .....

### Passenger transport

**GDP/capita:** This is the ratio between the GDP and the total population of a country. It is used as denominator in (P2a).

**Passenger transport total vkm:** This is the total distance travelled of all passenger vehicle movement summed up. It is used as denominator in (P2b).

**Total pkm:** This is the total distance travelled of all passenger movement summed up. It is used as denominator in (P2c).

**Figure 7.11** • Aggregated flow chart of the main activity data needed for energy efficiency indicators for transport

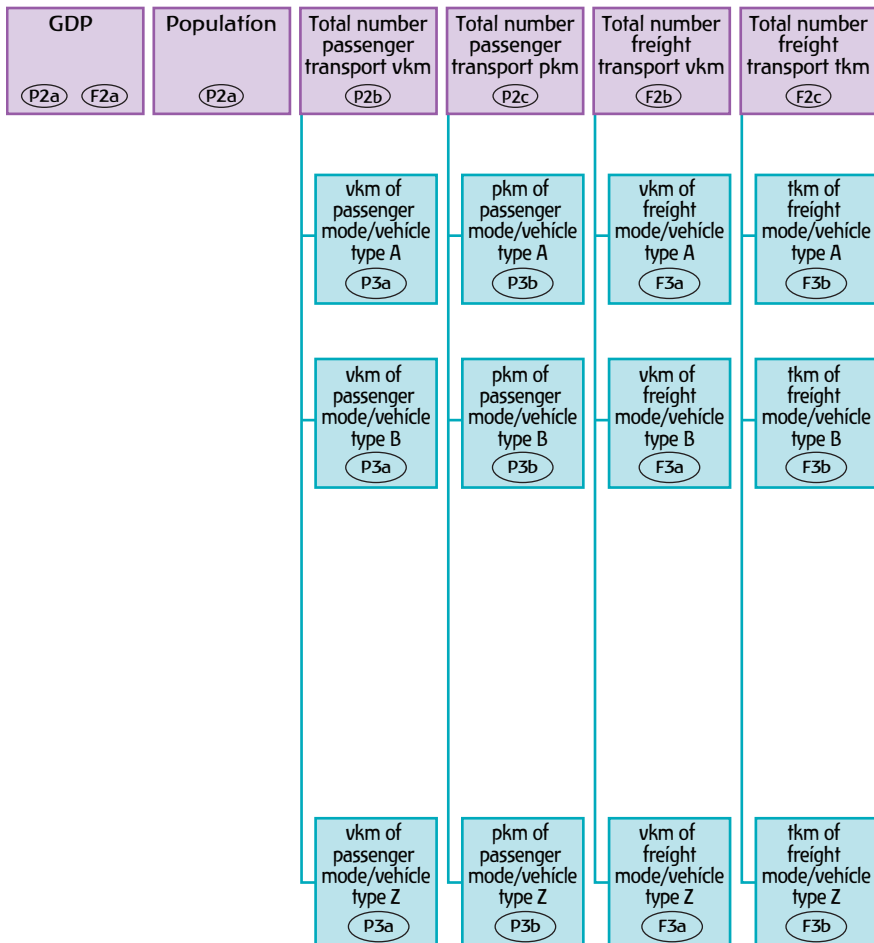

**Total vkm for passenger transport mode/vehicle type A:** This is the total distance travelled for a given mode/vehicle type of all passenger vehicle movements for that given mode/vehicle type. For example, it is the total distance travelled by air once the movements of all domestic passenger airplanes are summed up. It is used as a denominator in (P3a).

**Total pkm for passenger transport mode/vehicle type A:** This is the total distance travelled for a given mode/vehicle type when all movements of each passenger for that mode/vehicle type are summed up. For example, it is the total number of passengers transported by domestic airplanes, each multiplied by the distance travelled. It is used as a denominator in (P3b).

Similar to what is done for passenger transport, Box 7.1 presents the calculations of vkm and tkm. The intensity based on tkm is influenced by the energy intensity of each sub-sector, the share of that sub-sector, and also, differently from the indicator based on vkm, the “usage efficiency”, through the average load factor (the amount of freight transported). Using one truck to transport one tonne of goods is more efficient than using two trucks transporting half a tonne each. Changes in structure can have a very significant impact. For example, a higher share of truck activity and a lower share of train activity will result in an increase in the freight intensity, as trucks are more intensive than trains. These changes will affect both intensities.

### Box 7.1 • Calculations of transport activity data

Traffic volumes are measured by either vehicle-kilometre (vkm) for both segments, or by passenger-kilometre (pkm) or tonne-kilometre (tkm), respectively, for the passenger and the freight segments.

For one vehicle, vkm is the total distance travelled in a given period.

For a stock of vehicles, the following relationships hold:

$$\text{vkm} = \text{number of vehicles} \times \text{average distance per vehicle (km)}$$

$$\text{pkm} = \text{vkm} \times \text{average occupancy}$$

$$\text{tkm} = \text{vkm} \times \text{average load}$$

With average occupancy = average number of passengers per vehicle, and average load = average mass of goods transported per vehicle (in tonnes)

In other words, pkm (or tkm) can be higher due to either travelling longer distances or having more passengers (or weight of freight) per vehicle.

Here is an example of how to calculate total vkm and total pkm in a given period for a stock of three vehicles.

Stock vehicles	Distance travelled (km)	Average occupancy	Total vehicle-kilometres	Total average occupancy	Total passenger-kilometres
Vehicle 1	50 000	3	50 000	$\frac{(50\,000 \times 3 + 20\,000 \times 4 + 90\,000 \times 1)}{(50\,000 + 20\,000 + 90\,000)} = 2$	$160\,000 \times 2 = 320\,000$
Vehicle 2	20 000	4	+ 20 000		
Vehicle 3	90 000	1	+ 90 000 = 160 000		

## Freight transport

**GDP:** The GDP is used as a denominator in (F2a).

**Freight transport vkm:** This is the total distance travelled when all freight vehicle movements are summed up. It is used as denominator in (F2b).

**Total tkm:** This is the total mass carried of all goods movements summed up. It is used as denominator in (F2c).

**Total vkm for freight transport mode/vehicle type A:** This is the total distance travelled for a given mode/vehicle type when all movements of each freight vehicle for that mode/vehicle type are summed up. For example, it is the total distance travelled on water once the movements of all domestic freight ships are summed up. It is used as a denominator in (F3a).

**Total tkm for freight transport mode/vehicle type A:** This is the total distance travelled for a given mode/vehicle type when all movements of each tonne of goods for that mode/vehicle type are summed up. For example, it is the total number of tonnes transported by domestic freight ships, each multiplied by the distance travelled. It is used as a denominator in (F3b).

## Questions and Answers

### Q9. What is fuel economy? How does it relate to the pyramid indicators?

*The concept “fuel economy” (or “fuel efficiency”) refers to the relationship between the volume of fuel used to travel a given distance and the distance travelled. It is generally measured either in volume of fuel per distance travelled (“litre per 100 km”) or in distance per volume of fuel used (“km per litre”, or “mile per gallon”). Manufacturers provide theoretical information on fuel economy by vehicle type based on tests performed on sample vehicles within the manufacturing process. Under operational conditions, the actual consumption per unit distance may differ significantly from theoretical fuel economy values, being larger by a factor ranging between 15% and 40%\*.*

*Practically, “real life” fuel economy corresponds to the indicators (P3a) and (F3a), fuel consumption per vkm for both passenger and freight segments, after the units have been converted using the densities and calorific values of the fuels. In fact, the average national fuel economy by mode/vehicle type can be obtained as a ratio between the total energy consumption and the corresponding*

\* The 2013 report *From Laboratory to Road* (ICCT, 2013) shows that the gap between official and “real conditions” fuel economy for passenger cars in Europe and the United States increased significantly over the last ten years, reaching an average 25% in 2011.

*total distance travelled (vkm). For example, if in a country for a given period the total distance travelled by gasoline cars is 415 billion vkm and the total car gasoline consumption is 1 287 petajoules (PJ), given a density of 1 350 litre/tonne and a net calorific value of 44.75 gigajoules (GJ) per tonne for gasoline, it follows that:*

$$\begin{aligned} \text{Average fuel consumption} &= \frac{1\,287 \text{ PJ}}{(415 \text{ billion vehicle-kilometre})} \\ \text{per vehicle-kilometre} &= 3.1 \text{ megajoules per vehicle-kilometre} \\ \\ \text{Average national} &= \frac{3.1 \times 10^{-3} \text{ GJ}}{(44.75 \frac{\text{GJ}}{\text{tonne}})} \times 1\,350 \frac{\text{litre}}{\text{tonne}} \\ \text{fuel economy} &= 9 \text{ litre/100 km (or 11 km/litre)} \end{aligned}$$

### **Q 10. Is consumption for air conditioning in vehicles accounted for in energy efficiency indicators?**

*Consumption for air conditioning in vehicles can be very significant, with an impact of 15-20% on the actual fuel economy\*\*. As a consequence, climate conditions could lead to differences among countries when comparing average operational fuel economy. The effect is not generally included in the theoretical fuel economy values declared by manufacturers, so it is important to take it into account when estimating the fuel economy, especially for countries with a very warm climate.*

\*\* For a detailed report, please refer to *Impact of Vehicle Air-Conditioning on Fuel Economy, Tailpipe Emissions, and Electric Vehicle Range* (NREL, 2000)

## **6 How to collect data?**

Some data are easier to collect than others; this is true both for energy consumption and activity data. For instance, it is certainly easier to derive with accuracy the number of vehicles by type in the national stock or the gasoline consumption of cars than the total tkm for freight ships.

As for other end-use sectors, the four methodologies to collect energy consumption and activity data for the transport sector are: administrative sources, surveying, modelling and measuring. All methods have strengths and weaknesses. Moreover, countries often combine several methods (administrative sources and modelling, for example) to build proper indicators for the sector. A description of each methodology follows, mainly based on the submissions received by the International Energy Agency (IEA) on existing practices for collecting statistics for energy efficiency indicators. For the transport sector, the responses received by the IEA were

rather small in number, and did not cover homogeneously the four methodologies, probably because of the complexity of the sector. As a consequence, it might be difficult to draw final conclusions from the practices. Therefore, information from the practices for transport is complemented by information found in literature. Given the importance of road transport, an additional box (Box 7.4) at the end of the section summarises data collection methods for that specific sub-sector.

Table 7.3 presents an overview of the main sources and methodologies used to collect the data needed to build the indicators presented in the previous section. Individual methodologies will be described in the rest of this section.

**Table 7.3 • Summary of the main data needed for transport indicators and examples of possible sources and methodologies**

Data	Source	Methodology
<b>Energy data</b>		
Total transport consumption	National energy balance National energy statistics	Administrative sources Modelling
Consumption by sub-sector	National energy balance National energy statistics	Administrative sources Mobility surveys Modelling
Consumption by segment		Mobility surveys Modelling
Consumption by vehicle type		Mobility surveys Modelling
<b>Activity data</b>		
GDP, population	National statistics offices	Administrative sources
Vehicle-km (vkm)	Vehicle registers/ Roadworthiness testing services/ Inspecting organisations  Municipalities/Transport authorities  National and international databases Transport ministries	Measurements: odometer readings  Measurements: road traffic count  Administrative sources Mobility surveys Modelling
Passenger-km (pkm)	National and international databases Transport ministries	Administrative sources Mobility surveys
Tonne-km (tkm)	National and international databases Transport ministries	Administrative sources Mobility surveys, freight surveys

Data	Source	Methodology
Vehicle stocks*	Statistics offices Manufacturers National and international databases Vehicle registers	Administrative sources  Administrative sources/ measurements
Fuel economy	Manufacturers	Administrative source Modelling

\* Note that the quality of vehicle stock data may be variable depending on the quality of scrappage statistics.

## Questions and Answers

### Q 11. What is an odometer?

*An odometer, or odograph, is an instrument indicating the distance travelled by a vehicle, such as a car, a truck or even a bicycle. The device may be electronic, mechanical or a combination of the two. Odometer readings are generally performed during regular vehicle inspections and generally collected by vehicle registers. For road, odometer readings, combined with information on the total number of vehicles in the national fleet at a given time, are essential factors in calculating activity data such as total vkm.*

## Administrative sources .....

The transportation sector particularly relies on administrative data sources such as mobility vehicle surveys, statistics on transportation and vehicle register databases. This is probably because the cost and practical issues associated with directly surveying transport users is very high. Administrative sources should be the first sources consulted to identify which data are already available and how to best use them. Tapping into these existing sources would generally lead to savings in time and costs. The following description of administrative data for the transport sector is based on the submission of practices received by the IEA.

**Purpose of collecting administrative data:** Within the responses received by the IEA, countries noted that they heavily rely on administrative sources for the transport sector. For example, countries often use information from motor vehicle registers or from household surveys. Administrative data can be used directly to develop estimates of transport energy consumption, or to feed transportation models.

**Sources:** IEA respondents identified a number of existing sources: vehicle registers, government statistics offices, central and regional transport authorities, energy



utilities, manufacturers and international organisations. Vehicle registers record a lot of useful information on vehicles and owners, generally for a number of purposes: security, collection of taxes, administration and policy development. Information can include vehicle model, fuel type, weight and also odometer readings at regular inspection intervals. An annual requirement for car testing to maintain a driver's license would ensure the possibility to monitor the vkm of the national vehicle stock. Various statistics are also collected by governmental offices to support the development of transport policies, spatial and urban planning, infrastructure management, public transportation planning, etc. Also, a lot of information is provided in a number of international databases on transport, for example those listed in Box 7.2.

**Data collected:** The two types of data that are collected to build indicators include activity and energy data, as listed in the previous section. Energy data include fuel sales, often by oil suppliers but also from various utilities, such as electricity or gas. Activity data include average travel distance, pkm and tkm, vehicle stock, and technical characteristics such as fuel economy, engine capacity, gross weight, etc.

**Cost associated with administrative data:** Most of the respondents to the IEA survey noted that there was no fee associated with the data they needed to collect. However, when there is no direct cost, indirect costs are incurred from a number of steps needed: researching the existing administrative sources, discussing the feasibility of the data's use with the organisations collecting them, setting up agreements for data transfer and use, and finally transferring the data to a format suitable for use.

**Main challenges:** Some of the most commonly faced challenges include the time-consuming process of collecting and processing information (e.g. paper to digital), definitional issues between sources, management of incomplete data, and time needed to establish a relationship with the organisation or service providing the data.

## Surveying .....

Among the practices collected by the IEA, surveys were performed mainly for road transport, often covering both passenger and freight; in some cases, they were also performed for rail, air and water transport. Of course, surveys alone may not be enough, and may need to be complemented by information derived from administrative sources, direct measurements or modelling studies. The next paragraphs summarise the main characteristics of surveys derived from the practices received by the IEA.

**Survey purpose:** The key purpose for surveys is to calculate energy consumption in the transportation sector, by sub-sector and vehicle type, as well as average fuel consumption per unit of distance travelled, pkm and diffusion of vehicle stocks, nationally and by region. Broader purposes are to understand driver behaviours and trends in time, to support development of policies to improve road safety, to lower fuel consumption, and to reduce air pollution.

### Box 7.2 • Selected international sources for transport data

This section lists selected international organisations that provide transport data, either at the overall sectoral level or for a specific transport sub-sector. Data are collected from members, which are either countries or transport operators, depending on the case. This list is only indicative and by no means intends to be exhaustive.

#### Overall transport

The **International Transport Forum**<sup>(1)</sup> at the OECD, an intergovernmental organisation with 54 member countries, collects data relevant to a range of transport policy issues, maintains historical databases, and publishes analysis and indicators on road, rail and inland waterways for member countries. Data can be accessed at no cost.

**Eurostat** is the Statistics Office of the European Union, collecting data mostly based on legislation applied by EU member states. Its transport statistics<sup>(2)</sup> cover road, rail, pipeline, inland waterways, sea and air for passenger and freight.

#### Public transport

The **International Association of Public Transport**<sup>(3)</sup> is the international network for public transport authorities and operators, policy decision makers, scientific institutes, and the public transport supply and service industry. Its *Millennium Cities Database* includes public transport data and indicators for 100 of the world's cities for the year 1995, as a benchmarking initiative.

#### Road

The **International Road Federation**<sup>(4)</sup> is a non-profit organisation with the mission to encourage and promote development and maintenance of better, safer and more sustainable roads. Its annual *World Road Statistics* publication is an international reference for global road and vehicle statistics, based on data compiled from official sources from about 200 countries and regions.

#### Rail

The **International Union of Railways**<sup>(5)</sup>, an international professional association representing the railway sector, produces global railway statistics with activity data going back to 1970, and a number of other relevant publications.

#### Aviation

The **International Air Transport Association**<sup>(6)</sup>, the trade association for the world's airlines, runs various statistics collections from airlines, such as the Monthly International Statistics and the annual World Air Transport Statistics, including activity data for passenger and freight transport.

The **International Civil Aviation Organization**<sup>(7)</sup>, a specialised agency of the United Nations that also collects activity data on international and domestic flights for passenger and freight transport.

(1) <http://www.internationaltransportforum.org/Home.html>.

(2) <http://epp.eurostat.ec.europa.eu/portal/page/portal/transport/introduction>.

(3) <http://www.uitp.org/public-transport-sustainable-mobility>.

(4) [www.irfnet.ch](http://www.irfnet.ch).

(5) <http://www.uic.org/>.

(6) <http://www.iata.org/services/statistics/stats/Pages/index.aspx>.

(7) <http://www.icao.int/data/default.aspx>.

**Survey approach:** Surveys include mobility surveys, such as those targeting drivers (e.g. households and truck owners), who are asked to fill out a diary over a given time period. Another mobility survey is a gas station survey, where a random sample of vehicle drivers at selected gas stations is asked to give information on fuel consumption and vehicle type.

**Sample design:** Stratified random sampling approach is the most common method to design a national transportation survey sample. Household surveys will sample the adult population resident in the country; vehicle-driven surveys will cover all motor vehicles or selected types basing the sample on plate registration lists, lists of freight companies and lists of public carriers; gas station surveys will randomly sample vehicles refuelling at selected fuel stations. Existing panel surveys can also be used to define the sample. In those cases, a question on vehicle ownership is used to filter out non-relevant responders.

**Sample size:** Due to the diversity of the size of the countries and the high number of vehicles, the absolute size of the sample within the practices collected by the IEA ranged from 3 000 to 67 000. The sample generally corresponded to less than 1% of the total population.

**Frequency:** Within the IEA sample, the surveys in the transport sector are carried out either every one to three years – the majority on an annual basis. In other cases, surveys are conducted without regular cycles. Conducting surveys on a regular basis not only ensures continuity of data, but also enables improvement of data quality through a continued capacity-building effort.

**Legal status of the survey:** About half of the surveys in the IEA sample are mandatory, although not all carry fines in case of non-response. In a couple of voluntary surveys, some non-cash incentives are offered.

**Survey respondents:** Respondents are generally vehicle owners (for private passenger vehicles), fleet carriers (for freight transport), or railway and air carriers. For passenger vehicles, households can be asked to provide information about their vehicle use and vehicle ownership.

**Response rate:** Response rates can vary from 25% to 100%, with the highest score occurring only for mandatory surveys, although in some cases, voluntary surveys achieve very high response rates as well. Non-response and underreporting could occur if the burden on the respondent is felt to be too heavy, whether in the form of a lengthy interview or a questionnaire requesting many data. Underreporting occurs if a respondent does not declare all the journeys of the vehicle. Underreporting is not easily detected from a single respondent but will become clear in the final statistics if comparable data are available from other sources.

**Collection methods:** Surveys are either paper-based, in-person interviews (either in-house or in situ, as at a filling station), or computer-assisted telephone interviews. In one case, the survey is based on an electronic portable on-board data logger. This practice is also described under the measurements section.

**Time to complete a survey:** Time to complete surveys varies from a few minutes to about three hours.

**Elements collected:** Most surveys collect both energy consumption and activity data, including annual consumption by fuel, vkm and pkm, fuel economy, vehicle weight and capacity, and volumes of goods transported (for freight), but also further information on driving behaviour, such as reasons for trips, carrier age, road characteristics, and additional information on the amount spent for the fuel.

**Energy sources:** The energy sources generally considered in the surveys are oil products, but also natural gas and electricity.

**Overall time for a survey from survey design to reporting of results:** The time required to fully develop and implement a survey varies from a minimum of six months to a maximum of about one year. The overall time depends on the resources required to run the project, the training requirements of the staff for data collection and processing, the detail of the data being collected, and the validation process to ensure data quality. As surveys are repeated, organisations will typically become more efficient at delivering the results.

**Costs associated with the survey:** The cost of a survey depends on the labour cost, the detail of the survey itself, the stratification levels and the sample size of the survey. Based on cost estimates gathered from a few OECD countries, a national transport sector survey can cost between USD 100 000 and USD 1.6 million. In order to reduce survey costs, multipurpose surveys might be considered, where only part of the questionnaire will deal with vehicle use. Persons or households without vehicles, of no interest for statistics about vehicle traffic, can be sifted out easily via a filter question. To reduce setup costs, an existing general panel survey can be used to establish a sub-sample. In this case, the sampling frame is already established and the background data on the panel will be available for the estimation.

As an alternative method, it appears that fuel station-based surveys with short questionnaires are a relatively low-cost method to collect preliminary data for road transport. Although such surveys may be a good option for countries with less established systems for data collection, they may pose the same reproducibility challenges as any random-based survey.

**Main challenges faced in surveying:** Respondents generally noted that the key challenges were low response rate, low response quality, and incomplete and inconsistent responses. Some other issues include the quality of the interviewing staff members and the need to train them for the task so that they do not make inappropriate assumptions or interpretations of results. Driver-based surveys require that respondents fill out a trip diary and it is possible that drivers forget, or find it cumbersome to write down a dozen data variables by hand for each trip. Some countries have initiated activities that allow for monitoring vehicle with GPS-based monitoring equipment in order to have more accurate and complete information, and also to avoid the bias towards drivers who drive little or have more time to complete the trip logbook.

**Possible improvements:** Many respondents noted that the quality of results could improve significantly by increasing the survey sample size, although the allocated budget may impose strict constraints. Other suggestions include the simplification of questionnaires, and the clarification of definitions and instructions for each question

in order to decrease the burden on respondents. An idea to incentivise responses could be to share survey results with respondents and provide tips for drivers, but also simply to use reminders – whether by post or by telephone. To avoid having drivers forget to fill the trip diary, a respondent recommends that the record book be kept in the car to be filled out every time the driver stops at a gas station. Some countries are also moving away from a paper approach to an electronic auto-logger that will be installed on each vehicle being monitored, making the reporting easier.

Possible improvements also include investment in training and regular meetings among interviewers to discuss challenges. Simply improving the communication with respondents could significantly improve data validation and data quality checks.

## Measuring .....

Measurements for energy efficiency indicators in the transport sector are particularly complex because of the heterogeneous nature of the transport sub-sectors and modes/vehicle types, and because of the large diffusion of vehicles. These reasons make it very hard to implement measurements on nationally representative samples.

Unfortunately, in the case of transport measurements, only one practice was submitted – which limits the general applicability of some of the findings reported here, and also shows that measuring is not yet a well-developed approach for energy efficiency indicators in the transport sector. However, measuring may become important as a complement to national vehicle surveys, as demonstrated by the practice received. This practice was recently implemented and is based on on-board monitors. It is also possible that in the future, innovative approaches will be developed, as needs arise and cost of measuring instrumentation decreases.

The following paragraphs are based on the practice received, and on additional information coming from literature, in particular for measurements performed through vehicle inspection and traffic monitoring programmes<sup>3</sup>. Moreover, some elements could also be inferred from information collected within the administrative sources practices, for example on practices of odometer readings.

**Measuring purpose:** Measuring in the transport sector is generally performed to assess energy consumption patterns, as well as fuel consumption per unit distance travelled, but also to complement information coming from a survey or a modelling study and to feed models and estimates. The overall objective of measurement campaigns is to reduce fuel consumption and fuel expenses. For activity data, direct measurements are also regularly performed by programmes with specific purposes, such as vehicle inspections, for licences or pollution control purposes, or traffic monitoring programmes, performed to collect data that describe the use and performance of the roadway systems. Information in the administrative source section of this chapter also refers to such practices.

**Sub-sectors covered:** In the practice received, measurements target road transportation, especially private carriers, such as cars, vans, SUVs, taxis and pickup trucks, and more recently, also trucks, tractors and cargo vans.

3. For an example of methodological description of a traffic monitoring programme, see the *Traffic Monitoring Guide* (USDOT, 2013).

**Sample design:** Samples are usually designed based on a stratified random sampling approach, based on plate registration lists or lists of vehicles sold by manufacturers (for new vehicles). In the case of practices related to vehicle inspection, the sample would cover the full stock of registered vehicles in the country, with a high level of accuracy on vehicle types. For traffic monitoring programmes, the sample would include all vehicles, national and foreign, travelling at the measurement time on the targeted road sample. For such measurements, great care is needed with the selection of the counting sites, so that the information on the traffic intensity will cover a representative portion of the road network.

**Sample size:** In the practice received, the sample size was of about 20 000 vehicles, or about 1% of the total population.

**Frequency of measurements:** There is no ideal frequency for undertaking measurement initiatives. In the above example, measurements are conducted every year. Vehicle inspections are generally mandatory every one to four years for each vehicle, and are performed continuously. Traffic monitoring programmes may have more frequent data, as some counts are even performed on a continuous basis.

**Length of monitoring period:** Between measurement initiatives, the length of one monitoring period is variable. In the practice received, the measurement period is 21 days. Traffic monitoring programmes may be continuous (sites are recording traffic distribution 24 hours a day, seven days a week, all year long), or of short duration (the traffic flow is monitored regularly, for example for several hours, and counters can be moved to provide better spatial and geographical coverage).

**Who took measurements and how:** In the practice received, measurements are made through a logger device that collects data directly from the engines of vehicles. Other types of measurements, such as those from vehicle inspections, are performed by roadworthiness operators or pollution control authorities, collecting data through odometer readings. Traffic monitoring counts are generally performed by local transport authorities through manual or automatic devices.

**Cost of measurements:** Not enough information was submitted to provide an accurate estimate of transport sector measurements costs. Generally, the key driving factors are the cost of individual equipment and the labour costs to set up the equipment (if needed) and to collect measurements. Additional costs include the costs to design the sample, and to analyse and to communicate data. For traffic monitoring programmes, additional personnel requirements need to be taken into account in the case of manual counts.

**Main challenges:** The major challenges in the practice received are linked to the correct functioning of the equipment, to the understanding of how to use it and to the communication with respondents. For traffic count measurements, challenges also exist in calibration procedures and in data processing to derive representative average values for traffic volumes.

**Recommendations:** A general recommendation would be to use any existing mandatory national car inspection process also to collect energy efficiency data. In the practice received, a website with guidelines for respondents, also in the form of Frequently Asked Questions (FAQs), and with results of the study provides useful information

in support of the campaign. In addition, a cash incentive is given through a contest among respondents, with monthly draws covering all participants who have completed their contribution and returned the data logger. For traffic monitoring programmes, best practices would include: implementing automated software technologies to eliminate manual or electronic processing of data, upgrading site equipment to include cellular/dial-up modems, or establishing fibre network access, eliminating the need for site visits to download data.

## Modelling .....

Modelling is an integral part of the process to estimate energy consumption by sub-sector and mode/vehicle type in the transport sector, by itself, or to complement results from another methodology, such as for example a national mobility survey. As modelling is based on input data and assumptions, the quality of input data and the accuracy of assumptions will strongly impact the quality of the output. The key steps of modelling work include: establishing the modelling framework, setting model assumptions, inputting data, running the model, validating its outcomes against data, and analysing results. The following paragraphs are based on the practices submitted to the IEA for transport sector modelling.

**Model purpose:** Models are generally used to estimate energy consumption, by sub-sector and total across the sector, as well as to estimate greenhouse gas (GHG) emissions. In a few practices, models are also used for the assessment of various policy scenarios (e.g. fuel switching options, etc.).

**Modes covered:** Most of the existing bottom-up models cover the different transportation modes, including road, rail, air and water, although some of them focus on road, including private carriers, buses and trucks.

**Model type:** The transport sector models are generally bottom-up statistical or engineering models. They could simply use a statistical representation of vehicle stock flows and their associated energy consumption, or follow a more sophisticated engineering approach, with detailed technical parameters of vehicles and performances.

**Source of the model:** All transport models in the IEA sample are custom-built. Tapping into an existing model would have the advantages of saving time, and of potentially learning from other people who use the same model. However, existing models would nonetheless need to be customised to fit country-specific situations. Setting up a bottom-up model could be done using spreadsheet software (e.g. MS Excel™).

**Time required:** The key stages for a modelling study include: developing the model; inputting data; calibrating it to national historical data; regularly updating the framework, its input and its assumptions; validating the model's results; and analysing the data. The time needed to build and properly calibrate the model can vary, depending on the complexity of the model and on whether the model is developed based on an existing one or not – in which case the development phase only consists of an update based on custom assumptions and data. The overall modelling exercise could take anywhere from a few weeks to about two years.

**Cost:** In the IEA sample, not enough information was given to provide cost estimates. In general, the cost for modelling is largely a function of the cost of labour, and possibly of any cost of required input data. Bottom-up models could take from a few weeks to almost two years, and their corresponding cost would also vary greatly.

**Frequency:** Within the IEA sample, most modelling practices are undertaken on an annual basis, while some were performed only once. Repeating the exercise in time would allow improvement of the existing framework.

**Key model inputs:** Bottom-up models rely on information such as fuel economy by mode, fuel consumption by mode, pkm and tkm by mode, and vehicle stocks. More detailed models also require technology diffusion elements and physical characteristics by mode/vehicle type. Such input information may be derived from national surveys or from measurements, such as those collected by vehicle registers. In the absence of data, a higher number of assumptions would need to be developed in order to estimate energy consumption by the different modes. Output data are generally validated against total sectoral energy consumption data available within national statistics.

**Key model outputs:** Bottom-up models are used to estimate energy consumption of the various modes and vehicle types. In some cases, GHG emissions are also computed, and transport trends are broken down into activity, structure and efficiency effects. Some models also produce projections, based on further assumptions on demand growth.

**Validation of modelling outcome:** All models have their results validated against existing national data, such as energy balances or national energy statistics. The key reference is a country's energy balance or its national energy statistics, to validate the total energy consumption and the energy consumption by sub-sector derived by the model, combining all vehicle types for freight and passenger transport. However, there are generally no national references for validation of freight and passenger consumption separately. For models used for policy scenario analysis, a further validation process would be to verify forecast of past periods against actual historical time series.

**Main challenges:** Within the sample of submissions to the IEA, the most important challenge is the lack of input data – which implies that existing data collection practices in the transport sector still need to improve coverage. As the quality of model results strongly relies on the quality of input data and on the accuracy of assumptions, the lack of input data, or their low quality, will affect model reliability for estimations, and also limit the degree to which a model can be expanded. Other challenges include quality control issues and proper formulations of model assumptions.

**Recommendations:** To ensure continuity of the results, it is recommended that modelling exercises be maintained in time. As for modelling in other end-use sectors, the commitment from the service charged with allocating resources for ongoing modelling and modelling capacity is key. A model that produces good results could take as much as 15 years of teamwork and most-up-to-date technology updates. The example of the IEA Mobility Model (MoMo), described in Box 7.3, also shows the importance of continuous development effort in modelling.



### Box 7.3 • A transport modelling example: The IEA Mobility Model (MoMo)

The Energy Technology Policy (ETP) transport group at the IEA has built a transportation model (MoMo, “Fulton et al., 2009”) that estimates energy use by sub-sector and mode/vehicle type, at regional and global levels, based on a combination of sources for both energy and activity data.

The model is based on the “ASIF” framework:

$$\text{Activity} \times \text{Structure} \times \text{Energy Intensity} = \text{Fuel consumption}$$

Traffic activity refers to the average distance travelled, which is obtained combining vehicle stock numbers with average mileage data; structure refers to the shares of different vehicle types in each mode; energy intensity refers to the average consumption by vehicle type, estimated by adjusting the theoretical fuel economy from manufacturer information. All these variables are used to determine the total energy consumption. The model output is calibrated against total transport figures obtained through national energy balances.

The model also estimates traffic activity by segment in pkm and tkm by applying average occupancy and load estimates to the traffic activity data in vkm derived from household and freight surveys.

The diagram below schematically shows input and output variables, and examples of sources for the various input data.

Figure 7.12 • Schematics of a transport model

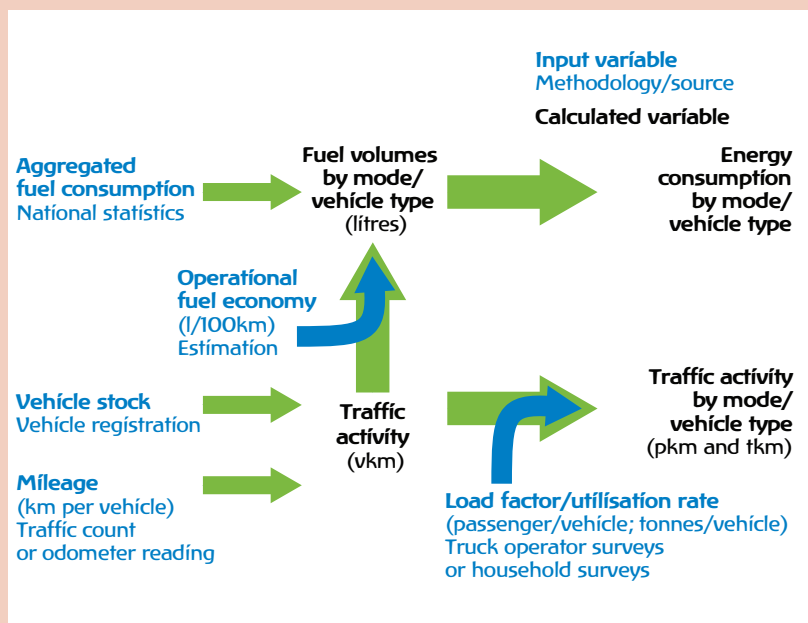

**Box 7.4 • Focus on road:  
Summary of key data collection methodologies**

Given the importance of road in transport energy consumption, this box summarises the main features of existing approaches specifically used to collect road data, based on the *Handbook on Statistics on Road Traffic* (UNECE, 2007).

The four approaches presented collect road data based on different approaches: vehicle (odometer readings), driver (household surveys), road (traffic counts) and fuel consumption (estimation), as schematically shown in Table 7.4.

**Table 7.4 • Schematic description of selected road data collection methodologies**

Approach	Methodology	Notes
Vehicle	Odometer-reading statistics, collected during regular inspections (including those for pollution control).	Only covers vehicles registered in the country and due for inspection, and excludes foreign vehicle activity on national territory. Data on road traffic generated by vehicles that are not due for inspection must be drawn from other sources.
Driver	Statistics collected through household surveys targeting vehicle owners, conducted by postal, telephone or face-to-face interviews. Collect information on journeys travelled during a given period.	Covers all motor vehicles or selected types. Could use existing panel surveys to establish a sub-sample. Excludes foreign vehicle activity on national territory.
Road	Manual or automatic traffic count at specific points on road segments, often carried out by local municipalities and regional offices to study road traffic and congestion levels. Measurements can be continuous (all year long) or focus on a short period. New technology also now enables collection of data on non-motorised travel including bicycle and pedestrian traffic.	Includes both national and foreign vehicles. Counting sites must be chosen with care as a statistical sample. Although it represents a basic input for calculating national vkm data, it may lack detail on vehicle characteristics and occupancy rates.
Fuel consumption	Traffic data and fuel consumption are estimated in an iterative mode based on multiple data sources. Activity data (vehicle stock, average mileage) are derived from surveys or measurements, and are the basis to estimate vkm. Fuel consumption is estimated based on estimated operational fuel economy. The method uses total fuel sales as a control variable for total energy consumption.	Covers all traffic on national territory as well as all traffic by national vehicles. Cross-border traffic and cross-border use of fuel need to be taken into account. Needs assumptions on average fuel economy of vehicles on roads (given different age spectrum and different consumption patterns) compared with manufacturers' tests.



# Validating the Data

## 1 Why is data validation important?

Data validation is important for any basic data collection but needs to be even more solid when basic data are elaborated, as in the case of energy efficiency indicators. Data for energy efficiency indicators are generally collected from a number of different data sources using different methodologies, so it is extremely important to verify their consistency. Also, energy efficiency indicators are generally ratios between two variables. On the one hand, this represents an opportunity to verify whether expected relationships between variables hold, contributing to the assessment of the quality of basic data. On the other hand, small uncertainties or errors in either the numerator or the denominator can lead to significant (and often incorrect) changes in indicators trends and reduce the meaningfulness of data for monitoring energy efficiency.

Since energy efficiency indicators will be used for assessing a country's situation, forecasting, defining policy and measures, and monitoring successes or failures, a thorough validation process of the data is of paramount importance. This is especially true as policies and measures can impact investments, technology developments, and the day-to-day life of people at a country or even regional level. And the impact can be dramatic in behavioural, technical and monetary terms.

For example, banning incandescent bulbs concerns not only people of a whole country, but also bulb manufacturers and importers. One can find another relevant example in the transport sector, where implementing a system of bonus-malus based on energy consumption for new cars will not only impact buyers but also car dealers and companies, as well as tax revenues, environment, policy makers, etc.

## 2 What are the main data validation criteria?

As a consequence of the importance of having sound data, a careful data validation process should be integrated in the data collection process. The set of checks performed will be specific in each case, but could be generally grouped around four main areas: coverage/definitions, internal consistency, consistency with external sources and plausibility. A brief overview is presented below and examples of specific checks for each end-use sector will be described in the following section.

### Coverage/definitions .....

Coverage/definitions checks ensure that the data collected follow predefined requirements in terms of definitions and coverage for sectors, end uses, geography, time, etc. Basic coverage/definition checks include verifying where boundaries of

a sector are, whether the period is defined in calendar year or fiscal year, whether calorific values are gross or net, etc. Using international standard classifications, for example the United Nations International Standard Industrial Classification of all Economic Activities (ISIC), would help to obtain data based on consistent definitions of sectors. As energy efficiency indicators are calculated by combining energy and activity data often coming from different sources, for example energy consumption and value added for a given industrial sub-sector, it is essential that all the variables refer exactly to the same boundaries. To this purpose, it is also very important to produce and effectively communicate to data providers and to users clear definitions of all terms, ranging from fuel types to detailed end-use and activity data.

## Internal consistency .....

Internal consistency checks ensure that different elements in a set of data follow expected relationships with one another. Examples of basic internal consistency checks include arithmetic checks at any given time, as well as checks on coherence of data in time. An arithmetic check could for instance verify that totals equal the sum of sub-components — an obvious but relevant requirement. Inconsistencies of this type frequently occur when figures are derived from different sources. A check on the coherence of data in time could for example detect discontinuities and breaks within data series. Breaks, usually due to changes in definitions, sources, classifications, coverage, methodologies, etc., could make time series analysis very difficult and could produce misleading results.

In case of revisions of historical data, it is very important to understand the reasons behind changes and to assess whether the revisions were applied to the whole time series or not. It is also useful to monitor data series for variables that are related and verify that any divergence in trends can be justified.

## Consistency with external data sources .....

Checks of consistency with external sources ensure that the data collected are consistent with similar data produced by other sources (industry, organisations, statistics offices, etc.) and that any significant discrepancies can be explained, for example by different boundary definitions, methodologies, coverage, etc.

Reference sources that could be used to validate energy efficiency indicators data include, for instance: the International Energy Agency (IEA) energy balances, based on official government data submissions but limited to data on energy consumption by sector; the Online Database for Yearly Assessment of Energy Efficiency (ODYSSEE)<sup>1</sup> database provides more disaggregated data on both energy and activity data, but is mainly limited to European Union countries. Other national and international organisations, such as national statistics offices, ministries, industrial associations, the United Nations, the Organisation for Economic Co-operation and Development (OECD), the Food and Agriculture Organisation (FAO), etc., may publish other relevant data on a particular topic (gross domestic product [GDP], biomass, etc.).

Figure 8.1 shows an example of problems detected while validating data of energy consumption for an industrial sub-sector against energy balances data for the same sub-sector.

1. See <http://www.indicators.odyssee-mure.eu/online-indicators.html>.

**Figure 8.1** • Energy consumption for an industry sub-sector of a country, based on the energy balance submission to the IEA and on the energy efficiency submission

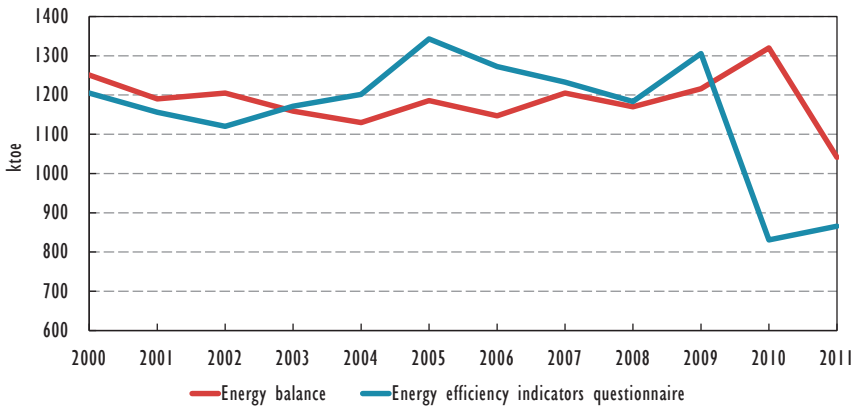

Notes: unless otherwise indicated, all tables and figures in this chapter derive from IEA data and analysis. Ktoe is kilotonnes of oil equivalent.

## Plausibility

Even if all the other types of checks were performed, the results obtained might be not reasonable. Plausibility checks ensure that values fall within expected ranges and that data and indicators make sense. At the simplest level, examples of those checks include verifying that actual fuel consumption is not negative, or checking whether data reported as zero represent actual values or simply not available information. At a higher level, plausibility checks would include reviewing shares of end uses in the total, monitoring trends of data and indicators, comparing calculated indicators against benchmark values (e.g. industry average and ranges, other countries values, best available technology, etc.), etc.

Assessing plausibility of energy efficiency indicators requires an adequate knowledge of the topic, as the variability of data and indicators will depend on country characteristics, industry practices, best available technologies, etc. Additional expertise of energy efficiency or policy analysts would contribute to assessing whether a trend for a specific indicator is the expected outcome of a new policy, corresponds to technological progress, etc., or there are likely problems in the underlying data.

## 3 How should data be validated for each end-use sector?

Validation of data for energy efficiency indicators will include a set of general checks, performed within any data collection, such as an analysis of time series for breaks and outliers, a completeness assessment, etc. On those types of procedures, the statistics literature is very rich. This section focuses instead on validation procedures that are specific to energy efficiency indicators for the different end-use sectors described in the sectoral chapters. A selection of validation checks, grouped according to the criteria outlined above, is presented for energy and activity data for the residential, services, industry and transport sectors. This selection is by no means exhaustive but only provides examples to contribute to developing a sound and comprehensive data validation system, also based on data collected by the IEA from a number of OECD countries.

## Residential sector .....

### Coverage/definitions

- The coverage of the residential sector should be clearly defined. In particular, the boundaries between the residential and services sectors are often confused; data for transport of households should be excluded; etc.
- The definitions and the coverage of each end use should be clear, to avoid any misallocations. For example, data for lighting and cooking are often incorrectly reported under appliances; data for fans could be allocated to space cooling instead of appliances, etc. Chapter 4 provides detailed information on coverage and definitions at the sectoral and end-use level.
- The definitions of all types of energy sources should be clear. For example, district heating may be reported as heat or as input fuel to heat plants.

### Internal consistency

- At the sectoral level, the total residential energy consumption should be equal to the sum of the consumption of all end uses.
- At the end-use level, the total appliances energy consumption should be equal to the sum of the consumption of each appliance category (e.g. refrigerators, TVs, etc.).
- At the appliance category level (e.g. refrigerators), the energy consumption should be the product of the average energy consumption per unit (unit energy consumption) and the number of units (stock).
- For activity data, a number of relationships can be verified. For example:
  - ▶ The number of total dwellings should be larger than the number of occupied dwellings.
  - ▶ The number of total dwellings in a given year must be larger than the number of total dwellings the year before plus the number of new dwellings — the difference being the number of demolished dwellings.
  - ▶ The total heated floor area cannot be larger than the total floor area.

### Consistency with external data sources

- The total energy consumption of the residential sector should be consistent with national energy balances.
- The total number of dwellings should correspond to the figure published by the national statistics office.

### Plausibility

- The shares of the various end uses within the total residential energy consumption, as well as trends in activity data and key indicators, should clearly reflect the country-specific situation and lifestyles. Some examples follow:
  - ▶ Space heating generally represents the largest energy consumption for countries with cold climates. Ranges observed in selected OECD countries for the share of space heating in residential energy consumption are reported in Figure 8.2.

**Figure 8.2** • Share of space heating in the residential sector energy consumption for 20 selected OECD countries in 2010

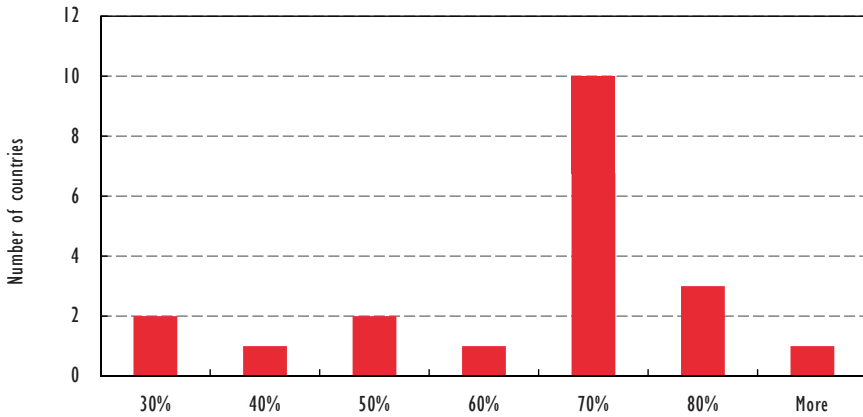

- ▶ The share of total appliances within the total residential energy consumption should be within reasonable ranges (usually much lower than 40%), unless the deviation can be explained by national circumstances. Figure 8.3 presents reported shares of appliances in the residential energy consumption for selected OECD countries.

**Figure 8.3** • Share of total appliances within the residential energy consumption for 20 selected OECD countries in 2010

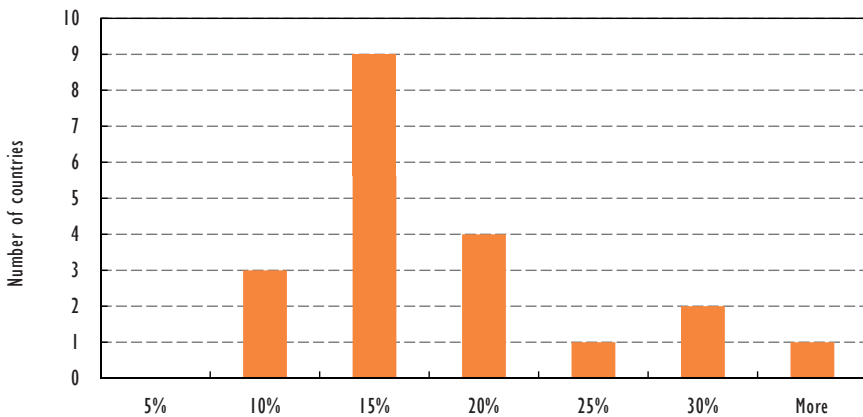

- ▶ The share of small appliances (such as telephones and personal computers) within total appliances should be small and is generally growing over time.
- ▶ The ratio of occupied dwellings to total dwellings should reflect the country's real estate market characteristics.
- ▶ The calculated average floor area per dwelling (total floor area/total number of dwellings) should reflect the country-specific situation and lifestyles and follow stable trends.



- ▶ The calculated average number of occupants per dwelling (total population/ number of occupied dwellings) should reflect the country-specific situation and lifestyles and follow stable trends.
- ▶ Indicators of energy consumption per dwelling or per dwelling area should follow stable trends.
- ▶ Energy consumption for space heating and space cooling should be consistent with time series of heating degree days (HDD) and cooling degree days (CDD), respectively.
- ▶ Unit energy consumption (UEC) of appliances, as well as average daily unit energy consumption, should be within reasonable ranges. Table 8.1 presents observed values based on the IEA data collection from fourteen OECD countries.

**Table 8.1 • Observed ranges of average UEC for selected appliances for a selection of 14 OECD countries**

kWh/ year	Refrigerators/ freezers		Dishwashers		Clothes washers		TVs/home entertainment	
	1990	2010	1990	2010	1990	2010	1990	2010
Min	340	200	220	120	150	90	80	90
Median	510	390	370	230	300	190	140	170
Max	1 500	510	950	320	730	490	190	310

## Services sector .....

### Coverage/definitions

- The coverage of the services sector should be clearly defined, for example listing all the categories of the ISIC that are included. In particular, the boundaries between the services and industry sectors are often confused. Chapter 5 provides detailed information on coverage and definitions.
- The definitions of all types of energy sources should be clear.
- For indicators based on value added, value-added data should have the same coverage/definition as their corresponding energy data (e.g. calendar years versus fiscal years; sectoral coverage).
- The services sector also includes non-building energy uses, such as street lighting, which are not reflected in some activity data, such as total services floor area.

### Internal consistency

- At the sectoral level, the total services energy consumption should be equal to the sum of the consumption of all end uses.
- In case of breakdown of services data into service categories, value added for the reference year should be additive. For example, if value-added data are based on 2005 constant prices, figures for 2005 total services value added should be equal to the sum of the 2005 value added of all the services categories.

## Consistency with external data sources

- The total energy consumption of the services sector should be consistent with national energy balances.
- Macroeconomic data, such as value added and the number of employees in the sector, should be consistent with data from international sources such as the OECD and the World Bank. Any deviations should be clearly explained.

## Plausibility

Among the four sectors, the services sector is certainly the most difficult for giving meaningful ranges to check plausibility, due to several reasons: heterogeneity of the sector, local specificities, climate, standard of living (hotels, restaurants, etc.).

- The share of each end use in the total services energy consumption should follow stable trends, after correcting for climate variations.
- The shares of the various end uses within the total services energy consumption, trends in activity data and key indicators should clearly reflect the country-specific situation and lifestyles. Some examples follow:
  - ▶ Energy consumption for space heating and space cooling should be consistent with time series of HDD and CDD, respectively.
  - ▶ Key indicators of energy consumption per floor area (e.g. space heating, space cooling, both corrected for temperature, lighting) should follow stable trends.
  - ▶ The calculated average floor area per building (total floor area/total number of buildings) should follow a stable trend.

## Industry sector .....

### Coverage/definitions

- The coverage of the industry sector should be clearly defined, for example listing all the categories of the ISIC that are included. In particular, the boundaries between the services and industry sectors are often confused. Also, data for transport-related activities should be included under the transport sector and excluded from industry.
- At the sub-sectoral level, boundaries need to be clear. For example, within the iron and steel sub-sector, it is important to verify whether energy consumption of iron and steel industry includes transformation losses and energy own use in coke oven and blast furnaces. If energy consumption in non-specified manufacturing industries is significant, consumption for some other industry sub-sectors may be underestimated, resulting in overestimated efficiency for those sub-sectors. Chapter 6 provides detailed information on coverage and definitions of the sector and its sub-sectors.
- The definitions of all types of energy sources should be clear.
- For indicators based on value added, value-added data should have the same coverage/definition as their corresponding energy data (e.g. calendar years versus fiscal years; sectoral and sub-sectoral coverage). When either energy consumption or value-added data for certain sub-sectors are missing or merged with others, an adjustment is needed to match the coverage. For example, if

energy consumption of manufacturing of rubber and plastics products is included in non-specified manufacturing industries or in chemical and petrochemical, value-added data for those related sub-sectors should be adjusted accordingly.

- When missing data for a sub-sector are obtained from a separate source, it has to be verified that they were not included in non-specified manufacturing industry in the original data, in order to avoid an overestimate of the total industry energy consumption.

### Internal consistency

- At the sectoral level, the total industry energy consumption should be equal to the sum of the consumption of all its sub-sectors.
- Value added for the reference year should be additive. For example, if value-added data are based on 2005 constant prices, figures for 2005 total industry value added should be equal to the sum of the 2005 value added of all the industrial sub-sectors.
- When a sub-sector can be disaggregated into a number of components, the energy consumption for that sub-sector should be greater than or equal to the sum of the available components. For example:
  - ▶ Non-metallic mineral products  $\geq$  Cement industry
  - ▶ Basic metals = Iron and steel + Precious and non-ferrous metals
- For activity data, when a commodity can be disaggregated into a number of components, the physical production of that commodity should be greater than or equal to the sum of its components. For example, for physical production:
  - ▶ Pulp  $\geq$  chemical pulp + mechanical pulp
  - ▶ Recovered paper  $\geq$  inked + de-inked
  - ▶ Paper and paperboard  $\geq$  sum of paper types
  - ▶ Crude steel  $\geq$  basic oxygen furnace steel + electric arc furnace steel + direct-reduced iron

### Consistency with external data sources

- The energy consumption of the industry sector and all its sub-sectors should be consistent with national energy balances.
- Macroeconomic data, such as GDP, value added and exchange rates, should be consistent with data from international sources such as the OECD and the World Bank. Any deviations should be clearly explained.
- Physical output of commodities should be consistent with data from international sources such as the FAO, the United States Geological Survey, and the World Steel Association. Any deviations should be clearly explained.

### Plausibility

- Series of energy consumption for a given sub-sector should follow similar trends to corresponding value added and physical output data for that sub-sector. Any deviations should be clearly explained.
- Some industry sub-sectors typically use specific fuels. Therefore, consumption of such fuels is expected to be reported for those sub-sectors. For example:

- ▶ Combustible renewables and waste in non-metallic minerals industry
  - ▶ Combustible renewables and waste in wood industry
  - ▶ Heat in paper industry
  - ▶ Electricity in aluminium industry
- The energy intensities for each sub-sector, either per value added or per unit of physical output, should follow stable trends and should be comparable with some benchmark values (such as other countries, industrial sub-sector average, best available technologies specific to the process, etc.). Figure 8.4 presents examples of intensities per value added observed in selected OECD countries for three different industrial sub-sectors, while Figure 8.5 presents examples of intensities per unit of physical output for three industrial sub-sectors. Both figures are based on data collected by the IEA.

**Figure 8.4** • Ranges of intensities per value added for selected industrial sub-sectors for 23 OECD countries in 2010 (based on constant 2005 USD at purchasing power parity)

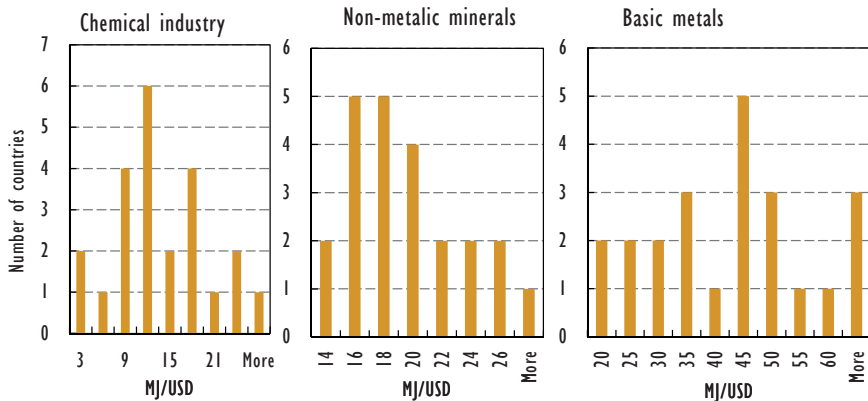

**Figure 8.5** • Ranges of intensities per unit of physical output for selected industrial sub-sectors for 15, 24 and 11 OECD countries in 2010

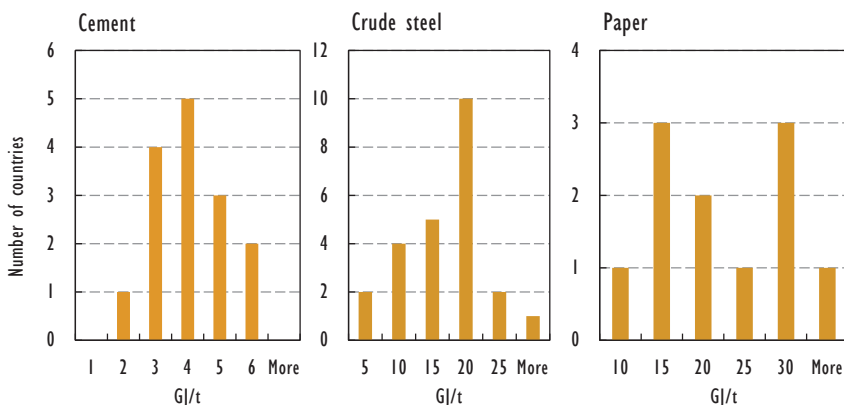

## Transport sector .....

### Coverage/definitions

- At the sectoral level, the definition and coverage should be clear. For example, off-road, military, fishing and pipelines consumption should be excluded from the transport sector for energy efficiency indicator purposes.
- The definitions and the coverage of each sub-sector and mode/vehicle type should be clear, to avoid any misallocations. For example, energy consumption and activity data for international aviation and marine bunkers should be excluded from data for air and water transport, respectively. Chapter 7 provides detailed information on coverage and definitions.
- The definitions of all types of energy sources should be clear. For example, the quantities of biofuels should be reported separately from motor gasoline and diesel.
- If significant amount of fuels are reported under non-specified consumption, the meaning should be clear, for example whether this is an estimate for fuel tourism.

### Internal consistency

- At the sectoral level, for each energy source, figures for total consumption and activity data should be equal to the sum of the different modes/vehicle types. For example:
  - ▶ The total transport energy consumption should equal the sum of the energy consumption of all sub-sectors or all modes/vehicle types, both for passenger and freight.
  - ▶ The total distance travelled in transport should equal the sum of all the distances travelled of all sub-sectors or all modes/vehicle types, both for passenger and freight.
- Relationships should hold between figures for passenger-kilometre (pkm) or tonne-kilometre (tkm), vkm and occupancy or load, for passenger and freight transport:
  - ▶  $V_{km} = \text{stock} \times \text{average distance travelled per vehicle}$
  - ▶  $P_{km} = \text{vehiclekilometres} \times \text{average occupancy}$
  - ▶  $T_{km} = \text{vehiclekilometres} \times \text{average load}$
- Energy consumption data and corresponding activity data should be consistent and complete across sub-sector and modes/vehicle types.

### Consistency with external data sources

- The energy consumption of the transport sector and all its sub-sectors (road, rail, air, water) should be consistent with national energy balances.
- Macroeconomic data, such as GDP, should be consistent with data from international sources such as the OECD and the World Bank. Any deviations should be clearly explained.

- Key activity data and indicators should be consistent with figures provided by sources like the International Transport Forum and other international sources, such as those listed in Box 7.2 in the chapter on transport.

## Plausibility

- Energy consumption data should necessarily be different from zero for some fuels, depending on the sub-sector. For example, consumption of motor gasoline and gas/diesel oil should be reported for road and consumption of electricity for rail transport.
- Activity data and key indicators for the various modes/vehicle types should fall within expected ranges, and reflect the country-specific situation (e.g. size, geography, lifestyle, etc.). Some examples follow:
  - ▶ Figures for average occupancy and load for the various modes/vehicle types should be within expected ranges. For instance, the expected load for passenger cars is between one and four occupants.
  - ▶ The average annual distance travelled by vehicle type should be reasonable and reflect country-specific conditions. For example, a reasonable average distance travelled in a year by passenger cars would range from 5 000 km to 20 000 km.
  - ▶ The average fuel economy of road vehicles (i.e. fuel consumption per distance travelled) calculated from consumption and activity data should be reasonable but may be different from theoretical values of fuel economy reported by manufacturers, by vehicle type, to account for driving habits, occupancy, traffic conditions, etc. In general, the average fuel economy of road vehicles improves over time.
  - ▶ The energy consumption per pkm and per tkm for each mode should follow stable trends and follow within reasonable ranges.

Table 8.2 provides ranges of values for selected activity data, while Figure 8.6 provides ranges of energy consumption per pkm and tkm, for selected OECD countries, based on the IEA data collection.

**Table 8.2 • Ranges of reported load and distance travelled per year for a group of 20 OECD countries in 2010**

	Average occupancy/load			Average distance travelled per year (thousand km)		
	Passenger light-duty vehicles (passengers)	Buses (passengers)	Freight road vehicles (tonnes)	Passenger light-duty vehicles	Buses	Freight road vehicles
Min	1.2	7	0.5	9	22	13
Median	1.6	13	2.5	13	37	19
Max	1.9	38	3.8	18	143	48

**Figure 8.6** • Ranges of reported energy consumption per pkm and tkm for passenger and freight transport, for 20 selected OECD countries

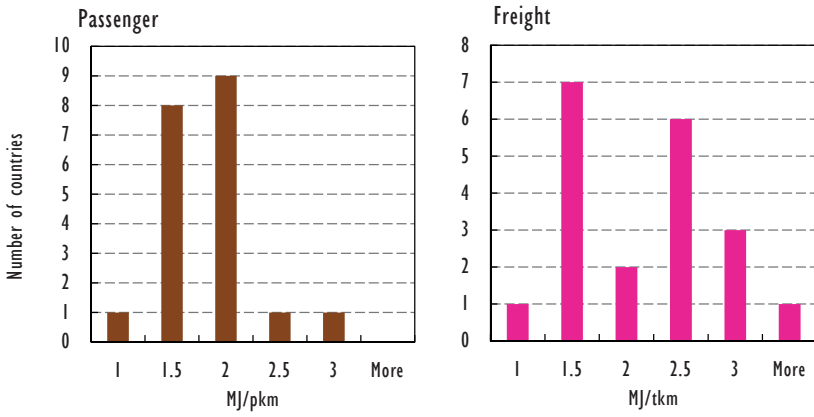

# Disseminating the Data

## 1 Why is dissemination important?

Collecting statistics and building indicators for the sake of it and without purpose or goal is pointless. Therefore one should only collect data and build indicators because there is a need for it. There is also no point in collecting and processing statistics if they are not properly disseminated. So, that is why it is of utmost importance for statisticians and analysts to ensure that data are suitably disseminated.

There is no silver bullet formula for an optimum dissemination strategy but, as often in statistics, there are a few key principles to follow in order to maximize the use of energy data and indicators.

The first rule is to identify the target group (or groups) which will be the prime user(s) of the information. There is in fact a large spectrum of potential target groups including policy makers, analysts, companies, journalists, academia and the man in the street. Each group has its own interest, its own way of looking at information, its own capacity to understand data and to further explore and interpret it.

For instance, policy makers might only have a few minutes to absorb a piece of information. That is why it is important when relaying a message to be concise and to the point, by using a clear graph or chart with a well written, powerful and punchy explanation or statement, which then in turn could be further passed on by the policy maker.

The other extreme is analysts and researchers who might spend days studying and digging into a database for further information to support their own analysis, reports and messages. They would not be satisfied with one single graph or chart but would want full access to the whole database in order to select and manipulate the data they want.

So on the one hand, there is an obvious need for concise graphs and messages, and on the other hand, there is also a need for full access to open databases. In many cases, the two needs need to be fulfilled by the same means. Dissemination therefore is multi dimensional and the work of statisticians and analysts should not be limited to collecting and processing of the data, but should also encompass dissemination as an important aspect of their core work.

Indeed, often statisticians concentrate the collection and processing of data, while forgetting the importance of marketing their work through a well thought out dissemination strategy.



## 2 What are the basic principles to follow?

As in all statistical work, there are a few key principles to follow when disseminating data or communicating analysis or derived information.

Ensuring that data are of good quality is certainly a must when disseminating. Releasing wrong data or messages based on incorrect information will indeed defeat the purpose and be counterproductive. As a consequence, only good quality data should be released; this supposes that thorough checks have been conducted (see Chapter 8) and that a certain level of confidence in the data is reached.

Not only should data be of proven quality but they should be clearly defined to avoid any ambiguity. This is for instance the case for the heating consumption in the residential sector; it should be clearly said if the consumption data have been corrected for temperature by heating degree days or not.

Equally important is the use of metadata. Metadata are additional information on how data have been collected and on some specificities the user should know when using the data. They should be easily accessible and clearly written. They more often apply to databases but can also be added to graphs or charts.

If metadata are important for databases, focused and clear messages are essential for a better understanding of graphs or charts. When showing data in graphical form, make sure that the chart shows the point which you want to make and ensure that the message is clear, concise and easy to understand.

Clearly define the units used: for instance, energy intensity which is the ratio between total primary energy supply and gross domestic product (GDP) is often reported in toe per USD. However, it is essential to mention whether GDP is calculated in market prices or in purchasing power parity (PPPs). Moreover the reference year of GDP should also be clearly identified: USD 2000, 2005, 2010 or another year basis.

When showing time series, consistency is an important element. Trends should be based on data collected through methodology which is consistent over the years. Avoid any gap or break in series due to changes in methodologies. In exceptional cases, where there was no other alternative than to use inconsistent series, users should be alerted to this fact through metadata or proper notes.

Only data which are not confidential should be disseminated. In statistics on energy efficiency as in many other statistics areas, statisticians should respect confidentiality clauses or legal acts. In fact, due to the detailed level of some of the information requested, chances are a lot higher to run into confidentiality issues when working on efficiency indicators. This could be the case for example for the energy consumption per tonne of product for some specific products which are only produced by 2 or 3 companies. If an agreement cannot be reached with the companies, the solution could be to aggregate the consumption and production with those of products of similar characteristics, risking the loss of useful information.

When releasing data through a database, access to the database should be made as easy as possible and the manipulation of data should be made user-friendly.

When releasing data in graphic or chart format, the charts and graphs should be as simple as possible, easy to read and understand. Accompany it with necessary information to facilitate understanding and with short, clear and punchy messages to highlight the main points.

### Box 9.1 • Messages should be short but clear

The two following examples illustrate the need to have short messages but not too vague in order to give the reader necessary elements for a quick understanding.

#### 1) Message related to the heating consumption in a country:

a) A vague message:

*Heating consumption has decreased in 2013.*

b) The same message but more detailed although still concise:

*Heating consumption in the residential sector has decreased by 5% in 2013. Part of the decrease is due to a milder winter with heating degree days 4% lower than in 2012.*

Although still short, the message mentions the sector, the magnitude of the decrease and gives an explanation for that decrease.

#### 2) Message related to the energy intensity of the cement sub-sector in a country:

a) A vague message:

*The energy intensity of the domestic cement production has improved in 2013.*

b) The same message but more detailed although still concise:

*In 2013, the closure of three old cement factories and their replacement by two new efficient plants have led to a 4% improvement in the energy intensity of the sub-sector, which is now 2% lower than the world average.*

Although still short, the message mentions the magnitude of the improvement in relative terms and provides an explanation for that improvement. It also gives a comparison with the world average.

## 3 What means of dissemination should be used?

There are several ways for disseminating data and indicators: they range from large databases to tweets on the social network. They include publications, booklets, one page briefs, articles in journals, press releases, websites, CDs, applications for mobile phone, etc.

The means of dissemination to adopt will depend for a large part on the target group. Policy makers rarely use databases but read briefs. Analysts prefer to make their own analysis by playing with the data, therefore using databases. As a consequence, it is essential to clearly identify the target group(s) and to prepare different means of access according to the group(s).

When targeting several groups, one should try to use several means in order not to privilege one group over another, in the hope that all needs and expectations are met. Therefore, it is important to adopt a multimedia dissemination strategy.

The following pages, far from being exhaustive, show different ways in disseminating data for selected sectors, countries and organisations. They include examples of publications as well as of web pages for each sector: residential, services, industry and transport.

One page is also dedicated to a short introduction to the *Energy Efficiency Market Report* of the IEA. This report gives its full dimension to energy efficiency since it complements a series of four existing reports on oil, coal, gas and renewables.

Another page is also dedicated to the *Energy Efficiency Indicators in Europe* website of the ODYSSEE MURE project of the European Commission.

## 4 Selected examples of dissemination practices

### Be simple but effective

#### *Residential*

Department of Energy and Climate Change, United Kingdom  
National Sample Survey Office, India

#### *Services*

Central Statistics Office, Poland  
Natural Resources Canada

#### *Industry*

Cement Sustainable Initiative  
International Aluminium Institute

#### *Transport*

European Environment Agency (EEA)  
Regional Center for Renewable Energy and Energy Efficiency (RCREEE)

#### *Energy Efficiency Market Report, IEA*

#### *Energy Efficiency Indicators in Europe, ODYSSEE MURE*

## Be simple but effective



Singapore



Viet Nam

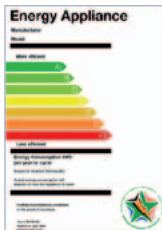

South Africa

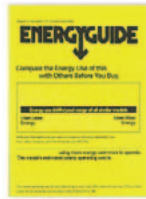

United States



Canada



Hongkong, China

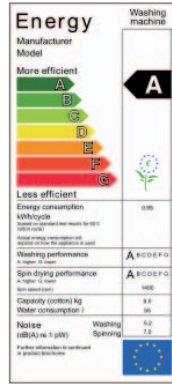

European Union



Australia

It is not always necessary to look for very sophisticated messages and representations of indicators.

Often simple illustrations are very effective, as seen from selected energy labels and guides developed all around the world.

Labelling is indeed a great popular indicator for new appliances and cars but is more and more used for the thermal performance of dwellings.

It is interesting to observe the creativity as well as certain homogeneity in the labels.

Link: selection of websites

At the border with mere indicators, well-designed illustrations and messages are often powerful vectors to draw attention to both policy makers and the man in the street on efficiency impacts.

The *Renovate Europe* site is a good example of short but powerful messages through easy-to-understand comparisons of savings.

Link:  
[www.renovate-europe.eu/](http://www.renovate-europe.eu/)  
[renovate-europe-campaign](http://renovate-europe-campaign)



## Residential: Department of Energy and Climate Change, United Kingdom

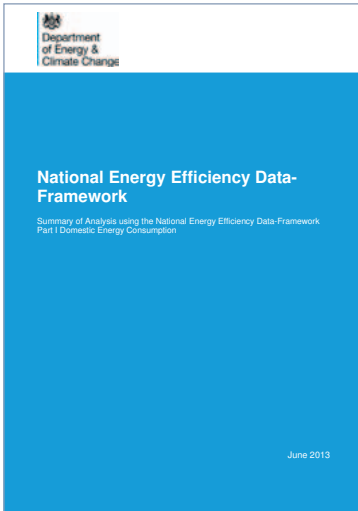

In June 2013, the Department of Energy and Climate Change published a very comprehensive report using the *National Energy Efficiency Data-Framework (NEED)*, which was set up to provide a better understanding of energy use and energy efficiency in domestic and non-domestic buildings. The report covers energy consumption in 2011 by property attributes, household characteristics, region and socio-demographic classifications. It also includes time series trends in energy consumption.

The report focuses on electricity and natural gas consumption and gives a statistical view of the consumption through distribution graphs as well as various median decompositions.

The report is complemented by a second report, Part II, summarising the impact of energy efficiency measures. The releases are supplemented by all available data tables which are published alongside the report on the DECC website, along with tools which allow users to produce customised breakdowns.

Link: [www.gov.uk/government/uploads/system/uploads/attachment\\_data/file/209089/National\\_Energy\\_Efficiency\\_Data-framework\\_June\\_2013\\_Part\\_I.pdf](http://www.gov.uk/government/uploads/system/uploads/attachment_data/file/209089/National_Energy_Efficiency_Data-framework_June_2013_Part_I.pdf)

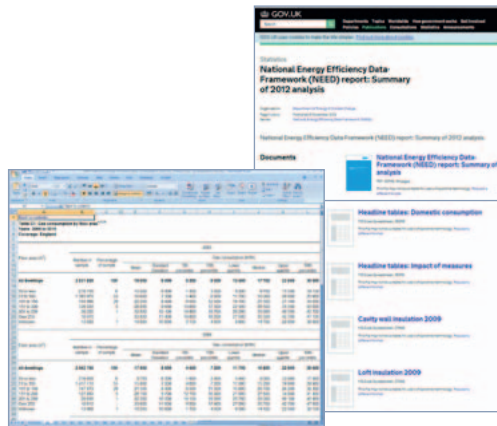
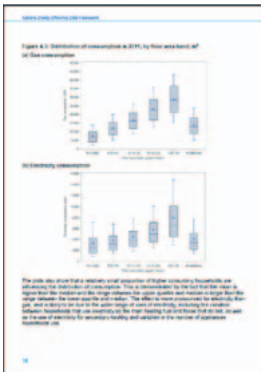

*The report provides easy-to-read distribution of consumption graphs by floor area, as well as key comments.*

*The report is complemented by data tables with detailed data from NEED. A comprehensive menu helps users to access the right data within a click.*

## Residential: National Sample Survey Office, India . . . . .

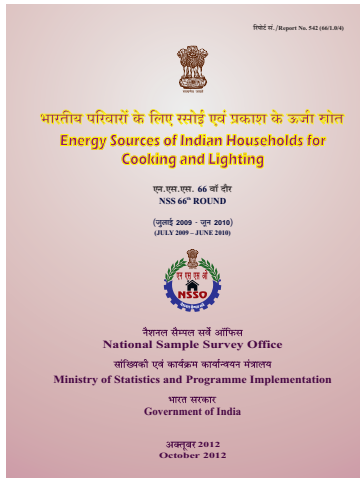

The National Sample Survey Office of the Indian Ministry of Statistics and Programme Implementation published in September 2012 a very comprehensive statistics report on *Energy Sources of Indian Households for Cooking and Lighting*.

The report is concerned with the break-up of Indian households by primary source of energy for cooking and for lighting. The break-ups are very detailed since they are given for rural and urban sectors of each State and Union Territory as well as for the country as a whole.

The report includes both modern energy types (LPG, kerosene, ...) as well as traditional ones (firewood and chips, dung cake, ...).

Link: [www.indiaenvironmentportal.org.in/files/file/Energy%20Sources%20of%20Indian%20Households.pdf](http://www.indiaenvironmentportal.org.in/files/file/Energy%20Sources%20of%20Indian%20Households.pdf)

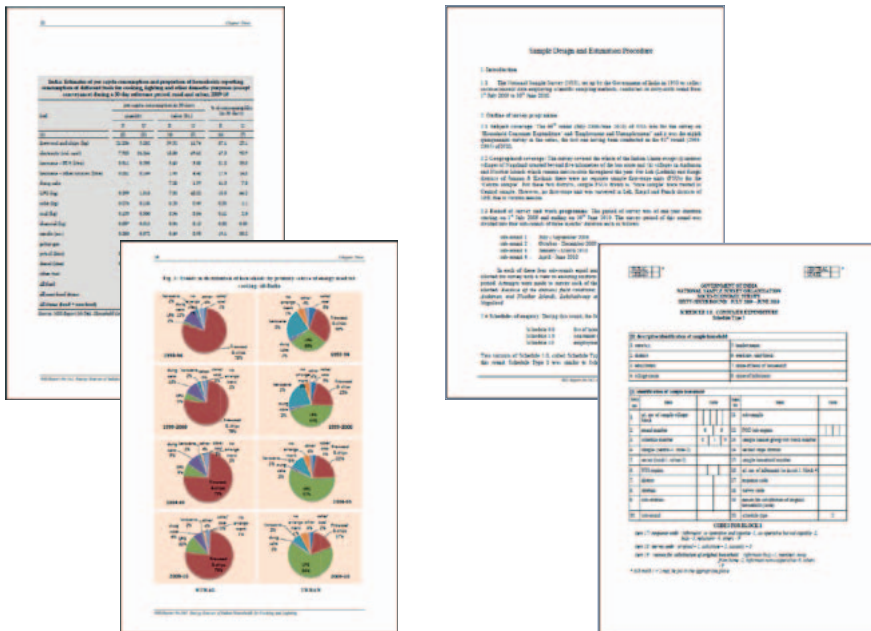

Results are presented in detailed tables as well as aggregated in selected charts

The report also includes in an Annex a Sample Design and Estimation Procedure as well as a copy of the survey questionnaire

# Services: Central Statistics Office, Poland



The Central Statistical Office (GUS) of Poland, in co-operation with the Polish National Energy Conservation Agency, has started to publish an annual publication on *Energy efficiency in Poland* as part of the series entitled "Information and statistical papers".

The aim of the publication is to present global and sector energy efficiency indicators with their analysis. After a presentation of some methodological issues (such as degree-days) the publication gives a large selection of selected energy indicators for the last 10 years and for the main economic sectors.

Several sectors are covered in the report: industry, households, transport, services as well as heat plants, and heat and power generating plants.

Link to the 2013 version (in English): [http://www.stat.gov.pl/cps/rde/xbcr/gus/ee\\_energy\\_efficiency\\_in\\_Poland\\_2001-2011.pdf](http://www.stat.gov.pl/cps/rde/xbcr/gus/ee_energy_efficiency_in_Poland_2001-2011.pdf)



Well-explained methodological remarks and definitions of basic concepts such as degree days

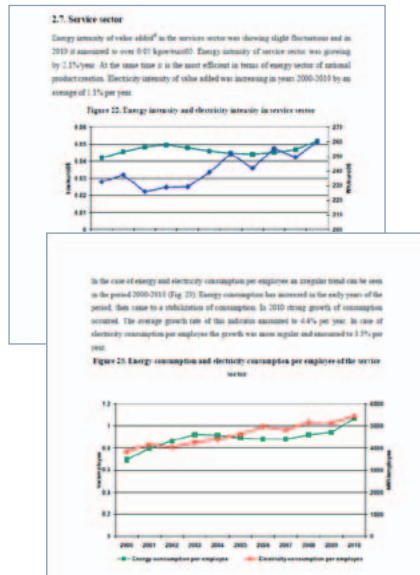

Selected graphs of energy intensity and consumption per employee



# Services: Natural Resources Canada



On its website, Natural Resources Canada hosts a very comprehensive database on energy efficiency data and indicators. The **Comprehensive Energy Use Database** provides an overview of sectoral energy markets in Canada and in each region of the country. The database covers five main sectors: Residential, Commercial/Institutional, Industrial, Transportation and the Agriculture Sector.

For each sector, the **Comprehensive Energy Use Database** shows a large number of summary tables covering both secondary energy use and GHG emissions by activity type and by end-use.

These tables are intended to complement data published in the Energy Use Data Handbook. Natural Resources Canada also publishes an **Energy Efficiency Trends in Canada** publication which delivers on Canada's commitment to provide a comprehensive summary of secondary energy use and related greenhouse gas (GHG) emissions in Canada. The publication also tracks trends in energy efficiency.

Link: [http://oee.nrcan.gc.ca/corporate/statistics/neud/dpa/comprehensive\\_tables/list.cfm?attr=0](http://oee.nrcan.gc.ca/corporate/statistics/neud/dpa/comprehensive_tables/list.cfm?attr=0)

Activity	1990	2000	2007	2009	2010
<b>Total Energy Use (PJ)</b>	10,400	10,400	10,400	10,400	10,400
<b>Commercial/Institutional Sector</b>					
Space heating	1,213	1,213	1,213	1,213	1,213
Water heating	1,213	1,213	1,213	1,213	1,213
Mechanical cooling	1,213	1,213	1,213	1,213	1,213
Electricity	1,213	1,213	1,213	1,213	1,213
Lighting	1,213	1,213	1,213	1,213	1,213
Other	1,213	1,213	1,213	1,213	1,213
<b>Residential Sector</b>					
Space heating	1,213	1,213	1,213	1,213	1,213
Water heating	1,213	1,213	1,213	1,213	1,213
Mechanical cooling	1,213	1,213	1,213	1,213	1,213
Electricity	1,213	1,213	1,213	1,213	1,213
Lighting	1,213	1,213	1,213	1,213	1,213
Other	1,213	1,213	1,213	1,213	1,213
<b>Industrial Sector</b>					
Electricity	1,213	1,213	1,213	1,213	1,213
Lighting	1,213	1,213	1,213	1,213	1,213
Other	1,213	1,213	1,213	1,213	1,213
<b>Transportation Sector</b>					
Electricity	1,213	1,213	1,213	1,213	1,213
Lighting	1,213	1,213	1,213	1,213	1,213
Other	1,213	1,213	1,213	1,213	1,213
<b>Agriculture Sector</b>					
Electricity	1,213	1,213	1,213	1,213	1,213
Lighting	1,213	1,213	1,213	1,213	1,213
Other	1,213	1,213	1,213	1,213	1,213

Selected example of tables on Secondary Energy Use and GHG Emissions by End-Use for the entire Canadian commercial/institutional sector

Activity	1990	2000	2007	2009	2010
<b>Space Conditioning</b>	1,213	1,213	1,213	1,213	1,213
Heating	1,213	1,213	1,213	1,213	1,213
Cooling	1,213	1,213	1,213	1,213	1,213
<b>Water Heating</b>	1,213	1,213	1,213	1,213	1,213
<b>Mechanical Cooling</b>	1,213	1,213	1,213	1,213	1,213
<b>Electricity</b>	1,213	1,213	1,213	1,213	1,213
<b>Lighting</b>	1,213	1,213	1,213	1,213	1,213
<b>Other</b>	1,213	1,213	1,213	1,213	1,213

Example of detailed secondary energy use data for one specific sector (Educational Services) and one specific end-use (Space Conditioning)



## Industry: Cement Sustainable Initiative .....



The Cement Sustainability Initiative from the World Business Council for Sustainable Development proposes a voluntary, independently-managed database of energy and CO<sub>2</sub> performance information on the global cement industry.

The *Getting the Numbers Right (GNR)* database covers data up to year -1; more recent data could be presented but competition law concerns recommend

a one-year time lag in publishing data.

It has grown over the years to cover around 1000 individual facilities producing 25% of global cement production. 94% of the data is assured at the participating company level by independent third parties. Standard web-based reports are also available for 12 regions and 16 countries.

Link: [www.wbcdcement.org/index.php/key-issues/climate-protection/gnr-database](http://www.wbcdcement.org/index.php/key-issues/climate-protection/gnr-database)

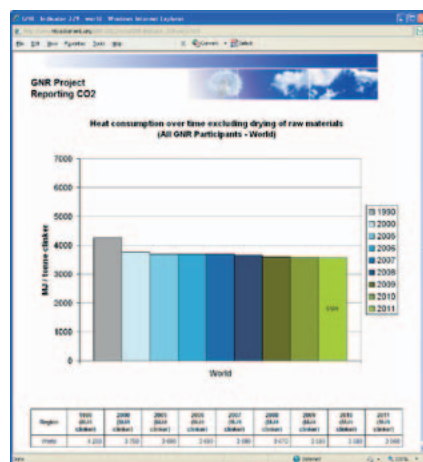

Menu driven selection of production, consumption and CO<sub>2</sub> emissions data

Example of a chart and a table (heat consumption per tonne of clinker)

## Industry: International Aluminium Institute .....

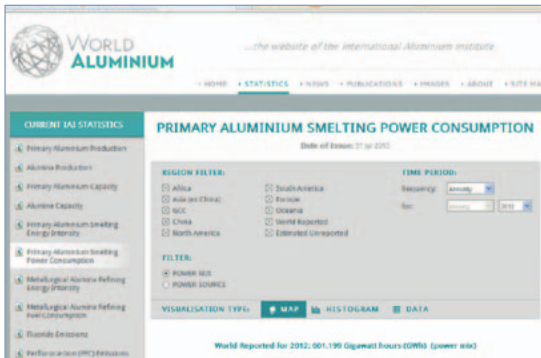

*World Aluminium*, the website of the International Aluminium Institute, contains a wealth of data related to aluminium and alumina production, capacity, smelting and refining energy consumption and power/fuel mixes as well as selected intensities and other sustainable development indicators.

The International Aluminium Institute was established in 1972 and its membership currently represents over 60% of global bauxite, alumina and aluminium production, although the data presented on World Aluminium has global coverage.

They include time series from 1973 to the most recent month on a monthly basis for production data and annually for all other datasets.

Data are presented globally or regionally depending on the dataset and can be visualised in various formats (tables, graphs, charts and maps) as well as downloaded in .csv format. Users are also able to filter/combine data and visualize results in a variety of ways to suit their needs.

World Aluminium also includes useful notes on definition, sources and aggregations.

Links: [www.world-aluminium.org/statistics/#data](http://www.world-aluminium.org/statistics/#data)

[www.world-aluminium.org/publications/tagged/statistics/](http://www.world-aluminium.org/publications/tagged/statistics/)

The screenshot shows a table of 'Alumina consumption (t) per tonne of alumina' for selected regions from 1985 to 2012. The table has columns for Year, Africa, Asia Pacific, Europe, Middle East, North America, Oceania, and World. The data shows a general downward trend in consumption over the period.

Year	Africa	Asia Pacific	Europe	Middle East	North America	Oceania	World
1985	1.00	1.00	1.00	1.00	1.00	1.00	1.00
1986	0.98	0.98	0.98	0.98	0.98	0.98	0.98
1987	0.96	0.96	0.96	0.96	0.96	0.96	0.96
1988	0.94	0.94	0.94	0.94	0.94	0.94	0.94
1989	0.92	0.92	0.92	0.92	0.92	0.92	0.92
1990	0.90	0.90	0.90	0.90	0.90	0.90	0.90
1991	0.88	0.88	0.88	0.88	0.88	0.88	0.88
1992	0.86	0.86	0.86	0.86	0.86	0.86	0.86
1993	0.84	0.84	0.84	0.84	0.84	0.84	0.84
1994	0.82	0.82	0.82	0.82	0.82	0.82	0.82
1995	0.80	0.80	0.80	0.80	0.80	0.80	0.80
1996	0.78	0.78	0.78	0.78	0.78	0.78	0.78
1997	0.76	0.76	0.76	0.76	0.76	0.76	0.76
1998	0.74	0.74	0.74	0.74	0.74	0.74	0.74
1999	0.72	0.72	0.72	0.72	0.72	0.72	0.72
2000	0.70	0.70	0.70	0.70	0.70	0.70	0.70
2001	0.68	0.68	0.68	0.68	0.68	0.68	0.68
2002	0.66	0.66	0.66	0.66	0.66	0.66	0.66
2003	0.64	0.64	0.64	0.64	0.64	0.64	0.64
2004	0.62	0.62	0.62	0.62	0.62	0.62	0.62
2005	0.60	0.60	0.60	0.60	0.60	0.60	0.60
2006	0.58	0.58	0.58	0.58	0.58	0.58	0.58
2007	0.56	0.56	0.56	0.56	0.56	0.56	0.56
2008	0.54	0.54	0.54	0.54	0.54	0.54	0.54
2009	0.52	0.52	0.52	0.52	0.52	0.52	0.52
2010	0.50	0.50	0.50	0.50	0.50	0.50	0.50
2011	0.48	0.48	0.48	0.48	0.48	0.48	0.48
2012	0.46	0.46	0.46	0.46	0.46	0.46	0.46

*Example of indicator related to the energy consumption per tonne of alumina (1985-2012) per selected region*



*Example of easy to understand map accompanied with proper definitions*

## Transport: European Environment Agency .....



The *European Environment Agency (EEA)* published on its website a wealth of information, reports, articles, statistics, and databases on a variety of topics related to environment. They range from “A” Agriculture or Air pollution to “W” Waste or Water. Since fuel combustion and more generally energy use are responsible for the largest part of CO<sub>2</sub> emissions,

the EEA website contains a large selection of statistics and indicators on the energy sector and in particular on the transport sector.

The site is menu-driven and user-friendly. Within a few clicks it is easy to access the topic, information, graphs and data needed. Moreover the site provides the sources of the information and when needed detailed metadata.

The site also contains questions and answers either through text or through more detailed graphs and charts as shown in the example below regarding a key policy question: Is transport becoming more efficient?

Link: [www.eea.europa.eu/data-and-maps/figures#c5=energy&c9=&c15=all&c0=15&b\\_start=45](http://www.eea.europa.eu/data-and-maps/figures#c5=energy&c9=&c15=all&c0=15&b_start=45)

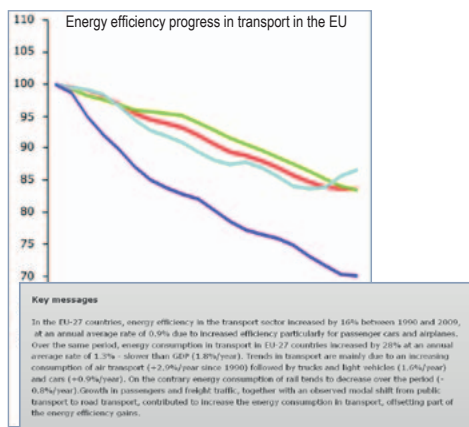

*Selected graph on energy efficiency progress in the transport in the EU with a text box providing a key message for the reader*

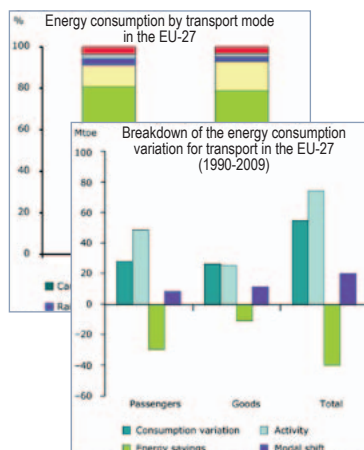

*More detailed information given through additional graphs for better understanding the progress (or not) in energy efficiency progress in the transport in the EU*

## Transport: Regional Center for Renewable Energy and Energy Efficiency



Plan Bleu in cooperation with the *Regional Center for Renewable Energy and Energy Efficiency (RCREEE)* have initiated a project with principal aim of kick-starting a new process in regional countries for several objectives including capacity building, disseminating a culture of indicators among policy makers, raising awareness of the issues around availability and reliability of energy data and socio-economic data for developing indicators. The project targets ten Southern and Eastern Mediterranean countries.

In October 2012, RCREEE released a comprehensive document on *Energy efficiency in the Southern and Eastern Mediterranean countries*. The document covers indicators for several key sectors from energy transformation sector to the

agriculture and fishing sector. It covers selected indicators for the transport sector.

Since the document is a regional document, it offers a comparison between the current situation as well as between the evolution of the situation since 2003 in the 10 regional countries. The document also gives clear recommendations for taking the process further.

Link: [www.rcreee.org/sites/default/files/rs\\_eeindicatorsinthesouthernandeasternmediterraneancountries\\_2012\\_en.pdf](http://www.rcreee.org/sites/default/files/rs_eeindicatorsinthesouthernandeasternmediterraneancountries_2012_en.pdf)

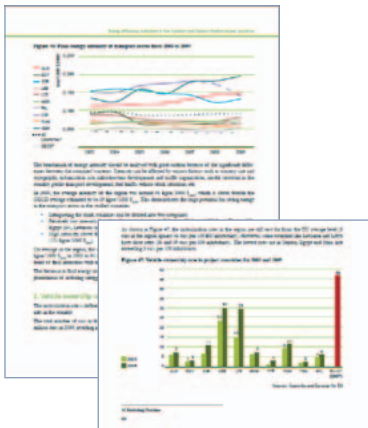

*Selected graphs on raw data regarding private car stocks, vehicle ownership as well evolution of final energy intensity of the transport sector. Useful comments are added to the graphs.*



*Graph illustrating the specific energy consumption of private cars per country for 2003 and 2009. Comments are also provided.*

## Energy Efficiency Market Report, IEA .....



Starting in 2013, the IEA publishes an annual *Energy Efficiency Market Report* which complements the initial IEA series of Market Trends and Medium-Term Prospects reports on oil, natural gas, coal and renewables. Energy savings through energy efficiency is not so much a “hidden fuel” but could in fact become the “first fuel”; this explains why a report on energy efficiency has all its place within a series on primary energy sources.

The report includes various chapters encompassing policy, market, technology, case studies and indicators. Based for a large part on the energy efficiency statistics collected by the IEA, the report includes a full chapter on *What the Numbers Say: Energy Efficiency and Changing Energy Use*. The chapter first looks at global trends and then

focuses on a series of indicators on industry, residential and transport.

For selected IEA member countries, for which detailed data are available, the report provides a set of graphs on changes in consumption and intensities decomposed in various effects (activity, structure, efficiency) and many other graphs on sectoral breakdown of consumption by sector or activity.

A comprehensive page on Energy Efficiency is also available on the IEA website; the page covers the various aspects of the work if the IEA on energy efficiency from energy statistics to indicators, measures and policy.

Links: [www.iea.org/W/bookshop/add.aspx?id=460](http://www.iea.org/W/bookshop/add.aspx?id=460)

[www.iea.org/topics/energyefficiency/](http://www.iea.org/topics/energyefficiency/)



*Selected graphs on sectoral consumption breakdown and decomposition*



*The IEA website includes a full page dedicated to the work of the IEA on energy efficiency*



## Energy Efficiency Indicators in Europe, ODYSSEE MURE...



ODYSSEE MURE is a project supported under the Intelligent Energy Europe Programme of the European Commission and coordinated by ADEME. It aims at monitoring energy efficiency trends and policy measures in Europe.

The project relies on two comprehensive databases: ODYSSEE and MURE. ODYSSEE contains, on the one hand, detailed data on the energy consumption drivers by end-use and sub-sector and, on the other hand, energy efficiency and

CO<sub>2</sub> related indicators. MURE is a data base on policy measures.

The **ODYSSEE MURE** website provides a lot of information and documents related to energy efficiency indicators in Europe. Indicators cover macro level, industry, services, residential and transport. The key indicators can be visualized in various ways including maps, time series and top ten ranking for each indicator. New data facilities have been added to ease the consultation of the ODYSSEE indicators.

The **ODYSSEE MURE** website also provides a link to the full ODYSSEE database which contains much more complete and detailed indicators for EU countries as well as the corresponding raw data.

Link: [www.odyssee-mure.eu/](http://www.odyssee-mure.eu/)



*Selected example highlighting map, chart and table for final energy intensity*



*The Energy Efficiency Trends in the EU publication also provides powerful graphs and messages on energy efficiency indicators*



# Annex A

## Abbreviations, Acronyms and Units of Measure

### 1 Abbreviations and acronyms

BOF	basic oxygen furnace
CDD	cooling degree days
CEPI	Confederation of European Paper Industries
CFLs	compact fluorescent lights
CO <sub>2</sub>	carbon dioxide
CSI	Cement Sustainability Initiative
DRI	direct reduced iron
EAf	electric arc furnace
EU	European Union
FAO	Food and Agriculture Organization
GDP	gross domestic product
GPS	global positioning systems
HDD	heating degree days
HDV	heavy duty vehicles
IAI	International Aluminium Institute
ICAO	International Civil Aviation Organization
IEA	International Energy Agency
IFA	International Fertilizer Industry Association
ISIC	United Nations International Standard Industrial Classification of all Economic Activities
ITF	International Transport Forum
LEDs	light-emitting diodes
LPG	liquefied petroleum gas
ODYSSEE	Online Database for Yearly Assessment of Energy Efficiency
OECD	Organisation for Economic Co-operation and Development
PLDV	passenger light-duty vehicles
PPP	purchasing power parity
SUVs	sport utility vehicles
TFC	total final consumption
UEC	unit energy consumption
UIC	International Union of Railways
WMO	World Meteorological Organization



## 2 Units of Measure

EJ	exajoule ( $10^{18}$ joules)
GJ	gigajoule ( $10^9$ joules)
kg	kilogramme
km	kilometre
ktoe	kilotonne of oil equivalent
kWh	kilowatt hour ( $10^3$ watt hours)
MJ	megajoule ( $10^6$ joules)
Mtoe	megatonne of oil equivalent
MWh	megawatt hour ( $10^6$ watt hours)
pkm	passenger-kilometre
t	tonne
tkm	tonne-kilometre
toe	tonne of oil equivalent
USD	US dollar
vkm	vehicle-kilometre

# Annex B

## Definitions of Sectors

The table below shows how the boundaries of the four sectors (residential, services, industry and transport) illustrated in Figure 3.4 are defined in this manual for energy efficiency indicators purposes, according to the International Standard Industrial Classification of all Economic Activities (ISIC), Revision 4, where the mapping is possible.

Note that these sectoral definitions may differ slightly from the corresponding definitions used for the IEA energy balances. For example, non-energy use across sectors is excluded for energy efficiency indicators purposes; some transformation processes are included under the Iron and steel sub-sector; several sub-sectors are not covered by this manual but are grouped under "Other".

**Table B.1 • Correspondence of sectors to ISIC Revision 4**

Sectors	Correspondence to ISIC Rev. 4
Residential	Report fuels consumed by all households including "households with employed persons ISIC Divisions 97 and 98."
Services	Report fuels consumed by business and offices in the public and private sectors. ISIC Divisions 33, 45, 46, 47, 52, 53, 55, 56, 58, 59, 60, 61, 62, 63, 64, 65, 66, 68, 69, 70, 71, 72, 73, 74, 75, 77, 78, 79, 80, 81, 82, 84 (excluding Class 8422), 85, 86, 87, 88, 90, 91, 92, 93, 94, 95, 96 and 99.
Industry	
<i>Iron and steel</i>	ISIC Group 241 and Class 2431. Consumption in coke ovens and blast furnaces, usually part of transformation processes and energy industry own use, are included here for the purpose of energy efficiency indicators.
<i>Chemical and petrochemical</i>	ISIC Divisions 20 and 21.
<i>Non-ferrous metals</i>	ISIC Group 242 and Class 2432.
<i>Non-metallic minerals</i>	ISIC Division 23. Report glass, ceramic, cement and other building materials industries.
<i>Machinery</i>	ISIC Divisions 25, 26, 27 and 28. Report fabricated metal products, machinery and equipment other than transport equipment.
<i>Transport equipment</i>	ISIC Divisions 29 and 30.
<i>Food and tobacco</i>	ISIC Divisions 10, 11 and 12.
<i>Wood and wood products</i>	ISIC Division 16.

Sectors	Correspondence to ISIC Rev. 4
<i>Paper, pulp and print</i>	ISIC Divisions 17 and 18. Includes production of recorded media.
<i>Textile and leather</i>	ISIC Divisions 13, 14 and 15.
<i>Industries not elsewhere specified</i>	ISIC Divisions 22, 31, 32 as well as any manufacturing industry not listed above nor in "Other".
<b>Transport</b>	Report fuels used in all transport activities irrespective of the economic sector in which the activity occurs, with the exception of military use.
<i>Road</i>	
<i>Rail</i>	
<i>Air</i>	ISIC Divisions 51.
<i>Water</i>	ISIC Divisions 50.
<b>Other – not addressed in this manual</b>	
<i>Mining and quarrying</i>	ISIC Divisions 07 and 08 and Group 099.
<i>Construction</i>	ISIC Divisions 41, 42 and 43.
<i>Water supply, sewerage, waste management</i>	ISIC Division 36, 37, 38, 39.
<i>Agriculture/forestry</i>	Report fuels consumed by users classified as agriculture, hunting and forestry by ISIC as follows: ISIC Divisions 01 and 02.
<i>Fishing</i>	Fuels delivered for inland, coastal and deep-sea fishing. Also include energy used in the fishing industry as specified in ISIC Division 03.
<i>Pipeline transport</i>	
<i>Non-specified other sectors</i>	Activities not included elsewhere. This category includes military fuel use for all mobile and stationary consumption (e.g. ships, aircraft, road and energy used in living quarters), regardless of whether the fuel delivered is for the military of that country or for the military of another country.
<i>Non-energy use</i>	Covers all fuels used for non-energy purposes across sectors.

# Annex C

## Temperature Correction and Heating Degree Days

The amount of energy required for space heating highly depends on the external temperature, and this impact on energy consumption may easily mask the effects of energy efficiency improvements. For example, a country may dramatically reduce the amount of energy it needs for space heating over a year simply due to an exceptionally warm winter; in another country, the reduction in energy consumption due to energy efficiency improvements of heating systems may be more than compensated by the extra requirement of energy due to an extremely cold winter.

Therefore, to accurately monitor the evolution in time of energy consumption for space heating in the residential and services sectors, it is essential to eliminate the impact of temperature variations and to produce climate-corrected data. One of the most common methodologies adopted for such correction is the use of heating degree days (HDD).

HDD are a simplified measure of the intensity and duration of cold weather over a certain period in a given location. The value of HDD for a period, for example a winter, is determined by subtracting for each day the average daily temperature from a preset base temperature, and then adding up the days of the period in which the average outside air temperature is lower than the base temperature. When the outside air temperature is equal to or higher than the base temperature, HDD are zero. The higher heating degree days, the colder the season, the greater the amount of energy required for space heating. HDD can be defined as:

$$\text{HDD} = \sum_{\substack{k=1 \\ T_{base} > T_k}}^n (T_{base} - T_k)$$

where:  $T_{base}$  is the base temperature.

$T_k$  is the average temperature of day  $k$ .

$n$  is the total number of day in the given period.

As noted above, two factors are key for the calculation of HDD. The first is the base temperature, which should be set at the level of outside air temperature at which residents of a given region tend to turn on their heating systems. This level can vary in different regions depending on many factors, such as the ability to tolerate cold temperatures, the portfolio variety of building types, the thermal properties of buildings, the density of occupants, etc. For example, the base temperature in the United Kingdom is typically 15.5°C while in the United States it is typically 65°F (equivalent to 18°C). The base temperature should be carefully determined based on the characteristics of the region: this choice will impact the climate correction of the energy consumption data. It may also evolve in time, for example if people already turn on their thermostat at higher outside temperatures.

The second factor is the time series of average daily temperatures. The simplest way to compute them would be to average the maximum and minimum temperatures  $(T_{min} + T_{max})/2$  for the day. A more accurate calculation would be to average more

frequent observations, e.g. hourly, to prevent irregular temperature fluctuations from having too strong an impact on the mean.

For example, if the average temperature on one day is 5 degrees below the base temperature, there are five HDD for that day. To get the annual number of HDD, all positive values of HDD are summed for each day in the year.

A further level of complication is due to the need to compute nationally representative HDD time series, as HDD may vary across regions in a country. The calculation of national HDD requires that appropriate weights, usually linked to the number of residents or the number of households, are applied to HDD figures for each region.

When the national HDD figures are available, the data of energy consumption for space heating can be corrected for temperature variations. A possible procedure for the correction is shown below:

$$\text{Energy consumption}_{(\text{corr},i)} = \frac{\text{Energy consumption}}{1 - \sigma_{\text{heat}}(1 - \tau_{\text{heat},i})}$$

where:  $\text{Energy consumption}_{(\text{corr},i)}$  is the corrected energy consumption for the year  $i$ ;

$\tau_{\text{heat},i}$  is the temperature correction factor, or the ratio between HDD in the given year  $i$  and the average annual HDD in the entire period in analysis; and

$\sigma_{\text{heat}}$  is the elasticity for adjusting heating requirements, often assumed to be equal to 1.

Such correction intends to remove the fluctuations in energy consumption due to fluctuations in temperature in the given year compared with the average temperature of a country. For example, if a year has 500 HDD and the annual average HDD for the country is 250, the corrected energy consumption for space heating would be half of the actual energy consumption (assuming that the elasticity factor is equal to 1). Of course, comparison of space heating efficiency indicators across countries is still difficult as a country on average experiencing colder temperatures than another country will need on average to consume more to heat the same floor area.

Similarly, cooling degree days (CDD) are a measure of the intensity of warm weather to correct energy consumption data for space cooling.

### Box C.1 • Possible sources for weather data

Time series of national HDD and CDD can be obtained from national meteorological services. At the local level, airport authorities could provide long-term temperature data for a given region. At the international level, the World Meteorological Organization (WMO) has links to various national meteorological services.

The United States Department of Energy offers weather data for more than 2 100 locations — 1 042 locations in the United States, 71 locations in Canada, and more than 1 000 locations in 100 other countries throughout the world. The weather series for these locations, arranged by region and country following the WMO classification, can be downloaded at no charge within the “Energy Plus Energy Simulation Software” package pages.

\* See [http://www.wmo.int/pages/index\\_en.html](http://www.wmo.int/pages/index_en.html). \*\* See [http://apps1.eere.energy.gov/buildings/energyplus/weatherdata\\_about.cfm](http://apps1.eere.energy.gov/buildings/energyplus/weatherdata_about.cfm).

# Annex D

## Collection of Country Practices

Each of the 160 practices selected in this Annex is presented using a unique format. Having only one format for all will certainly ease the reading and facilitate cross-practices comparison.

Figure D.1 provides the main keys for reading a practice. The first row gives the name of the country where the practice took place and a coded number. The first letter of the number corresponds to the sector (e.g. R for Residential); the next two letters correspond to the methodology used in the practice (e.g. Su for Survey). They are followed by the number of the practice for that sector and that methodology. The number is allocated by alphabetical order based on the country name.

The template itself is divided into 3 parts: the first part (1) gives information on the background of the practice (purpose of the practice, organisation in charge, etc.); the second part (2) lists detailed information on the data collection (or inputs/outputs in the case of modelling): sample design, sample size, frequency, data collected, etc. At the bottom of the template the third part (3) provides useful notes, comments and recommendations, including when available a list of additional documents to consult.

**Figure D.1 • How to read a practice template**

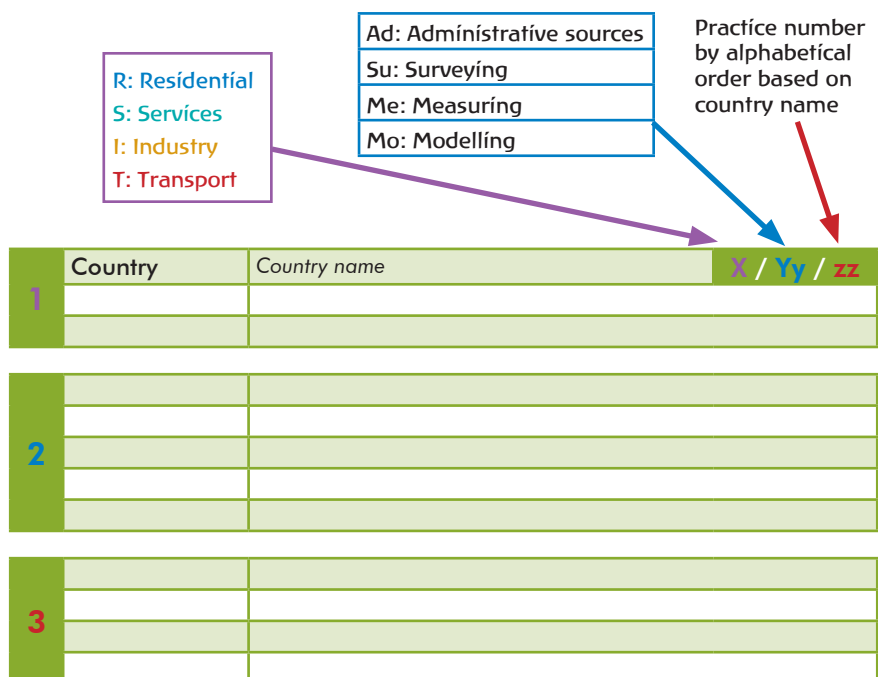

# Index of country practices

## Residential .....195

### Administrative sources

Albania .....	195	Italy .....	197,204
Belgium .....	196,197	Korea.....	205
Bosnia.....	198	Netherlands .....	206
Bulgaria .....	197	New Zealand.....	207
Canada .....	199	Norway.....	197
Czech Republic.....	197,200	Portugal .....	197
Denmark.....	197,201	Romania .....	197
France .....	197	Spain .....	208
Germany.....	197	Togo .....	209
Greece.....	197	Ukraine.....	210
Hungary.....	197	United Kingdom .....	211,212
Indonesia .....	202	United States .....	213
Israel* .....	203		

### Surveying

Albania .....	214	Hungary.....	217
Austria .....	215	Indonesia .....	228
Belgium .....	216,217	Italy .....	217,229
Bosnia and Herzegovina .....	223	Korea.....	230
Bulgaria .....	217	Norway.....	217,231
Canada .....	218	Portugal .....	217
People's Republic of China.....	219, 220	Romania .....	217,232
Croatia .....	221,222,223	Spain .....	233
Czech Republic.....	217,224	Sweden .....	234
Denmark.....	217,225	Thailand .....	235
France .....	217	Togo .....	236
Germany.....	217,226	United Kingdom .....	237
Greece.....	217	United States .....	238
Hong Kong, China .....	227		

### Measuring

Austria .....	239	Italy .....	240
Belgium .....	240	Norway.....	240
Bulgaria.....	240	New Zealand.....	242
Czech Republic.....	240	Portugal .....	240
Denmark.....	240,241	Romania .....	240
France .....	240	Spain .....	243
Germany.....	240	Sweden .....	244
Greece.....	240	Togo .....	245
Hungary.....	240		

### Modelling

Albania .....	246	Italy .....	255,256
Australia .....	247	Mexico .....	257
Austria .....	248	New Zealand.....	258
Bosnia and Herzegovina .....	249	Romania .....	259
Canada .....	250	Spain .....	260
Croatia .....	249,251	Switzerland.....	261,262
Czech Republic.....	252	United Kingdom .....	263
Denmark.....	253	United States .....	264
Indonesia .....	254		

\*See Annex F.

## Services .....265

### Administrative sources

Belgium .....	265	Mexico .....	271
Bosnia and Herzegovina .....	266,267	Netherlands .....	272
Hong Kong, China .....	268	Spain .....	273
Israel* .....	269	United Kingdom .....	274
Korea.....	270		

### Surveying

Austria .....	275	Hong Kong, China .....	283
Belgium .....	276	Korea.....	284
Bosnia and Herzegovina .....	277,280	New Zealand.....	285
Canada .....	278	Spain .....	286
Croatia .....	279,280	Sweden .....	287,288
Czech Republic.....	281	Ukraine.....	289
Germany.....	282	United States .....	290

### Measuring

Bosnia and Herzegovina .....	291	Sweden .....	293
New Zealand.....	292		

### Modelling

Australia .....	294	Mexico .....	299
Belgium .....	295	New Zealand.....	300
Bosnia and Herzegovina .....	297	Spain .....	301
Canada .....	296	Switzerland.....	302
Croatia .....	297	United Kingdom .....	303
EU Countries 27+2 .....	298	United States .....	304

## Industry .....305

### Administrative sources

Australia .....	305	Korea.....	311
Belgium .....	306	Spain .....	312
Bosnia and Herzegovina .....	307	Turkey.....	313
Canada .....	308	United Kingdom .....	314,315
Israel* .....	309	United States .....	316
Italy .....	310		

### Surveying

Australia .....	317	Netherlands .....	333
Austria .....	318	New Zealand.....	334
Belgium .....	319-322	Slovakia .....	335
Bosnia and Herzegovina .....	323,326	Spain .....	336
Canada .....	324,325	Sweden .....	337
Croatia .....	326	Switzerland.....	338,339
Czech Republic.....	327	Thailand .....	340
France .....	328	Turkey.....	341
Indonesia .....	329	Ukraine.....	342
Kazakhstan .....	330	United Kingdom .....	343
Korea.....	331	United States .....	344,345
Mexico .....	332		

### Measuring

Japan .....	346
-------------	-----

\*See Annex F.



**Modelling**

Canada .....	347	Sweden .....	351
Croatia .....	348	Switzerland.....	352,353
Germany.....	349	United States .....	354
Mexico .....	350		

**Transport..... 355****Administrative sources**

Australia .....	355	Israel* .....	360
Bosnia and Herzegovina .....	356	Japan .....	361
Brazil .....	357	Korea.....	362
Canada .....	358	Mexico .....	363
Ireland .....	359	New Zealand.....	364

**Surveying**

Australia .....	365	Mexico .....	371
Canada .....	366	New Zealand.....	372
Czech Republic.....	367	Sweden .....	373
France .....	368,369	Ukraine.....	374
Korea.....	370		

**Measuring**

Canada .....	375
--------------	-----

**Modelling**

Brazil .....	376	Switzerland.....	379
Canada .....	377	United Kingdom .....	380
New Zealand.....	378		

\*See Annex F.

# 1 Residential

<b>Background</b>	<b>Country</b>	Albania	<b>R/Ad/01</b>
	<b>Organisation</b>	National Agency of Natural Resources	
	<b>Data collection purpose</b>	To establish residential energy and activity statistics such as energy consumption per dwelling, energy cost and consumer behaviour	
<b>Collection</b>	<b>Sources</b>	<ul style="list-style-type: none"> <li>• Government statistics office</li> <li>• Energy utilities (gas, oil, electricity, other)</li> </ul>	
	<b>Data collected</b>	Data on the number of dwellings, population, age, income, employment, etc.	
<b>Comments</b>	<b>Main challenges</b>	<ul style="list-style-type: none"> <li>• Long time to establish a relationship with the organisation</li> <li>• In paper format — difficult to transfer to digital format</li> <li>• Infrequent data collection</li> <li>• Low response rate</li> </ul>	
	<b>Additional observations</b>	Energy data have to be coordinated with the government statistics office (Albanian Institute of Statistics)	

<b>Background</b>	<b>Country</b>	Belgium	<b>R/Ad/02</b>
	<b>Organisation</b>	Vision on Technology	
	<b>Data collection purpose</b>	To establish energy and activity statistics in the residential sector	
<b>Collection</b>	<b>Sources</b>	<ul style="list-style-type: none"> <li>• Government statistics office</li> <li>• Energy utilities (gas, oil, electricity, other)</li> </ul>	
	<b>Data collected</b>	<ul style="list-style-type: none"> <li>• Electricity and natural gas supplied by the grid operators (yearly obligatory reporting)</li> <li>• Census building statistics of newly built dwellings</li> </ul>	
<b>Comments</b>	<b>Main challenges</b>		
	<b>Additional observations</b>	The practices apply only to the region of Flanders	

<b>Background</b>	<b>Country</b>	Belgium, Bulgaria, Czech Republic, Denmark, France, Germany, Greece, Hungary, Italy, Norway, Portugal, Romania	<b>R/Ad/03</b>
	<b>Organisation</b>	REMODECE Project	
	<b>Data collection purpose</b>	To estimate yearly national energy consumption based on two-week household measurements	
<b>Data collection</b>	<b>Sources</b>	<ul style="list-style-type: none"> <li>• Government statistics offices</li> <li>• Energy utilities (gas, oil, electricity, other)</li> </ul>	
	<b>Data collected</b>	<ul style="list-style-type: none"> <li>• Number of households in the country</li> <li>• Government statistics offices (Statistics Norway): average electricity demand of households</li> <li>• Meteorologisk Institutt (Norwegian weather forecast bureau): daily temperature data for various places in Norway</li> </ul>	
<b>Comments</b>	<b>Main challenges</b>	<ul style="list-style-type: none"> <li>• High cost to obtain data</li> <li>• Time-consuming to gather data</li> <li>• Many data points crossed off due to confidentiality of the sources</li> </ul>	
	<b>Additional observations</b>		

<b>Background</b>	Country	Bosnia	<b>R/Ad/04</b>	
	Organisation	Ministry of Industry, Energy and Mining of Republic of Srpska		
	Data collection purpose	To establish residential sector energy statistics		
<b>Data collection</b>	Sources	<ul style="list-style-type: none"> <li>• Government statistics office</li> <li>• Energy utilities (gas, oil, electricity, other)</li> <li>• Manufacturers</li> </ul>		
	Data collected	<ul style="list-style-type: none"> <li>• Electricity consumption by sector</li> <li>• Heat production and consumption by sector</li> <li>• Solid biofuel consumption</li> <li>• Coal consumption</li> <li>• Natural gas consumption</li> </ul>		
<b>Comments</b>	Main challenges	<ul style="list-style-type: none"> <li>• Time-consuming to gather data</li> <li>• In paper format – difficult to transfer to digital format</li> <li>• Shipment data from manufacturers did not have appliance specifications (e.g. size, unit energy consumption, model)</li> <li>• Some data are estimated and incomplete</li> </ul>		
	Additional observations			

<b>Background</b>	<b>Country</b>	Canada	<b>R/Ad/05</b>
	<b>Organisation</b>	Natural Resources Canada	
	<b>Data collection purpose</b>	To obtain total appliance stock and total appliance energy use	
<b>Collection</b>	<b>Sources</b>	National or international associations and organisations	
	<b>Data collected</b>	Data on major appliances shipments and unit energy consumption for new major appliances	
<b>Comments</b>	<b>Main challenges</b>	<ul style="list-style-type: none"> <li>• High cost to obtain data</li> <li>• Time-consuming to gather data</li> <li>• Many data points crossed off due to confidentiality of the sources</li> <li>• Needed to establish a Memorandum of Understanding with a given organisation</li> </ul>	
	<b>Additional observations</b>		

Background	Country	Czech Republic	R/Ad/06
	Organisation	Ministry of Industry and Trade	
	Data collection purpose		
Collection	Sources	<ul style="list-style-type: none"> <li>• Government statistics office</li> <li>• Energy utilities (gas, oil, electricity, other)</li> <li>• Manufacturers</li> </ul>	
	Data collected	Coal, biomass production and trade; solar collectors and heat pumps trade; gas and electricity trade, etc.	
Comments	Main challenges		
	Additional observations		

<b>Background</b>	<b>Country</b>	Denmark	<b>R/Ad/07</b>
	<b>Organisation</b>	IT Energy	
	<b>Data collection purpose</b>	To estimate residential energy consumption with the residential model. The model is populated with administrative-based data.	
<b>Data collection</b>	<b>Sources</b>	<ul style="list-style-type: none"> <li>• Government statistics office</li> <li>• Energy utilities (gas, oil, electricity, other)</li> <li>• Manufacturers</li> <li>• National or international associations and organisations</li> </ul>	
	<b>Data collected</b>	<ul style="list-style-type: none"> <li>• Number of dwellings by type, from Government statistics office (Danish Statistics Office)</li> <li>• Total residential electricity consumption, from Danish Energy Association</li> <li>• Appliance data from manufacturers</li> <li>• Sales figures for home appliances, from Danish organisation for importers of consumer appliances</li> </ul>	
<b>Comments</b>	<b>Main challenges</b>	<ul style="list-style-type: none"> <li>• Time-consuming to gather data</li> <li>• Long time to establish a relationship with the organisation</li> <li>• Many data points crossed off due to confidentiality of the sources</li> <li>• In paper format — difficult to transfer to digital format</li> <li>• Shipment data from manufacturers did not have appliance specification (<i>e.g.</i> size, unit energy consumption, model)</li> </ul>	
	<b>Additional observations</b>	Different organisations are starting to show interest in collaborating on energy data collection	



<b>Background</b>	<b>Country</b>	Indonesia	<b>R/Ad/08</b>
	<b>Organisation</b>	Data and Information Centre, Ministry of Energy and Mineral Resources	
	<b>Data collection purpose</b>	To assure accuracy of energy supply data	
<b>Data collection</b>	<b>Sources</b>	<ul style="list-style-type: none"> <li>• Government statistics office</li> <li>• Energy utilities (gas, oil, electricity, other)</li> </ul>	
	<b>Data collected</b>	<ul style="list-style-type: none"> <li>• Socio-economic data</li> <li>• Energy intensity data</li> <li>• Sales of energy (oil, electricity, gas)</li> <li>• Production of energy</li> <li>• Resources and infrastructure capacity (refinery and power plants)</li> </ul>	
<b>Comments</b>	<b>Main challenges</b>	In paper format — difficult to transfer to digital format	
	<b>Additional observations</b>	Making data updates via a website would make it easier to transfer data to digital format. Regular energy consumption surveys are needed to establish energy consumption trends.	

<b>Background</b>	<b>Country</b>	Israel*	<b>R/Ad/09</b>
	<b>Organisation</b>	Central Bureau of Statistics	
	<b>Data collection purpose</b>	To establish national energy balances	
<b>Collection</b>	<b>Sources</b>	<ul style="list-style-type: none"> <li>• Energy utilities (gas, oil, electricity, other)</li> <li>• Manufacturers</li> <li>• National or international associations and organisations</li> </ul>	
	<b>Data collected</b>	Energy supply and demand	
<b>Comments</b>	<b>Main challenges</b>	<ul style="list-style-type: none"> <li>• Time-consuming to gather data</li> <li>• Long time to establish a relationship with the organisations</li> </ul>	
	<b>Additional observations</b>		

\* See Annex F.

Background	Country	Italy	R/Ad/10
	Organisation	Institute of Studies for the Integration of Systems	
	Data collection purpose		
Data collection	Sources	<ul style="list-style-type: none"> <li>• Government statistics office</li> <li>• Energy utilities (gas, oil, electricity, other)</li> <li>• Manufacturers</li> <li>• National or international associations and organisations</li> <li>• Appliances manufacturers' technical literature, <i>e.g.</i> the EuP studies</li> <li>• Other models such as PRIMES and ADAMS</li> </ul>	
	Data collected	<ul style="list-style-type: none"> <li>• Demographic data</li> <li>• Technologies diffusion and unit consumption of appliances</li> <li>• Energy consumption for space heating, water heating and lighting</li> </ul>	
Comments	Main challenges	<ul style="list-style-type: none"> <li>• High cost to obtain data</li> <li>• Time-consuming to gather data</li> <li>• Many data points crossed off due to confidentiality of the sources</li> <li>• Needed to establish a Memorandum of Understanding with a given organisation</li> <li>• Definition issues within a sector</li> </ul>	
	Additional observations		

<b>Background</b>	<b>Country</b>	Korea	<b>R/Ad/11</b>
	<b>Organisation</b>	Korea National Oil Corporation	
	<b>Data collection purpose</b>	To establish national oil supply-and-demand statistics	
<b>Collection</b>	<b>Sources</b>	Manufacturers	
	<b>Data collected</b>	Imports, exports, sales, production, stocks of crude oil and final oil products.	
<b>Comments</b>	<b>Main challenges</b>	<ul style="list-style-type: none"> <li>• In paper format — difficult to transfer to digital format</li> <li>• Definition issues within a sector</li> </ul>	
	<b>Additional observations</b>		

<b>Background</b>	Country	Netherlands	<b>R/Ad/12</b>
	Organisation	Statistics Netherlands	
	Data collection purpose		
<b>Collection</b>	Sources	Energy utilities (gas, oil, electricity, other)	
	Data collected	Client information from energy companies. For each connection of gas and electricity (households and companies): annual purchased amount of gas and electricity (no breakdown by end use).	
<b>Comments</b>	Main challenges	<ul style="list-style-type: none"> <li>• Time-consuming to gather data</li> <li>• Long time to establish a relationship with the organisations</li> </ul>	
	Additional observations	Methodology is still being improved. Results published from 2006 onwards.	

<b>Background</b>	<b>Country</b>	New Zealand	<b>R/Ad/13</b>
	<b>Organisation</b>	Energy Efficiency and Conservation Authority	
	<b>Data collection purpose</b>	<ul style="list-style-type: none"> <li>• To monitor industry trends for policy analysis</li> <li>• To provide aggregate statistics for domestic and international reporting</li> <li>• To prepare energy-related greenhouse gas emissions inventory</li> <li>• To project supply and demand through modelling based on historical data</li> </ul>	
<b>Data collection</b>	<b>Sources</b>	<ul style="list-style-type: none"> <li>• Government statistics office</li> <li>• National or international associations and organisations</li> </ul>	
	<b>Data collected</b>	<ul style="list-style-type: none"> <li>• Coal sales survey</li> <li>• Deliveries of petroleum fuels by industry</li> <li>• Survey of gas-selling enterprises' wholesaling, retailing and sales information</li> <li>• Survey of electricity-retailing enterprises</li> </ul>	
<b>Comments</b>	<b>Main challenges</b>	<ul style="list-style-type: none"> <li>• Time-consuming to gather data</li> <li>• Many data points crossed off due to confidentiality of the sources</li> <li>• Definition issues within a sector</li> </ul>	
	<b>Additional observations</b>	Demand information on electricity, coal and gas for New Zealand is generally good	

		R/Ad/14
<b>Background</b>	Country	Spain
	Organisation	Institute for the Diversification and Saving of Energy
	Data collection purpose	<ul style="list-style-type: none"> <li>• To establish final energy consumption by fuel type in the residential sector</li> <li>• To determine dwelling unit energy consumption relative to average floor area of dwellings</li> <li>• To estimate consumption by energy sources and end uses</li> <li>• To determine energy intensity of the residential sector</li> </ul>
<b>Data collection</b>	Sources	<ul style="list-style-type: none"> <li>• Government statistics office</li> <li>• Ministry of Development/Ministry of Dwelling/Ministry of Economy and Finance/Ministry of Industry, Trade and Commerce (MITYC)</li> <li>• Energy utilities (gas, oil, electricity, other)</li> <li>• Manufacturers</li> </ul>
	Data collected	<ul style="list-style-type: none"> <li>• Spanish Statistics Office (INE): data on national accountability; ownership of appliances; annual construction of dwellings (m<sup>2</sup>), etc.</li> <li>• Associations of manufacturers: data on appliances sales, etc.</li> <li>• Eurostat: data on degree days</li> <li>• MITYC: data on energy balance (by sources and sectors)</li> </ul>
<b>Comments</b>	Main challenges	<ul style="list-style-type: none"> <li>• Time-consuming to gather data</li> <li>• In paper format — difficult to transfer to digital format</li> <li>• Definition issues within a sector</li> <li>• Shipment data from manufacturers did not have appliance specifications (e.g. size, unit energy consumption, model)</li> <li>• Interruption in the time series given by INE because some data are no longer available or because of a change in the methodology used</li> </ul>
	Additional observations	It is very important to integrate the traditional methods based on administrative data with other mix of methods, such as the bottom-up method

<b>Background</b>	<b>Country</b>	Togo	<b>R/Ad/15</b>
	<b>Organisation</b>	Ministry of Mines and Energy	
	<b>Data collection purpose</b>	To determine energy consumption in the residential sector	
<b>Collection</b>	<b>Sources</b>	<ul style="list-style-type: none"> <li>• Government statistics office</li> <li>• Energy utilities (gas, oil, electricity, other)</li> <li>• Manufacturers</li> <li>• National or international associations and organisations</li> </ul>	
	<b>Data collected</b>		
<b>Comments</b>	<b>Main challenges</b>		
	<b>Additional observations</b>	The information exists, but sometimes not in the desired format	



<b>Background</b>	Country	Ukraine	<b>R/Ad/16</b>
	Organisation	State Statistics Committee of Ukraine	
	Data collection purpose	To submit the International Energy Agency annual questionnaires	
<b>Data collection</b>	Sources	<ul style="list-style-type: none"> <li>• Government statistics office</li> <li>• Energy utilities (gas, oil, electricity, other)</li> <li>• Manufacturers</li> <li>• National Commission on Energy Regulation</li> <li>• National joint-stock company Oil and Gas of Ukraine</li> </ul>	
	Data collected		
<b>Comments</b>	Main challenges	<ul style="list-style-type: none"> <li>• In paper format — difficult to transfer to digital format</li> <li>• Needed agreement from house owners</li> <li>• Missing the full list of fuels used</li> </ul>	
	Additional observations		

<b>Background</b>	<b>Country</b>	United Kingdom	<b>R/Ad/17</b>
	<b>Organisation</b>	Department of Energy and Climate Change	
	<b>Data collection purpose</b>	<ul style="list-style-type: none"> <li>• To provide estimates of energy consumption for different households and to establish energy consumption drivers</li> <li>• To estimate the savings from energy efficiency measures adopted in households</li> </ul>	
<b>Data collection</b>	<b>Sources</b>	Energy utilities (gas, oil, electricity, other)	
	<b>Data collected</b>	The energy consumption data are from household electricity and gas meter point readings, provided by utility companies. Those data are matched with data on energy efficiency measures installed (from the Homes Energy Efficiency Database, which holds data provided by installers) and property attribute data held by the Valuation Office Agency (a UK government agency). Commercially available modelled data on household attributes are also matched to the data.	
<b>Comments</b>	<b>Main challenges</b>	<ul style="list-style-type: none"> <li>• Time-consuming to gather data</li> <li>• Needed to establish a Memorandum of Understanding with a given organisation</li> <li>• Data protection and data confidentiality have been two of the most significant challenges. These have led to access being limited and processes being more time-consuming. Reducing these challenges will require legislation in some cases.</li> </ul>	
	<b>Additional observations</b>	There are some rich sources of administrative data within the UK, but sharing the data is limited to specified purposes	

<b>Background</b>	Country	United Kingdom	<b>R/Ad/18</b>
	Organisation	Department of Energy and Climate Change	
	Data collection purpose	To produce data on total energy consumption by fuel type in the residential sector	
<b>Collection</b>	Sources	Energy utilities (gas, oil, electricity, other)	
	Data collected	Energy suppliers provide the amount of consumption of each energy source. Gas and electricity utilities are able to identify domestic users by the type of meters and tariffs. Estimates are provided for supplied liquid and solid fuels and renewable sources.	
<b>Comments</b>	Main challenges	<ul style="list-style-type: none"> <li>• Time-consuming to gather data</li> <li>• Difficulties exist in a few records having to distinguish residential sector energy consumption from services sector consumption (e.g. offices)</li> </ul>	
	Additional observations		

<b>Background</b>	<b>Country</b>	United States	<b>R/Ad/19</b>
	<b>Organisation</b>	Energy Information Administration	
	<b>Data collection purpose</b>	To estimate housing unit energy consumption and energy end uses supplemented with the model and the characteristics data	
<b>Collection</b>	<b>Sources</b>	Energy utilities (gas, oil, electricity, other)	
	<b>Data collected</b>	16 to 20 months of customer billing data for all major fuels, including consumption, expenditures, and for bulk fuels, amount delivered and receipts	
<b>Comments</b>	<b>Main challenges</b>	<ul style="list-style-type: none"> <li>• Data are collected in a separate phase after household survey, which adds both quality and time to overall project</li> <li>• Establishing rapport with and access to the right respondents in energy supplier companies</li> <li>• Managing and using data in non-standard data formats, keeping up with best practices for data capture in an ever-changing computing and business environment</li> </ul>	
	<b>Additional observations</b>	For major fuels, data are collected on fuel-specific survey instruments from energy suppliers to sampled households. Service areas of various energy suppliers cross geopolitical boundaries. Energy policy and rate structures are largely in the hands of states, which influences ease and quality of data capture.	

<b>Background</b>	Country	Albania	<b>R/Su/01</b>	
	Organisation	National Agency of Natural Resources		
	Name of the survey	Energy Consumption in Household		
	Survey purpose	<ul style="list-style-type: none"> <li>• To determine total residential energy consumption</li> <li>• To determine residential appliances energy consumption</li> <li>• To collect residential appliances diffusion</li> <li>• To collect household energy expenditure</li> <li>• To collect dwelling physical characteristics</li> </ul>		
<b>Data collection</b>	Sample design	Stratified random sampling approach		
	Sample sources	National census		
	Collection methods	In-house visit		
	Sample/Population size	1 000 / 700 000	Response rate	14%
	Frequency	No regular survey cycle		
	Time to complete survey	20 minutes	Mandatory	No
	Incentive			
	Survey respondents	Households		
	Elements collected	Dwelling type, dwelling floor area, building age, household occupancy, income, identification of main appliances, number of light fixtures, types of lighting, residential energy consumption		
End uses covered	Space cooling, space heating, water heating, lighting, freezers, washing machines, other small appliances			
<b>Comments</b>	Main challenges	Response quality		
	Possible improvements	The questionnaire should be simple with clear questions and instructions. Training of the interviewing staff is essential to ensure quality control of responses.		
	Key best practice			
	Other documentation	Available: survey questionnaire		

<b>Background</b>	Country	Austria		<b>R/Su/02</b>
	Organisation	Statistics Austria		
	Name of the survey	Residential energy consumption survey		
	Survey purpose	<ul style="list-style-type: none"> <li>• To determine total residential energy consumption</li> <li>• To determine residential appliances energy consumption</li> <li>• To collect household energy expenditure</li> <li>• To collect dwelling physical characteristics</li> <li>• To collect household occupant characteristics</li> </ul>		
<b>Data collection</b>	Sample design	Stratified random sampling approach		
	Sample sources	List of addresses, list of telephone numbers, labour force survey		
	Collection methods	<ul style="list-style-type: none"> <li>• Computer-assisted personal interview</li> <li>• Computer-assisted telephone interview</li> </ul>		
	Sample/Population size	14 000 / 3 429 720	Response rate	55%
	Frequency	Every two years		
	Time to complete survey	10 minutes	Mandatory	No
	Incentive	None		
	Survey respondents	Households		
	Elements collected	Dwelling type, dwelling floor area, building age, household occupancy, energy-related renovations, residential energy consumption and related expenditures		
End uses covered	Space cooling, space heating, water heating, other: cooking			
<b>Comments</b>	Main challenges	<ul style="list-style-type: none"> <li>• Inconsistent responses</li> <li>• Response quality</li> </ul>		
	Possible improvements			
	Key best practice	<p>A new approach to data control compared with previous surveys was taken for the first time in 2004 and continued in the follow-up survey runs. Up to and including the 2000 survey, only the individual energy sources themselves were checked for plausibility. Any missing data were calculated (quantity-value pairs) and substitutions were made if necessary. Such routines of course continue to be used, with the additional step that the total of the reported energy consumption is then related to a calculated (fictitious) overall consumption. This fictitious overall consumption by the household is calculated from the data for that household, on the one hand (floor space, number of people in household) and preset parameters for the individual types of use (space heating, water heating, cooking, other purposes), on the other hand. Calculating the total reported energy consumption per household in this way involves some quite complicated plausibility routines, because one or more alternative quantities have to be calculated if the quantity-value pairs do not match and these alternative quantities then, when variably applied, lead to a number of different calculated overall energy consumption figures. The fictitious standard value is then used to select the quantity-value pairs that appear most probable.</p>		
	Other documentation	Available: surveying methodology and questionnaire		

<b>Background</b>	Country	Belgium		<b>R/Su/03</b>
	Organisation	Vision on Technology		
	Name of the survey	Two yearly surveys on energy behaviour and energy awareness by the Flemish energy agency (Flemish region)		
	Survey purpose	<ul style="list-style-type: none"> <li>• To determine total residential energy consumption</li> <li>• To determine residential appliances energy consumption</li> <li>• To collect residential appliances diffusion</li> <li>• To collect dwelling physical characteristics</li> <li>• To collect household occupant characteristics</li> <li>• To complement another data collection/estimation effort</li> </ul>		
<b>Data collection</b>	Sample design	Stratified random sampling approach		
	Sample sources	National census, lists of addresses		
	Collection methods	<ul style="list-style-type: none"> <li>• Computer-assisted personal interview</li> <li>• In-house visit</li> </ul>		
	Sample/Population size	1 000 / 2 500 000	Response rate	Not available
	Frequency	Every two years		
	Time to complete survey	50 minutes	Mandatory	No
	Incentive	Non-cash incentives		
	Survey respondents	Households		
	Elements collected	Dwelling type, dwelling floor area, building age, household occupancy, income, identification of main appliances, number of light fixtures, types of lighting, energy-related renovations, renewable equipment, residential energy consumption		
End uses covered	Space heating, water heating, lighting, refrigerators, freezers, dishwashers, washing machines, clothes dryers, televisions, computers.			
<b>Comments</b>	Main challenges			
	Possible improvements			
	Key best practice			
	Other documentation	Available: surveying questionnaire		

<b>Background</b>	<b>Country</b>	Belgium, Bulgaria, Czech Republic, Denmark, France, Germany, Greece, Hungary, Italy, Norway, Portugal, Romania		<b>R/Su/04</b>
	<b>Organisation</b>	Institute of Systems and Robotics-University of Coimbra		
	<b>Name of the survey</b>	REMODECE		
	<b>Survey purpose</b>	<ul style="list-style-type: none"> <li>• To determine total residential energy consumption</li> <li>• To determine residential appliances energy consumption</li> <li>• To collect residential appliances diffusion</li> <li>• To collect dwelling physical characteristics</li> <li>• To collect household occupant characteristics</li> <li>• To complement another data collection/estimation effort</li> </ul>		
<b>Data collection</b>	<b>Sample design</b>	Stratified random sampling approach		
	<b>Sample sources</b>	Lists of addresses, lists of telephone numbers, national census, lists from energy suppliers		
	<b>Collection methods</b>	<ul style="list-style-type: none"> <li>• Paper form sent by mail</li> <li>• Internet based</li> <li>• Telephone interview</li> <li>• In-house visit</li> <li>• Direct email contacts, existing consumers panel in one country (Germany)</li> </ul>		
	<b>Sample size</b>	6 000 (500 per country)	<b>Response rate</b>	90%–95%
	<b>Frequency</b>	Once, no regular survey cycle		
	<b>Time to complete survey</b>	10 minutes to 40 minutes	<b>Mandatory</b>	No
	<b>Incentive</b>	Free audits, maintenance or other energy-related services or equipment, non-cash incentives such as gift coupons		
	<b>Survey respondents</b>	Households		
	<b>Elements collected</b>	Dwelling type, dwelling floor area, building age, household occupancy, income, identification of main appliances, number of light fixtures, types of lighting, residential energy consumption, information from energy bills, energy-related renovations, renewable equipment, behavioural issues and practices: washing temperatures, efficiency classes of appliances, eco-button, etc.		
<b>End uses covered</b>	Space cooling, space heating, water heating, lighting, refrigerators and freezers, dishwashers, washing machines, clothes dryers, televisions, computers, other			
<b>Comments</b>	<b>Main challenges</b>	<ul style="list-style-type: none"> <li>• Low response rate</li> <li>• Incomplete survey</li> <li>• Response quality</li> <li>• Bias from the interviewer</li> </ul>		
	<b>Possible improvements</b>	The quality of the interviewing staff is very important as well as the definition of the statistical sample. Using telephone lists would be better since it would improve the response rate.		
	<b>Key best practice</b>	A mix of techniques was used to collect the questionnaires: face-to-face interviews, telephone interviews, direct email contacts, mail, one existing panel in one country, etc. Using Internet-based survey lowers the cost. The data from the questionnaires can be fed directly into a database.		
	<b>Other documentation</b>	Available: reports, reference (De Almeida et al., 2011).		



<b>Background</b>	Country	Canada	<b>R/Su/05</b>	
	Organisation	Natural Resources Canada		
	Name of the survey	Survey of Household Energy Use (SHEU)		
	Survey purpose	<ul style="list-style-type: none"> <li>• To determine total residential energy consumption</li> <li>• To determine residential appliances energy consumption</li> <li>• To collect residential appliances diffusion</li> <li>• To collect household energy expenditure</li> <li>• To collect dwelling physical characteristics</li> <li>• To collect household occupant characteristics</li> </ul>		
<b>Data collection</b>	Sample design	Stratified random sampling approach		
	Sample sources	The respondents for the households and the environment survey (HES) were people from the area frame of the Canadian community health survey (CCHS) who were interviewed for the CCHS. The respondents were then surveyed for the telephone portion of the HES to get the SHEU.		
	Collection methods	Paper form sent by mail		
	Sample/Population size	21 690 / 12 932 350	Response rate	45%
	Frequency	No regular survey cycle		
	Time to complete survey	60 minutes	Mandatory	No
	Incentive	None		
	Survey respondents	Households, property managers/landlords		
	Elements collected	Dwelling type, dwelling floor area, building age, household occupancy, identification of main appliances, number of light fixtures, types of lighting, energy-related renovations, renewable equipment, residential energy consumption, information from energy bills, information from energy suppliers		
	End uses covered	Space cooling, space heating, water heating, lighting, refrigerators, freezers, dishwashers, washing machines, clothes dryers, televisions, computers, other small appliances: personal computers, computer printers, computer monitors, DVDs, VCRs, home theatre systems, video game consoles, telephones, water coolers		
<b>Comments</b>	Main challenges	<ul style="list-style-type: none"> <li>• Low response rate</li> <li>• Incomplete survey</li> <li>• Inconsistent responses</li> <li>• Response quality</li> </ul>		
	Possible improvements	Increased sample size and use of computer-assisted personal interview		
	Key best practice	For the 2007 SHEU, the survey included both low-rise and high-rise apartments to highlight the differences between households that live in low-rise apartments and that live in high-rise apartments.		
	Other documentation	Available: survey questionnaire		

		<b>R/Su/06</b>		
<b>Background</b>	Country	People's Republic of China (PRC)		
	Organisation	Tsinghua University and Ministry of Agriculture of PRC		
	Name of the survey	National rural residential buildings energy consumption survey		
	Survey purpose	<ul style="list-style-type: none"> <li>• To collect dwelling physical characteristics</li> <li>• To collect household occupant characteristics and occupant behaviour data</li> <li>• To collect household energy consumption data by type of fuels</li> </ul>		
<b>Data collection</b>	Sample design	Random sampling approach		
	Sample sources	Designated by the local government		
	Collection methods	Face-to-face survey (500 students and local government)		
	Sample	3 200 households	Response rate	100%
	Frequency	No regular survey cycle		
	Time to complete survey	40 minutes	Mandatory	No
	Incentive	None		
	Survey respondents	Households		
	Elements collected	Dwelling type, household occupancy, identification of main appliances, occupant behaviour, energy consumption by fuel		
End uses collected	Space heating, water heating, appliances, etc.			
<b>Comments</b>	Main challenges	Response quality, need for additional modelling work		
	Possible improvements	Educate the panellists by regularly repeating the surveys every two years		
	Key best practice			
	Other documentation			

<b>Background</b>	Country	People's Republic of China	<b>R/Su/07</b>	
	Organisation	Tsinghua University and China Council for International Cooperation on Environment and Development		
	Name of the survey	National urban residential buildings energy consumption survey		
	Survey purpose	<ul style="list-style-type: none"> <li>• To collect dwelling physical characteristics</li> <li>• To collect household occupant characteristics and occupant behaviour data</li> <li>• To collect household energy consumption data</li> </ul>		
<b>Data collection</b>	Sample design	Stratified random sampling approach		
	Sample sources	National census		
	Collection methods	Face-to-face survey, data from Electrical Bureau		
	Sample size	7 000 households (1 000 households per city)	Response rate	60%
	Frequency	No regular survey cycle		
	Time to complete survey	60 minutes	Mandatory	No
	Incentive	Non-cash incentives		
	Survey respondents	Households		
	Elements collected	Dwelling type, dwelling floor area, household occupancy, identification of main appliances, occupant behaviour, energy consumption by fuel		
End uses collected	Space cooling, space heating, water heating, appliances (refrigerators, freezers, washing machines, televisions, computers, etc.)			
<b>Comments</b>	Main challenges	Response quality, need for additional modelling work		
	Possible improvements	Educate the panellists by regularly repeating the surveys		
	Key best practice			
	Other documentation			

<b>Background</b>	Country	Croatia		<b>R/Su/08</b>
	Organisation	Croatian Bureau of Statistics		
	Name of the survey	Energy consumption of the household sector		
	Survey purpose	To establish statistical survey on final energy consumption according to the Eurostat-defined list of variables and modalities for calculating energy efficiency indicators		
<b>Data collection</b>	Sample design	Stratified random sampling approach		
	Sample sources	Census data		
	Collection methods	Computer-assisted personal interview		
	Sample/Population size	5 000 / 1 535 000	Response rate	Ongoing
	Frequency	Ongoing		
	Time to complete survey	25 minutes	Mandatory	No
	Incentive	None		
	Survey respondents	Households		
	Elements collected	Dwelling type, dwelling floor area, building age, household occupancy, energy-related renovations, household energy consumption and related expenditures		
End uses covered	Space cooling, space heating, water heating, cooking, air conditioning, lighting, appliances			
<b>Comments</b>	Main challenges	Response quality, collection of exact information on annual energy consumption of all energy forms		
	Possible improvements	Collection of metered energy consumption in households from distribution companies		
	Key best practice	Low response rate		
	Other documentation	Available on <a href="http://www.dzs.hr">www.dzs.hr</a>		

<b>Background</b>	Country	Croatia		<b>R/Su/09</b>
	Organisation	Energy Institute Hrvoje Pozar		
	Name of the survey	Survey on energy consumption in Split and Dalmatia County		
	Survey purpose	<ul style="list-style-type: none"> <li>• To determine total residential energy consumption</li> <li>• To determine residential appliances energy consumption</li> <li>• To collect residential appliances diffusion</li> <li>• To collect household energy expenditure</li> <li>• To collect dwelling physical characteristics</li> <li>• To collect household occupant characteristics</li> <li>• To complement another data collection/estimation effort</li> </ul>		
<b>Data collection</b>	Sample design	Stratified random sampling approach		
	Sample sources	National census, lists from energy suppliers		
	Collection methods	<ul style="list-style-type: none"> <li>• Telephone interview</li> <li>• In-house visit</li> </ul>		
	Sample/Population size	2 000 / 133 496	Response rate	75%
	Frequency	Every five years		
	Time to complete survey	25 minutes	Mandatory	No
	Incentive	None		
	Survey respondents	Households		
	Elements collected	Dwelling type, dwelling floor area, building age, household occupancy, income, identification of main appliances, number of light fixtures, types of lighting, energy-related renovations, renewable equipment, residential energy consumption, information from energy bills, information from energy suppliers, on-site energy audit, personal car utilisation characteristics (consumption in litres per 100 kilometres [L/100 km], distance, type of motor fuel)		
End uses covered	Space cooling, space heating, water heating, lighting, refrigerators, freezers, dishwashers, washing machines, clothes dryers, televisions, computers, other small appliances			
<b>Comments</b>	Main challenges	Incomplete survey		
	Possible improvements	Using market research company, repeating the survey		
	Key best practice	Households are split into 14 energy zones. All counties were analysed. Survey identified consumption of fuel wood. Developed software for the data storing and processing.		
	Other documentation	Not available		

		R/Su/10		
<b>Background</b>	Country	Croatia/Bosnia and Herzegovina		
	Organisation	Energy Institute Hrvoje Pozar		
	Name of the survey	Survey on energy consumption in Bosnia and Herzegovina		
	Survey purpose	<ul style="list-style-type: none"> <li>• To determine total residential energy consumption</li> <li>• To determine residential appliances energy consumption</li> <li>• To collect residential appliances diffusion</li> <li>• To collect household energy expenditure</li> <li>• To collect dwelling physical characteristics</li> <li>• To collect household occupant characteristics</li> </ul>		
<b>Data collection</b>	Sample design	Stratified random sampling approach		
	Sample sources	National census, lists from energy suppliers, lists of addresses, lists of telephone numbers		
	Collection methods	In-house visit		
	Sample/Population size	4 000 / 1 200 000	Response rate	60%
	Frequency	Only conducted once		
	Time to complete survey	25 minutes		
	Incentive			
	Survey respondents	Households		
	Elements collected	Dwelling type, dwelling floor area, building age, household occupancy, income, identification of main appliances, number of light fixtures, types of lighting, energy-related renovations, renewable equipment, residential energy consumption, information from energy bills, information from energy suppliers, on-site energy audit		
	End uses covered	Space cooling, space heating, water heating, lighting, refrigerators, freezers, dishwashers, washing machines, clothes dryers, televisions, computers, other small appliances		
<b>Comments</b>	Main challenges	Incomplete survey Quality of the interviewing staff		
	Possible improvements	Using educated market research company, repeating the survey		
	Key best practice	Survey was used to identify more precisely the number of inhabitants in Bosnia and Herzegovina. Households were split into 20 energy zones. Overall country was analysed. Survey identified consumption of fuel wood. Developed software for data storing and processing.		
	Other documentation	Available		

<b>Background</b>	Country	Czech Republic	<b>R/Su/11</b>	
	Organisation	Czech Statistics Office, Ministry of Industry and Trade		
	Name of the survey	ENERGO 2004		
	Survey purpose	<ul style="list-style-type: none"> <li>• To determine total residential energy consumption</li> <li>• To determine residential appliances energy consumption</li> <li>• To collect residential appliances diffusion</li> <li>• To collect household energy expenditure</li> <li>• To collect dwelling physical characteristics</li> </ul>		
<b>Data collection</b>	Sample design	Stratified random sampling approach		
	Sample sources	National census		
	Collection methods	In-house visit		
	Sample/Population size	40 000 / 4 000 000	Response rate	100%
	Frequency	No regular survey cycle		
	Time to complete survey	60 minutes	Mandatory	No
	Incentive	None		
	Survey respondents	Households		
	Elements collected	Dwelling type, dwelling floor area, building age, identification of main appliances, energy-related renovations, renewable equipment, residential energy consumption		
	End uses covered	Space heating, water heating, appliances		
<b>Comments</b>	Main challenges	Inconsistent responses Response quality		
	Possible improvements	A better manual for interviewing staff (e.g. identifying proper biomass volume through visual examples)		
	Key best practice	Cooperation among different government agencies. ENERGO 2004 survey was prepared and processed by the Czech Statistics Office. The Ministry of Industry and Trade participated in the recalculation of the results, mainly energy consumption of households (solid fuels). They used primary data from this survey for the IEA Energy Efficiency Indicators template.		
	Other documentation	Available: survey questionnaire and report		

		R/Su/12		
<b>Background</b>	Country	Denmark		
	Organisation	IT Energy		
	Name of the survey	The possession and use of electrical appliances at homes		
	Survey purpose	<ul style="list-style-type: none"> <li>• To determine total residential energy consumption</li> <li>• To determine residential appliances energy consumption</li> <li>• To collect residential appliances diffusion</li> <li>• To collect household energy expenditure</li> <li>• To collect dwelling physical characteristics</li> <li>• To collect household occupant characteristics</li> <li>• To collect data about the use patterns for major appliances</li> <li>• To collect data about disposal of appliances</li> </ul>		
<b>Data collection</b>	Sample design	Stratified random sampling approach		
	Sample sources	National census, lists of telephone numbers		
	Collection methods	<ul style="list-style-type: none"> <li>• Paper form sent by mail</li> <li>• Internet based</li> </ul>		
	Sample/Population size	5 300 / 2 450 000	Response rate	40%
	Frequency	Every two years		
	Time to complete survey	90 minutes	Mandatory	No
	Incentive	Cash or other monetary incentives to responders, non-cash incentives		
	Survey respondents	Households		
	Elements collected	Dwelling type, dwelling floor area, building age, household occupancy, income, identification of main appliances, number of light fixtures, types of lighting, energy-related renovations, renewable equipment, residential energy consumption		
	End uses covered	Space cooling, space heating, water heating, lighting, refrigerators, freezers, dishwashers, washing machines, clothes dryers, televisions, computers, other small appliances		
<b>Comments</b>	Main challenges	<ul style="list-style-type: none"> <li>• Inconsistent responses</li> <li>• Response quality</li> </ul>		
	Possible improvements	Further limit the response possibilities to only valid answers. Visit some of the household respondents, though this is expensive.		
	Key best practice	<ul style="list-style-type: none"> <li>• Design: all questions are reviewed every second year to ensure that they are still relevant and the wording is up to date. New appliances are considered, as well as other relevant new consumption questions. The questionnaire is then put out to tender. Together with the winning market bureau, the questionnaire is reviewed again, now mostly with regard to the web system they run.</li> <li>• Increase of response rate: a big effort was made to let the respondents know that their responses are important scientific contributions to the national statistics. Use of the Energy Authorities logo: this encourages more people to answer.</li> <li>• Data quality: limit answer ranges further, so only valid responses are presented (in web questionnaires), e.g. only the valid wattages for compact fluorescent light bulbs (CFLs) are shown when CFLs are in question etc.</li> <li>• Representativeness: the resulting pool of answers is scaled up to national level. This is done using a weight for each response. The weights are calculated on the basis of characteristics of the households (dwelling type, dwelling size, family size) compared with the national level.</li> <li>• Further processing: to catch errors the results are all compared with same results from last cycle.</li> </ul>		
	Other documentation	Available: survey questionnaire		



<b>Background</b>	Country	Germany	<b>R/Su/13</b>	
	Organisation	Rheinisch-Westfälisches Institut		
	Name of the survey	The German residential energy consumption survey (Erhebung des Energieverbrauchs der privaten Haushalte)		
	Survey purpose	<ul style="list-style-type: none"> <li>• To determine total residential energy consumption</li> <li>• To determine residential appliances energy consumption</li> <li>• To collect residential appliances diffusion</li> <li>• To collect household energy expenditure</li> <li>• To collect dwelling physical characteristics</li> <li>• To collect household occupant characteristics</li> </ul>		
<b>Data collection</b>	Sample design	Stratified random sampling approach		
	Sample sources			
	Collection methods	<ul style="list-style-type: none"> <li>• Internet based</li> <li>• Computer-assisted telephone interview</li> <li>• Sampled households are equipped with an electronic set-top box connected to the television via which they can provide responses to the survey</li> </ul>		
	Sample/Population size	6 715 / 40 076 000	Response rate	70%
	Frequency	Every three years		
	Time to complete survey	30 minutes	Mandatory	No
	Incentive	None		
	Survey respondents	Households		
	Elements collected	Dwelling type, dwelling floor area, building age, household occupancy, income, identification of main appliances, energy-related renovations, renewable equipment, residential energy consumption, information from energy bills		
	End uses covered	Space heating, water heating, refrigerators, freezers, dishwashers, washing machines, clothes dryers, televisions, computers, other		
<b>Comments</b>	Main challenges	<ul style="list-style-type: none"> <li>• Breakdown of consumption figures into consumption purposes</li> <li>• Renters are often not well informed about the building's characteristics</li> <li>• Treatment of storable fuels</li> <li>• Billing period does not correspond to surveying year coverage</li> </ul>		
	Possible improvements	Sample of in-home visits		
	Key best practice	Heating bills are often complex in Germany. The project thus developed a tool where the households can select their billing operator, and it subsequently displays sample bills with the figures of interest marked. People do not need to understand their bills but just report the relevant figures.		
	Other documentation	Available: surveying questionnaire and report		

<b>Background</b>	<b>Country</b>	Hong Kong, China		<b>R/Su/14</b>
	<b>Organisation</b>	Electrical and Mechanical Services Department		
	<b>Name of the survey</b>	Energy Consumption Survey on Residential Sector		
	<b>Survey purpose</b>	<ul style="list-style-type: none"> <li>• To determine total residential energy consumption</li> <li>• To determine residential appliances energy consumption</li> <li>• To collect residential appliances diffusion</li> <li>• To collect household energy expenditure</li> <li>• To collect dwelling physical characteristics</li> <li>• To collect household occupant characteristics</li> </ul>		
	<b>Sample design</b>	Stratified random sampling approach		
<b>Data collection</b>	<b>Sample sources</b>	National census		
	<b>Collection methods</b>	In-house visit		
	<b>Sample/Population size</b>	2 100 / 2 000 000	<b>Response rate</b>	Almost 100%
	<b>Frequency</b>	Every three years		
	<b>Time to complete survey</b>	45 minutes	<b>Mandatory</b>	No
	<b>Incentive</b>	None		
	<b>Survey respondents</b>	Households		
	<b>Elements collected</b>	Dwelling type, dwelling floor area, building age, household occupancy, income, number of light fixtures, types of lighting, residential energy consumption, information from energy bills, operating behaviour of appliances, rating of appliances		
<b>End uses covered</b>	Space cooling, water heating, lighting, refrigerators, washing machines, televisions, computers, other small appliances			
<b>Comments</b>	<b>Main challenges</b>	<ul style="list-style-type: none"> <li>• Quality of the interviewing staff</li> <li>• Recruiting, training and retaining project staff</li> </ul>		
	<b>Possible improvements</b>	Recruit experienced interviewers, organise training, conduct pilot survey, refine questionnaire, establish hotline with supervisor to provide assistance		
	<b>Key best practice</b>	A novel approach was devised to boost the response rate. Instead of one single sample being selected, each "single" sample is supplemented with two neighbouring samples (e.g. units one floor above and below the selected sample). In the event the selected sample fails or rejects, another sample with similar energy consumption characteristics can be used as supplement. The response rate can be close to 100% without seriously distorting the characteristics of the samples.		
	<b>Other documentation</b>	Available: survey report		

<b>Background</b>	Country	Indonesia	<b>R/Su/15</b>	
	Organisation	Data and Information Centre, Ministry of Energy and Mineral Resources		
	Name of the survey	Residential survey for poor households		
	Survey purpose	<ul style="list-style-type: none"> <li>• To determine total residential energy consumption</li> <li>• To determine residential appliances energy consumption</li> <li>• To collect household energy expenditure</li> <li>• To collect household occupant characteristics</li> </ul>		
<b>Data collection</b>	Sample design	Stratified random sampling approach		
	Sample sources	National census, list of households		
	Collection methods	In-house visit		
	Sample/Population size	Not available		
	Frequency	No regular survey cycle		
	Time to complete survey	30 minutes	Mandatory	No
	Incentive	Non-cash incentives		
	Survey respondents	Households		
	Elements collected	Household occupancy, income, identification of main appliances, number of light fixtures, residential energy consumption, information from energy bills		
End uses covered	Lighting, refrigerators, washing machines, televisions, cooking, other			
<b>Comments</b>	Main challenges	<ul style="list-style-type: none"> <li>• Incomplete survey</li> <li>• Bias of the interviewer</li> <li>• Quality of the interviewing staff</li> <li>• Recruiting, training and retaining project staff</li> <li>• Willingness of household participation</li> </ul>		
	Possible improvements	The questionnaire should be designed in a simple format. The hired interviewers should be familiar with energy concepts.		
	Key best practice	One of the key challenges is to find households willing to participate in the survey. To overcome this challenge, the surveying team needs to approach the chairman of the community to request permission and to obtain support during the household surveying exercise. Generally, the community will nominate a representative to accompany the surveying team.		
	Other documentation	Available: surveying questionnaire		

<b>Background</b>	<b>Country</b>	Italy		<b>R/Su/16</b>
	<b>Organisation</b>	Ricerca sul Sistema Energetico		
	<b>Name of the survey</b>			
	<b>Survey purpose</b>	<ul style="list-style-type: none"> <li>• To collect residential appliances diffusion</li> <li>• To collect dwelling physical characteristics</li> <li>• To collect household occupant characteristics</li> <li>• To collect appliances usage pattern</li> <li>• To complement another data collection/estimation, standard annual consumption per appliance</li> </ul>		
<b>Data collection</b>	<b>Sample design</b>	Stratified random sampling approach		
	<b>Sample sources</b>	National census		
	<b>Collection methods</b>	Specific interview panel connected to data collection centre via global system for mobile communications		
	<b>Sample/Population size</b>	1 500 / 22 000 000	<b>Response rate</b>	100%
	<b>Frequency</b>	No regular survey cycle		
	<b>Time to complete survey</b>	5 minutes	<b>Mandatory</b>	No
	<b>Incentive</b>	Non-cash incentives		
	<b>Survey respondents</b>	Households		
	<b>Elements collected</b>	Dwelling type, dwelling floor area, household occupancy, identification of main appliances, number of light fixtures, types of lighting, residential energy consumption		
	<b>End uses covered</b>	Space cooling, space heating, water heating, lighting, refrigerators, freezers, dishwashers, washing machines, clothes dryers, televisions, computers, other small appliances: VCR/DVDs, printers, hi-fis, set-top boxes, modems, game consoles, irons, vacuum cleaners, clocks, alarm sets, cordless phones		
<b>Comments</b>	<b>Main challenges</b>	Response quality		
	<b>Possible improvements</b>	Educate the panellists by regularly repeating the surveys		
	<b>Key best practice</b>	At the time of the preparation of this Manual, the survey was still under way and it was too early to draw conclusions. However, the technology adopted to contact the families can be considered very innovative.		
	<b>Other documentation</b>	Not available		

<b>Background</b>	Country	Korea		<b>R/Su/17</b>
	Organisation	Korea Energy Management Corporation		
	Name of the survey	National Energy and GHG Emissions Survey		
	Survey purpose	<ul style="list-style-type: none"> <li>• To determine total residential energy consumption</li> <li>• To determine residential appliances energy consumption</li> <li>• To collect household occupant characteristics</li> </ul>		
<b>Data collection</b>	Sample design	Stratified random sampling approach		
	Sample sources	National census		
	Collection methods	In-house visit		
	Sample/Population size	67 567 / 15 988 274	Response rate	90%
	Frequency	Every three years		
	Time to complete survey	20 minutes	Mandatory	No
	Incentive	Non-cash incentives		
	Survey respondents	Households		
	Elements collected	Dwelling type, dwelling floor area, household occupancy, income, identification of main appliances, number of light fixtures, types of lighting, energy-related renovations, renewable equipment, residential energy consumption, information from energy bills		
End uses covered	Space heating, water heating, lighting, appliances			
<b>Comments</b>	Main challenges	Response quality		
	Possible improvements			
	Key best practice			
	Other documentation	Available: surveying questionnaire		

		R/Su/18		
<b>Background</b>	Country	Norway		
	Organisation	Statistics Norway		
	Name of the survey	Energy consumption per household		
	Survey purpose	<ul style="list-style-type: none"> <li>• To determine total residential energy consumption</li> <li>• To determine residential appliances energy consumption</li> <li>• To collect household energy expenditure</li> <li>• To collect dwelling physical characteristics</li> <li>• To collect household occupant characteristics</li> </ul>		
<b>Data collection</b>	Sample design	Stratified random sampling approach		
	Sample sources	National census		
	Collection methods	Computer-assisted personal interview		
	Sample/Population size	7 000 / 2 200 000	Response rate	52%
	Frequency	Every three years		
	Time to complete survey	12 minutes for the energy portion	Mandatory	No
	Incentive	Cash or other monetary incentives to responders		
	Survey respondents	Households		
	Elements collected	Dwelling type, dwelling floor area, building age, household occupancy, identification of main appliances, energy-related renovations, residential energy consumption, information from energy bills, information from energy suppliers		
End uses covered				
<b>Comments</b>	Main challenges	<ul style="list-style-type: none"> <li>• Low response rate</li> <li>• Response quality</li> </ul>		
	Possible improvements	The response rate is about 50%. Different approaches have been used to improve the response rate, but it has been challenging to improve it beyond 50%. This has to be taken into account when selecting the gross sample. The response quality is good. It appears that errors are due to household respondents not remembering (or not being able to extract the information) of exact purchases in the last 12 months.		
	Key best practice	The households receive about €38 to participate in the survey.		
	Other documentation	Available: surveying report and questionnaire		

<b>Background</b>	Country	Romania	<b>R/Su/19</b>	
	Organisation	National Institute of Statistics		
	Name of the survey	Energy Consumption in Households		
	Survey purpose	<ul style="list-style-type: none"> <li>• To determine total residential energy consumption</li> <li>• To determine residential appliances energy consumption</li> <li>• To collect dwelling physical characteristics</li> </ul>		
<b>Data collection</b>	Sample design	Stratified random sampling approach		
	Sample sources	National census		
	Collection methods	In-house visit		
	Sample/Population size	10 920 / 7 359 000	Response rate	88%
	Frequency	No regular survey cycle		
	Time to complete survey	120 minutes	Mandatory	No
	Incentive	Free audits, maintenance or other energy-related services or equipment.		
	Survey respondents	Households		
	Elements collected	Dwelling type, dwelling floor area, building age, household occupancy, identification of main appliances, number of light fixtures, types of lighting, energy-related renovations, residential energy consumption, information from energy bills		
End uses covered	Space heating, water heating, lighting, appliances			
<b>Comments</b>	Main challenges	<ul style="list-style-type: none"> <li>• Inconsistent responses</li> <li>• Response quality</li> <li>• Quality of the interviewing staff</li> </ul>		
	Possible improvements			
	Key best practice			
	Other documentation	Available: surveying questionnaire		

	Country	Spain		R/Su/20
	Organisation	Institute for the Diversification and Saving of Energy		
Background	Name of the survey			
	Survey purpose	<ul style="list-style-type: none"> <li>• To determine total residential energy consumption</li> <li>• To determine residential appliances energy consumption</li> <li>• To collect residential appliances diffusion</li> <li>• To collect household energy expenditure</li> <li>• To collect dwelling physical characteristics</li> <li>• To collect household occupant characteristics</li> <li>• To complement another data collection/estimation effort</li> <li>• To determine the influence of the climate in the consumption of the sector</li> <li>• To determine the influence of the type of habitat in the consumption of the sector</li> </ul>		
Data collection	Sample design	Stratified random sampling approach		
	Sample sources	Lists of telephone numbers; for <i>in situ</i> survey, a panel of homes is used		
	Collection methods	<ul style="list-style-type: none"> <li>• Computer-assisted personal interview</li> <li>• Telephone interview</li> <li>• In-house visit</li> </ul>		
	Sample size	6 390		
	Frequency	Every three years		
	Time to complete survey	12 minutes	Mandatory	No
	Incentive	None		
	Survey respondents	Households		
	Elements collected	Dwelling type, dwelling floor area, building age, household occupancy, income, identification of main appliances, number of light fixtures, types of lighting, energy-related renovations, renewable equipment, residential energy consumption, information from energy bills. In addition, some aspects related to energy consumption habits are evaluated.		
	End uses covered	Space cooling, space heating, water heating, lighting, refrigerators, freezers, dishwashers, washing machines, clothes dryers, televisions, computers, other small appliances		
Comments	Main challenges	<ul style="list-style-type: none"> <li>• Low response rate</li> <li>• Incomplete survey</li> <li>• Inconsistent responses</li> <li>• Response quality</li> <li>• Recruiting, training and retaining project staff</li> </ul>		
	Possible improvements	Better training of the staff dedicated to the execution of the surveys, a better control system which covers a pilot pretest to check the questionnaires and the development of all the processes, in order to guarantee a high rate of responses, as well as a reasonable consistency of the responses		
	Key best practice	<p><b>In situ survey:</b> giving incentives for the collaboration of the households; organising the results in different life segments and styles; each panel to pretest to validate the questionnaire; quality control covering the field research and the data processing</p> <p><b>Telephone survey:</b> collaboration with companies, expert on telephone surveys; training of the interviewers; powerful computer-assisted telephone interview surveys management system</p> <p><b>Quality control:</b> pretest to validate the questionnaire; additional supervision of some selected surveys; data editing procedure; incorporation of a control variable to check the quality and confidence of the surveys</p>		
		Other documentation		



		R/Su/21		
<b>Background</b>	Country	Sweden		
	Organisation	Swedish Energy Agency		
	Name of the survey	Energy statistics for one- and two-dwelling buildings		
	Survey purpose	<ul style="list-style-type: none"> <li>• To determine total residential energy consumption</li> <li>• To determine residential appliances energy consumption</li> <li>• To collect dwelling physical characteristics</li> <li>• To collect household occupant characteristics</li> </ul>		
<b>Data collection</b>	Sample design	Stratified random sampling approach		
	Sample sources	List of addresses, other source: list from tax agency		
	Collection methods	<ul style="list-style-type: none"> <li>• Paper form sent by mail</li> <li>• Internet based</li> </ul>		
	Sample/Population size	6 800 / 1 800 000	Response rate	60%
	Frequency	Every year		
	Time to complete survey	Not available	Mandatory	No
	Incentive	None		
	Survey respondents	Households		
	Elements collected	Dwelling type, dwelling floor area, building age, household occupancy, energy-related renovations, renewable equipment, residential energy consumption		
	End uses covered	Space cooling, space heating, water heating, appliances		
<b>Comments</b>	Main challenges	<ul style="list-style-type: none"> <li>• Low response rate</li> <li>• Incomplete survey</li> <li>• Inconsistent responses</li> <li>• Recruiting, training and retaining project staff</li> </ul>		
	Possible improvements			
	Key best practice			
	Other documentation	Available: surveying questionnaire		

<b>Background</b>	Country	Thailand		<b>R/Su/22</b>
	Organisation	Department of Alternative Energy Development and Efficiency		
	Name of the survey	Households Consumption		
	Survey purpose	To collect residential energy consumption and expenditure		
<b>Data collection</b>	Sample design	Stratified random sampling approach		
	Sample sources	National census, lists from energy suppliers, lists of addresses		
	Collection methods	<ul style="list-style-type: none"> <li>• Computer-assisted personal interview</li> <li>• In-house visit</li> </ul>		
	Sample/Population size	1 710 036 / 5 700 123	Response rate	50%
	Frequency	Every two years		
	Time to complete survey	30 minutes	Mandatory	No
	Incentive	None		
	Survey respondents	Households		
	Elements collected	Dwelling type, dwelling floor area, building age, household occupancy, income, identification of main appliances, number of light fixtures, types of lighting, energy-related renovations, renewable equipment, residential energy consumption, information from energy bills, information from energy suppliers, on-site energy audit		
	End uses covered	Space cooling, water heating, lighting, refrigerators, freezers, dishwashers, washing machines, televisions, computers, other small appliances		
<b>Comments</b>	Main challenges	<ul style="list-style-type: none"> <li>• Low response rate</li> <li>• Incomplete survey</li> <li>• Response quality</li> <li>• Bias from the interviewer</li> </ul>		
	Possible improvements			
	Key best practice	Training of interviewers		
	Other documentation	Not available		

<b>Background</b>	Country	Togo		R/Su/23
	Organisation	Ministry of Mines and Energy		
	Name of the survey	Questionnaire d'enquete consommation		
	Survey purpose	<ul style="list-style-type: none"> <li>• To determine total residential energy consumption</li> <li>• To determine residential appliances energy consumption</li> <li>• To collect household energy expenditure</li> <li>• To collect dwelling physical characteristics</li> <li>• To collect household occupant characteristics</li> </ul>		
<b>Data collection</b>	Sample design	Equal probability of selection		
	Sample sources	National census		
	Collection methods	In-house visit		
	Sample/Population size	2 500 / 1 067 400	Response rate	100%
	Frequency	No regular survey cycle		
	Time to complete survey	15 minutes	Mandatory	No
	Incentive	None		
	Survey respondents	Households		
	Elements collected	Dwelling type, household occupancy, income, identification of main appliances, number of light fixtures, residential energy consumption, information from energy suppliers, on-site energy audit		
End uses covered	Water heating, lighting, cooking, refrigerators, freezers, televisions, computers, other			
<b>Comments</b>	Main challenges	<ul style="list-style-type: none"> <li>• Incomplete survey</li> <li>• Recruiting, training and retaining project staff</li> </ul>		
	Possible improvements	Conduct the survey every two or three years		
	Key best practice	The survey is conducted during two seasons (rainy and dry). The survey staff used a scale to measure the quantity of charcoal and wood used in households.		
	Other documentation	Not available		

<b>Background</b>	Country	United Kingdom		<b>R/Su/24</b>
	Organisation	Department of Energy and Climate Change		
	Name of the survey	English Housing Survey		
	Survey purpose	<ul style="list-style-type: none"> <li>• To collect dwelling physical characteristics</li> <li>• To complement another data collection/estimation effort</li> </ul>		
<b>Data collection</b>	Sample design	Stratified random sampling approach		
	Sample sources	List of addresses		
	Collection methods	<ul style="list-style-type: none"> <li>• Computer-assisted personal interview</li> <li>• In-house visit: physical survey carried out by a technical surveyor</li> </ul>		
	Sample/Population size	16 000 / 22 000 000	Response rate	Not available
	Frequency	Every year		
	Time to complete survey	Not available	Mandatory	No
	Incentive	None		
	Survey respondents	Households		
	Elements collected	Dwelling type, dwelling floor area, building age, household occupancy, income, identification of main appliances, number of light fixtures, energy-related renovations, residential energy consumption, on-site energy audit		
End uses covered				
<b>Comments</b>	Main challenges	Recruiting, training and retaining project staff		
	Possible improvements			
	Key best practice			
	Other documentation	Available: surveying questionnaire and report		

<b>Background</b>	Country	United States	<b>R/Su/25</b>	
	Organisation	Energy Information Administration		
	Name of the survey	Residential Energy Consumption Survey		
	Survey purpose	<ul style="list-style-type: none"> <li>• To determine total residential energy consumption</li> <li>• To determine residential appliances energy consumption</li> <li>• To collect residential appliances diffusion</li> <li>• To collect household energy expenditure</li> <li>• To collect dwelling physical characteristics</li> <li>• To collect household occupant characteristics</li> </ul>		
<b>Data collection</b>	Sample design	Area-probability sample survey		
	Sample sources	List of addresses		
	Collection methods	<ul style="list-style-type: none"> <li>• Computer-assisted personal interview</li> <li>• In-house visit</li> <li>• Telephone interview for many of the rental agent surveys</li> <li>• Combination of a paper form and an Internet-based survey for the supplier survey</li> </ul>		
	Sample/Population size	15 300 / 113 616 229	Response rate	79%
	Frequency	Every four years		
	Time to complete survey	50 minutes	Mandatory	No
	Incentive	Cash or other monetary incentives to responders, energy brochures, information about low-income home energy assistance programmes, magnets with survey logo		
	Survey respondents	Households, rental agents for housing units sampled where rent includes energy costs		
	Elements collected	Dwelling type, dwelling floor area, building age, household occupancy, income, identification of main appliances, number of light fixtures, types of lighting, energy-related renovations, renewable equipment, energy bills to administer follow-up survey with energy suppliers, names of energy suppliers of sampled households, eligibility criteria for low-income energy assistance programmes, Energy Star features on appliances		
	End uses covered	Space heating, water heating, space cooling, lighting, appliances		
<b>Comments</b>	Main challenges	<ul style="list-style-type: none"> <li>• Maintaining a high response rate</li> <li>• Quality of householder self-reported answers</li> <li>• Quality of the interviewing staff</li> <li>• Survey conducted under contract and without full control</li> </ul>		
	Possible improvements	Adding an energy audit element to validate, improve or replace respondent answers on fuel sources, energy equipment characteristics, or other more technical information. Redesigning repetitive series to reduce interview time, improving accuracy of behavioural frequency questions.		
	Key best practice	Systematic quality control procedures and IT processes from instrument design and data review to statistical estimation. This reduces errors where they occur, whether in CAPI, data processing or tabulation. Utility bills were also scanned by interviewers using portable scanners.		
	Other documentation	Available: surveying questionnaire		

<b>Background</b>	Country	Austria	<b>R/Me/01</b>
	Organisation	Statistics Austria	
	Name of the project	Household Electricity Consumption by Purpose	
	Project purpose	<ul style="list-style-type: none"> <li>• Physical characteristics by mode (e.g. weight, life cycle)</li> <li>• To understand residential energy consumption patterns</li> <li>• To understand appliance utilisation patterns</li> <li>• To complement an existing survey</li> <li>• To complement a model</li> </ul>	
<b>Data collection</b>	Sample design	Simple random sampling	
	Sample sources	Respondents of labour force survey were asked to join the exercise	
	Equipment used	Electricity cost meter	
	Sample size	254	
	Frequency	No regular cycle	
	Time to collect measurements	26 weeks per household	
	Who took measurements	Household occupants	
	End uses measured	Space heating, space cooling, water heating, refrigerators, freezers, dishwashers, washing machines, clothes dryers, televisions, radios/portable devices, clock radios, hi-fis/stereos, TV projectors, DVB-T set top box, satellite receivers, antenna amplifiers/digital antennae, VCR/DVD recorders, DVD players, cd players, consoles (e.g. PlayStations), waterbeds, aquariums — measure the complete system, including lights, hairdryers, espresso/coffee dispensers	
Geo-climatic measurements	Yes		
<b>Comments</b>	Main challenges	Communication with household occupants	
	Recommendations		
	Key best practice	The voluntary survey covers the consumption of electricity in private households, broken down by consumption purpose. With four questionnaires, the households recorded data about their electrical appliances (equipment, power consumption and usage) as well as data on space heating, water heating and lighting all linked to power consumption over 24-hour periods in two one-week runs. A portable energy cost meter was given to the contributing households to measure the specific electrical consumption, and an allowance of €100 was paid to every household that completed all the questionnaires.	
	Other documentation	Available: metering documentation	

<b>Background</b>	Country	Belgium, Bulgaria, Czech Republic, Denmark, France, Germany, Greece, Hungary, Italy, Norway, Portugal, Romania	<b>R/Me/02</b>
	Organisation	Intelligent Energy Europe	
	Name of the project	REMODECE	
	Project purpose	<ul style="list-style-type: none"> <li>• To understand appliance utilisation patterns</li> <li>• To understand residential energy consumption patterns</li> </ul>	
<b>Data collection</b>	Sample design	Simple random sampling	
	Sample sources	Lists from energy suppliers, lists of addresses, lists of telephone numbers, volunteers (after announcement in radio) and co-workers with air-conditioning equipment.	
	Equipment used	Power detective, electricity household meter, SEM 10, Enertech lamp meter logger, Sparo Meter NZR230, Enertech Wattmeter, DIACE System	
	Sample size	1 300 (100 households per country)	
	Frequency	No regular cycle (Norway - every year)	
	Time to collect measurements	5 to 20 days per household	
	Who took measurements	Energy auditors (household owners in Norway)	
	End uses measured	Space heating, space cooling, water heating, refrigerators, freezers, dishwashers, washing machines, clothes dryers, televisions, computers, other	
Geo-climatic measurements	Yes		
<b>Comments</b>	Main challenges	<ul style="list-style-type: none"> <li>• Equipment setup difficulties</li> <li>• Quality control</li> <li>• Malfunctioning equipment</li> <li>• Insufficient number of devices</li> <li>• Legal constraints in some countries</li> <li>• Monitoring takes longer than foreseen</li> </ul>	
	Recommendations	Difficulties in installing on-site metering devices should be considered. Care while installing the devices, and regular checks (every night if possible) to verify the data collection reliability and to avoid repetition of the measurements. Calibration of data to typical national energy demand of a household is important. Both end uses and total demand should be calibrated. For Norway and northern countries, having much electric heating, it is important to know the outdoor temperature for each day of the metered period of total energy demand. A regression analysis of temperature against metered demand gives the temperature sensitivities of the total energy demand. The regression analysis leaves data that are typical for classes of households such as detached houses and row houses. Stratified random sampling methods should be used when collecting and analysing the data. For lighting, too expensive metering devices were used — on/off detecting equipment is much less costly.	
	Key best practice	A tool was developed for the purpose of analysing the metered data. The data were stored with one-minute intervals for each appliance of each household. By analysing the appliance data and combining with survey data on a number of appliances, a typical appliance load-demand curve was established on a hourly basis. The energy demand of heating and cooling end uses was calculated as the residual from total energy demand subtracting all end-use demand.	
	Other documentation	Available: metering report	

<b>Background</b>	Country	Denmark	<b>R/Me/03</b>
	Organisation	IT Energy	
	Name of the project	SELINA (Intelligent Energy Europe project)	
	Project purpose	To measure standby power consumption of appliances being sold	
<b>Data collection</b>	Sample design	The appliances were not measured in homes, but in stores	
	Sample sources	Shops were the target, so all major shops selling electrical appliances participated. About 500 measurements were conducted by 12 participating countries in the project, resulting in more than 6 000 measurements for standby power.	
	Equipment used	WATTMAN from ADPOWER	
	Sample size	6 000	
	Frequency	No regular cycle	
	Time to collect measurements	Three days per store (10 weeks for total measurements)	
	Who took measurements	Energy auditors	
	End uses measured	Dishwashers, washing machines, clothes dryers, televisions, computers, other	
Geo-climatic measurements	No		
<b>Comments</b>	Main challenges	Selected shops did not allow for measurements	
	Recommendations	To keep the data processing simple and as flawless as possible, instead of typing in results, use a macro to get measurement data from meters to spreadsheet directly	
	Key best practice	A time-saving practice was established to go to the stores a day before the actual measurements were conducted to list all appliances that should be measured the following day	
	Other documentation	Not available	



<b>Background</b>	Country	New Zealand	<b>R/Me/04</b>
	Organisation	Energy Efficiency Conservation Authority	
	Name of the project	Household Energy End-Use Project	
	Project purpose	<ul style="list-style-type: none"> <li>• To understand residential energy consumption patterns</li> <li>• To understand appliance utilisation patterns</li> <li>• To develop a model of the residential energy sector</li> <li>• To help improve energy efficiency</li> <li>• To reduce GHG emissions</li> <li>• To identify new energy-saving opportunities</li> </ul>	
<b>Data collection</b>	Sample design	Random sampling approach	
	Sample sources	List of addresses	
	Equipment used		
	Sample size	400 households	
	Frequency	Only conducted once	
	Time to collect measurements	Five to six years for all households	
	Who took measurements	Household owners	
	End uses measured	Space heating, space cooling, water heating, refrigerators, freezers, dishwashers, washing machines, clothes dryers, televisions, computers, other	
Geo-climatic measurements			
<b>Comments</b>	Main challenges	A very small proportion (almost negligible) of the appliances in the study failed to operate during the six-year life span of the project	
	Recommendations	The metering could be improved with better metering equipment, which in turn would improve quality of results and lower the cost of the metering exercise	
	Key best practice	Metering was used to obtain energy consumption from major end uses	
	Other documentation	Available: metering report	

<b>Background</b>	Country	Spain	<b>R/Me/05</b>
	Organisation	Instituto para la Diversificación y Ahorro de la Energía	
	Name of the project	Energy Consumption in the Spanish Households Project	
	Project purpose	<ul style="list-style-type: none"> <li>• To understand residential energy consumption patterns</li> <li>• To understand appliance utilisation patterns</li> </ul>	
<b>Data collection</b>	Sample design	Equal probability of selection, according to certain characteristics. The selection is based on definitions of a typical dwelling corresponding to six sample spaces, divided by type of climatic area (Mediterranean, Continental, Atlantic) and type of dwelling (house, apartment).	
	Sample sources	List of addresses	
	Equipment used	One piece of equipment measuring the real consumption (Watt-hours) by each household appliance. Another piece of equipment recording the hourly consumption of the dwelling.	
	Sample size	600 households	
	Frequency	Every three years	
	Time to collect measurements	Four days per household	
	Who took measurements	Energy auditors	
	End uses measured	Space heating, space cooling, water heating, refrigerators, freezers, dishwashers, washing machines, clothes dryers, televisions, computers, other.	
Geo-climatic measurements	Yes		
<b>Comments</b>	Main challenges	<ul style="list-style-type: none"> <li>• Quality control</li> <li>• Malfunctioning equipment</li> <li>• Communication with household occupants</li> <li>• Access to some of the household equipment</li> </ul>	
	Recommendations	It is important to develop bottom-up methods based on <i>in situ</i> measurements	
	Key best practice	An informative campaign was launched ahead of field measurements in order to guarantee access to the dwellings. Established agreements with associations and organisations related to the energy sector such as citizens, universities, energy utilities, cities, and towns. Provision of incentives such as free energy studies about energy-saving tips. Preliminary diagnosis of 5% of the sample dwellings in order to estimate their energy consumption can be used as a reference to check the quality of the measurements in the rest of the dwellings.	
	Other documentation		

<b>Background</b>	Country	Sweden	<b>R/Me/06</b>
	Organisation	Swedish Energy Agency	
	Name of the project	Metering of Household Electricity Use in 400 Households	
	Project purpose	<ul style="list-style-type: none"> <li>• To understand residential energy consumption patterns</li> <li>• To complement an existing survey</li> <li>• To understand diffusion of different types of equipment</li> <li>• To measure electricity use by type of equipment/end use (e.g. lighting, ventilation, white goods, TVs, computers, etc.)</li> <li>• To complement energy statistics for one- and two-dwelling buildings</li> </ul>	
<b>Data collection</b>	Sample design	Stratified random sampling approach	
	Sample sources	List of addresses	
	Equipment used		
	Sample size	400	
	Frequency	Only conducted once	
	Time to collect measurements	Half a day per household (100 weeks for all households)	
	Who took measurements	Energy auditors	
	End uses measured	Refrigerators, freezers, dishwashers, washing machines, clothes dryers, televisions, computers, lighting, other	
	Geo-climatic measurements		
<b>Comments</b>	Main challenges	Quality control Communication with household occupants	
	Recommendations	Develop tools for quality control evaluation before the commencement of measurements	
	Key best practice	The distributed data logging system (B-manage) developed by Enertech has been instrumental. Sweden developed a custom interface in SQL database to analyse measured data and to make estimates.	
	Other documentation	Available: metering report	

<b>Background</b>	Country	Togo	<b>R/Me/07</b>
	Organisation	Ministry of Mines and Energy	
	Name of the project		
	Project purpose	<ul style="list-style-type: none"> <li>• To understand residential energy consumption patterns</li> <li>• To understand appliance utilisation patterns</li> <li>• To complement an existing survey</li> </ul>	
<b>Data collection</b>	Sample design	Simple random sampling, equal probability of selection	
	Sample sources	National census	
	Equipment used	Scale to weigh the amount of wood used on a daily basis	
	Sample size	2 500	
	Frequency	No regular cycle	
	Time to collect measurements	Three days per household	
	Who took measurements	Survey team undertaking the household survey	
	End uses measured	Space cooling, water heating	
Geo-climatic measurements	No		
<b>Comments</b>	Main challenges	Communication with household occupants	
	Recommendations		
	Key best practice		
	Other documentation		

<b>Background</b>	Country	Albania	<b>R/Mo/01</b>
	Organisation	National Agency of Natural Resources	
	Name of the model		
	Model purpose	<ul style="list-style-type: none"> <li>• To estimate residential energy consumption</li> <li>• To estimate diffusion of residential appliances</li> </ul>	
<b>Data inputs/outputs</b>	Model type	Bottom-up statistical model	
	Results validated	No	
	Frequency	Only conducted once	
	Key model inputs	<ul style="list-style-type: none"> <li>• Water heating system</li> <li>• Diffusion of residential appliances</li> <li>• Lighting fixture</li> <li>• Building types</li> <li>• Heating/cooling degree days</li> </ul>	
	Key model outputs	<ul style="list-style-type: none"> <li>• Space heating energy consumption</li> <li>• Space cooling energy consumption</li> <li>• Water heating energy consumption</li> <li>• Appliance energy consumption</li> <li>• Lighting energy consumption</li> <li>• Total residential sector energy consumption</li> </ul>	
<b>Comments</b>	Main challenges	<ul style="list-style-type: none"> <li>• Lack of input data</li> <li>• Lack of good model documentation</li> </ul>	
	Additional information		
	Key best practice	The model has helped improve quality of energy data in the residential sector and estimate missing data	
	Other documentation		

<b>Background</b>	<b>Country</b>	Australia	<b>R/Mo/02</b>
	<b>Organisation</b>	Australian Bureau of Agricultural and Resource Economics — Bureau of Rural Sciences	
	<b>Name of the model</b>		
	<b>Model purpose</b>	To estimate residential energy consumption	
<b>Data inputs/outputs</b>	<b>Model type</b>	<ul style="list-style-type: none"> <li>• Top-down econometric model</li> <li>• Modelling of the residential sector is done “in-house” using recognised econometric software, such as Stata and Eviews.</li> </ul>	
	<b>Results validated</b>	No	
	<b>Frequency</b>	No regular cycle	
	<b>Key model inputs</b>	<ul style="list-style-type: none"> <li>• Household occupancy</li> <li>• Total residential sector energy consumption</li> </ul>	<ul style="list-style-type: none"> <li>• Energy prices</li> <li>• Macroeconomic data</li> <li>• Heating/cooling degree days</li> </ul>
	<b>Key model outputs</b>	Energy consumption in the residential sector by state and fuel type	
<b>Comments</b>	<b>Main challenges</b>	<ul style="list-style-type: none"> <li>• Boundary issues</li> <li>• Lack of input data</li> <li>• Quality control issues with input data</li> </ul>	
	<b>Additional information</b>	<p>The lack of primary source data relating to the residential sector has meant that estimations of energy use in this sector have been based on secondary sources and analysis of the residual of energy remaining after the estimates of other sectors’ energy use. The modelling provides a thorough estimation framework to guide and improve the consistency of annual estimates. The top-down approach mainly attempts to identify price and income elasticities on a case-by-case basis for residential energy consumption for each Australian state and fuel type using a variety of indicators and fairly straightforward econometric techniques. The quality, periodicity and availability of input data limit the sophistication of techniques that can be used for this purpose.</p>	
	<b>Key best practice</b>		
	<b>Other documentation</b>		

		R/Mo/03
<b>Background</b>	Country	Austria
	Organisation	Statistics Austria
	Name of the model	Matching the results of Household Electricity Consumption Survey with Residential Energy Consumption Survey
	Model purpose	<ul style="list-style-type: none"> <li>• To estimate end-use energy consumption</li> <li>• To estimate regional residential energy consumption</li> <li>• To estimate household power consumption in urban and rural areas</li> <li>• To complement data collected in a survey</li> </ul>
<b>Data inputs/outputs</b>	Model type	<ul style="list-style-type: none"> <li>• Bottom-up statistical model</li> <li>• Custom-built survey-matching model</li> </ul>
	Results validated	No
	Frequency	Every two years
	Key model inputs	<ul style="list-style-type: none"> <li>• Household occupancy, floor area, dwelling demolition/construction rates, building types</li> <li>• Socio-economic factors such as education, age and employment of household members</li> <li>• Total electricity consumption with regional breakdown, heating system</li> <li>• Use of solar heating, electricity-powered space and water heating</li> </ul>
<b>Key model outputs</b>	<ul style="list-style-type: none"> <li>• Detailed electricity consumption of residential appliances</li> <li>• Lighting energy consumption</li> <li>• Standby power</li> <li>• Office and communication equipment</li> <li>• Fan heaters, air conditioning, other</li> </ul>	
<b>Comments</b>	Main challenges	Infrequent surveys to feed the model with up-to-date data and trends
	Additional information	
	Key best practice	The model links the results of the detailed and infrequent survey Household Electricity Consumption by Purpose Survey with the annual survey Residential Energy Consumption Survey
	Other documentation	Available: modelling documentation

		<b>R/Mo/04</b>
<b>Background</b>	<b>Country</b>	Bosnia and Herzegovina/Croatia
	<b>Organisation</b>	Energy Institute Hrvoje Pozar in Croatia
	<b>Name of the model</b>	End-use modelling using MAED tool
	<b>Model purpose</b>	<ul style="list-style-type: none"> <li>• To estimate residential energy consumption by end use</li> <li>• To estimate diffusion of residential appliances</li> <li>• To estimate regional residential energy consumption</li> <li>• To estimate seasonal residential energy consumption</li> <li>• To estimate residential energy load profile</li> <li>• To complement data collected through another survey</li> </ul>
<b>Data inputs/outputs</b>	<b>Model type</b>	<ul style="list-style-type: none"> <li>• Bottom-up engineering model</li> <li>• Custom-built model</li> </ul>
	<b>Results validated</b>	Yes: calibration with energy balances
	<b>Frequency</b>	Only conducted once
	<b>Key model inputs</b>	<ul style="list-style-type: none"> <li style="width: 50%;">• Space heating system</li> <li style="width: 50%;">• Technology energy efficiency</li> <li style="width: 50%;">• Space cooling system</li> <li style="width: 50%;">• Total residential sector energy consumption</li> <li style="width: 50%;">• Water heating system</li> <li style="width: 50%;">• Energy prices</li> <li style="width: 50%;">• Diffusion of residential appliances</li> <li style="width: 50%;">• Macroeconomic data</li> <li style="width: 50%;">• Lighting</li> <li style="width: 50%;">• Heating/cooling degree days</li> <li style="width: 50%;">• Household occupancy</li> <li style="width: 50%;">• Building thermal envelope</li> <li style="width: 50%;">• Dwelling demolition/construction rates</li> <li style="width: 50%;">• Building types</li> </ul>
<b>Key model outputs</b>	<ul style="list-style-type: none"> <li style="width: 50%;">• Space heating energy consumption</li> <li style="width: 50%;">• Seasonal energy consumption</li> <li style="width: 50%;">• Space cooling energy consumption</li> <li style="width: 50%;">• Regional energy consumption</li> <li style="width: 50%;">• Water heating energy consumption</li> <li style="width: 50%;">• Total residential sector energy consumption</li> <li style="width: 50%;">• Appliance energy consumption</li> <li style="width: 50%;">• Lighting energy consumption</li> </ul>	
<b>Comments</b>	<b>Main challenges</b>	Lack of input data
	<b>Additional information</b>	
	<b>Key best practice</b>	The regional modelling perspective allowed the identification of significant differences among households in different zones
	<b>Other documentation</b>	



<b>Background</b>	Country	Canada	<b>R/Mo/05</b>
	Organisation	Natural Resources Canada	
	Name of the model	Residential Energy End-Use Model	
	Model purpose	To estimate residential energy consumption by end use	
<b>Data inputs/outputs</b>	Model type	<ul style="list-style-type: none"> <li>• Bottom-up statistical model</li> <li>• The modelling tool was developed in-house and undergoes continuous improvements to take into account new or improved data</li> </ul>	
	Results validated	Yes: the Report on Energy Supply and Demand in Canada from Statistics Canada and the National Inventory Report from Environment Canada.	
	Frequency	Every year	
	Key model inputs	<ul style="list-style-type: none"> <li>• Space heating system</li> <li>• Space cooling system</li> <li>• Water heating system</li> <li>• Diffusion of residential appliances</li> <li>• Lighting</li> <li>• Household occupancy</li> </ul>	<ul style="list-style-type: none"> <li>• Dwelling demolition/construction rates</li> <li>• Building types</li> <li>• Total residential sector energy consumption</li> <li>• Macroeconomic data</li> <li>• Heating/cooling degree days</li> </ul>
	Key model outputs	<ul style="list-style-type: none"> <li>• Space heating energy consumption</li> <li>• Space cooling energy consumption</li> <li>• Water heating energy consumption</li> <li>• Appliances energy consumption</li> </ul>	<ul style="list-style-type: none"> <li>• Lighting energy consumption</li> <li>• Total residential sector energy consumption</li> </ul>
<b>Comments</b>	Main challenges	<ul style="list-style-type: none"> <li>• Lack of input data</li> <li>• Lack of data limits capacity to expand the model</li> </ul>	
	Additional information		
	Key best practice	Results from the Survey of Households Energy Use are compared with data from the Survey of Household Spending, such as the distribution of households by fuel type and the penetration rate of appliances	
	Other documentation		

<b>Background</b>	Country	Croatia	<b>R/Mo/06</b>
	Organisation	Energy Institute Hrvoje Pozar in Croatia	
	Name of the model	End-use modelling with MAED tool	
	Model purpose	<ul style="list-style-type: none"> <li>• To estimate residential energy consumption by end use and region</li> <li>• To estimate diffusion of residential appliances</li> <li>• To estimate seasonal residential energy consumption</li> <li>• To estimate residential energy load profile</li> </ul>	
<b>Data inputs/outputs</b>	Model type	<ul style="list-style-type: none"> <li>• Bottom-up engineering model</li> <li>• Custom-built model</li> </ul>	
	Results validated	Yes: calibration with energy balance	
	Frequency	Every five years	
	Key model inputs	<ul style="list-style-type: none"> <li>• Space heating system</li> <li>• Space cooling system</li> <li>• Water heating system</li> <li>• Diffusion of residential appliances</li> <li>• Lighting</li> <li>• Household occupancy</li> <li>• Dwelling demolition/construction rates</li> <li>• Building types</li> <li>• Technology cost</li> </ul>	<ul style="list-style-type: none"> <li>• Technology life cycle</li> <li>• Technology energy efficiency</li> <li>• Total residential sector energy consumption</li> <li>• Energy prices</li> <li>• Macroeconomic data</li> <li>• Heating/cooling degree days</li> <li>• Building thermal envelope</li> </ul>
Key model outputs	<ul style="list-style-type: none"> <li>• Space heating energy consumption</li> <li>• Space cooling energy consumption</li> <li>• Water heating energy consumption</li> <li>• Appliance energy consumption</li> <li>• Lighting energy consumption</li> </ul>	<ul style="list-style-type: none"> <li>• Seasonal energy consumption</li> <li>• Regional energy consumption</li> <li>• Total residential sector energy consumption</li> </ul>	
<b>Comments</b>	Main challenges	Lack of input data	
	Additional information	Limited to Split and Dalmatia County	
	Key best practice	The regional modelling perspective allowed the identification of significant differences among households in different zones	
	Other documentation		

<b>Background</b>	Country	Czech Republic	<b>R/Mo/07</b>
	Organisation	Ministry of Industry and Trade	
	Name of the model		
	Model purpose	<ul style="list-style-type: none"> <li>• To estimate residential space heating demand</li> <li>• To complement another data collection effort</li> <li>• To prepare the IEA Energy Efficiency Indicators questionnaire</li> </ul>	
<b>Inputs/outputs</b>	Model type	Bottom-up statistical model	
	Results validated	No	
	Frequency	Every year	
	Key model inputs	<ul style="list-style-type: none"> <li>• Space heating system</li> <li>• Total residential sector energy consumption</li> </ul>	
	Key model outputs	Residential energy consumption in space heating	
<b>Comments</b>	Main challenges		
	Additional information	Work on this model has been ongoing since 2004 and the model is still not complete. Originally, the model's objective was to estimate total household coal and biomass consumption. The model's objective has currently shifted to better estimate the final household heating demand as energy prices fluctuate. The second goal is to better connect the statistics with household emissions statistics to build a coherent model for both purposes. The modelling benefits from the new household census (2011) and the ENERGY survey carried out by the Czech Statistics Office.	
	Key best practice		
	Other documentation		

<b>Background</b>	Country	Denmark	<b>R/Mo/08</b>
	Organisation	IT Energy	
	Name of the model	ELMODEL	
	Model purpose	<ul style="list-style-type: none"> <li>• To estimate residential energy consumption by end use</li> <li>• To estimate regional residential energy consumption</li> </ul>	
<b>Data inputs/outputs</b>	Model type	Bottom-up engineering model Custom-built model with annual license fee	
	Results validated	Yes: the validation is against total consumption for the domestic sector derived from the energy utilities (Danish Energy Association)	
	Frequency	Every two years	
	Key model inputs	<ul style="list-style-type: none"> <li>• Space heating system</li> <li>• Space cooling system</li> <li>• Water heating system</li> <li>• Diffusion of residential appliances</li> <li>• Lighting fixture</li> <li>• Household occupancy</li> </ul>	<ul style="list-style-type: none"> <li>• Dwelling demolition/construction rates</li> <li>• Building types</li> <li>• Technology life cycle</li> <li>• Technology energy efficiency</li> <li>• Heating/cooling degree days</li> <li>• Sales figures for specific appliance types</li> </ul>
	Key model outputs	<ul style="list-style-type: none"> <li>• Space heating energy consumption</li> <li>• Appliances energy consumption</li> <li>• Lighting energy consumption</li> <li>• Regional energy consumption</li> <li>• Total residential sector energy consumption</li> </ul>	<ul style="list-style-type: none"> <li>• Consumption by dwelling type</li> <li>• Consumption by end use</li> <li>• Standby power</li> </ul>
<b>Comments</b>	Main challenges	<ul style="list-style-type: none"> <li>• Lack of training for the modelling staff</li> <li>• Choice of assumptions</li> </ul>	
	Additional information		
	Key best practice	The model uses a traditional bottom-up approach. An improved feature is the combined use of ownership levels and sales figures for specific appliances. Assuming a specific technical lifespan of an appliance, the theoretical sales per year can be calculated. This is then compared with actual sales figures (for the appliances where they can be collected) and adjustments are made.	
	Other documentation	Available: modelling documentation	

<b>Background</b>	Country	Indonesia	<b>R/Mo/09</b>
	Organisation	Data and Information Centre, Ministry of Energy and Mineral Resources	
	Name of the model	Simulation model	
	Model purpose	<ul style="list-style-type: none"> <li>• To estimate residential energy consumption</li> <li>• To estimate regional residential energy consumption</li> </ul>	
<b>Data inputs/outputs</b>	Model type	<ul style="list-style-type: none"> <li>• Top-down model</li> <li>• Free software</li> </ul>	
	Results validated	Yes: energy sales data	
	Frequency	No regular cycle	
	Key model inputs	Macroeconomic data	
	Key model outputs	<ul style="list-style-type: none"> <li>• Total residential sector energy consumption</li> <li>• Energy consumption by fuel type for residential sector</li> </ul>	
<b>Comments</b>	Main challenges	<ul style="list-style-type: none"> <li>• Lack of input data</li> <li>• Lack of good model documentation</li> </ul>	
	Additional information		
	Key best practice		
	Other documentation		

<b>Background</b>	Country	Italy	<b>R/Mo/10</b>
	Organisation	Ricerca sul Sistema Energetico	
	Name of the model		
	Model purpose	<ul style="list-style-type: none"> <li>• To estimate residential energy consumption by end use</li> <li>• To estimate diffusion of residential appliances</li> </ul>	
<b>Data inputs/outputs</b>	Model type	<ul style="list-style-type: none"> <li>• Top-down technological model</li> <li>• Bottom-up engineering model</li> <li>• Custom-built model</li> </ul>	
	Results validated	Yes: the results are calibrated with aggregated electricity consumption	
	Frequency	Every year	
	Key model inputs		
	Key model outputs	<ul style="list-style-type: none"> <li>• Space cooling energy consumption</li> <li>• Appliances energy consumption</li> <li>• Lighting energy consumption</li> </ul>	
<b>Comments</b>	Main challenges	<ul style="list-style-type: none"> <li>• Lack of input data</li> <li>• Quality control issues with input data</li> <li>• Choice of assumptions</li> </ul>	
	Additional information		
	Key best practice		
	Other documentation		

	Country	Italy	R/Mo/11
Background	Organisation	Institute of Studies for the Integration of Systems	
	Name of the model		
	Model purpose	<ul style="list-style-type: none"> <li>• To estimate diffusion of residential appliances</li> <li>• To estimate energy consumption by end use</li> <li>• To estimate residential energy load profile</li> <li>• To complement data collected through another survey</li> </ul>	
Data inputs/outputs	Model type	<ul style="list-style-type: none"> <li>• Bottom-up statistical model</li> <li>• Bottom-up engineering model</li> <li>• Custom-built model</li> </ul>	
	Results validated	Yes: comparison and calibration at the reference year against Eurostat and ODYSSEE data	
	Frequency	No regular cycle	
	Key model inputs	<ul style="list-style-type: none"> <li>• Space heating system</li> <li>• Water heating system</li> <li>• Diffusion of residential appliances</li> <li>• Lighting</li> <li>• Household occupancy</li> <li>• Dwelling demolition/construction rates</li> <li>• Building types</li> </ul>	<ul style="list-style-type: none"> <li>• Technology life cycle</li> <li>• Technology energy efficiency</li> <li>• Total residential sector energy consumption</li> <li>• Energy prices</li> <li>• Macroeconomic data</li> <li>• Building thermal envelope</li> </ul>
	Key model outputs	<ul style="list-style-type: none"> <li>• Space heating energy consumption</li> <li>• Water heating energy consumption</li> <li>• Appliance energy consumption</li> </ul>	<ul style="list-style-type: none"> <li>• Lighting energy consumption</li> <li>• Total residential sector energy consumption</li> </ul>
Comments	Main challenges	<ul style="list-style-type: none"> <li>• Quality control issues with the model</li> <li>• Lack of input data</li> <li>• Quality control issues with input data</li> <li>• Choice of assumptions</li> <li>• Lack of good model documentation</li> </ul>	
	Additional information		
	Key best practice	No real innovative methods used. The model is a statistical and partly engineering bottom-up tool whose assumptions and results were checked by an expert panel.	
	Other documentation		

<b>Background</b>	<b>Country</b>	Mexico	<b>R/Mo/12</b>
	<b>Organisation</b>	Ministry of Energy	
	<b>Name of the model</b>	Energy Consumption by End Use in the Residential Sector	
	<b>Model purpose</b>	<ul style="list-style-type: none"> <li>• To estimate diffusion of residential appliances</li> <li>• To estimate residential energy consumption by end use</li> </ul>	
<b>Data inputs/outputs</b>	<b>Model type</b>	<ul style="list-style-type: none"> <li>• Bottom-up statistical model</li> <li>• The model was developed using MS Excel and SPSS software</li> </ul>	
	<b>Results validated</b>	Yes: the total energy consumption in the residential sector calculated in the model was validated against data published in the National Energy Balance	
	<b>Frequency</b>	Every two years	
	<b>Key model inputs</b>	<ul style="list-style-type: none"> <li>• Space heating system</li> <li>• Space cooling system</li> <li>• Water heating system</li> <li>• Diffusion of residential appliances</li> <li>• Lighting</li> <li>• Household occupancy</li> </ul>	<ul style="list-style-type: none"> <li>• Heating/cooling degree days</li> <li>• Floor area</li> <li>• Behaviour-based consumption patterns were derived from a national survey</li> <li>• Average power consumption of appliances was provided by manufacturers</li> </ul>
	<b>Key model outputs</b>	<ul style="list-style-type: none"> <li>• Space heating energy consumption</li> <li>• Space cooling energy consumption</li> <li>• Water heating energy consumption</li> <li>• Appliance energy consumption</li> </ul>	<ul style="list-style-type: none"> <li>• Lighting energy consumption</li> <li>• Total residential sector energy consumption</li> </ul>
<b>Comments</b>	<b>Main challenges</b>	<ul style="list-style-type: none"> <li>• Lack of input data</li> <li>• Quality control issues with input data</li> <li>• Choice of assumptions</li> </ul>	
	<b>Additional information</b>		
	<b>Key best practice</b>	Results of a household survey conducted every two years by the National Institute of Statistics were used for appliance utilisation patterns and general household characteristics. Given the lack of resources, this is a very good way to construct energy efficiency indicators because data continuity can be maintained.	
	<b>Other documentation</b>		



<b>Background</b>	Country	New Zealand	<b>R/Mo/13</b>
	Organisation	Energy Efficiency and Conservation Authority (EECA)	
	Name of the model	New Zealand Energy End-Use Database	
	Model purpose	<ul style="list-style-type: none"> <li>• To estimate end-use energy consumption</li> <li>• To estimate regional residential energy consumption</li> <li>• To meet partial fulfilment of EECA to monitor and analyse energy use in New Zealand</li> <li>• To provide a tool for market researchers, investment advisers, energy forecasters and policy analysts</li> </ul>	
<b>Data inputs/outputs</b>	Model type	<ul style="list-style-type: none"> <li>• Bottom-up statistical model</li> <li>• Purchased an existing model</li> </ul>	
	Results validated	Yes: the estimates are validated with national New Zealand statistics and other organisations	
	Frequency	Every five years	
	Key model inputs	<ul style="list-style-type: none"> <li>• Diffusion of appliances</li> <li>• Household occupancy</li> <li>• Building types</li> </ul>	<ul style="list-style-type: none"> <li>• Technology life cycle</li> <li>• Macroeconomic data</li> <li>• Heating/cooling degree days</li> </ul>
	Key model outputs	<ul style="list-style-type: none"> <li>• Space heating energy consumption</li> <li>• Space cooling energy consumption</li> <li>• Water heating energy consumption</li> </ul>	<ul style="list-style-type: none"> <li>• Appliances energy consumption</li> <li>• Lighting energy consumption</li> </ul>
<b>Comments</b>	Main challenges	<ul style="list-style-type: none"> <li>• Quality control issues with the model</li> <li>• Lack of input data</li> <li>• Quality control issues with input data</li> <li>• Choice of assumptions</li> </ul>	
	Additional information	EECA has a plan to get the database updated on an annual basis. Economy-wide and sectoral fuel type data are obtained from government published sources and then allocated across end uses, technologies, and regional and territorial authorities. The results are in the form of estimates.	
	Key best practice	The database dates back to 1987. EECA purchased the ownership rights with the objective to utilise it for internal analysis and also with the aim to share it with the public.	
	Other documentation		

<b>Background</b>	Country	Romania	<b>R/Mo/14</b>
	Organisation	National Institute of Statistics	
	Name of the model		
	Model purpose	To estimate final energy consumption by end use	
<b>Inputs/outputs</b>	Model type	Bottom-up engineering model	
	Results validated		
	Frequency	No regular cycle	
	Key model inputs	<ul style="list-style-type: none"> <li>• Household occupancy</li> <li>• Total residential sector energy consumption</li> </ul>	
	Key model outputs	<ul style="list-style-type: none"> <li>• Space heating energy consumption</li> <li>• Appliances energy consumption</li> <li>• Cooking energy consumption</li> <li>• Lighting energy consumption</li> </ul>	
<b>Comments</b>	Main challenges		
	Additional information		
	Key best practice		
	Other documentation		

<b>Background</b>	Country	Spain	<b>R/Mo/15</b>
	Organisation	Instituto para la Diversificación y Ahorro de la Energía	
	Name of the model		
	Model purpose	<ul style="list-style-type: none"> <li>• To estimate diffusion of residential appliances</li> <li>• To estimate energy consumption by end use</li> </ul>	
<b>Data inputs/outputs</b>	Model type	<ul style="list-style-type: none"> <li>• Top-down technological model</li> <li>• Custom-built model</li> </ul>	
	Results validated	Yes: the modelling results are validated against existing surveys and measurements	
	Frequency	Every year	
	Key model inputs	<ul style="list-style-type: none"> <li>• Household occupancy</li> <li>• Total residential sector energy consumption</li> </ul>	<ul style="list-style-type: none"> <li>• Macroeconomic data</li> <li>• Heating/cooling degree days</li> </ul>
	Key model outputs	<ul style="list-style-type: none"> <li>• Space heating energy consumption</li> <li>• Space cooling energy consumption</li> <li>• Water heating energy consumption</li> </ul>	<ul style="list-style-type: none"> <li>• Appliances energy consumption</li> <li>• Lighting energy consumption</li> </ul>
<b>Comments</b>	Main challenges	<ul style="list-style-type: none"> <li>• Boundary issues</li> <li>• Quality control issues with input data</li> <li>• Choice of assumptions</li> </ul>	
	Additional information		
	Key best practice		
	Other documentation		

<b>Background</b>	<b>Country</b>	Switzerland	<b>R/Mo/16</b>
	<b>Organisation</b>	Swiss Federal Office of Energy; Prognos AG	
	<b>Name of the model</b>	Residential Energy Consumption Model	
	<b>Model purpose</b>	<ul style="list-style-type: none"> <li>• To estimate residential energy consumption by end use</li> <li>• To estimate energy consumption by determinant factors.</li> </ul>	
<b>Data inputs/outputs</b>	<b>Model type</b>	<ul style="list-style-type: none"> <li>• Bottom-up energy-economic model, close to bottom-up engineering model</li> <li>• Custom-built model</li> </ul>	
	<b>Results validated</b>	Yes: calibration with Swiss energy statistics	
	<b>Frequency</b>	Every year	
	<b>Key model inputs</b>	<ul style="list-style-type: none"> <li>• Space heating system</li> <li>• Space cooling system</li> <li>• Water heating system</li> <li>• Diffusion of residential appliances</li> <li>• Lighting</li> <li>• Household occupancy</li> <li>• Dwelling demolition/construction rates building types</li> <li>• Technology life cycle</li> <li>• Technology energy efficiency</li> </ul>	<ul style="list-style-type: none"> <li>• Total residential sector energy consumption</li> <li>• Building thermal envelope</li> <li>• Heating degree days and radiation data</li> <li>• Energy reference area</li> <li>• Household structure by size</li> <li>• Building stock by period of construction</li> <li>• Annual sales of equipment</li> <li>• Energy subsidies data</li> </ul>
	<b>Key model outputs</b>	<ul style="list-style-type: none"> <li>• Space heating energy consumption</li> <li>• Water heating energy consumption</li> </ul>	<ul style="list-style-type: none"> <li>• Appliances energy consumption</li> <li>• Lighting energy consumption</li> </ul>
<b>Comments</b>	<b>Main challenges</b>	<ul style="list-style-type: none"> <li>• Lack of input data</li> <li>• Including new trends whenever possible</li> </ul>	
	<b>Additional information</b>		
	<b>Key best practice</b>	The analysis of energy consumption by end use is based on the models developed for the energy perspectives. Fifteen years of experience and annual model runs have helped to increase the number of inputs in all fields of data sources	
	<b>Other documentation</b>	Available: report	

<b>Background</b>	Country	Switzerland	<b>R/Mo/17</b>
	Organisation	TEP Energy	
	Name of the model		
	Model purpose	<ul style="list-style-type: none"> <li>• To estimate residential energy consumption by end use</li> <li>• To estimate diffusion of residential appliances</li> <li>• To estimate regional residential energy consumption</li> </ul>	
<b>Data inputs/outputs</b>	Model type	<ul style="list-style-type: none"> <li>• Bottom-up engineering model</li> <li>• Custom-built model</li> </ul>	
	Results validated	Yes: compare model output with national statistical data	
	Frequency	Every two years	
	Key model inputs	<ul style="list-style-type: none"> <li>• Space heating system</li> <li>• Space cooling system</li> <li>• Water heating system</li> <li>• Diffusion of residential appliances</li> <li>• Lighting fixture</li> <li>• Household occupancy</li> <li>• Dwelling demolition/construction rates</li> </ul>	<ul style="list-style-type: none"> <li>• Building types</li> <li>• Technology life cycle</li> <li>• Technology energy efficiency</li> <li>• Total residential sector energy consumption</li> <li>• Heating/cooling degree days</li> <li>• Building thermal envelope</li> </ul>
	Key model outputs	<ul style="list-style-type: none"> <li>• Space heating energy consumption</li> <li>• Space cooling energy consumption</li> <li>• Water heating energy consumption</li> <li>• Appliance energy consumption</li> </ul>	<ul style="list-style-type: none"> <li>• Lighting energy consumption</li> <li>• Regional energy consumption</li> <li>• Total residential sector energy consumption</li> </ul>
<b>Comments</b>	Main challenges	<ul style="list-style-type: none"> <li>• Quality control issues with the model</li> <li>• Modelling boundary definition</li> <li>• Lack of input data</li> <li>• Quality control issues with input data</li> </ul>	
	Additional information		
	Key best practice	The model incorporated spatial analysis. Energy consumption was compared with spatially differentiated potentials of renewable energies and existing energy infrastructure elements using geographical information system.	
	Other documentation		

<b>Background</b>	<b>Country</b>	United Kingdom	<b>R/Mo/18</b>
	<b>Organisation</b>	Department of Energy and Climate Change	
	<b>Name of the model</b>	BREhomes/BREdem	
	<b>Model purpose</b>	<ul style="list-style-type: none"> <li>• To estimate residential energy consumption by end use</li> <li>• To estimate regional residential energy consumption</li> </ul>	
<b>Data inputs/outputs</b>	<b>Model type</b>	<ul style="list-style-type: none"> <li>• Bottom-up statistical model</li> <li>• Custom-built model</li> </ul>	
	<b>Results validated</b>	Yes: total domestic consumption is validated against the energy balance data	
	<b>Frequency</b>	Every year	
	<b>Key model inputs</b>	<ul style="list-style-type: none"> <li>• Building types</li> <li>• Macroeconomic data</li> <li>• Heating/cooling degree days</li> <li>• Building thermal envelope</li> </ul>	
	<b>Key model outputs</b>	<ul style="list-style-type: none"> <li>• Space heating energy consumption</li> <li>• Water heating energy consumption</li> <li>• Appliances energy consumption</li> <li>• Lighting energy consumption</li> <li>• Cooking</li> </ul>	
<b>Comments</b>	<b>Main challenges</b>	<ul style="list-style-type: none"> <li>• Quality control issues with the model</li> <li>• Lack of input data</li> <li>• Choice of assumptions</li> </ul>	
	<b>Additional information</b>		
	<b>Key best practice</b>		
	<b>Other documentation</b>	Available: modelling documentation	

<b>Background</b>	Country	United States	R/Mo/19
	Organisation	Energy Information Administration	
	Name of the model	Residential Energy Consumption Survey (RECS) End-Use Modelling	
	Model purpose	<ul style="list-style-type: none"> <li>• To estimate residential energy consumption</li> <li>• To estimate energy consumption of appliances</li> <li>• To estimate regional residential energy consumption</li> <li>• To estimate residential energy load profile</li> </ul>	
<b>Data inputs/outputs</b>	Model type	<ul style="list-style-type: none"> <li>• Bottom-up statistical model</li> <li>• Built in-house</li> </ul>	
	Results validated	Statistical tests comparing RECS estimates with all available published end-use consumption estimates from similar national and regional studies	
	Frequency	Every four years	
	Key model inputs	<ul style="list-style-type: none"> <li>• Space heating system</li> <li>• Space cooling system</li> <li>• Water heating system</li> <li>• Diffusion of residential appliances</li> <li>• Lighting</li> <li>• Household occupancy</li> </ul>	<ul style="list-style-type: none"> <li>• Building types</li> <li>• Technology energy efficiency</li> <li>• Energy prices</li> <li>• Macroeconomic data</li> <li>• Heating/cooling degree days</li> <li>• Building thermal envelope</li> </ul>
	Key model outputs	<ul style="list-style-type: none"> <li>• Space heating energy consumption</li> <li>• Space cooling energy consumption</li> <li>• Water heating energy consumption</li> <li>• Appliances energy consumption</li> </ul>	<ul style="list-style-type: none"> <li>• Lighting energy consumption</li> <li>• Regional energy consumption</li> <li>• Total energy consumption for residential sector</li> </ul>
<b>Comments</b>	Main challenges	<ul style="list-style-type: none"> <li>• Quality control issues with the model</li> <li>• Modelling boundary definition</li> <li>• Quality control issues with input data</li> <li>• Choice of assumptions</li> <li>• Lack of good end-use modelling literature</li> </ul>	
	Additional information		
	Key best practice	<p>The basic structure of the model has not significantly changed since it was first developed in the late 1970s. The 2009 RECS model takes advantage of the larger sample size and newly added end-use questionnaire items. Further, the 2009 RECS model incorporates monthly consumption and expenditure data directly, instead of aggregated annual data. The underlying structure of the RECS model is periodically assessed to determine whether significant changes are necessary to bring the model on par with the state-of-the-art residential end-use consumption modelling.</p>	
	Other documentation	Available	

## 2 Services

<b>Background</b>	Country	Belgium	<b>S/Ad/01</b>
	Organisation	Vision on Technology	
	Data collection purpose		
<b>Collection</b>	Sources	<ul style="list-style-type: none"> <li>• Energy utilities (gas, oil, electricity, other)</li> <li>• Supplied electricity and natural gas by grid operator, by sector (mandatory reporting on a yearly basis)</li> </ul>	
	Data collected	Annual energy consumption of municipal buildings, schools, hospitals and retirement homes	
<b>Comments</b>	Main challenges	<ul style="list-style-type: none"> <li>• Time-consuming to gather data</li> <li>• In paper format — difficult to transfer to digital format</li> </ul>	
	Additional observations	This survey was performed only for the Flemish region	



<b>Background</b>	<b>Country</b>	Bosnia and Herzegovina	<b>S/Ad/02</b>
	<b>Organisation</b>	Ministry of Industry, Energy and Mining of Republic of Srpska	
	<b>Data collection purpose</b>	To collect energy consumption for commercial and public services sector	
<b>Collection</b>	<b>Sources</b>	<ul style="list-style-type: none"> <li>• Government statistics office</li> <li>• Energy utilities (gas, oil, electricity, other)</li> <li>• Manufacturers</li> </ul>	
	<b>Data collected</b>	Electricity consumption by voltage levels	
<b>Comments</b>	<b>Main challenges</b>	<ul style="list-style-type: none"> <li>• Time-consuming to gather data</li> <li>• In paper format — difficult to transfer to digital format</li> <li>• Data were incomplete</li> </ul>	
	<b>Additional observations</b>	Some data are estimated	

<b>Background</b>	<b>Country</b>	Bosnia and Herzegovina	<b>S/Ad/03</b>
	<b>Organisation</b>	Power Utility of the Republic of Srpska	
	<b>Data collection purpose</b>	To prepare energy balances of electricity	
<b>Collection</b>	<b>Sources</b>	Energy utilities (gas, oil, electricity, other)	
	<b>Data collected</b>		
<b>Comments</b>	<b>Main challenges</b>	<ul style="list-style-type: none"> <li>• Many data points crossed off due to confidentiality of the sources</li> <li>• In paper format — difficult to transfer to digital format</li> <li>• Definition issues within a sector</li> <li>• Data were incomplete</li> </ul>	
	<b>Additional observations</b>	<p>In comparison with other countries in the region, Bosnia and Herzegovina is special because there are three power utilities operating independently. In the Republic of Srpska, there is ERS. In BiH Federation, there are EP BiH and EP HZHB, while the company in the Brcko District performs only distribution and supplying activities.</p> <p>Regulation of the BiH electric energy sector is a common activity of three regulatory commissions. The State Regulatory Commission for Electricity mostly regulates transmission company, independent system operator and international electricity trade; two other regulatory commissions (Regulatory Commission for Energy in the Republic of Srpska and Regulatory Commission for Electricity in BiH Federation) regulate electricity generation, distribution and supply.</p>	

<b>Background</b>	Country	Hong Kong, China	<b>S/Ad/04</b>
	Organisation	Electrical and Mechanical Services Department	
	Data collection purpose		
<b>Collection</b>	Sources	<ul style="list-style-type: none"><li>• Government statistics office</li><li>• Energy utilities (gas, oil, electricity, other)</li></ul>	
	Data collected		
<b>Comments</b>	Main challenges		
	Additional observations		

<b>Background</b>	Country	Israel*	<b>S/Ad/05</b>
	Organisation	Central Bureau of Statistics	
	Data collection purpose	To prepare energy balances	
<b>Collection</b>	Sources	Energy utilities (gas, oil, electricity, other)	
	Data collected	Energy supply and consumption	
<b>Comments</b>	Main challenges	<ul style="list-style-type: none"> <li>• Time-consuming to gather data</li> <li>• Took a long time to establish a relationship with the organisation</li> </ul>	
	Additional observations		

\* See Annex F.

<b>Background</b>	Country	Korea	<b>S/Ad/06</b>
	Organisation	Korea National Oil Corporation	
	Data collection purpose	To prepare national oil supply-and-demand statistics	
<b>Collection</b>	Sources	Manufacturers	
	Data collected	Imports, exports, sales, production, stocks of crude oil and final oil products	
<b>Comments</b>	Main challenges	<ul style="list-style-type: none"> <li>• In paper format — difficult to transfer to digital format</li> <li>• Definition issues within a sector</li> </ul>	
	Additional observations		

<b>Background</b>	<b>Country</b>	Mexico	<b>S/Ad/07</b>
	<b>Organisation</b>	Ministry of Energy	
	<b>Data collection purpose</b>	To prepare national energy balances	
<b>Collection</b>	<b>Sources</b>	<ul style="list-style-type: none"> <li>• Energy utilities (gas, oil, electricity, other)</li> <li>• CFE (state-owned electricity company in Mexico): electricity sales</li> <li>• PEMEX (state-owned petroleum company): petroleum product sales to the sector</li> </ul>	
	<b>Data collected</b>	Total services energy consumption by fuel type	
<b>Comments</b>	<b>Main challenges</b>	<ul style="list-style-type: none"> <li>• Definition issues within a sector</li> <li>• Lack of detailed data</li> </ul>	
	<b>Additional observations</b>		

<b>Background</b>	<b>Country</b>	Netherlands	<b>S/Ad/08</b>
	<b>Organisation</b>	Statistics Netherlands, Department of Energy Statistics	
	<b>Data collection purpose</b>	To derive end use of electricity and gas in all services sub-sectors (on NACE 2-digit level)	
<b>Collection</b>	<b>Sources</b>	Energy utilities (gas, oil, electricity, other)	
	<b>Data collected</b>	For each connection of gas and electricity (households and companies): annual purchased amounts of gas and electricity (no break down by end use)	
<b>Comments</b>	<b>Main challenges</b>	<ul style="list-style-type: none"> <li>• Time-consuming to gather data</li> <li>• Took a long time to establish a relationship with the organisation</li> <li>• Needed to establish the obligation to deliver client files to Statistics Netherlands office for statistical purposes in the statistical law (took several years). Without obligation companies are not willing to co-operate (based on experience in the Netherlands).</li> </ul>	
	<b>Additional observations</b>	Although this project took more time to develop than expected it is still very promising	

<b>Background</b>	<b>Country</b>	Spain	<b>S/Ad/09</b>
	<b>Organisation</b>	Instituto para la Diversificación y Ahorro de la Energía	
	<b>Data collection purpose</b>	To obtain value-added of services sector by branch and breakdown of the final energy consumption by energy source	
<b>Data collection</b>	<b>Sources</b>	<ul style="list-style-type: none"> <li>• Government statistics office</li> <li>• Energy utilities (gas, oil, electricity, other)</li> <li>• National or international associations and organisations</li> </ul>	
	<b>Data collected</b>	<ul style="list-style-type: none"> <li>• Ministry of Economy and Finance, Spanish Statistics Office: accounting data; employment of different branches of the services sector; data on new buildings, such as annual construction (m<sup>2</sup>)</li> <li>• Ministerio de Industria, Energía y Turismo: data for energy balances (by sources and sectors)</li> </ul>	
<b>Comments</b>	<b>Main challenges</b>	<ul style="list-style-type: none"> <li>• Time-consuming to gather data</li> <li>• Data were incomplete</li> </ul>	
	<b>Additional observations</b>	Collaboration of the different administrative bodies at national and local levels will further help improve data quality and data collection	



<b>Background</b>	<b>Country</b>	United Kingdom	<b>S/Ad/10</b>
	<b>Organisation</b>	Department of Energy and Climate Change	
	<b>Data collection purpose</b>	To produce energy consumption by energy source for the commercial sector and separately for the public administration sector in the energy consumption balance	
<b>Collection</b>	<b>Sources</b>	Energy utilities (gas, oil, electricity, other)	
	<b>Data collected</b>	Energy consumption by sector (the commercial and public sectors are identified based on their tariffs and meter types)	
<b>Comments</b>	<b>Main challenges</b>	<ul style="list-style-type: none"> <li>• Time-consuming to gather data</li> <li>• Definition issues within a sector</li> </ul>	
	<b>Additional observations</b>		

<b>Background</b>	Country	Austria	<b>S/Su/01</b>	
	Organisation	Statistics Austria		
	Name of the survey	Energy Consumption of the Service Sector		
	Services categories covered	<ul style="list-style-type: none"> <li>• Office</li> <li>• Retail space</li> <li>• Health care</li> <li>• Education</li> <li>• Warehouse</li> </ul>	<ul style="list-style-type: none"> <li>• Food sales</li> <li>• Food service</li> <li>• Lodging</li> <li>• Arts and entertainment</li> <li>• Multipurpose building</li> </ul>	
	Survey purpose	<ul style="list-style-type: none"> <li>• To track energy consumption over time</li> <li>• To collect energy expenditure</li> </ul>		
<b>Data collection</b>	Sample design	Stratified random sampling approach		
	Sample sources	Business register		
	Population description	Establishments in NACE categories E (of which only 41), G, H, I, J, K and O (of which only 92 and 93) with more than three employees. The survey was sent out to establishments at NACE 2-digit level.		
	Collection methods	<ul style="list-style-type: none"> <li>• Paper form sent by mail</li> <li>• Internet based</li> </ul>		
	Sample/Population size	3 000 / 88 630	Response rate	39%
	Frequency	Every five years		
	Time to complete survey	Not available	Mandatory	No
	Incentive	None		
	Survey respondents	Enterprises		
	Elements collected	<ul style="list-style-type: none"> <li>• Main building function</li> <li>• Energy used</li> <li>• The survey does not focus on buildings but on enterprises and establishments. Floor area and energy consumption by fuel type are collected for the enterprise and not for a single building. Space heating system and age information were collected.</li> </ul>		
End uses covered	<ul style="list-style-type: none"> <li>• Space cooling</li> <li>• Space heating</li> </ul>	<ul style="list-style-type: none"> <li>• Water heating</li> <li>• Transport</li> </ul>		
<b>Comments</b>	Main challenges	<ul style="list-style-type: none"> <li>• Low response rate</li> <li>• Response quality</li> </ul>		
	Possible improvements	Larger sample, face-to-face interview		
	Key best practice	Small and simple questionnaire (only one page) to increase the response rate, including both quantities and monetary values spent on energy as a reference check. The online version of the questionnaire includes checks. Rules about minimum content requirements are set and communicated with respondents that inconsistent and incomplete questionnaires cannot be submitted.		
	Other documentation	Available: questionnaire		

		S/Su/02	
<b>Background</b>	Country	Belgium	
	Organisation	Vision on Technolgy	
	Name of the survey	Voluntary Energy Survey for the Flemish Energy Balance	
	Services categories covered	<ul style="list-style-type: none"> <li>• Office</li> <li>• Retail space</li> <li>• Health care</li> <li>• Education</li> <li>• Warehouse</li> </ul>	<ul style="list-style-type: none"> <li>• Food sales</li> <li>• Food service</li> <li>• Lodging</li> <li>• Arts and entertainment</li> <li>• Multipurpose building</li> </ul>
	Survey purpose	<ul style="list-style-type: none"> <li>• To track energy consumption over time</li> <li>• To set energy efficiency benchmarks</li> <li>• To complement another data collection initiative</li> </ul>	
<b>Data collection</b>	Sample design	A repeating panel of respondents that had been interviewed previously for other surveys	
	Sample sources	List from energy supplier, list of addresses, address list of sectors-based organisations (e.g. hospitals, schools, etc.)	
	Population description	All sectors according to the NACE codes used by the IEA	
	Collection methods	<ul style="list-style-type: none"> <li>• Paper form sent by mail</li> <li>• Internet based</li> </ul>	
	Sample/Population size	Not available	
	Frequency	Every year	
	Time to complete survey	Mandatory	No
	Incentive	None	
	Survey respondents	Mostly CEOs of companies, directors of schools, energy managers of hospitals, etc.	
	Elements collected	<ul style="list-style-type: none"> <li>• Main building function</li> <li>• Building floor area</li> </ul>	<ul style="list-style-type: none"> <li>• Number of occupants/employees</li> <li>• Energy use per type of energy carrier</li> </ul>
End uses covered			
<b>Comments</b>	Main challenges	<ul style="list-style-type: none"> <li>• Low response rate</li> <li>• Response quality</li> </ul>	
	Possible improvements		
	Key best practice		
	Other documentation	Available: questionnaire	

		<b>S/Su/03</b>		
<b>Background</b>	Country	Bosnia and Herzegovina		
	Organisation	Power Utility of the Republic of Srpska		
	Name of the survey			
	Services categories covered			
	Survey purpose	<ul style="list-style-type: none"> <li>• To collect information on energy consumption</li> <li>• To collect energy expenditure</li> <li>• To complement another data collection initiative</li> </ul>		
<b>Data collection</b>	Sample design	Stratified random sampling approach		
	Sample sources	List from energy supplier, transmission company		
	Population description			
	Collection methods	Paper form sent by mail		
	Sample/Population size	Not available	Response rate	100%
	Frequency	Every three years		
	Time to complete survey		Mandatory	Yes
	Incentive	None		
	Survey respondents	Utility companies		
	Elements collected	<ul style="list-style-type: none"> <li>• Main building function</li> <li>• Energy consumption from energy supplier</li> </ul>		
End uses covered				
<b>Comments</b>	Main challenges	Response quality		
	Possible improvements	Bigger sample size		
	Key best practice			
	Other documentation	Not available		

		S/Su/04		
<b>Background</b>	Country	Canada		
	Organisation	Natural Resources Canada		
	Name of the survey	Commercial and Institutional Consumption of Energy Survey		
	Services categories covered	<ul style="list-style-type: none"> <li>• Office</li> <li>• Retail space</li> <li>• Health care</li> <li>• Education</li> </ul>	<ul style="list-style-type: none"> <li>• Warehouse</li> <li>• Food service</li> <li>• Lodging</li> <li>• Arts and entertainment</li> </ul>	
	Survey purpose	<ul style="list-style-type: none"> <li>• To track energy consumption over time</li> <li>• To set energy efficiency benchmarks</li> <li>• To complement another data collection initiative</li> </ul>		
<b>Data collection</b>	Sample design	Stratified random sampling approach		
	Sample sources	Building registrations		
	Population description	Establishment, commercial and institutional sector		
	Collection methods	Paper form sent by mail		
	Sample/Population size	9 500 / 469 000	Response rate	45%
	Frequency	Every year		
	Time to complete survey	60 minutes	Mandatory	No
	Incentive	None		
	Survey respondents	Building occupants		
	Elements collected	<ul style="list-style-type: none"> <li>• Main building function</li> <li>• Building age</li> </ul>	<ul style="list-style-type: none"> <li>• Diffusion of office equipment</li> <li>• Type of renovations</li> </ul>	
End uses covered	Just gathered total energy use. No breakdowns.			
<b>Comments</b>	Main challenges	<ul style="list-style-type: none"> <li>• Low response rate</li> <li>• Incomplete survey</li> <li>• Inconsistent responses</li> <li>• Response quality</li> </ul>		
	Possible improvements	Increased sample size and working on a combined sample of establishments and buildings. This approach is currently being tested.		
	Key best practice			
	Other documentation	Available: questionnaire		

		S/Su/05		
<b>Background</b>	Country	Croatia		
	Organisation	Croatian Bureau of Statistics		
	Name of the survey	Statistical Reports		
	Services categories covered	<ul style="list-style-type: none"> <li>• Education and training</li> <li>• Trade</li> <li>• Tourism and hospitality</li> </ul>	<ul style="list-style-type: none"> <li>• Public administration</li> <li>• Health care</li> <li>• Others</li> </ul>	
	Survey purpose	<ul style="list-style-type: none"> <li>• To track energy consumption over time</li> <li>• To collect all the necessary data to calculate EEI</li> </ul>		
<b>Data collection</b>	Sample design	Stratified random sampling approach		
	Sample sources	Business register		
	Population description	Establishments in NACE categories C33 only, and E, G, H, I, J, K, L, M, N, O, P, Q, R, S. The country does not survey on building level but on NACE 2-digit level.		
	Collection methods	<ul style="list-style-type: none"> <li>• Paper form sent by mail</li> <li>• Internet based</li> </ul>		
	Sample/Population size	6 000 / 196 000	Response rate	40%
	Frequency	Every five years		
	Time to complete survey	Not available	Mandatory	No
	Incentive	None		
	Survey respondents	Enterprises		
	Elements collected	<ul style="list-style-type: none"> <li>• Floor area and energy consumption by fuel type</li> <li>• Heated and cooled surfaces</li> <li>• Renewable energy used</li> <li>• The purpose of final energy used</li> <li>• The heating system and the age of the heating system</li> </ul>		
End uses covered	<ul style="list-style-type: none"> <li>• Space heating</li> <li>• Water heating</li> <li>• Cooking</li> <li>• Space cooling</li> <li>• Non-thermal electricity</li> </ul>			
<b>Comments</b>	Main challenges	Low response rate		
	Possible improvements	Face-to-face interview, but more expensive		
	Key best practice	<ul style="list-style-type: none"> <li>• The online version of the questionnaire including checks</li> <li>• The questionnaires are sent to the enterprises and to the operator of the building if some office space is leased</li> </ul>		
	Other documentation	Available		

<b>Background</b>	Country	Croatia/Bosnia and Herzegovina		<b>S/Su/06</b>
	Organisation	Energy Institute Hrvoje Pazar in Croatia		
	Name of the survey	Survey on energy consumption in Bosnia and Herzegovina		
	Services categories covered	<ul style="list-style-type: none"> <li>• Office</li> <li>• Retail space</li> <li>• Health care</li> <li>• Education</li> <li>• Warehouse</li> </ul>	<ul style="list-style-type: none"> <li>• Food sales</li> <li>• Food service</li> <li>• Arts and entertainment</li> <li>• Multipurpose building</li> </ul>	
	Survey purpose	<ul style="list-style-type: none"> <li>• To track diffusion of equipment</li> <li>• To collect energy consumption by equipment</li> <li>• To track energy consumption over time</li> </ul>		
<b>Data collection</b>	Sample design	Stratified random sampling approach		
	Sample sources	List from tax agency, list from energy supplier, list of addresses		
	Population description	Separate surveys in tourism, health, education, administration, trade, others		
	Collection methods	In-house visit		
	Sample/Population size	1 500 / 15 000	Response rate	30%
	Frequency	Only conducted once		
	Time to complete survey	20 minutes	Mandatory	Yes
	Incentive	None		
	Survey respondents	Utility companies		
	Elements collected	<ul style="list-style-type: none"> <li>• Main building function</li> <li>• Building floor area</li> <li>• Building age</li> <li>• Number of occupants/employees</li> <li>• Occupancy time patterns</li> <li>• Energy bills from building operator</li> </ul>	<ul style="list-style-type: none"> <li>• Diffusion of office equipment</li> <li>• Number of lights</li> <li>• Diffusion of lighting by type</li> <li>• Type of renovations</li> <li>• Energy used</li> </ul>	
End uses covered	<ul style="list-style-type: none"> <li>• Space cooling</li> <li>• Space heating</li> <li>• Water heating</li> </ul>	<ul style="list-style-type: none"> <li>• Office equipment</li> <li>• Auxiliary motors</li> <li>• Lighting</li> </ul>		
<b>Comments</b>	Main challenges	<ul style="list-style-type: none"> <li>• Low response rate</li> <li>• Incomplete survey</li> <li>• Inconsistent responses</li> </ul>	<ul style="list-style-type: none"> <li>• Response quality</li> <li>• Bias from the interviewer</li> </ul>	
	Possible improvements			
	Key best practice			
	Other documentation	Available: questionnaire		

<b>Background</b>	Country	Czech Republic	<b>S/Su/07</b>	
	Organisation	Ministry of Industry and Trade		
	Name of the survey	Statistical Reports		
	Services categories covered			
	Survey purpose	To track energy consumption over time		
<b>Data collection</b>	Sample design	Stratified random sampling approach		
	Sample sources	Business register		
	Population description	According to the NACE organisations with more than 20 employers		
	Collection methods	<ul style="list-style-type: none"> <li>• Paper form sent by mail</li> <li>• Internet based</li> </ul>		
	Sample/Population size	15 000 / 100 000	Response rate	80%
	Frequency	Every year		
	Time to complete survey	80 minutes	Mandatory	Yes
	Incentive	A fine		
	Survey respondents	Utility companies		
	Elements collected	<ul style="list-style-type: none"> <li>• Main building function</li> <li>• Energy consumption from energy supplier</li> </ul>		
End uses covered				
<b>Comments</b>	Main challenges	<ul style="list-style-type: none"> <li>• Low response rate</li> <li>• Incomplete survey</li> <li>• Inconsistent responses</li> <li>• Response quality</li> <li>• Lack of resources</li> </ul>		
	Possible improvements	Improve communication with respondents, better fund allocation		
	Key best practice	Contact and build a long-term relationship with energy managers in companies		
	Other documentation	Available: URL link		



<b>Background</b>	Country	Germany	<b>S/Su/08</b>	
	Organisation	Fraunhofer Institute for Systems and Innovation Research		
	Name of the survey	Energieverbrauch des Sektors Gewerbe, Handel, Dienstleistungen in Deutschland (Energy Consumption of the Tertiary Sector in Germany)		
	Services categories covered	<ul style="list-style-type: none"> <li>• Retail space</li> <li>• Health care</li> <li>• Education</li> <li>• Warehouse</li> </ul>	<ul style="list-style-type: none"> <li>• Food sales</li> <li>• Food service</li> <li>• Lodging</li> </ul>	
	Survey purpose	<ul style="list-style-type: none"> <li>• To collect physical building characteristics</li> <li>• To collect energy consumption by equipment</li> <li>• To track energy consumption over time</li> <li>• To collect energy expenditure</li> </ul>		
<b>Data collection</b>	Sample design	Stratified random sampling approach		
	Sample sources	List of addresses		
	Population description	The main focus of the survey was on sub-sectors (NACE classification), not on building types. Other sub-sectors: agriculture, construction industry, airports. Choice of certain number of companies (workplaces) within the tertiary sector.		
	Collection methods	Computer-assisted personal interview		
	Sample/Population size	2 100 / 70 000	Response rate	100%
	Frequency	Every two years		
	Time to complete survey	120 minutes	Mandatory	No
	Incentive	Non-cash incentives, short report on the survey results for the respective sub-sector and benchmark		
	Survey respondents	Person most knowledgeable with facility/enterprise energy consumption		
	Elements collected	<ul style="list-style-type: none"> <li>• Main building function</li> <li>• Building floor area</li> <li>• Building age</li> <li>• Number of occupants/employees</li> <li>• Energy bills from building operator</li> <li>• Diffusion of office equipment</li> </ul>	<ul style="list-style-type: none"> <li>• Number of lights</li> <li>• Diffusion of lighting by type</li> <li>• Energy used</li> <li>• Questionnaire on energy management issues</li> </ul>	
End uses covered	<ul style="list-style-type: none"> <li>• Space cooling</li> <li>• Space heating</li> <li>• Water heating</li> <li>• Office equipment</li> </ul>	<ul style="list-style-type: none"> <li>• Auxiliary motors</li> <li>• Lighting</li> <li>• Process heat</li> <li>• Process cold</li> </ul>		
<b>Comments</b>	Main challenges	Inconsistent responses		
	Possible improvements	A personal check and energy audit by qualified engineers in 100 of the 2 100 workplaces are planned in addition to the 2008 survey		
	Key best practice	<ul style="list-style-type: none"> <li>• Personal check and energy audit in 100 workplaces</li> <li>• Development of a building typology based on the survey results</li> </ul>		
	Other documentation	Available: 12 sector-level questionnaires, report		

		<b>S/Su/09</b>		
<b>Background</b>	Country	Hong Kong, China		
	Organisation	Electrical and Mechanical Services Department		
	Name of the survey	Energy consumption survey on commercial sector		
	Services categories covered	<ul style="list-style-type: none"> <li>• Office</li> <li>• Retail space</li> <li>• Health care</li> </ul>	<ul style="list-style-type: none"> <li>• Lodging</li> <li>• Education</li> <li>• Warehouse</li> </ul>	
	Survey purpose	<ul style="list-style-type: none"> <li>• To collect physical building characteristics</li> <li>• To track diffusion of equipment</li> <li>• To collect energy consumption by equipment</li> </ul>	<ul style="list-style-type: none"> <li>• To track energy consumption over time</li> <li>• To understand building occupant characteristics</li> <li>• To collect energy expenditure</li> </ul>	
<b>Data collection</b>	Sample design	Stratified random sampling approach		
	Sample sources	National census		
	Population description			
	Collection methods			
	Sample/Population size	Not available		
	Frequency	Every three years		
	Time to complete survey	60 minutes	Mandatory	No
	Incentive	None		
	Survey respondents			
	Elements collected	<ul style="list-style-type: none"> <li>• Main building function</li> <li>• Building floor area</li> <li>• Building age</li> <li>• Energy bills from building operator</li> </ul>	<ul style="list-style-type: none"> <li>• Diffusion of office equipment</li> <li>• Number of lights</li> <li>• Diffusion of lighting by type</li> </ul>	
End uses covered				
<b>Comments</b>	Main challenges	<ul style="list-style-type: none"> <li>• Quality of the interviewing staff</li> <li>• Recruiting, training and retaining project staff</li> </ul>		
	Possible improvements			
	Key best practice			
	Other documentation	Not available		

		S/Su/10		
<b>Background</b>	Country	Korea		
	Organisation	Korea Energy Management Corporation		
	Name of the survey	National Energy & GHG Emissions Survey		
	Services categories covered	<ul style="list-style-type: none"> <li>• Retail space</li> <li>• Health care</li> <li>• Education</li> <li>• Food sales</li> </ul>	<ul style="list-style-type: none"> <li>• Food service</li> <li>• Lodging</li> <li>• Arts and entertainment</li> </ul>	
	Survey purpose	<ul style="list-style-type: none"> <li>• To collect physical building characteristics</li> <li>• To track energy consumption over time</li> </ul>		
<b>Data collection</b>	Sample design	Stratified random sampling approach		
	Sample sources	Census of establishments		
	Population description	All facilities in a given service sector as per classification index		
	Collection methods	In-house visit		
	Sample/Population size	55 925 / 2 611 985	Response rate	90%
	Frequency	Every three years		
	Time to complete survey	30 minutes	Mandatory	No
	Incentive	Non-cash incentives		
	Survey respondents	Building operators		
	Elements collected	<ul style="list-style-type: none"> <li>• Main building function</li> <li>• Building floor area</li> <li>• Building age</li> <li>• Number of occupants/employees</li> <li>• Occupancy time patterns</li> </ul>	<ul style="list-style-type: none"> <li>• Energy bills from building operator</li> <li>• Number of lights</li> <li>• Diffusion of lighting by type</li> <li>• Type of renovations</li> </ul>	
End uses covered	<ul style="list-style-type: none"> <li>• Space cooling</li> <li>• Space heating</li> </ul>	<ul style="list-style-type: none"> <li>• Water heating</li> <li>• Lighting</li> </ul>		
<b>Comments</b>	Main challenges	<ul style="list-style-type: none"> <li>• Low response rate</li> <li>• Response quality</li> </ul>		
	Possible improvements			
	Key best practice			
	Other documentation	Available: questionnaire		

<b>Background</b>	Country	New Zealand	<b>S/Su/11</b>		
	Organisation	Energy Efficiency and Conservation Authority			
	Name of the survey	Building Energy End-Use Study (BEES)			
	Services categories covered	<ul style="list-style-type: none"> <li>• Office</li> <li>• Retail space</li> <li>• Food sales</li> <li>• Food service</li> </ul>	<ul style="list-style-type: none"> <li>• Lodging</li> <li>• Arts and entertainment</li> <li>• Multipurpose building</li> </ul>		
Survey purpose	<ul style="list-style-type: none"> <li>• To collect physical building characteristics</li> <li>• To collect energy consumption by equipment</li> <li>• To collect energy expenditure</li> </ul>	<ul style="list-style-type: none"> <li>• To understand building occupant characteristics</li> <li>• To set energy efficiency benchmarks</li> <li>• To complement another data collection initiative</li> </ul>			
<b>Data collection</b>	Sample design	Stratified random sampling approach; a stratified sampling design divided into 50 strata, mainly size, use and geographical groupings.			
	Sample sources	Property Valuation Roll and NZ Building Code definition; an innovative approach based on the use of Internet search, coupled with the use of Google Earth and Street View			
	Population description	This study covers non-residential buildings such as those for office and retail use. Excluded are industrial and all ancillary and external structures, such as boiler houses or parking spaces.			
	Collection methods	<ul style="list-style-type: none"> <li>• Paper form sent by mail</li> <li>• Telephone interview</li> <li>• In-house visit</li> </ul>	<ul style="list-style-type: none"> <li>• Data logging and metering of individual energy using services and equipment</li> </ul>		
	Sample/Population size	1 000 / 50 000			
	Frequency	A five-year project. Conducted once.			
	Time to complete survey		Mandatory	No	
	Incentive	Respondents have access to energy and water consumption benchmark information in commercial buildings			
	Survey respondents	Building operators, energy auditors			
	Elements collected	<ul style="list-style-type: none"> <li>• Main building function</li> <li>• Building floor area</li> <li>• Building age</li> <li>• Number of occupants/employees</li> <li>• Occupancy time patterns</li> <li>• Energy bills from building operator</li> </ul>	<ul style="list-style-type: none"> <li>• Water use</li> <li>• Energy consumption from energy supplier</li> <li>• Diffusion of office equipment</li> <li>• Number of lights</li> <li>• Diffusion of lighting by type</li> <li>• Type of renovations</li> </ul>		
End uses covered	<ul style="list-style-type: none"> <li>• Space cooling</li> <li>• Space heating</li> <li>• Water heating</li> </ul>	<ul style="list-style-type: none"> <li>• Office equipment</li> <li>• Auxiliary motors</li> <li>• Lighting</li> </ul>			
<b>Comments</b>	Main challenges	<ul style="list-style-type: none"> <li>• Highly resource-intensive</li> </ul>	<ul style="list-style-type: none"> <li>• Building profile is heterogeneous</li> </ul>		
	Possible improvements	Increasing sample size			
	Key best practice	Besides survey and data logging, BEES will also employ simulation modelling. The research will provide a greater understanding of how, why, where and when energy is used in New Zealand's non-residential buildings. Through actual measurement and analysis of energy use in buildings, BEES will identify opportunities for increased operational energy and water efficiency.			
	Other documentation	Available: report			

		S/Su/12		
<b>Background</b>	Country	Spain		
	Organisation	Instituto para la Diversificación y Ahorro de la Energía (IDAE)		
	Name of the survey	Energy Sectoral Follow-Up Surveys		
	Services categories covered	<ul style="list-style-type: none"> <li>• Health care</li> <li>• Education</li> <li>• Lodging</li> </ul>	<ul style="list-style-type: none"> <li>• Large retail stores</li> <li>• Food service</li> </ul>	
	Survey purpose	<ul style="list-style-type: none"> <li>• To track energy consumption over time</li> <li>• To collect energy expenditure</li> <li>• To complement another data collection initiative</li> </ul>		
<b>Data collection</b>	Sample design	All hospitals were contacted with a questionnaire. For hotels, an initial study under development promoted by Hotel Technological Institute (ITH) focused on representative hotels sector of two of the main climatic areas in Spain (Mediterranean and Continental areas). Through the collaboration between IDAE and ITH, the scope of this study will be enlarged, covering an additional climatic area (Atlantic area) as well.		
	Sample sources	National census; in the case of surveys in the hotel sector, listing of hotels and hotel associations facilitated by ITH.		
	Population description			
	Collection methods	Paper form sent by mail		
	Sample size	800 Hospitals, 18 million m <sup>2</sup> of large retail stores	Response rate	20%
	Frequency	Every year		
	Time to complete survey	20 minutes	Mandatory	No
	Incentive	None		
	Survey respondents	Hospitals, primary and secondary schools and universities, larger retail stores, and hotels		
	Elements collected	<ul style="list-style-type: none"> <li>• Main building function</li> <li>• Building floor area</li> <li>• Number of occupants/employees</li> <li>• Energy bills from building operator</li> <li>• Number of hospital beds</li> </ul>	<ul style="list-style-type: none"> <li>• Diffusion of office equipment</li> <li>• Number of lights</li> <li>• Energy used</li> <li>• Combined production of heat and power.</li> </ul>	
End uses covered	Total electricity and heat consumptions			
<b>Comments</b>	Main challenges	<ul style="list-style-type: none"> <li>• Low response rate</li> <li>• Incomplete survey</li> </ul>	<ul style="list-style-type: none"> <li>• Inconsistent responses</li> <li>• Response quality</li> </ul>	
	Possible improvements	Having clear definitions and questions could reduce the respondents' burden and could help respondents provide more appropriate answers		
	Key best practice			
	Other documentation	Available: questionnaire		

<b>Background</b>	Country	Sweden	<b>S/Su/13</b>	
	Organisation	Swedish Energy Agency		
	Name of the survey	Energy Statistics for Non-Residential Premises		
	Services categories covered	<ul style="list-style-type: none"> <li>• Office</li> <li>• Retail space</li> <li>• Health care</li> <li>• Education</li> <li>• Warehouse</li> <li>• Food sales</li> </ul>	<ul style="list-style-type: none"> <li>• Food service</li> <li>• Lodging</li> <li>• Arts and entertainment</li> <li>• Multipurpose building</li> <li>• Churches</li> <li>• Sports centres</li> </ul>	
	Survey purpose	<ul style="list-style-type: none"> <li>• To collect physical building characteristics</li> <li>• To track energy consumption over time</li> <li>• To set energy efficiency benchmarks</li> </ul>		
<b>Data collection</b>	Sample design	Stratified random sampling approach		
	Sample sources	List from tax agency, list of addresses, registry of business		
	Population description	All buildings in the services sector with heated floor area exceeding 200 m <sup>2</sup> and being heated for more than 90 days per year.		
	Collection methods	<ul style="list-style-type: none"> <li>• Paper form sent by mail</li> <li>• Internet based</li> </ul>		
	Sample/Population size	8 500 / 123 000	Response rate	65%
	Frequency	Every year		
	Time to complete survey	60 minutes	Mandatory	Yes
	Incentive	None		
	Survey respondents	Survey sent to building owners, who are responsible for distributing the survey to the appropriate person for answering the survey		
	Elements collected	<ul style="list-style-type: none"> <li>• Main building function</li> <li>• Building floor area</li> <li>• Building age</li> <li>• Type of renovations</li> <li>• Energy used</li> </ul>	<ul style="list-style-type: none"> <li>• Total electricity use for buildings, normally excluding electricity for office equipment since companies pay for their own electricity</li> </ul>	
	End uses covered	<ul style="list-style-type: none"> <li>• Space cooling</li> <li>• Space heating</li> <li>• Water heating</li> </ul>		
<b>Comments</b>	Main challenges	<ul style="list-style-type: none"> <li>• Low response rate</li> <li>• Inconsistent responses</li> <li>• Recruiting, training and retaining project staff</li> </ul>		
	Possible improvements			
	Key best practice			
	Other documentation	Available: questionnaire, report		

		S/Su/14		
<b>Background</b>	Country	Sweden		
	Organisation	Swedish Energy Agency		
	Name of the survey	Energy Statistics for Multi-Dwelling Buildings		
	Services categories covered	Main area in the buildings are residential apartments. The survey also covers non-residential building use such as offices, education, health care, etc.		
	Survey purpose	<ul style="list-style-type: none"> <li>• To collect physical building characteristics</li> <li>• To track energy consumption over time</li> <li>• To set energy efficiency benchmarks</li> </ul>		
<b>Data collection</b>	Sample design	Stratified random sampling approach		
	Sample sources	List from tax agency, list of addresses, registry of businesses		
	Population description	Multi-dwelling buildings with a minimum of three apartments		
	Collection methods	<ul style="list-style-type: none"> <li>• Paper form sent by mail</li> <li>• Internet based</li> </ul>		
	Sample/Population size	7 000 / 153 000	Response rate	70%
	Frequency	Every year		
	Time to complete survey	60 minutes	Mandatory	Yes
	Incentive	None		
	Survey respondents	Building operators — survey is sent to building owners who are responsible for ensuring that the appropriate person responds to the survey		
	Elements collected	<ul style="list-style-type: none"> <li>• Building floor area</li> <li>• Building age</li> </ul>	<ul style="list-style-type: none"> <li>• Type of renovations</li> <li>• Energy consumption</li> </ul>	
	End uses covered	<ul style="list-style-type: none"> <li>• Space cooling</li> <li>• Space heating</li> </ul>	<ul style="list-style-type: none"> <li>• Water heating</li> </ul>	
<b>Comments</b>	Main challenges	<ul style="list-style-type: none"> <li>• Low response rate</li> <li>• Incomplete survey</li> <li>• Inconsistent responses</li> </ul>	<ul style="list-style-type: none"> <li>• Quality of the interviewing staff</li> <li>• Recruiting, training and retaining project staff</li> </ul>	
	Possible improvements			
	Key best practice			
	Other documentation	Available: questionnaire		

		<b>S/Su/15</b>		
<b>Background</b>	Country	Ukraine		
	Organisation	State Statistics Committee of Ukraine		
	Name of the survey	Consumption of Fuel, Heat Power and Energy; Stocks and Use of Energy Materials and Oil-Processing Products		
	Services categories covered	Office		
	Survey purpose	<ul style="list-style-type: none"> <li>• To track energy consumption over time</li> <li>• To collect energy expenditure</li> </ul>		
<b>Data collection</b>	Sample design	Census		
	Sample sources	National census		
	Population description			
	Collection methods	<ul style="list-style-type: none"> <li>• Paper form sent by mail</li> <li>• Internet based</li> </ul>		
	Sample/Population size	120 000 / 120 000	Response rate	100%
	Frequency	Every year		
	Time to complete survey	180 minutes	Mandatory	Yes
	Incentive	A fine		
	Survey respondents	Building operators		
	Elements collected	<ul style="list-style-type: none"> <li>• Main building function</li> <li>• Energy used</li> </ul>		
End uses covered	Water heating			
<b>Comments</b>	Main challenges	Response quality		
	Possible improvements	A need to establish buildings register		
	Key best practice			
	Other documentation			



<b>Background</b>	Country	United States		<b>S/Su/16</b>
	Organisation	Energy Information Administration		
	Name of the survey	Commercial Buildings Energy Consumption Survey		
	Services categories covered	<ul style="list-style-type: none"> <li>• Office</li> <li>• Retail space</li> <li>• Health care</li> <li>• Education</li> <li>• Warehouse</li> </ul>	<ul style="list-style-type: none"> <li>• Food sales</li> <li>• Food service</li> <li>• Lodging</li> <li>• Arts and entertainment</li> <li>• Multipurpose building</li> </ul>	
	Survey purpose	<ul style="list-style-type: none"> <li>• To collect physical building characteristics</li> <li>• To track diffusion of equipment</li> <li>• To track energy consumption over time</li> <li>• To understand building occupant characteristics</li> <li>• To collect energy expenditure</li> </ul>		
<b>Data collection</b>	Sample design	Area-probability sample survey		
	Sample sources	List of addresses		
	Population description	Buildings over 1 000 square feet, excluding agricultural and residential and industrial		
	Collection methods	<ul style="list-style-type: none"> <li>• Paper form sent by mail</li> <li>• Computer-assisted personal interview</li> <li>• Telephone interview</li> </ul>		
	Sample/Population size	5 000 / 4 900 000	Response rate	75%
	Frequency	Every four years		
	Time to complete survey	45 minutes	Mandatory	No
	Incentive	None		
	Survey respondents	Building operators, utility companies		
	Elements collected	<ul style="list-style-type: none"> <li>• Main building function</li> <li>• Building floor area</li> <li>• Building age</li> <li>• Number of occupants/employees</li> <li>• Energy bills from building operator</li> <li>• Energy consumption from energy supplier</li> </ul>	<ul style="list-style-type: none"> <li>• Diffusion of office equipment</li> <li>• Diffusion of lighting by type</li> <li>• Type of renovations</li> <li>• Energy used</li> </ul>	
	End uses covered	<ul style="list-style-type: none"> <li>• Space cooling</li> <li>• Space heating</li> <li>• Water heating</li> </ul>	<ul style="list-style-type: none"> <li>• Office equipment</li> <li>• Lighting</li> <li>• Cooking</li> </ul>	
<b>Comments</b>	Main challenges	<ul style="list-style-type: none"> <li>• Inconsistent responses</li> <li>• Response quality</li> <li>• Quality of the interviewing staff</li> </ul>		
	Possible improvements			
	Key best practice			
	Other documentation	Available: questionnaire, report, URL		

<b>Background</b>	Country	Bosnia and Herzegovina	<b>S/Me/01</b>
	Organisation	Power Utility of the Republic of Srpska	
	Name of the project	Analysis of loads	
	Services categories covered		
	Project purpose	<ul style="list-style-type: none"> <li>• To complement an existing survey or data collection effort with energy consumption data</li> <li>• To complement a model with energy consumption patterns</li> </ul>	
<b>Data collection</b>	Sample design	Simple random sampling	
	Sample sources	List of telephone numbers	
	Population description		
	Equipment used		
	Sample/Population size	2 500 / 528 000	
	Frequency	Every three months	
	Time to collect measurements	Seven days	
	Who took measurements	Energy supplying companies, transmission company, independent system operator	
	End uses measured		
Geo-climatic measurements	Yes		
<b>Comments</b>	Main challenges	Quality control	
	Recommendations	Having a bigger sample size	
	Key best practice		
	Other documentation		

<b>Background</b>	Country	New Zealand	<b>S/Me/02</b>
	Organisation	Energy Efficiency and Conservation Authority	
	Name of the project	Building Energy End-Use Study	
	Services categories covered	<ul style="list-style-type: none"> <li>• Office</li> <li>• Retail space</li> <li>• Food sales</li> <li>• Food service</li> </ul>	<ul style="list-style-type: none"> <li>• Lodging</li> <li>• Arts and entertainment</li> <li>• Multipurpose building</li> </ul>
Project purpose	<ul style="list-style-type: none"> <li>• To measure energy consumption of buildings by service type</li> <li>• To understand occupant equipment utilisation pattern within a building over a given period of time</li> <li>• To understand effectiveness of existing energy efficiency policies and regulations</li> <li>• To measure diffusion and energy consumption from office equipment</li> <li>• To understand seasonal energy consumption of a building</li> <li>• To establish energy efficiency benchmarks within the services sector</li> <li>• To complement an existing survey or data collection effort with energy consumption data</li> <li>• To complement a model with energy consumption patterns</li> </ul>		
<b>Data collection</b>	Sample design	Stratified random sampling approach; a stratified sampling design divided into 50 strata, mainly size, use and geographical groupings.	
	Sample sources	Property Valuation Roll and NZ Building Code definition; an innovative approach based on the use of Internet search, coupled with the use of Google Earth and Street View	
	Population description	This study covers non-residential buildings such as office and retail use. Excluded are industrial and all ancillary and external structures such as boiler houses or parking spaces.	
	Equipment used		
	Sample/Population size	500 / 50 000	
	Frequency	Only conducted once	
	Time to collect measurements	Not available	
	Who took measurements		
End uses measured	<ul style="list-style-type: none"> <li>• Space heating</li> <li>• Water heating</li> <li>• Office equipment</li> <li>• Lighting</li> </ul>		
Geo-climatic measurements			
<b>Comments</b>	Main challenges		
	Recommendations		
	Key best practice		
	Other documentation	For reference please see survey entry	

		S/Me/03
<b>Background</b>	Country	Sweden
	Organisation	Swedish Energy Agency
	Name of the project	STIL2
	Services categories covered	<ul style="list-style-type: none"> <li>• Office</li> <li>• Retail space</li> <li>• Health care</li> <li>• Education</li> <li>• Food sales</li> <li>• Arts and entertainment</li> </ul>
	Project purpose	<ul style="list-style-type: none"> <li>• To measure energy consumption of buildings by service type</li> <li>• To measure diffusion and energy consumption from office equipment</li> <li>• To establish energy efficiency benchmarks within the services sector</li> <li>• To complement an existing survey or data collection effort (energy statistics for non-residential premises) with energy consumption data</li> </ul>
<b>Data collection</b>	Sample design	Stratified random sampling approach
	Sample sources	List from energy supplier, list of addresses, registry of businesses
	Population description	Majority of buildings in one specific geographical area to keep the costs down. Total area of building between 200 and 5 000 m <sup>2</sup> . Majority of area used for the specific activity of the building (office activity, health care, etc.).
	Equipment used	Current meter (data logger)
	Sample/Population size	1 000 / 62 700
	Frequency	The measurements have been conducted for one building type (office, retail, sports centre, health care, etc.) per year. First measurements in 2005.
	Time to collect measurements	1.5 days
	Who took measurements	Energy auditors, building operators
	End uses measured	<ul style="list-style-type: none"> <li>• Space heating</li> <li>• Space cooling</li> <li>• Water heating</li> <li>• Auxiliary motors</li> <li>• Office equipment</li> <li>• Office kitchenette equipment</li> <li>• Lighting</li> <li>• Ventilation, electricity use typical for the specific building types (health care, offices, etc.)</li> </ul>
Geo-climatic measurements	Yes	
<b>Comments</b>	Main challenges	
	Recommendations	It is important to prioritise the planning phase. With good planning, the time for the experts at the site can be minimised and the quality can be improved. In the preparatory phase there was a reference group representing building owners.
	Key best practice	Training and repetition. The same company and in most cases same staffs carried out the whole campaign (six years).
	Other documentation	Available: report

<b>Background</b>	Country	Australia	S/Mo/01
	Organisation	Australian Bureau of Agricultural and Resource Economics — Bureau of Rural Sciences	
	Name of the model		
	Services categories covered	<ul style="list-style-type: none"> <li>• Health care</li> <li>• Education</li> <li>• Food sales</li> </ul>	<ul style="list-style-type: none"> <li>• Food service</li> <li>• Lodging</li> <li>• Arts and entertainment</li> </ul>
Model purpose	To estimate energy consumption in the commercial and services sector by Australian state and fuel type		
<b>Data inputs/outputs</b>	Model type	Top-down econometric model Modelling of the commercial and services sector is done “in-house” using recognised econometric software such as Stata and Eviews	
	Results validated	No	
	Frequency	No regular cycle	
	Key model inputs	<ul style="list-style-type: none"> <li>• Energy prices</li> <li>• Macroeconomic data</li> <li>• Labour force indicators</li> </ul>	
	Key model outputs	Energy consumption by region and fuel type	
<b>Comments</b>	Main challenges	Modelling boundary definition Lack of input data Quality control issues with input data	
	Additional information	The lack of primary source data relating to the commercial and services sector has meant that estimation of energy use in this sector has been based on secondary sources and analysis of the residual energy remaining after the estimates of other sectors’ energy use. The modelling was undertaken with the aim of adding a more thorough estimation framework to guide and improve the consistency of annual estimates. The top-down approach was used to identify price and income elasticities on a case-by-case basis for commercial and services energy consumption for each Australian state and fuel type using a variety of indicators and fairly straightforward econometric techniques. The quality, periodicity and availability of input data limit the sophistication of techniques that can be used for this purpose.	
	Key best practice		
	Other documentation		

<b>Background</b>	<b>Country</b>	Belgium	<b>S/Mo/02</b>
	<b>Organisation</b>	Vision on Technology	
	<b>Name of the model</b>	Assessment of Energy Use Based on Electricity Consumption	
	<b>Services categories covered</b>	<ul style="list-style-type: none"> <li>• Office</li> <li>• Retail space</li> <li>• Health care</li> <li>• Education</li> <li>• Warehouse</li> </ul>	<ul style="list-style-type: none"> <li>• Food sales</li> <li>• Food service</li> <li>• Lodging</li> <li>• Arts and entertainment</li> <li>• Multipurpose building</li> </ul>
	<b>Model purpose</b>	To complement data collected in a survey or other data collection exercises such as supplied electricity and natural gas by the grid operators (yearly mandatory reporting) and monitoring reports of yearly energy consumption of public buildings (city town houses, swimming pools, theatres, etc.)	
<b>Data inputs/outputs</b>	<b>Model type</b>	The approach used is to extrapolate oil use based on the share of electricity surveyed compared with the total electricity supplied. This approach is applied on a sector-by-sector basis, which is defined as per NACE codes.	
	<b>Results validated</b>	No	
	<b>Frequency</b>	Every year	
	<b>Key model inputs</b>	<ul style="list-style-type: none"> <li>• Electricity consumption surveyed per sector</li> <li>• Total electricity supplied to the sector</li> </ul>	
	<b>Key model outputs</b>	Total energy consumption per building	
<b>Comments</b>	<b>Main challenges</b>	Lack of input data	
	<b>Additional information</b>		
	<b>Key best practice</b>		
	<b>Other documentation</b>		

Background	Country	Canada	S/Mo/03
	Organisation	Natural Resources Canada	
	Name of the model	Commercial Energy End-Use Model	
	Services categories covered	<ul style="list-style-type: none"> <li>• Office</li> <li>• Retail space</li> <li>• Health care</li> <li>• Education</li> </ul>	<ul style="list-style-type: none"> <li>• Warehouse</li> <li>• Food service</li> <li>• Lodging</li> <li>• Arts and entertainment</li> </ul>
Model purpose	<ul style="list-style-type: none"> <li>• To estimate building energy consumption</li> <li>• To calculate regional energy consumption profile of buildings by service type</li> <li>• To estimate diffusion of office equipment</li> <li>• To estimate energy consumption of office equipment</li> </ul>		
Data inputs/outputs	Model type	Bottom-up statistical model The modelling tool was developed in-house and undergoes continuous improvements to take into account new or improved data.	
	Results validated	Yes: the <i>Report on Energy Supply and Demand in Canada</i> from Statistics Canada and <i>National Inventory Report</i> from Environment Canada are used for calibration.	
	Frequency	Every year	
	Key model inputs	<ul style="list-style-type: none"> <li>• Space heating system</li> <li>• Space cooling system</li> <li>• Water heating system</li> <li>• Building occupancy</li> </ul>	<ul style="list-style-type: none"> <li>• Office equipment power consumption</li> <li>• Energy prices</li> <li>• Macroeconomic data</li> </ul>
	Key model outputs	<ul style="list-style-type: none"> <li>• Heating energy consumption</li> <li>• Cooling energy consumption</li> <li>• Water heating energy consumption</li> </ul>	<ul style="list-style-type: none"> <li>• Energy consumption of office equipment</li> <li>• Lighting energy consumption</li> <li>• Auxiliary motors</li> </ul>
Comments	Main challenges	Lack of input data	
	Additional information		
	Key best practice		
	Other documentation		

<b>Background</b>	Country	Croatia / Bosnia and Herzegovina	S/Mo/04
	Organisation	Energy Institute Hrvoje Pazar in Croatia	
	Name of the model		
	Services categories covered	<ul style="list-style-type: none"> <li>• Office</li> <li>• Retail space</li> <li>• Health care</li> <li>• Education</li> <li>• Warehouse</li> </ul>	<ul style="list-style-type: none"> <li>• Food sales</li> <li>• Food service</li> <li>• Lodging</li> <li>• Arts and entertainment</li> <li>• Multipurpose building</li> </ul>
<b>Data inputs/outputs</b>	Model type	<ul style="list-style-type: none"> <li>• Bottom-up engineering model</li> <li>• Custom-built model, end-use modelling with MAED tool</li> </ul>	
	Results validated	Yes: calibration with energy balances	
	Frequency	Only conducted once	
	Key model inputs	<ul style="list-style-type: none"> <li>• Space heating system</li> <li>• Space cooling system</li> <li>• Water heating system</li> <li>• Heating, ventilation and air-conditioning (HVAC) system cost</li> </ul>	<ul style="list-style-type: none"> <li>• HVAC life cycle</li> <li>• HVAC energy rating</li> <li>• Building thermal envelope</li> <li>• Building occupancy</li> </ul>
<b>Comments</b>	Key model outputs	<ul style="list-style-type: none"> <li>• Total energy consumption per building</li> <li>• Heating energy consumption</li> <li>• Cooling energy consumption</li> <li>• Water heating energy consumption</li> </ul>	<ul style="list-style-type: none"> <li>• Energy consumption of office equipment</li> <li>• Lighting energy consumption</li> <li>• Auxiliary motors</li> </ul>
	Main challenges		
	Additional information		
	Key best practice		
Other documentation	Available: report		



<b>Background</b>	Country	EU countries: 27 + 2	S/Mo/05
	Organisation	TEP Energy in Switzerland	
	Name of the model	Forecasting Energy Consumption Analysis and Simulation Tool	
	Services categories covered	<ul style="list-style-type: none"> <li>• Office</li> <li>• Retail space</li> <li>• Health care</li> <li>• Education</li> <li>• Warehouse</li> </ul>	<ul style="list-style-type: none"> <li>• Food sales</li> <li>• Food service</li> <li>• Lodging</li> <li>• Arts and entertainment</li> <li>• Multipurpose building</li> </ul>
	Model purpose	<ul style="list-style-type: none"> <li>• To estimate building energy consumption</li> <li>• To calculate regional energy consumption profile of buildings by service type</li> <li>• To estimate energy consumption of office equipment</li> </ul>	
<b>Data inputs/outputs</b>	Model type	<ul style="list-style-type: none"> <li>• Bottom-up statistical model, bottom-up engineering model</li> <li>• Custom-built model</li> </ul>	
	Results validated	Yes: Electricity consumption of EUROSTAT from 1990 to 2010. Iteration process adjusts model parameters to fit both the level and the slope of the electricity consumption by country.	
	Frequency	Every year	
	Key model inputs	<ul style="list-style-type: none"> <li>• Space heating system</li> <li>• Water heating system</li> <li>• HVAC system cost</li> <li>• HVAC life cycle</li> <li>• HVAC energy rating</li> <li>• Building occupancy</li> <li>• Office equipment power consumption</li> </ul>	<ul style="list-style-type: none"> <li>• Technology cost</li> <li>• Technology life cycle</li> <li>• Technology energy efficiency</li> <li>• Energy prices</li> <li>• Macroeconomic data</li> <li>• Number of employees, other energy service diffusion parameters</li> </ul>
	Key model outputs	<ul style="list-style-type: none"> <li>• Total energy consumption per building</li> <li>• Heating energy consumption</li> <li>• Cooling energy consumption</li> <li>• Water heating energy consumption</li> </ul>	<ul style="list-style-type: none"> <li>• Energy consumption of office equipment</li> <li>• Lighting energy consumption</li> <li>• Auxiliary motors</li> <li>• Only electricity is modelled so far</li> </ul>
<b>Comments</b>	Main challenges	<ul style="list-style-type: none"> <li>• Lack of input data</li> <li>• Quality control issues with input data</li> </ul>	
	Additional information	Only electricity so far. Other energies will be included in next modelling exercises.	
	Key best practice	Tapping the amount of available energy-saving potential is chosen according to the cost-effectiveness of respective technologies or practices. Hidden costs and barriers are approximated as well.	
	Other documentation		

<b>Background</b>	<b>Country</b>	Mexico	<b>S/Mo/06</b>
	<b>Organisation</b>	Ministry of Energy	
	<b>Name of the model</b>	Electricity Consumption for Lighting in the Commercial Sector	
	<b>Services categories covered</b>	<ul style="list-style-type: none"> <li>• Office</li> <li>• Retail space</li> <li>• Health care</li> <li>• Education</li> <li>• Warehouse</li> </ul>	<ul style="list-style-type: none"> <li>• Food sales</li> <li>• Food service</li> <li>• Lodging</li> <li>• Arts and entertainment</li> </ul>
	<b>Model purpose</b>	To estimate electricity consumption for lighting by service type	
<b>Data inputs/outputs</b>	<b>Model type</b>	Bottom-up statistical model Estimation done using Excel and SPSS instead of more sophisticated software due to the lack of resources	
	<b>Results validated</b>	Yes: total electricity consumption in the services sector was used to validate the results	
	<b>Frequency</b>	Only conducted once	
	<b>Key model inputs</b>	<ul style="list-style-type: none"> <li>• Building occupancy</li> <li>• Macroeconomic data</li> <li>• Use of a norm or policy set by the government to determine the lighting requirements for each building, according to the number of workers and employees</li> </ul>	
	<b>Key model outputs</b>	Lighting energy consumption	
<b>Comments</b>	<b>Main challenges</b>	<ul style="list-style-type: none"> <li>• Lack of input data</li> <li>• Quality control issues with input data</li> <li>• Choice of assumptions</li> </ul>	
	<b>Additional information</b>		
	<b>Key best practice</b>	Existing economic surveys and administrative records were used to derive final energy consumption estimates.	
	<b>Other documentation</b>		

<b>Background</b>	Country	New Zealand	S/Mo/07
	Organisation	Energy Efficiency and Conservation Authority (EECA)	
	Name of the model	Building Energy End-Use Project EECA End-Use Data Modelling Exercise	
	Services categories covered	<ul style="list-style-type: none"> <li>• Office</li> <li>• Retail space</li> <li>• Food sales</li> <li>• Food service</li> </ul>	<ul style="list-style-type: none"> <li>• Lodging</li> <li>• Arts and entertainment</li> <li>• Multipurpose building</li> </ul>
	Model purpose	<ul style="list-style-type: none"> <li>• To estimate building energy consumption</li> <li>• To calculate regional energy consumption profile of buildings by service type</li> <li>• To estimate energy consumption of office equipment</li> <li>• To complement data collected in a survey or other data collection exercises</li> </ul>	
<b>Data inputs/outputs</b>	Model type	<ul style="list-style-type: none"> <li>• Bottom-up statistical model</li> <li>• Purchased an existing model</li> </ul>	
	Results validated	Yes: the estimates are validated with national New Zealand statistics and other organisations	
	Frequency	Every five years	
	Key model inputs	<ul style="list-style-type: none"> <li>• Technology life cycle</li> <li>• Macroeconomic data</li> <li>• Heating/cooling degree days</li> <li>• Main building function</li> <li>• Building floor area</li> <li>• Building age</li> <li>• Type of renovations</li> <li>• Number of occupants/employees</li> </ul>	<ul style="list-style-type: none"> <li>• Occupancy time patterns</li> <li>• Energy bills from building operator</li> <li>• Energy consumption from energy supplier</li> <li>• Diffusion of office equipment</li> <li>• Number of lights</li> <li>• Diffusion of lighting by type</li> </ul>
	Key model outputs	Space heating energy consumption, space cooling energy consumption, water heating energy consumption, equipment energy consumption, lighting energy consumption	
<b>Comments</b>	Main challenges	<ul style="list-style-type: none"> <li>• Quality control issues with the model</li> <li>• Lack of input data</li> <li>• Quality control issues with input data</li> <li>• Choice of assumptions</li> </ul>	
	Additional information		
	Key best practice		
	Other documentation	Please see entries in residential modelling and services survey	

<b>Background</b>	Country	Spain	<b>S/Mo/08</b>
	Organisation	Instituto para la Diversificación y Ahorro de la Energía	
	Name of the model		
	Services categories covered	<ul style="list-style-type: none"> <li>• Office</li> <li>• Retail space</li> </ul>	<ul style="list-style-type: none"> <li>• Health care</li> <li>• Lodging</li> </ul>
	Model purpose	To estimate building energy consumption	
<b>Data inputs/outputs</b>	Model type	<ul style="list-style-type: none"> <li>• Top-down technological model</li> <li>• Custom-built model which uses input-output tables of the economy to make the breakdown of the total consumption of the sector by branches</li> </ul>	
	Results validated	Yes: in the future results will be validated against outcomes from the hotel and hospital surveys	
	Frequency	Every year	
	Key model inputs	Macroeconomic data	
	Key model outputs	Total energy consumption by sector and source of energy	
<b>Comments</b>	Main challenges	<ul style="list-style-type: none"> <li>• Quality control issues with the model</li> <li>• Lack of input data</li> <li>• Quality control issues with input data</li> </ul>	
	Additional information		
	Key best practice	Comparing economic data with available energy data periodically	
	Other documentation	Available: report	

Background	Country	Switzerland	S/Mo/09
	Organisation	Swiss Federal Office of Energy; TEP Energy	
	Name of the model	Services Energy Consumption Model, SERVE04	
	Services categories covered	<ul style="list-style-type: none"> <li>• Office</li> <li>• Retail space</li> <li>• Health care</li> <li>• Education</li> <li>• Warehouse</li> </ul>	<ul style="list-style-type: none"> <li>• Food sales</li> <li>• Food service</li> <li>• Lodging</li> <li>• Arts and entertainment</li> <li>• Multipurpose building</li> </ul>
	Model purpose	To estimate services energy consumption in general, by end use and by determinant factors. The basic model was developed for energy perspectives, but also serves for the <i>ex post</i> analysis of energy consumption by end use and by determinant factors. The model is calibrated to the Swiss energy balances. Adding statistics (inputs) of the actual year allows getting output in form of end-use data.	
Data inputs/outputs	Model type	Bottom-up energy-economic model, close to bottom-up engineering model but using further inputs. The model is mainly based on administrative data (Federal Office of Statistics, Federal Office of Energy, etc.) but also uses data from utilities, manufacturers. Custom-built model	
	Results validated	Yes: calibration with Swiss energy statistics, cross-check with energy consumption statistics in the industry and services sectors (survey of 12 000 companies)	
	Frequency	Every year	
	Key model inputs	<ul style="list-style-type: none"> <li>• Space heating system</li> <li>• Space cooling system</li> <li>• Water heating system</li> <li>• HVAC life cycle</li> <li>• Building thermal envelope</li> <li>• Building occupancy</li> <li>• Office equipment power consumption</li> </ul>	<ul style="list-style-type: none"> <li>• Technology life cycle</li> <li>• Energy prices</li> <li>• Data from national register of building and dwellings, statistics of value added, job statistics, energy reference area, heating degree days (HDD) &amp; radiation, etc.</li> </ul>
	Key model outputs	<ul style="list-style-type: none"> <li>• Heating energy consumption</li> <li>• Cooling energy consumption</li> <li>• Water heating energy consumption</li> <li>• Energy consumption of office equipment</li> <li>• Lighting energy consumption</li> </ul>	<ul style="list-style-type: none"> <li>• Auxiliary motors</li> <li>• Process heat, information and communications technology (ICT) incl. consumer entertainment electronics</li> </ul>
Comments	Main challenges	<ul style="list-style-type: none"> <li>• Lack of input data</li> <li>• Including new trends whenever possible</li> </ul>	
	Additional information	The analysis of energy consumption by end use is based on the models developed for the energy perspectives. Fifteen years of experience and annual model runs have helped to increase the number of inputs in all fields of data sources.	
	Key best practice		
	Other documentation	Available: report	

<b>Background</b>	Country	United Kingdom	<b>S/Mo/10</b>
	Organisation	Department of Energy and Climate Change	
	Name of the model	Non-Domestic Energy Efficiency Model	
	Services categories covered	<ul style="list-style-type: none"> <li>• Office</li> <li>• Retail space</li> <li>• Health care</li> <li>• Education</li> <li>• Warehouse</li> </ul>	<ul style="list-style-type: none"> <li>• Food sales</li> <li>• Food service</li> <li>• Lodging</li> <li>• Arts and entertainment</li> <li>• Multipurpose building</li> </ul>
	Model purpose	<ul style="list-style-type: none"> <li>• To estimate building energy consumption</li> <li>• To estimate energy consumption of office equipment</li> </ul>	
<b>Data inputs/outputs</b>	Model type	<ul style="list-style-type: none"> <li>• Bottom-up statistical model</li> <li>• Custom-built model</li> </ul>	
	Results validated	Yes: against total energy consumption reported for energy balance purposes	
	Frequency	Every year	
	Key model inputs	<ul style="list-style-type: none"> <li>• Space heating system</li> <li>• Space cooling system</li> <li>• Water heating system</li> </ul>	<ul style="list-style-type: none"> <li>• HVAC system cost</li> <li>• Floor area</li> </ul>
	Key model outputs	<ul style="list-style-type: none"> <li>• Total energy consumption per building</li> <li>• Heating energy consumption</li> <li>• Cooling energy consumption</li> </ul>	<ul style="list-style-type: none"> <li>• Water heating energy consumption</li> <li>• Lighting energy consumption</li> <li>• Auxiliary motors</li> </ul>
<b>Comments</b>	Main challenges	<ul style="list-style-type: none"> <li>• Quality control issues with the model</li> <li>• Lack of input data</li> <li>• Quality control issues with input data</li> </ul>	
	Additional information		
	Key best practice		
	Other documentation		

<b>Background</b>	Country	United States	S/Mo/11
	Organisation	Energy Information Administration	
	Name of the model	Commercial Building Energy Consumption Survey End-Use Model	
	Services categories covered	<ul style="list-style-type: none"> <li>• Office</li> <li>• Retail space</li> <li>• Health care</li> <li>• Education</li> <li>• Warehouse</li> </ul>	<ul style="list-style-type: none"> <li>• Food sales</li> <li>• Food service</li> <li>• Lodging</li> <li>• Arts and entertainment</li> <li>• Multipurpose building</li> </ul>
	Model purpose	To estimate energy consumption of office equipment	
<b>Data inputs/outputs</b>	Model type	<ul style="list-style-type: none"> <li>• Bottom-up statistical model</li> <li>• Bottom-up engineering model</li> <li>• Custom-built model</li> </ul>	
	Results validated	No	
	Frequency	Every four years	
	Key model inputs	<ul style="list-style-type: none"> <li>• Space heating system</li> <li>• Space cooling system</li> <li>• Water heating system</li> <li>• Building thermal envelope</li> </ul>	<ul style="list-style-type: none"> <li>• Building occupancy</li> <li>• Office equipment power consumption</li> <li>• Energy prices</li> </ul>
	Key model outputs	<ul style="list-style-type: none"> <li>• Total energy consumption per building</li> <li>• Heating energy consumption</li> <li>• Cooling energy consumption</li> </ul>	<ul style="list-style-type: none"> <li>• Water heating energy consumption</li> <li>• Energy consumption of office equipment</li> <li>• Lighting energy consumption</li> </ul>
<b>Comments</b>	Main challenges	<ul style="list-style-type: none"> <li>• Boundary issues</li> <li>• Choice of assumptions</li> </ul>	
	Additional information		
	Key best practice		
	Other documentation	Available: URL site with report	

## 3

## Industry

Background	Country	Australia	I/Ad/01
	Organisation	Australian Bureau of Agricultural and Resource Economics (ABARE) – Bureau of Rural Sciences	
	Sectors covered	All manufacturing sectors	
	Data collection purpose	To estimate end-use energy consumption for industry sectors	
Data collection	Sources	<ul style="list-style-type: none"> <li>• National Greenhouse and Energy Reporting system (NGER)</li> <li>• National Electricity Market</li> <li>• Department of Resources, Energy &amp; Trade</li> <li>• Australian Bureau of Statistics</li> </ul>	
	Data collected	<p>Primary survey data are now collected from the NGER undertaken by the Australian Government Department of Climate Change and Energy Efficiency. Previously the survey was collected internally via ABARE's Fuel &amp; Electricity Survey. Supplemental data related to electricity generation are also collected from the National Electricity Market. Petroleum refining and sales data are collected from a survey undertaken by the Australian Government Department of Resources, Energy &amp; Trade. Other secondary source information relating to industries is used on an ad-hoc basis where appropriate. Economic indicators and production data related to industrial processes are obtained from the Australian Bureau of Statistics.</p>	
Comments	Main challenges	<ul style="list-style-type: none"> <li>• Time-consuming to collect data</li> <li>• Needed to establish a Memorandum of Understanding with a given organisation</li> <li>• Definition issues within a sector</li> <li>• A major challenge is to reconcile and harmonise newly collected data with historical time series</li> </ul>	
	Additional observations	<p>Australia has moved to a more centralised energy and GHG data collection framework (NGER). Reporting is now mandated under legislation and is now compulsory for energy users over a certain threshold. These developments have the potential to lead to more informed energy balances and lead to improved policy development. In the short term, significant challenges exist in applying these new data to its existing data set.</p>	



<b>Background</b>	<b>Country</b>	Belgium	<b>I/Ad/02</b>
	<b>Organisation</b>	Vision on Technology	
	<b>Sectors covered</b>	All manufacturing sectors	
	<b>Data collection purpose</b>	To prepare energy balances	
<b>Data collection</b>	<b>Sources</b>	<ul style="list-style-type: none"> <li>• Energy utilities (gas, oil, electricity, other)</li> <li>• National or international associations and organisations</li> </ul>	
	<b>Data collected</b>	Supplied electricity and natural gas by the grid providers; per sector and annual energy data from benchmark and audited companies (companies with primary energy consumption higher than 0.1 petajoules [PJ]); installation and energy data on co-generation; renewable electricity installations that receive certificates	
<b>Comments</b>	<b>Main challenges</b>	Confidentiality issues	
	<b>Additional observations</b>	This survey is performed only for the Flemish energy balances	

<b>Background</b>	<b>Country</b>	Bosnia and Herzegovina	<b>I/Ad/03</b>
	<b>Organisation</b>	Ministry of Industry, Energy and Mining of Republic of Srpska	
	<b>Sectors covered</b>	All manufacturing sectors	
	<b>Data collection purpose</b>	To collect energy consumption data by sub-sector	
<b>Data collection</b>	<b>Sources</b>	<ul style="list-style-type: none"> <li>• Government statistics office</li> <li>• Energy utilities (gas, oil, electricity, other)</li> <li>• Manufacturers</li> </ul>	
	<b>Data collected</b>	Consumption of natural gas, electricity, thermal energy, petroleum and petroleum products by 13 sub-sectors (iron and steel, chemical and petrochemical, non-ferrous metals, non-metallic minerals, transport equipment, machinery, mining and quarrying, food and tobacco, paper pulp and print, wood and wood products, construction, textile and leather, non-specified)	
<b>Comments</b>	<b>Main challenges</b>	<ul style="list-style-type: none"> <li>• Time-consuming to collect data</li> <li>• In paper format - difficult to transfer to digital format</li> <li>• Data were incomplete</li> </ul>	
	<b>Additional observations</b>	Some data are estimated	

<b>Background</b>	<b>Country</b>	Canada	<b>I/Ad/04</b>
	<b>Organisation</b>	Natural Resources Canada (NRCan)	
	<b>Sectors covered</b>	<ul style="list-style-type: none"> <li>• Aluminium</li> <li>• Iron and steel</li> <li>• Cement</li> <li>• Pulp and paper</li> <li>• Chemicals</li> </ul>	<ul style="list-style-type: none"> <li>• Mining, construction, forestry</li> <li>• All other manufacturing sectors</li> </ul>
	<b>Data collection purpose</b>	To derive all energy end-use and physical production data from these external sources	
<b>Data collection</b>	<b>Sources</b>	<ul style="list-style-type: none"> <li>• Report on Energy Supply and Demand in Canada (Statistics Canada)</li> <li>• Industrial Consumption of Energy Survey (Statistics Canada)</li> <li>• Canadian Industrial Energy End-Use Data and Analysis Centre</li> <li>• Annual Census of Mines (NRCan)</li> <li>• A private consultant (Informetrica)</li> </ul>	
	<b>Data collected</b>	Fuel use and activity data for industry	
<b>Comments</b>	<b>Main challenges</b>	<ul style="list-style-type: none"> <li>• High cost to obtain data</li> <li>• Needed to establish a Memorandum of Understanding with a given organisation</li> </ul>	
	<b>Additional observations</b>		

<b>Background</b>	<b>Country</b>	Israel*	<b>I/Ad/05</b>
	<b>Organisation</b>	Central Bureau of Statistics	
	<b>Sectors covered</b>	Pulp and paper	
	<b>Data collection purpose</b>	To prepare energy balances and related publications	
<b>Collection</b>	<b>Sources</b>	Manufacturers	
	<b>Data collected</b>	Energy consumption and transformation data	
<b>Comments</b>	<b>Main challenges</b>		
	<b>Additional observations</b>		

\* See Annex F.

<b>Background</b>	Country	Italy	I/Ad/06
	Organisation	Italian National Agency for New Technologies, Energy and Sustainable Economic Development	
	Sectors covered	<ul style="list-style-type: none"> <li>• Iron and steel</li> <li>• Cement</li> </ul>	
	Data collection purpose	To estimate energy consumption and to elaborate indicators	
<b>Collection</b>	Sources	<ul style="list-style-type: none"> <li>• Government statistics office</li> <li>• Energy utilities (gas, oil, electricity, other)</li> </ul>	
	Data collected	Physical production and electricity consumption for specific products	
<b>Comments</b>	Main challenges	<ul style="list-style-type: none"> <li>• Time-consuming to collect data</li> <li>• Confidentiality of the sources</li> </ul>	
	Additional observations		

<b>Background</b>	<b>Country</b>	Korea	<b>I/Ad/07</b>
	<b>Organisation</b>	Korea National Oil Corporation	
	<b>Sectors covered</b>	All manufacturing sectors	
	<b>Data collection purpose</b>	To build national oil supply-and-demand statistics	
<b>Collection</b>	<b>Sources</b>	Manufacturers	
	<b>Data collected</b>	Imports; exports; sales; production; stocks of crude oil and final oil products	
<b>Comments</b>	<b>Main challenges</b>	<ul style="list-style-type: none"> <li>• In paper format — difficult to transfer to digital format</li> <li>• Definition issues within a sector</li> </ul>	
	<b>Additional observations</b>		

<b>Background</b>	<b>Country</b>	Spain	<b>I/Ad/08</b>
	<b>Organisation</b>	Instituto para la Diversificación y Ahorro de la Energía	
	<b>Sectors covered</b>	<ul style="list-style-type: none"> <li>● Iron and steel</li> <li>● Cement</li> <li>● Pulp and paper</li> </ul>	<ul style="list-style-type: none"> <li>● Chemicals</li> <li>● All manufacturing sectors</li> </ul>
	<b>Data collection purpose</b>	<ul style="list-style-type: none"> <li>● To determine final energy consumption by energy source and industry branch</li> <li>● To determine unit energy (and electricity) consumption referred to the physical production</li> <li>● To determine the energy intensity of both the industry sector as a whole and the industry branches</li> </ul>	
<b>Data collection</b>	<b>Sources</b>	<ul style="list-style-type: none"> <li>● Government Statistics Office</li> <li>● Energy utilities (gas, oil, electricity, other)</li> <li>● National or international associations and organisations</li> </ul>	
	<b>Data collected</b>	<ul style="list-style-type: none"> <li>● Ministry of Economy and Finance, Spanish Statistics Office: accounting data, index of industrial production</li> <li>● Sectoral associations of most energy-intensive industry branches, such as iron, steel, paper and cement: Data on physical production and energy consumption</li> <li>● Ministerio de Industria, Energía y Turismo: data for energy balances (by source and sector)</li> </ul>	
<b>Comments</b>	<b>Main challenges</b>	<ul style="list-style-type: none"> <li>● Time-consuming to collect data</li> <li>● Definition issues within a sector</li> <li>● Data were incomplete</li> <li>● Information deficiencies in some sectors</li> <li>● Differences between the breakdown of the energy consumptions and the NACE classification</li> </ul>	
	<b>Additional observations</b>	Collaboration with the industry associations is needed to evaluate the process-level energy consumption of the different industry branches	

<b>Background</b>	<b>Country</b>	Turkey	<b>I/Ad/09</b>
	<b>Organisation</b>	General Directorate of Electrical Power Resources Survey and Development Administration	
	<b>Sectors covered</b>	<ul style="list-style-type: none"> <li>• Iron and steel</li> <li>• All other manufacturing sectors</li> </ul>	
	<b>Data collection purpose</b>	<ul style="list-style-type: none"> <li>• To verify energy consumption for plants of over 1 kilotonne of oil equivalent (ktoe) driven by the Energy Efficiency Law</li> <li>• To calculate energy efficiency indicators</li> <li>• To feed data into energy demand model</li> </ul>	
<b>Collection</b>	<b>Sources</b>	Manufacturers	
	<b>Data collected</b>	Annual energy consumption by plants consuming over 1 ktoe	
<b>Comments</b>	<b>Main challenges</b>	<ul style="list-style-type: none"> <li>• Time-consuming to collect data</li> <li>• Data were incomplete</li> </ul>	
	<b>Additional observations</b>		



<b>Background</b>	<b>Country</b>	United Kingdom – International Organisation	<b>I/Ad/10</b>
	<b>Organisation</b>	International Aluminium Institute	
	<b>Sectors covered</b>	Aluminium	
	<b>Data collection purpose</b>	To estimate GHG emissions of the aluminium sector through modelling, which is used for life-cycle assessment, and global performance tracking	
<b>Collection</b>	<b>Sources</b>	National or international associations and organisations	
	<b>Data collected</b>	Process efficiency and power/fuel source	
<b>Comments</b>	<b>Main challenges</b>	<ul style="list-style-type: none"> <li>• Time-consuming to collect data</li> <li>• Took a long time to establish a relationship with the organisation</li> <li>• Definition issues within a sector</li> </ul>	
	<b>Additional observations</b>		

<b>Background</b>	<b>Country</b>	United Kingdom	<b>I/Ad/11</b>
	<b>Organisation</b>	Department of Energy and Climate Change	
	<b>Sectors covered</b>	All manufacturing sectors	
	<b>Data collection purpose</b>	<ul style="list-style-type: none"> <li>• To compile the energy balance</li> <li>• To allocate aggregate energy consumption data into different branches</li> </ul>	
<b>Collection</b>	<b>Sources</b>	<ul style="list-style-type: none"> <li>• Energy utilities (gas, oil, electricity, other)</li> <li>• Manufacturers</li> </ul>	
	<b>Data collected</b>	Energy suppliers provide data on the amount of energy produced and supplied to final consumers by sector. This is supplemented with data on combined heat and power.	
<b>Comments</b>	<b>Main challenges</b>	<ul style="list-style-type: none"> <li>• Time-consuming to collect data</li> <li>• Definition issues within a sector</li> </ul>	
	<b>Additional observations</b>		

<b>Background</b>	<b>Country</b>	United States	I/Ad/12
	<b>Organisation</b>	Lawrence Berkeley National Laboratory	
	<b>Sectors covered</b>	<ul style="list-style-type: none"> <li>• Iron and steel</li> <li>• Cement</li> <li>• Pulp and paper</li> <li>• All other manufacturing sectors</li> </ul>	
	<b>Data collection purpose</b>		
<b>Data collection</b>	<b>Sources</b>	<ul style="list-style-type: none"> <li>• Government Statistics Office</li> <li>• U.S. Department of Energy (DOE)</li> <li>• California Energy Commission</li> <li>• California Air Resources Board</li> <li>• Energy utilities (gas, oil, electricity, other)</li> <li>• Manufacturers</li> </ul>	
	<b>Data collected</b>	Statistics on annual energy use by fuel and process; data on GHG emissions and fuel sources for various industries	
<b>Comments</b>	<b>Main challenges</b>	<ul style="list-style-type: none"> <li>• Time-consuming to collect data</li> <li>• Many data points crossed off due to confidentiality of the sources</li> <li>• In paper format — difficult to transfer to digital format</li> <li>• Definition issues within a sector</li> <li>• Data were incomplete</li> </ul>	
	<b>Additional observations</b>	Data quality and comprehensiveness can vary between surveys, depending on funding levels. US DOE data are only issued every four to five years, so there is a considerable lag in the more detailed data from the Manufacturing Energy Consumption Survey which is critical for modelling industrial fuel and end use values.	

Background	Country	Australia	I/Su/01	
	Organisation	Australian Bureau of Statistics		
	Name of the survey	Energy, Water and Environment Survey		
	Sectors covered	Covered whole economy excluding the following Australian and New Zealand Standard Industrial Classification (ANZSIC) subdivisions: <ul style="list-style-type: none"> <li>• 01 Agriculture</li> <li>• 28 Water supply, sewerage and drainage services</li> <li>• 63 Insurance</li> <li>• 75 Public administration</li> <li>• 76 Defence</li> <li>• 62 Finance</li> </ul>		
	Economic activity classification	Australian and New Zealand Standard Industrial Classification (ANZSIC)		
	Survey purpose	<ul style="list-style-type: none"> <li>• To track energy consumption of the industry over time</li> <li>• To track industry's physical output over time</li> </ul>		
Data collection	Sample design	Stratified random sampling approach		
	Sample sources	Australian Business Register (maintained by Australian Tax Office)		
	Population description	This survey shares a common sample with the ABS annual Economic Activity Survey. The Economic Activity Survey is used to derive estimates of the economic and financial performance of Australian industry and results were published in <i>Australian Industry, 2008-09</i> . The businesses that contribute to the statistics in this publication are classified: by institutional sector, in accordance with the Standard Institutional Sector Classification of Australia, which is detailed in Standard Economic Sector Classifications of Australia by industry, in accordance with ANZSIC by business size.		
	Collection methods	<ul style="list-style-type: none"> <li>• Paper form sent by mail</li> <li>• Personal interview (testing)</li> </ul>		
	Sample/Population size	14 400 / 1 001 000	Response rate	89%
	Frequency	Every three years		
	Time to complete survey	118 minutes	Mandatory	Yes
	Incentive	A fine		
	Survey respondents	Businesses as defined in sectors covered		
Elements collected	<ul style="list-style-type: none"> <li>• Total energy consumption of a facility</li> <li>• Energy sources</li> </ul>			
Comments	Main challenges	<ul style="list-style-type: none"> <li>• Inconsistent responses</li> <li>• Response quality</li> </ul>		
	Possible improvements	Higher level of data confrontation, improved clarity, detail of "other fuels" question through more targeted field testing		
	Key best practice			
	Other documentation	Available: questionnaires		

<b>Background</b>	Country	Austria	<b>I/Su/02</b>	
	Organisation	Statistics Austria		
	Name of the survey	Energy consumption of small and medium-sized enterprises in the industry		
	Sectors covered	<ul style="list-style-type: none"> <li>Aluminium</li> <li>Iron and steel</li> <li>Cement</li> </ul>	<ul style="list-style-type: none"> <li>Pulp and paper</li> <li>Chemicals</li> <li>All other manufacturing sectors</li> </ul>	
	Economic activity classification	NACE (Statistical Classification of Economic Activities in the European Community)		
	Survey purpose	<ul style="list-style-type: none"> <li>To track energy consumption of the industry over time</li> <li>To complement another data collection initiative</li> </ul>		
<b>Data collection</b>	Sample design	Stratified random sampling approach		
	Sample sources	Business register		
	Population description	Small and medium-sized industrial establishments with more than three employees and not included in the sample of the Material Input Statistics		
	Collection methods	<ul style="list-style-type: none"> <li>Paper form sent by mail</li> <li>Internet based</li> </ul>		
	Sample/Population size	3 000 / 30 041	Response rate	28%
	Frequency	Every two years		
	Time to complete survey	Not available	Mandatory	No
	Incentive	None		
	Survey respondents	Establishments		
	Elements collected	<ul style="list-style-type: none"> <li>Total energy consumption of a facility</li> <li>Energy use by type of end use</li> </ul>		
<b>Comments</b>	Main challenges	<ul style="list-style-type: none"> <li>Low response rate</li> <li>Inconsistent responses</li> <li>Response quality</li> </ul>		
	Possible improvements	Larger sample, face-to-face interview		
	Key best practice	Small and simple questionnaire (only one A4 page) to increase the response rate, including both quantities and monetary values for a cross-reference, the online version of the questionnaire including automated checks. Inconsistent and incomplete questionnaires cannot be submitted (e.g. electricity and at least one fuel for space heating have to be filled in).		
	Other documentation	Available: report and questionnaire		

<b>Background</b>	Country	Belgium	<b>I/Su/03</b>	
	Organisation	Vision on Technology		
	Name of the survey	Yearly energy consumption for the Flemish energy balance		
	Sectors covered	All manufacturing sectors		
	Economic activity classification	NACE		
	Survey purpose	To track energy consumption of the industry over time		
<b>Data collection</b>	Sample design	A repeating panel of respondents that has been interviewed previously for other surveys		
	Sample sources	List of addresses		
	Population description			
	Collection methods	<ul style="list-style-type: none"> <li>• Paper form sent by mail</li> <li>• Internet based</li> </ul>		
	Sample size	2 000		
	Frequency	Every year		
	Time to complete survey	Not available	Mandatory	No
	Incentive	None		
	Survey respondents	Operating facility		
	Elements collected	<ul style="list-style-type: none"> <li>• Total energy consumption of a facility</li> <li>• Energy sources</li> <li>• Non-energy use (e.g. feedstocks)</li> </ul>		
<b>Comments</b>	Main challenges			
	Possible improvements			
	Key best practice			
	Other documentation			

<b>Background</b>	<b>Country</b>	Belgium – International Industry Association		<b>I/Su/04</b>
	<b>Organisation</b>	European Committee of Domestic Equipment Manufacturers (CECED)		
	<b>Name of the survey</b>	Energy label data		
	<b>Sectors covered</b>	Household appliances manufacturers		
	<b>Economic activity classification</b>			
	<b>Survey purpose</b>	<ul style="list-style-type: none"> <li>• To track energy consumption of the industry over time</li> <li>• To set industry energy efficiency benchmarks</li> <li>• To track industry's physical output over time</li> <li>• To evaluate effectiveness of programmes and policies</li> </ul>		
<b>Data collection</b>	<b>Sample design</b>	Census		
	<b>Sample sources</b>			
	<b>Population description</b>	All companies directly associated with CECED		
	<b>Collection methods</b>	Paper form sent by mail		
	<b>Sample/Population size</b>	Not available	Response rate	100%
	<b>Frequency</b>	Every year		
	<b>Time to complete survey</b>	16 hours	Mandatory	No
	<b>Incentive</b>	None		
	<b>Survey respondents</b>			
<b>Elements collected</b>	Energy use by type of end use			
<b>Comments</b>	<b>Main challenges</b>	<ul style="list-style-type: none"> <li>• Incomplete survey</li> <li>• Respect deadline to provide data</li> </ul>		
	<b>Possible improvements</b>	Getting more participants and having a faster data delivery.		
	<b>Key best practice</b>	The innovative idea was to involve all members of the association in the data collection. Covering the cost of their participation can give value to all the participants.		
	<b>Other documentation</b>	Available: questionnaire		

<b>Background</b>	<b>Country</b>	Belgium – International Industry Association		<b>I/Su/05</b>
	<b>Organisation</b>	Confederation of the European Paper Industry		
	<b>Name of the survey</b>	Annual Statistic Questionnaire		
	<b>Sectors covered</b>	Pulp and paper		
	<b>Economic activity classification</b>	NACE		
	<b>Survey purpose</b>	<ul style="list-style-type: none"> <li>• To track energy consumption of the industry over time</li> <li>• To track industry's physical output over time</li> <li>• To identify type of energy used, emissions, raw materials used</li> </ul>		
<b>Data collection</b>	<b>Sample design</b>	Census		
	<b>Sample sources</b>			
	<b>Population description</b>	Industrial plants for the production of pulp from timber or other fibrous materials; paper and board		
	<b>Collection methods</b>	Questionnaire in electronic format sent by email		
	<b>Sample/Population size</b>	19 / 19	<b>Response rate</b>	95%
	<b>Frequency</b>	Every year		
	<b>Time to complete survey</b>	60 minutes	<b>Mandatory</b>	No
	<b>Incentive</b>	Free access to the statistics for the members and annual reports.		
	<b>Survey respondents</b>	Operating facilities of the national associations		
<b>Elements collected</b>	<ul style="list-style-type: none"> <li>• Total energy consumption of a facility</li> <li>• Production volumes by type of product</li> <li>• Energy sources</li> <li>• Non-energy use (e.g. feedstocks)</li> </ul>			
<b>Comments</b>	<b>Main challenges</b>	<ul style="list-style-type: none"> <li>• Incomplete survey</li> <li>• Inconsistent responses</li> <li>• Response quality</li> </ul>		
	<b>Possible improvements</b>	Structured content, fewer revisions, decreasing time to complete the survey		
	<b>Key best practice</b>	Common understanding and definitions through harmonisation		
	<b>Other documentation</b>	Available: questionnaire		



<b>Background</b>	Country	Belgium – International Industry Association		<b>I/Su/06</b>
	Organisation	World Steel Association		
	Name of the survey	Energy use in steelmaking		
	Sectors covered	Iron and steel		
	Economic activity classification			
	Survey purpose	<ul style="list-style-type: none"> <li>• To track energy consumption of the industry over time</li> <li>• To derive energy intensity (energy per unit of production) for all upstream processes developed in-house</li> </ul>		
<b>Data collection</b>	Sample design	Members of the association who participate voluntarily		
	Sample sources			
	Population description	All steel-producing members covering about 50% of the global production		
	Collection methods	<ul style="list-style-type: none"> <li>• Internet based</li> <li>• Telephone interview</li> </ul>		
	Sample/Population size	45 / 108	Response rate	35%
	Frequency	No regular survey cycle		
	Time to complete survey	6 hours	Mandatory	No
	Incentive	None		
	Survey respondents	Operating facility		
Elements collected	<ul style="list-style-type: none"> <li>• Energy use at various stages of production</li> <li>• Total energy consumption of a facility</li> </ul>			
<b>Comments</b>	Main challenges	<ul style="list-style-type: none"> <li>• Low participation</li> <li>• Boundaries and definitions</li> <li>• Complex questionnaire</li> </ul>		
	Possible improvements	Reduce redundant information requests or make it at a higher level		
	Key best practice	Using MS Excel with macros since it is easier to learn how to complete the survey via Excel, which also provides simple and transparent data tracing and detects errors easily		
	Other documentation	Available: report and questionnaire		

<b>Background</b>	Country	Bosnia and Herzegovina	<b>I/Su/07</b>	
	Organisation	Ministry of Industry, Energy and Mining of Republic of Srpska		
	Name of the survey			
	Sectors covered	All manufacturing sectors		
	Economic activity classification	NACE		
	Survey purpose	To track energy consumption of the industry over time		
<b>Data collection</b>	Sample design	According to certain characteristics		
	Sample sources			
	Population description			
	Collection methods	<ul style="list-style-type: none"> <li>• Paper form sent by mail</li> <li>• Internet based</li> <li>• Telephone interview</li> </ul>		
	Sample/Population size	Not available	Response rate	90%
	Frequency	Every year		
	Time to complete survey	Not available	Mandatory	Yes
	Incentive	None		
	Survey respondents	Operating facility, utility company, engineering group, accounting firm		
Elements collected	Total energy consumption of a facility Energy sources			
<b>Comments</b>	Main challenges	Incomplete survey Response quality		
	Possible improvements			
	Key best practice			
	Other documentation	Available: questionnaire, URL link		

<b>Background</b>	Country	Canada	<b>I/Su/08</b>	
	Organisation	Natural Resources Canada		
	Name of the survey	Industrial Consumption of Energy Survey		
	Sectors covered	<ul style="list-style-type: none"> <li>• Aluminium</li> <li>• Iron and steel</li> <li>• Cement</li> <li>• Pulp and paper</li> <li>• Chemicals</li> <li>• Mining, construction, forestry</li> <li>• All other manufacturing sectors</li> </ul>		
	Economic activity classification	North American Industry Classification System (NAICS)		
	Survey purpose	To track energy consumption of the industry over time		
<b>Data collection</b>	Sample design	Stratified random sampling approach		
	Sample sources			
	Population description	All manufacturers (establishments in NAICS 31, 32 and 33)		
	Collection methods	Paper form sent by mail		
	Sample/Population size	4 613 / 90 000	Response rate	84%
	Frequency	Every year		
	Time to complete survey	45 minutes	Mandatory	Yes
	Incentive	None		
	Survey respondents			
Elements collected	<ul style="list-style-type: none"> <li>• Total energy consumption of a facility</li> <li>• Energy sources</li> <li>• Non-energy use (e.g. feedstocks)</li> </ul>			
<b>Comments</b>	Main challenges	Inconsistent responses		
	Possible improvements	A working group has been established to discuss ways to improve the survey		
	Key best practice			
	Other documentation	Available: questionnaire		

<b>Background</b>	<b>Country</b>	Canada – National Industry Association		<b>I/Su/09</b>
	<b>Organisation</b>	Forest Products Association of Canada (FPAC)		
	<b>Name of the survey</b>	FPAC Pulp and Paper Sector Energy Survey		
	<b>Sectors covered</b>	Pulp and paper		
	<b>Economic activity classification</b>	North American Industry Classification System		
	<b>Survey purpose</b>	<ul style="list-style-type: none"> <li>• To track energy consumption of the industry over time</li> <li>• To determine process efficiencies within an industry</li> <li>• To calculate GHG emissions</li> </ul>		
<b>Data collection</b>	<b>Sample design</b>	Census		
	<b>Sample sources</b>	Internal database updated via industry input, sector directories and company websites		
	<b>Population description</b>	All mills producing primary pulp and paper products (excludes converting facilities)		
	<b>Collection methods</b>	Internet based		
	<b>Sample/Population size</b>	100 / 100	<b>Response rate</b>	75%
	<b>Frequency</b>	Every year		
	<b>Time to complete survey</b>	20 minutes	<b>Mandatory</b>	No
	<b>Incentive</b>	Non-cash incentives		
	<b>Survey respondents</b>	Operating facility		
	<b>Elements collected</b>	<ul style="list-style-type: none"> <li>• Total energy consumption of a facility</li> <li>• Energy use at various stages of production</li> <li>• Production volumes by type of product</li> <li>• Energy sources</li> </ul>		
<b>Comments</b>	<b>Main challenges</b>	<ul style="list-style-type: none"> <li>• Low response rate</li> <li>• Incomplete survey</li> <li>• Response quality</li> </ul>		
	<b>Possible improvements</b>	Quality assurance and quality control should be conducted to ensure highly reliable data		
	<b>Key best practice</b>	Survey is Internet based, which is accessible to multiple users per participating facility. This platform also partially optimises the quality assurance work and data analysis.		
	<b>Other documentation</b>	Available: questionnaire		

<b>Background</b>	Country	Croatia / Bosnia and Herzegovina	<b>I/Su/10</b>	
	Organisation	Energy Institute Hrvoje Pozar		
	Name of the survey	Energy consumption survey in Bosnia and Herzegovina		
	Sectors covered	<ul style="list-style-type: none"> <li>Aluminium</li> <li>Iron and steel</li> <li>Cement</li> </ul>	<ul style="list-style-type: none"> <li>Pulp and paper</li> <li>Chemicals</li> <li>All other manufacturing sectors</li> </ul>	
	Economic activity classification	NACE		
	Survey purpose	<ul style="list-style-type: none"> <li>To track energy consumption of the industry over time</li> <li>To set industry energy efficiency benchmarks</li> <li>To complement another data collection initiative</li> </ul>		
<b>Data collection</b>	Sample design	Selection of the largest energy consumers whose total consumption amounts to 85% of total industry energy consumption (taking into account electricity and natural gas consumption)		
	Sample sources	List from tax agency (e.g. municipal, regional), list of addresses		
	Population description			
	Collection methods	On-site interviewing		
	Sample/Population size	900 / 12 000	Response rate	90%
	Frequency	Only conducted once		
	Time to complete survey	90 minutes		
	Incentive			
	Survey respondents	Utility companies		
Elements collected	<ul style="list-style-type: none"> <li>Total energy consumption of a facility</li> <li>Energy use at various stages of production</li> <li>Energy use by type of end use</li> <li>Energy sources</li> <li>Non-energy use (e.g. feedstocks)</li> <li>Age of the system/equipment</li> </ul>			
<b>Comments</b>	Main challenges	<ul style="list-style-type: none"> <li>Incomplete survey</li> <li>Inconsistent responses</li> <li>Response quality</li> </ul>		
	Possible improvements	Carrying out the survey by experienced market research companies		
	Key best practice			
	Other documentation	Available: questionnaire		

<b>Background</b>	Country	Czech Republic	<b>I/Su/11</b>	
	Organisation	Ministry of Industry and Trade (MIT)		
	Name of the survey	Statistical reports of the Czech Statistics Office line and MIT line		
	Sectors covered	<ul style="list-style-type: none"> <li>Aluminium</li> <li>Iron and steel</li> <li>Cement</li> </ul>	<ul style="list-style-type: none"> <li>Pulp and paper</li> <li>Chemicals</li> <li>All other manufacturing sectors</li> </ul>	
	Economic activity classification	NACE		
	Survey purpose	<ul style="list-style-type: none"> <li>To track energy consumption of the industry over time</li> <li>To determine process efficiencies within an industry</li> <li>To track industry's physical output over time</li> <li>To calculate GHG emissions</li> </ul>		
<b>Data collection</b>	Sample design	According to certain characteristics		
	Sample sources	Business register		
	Population description	All companies producing selected goods and with 20 or more employees		
	Collection methods	<ul style="list-style-type: none"> <li>Paper form sent by mail</li> <li>Internet based</li> </ul>		
	Sample size	22 500	Response rate	80%
	Frequency	Every year		
	Time to complete survey	80 minutes	Mandatory	Yes
	Incentive	A fine		
	Survey respondents	Active enterprises		
	Elements collected	<ul style="list-style-type: none"> <li>Total energy consumption of a facility</li> <li>Production volumes by type of product</li> <li>Energy sources</li> <li>Non-energy use (e.g. feedstocks)</li> </ul>		
<b>Comments</b>	Main challenges	<ul style="list-style-type: none"> <li>Low response rate</li> <li>Incomplete survey</li> <li>Inconsistent responses</li> <li>Response quality</li> <li>Lack of resources</li> </ul>		
	Possible improvements	Improved communication with respondents, better fund allocation		
	Key best practice	Long-term relationship with energy managers within enterprises of interest		
	Other documentation	Available: URL		

<b>Background</b>	Country	France	<b>I/Su/12</b>	
	Organisation	Ministry of Ecology, Sustainable Development, Transport and Housing		
	Name of the survey	Energy Consumption in Industry		
	Sectors covered			
	Economic activity classification	NACE, NCE: energy consumption classification (a French classification)		
	Survey purpose	To track energy consumption of the industry over time		
<b>Data collection</b>	Sample design	<ul style="list-style-type: none"> <li>• Census for the following facilities:</li> <li>• Industry (apart from food industry) facilities with more than 500 employees</li> <li>• Facilities with more than 20 employees in industries where the consumption of energy is high</li> <li>• Facilities with more than ten employees in the industrial gas industry</li> </ul>		
	Sample sources	Surveys carried out in previous year. The SIRENE directory is created from several sources: tax files and statistical surveys		
	Population description	Population is selected using the following three criteria: <ul style="list-style-type: none"> <li>• Facilities whose main activity belongs to list of NACE codes</li> <li>• A manufacturing activity exists inside the facility</li> <li>• The number of employees (see sample design)</li> </ul>		
	Collection methods	Internet based		
	Sample/Population size	12 000 / 24 000	Response rate	88%
	Frequency	Every year		
	Time to complete survey	60 minutes	Mandatory	Yes
	Incentive	A fine (practically, not charged)		
	Survey respondents	Operating facility		
	Elements collected	<ul style="list-style-type: none"> <li>• Total energy consumption of a facility</li> <li>• Energy use by type of end use</li> <li>• Energy sources</li> <li>• Non-energy use (e.g. feedstocks)</li> <li>• Type of tariffs for electricity and gas (regulated, non-regulated)</li> </ul>		
<b>Comments</b>	Main challenges	<ul style="list-style-type: none"> <li>• Incomplete survey</li> <li>• Response quality</li> </ul>		
	Possible improvements			
	Key best practice			
	Other documentation	Available: report and questionnaire		

<b>Background</b>	Country	Indonesia	<b>I/Su/13</b>	
	Organisation	Bandung Institute of Technology		
	Name of the survey	Energy survey		
	Sectors covered	All manufacturing sectors		
	Economic activity classification	International Standard Industrial Classification		
	Survey purpose	<ul style="list-style-type: none"> <li>• To track energy consumption of the industry over time</li> <li>• To set industry energy efficiency benchmarks</li> <li>• To determine process efficiencies within an industry</li> <li>• To track industry's physical output over time</li> <li>• To understand operational costs within an industry (e.g. energy and labour costs)</li> <li>• To calculate GHG emissions</li> <li>• To evaluate effectiveness of programmes and policies</li> <li>• To complement another data collection initiative</li> </ul>		
<b>Data collection</b>	Sample design	Stratified random sampling approach; rotating sample of respondents		
	Sample sources			
	Population description			
	Collection methods	<ul style="list-style-type: none"> <li>• Paper form sent by mail</li> <li>• Computer-assisted personal interview</li> </ul>		
	Sample/Population size	2 900 / 25 000		
	Frequency	Every year		
	Time to complete survey	Not available	Mandatory	Yes
	Incentive	No penalty		
	Survey respondents	Energy auditors		
Elements collected	<ul style="list-style-type: none"> <li>• Total energy consumption of a facility</li> <li>• Energy use at various stages of production</li> <li>• Energy use by type of end use</li> <li>• Production volumes by type of product</li> <li>• Energy sources</li> <li>• Non-energy use (e.g. feedstocks)</li> <li>• Age of the system/equipment</li> </ul>			
<b>Comments</b>	Main challenges			
	Possible improvements			
	Key best practice			
	Other documentation			



<b>Background</b>	Country	Kazakhstan		I/Su/14
	Organisation	Kazakhstan Agency of Statistics		
	Name of the survey			
	Sectors covered	All manufacturing sectors		
	Economic activity classification	NACE		
	Survey purpose	<ul style="list-style-type: none"> <li>To track energy consumption of the industry over time</li> <li>To track industry's physical output over time</li> </ul>		
<b>Data collection</b>	Sample design	According to certain characteristics		
	Sample sources			
	Population description	Representative entities with the primary and secondary activities under manufacturing (NACE codes 05-33, 35-39)		
	Collection methods	Paper form sent by mail		
	Sample/Population size	31 386 / 153 610	Response rate	20%
	Frequency	Every year		
	Time to complete survey	110 minutes	Mandatory	Yes
	Incentive	A fine		
	Survey respondents	Operating facility		
	Elements collected	<ul style="list-style-type: none"> <li>Total energy consumption of a facility</li> <li>Production volumes by type of product</li> </ul>		
<b>Comments</b>	Main challenges			
	Possible improvements	<ul style="list-style-type: none"> <li>Organising meetings with a working group to improve energy statistics on a regular basis. The working group is composed of representatives from ministries, departments, research organisations and national companies</li> <li>Using administrative data to monitor the businesses</li> </ul>		
	Key best practice	<ul style="list-style-type: none"> <li>Working with international experts to improve the national energy statistical system</li> <li>Conducting regional trainings with the data respondents to highlight how to properly fill out national energy statistics questionnaires</li> </ul>		
	Other documentation	Available: questionnaire		

<b>Background</b>	Country	Korea		I/Su/15
	Organisation	Korea Energy Management Corporation		
	Name of the survey	National Energy & GHG Emissions Survey		
	Sectors covered	All manufacturing sectors		
	Economic activity classification	Korean Standard Industrial Classification		
	Survey purpose	<ul style="list-style-type: none"> <li>• To track energy consumption of the industry over time</li> <li>• To calculate GHG emissions</li> </ul>		
<b>Data collection</b>	Sample design	According to certain characteristics		
	Sample sources			
	Population description	All facilities in a given industry sector as per classification index		
	Collection methods	Computer-assisted personal interview		
	Sample/Population size	150 000 / 340 000	Response rate	90%
	Frequency	Every three years		
	Time to complete survey	30 minutes	Mandatory	No
	Incentive	Non-cash incentives		
	Survey respondents	Operating facility		
	Elements collected	<ul style="list-style-type: none"> <li>• Total energy consumption of a facility</li> <li>• Energy use by type of end use</li> <li>• Production volumes by type of product</li> <li>• Age of the system/equipment</li> </ul>		
<b>Comments</b>	Main challenges	<ul style="list-style-type: none"> <li>• Low response rate</li> <li>• Response quality</li> </ul>		
	Possible improvements			
	Key best practice			
	Other documentation	Available: questionnaire		

<b>Background</b>	Country	Mexico	I/Su/16	
	Organisation	Ministry of Energy		
	Name of the survey	Energy Consumption Survey in the Industrial Sector		
	Sectors covered	<ul style="list-style-type: none"> <li>• Cement</li> <li>• Sugar</li> <li>• Pulp and paper</li> </ul>		
	Economic activity classification	North American Industry Classification System		
	Survey purpose	<ul style="list-style-type: none"> <li>• To track energy consumption of the industry over time</li> <li>• To determine process efficiencies within an industry</li> </ul>		
<b>Data collection</b>	Sample design	The sample design was based on a random rather than a probability-based selection. However, in order to verify the responses, submissions are checked against industry physical output reported in national statistics office (INEGI) official reports.		
	Sample sources	List of companies within the Chamber of Commerce in Mexico		
	Population description	All facilities in a given industry sector with a minimum level of output		
	Collection methods	Internet based (Excel file)		
	Sample/Population size	Not available	Response rate	100%
	Frequency	Every year		
	Time to complete survey	Not available	Mandatory	No
	Incentive	Non-cash incentive: provide respondents with information about their own performance relative to others in the sector		
	Survey respondents	Operating facility		
	Elements collected	<ul style="list-style-type: none"> <li>• Total energy consumption of a facility</li> <li>• Production volumes by type of product</li> <li>• Energy sources</li> <li>• Stocks (cement, given that they use petroleum coke)</li> <li>• Electricity auto-production</li> <li>• Measures taken to save energy</li> </ul>		
<b>Comments</b>	Main challenges	<ul style="list-style-type: none"> <li>• Incomplete survey</li> <li>• Inconsistent responses</li> <li>• Insufficient industry coverage due to low response rate</li> </ul>		
	Possible improvements	More frequent direct contact with other industry associations, customised questionnaires for each industry branch		
	Key best practice	The goal is to work with a number of industry associations. For example, existing activity-based surveys can be used to validate energy consumption survey.		
	Other documentation	Available: questionnaire		

<b>Background</b>	Country	Netherlands	<b>I/Su/17</b>	
	Organisation	Statistics Netherlands		
	Name of the survey	Energy consumption of the industry		
	Sectors covered	All manufacturing sectors		
	Economic activity classification	NACE		
	Survey purpose	<ul style="list-style-type: none"> <li>• To track energy consumption of the industry over time</li> <li>• To calculate GHG emissions</li> <li>• To evaluate effectiveness of programmes and policies</li> </ul>		
<b>Data collection</b>	Sample design	Stratified random sampling approach		
	Sample sources			
	Population description	Companies (type of activity units) in general business register, classified in NACE with 20 or more employees (smaller companies are estimated)		
	Collection methods	Paper form sent by mail		
	Sample/Population size	2 000 / 7 000	Response rate	85%
	Frequency	Every three years		
	Time to complete survey	15 minutes	Mandatory	Yes
	Incentive	None		
	Survey respondents	Operating facility		
	Elements collected	<ul style="list-style-type: none"> <li>• Total energy consumption of a facility</li> <li>• Energy sources</li> <li>• Non-energy use (e.g. feedstocks)</li> </ul>		
<b>Comments</b>	Main challenges	<ul style="list-style-type: none"> <li>• Incomplete survey</li> <li>• Response quality</li> </ul>		
	Possible improvements	Electronic questionnaire instead of paper, which makes it possible for respondents to carry out controls. This will be implemented from 2011 onward.		
	Key best practice	The existing paper-based survey is scheduled to be changed to an electronic-based survey. The survey will be carried out annually, instead of quarterly.		
	Other documentation			

Background	Country	New Zealand		I/Su/18
	Organisation	Statistics New Zealand		
	Name of the survey	Manufacturing Energy Use Survey		
	Sectors covered	<ul style="list-style-type: none"> <li>Aluminium</li> <li>Iron and steel</li> <li>Cement</li> <li>Pulp and paper</li> </ul>	<ul style="list-style-type: none"> <li>Chemicals</li> <li>Food, beverage and tobacco manufacturing</li> <li>All other manufacturing sectors</li> </ul>	
	Economic activity classification	Australian and New Zealand Standard Industrial Classification (ANZSIC), 96 Division C groups		
	Survey purpose	<ul style="list-style-type: none"> <li>To establish an industry energy efficiency benchmark</li> <li>To complement another data collection initiative</li> <li>To collect statistics about the use of energy in the manufacturing industry; the 2006 Manufacturing Energy Use Survey was carried out by Statistics New Zealand, in collaboration with the Ministry for Economic Development and the Energy Efficiency and Conservation Authority.</li> </ul>		
Data collection	Sample design	Stratified random sampling approach; one-stage stratified design was used		
	Sample sources	List of addresses		
	Population description	<p>The target population for this survey is all enterprises that operate in New Zealand, classified to ANZSIC. The survey population was selected by taking all enterprises that met the following criteria:</p> <ul style="list-style-type: none"> <li>Rolling mean employment greater than 10</li> <li>Economically significant (annual gross sales tax turnover figure of greater than \$30,000)</li> </ul> <p>For this survey the selection unit was the enterprise, and the collection unit was the geographic unit.</p>		
	Collection methods	Paper form sent by mail		
	Sample/Population size	1 576 / 5 500	Response rate	80%
	Frequency	Every three years		
	Time to complete survey	45 minutes	Mandatory	Yes
	Incentive	Reminders emphasising the need for data		
	Survey respondents	Operating facility, energy auditing firm, accounting firm		
	Elements collected	<ul style="list-style-type: none"> <li>Total energy consumption of a facility</li> <li>Energy use by type of end use</li> <li>Energy sources</li> </ul>		
Comments	Main challenges	<ul style="list-style-type: none"> <li>Incomplete survey</li> <li>Inconsistent responses</li> <li>Response quality</li> </ul>		
	Possible improvements	More resources and expertise in energy use evaluation		
	Key best practice	Multiple testing of the questionnaire; involvement of the field staff and related experts		
	Other documentation	Available: report and questionnaire, URL		

<b>Background</b>	Country	Slovakia	<b>I/Su/19</b>	
	Organisation	Statistics Office of the Slovak Republic		
	Name of the survey	Annual questionnaire on sources and consumption of fuels and energy		
	Sectors covered	All manufacturing sectors		
	Economic activity classification	NACE		
	Survey purpose	To track energy consumption of the industry over time		
<b>Data collection</b>	Sample design	According to certain characteristics		
	Sample sources			
	Population description	Industries with a minimum number of employees		
	Collection methods	<ul style="list-style-type: none"> <li>• Paper form sent by mail</li> <li>• Internet based</li> </ul>		
	Sample/Population size	Not available	Response rate	86%
	Frequency	Every year		
	Time to complete survey	104 minutes	Mandatory	Yes
	Incentive	Individually in accordance with the administrative law		
	Survey respondents	Operating facility		
	Elements collected	<ul style="list-style-type: none"> <li>• Total energy consumption of a facility</li> <li>• Energy use by type of end use</li> <li>• Energy sources</li> <li>• Non-energy use (e.g. feedstocks)</li> </ul>		
<b>Comments</b>	Main challenges			
	Possible improvements			
	Key best practice			
	Other documentation	Available: questionnaire		

<b>Background</b>	Country	Spain	<b>I/Su/20</b>	
	Organisation	Instituto para la Diversificación y Ahorro de la Energía		
	Name of the survey	Natural Gas Industry Survey and Electrical Energy Industry Survey		
	Sectors covered	<ul style="list-style-type: none"> <li>• Iron and steel</li> <li>• Cement</li> <li>• Pulp and paper</li> </ul>	<ul style="list-style-type: none"> <li>• Chemicals</li> <li>• All other manufacturing sectors</li> </ul>	
	Economic activity classification	NACE		
	Survey purpose	To track energy consumption of the industry over time		
<b>Data collection</b>	Sample design	Census		
	Sample sources			
	Population description	All natural gas and electricity suppliers		
	Collection methods			
	Sample/Population size	Not available		
	Frequency	Every year		
	Time to complete survey	Not available	Mandatory	Yes
	Incentive			
	Survey respondents	Electricity and natural gas utilities		
Elements collected	Natural gas and electricity consumption of the manufacturing sectors			
<b>Comments</b>	Main challenges			
	Possible improvements			
	Key best practice			
	Other documentation	Available: questionnaire		

<b>Background</b>	Country	Sweden	<b>I/Su/21</b>	
	Organisation	Swedish Energy Agency		
	Name of the survey	Energy use in manufacturing industry		
	Sectors covered	All manufacturing sectors		
	Economic activity classification	NACE		
	Survey purpose	<ul style="list-style-type: none"> <li>• To track energy consumption of the industry over time</li> <li>• To calculate GHG emissions</li> <li>• To evaluate effectiveness of programmes and policies</li> </ul>		
<b>Data collection</b>	Sample design	According to certain characteristics		
	Sample sources	Total industry census		
	Population description	Enterprises with more than ten employees, within NACE 05-33. Facilities with fewer than ten employees are estimated using a model.		
	Collection methods	<ul style="list-style-type: none"> <li>• Paper form sent by mail</li> <li>• Internet based</li> </ul>		
	Sample/Population size	8 200 / 58 200	Response rate	89%
	Frequency	Every year		
	Time to complete survey	25 minutes	Mandatory	Yes
	Incentive	None		
	Survey respondents	Operating facility		
	Elements collected	<ul style="list-style-type: none"> <li>• Total energy consumption of a facility</li> <li>• Energy sources</li> </ul>		
<b>Comments</b>	Main challenges			
	Possible improvements	Increasing the time for examining microdata. This requires additional resources.		
	Key best practice			
	Other documentation	Available: report and questionnaire		



<b>Background</b>	Country	Switzerland – International Industry Association		I/Su/22
	Organisation	Cement Sustainability Initiative		
	Name of the survey	Carbon Dioxide (CO <sub>2</sub> ) and Energy Database for the Cement Industry		
	Sectors covered	Cement		
	Economic activity classification			
	Survey purpose	<ul style="list-style-type: none"> <li>• To track energy consumption of the industry over time</li> <li>• To set industry energy efficiency benchmarks</li> <li>• To determine process efficiencies within an industry</li> <li>• To track industry's physical output over time</li> <li>• To provide accurate and verified data on the global cement industry's CO<sub>2</sub> and energy performance</li> </ul>		
<b>Data collection</b>	Sample design			
	Sample sources	Industry association members: Members of the Cement Sustainability Initiative and European cement producers, CEMBUREAU, the European Cement Association		
	Population description	Cement manufacturers: 29% of global cement production		
	Collection methods	Internet based		
	Sample size	912		
	Frequency	Every year		
	Time to complete survey	Not available	Mandatory	No
	Incentive			
	Survey respondents	Operating facility		
	Elements collected	<ul style="list-style-type: none"> <li>• Energy use at various stages of production</li> <li>• Production volumes by type of product</li> <li>• Absolute gross and net CO<sub>2</sub> emissions</li> <li>• Specific gross and net CO<sub>2</sub> emissions per tonne of clinker and per tonne of cementitious product</li> <li>• Average thermal energy consumption per tonne of clinker</li> <li>• Specific electric energy consumption as a kilowatt hour per tonne</li> </ul>		
<b>Comments</b>	Main challenges			
	Possible improvements			
	Key best practice			
	Other documentation	Available: URL		

<b>Background</b>	Country	Switzerland	<b>I/Su/23</b>	
	Organisation	Swiss Federal Office of Energy; Helbling		
	Name of the survey	Statistics on final energy consumption in industry and services		
	Sectors covered	<ul style="list-style-type: none"> <li>Aluminium</li> <li>Iron and steel</li> <li>Cement</li> <li>Pulp and paper</li> <li>Chemicals</li> </ul>	<ul style="list-style-type: none"> <li>Food, textile, non-metallic mineral products, non-ferrous metals, electric equipment, machines, etc.</li> <li>All other manufacturing sectors</li> </ul>	
	Economic activity classification	Swiss classification, based on NACE, used for inputs. Output only per whole industry sector.		
	Survey purpose	To track energy consumption of the industry over time		
<b>Data collection</b>	Sample design	A stratified random sampling approach, stratified by branches and company size		
	Sample sources	Business and Enterprise Register of the Swiss Federal Statistics Office		
	Population description	All workplaces where one or more people work for at least 20 hours per week in industry and services sectors		
	Collection methods	<ul style="list-style-type: none"> <li>Paper form sent by mail</li> <li>Internet based</li> </ul>		
	Sample/Population size	12 000 / 380 000		50%
	Frequency	Every year		
	Time to complete survey	25 minutes	Mandatory	Yes
	Incentive	None		
	Survey respondents	Operating facility		
	Elements collected	<ul style="list-style-type: none"> <li>Total energy consumption of a facility</li> <li>Energy sources</li> </ul>		
<b>Comments</b>	Main challenges	Incomplete survey		
	Possible improvements			
	Key best practice	Parallel and immediate data analysis along with data collection help to improve data quality and timeliness.		
	Other documentation	Available: report and questionnaire		

<b>Background</b>	Country	Thailand	<b>I/Su/24</b>	
	Organisation	Department of Alternative Energy Development		
	Name of the survey	Project of Study and Analysis of the Energy Consumption Structure in the Industry Sector		
	Sectors covered	All manufacturing sectors		
	Economic activity classification	ISIC and Thailand Standard Industrial Classification (TSIC)		
	Survey purpose	<ul style="list-style-type: none"> <li>• To complement another data collection initiative</li> <li>• To establish the data collection system of industry's energy consumption by sub-sector according to ISIC and TSIC in Thailand</li> <li>• To develop and establish modelling in industry's energy consumption forecast</li> <li>• To study energy consumption behaviour, structure and energy prices in industry sector for industry's data analysis in annual energy statistics preparation</li> </ul>		
<b>Data collection</b>	Sample design	A stratified random sampling approach		
	Sample sources			
	Population description			
	Collection methods			
	Sample/Population size	Not available		
	Frequency	No regular cycle		
	Time to complete survey	25 minutes	Mandatory	No
	Incentive	Energy consumption data in the industry sector is important in conducting the strategic plan in energy conservation and alternative energy development		
	Survey respondents			
	Elements collected			
<b>Comments</b>	Main challenges			
	Possible improvements			
	Key best practice			
	Other documentation			

<b>Background</b>	Country	Turkey	<b>I/Su/25</b>	
	Organisation	Ministry of Energy and Natural Resources		
	Name of the survey	Energy Balance		
	Sectors covered	Cement		
	Economic activity classification	NACE		
	Survey purpose	To track energy consumption of the industry over time		
<b>Data collection</b>	Sample design	Census		
	Sample sources			
	Population description	All facilities in a given industry sector		
	Collection methods	<ul style="list-style-type: none"> <li>• Paper form sent by mail</li> <li>• Computer-assisted personal interview</li> <li>• Computer-assisted telephone interview</li> <li>• Telephone interview</li> </ul>		
	Sample/Population size	76 / 76	Response rate	100%
	Frequency	Every year		
	Time to complete survey	30 minutes	Mandatory	Yes
	Incentive	A fine		
	Survey respondents	Operating facility		
	Elements collected	<ul style="list-style-type: none"> <li>• Total energy consumption of a facility</li> <li>• Energy use at various stages of production</li> <li>• Production volumes by type of product</li> <li>• Energy sources</li> <li>• Non-energy use (e.g. feedstocks)</li> <li>• Age of the system/equipment</li> </ul>		
<b>Comments</b>	Main challenges	<ul style="list-style-type: none"> <li>• Inconsistent responses</li> <li>• Response quality</li> <li>• Bias from the interviewer</li> <li>• Quality of the interviewing staff</li> <li>• Recruiting, training and retaining project staff</li> </ul>		
	Possible improvements			
	Key best practice			
	Other documentation	Available: questionnaire		

<b>Background</b>	Country	Ukraine	<b>I/Su/26</b>	
	Organisation	State Statistics Committee of Ukraine		
	Name of the survey	Consumption of Fuel, Heat, Power and Energy		
	Sectors covered	All manufacturing sectors		
	Economic activity classification	NACE		
	Survey purpose	<ul style="list-style-type: none"> <li>• To track energy consumption of the industry over time</li> <li>• To track industry's physical output over time</li> <li>• To understand operational costs within an industry (e.g. energy and labour costs)</li> </ul>		
<b>Data collection</b>	Sample design	Census		
	Sample sources			
	Population description	Enterprises with average daily consumption of 2 tons or more of standard fuel or 15 gigacalories or more of heat and 100 kWh or more of electricity.		
	Collection methods	<ul style="list-style-type: none"> <li>• Paper form sent by mail</li> <li>• Internet based</li> </ul>		
	Sample/Population size	50 000 / 50 000	Response rate	100%
	Frequency	Every year		
	Time to complete survey	4 hours	Mandatory	Yes
	Incentive	A fine		
	Survey respondents	Operating facility		
	Elements collected	<ul style="list-style-type: none"> <li>• Total energy consumption of a facility</li> <li>• Energy use at various stages of production</li> <li>• Production volumes by type of product</li> <li>• Non-energy use (e.g. feedstocks)</li> </ul>		
<b>Comments</b>	Main challenges	Response quality		
	Possible improvements			
	Key best practice			
	Other documentation	Available: questionnaire		

<b>Background</b>	<b>Country</b>	United Kingdom – International Industry Association		<b>1/Su/27</b>
	<b>Organisation</b>	International Aluminium Institute		
	<b>Name of the survey</b>	Energy Survey (ES001, ES011)		
	<b>Sectors covered</b>	Aluminium		
	<b>Economic activity classification</b>			
	<b>Survey purpose</b>	<ul style="list-style-type: none"> <li>• To track energy consumption of the industry over time</li> <li>• To set industry energy efficiency benchmarks</li> <li>• To calculate GHG emissions</li> <li>• To complement another data collection initiative: GHG Modelling Mass flow and energy flow modelling</li> </ul>		
	<b>Data collection</b>	<b>Sample design</b>	Census	
<b>Sample sources</b>		Other surveys		
<b>Population description</b>		All (alumina refining and primary aluminium smelting) production facilities globally — by production tonnage (40 million tonnes [Mt] primary, 80 Mt alumina)		
<b>Collection methods</b>		<ul style="list-style-type: none"> <li>• Paper form sent by mail</li> <li>• Internet based</li> <li>• Emailed form</li> </ul>		
<b>Sample/Population size</b>		40 / 40	<b>Response rate</b>	95%
<b>Frequency</b>		Every year		
<b>Time to complete survey</b>		Not available	<b>Mandatory</b>	No
<b>Incentive</b>				
<b>Survey respondents</b>		Operating facility		
<b>Elements collected</b>		<ul style="list-style-type: none"> <li>• Total energy consumption of a facility</li> <li>• Energy use at various stages of production</li> <li>• Production volumes by type of product</li> <li>• Energy sources</li> <li>• Non-energy use (e.g. feedstocks)</li> </ul>		
<b>Comments</b>	<b>Main challenges</b>	<ul style="list-style-type: none"> <li>• Incomplete survey</li> <li>• Inconsistent responses</li> <li>• Changes in personnel year to year mean inconsistency over time, changes in some definitions over time (i.e. more granularity in data requested)</li> </ul>		
	<b>Possible improvements</b>			
	<b>Key best practice</b>	Annual benchmarking and feedback to respondents. Real-time benchmarking is done via online reporting and users can see immediately where their operations stand relative to others.		
	<b>Other documentation</b>	Available: URL link		

<b>Background</b>	<b>Country</b>	United States – National Industry Association		<b>I/Su/28</b>
	<b>Organisation</b>	American Forest & Paper Association (AF&PA)		
	<b>Name of the survey</b>	AF&PA Pulp and Paper Mill Environment, Fuel & Energy and Health Survey		
	<b>Sectors covered</b>	Pulp and paper		
	<b>Economic activity classification</b>	North American Industry Classification System (NAICS)		
	<b>Survey purpose</b>	<ul style="list-style-type: none"> <li>• To track energy consumption of the industry over time</li> <li>• To calculate GHG emissions</li> <li>• To track and report air, water and waste management</li> <li>• To report on progress towards AF&amp;PA's Better Practices, Better Planet 2020 Sustainability Goals</li> </ul>		
<b>Data collection</b>	<b>Sample design</b>	Census		
	<b>Sample sources</b>			
	<b>Population description</b>	All pulp and paper mills belonging to AF&PA members		
	<b>Collection methods</b>	<ul style="list-style-type: none"> <li>• Web-based data entry</li> <li>• Paper form sent by mail</li> </ul>		
	<b>Sample/Population size</b>	200 / 390	<b>Response rate</b>	100% for members
	<b>Frequency</b>	Every two years		
	<b>Time to complete survey</b>	30 minutes for readily available data	<b>Mandatory</b>	Yes, for members
	<b>Incentive</b>	None		
	<b>Survey respondents</b>	Operating facility and/or corporate		
	<b>Elements collected</b>	<ul style="list-style-type: none"> <li>• Total energy consumption of a facility</li> <li>• Production of paper, pulp for off-site shipments, unbleached chemical pulp and bleached chemical pulp</li> <li>• Energy sources — various types of fossil and biomass fuels</li> <li>• On-site electricity generated</li> <li>• Sulphur dioxide and nitrogen oxide emissions by power boilers and process</li> <li>• Solid residuals management data</li> <li>• Water discharge — flow, total suspended solids, Halogenated organic compounds and biochemical oxygen demand</li> </ul>		
<b>Comments</b>	<b>Main challenges</b>	<ul style="list-style-type: none"> <li>• Incomplete survey</li> <li>• Reporting units for various metrics</li> <li>• Reporting within deadlines</li> <li>• Resource availability at the reporting companies</li> </ul>		
	<b>Possible improvements</b>	For respondents to validate data consistency in their surveys; additional online validations		
	<b>Key best practice</b>	Online data collection, edit procedure for validating some of the data		
	<b>Other documentation</b>	Available: questionnaire		

Background	Country	United States	I/Su/29	
	Organisation	Energy Information Administration		
	Name of the survey	Manufacturing Energy Consumption Survey (MECS)		
	Sectors covered	All manufacturing sectors		
	Economic activity classification	North American Industry Classification System (NAICS)		
	Survey purpose	<ul style="list-style-type: none"> <li>• To track energy consumption of the industry over time</li> <li>• To evaluate effectiveness of programmes and policies</li> <li>• In addition to collecting data on energy consumption and energy management activities, the survey also collects data on fuel-switching capacity and specific end uses (e.g., process heating).</li> </ul>		
	Data collection	Sample design	Stratified random sampling approach	
Sample sources		List from tax agency (e.g. municipal, regional), list of addresses		
Population description		All establishments classified as manufacturing according to the NAICS system except the smallest ones. These smallest establishments all together account for 2% to 3% of the total manufacturing payroll in the United States. The eliminated establishments are identified by labour force size – those establishments with five or fewer employees are eliminated, but that minimum size cutoff can be as high as 20 employees for industries with typically large establishments.		
Collection methods		<ul style="list-style-type: none"> <li>• Paper form sent by mail</li> <li>• Internet based</li> </ul>		
Sample/Population size		15 000 / 195 000	Response rate	80%
Frequency		Every four years		
Time to complete survey		9 hours	Mandatory	Yes
Incentive		A fine could be applied if pursued but this process has not been exercised		
Survey respondents		Operating facility		
Elements collected		<ul style="list-style-type: none"> <li>• Total energy consumption of a facility</li> <li>• Energy use by type of end use</li> </ul>	<ul style="list-style-type: none"> <li>• Energy sources</li> <li>• Non-energy use (e.g. feedstocks)</li> </ul>	
Comments	Main challenges	<ul style="list-style-type: none"> <li>• Low response rate</li> <li>• Incomplete survey</li> </ul>	<ul style="list-style-type: none"> <li>• Response quality</li> </ul>	
	Possible improvements	More efficient follow-up methods (did not have email available for 2006 survey – will for 2010); greater emphasis on mandatory authority; the implementation of a fully automated statistical disclosure avoidance system to protect confidentiality; increasing the frequency to once every two years to foster continuity in institutional awareness and knowledge for both respondents and processing staff.		
	Key best practice	The 2006 MECS was primarily an Internet-based electronic survey. Almost 90% of the respondents chose to use this method. Prior to 2006, the MECS had been mostly a paper-and-pencil survey. The advantages of the Internet-based survey: 1) Better quality of response through in-survey price and other types of edits; 2) Easier navigation for respondents which also led to better quality; 3) The survey instrument would make necessary calculations that would appear later in the survey for respondent's reference; 4) Elimination of data keying errors for Internet respondents and reduction of money used for data keyers.		
	Other documentation	Available: questionnaires		



<b>Background</b>	Country	Japan	I/Me/01
	Organisation	Sumitomo Metal Industries Ltd.	
	Name of the project	Nippon Keidanren Voluntary Action Programme	
	Sectors covered	Iron and Steel	
	Project purpose	<ul style="list-style-type: none"> <li>• To measure energy use at various stages of production within a facility</li> <li>• To measure non-energy use (e.g. feedstocks) of fuels within a facility</li> <li>• To optimise fuel utilisation within a facility production process</li> <li>• To calculate energy efficiency of an industrial process</li> </ul>	
<b>Data collection</b>	Sample design	All steel producers who agree to submit data.	
	Sample sources	List of industry association members	
	Population description	Industry association members	
	Equipment used	Current meter (data logger)	
	Sample/Population size	Not available	
	Frequency	Every year	
	Time to collect measurements	Not available	
	Who took measurements	Energy auditors	
	Elements measured	<ul style="list-style-type: none"> <li>• Energy use at various stages of production</li> <li>• Heat generation and heat losses</li> <li>• Combustion process efficiency</li> <li>• Production volumes by type of product</li> <li>• Non-energy use of feedstocks</li> <li>• Efficiency rating of processes within production flow</li> </ul>	
Geo-climatic measurements	No		
<b>Comments</b>	Main challenges		
	Recommendations	Measurements should be made using the same methodology	
	Key best practice	Use of latest technology to undertake measurements	
	Other documentation		

<b>Background</b>	Country	Canada	I/Mo/O1
	Organisation	Natural Resources Canada	
	Name of the model	Industrial Energy End-Use Model	
	Sectors covered	<ul style="list-style-type: none"> <li>• Aluminium</li> <li>• Iron and steel</li> <li>• Cement</li> <li>• Pulp and paper</li> <li>• Chemicals</li> <li>• Mining, construction, forestry</li> <li>• All other manufacturing sectors</li> </ul>	
	Model purpose	<ul style="list-style-type: none"> <li>• To estimate total energy use for a given industry</li> <li>• To estimate energy efficiency of a given industry</li> <li>• To calculate GHG emissions from a given industry sector</li> </ul>	
<b>Data inputs/outputs</b>	Model type	Bottom-up statistical model The modelling tool was developed in-house and undergoes continuous improvements to take into account new or improved data	
	Results validated	Yes: <i>Report on Energy Supply and Demand in Canada</i> , Industrial Consumption of Energy Survey, Canada's Greenhouse Gas Inventory	
	Frequency	Every year	
	Key model inputs	<ul style="list-style-type: none"> <li>• Historical production volume in a given industry</li> <li>• Historical energy prices</li> <li>• Industry production output assumptions</li> <li>• Industrial fuel consumption</li> <li>• Energy conversion factors</li> <li>• GHG emissions factors</li> </ul>	
	Key model outputs	<ul style="list-style-type: none"> <li>• Energy efficiency of a given industry</li> <li>• Total energy use for a given industry</li> <li>• GHG emissions from a given industry sector</li> </ul>	
<b>Comments</b>	Main challenges	Lack of input data Lack of data limits capacity to expand model	
	Additional information	Modelling is an ongoing activity, so cost cannot be estimated.	
	Key best practice		
	Other documentation		

	Country	Croatia	I/Mo/02
	Organisation	Energy Institute Hrvoje Pozar	
	Name of the model	End-use modelling (MAED, MDEE)	
Background	Sectors covered	<ul style="list-style-type: none"> <li>Aluminium</li> <li>Iron and steel</li> <li>Cement</li> </ul>	<ul style="list-style-type: none"> <li>Pulp and paper</li> <li>Chemicals</li> <li>All other manufacturing sectors</li> </ul>
	Model purpose	<ul style="list-style-type: none"> <li>To estimate energy use at various stages of production within a facility</li> <li>To estimate total energy use for a given industry</li> <li>To calculate GHG emissions from a given industry sector</li> <li>To complement an existing survey or data collection effort with energy consumption trends</li> </ul>	
Data inputs/outputs	Model type	<ul style="list-style-type: none"> <li>Bottom-up engineering model</li> <li>Custom-built model</li> </ul>	
	Results validated	Yes: calibration with energy balances	
	Frequency	Only conducted once	
	Key model inputs	<ul style="list-style-type: none"> <li>Detailed industrial process flows</li> <li>Historical production volume in a given industry</li> </ul>	
	Key model outputs	<ul style="list-style-type: none"> <li>Detailed industrial energy consumption</li> <li>Energy use and energy efficiency of a facility</li> <li>Industry growth projections</li> <li>Total energy use for a given industry</li> <li>GHG emissions from a given industry sector</li> <li>Technology evolution and diffusion within an industry</li> </ul>	
Comments	Main challenges		
	Additional information		
	Key best practice		
	Other documentation		

<b>Background</b>	<b>Country</b>	Germany	<b>I/Mo/03</b>
	<b>Organisation</b>	Fraunhofer Institute for Systems and Innovation Research	
	<b>Name of the model</b>	FORECAST-Industry (former name ISIndustry)	
	<b>Sectors covered</b>	<ul style="list-style-type: none"> <li>Aluminium</li> <li>Iron and steel</li> <li>Cement</li> </ul>	<ul style="list-style-type: none"> <li>Pulp and paper</li> <li>Chemicals</li> <li>All manufacturing sectors</li> </ul>
	<b>Model purpose</b>	<ul style="list-style-type: none"> <li>To estimate total energy use for a given industry</li> <li>To estimate energy efficiency of a given industry</li> <li>To calculate GHG emissions from a given industry sector</li> <li>To evaluate technology evolution and diffusion in a given industry sector</li> <li>To assess economic policies</li> </ul>	
<b>Data inputs/outputs</b>	<b>Model type</b>	<ul style="list-style-type: none"> <li>Bottom-up engineering model</li> <li>Custom-built model</li> </ul>	
	<b>Results validated</b>	Yes: historical data on energy demand by industrial sector were used to calibrate the bottom-up calculations of energy demand	
	<b>Frequency</b>	Every year	
	<b>Key model inputs</b>	<ul style="list-style-type: none"> <li>Aggregate representation of an industrial process</li> <li>Historical production volume in a given industry</li> <li>Technology and/or process evolution assumptions</li> <li>Historical technology and/or process cost</li> <li>Historical energy prices</li> <li>Industry production output assumptions</li> <li>Industry growth rate and other macroeconomic assumptions</li> </ul>	
	<b>Key model outputs</b>	<ul style="list-style-type: none"> <li>Energy efficiency of a given industry</li> <li>Total energy use for a given industry</li> <li>GHG emissions from a given industry sector</li> <li>Technology evolution and diffusion within an industry</li> <li>Impact of policies and regulations on energy efficiency of an industry</li> </ul>	
<b>Comments</b>	<b>Main challenges</b>	<ul style="list-style-type: none"> <li>Lack of input data</li> <li>Quality control issues with input data</li> </ul>	
	<b>Additional information</b>	For the time being, no published model documentation is available. Some of the reports that use the model are confidential, but some examples of model applications could be provided on demand.	
	<b>Key best practice</b>	<ul style="list-style-type: none"> <li>The model is mostly applied to the EU-27 member states plus Norway and Switzerland. It calculates on a country level and breaks down industrial energy demand by industrial process and country. This is far more detailed than any other official energy balance provides.</li> <li>The model shows a very high degree of technology details, not only for process-specific technologies but also for cross-cutting technologies</li> <li>Although being a bottom-up engineering model, it considered investment costs and energy prices that allow estimating costs of policies</li> <li>The model also allows estimation of the cost effect of the EU emissions trading scheme</li> </ul>	
	<b>Other documentation</b>	Available: reports	

<b>Background</b>	Country	Mexico	I/Mo/04
	Organisation	Ministry of Energy	
	Name of the model	Energy consumption in the industry sector	
	Sectors covered	<ul style="list-style-type: none"> <li>• Cement</li> <li>• Pulp and paper</li> <li>• Sugar</li> </ul>	
	Model purpose	To estimate total energy use for a given industry	
<b>Data inputs/outputs</b>	Model type	Top-down econometric model. This approach was used to complete the information we obtained from the surveys. The model was developed with Eviews software.	
	Results validated	Yes: Official total industry energy consumption data are calibrated with the data obtained through this exercise. In addition, industry associations review the data.	
	Frequency	Every year	
	Key model inputs	<ul style="list-style-type: none"> <li>• Historical production volume in a given industry</li> <li>• Industry growth rate and other macroeconomic assumptions</li> <li>• Total energy consumption by industry provided by the survey</li> </ul>	
	Key model outputs	Total energy use for a given industry	
<b>Comments</b>	Main challenges	Lack of input data	
	Additional information		
	Key best practice	Given the lack of resources, it is very important to be innovative and make the most of what is available	
	Other documentation		

<b>Background</b>	Country	Sweden	I/Mo/05
	Organisation	Swedish Energy Agency	
	Name of the model		
	Sectors covered	All manufacturing sectors	
	Model purpose	<ul style="list-style-type: none"> <li>• To estimate total energy use for a given industry</li> <li>• To calculate GHG emissions from a given industry sector</li> <li>• To assess economic policies</li> <li>• To complement an existing survey or data collection effort with energy consumption trends</li> </ul>	
<b>Data inputs/outputs</b>	Model type	<ul style="list-style-type: none"> <li>• Top-down econometric model</li> <li>• Custom-built model</li> </ul>	
	Results validated	No	
	Frequency	Every year	
	Key model inputs		
	Key model outputs	Total energy use for a given industry	
<b>Comments</b>	Main challenges		
	Additional information	The model attempts to estimate the energy use of small manufacturing facilities with fewer than ten employees.	
	Key best practice		
	Other documentation		

<b>Background</b>	Country	Switzerland	I/Mo/06
	Organisation	Cement Sustainability Initiative	
	Name of the model	Sectoral Approach: GHG mitigation in the cement industry	
	Sectors covered	Cement	
	Model purpose	<ul style="list-style-type: none"> <li>• To estimate GHG emissions from cement production</li> <li>• To develop policy measures to mitigate the emissions</li> </ul>	
<b>Data inputs/outputs</b>	Model type	<ul style="list-style-type: none"> <li>• Bottom-up statistical model</li> <li>• Custom-built model</li> </ul>	
	Results validated	Yes: peer review of the model	
	Frequency	Only conducted once	
	Key model inputs	<ul style="list-style-type: none"> <li>• Technology and capacity information on cement production facilities</li> <li>• Production and investment costs</li> <li>• Cement demand by region over time</li> <li>• Transportation costs</li> <li>• Availability and cost of blending materials and fuel/electricity</li> <li>• CO<sub>2</sub> constraints and prices</li> </ul>	
	Key model outputs	GHG emissions from a given industry sector	
<b>Comments</b>	Main challenges	<ul style="list-style-type: none"> <li>• Choice of assumptions</li> <li>• Data availability and quality</li> </ul>	
	Additional information		
	Key best practice		
	Other documentation	Available: URL	

<b>Background</b>	<b>Country</b>	Switzerland	<b>I/Mo/07</b>
	<b>Organisation</b>	Swiss Federal Office of Energy; Prognos AG	
	<b>Name of the model</b>	Industry Energy Consumption Model	
	<b>Sectors covered</b>	All sectors	
	<b>Model purpose</b>	To estimate industry energy consumption in general, by end use and by determinant factors. The basic model was developed for energy perspectives, but also serves for the ex post analysis of energy consumption by end use and by determinant factors. The model is calibrated to the Swiss energy balances. Adding statistics (inputs) of the actual year allows getting output in form of end-use data.	
<b>Data inputs/outputs</b>	<b>Model type</b>	Bottom-up energy-economic model, close to bottom-up engineering model, but using further inputs. The model is mainly based on administrative data (Federal Office of Statistics, Federal Office of Energy, etc.) but also uses data from utilities, manufacturers and national associations.	
	<b>Results validated</b>	Yes: calibration with Swiss energy statistics; cross-check with energy consumption statistics in the industry and services sectors (survey of 12 000 companies)	
	<b>Frequency</b>	Every year	
	<b>Key model inputs</b>	<ul style="list-style-type: none"> <li>• Fuel-switching assumptions</li> <li>• Industry production output assumptions</li> <li>• Extrapolation factors and specific consumption factors of 207 production processes in 16 branches such as energy reference area, energy prices, valued added, number of employees and workplaces, HDD and radiation, etc.</li> </ul>	
	<b>Key model outputs</b>	Industry energy consumption in general, by end use and by determinant factors	
<b>Comments</b>	<b>Main challenges</b>	<ul style="list-style-type: none"> <li>• Lack of input data</li> <li>• Including new trends whenever possible</li> </ul>	
	<b>Additional information</b>	The analysis of energy consumption by end use is based on the models developed for the energy perspectives. Fifteen years of experience and annual model runs have helped to increase the number of inputs in all fields of data sources.	
	<b>Key best practice</b>		
	<b>Other documentation</b>	Available: report	



<b>Background</b>	Country	United States	I/Mo/08
	Organisation	Lawrence Berkeley National Laboratory	
	Name of the model	Estimation of energy efficiency potential for various industries	
	Sectors covered	<ul style="list-style-type: none"> <li>• Iron and steel</li> <li>• Cement</li> </ul>	<ul style="list-style-type: none"> <li>• Pulp and paper</li> <li>• All other manufacturing sectors</li> </ul>
	Model purpose	<ul style="list-style-type: none"> <li>• To estimate energy use at various stages of production within a facility</li> <li>• To estimate energy efficiency of facility processes at various stages of production</li> <li>• To estimate total energy use for a given industry</li> <li>• To estimate energy efficiency of a given industry</li> <li>• To calculate GHG emissions from a given industry sector</li> </ul>	
<b>Data inputs/outputs</b>	Model type	<ul style="list-style-type: none"> <li>• Bottom-up engineering model</li> <li>• Custom-built model</li> </ul>	
	Results validated	No	
	Frequency	No regular survey cycle	
	Key model inputs	<ul style="list-style-type: none"> <li>• Aggregate representation of an industrial process</li> <li>• Fuel-switching assumptions</li> <li>• Technology and/or process evolution assumptions</li> <li>• Industry production output assumptions</li> <li>• Industry growth rate and other macroeconomic assumptions</li> </ul>	
	Key model outputs	<ul style="list-style-type: none"> <li>• Energy efficiency of a given industry</li> <li>• Industry growth projections</li> <li>• Total energy use for a given industry</li> <li>• GHG emissions from a given industry sector</li> </ul>	
<b>Comments</b>	Main challenges	<ul style="list-style-type: none"> <li>• Lack of input data</li> <li>• Quality control issues with input data</li> <li>• Lack of good model documentation</li> </ul>	
	Additional information		
	Key best practice	Inclusion of existing and emerging industrial technologies, discrete representation of process and cross-cutting (e.g., motors, pumps, steam) technologies, levelised costs normalized to consistent reference year, projections through 2050	
	Other documentation	Available: reference (Masanet et al., 2009)	

## 4 Transport

<b>Background</b>	<b>Country</b>	Australia	<b>T/Ad/01</b>
	<b>Organisation</b>	Australian Bureau of Agricultural and Resource Economics	
	<b>Data collection purpose</b>	<ul style="list-style-type: none"> <li>• To develop a broad range of transport energy consumption estimates, which include bunker fuel use, road transport energy use for all fuel types, rail transport energy use for all fuel types, air transport and sea transport</li> <li>• To develop transport activity estimates</li> </ul>	
<b>Data collection</b>	<b>Sources</b>	<ul style="list-style-type: none"> <li>• Government statistics office</li> <li>• External survey data of petroleum sales from the Australian Government Department of Resources, Energy and Tourism</li> <li>• External data from the National Greenhouse and Energy Reporting system</li> <li>• Transport model – based output from the Bureau of Infrastructure, Transport and Regional Economics and company reports</li> <li>• A survey of motor vehicle use by the Australian Bureau of Statistics, if available</li> </ul>	
	<b>Data collected</b>	Petroleum sales data, company-level energy use, activity-based transport model energy consumption estimates, fuel consumption, distance travelled estimates	
<b>Comments</b>	<b>Main challenges</b>	<ul style="list-style-type: none"> <li>• Time-consuming to gather data</li> <li>• Took a long time to establish a relationship with the organisation</li> <li>• Needed to establish a Memorandum of Understanding with a given organisation</li> <li>• Definition issues within a sector</li> <li>• Data were incomplete</li> </ul>	
	<b>Additional observations</b>	A wide variety of administrative sources are likely to remain important for the estimation of road transport use in Australia. This is because the cost and practical issues associated with the fact that directly surveying road users is prohibited.	

<b>Background</b>	<b>Country</b>	Bosnia and Herzegovina	<b>T/Ad/02</b>
	<b>Organisation</b>	Ministry of Industry, Energy and Mining of Republic of Srpska	
	<b>Data collection purpose</b>	To collect energy consumption for transport sector	
<b>Collection</b>	<b>Sources</b>	<ul style="list-style-type: none"> <li>• Government statistics office</li> <li>• Energy utilities (gas, oil, electricity, other)</li> <li>• Manufacturers</li> </ul>	
	<b>Data collected</b>	<ul style="list-style-type: none"> <li>• Consumption of petroleum and petroleum products</li> <li>• Electricity consumption (railway)</li> </ul>	
<b>Comments</b>	<b>Main challenges</b>	<ul style="list-style-type: none"> <li>• Time-consuming to gather data</li> <li>• In paper format – difficult to transfer to digital format</li> <li>• Data were incomplete</li> </ul>	
	<b>Additional observations</b>	Some data are estimated	

<b>Background</b>	<b>Country</b>	Brazil	<b>T/Ad/03</b>
	<b>Organisation</b>	Centro Clima	
	<b>Data collection purpose</b>	<ul style="list-style-type: none"> <li>• To estimate transport energy and activity data</li> <li>• To calculate transport energy efficiency indicators</li> </ul>	
<b>Data collection</b>	<b>Sources</b>	<ul style="list-style-type: none"> <li>• Government statistics office</li> <li>• Utilities (gas, oil, electricity, other)</li> <li>• Manufacturers</li> <li>• International organisations</li> </ul>	
	<b>Data collected</b>	<ul style="list-style-type: none"> <li>• Base fleet</li> <li>• Scrap curve</li> <li>• Average fuel efficiency</li> </ul>	<ul style="list-style-type: none"> <li>• Sales distribution by technology</li> <li>• Consumption distribution by fuel type</li> <li>• Average distance travelled</li> </ul>
<b>Comments</b>	<b>Main challenges</b>	<ul style="list-style-type: none"> <li>• Time-consuming to gather data</li> <li>• Took a long time to establish a relationship with the organisation</li> <li>• Many data points crossed off due to confidentiality of the sources</li> <li>• Needed agreement from respondents</li> <li>• Data were incomplete</li> <li>• Data existed but were confidential</li> </ul>	
	<b>Additional observations</b>	<p>This methodology adopts a bottom-up approach that estimates the total amount of fuel consumed by the fleet by adding the new cars entering the market by fuel type to the existing fleet and applying a scrap rate to the whole fleet, an average travel distance and an average car efficiency rate by fuel type.</p> <p>Starting to grow fast again, administrative sources in Brazil seems to be evolving in terms of data provision due to the need to invest in infrastructure. Nevertheless there are still a lot of difficulties finding the data needed. For example, there are no national or regional data on transport demand such as passenger kilometre (pkm) and tonne kilometre (tkm).</p>	

<b>Background</b>	<b>Country</b>	Canada	<b>T/Ad/04</b>
	<b>Organisation</b>	Natural Resources Canada	
	<b>Data collection purpose</b>	To help run the transportation model	
<b>Data collection</b>	<b>Sources</b>	<ul style="list-style-type: none"> <li>• International organisations</li> <li>• Government agency</li> <li>• Industry experts</li> </ul>	
	<b>Data collected</b>	<ul style="list-style-type: none"> <li>• Canadian vehicles in operation from DesRosiers Automotive Consultants Inc.</li> <li>• Canadian New Vehicle Registrations Medium and Heavy from R.L. Polk Canada Inc.</li> <li>• Passenger Cars and Light Trucks New Vehicle Registrations from R.L. Polk Canada Inc.</li> <li>• Vehicle fuel economy information system from Transport Canada</li> </ul>	
<b>Comments</b>	<b>Main challenges</b>	High cost to obtain data	
	<b>Additional observations</b>		

<b>Background</b>	<b>Country</b>	Ireland	<b>T/Ad/05</b>
	<b>Organisation</b>	Sustainable Energy Authority of Ireland	
	<b>Data collection purpose</b>	To model overall energy use by car with inputs from administrative sources such as weighted averages of fuel efficiency and mileage by engine size (albeit using assumptions for on-road efficiency derived from test efficiency)	
<b>Data collection</b>	<b>Sources</b>	<ul style="list-style-type: none"> <li>• Vehicle registration database</li> <li>• National Car Test database</li> <li>• EU database on car fuel efficiency and CO<sub>2</sub> emissions</li> </ul>	
	<b>Data collected</b>	<p>New vehicles each year by make, model, engine size, fuel, emissions label, etc. These are linked to the EU database on fuel efficiency and CO<sub>2</sub> emissions to derive sales-weighted fuel efficiency and CO<sub>2</sub> emissions overall and by engine size.</p> <p>From the National Car Test, odometer readings are used to produce weighted average annual mileage by engine size and fuel type.</p>	
<b>Comments</b>	<b>Main challenges</b>	<ul style="list-style-type: none"> <li>• Time-consuming to gather data</li> <li>• Took a long time to establish a relationship with the organisation</li> </ul>	
	<b>Additional observations</b>		

<b>Background</b>	<b>Country</b>	Israel*	<b>T/Ad/06</b>
	<b>Organisation</b>	Central Bureau of Statistics	
	<b>Data collection purpose</b>	To derive transport activity data	
<b>Data collection</b>	<b>Sources</b>	Ministry of Transport	
	<b>Data collected</b>	<ul style="list-style-type: none"> <li>• Type of vehicle</li> <li>• Registration date</li> <li>• Engine capacity</li> <li>• Type of fuel</li> <li>• Gross weight</li> </ul>	
<b>Comments</b>	<b>Main challenges</b>	Took a long time to establish a relationship with the organisation	
	<b>Additional observations</b>		

\* See Annex F.

<b>Background</b>	<b>Country</b>	Japan	<b>T/Ad/07</b>
	<b>Organisation</b>	Japan Automobile Manufactures Association, Libertas Terra Co. Ltd.	
	<b>Data collection purpose</b>	To collect various transport energy and activity data	
<b>Data collection</b>	<b>Sources</b>	<ul style="list-style-type: none"> <li>• Government statistics office</li> <li>• Manufacturers</li> <li>• International organisations</li> </ul>	
	<b>Data collected</b>	<ul style="list-style-type: none"> <li>• Statistical Survey on Motor Vehicle Transport (Ministry of Land, Infrastructure, Transport and Tourism)</li> <li>• General Energy Statistics (Energy Balance Table, Agency for Natural Resources and Energy)</li> <li>• Average new-car fuel economy (Ministry of Land, Infrastructure)</li> </ul>	
<b>Comments</b>	<b>Main challenges</b>	<ul style="list-style-type: none"> <li>• Time-consuming to gather data</li> <li>• It is difficult to align the time axis of the data</li> </ul>	
	<b>Additional observations</b>	The Japanese government has been vigorously collecting various data related to transportation. Data have been well controlled, and over the Internet, have been widely available to the public. As of now, the data are available only in Japanese.	



<b>Background</b>	Country	Korea	<b>T/Ad/08</b>
	Organisation	Korea National Oil Corporation	
	Data collection purpose	To prepare national oil supply-and-demand statistics	
<b>Collection</b>	Sources	Manufacturers	
	Data collected	Imports, exports, sales, production, stocks of crude oil and final oil products	
<b>Comments</b>	Main challenges	<ul style="list-style-type: none"> <li>• In paper format – difficult to transfer to digital format</li> <li>• Definition issues within a sector</li> </ul>	
	Additional observations		

<b>Background</b>	Country	Mexico	<b>T/Ad/09</b>
	Organisation	Ministry of Energy	
	Data collection purpose		
<b>Data collection</b>	Sources	<ul style="list-style-type: none"> <li>• Government statistics office</li> <li>• Transport and Communication Federal Secretariat (Secretaria de Comunicaciones y Transportes, SCT)</li> <li>• Local transport secretariats for main cities in Mexico: Ciudad de Mexico, Guadalajara and Monterrey</li> </ul>	
	Data collected	<ul style="list-style-type: none"> <li>• Traffic indicators for rail, water and air transport modes such as pkm and tkm</li> <li>• Average distance travelled by transport mode</li> <li>• Number of vehicles or carriers registered in the country by transport mode</li> </ul>	
<b>Comments</b>	Main challenges	<ul style="list-style-type: none"> <li>• In paper format – difficult to transfer to digital format</li> <li>• Definition issues within a sector</li> <li>• Data were incomplete</li> </ul>	
	Additional observations		

<b>Background</b>	Country	New Zealand	<b>T/Ad/10</b>
	Organisation	Ministry of Transport	
	Data collection purpose	To use the data in statistics publications, research, policy development and the emissions model	
<b>Collection</b>	Sources	<ul style="list-style-type: none"> <li>• New Zealand vehicle database</li> <li>• Mandatory vehicle inspection results (in New Zealand vehicles are inspected every 6 or 12 months)</li> </ul>	
	Data collected	<ul style="list-style-type: none"> <li>• Fuel test cycle results</li> <li>• Odometer readings</li> </ul>	
<b>Comments</b>	Main challenges	Data were incomplete	
	Additional observations		

<b>Background</b>	Country	Australia	<b>T/Su/01</b>	
	Organisation	Australian Bureau of Statistics		
	Name of the survey	Survey of Motor Vehicle Use		
	Vehicle type covered	<ul style="list-style-type: none"> <li>• Passenger light-duty vehicles</li> <li>• Freight trucks</li> <li>• Buses</li> </ul>		
	Survey purpose	<ul style="list-style-type: none"> <li>• To understand fuel consumption trends by transportation mode</li> <li>• To track average fuel consumption per unit of distance travelled</li> </ul>		
<b>Data collection</b>	Sample design	Stratified random sampling approach		
	Sample sources	Plate registration list		
	Population description	This survey relates purely to motor vehicles registered for road use (passenger light-duty vehicles, trucks, buses, etc.).		
	Collection methods	Paper form sent by mail		
	Sample/Population size	16 000/16 000 000	Response rate	84%
	Frequency	Every two years		
	Time to complete survey	Not available	Mandatory	Yes
	Incentive	The co-operation of providers is always sought in the first instance. The Census and Statistics Act 1907 gives the Australian Statistician the power to issue a notice of direction to non-respondents. If the non-respondent fails to provide data in response to the notice then the statistician can seek a fine.		
	Survey respondents	Registered road vehicle owners (government and private)		
Elements collected	<ul style="list-style-type: none"> <li>• Vehicle fuel efficiency</li> <li>• Type and volume of annual fuel consumed</li> <li>• Distance travelled</li> <li>• Vehicle size (weight/capacity/volume)</li> <li>• Vehicle age group</li> </ul>			
<b>Comments</b>	Main challenges	<ul style="list-style-type: none"> <li>• Incomplete survey</li> <li>• Inconsistent responses</li> <li>• Response quality</li> </ul>		
	Possible improvements			
	Key best practice			
	Other documentation			

<b>Background</b>	Country	Canada	<b>T/Su/02</b>	
	Organisation	Transport Canada		
	Name of the survey	Canadian Vehicle Use Study		
	Vehicle type covered	Passenger light-duty vehicles: car, van, SUV, pickup truck, other truck		
	Survey purpose	<ul style="list-style-type: none"> <li>• To derive energy consumption in the transportation sector</li> <li>• To estimate regional diffusion of various transportation modes</li> <li>• To understand fuel consumption trends by transportation mode</li> <li>• To track average fuel consumption per unit of distance travelled</li> <li>• To collect information on motor vehicle use to help understand driving behaviour, observe trends in use across the country and over time, and aid in the development of programmes and policies to improve road safety, lower fuel consumption, and reduce air pollution and related emissions</li> </ul>		
<b>Data collection</b>	Sample design	Stratified random sampling approach		
	Sample sources	Plate registration list		
	Population description	Activity data are collected electronically via a portable onboard data logger, which connects on all 1996 and newer light vehicles. Light vehicles include passenger cars, pickup/cargo, minivans and SUVs.		
	Collection methods	<ul style="list-style-type: none"> <li>• Paper form sent by mail</li> <li>• Telephone interview</li> </ul>	<ul style="list-style-type: none"> <li>• Electronic portable onboard data logger</li> </ul>	
	Sample/Population size	20 000 / 20 000 000	Response rate	25%
	Frequency	Every year		
	Time to complete survey	5 minutes	Mandatory	Voluntary
	Incentive	Cash or other monetary incentives		
	Survey respondents	Private vehicle owners, fleet carriers		
Elements collected	<ul style="list-style-type: none"> <li>• Total energy consumption</li> <li>• Vehicle fuel efficiency</li> <li>• Type and volume of annual fuel consumed</li> <li>• Vehicle kilometres (vkm)</li> <li>• pkm</li> <li>• Motive for trip</li> <li>• Vehicle size (weight/ capacity)</li> <li>• Vehicle age group</li> <li>• Unit fuel cost</li> </ul>	<ul style="list-style-type: none"> <li>• Total annual fuel cost</li> <li>• In total, more than 50 fields of information collected: number of study days, number of active days (actual drive), number of trips, driving time, idling time, trip length, trip duration, vehicle speed, vehicle location (GPS), engine temperature, day type (e.g. weekday versus weekend) etc.</li> </ul>		
<b>Comments</b>	Main challenges	<ul style="list-style-type: none"> <li>• Low response rate</li> <li>• Incomplete survey</li> <li>• Quality of the interviewing staff</li> <li>• Recruiting, training and retaining project staff</li> </ul>	<ul style="list-style-type: none"> <li>• Participants accepting to participate and not participating</li> <li>• In some cases it is challenging to retrieve the monitoring equipment</li> </ul>	
	Possible improvements	At this point the effort is to increase the participation rate, by offering better incentives, the information through a website, participant reports, tips for drivers, quarterly results. Also, it is important to understand the non-respondents.		
	Key best practice	Regular biweekly meetings with surveying team to discuss all points needed to improve (issues, challenges, items not required anymore, adapt the phone script if necessary)		
	Other documentation	Available: questionnaire		

<b>Background</b>	Country	Czech Republic	<b>T/Su/03</b>	
	Organisation	Ministry of Industry and Trade		
	Name of the survey	Statistical Reports		
	Vehicle type covered			
	Survey purpose	To derive energy consumption in the transportation sector		
<b>Data collection</b>	Sample design	According to certain characteristics		
	Sample sources			
	Population description	According to NACE		
	Collection methods	<ul style="list-style-type: none"> <li>• Paper form sent by mail</li> <li>• Internet based</li> </ul>		
	Sample size	6 000	Response rate	80%
	Frequency	Every year		
	Time to complete survey	80 minutes	Mandatory	Yes
	Incentive	A fine		
	Survey respondents	Private vehicle owners, air carriers, railway carriers		
	Elements collected	<ul style="list-style-type: none"> <li>• Total energy consumption</li> <li>• Unit fuel cost</li> </ul>		
<b>Comments</b>	Main challenges	<ul style="list-style-type: none"> <li>• Low response rate</li> <li>• Incomplete survey</li> <li>• Inconsistent responses</li> <li>• Response quality</li> <li>• Lack of resources</li> </ul>		
	Possible improvements	Improve communication with respondents; better funding		
	Key best practice			
	Other documentation	Available: URL link		

		T/Su/04		
<b>Background</b>	Country	France		
	Organisation	Ministry of Ecology, Sustainable Development and Energy		
	Name of the survey	National Transportation Survey		
	Vehicle type covered	<ul style="list-style-type: none"> <li>Passenger vehicles: car, van, SUV, pickup truck, other truck, taxi, bicycle, motorhome (RV), motorcycle</li> <li>Bus: city, intercity, tour</li> <li>Air: commercial, charter</li> <li>Rail: subway, commuter</li> <li>Ship: cruise, passenger ferry, sailboat</li> </ul>		
	Survey purpose	<ul style="list-style-type: none"> <li>To derive energy consumption in the transportation sector</li> <li>To estimate regional diffusion of various transportation modes</li> <li>To understand fuel consumption trends by transportation mode</li> <li>To get a global and coherent vision of all the modes in Metropolitan France</li> <li>To estimate pkm covered by the households</li> <li>To describe the vehicles (car, bike, motorcycle, motorhome, etc.) used by the households</li> </ul>		
<b>Data collection</b>	Sample design	Stratified random sampling approach		
	Sample sources	National census		
	Population description	Every aspect of personal mobility and every mode of transportation (by foot, bike, motorcycle, car, bus, train, plane, etc.) are included. Commercial trips are excluded.		
	Collection methods	Computer-assisted personal interview		
	Sample/Population size	20 178 / 27 000 000 households	Response rate	Not available
	Frequency	No regular survey cycle		
	Time to complete survey	60 minutes	Mandatory	Yes
	Incentive	None		
	Survey respondents	The household (the individuals) and one vehicle of the household		
Elements collected	<ul style="list-style-type: none"> <li>Total energy consumption</li> <li>Pkm</li> <li>Purpose of trip</li> <li>Vehicle age group</li> </ul>			
<b>Comments</b>	Main challenges	<ul style="list-style-type: none"> <li>Incomplete survey</li> <li>Inconsistent responses</li> <li>Response quality</li> </ul>		
	Possible improvements	Existing survey could be improved by further simplifying the survey questions and length		
	Key best practice			
	Other documentation	Available: questionnaire, report, reference		

		<b>T/Su/05</b>		
<b>Background</b>	Country	France		
	Organisation	Ministry of Ecology, Sustainable Development and Energy		
	Name of the survey	Survey on fuel consumption of personal cars		
	Vehicle type covered	Passenger light-duty vehicles		
	Survey purpose	<ul style="list-style-type: none"> <li>• To derive energy consumption in the transportation sector</li> <li>• To track average fuel consumption per unit of distance travelled</li> <li>• To derive a global circulation in terms of vkm</li> </ul>		
<b>Data collection</b>	Sample design	There is no specific sampling method. "Volunteers" are required by Kantar Worldpanel, the company in charge of the survey. The statistical representativeness is guaranteed due to post-survey statistical treatments		
	Sample sources			
	Population description	Only personal light-duty vehicles whose fuel is either gasoline or diesel are included in the survey		
	Collection methods	Paper form sent by mail		
	Sample/Population size	3 300 / 31 100 000	Response rate	84%
	Frequency	Every year		
	Time to complete survey	Not available	Mandatory	Voluntary
	Incentive	None		
	Survey respondents	Personal vehicle owners		
	Elements collected	<ul style="list-style-type: none"> <li>• Total energy consumption</li> <li>• Type and volume of annual fuel consumed</li> <li>• Vkm</li> </ul>	<ul style="list-style-type: none"> <li>• Vehicle size (capacity)</li> <li>• Vehicle age group</li> <li>• Unit fuel cost</li> <li>• Total annual fuel cost</li> </ul>	
<b>Comments</b>	Main challenges	<ul style="list-style-type: none"> <li>• Inconsistent responses</li> <li>• Response quality</li> </ul>		
	Possible improvements	Increasing the sample size		
	Key best practice	The fuel record book stays in the car and is filled by the driver each time he/she fills the tank with fuel		
	Other documentation	Available: report		



		T/Su/06		
<b>Background</b>	Country	Korea		
	Organisation	Korea Energy Management Corporation		
	Name of the survey	National Energy & GHG Emissions Survey		
	Vehicle type covered	<ul style="list-style-type: none"> <li>• Passenger vehicles: car, van, SUV, pickup truck, other truck, taxi, motorcycle</li> <li>• Freight truck: 15 tonnes or more, 1.1 tonnes to 14.9 tonnes, 1 tonne or less</li> </ul>	<ul style="list-style-type: none"> <li>• Bus: city, intercity, tour</li> <li>• Air: commercial, charter</li> <li>• Rail: subway, commuter, freight</li> <li>• Ship: freight, cruise, passenger ferry</li> </ul>	
	Survey purpose	<ul style="list-style-type: none"> <li>• To derive energy consumption in the transportation sector</li> <li>• To understand fuel consumption trends by transportation mode</li> <li>• To track average fuel consumption per unit of distance travelled</li> </ul>		
<b>Data collection</b>	Sample design	Stratified random sampling approach		
	Sample sources	Plate registration list, list of freight companies, list of public vehicles		
	Population description	All transportation modes		
	Collection methods	In-house visit		
	Sample/Population size	67 012 / 18 476 400	Response rate	90%
	Frequency	Every three years		
	Time to complete survey	30 minutes	Mandatory	Voluntary
	Incentive	Non-cash incentives such as gift coupons		
	Survey respondents	Private vehicle owners, air carriers, railway carriers, fleet carriers		
	Elements collected	<ul style="list-style-type: none"> <li>• Total energy consumption</li> <li>• Type and volume of annual fuel consumed</li> <li>• Vkm</li> <li>• Pkm</li> </ul>	<ul style="list-style-type: none"> <li>• Vehicle size (weight)</li> <li>• Vehicle size (capacity)</li> <li>• Vehicle age group</li> <li>• Total annual fuel cost</li> </ul>	
<b>Comments</b>	Main challenges	<ul style="list-style-type: none"> <li>• Low response rate</li> <li>• Response quality</li> </ul>		
	Possible improvements			
	Key best practice			
	Other documentation	Available: questionnaires		

		<b>T/Su/07</b>		
<b>Background</b>	Country	Mexico		
	Organisation	Ministry of Energy		
	Name of the survey	Survey on Fuel Consumption in the Cargo and Passenger Road Transport Sector by Mode		
	Vehicle type covered	<ul style="list-style-type: none"> <li>● Passenger vehicles: car, van, SUV, pickup truck, other truck, taxi, motorhome (RV), motorcycle</li> <li>● Bus: city, intercity, tour</li> <li>● Freight truck: up to 4.5 tonnes, 4.5 tonnes to 14.9 tonnes, 15 tonnes or more</li> </ul>		
	Survey purpose	<ul style="list-style-type: none"> <li>● To track average fuel consumption per unit of distance travelled</li> <li>● To learn about the travel patterns of passengers and freights by mode</li> </ul>		
<b>Data collection</b>	Sample design	Stratified random sampling approach. The sample was designed in two stages: Sample of gasoline, diesel and LPG filling stations stratified according to SENER region, sales volume and other characteristics of the filling stations Equal probability of selection of the vehicles at the filling station selected in stage 1.		
	Sample sources			
	Population description	All type of road vehicles at gasoline, diesel and LPG filling stations in the sample selected according to the region and characteristics of the station		
	Collection methods	Questionnaire applied <i>in situ</i> to the driver of the vehicle		
	Sample/Population size	24 630 / 28 188 362	Response rate	Not available
	Frequency	No regular survey cycle		
	Time to complete survey	4 minutes	Mandatory	Voluntary
	Incentive	None		
	Survey respondents	Drivers of the road vehicles at the gasoline, diesel and LPG filling stations		
	Elements collected	<ul style="list-style-type: none"> <li>● Total energy consumption</li> <li>● Vehicle fuel efficiency</li> <li>● Type and volume of annual fuel consumed</li> <li>● Vkm</li> <li>● Pkm</li> <li>● Vehicle size (capacity)</li> </ul>	<ul style="list-style-type: none"> <li>● Vehicle age group</li> <li>● Unit fuel cost</li> <li>● Vehicle purchased as new or used, use of air conditioner, tenure of vehicle insurance, maintenance and mechanical characteristics of the vehicle (tuning, mechanical problems and verification)</li> </ul>	
<b>Comments</b>	Main challenges	<ul style="list-style-type: none"> <li>● Inconsistent responses</li> <li>● Response quality</li> </ul>	<ul style="list-style-type: none"> <li>● Bias from the interviewer</li> </ul>	
	Possible improvements	Changing the wording of some questions, establishing other ways to ask or get the information required, retaining and training the project and interviewing staff, improving the representativeness of the sample for trucks, among others.		
	Key best practice			
	Other documentation	Available: questionnaire		

<b>Background</b>	Country	New Zealand		<b>T/Su/08</b>
	Organisation	Ministry of Transport		
	Name of the survey	Statistics New Zealand Energy End Use Survey (or similar)		
	Vehicle type covered	It is not constructed at the mode level of detail		
	Survey purpose	To derive energy consumption in the transportation sector		
<b>Data collection</b>	Sample design	Stratified random sampling approach		
	Sample sources			
	Population description	A series of rolling surveys of different sectors of the economy		
	Collection methods	Paper form sent by mail		
	Sample/Population size	Not available	Response rate	80%
	Frequency	Every three years		
	Time to complete survey	Not available	Mandatory	Voluntary
	Incentive	None		
	Survey respondents	A survey of different sectors of the economy including farms, fishing, forestry, industrial, distribution		
Elements collected	<ul style="list-style-type: none"> <li>• Total energy consumption</li> <li>• Type and volume of annual fuel consumed</li> </ul>			
<b>Comments</b>	Main challenges	Response quality		
	Possible improvements	The quality was good, but some questions have been improved after finding out what most troubled the respondents		
	Key best practice			
	Other documentation	Available: report, URL link		

		T/Su/09		
<b>Background</b>	Country	Sweden		
	Organisation	Energimyndigheten		
	Name of the survey	Monthly Fuel Gas and Inventory Statistics		
	Vehicle type covered	<ul style="list-style-type: none"> <li>• Passenger vehicles: car, van, SUV, pickup truck, other truck, taxi, bicycle, motorhome (RV), motorcycle</li> <li>• Freight truck: up to 4.5 tonnes, 4.5 tonnes to 14.9 tonnes, 15 tonnes or more</li> <li>• Bus: city, intercity, tour</li> <li>• Air: commercial, charter</li> <li>• Rail: subway, commuter, freight</li> <li>• Ship: freight, cruise, passenger ferry, sailboat</li> </ul>		
Survey purpose	To derive energy consumption in the transportation sector			
<b>Data collection</b>	Sample design	Census		
	Sample sources			
	Population description	All companies delivering oil products to the Swedish market		
	Collection methods	Internet based		
	Sample/Population size	200 / 200	Response rate	100%
	Frequency	Every year		
	Time to complete survey	Not available	Mandatory	Yes
	Incentive	A fine		
	Survey respondents	Oil companies		
Elements collected	<ul style="list-style-type: none"> <li>• Total energy consumption</li> <li>• Type and volume of annual fuel consumed</li> </ul>			
<b>Comments</b>	Main challenges	Inconsistent responses		
	Possible improvements			
	Key best practice			
	Other documentation	Available: questionnaire		

<b>Background</b>	Country	Ukraine	<b>T/Su/10</b>	
	Organisation	State Statistics Committee of Ukraine		
	Name of the survey	Consumption of fuel, heat power and energy; Stocks and use of energy materials and oil-processing products; Sale of oil products by fuel filling stations		
	Vehicle type covered	Surveyed legal units that consume fuels that can be split by economic activities, such as railway companies, airline companies, etc.		
	Survey purpose	<ul style="list-style-type: none"> <li>• To derive energy consumption in the transportation sector</li> <li>• To understand fuel consumption trends by transportation mode</li> </ul>		
<b>Data collection</b>	Sample design	Census		
	Sample sources	National census		
	Population description	Reports are provided by all legal units that consume or sell fuel. Legal units can be classified by mode of transport.		
	Collection methods	<ul style="list-style-type: none"> <li>• Paper form sent by mail</li> <li>• Internet based</li> </ul>		
	Sample/Population size	9 000 / 9 000	Response rate	100%
	Frequency	Every year		
	Time to complete survey	180 minutes	Mandatory	Yes
	Incentive	A fine		
	Survey respondents	Private vehicle owners, air carriers, railway carriers, vehicle manufacturers, fleet carriers		
	Elements collected	<ul style="list-style-type: none"> <li>• Total energy consumption</li> <li>• Vehicle fuel efficiency</li> <li>• Total annual fuel cost</li> <li>• Sale of oil products</li> </ul>		
<b>Comments</b>	Main challenges	The number of respondents is too large		
	Possible improvements	Shift from census to sample-based survey, simplification of the questionnaire		
	Key best practice			
	Other documentation	Available: see industry questionnaire		

<b>Background</b>	<b>Country</b>	Canada	<b>T/Me/01</b>
	<b>Organisation</b>	Transport Canada	
	<b>Name of the project</b>	Canadian Vehicle Use Study (CVUS)	
	<b>Vehicle type covered</b>	Passenger light-duty vehicles: car, van, SUV, pickup truck	
	<b>Project purpose</b>	<ul style="list-style-type: none"> <li>• To understand fuel consumption trends over time by various transportation modes</li> <li>• To understand impact of a carrier utilisation pattern on fuel economy</li> <li>• To track average fuel consumption per unit of distance travelled</li> <li>• To reduce consumption of fuel</li> <li>• To reduce expenses on fuel</li> <li>• To complement a model with energy consumption patterns</li> </ul>	
<b>Data collection</b>	<b>Sample design</b>	Stratified random sampling approach	
	<b>Sample sources</b>	National census, plate registration list	
	<b>Population description</b>	For the moment, the CVUS targets only passenger light-duty vehicles such as pickup truck, minivan, SUV	
	<b>Equipment used</b>	<ul style="list-style-type: none"> <li>• GPS data logger – OttoView</li> <li>• Suction cup</li> <li>• OBD cable</li> </ul>	
	<b>Sample/Population size</b>	20 000 / 20 000 000	
	<b>Frequency</b>	Every year	
	<b>Time to collect measurements</b>	21 days	
	<b>Who took measurements</b>	Carrier/vehicle operators	
	<b>Elements measured</b>	<ul style="list-style-type: none"> <li>• Trip patterns over time</li> <li>• Fuel consumption over time</li> <li>• Carrier utilisation pattern and impact on fuel economy</li> <li>• Impact of fuel switching on vehicle fuel economy</li> <li>• Same as described in the survey</li> </ul>	
<b>Comments</b>	<b>Main challenges</b>	<ul style="list-style-type: none"> <li>• Malfunctioning equipment</li> <li>• Lack of understanding, lack of proper training on the equipment</li> <li>• Communication difficulties with respondents</li> </ul>	
	<b>Recommendations</b>		
	<b>Key best practice</b>	Please see survey entry	
	<b>Other documentation</b>	Available: see survey entry, URL link	

<b>Background</b>	Country	Brazil	<b>T/Mo/O1</b>
	Organisation	Centro Clima	
	Name of the model	Light Vehicles Fleet, Consumption and GHG Emissions Projection Model	
	Modes covered	Passenger light-duty vehicles: car, SUV, taxi	
	Model purpose	<ul style="list-style-type: none"> <li>• To estimate energy consumption by mode type</li> <li>• To estimate regional energy consumption profile by mode type</li> <li>• To estimate total energy consumption in the transport sector</li> <li>• To undertake policy scenario analysis</li> <li>• To estimate GHG emissions</li> </ul>	
<b>Data inputs/outputs</b>	Model type	<ul style="list-style-type: none"> <li>• Bottom-up statistical model</li> <li>• Custom-built model</li> </ul>	
	Results validated	Yes: the model is used to make projections for the period 1990–2005, and then compared with real data to calibrate it	
	Frequency	No regular survey cycle	
	Key model inputs	<ul style="list-style-type: none"> <li>• Vehicle penetration by mode</li> <li>• Fuel economy by mode</li> <li>• Type of travel by mode</li> <li>• Fuel consumption by mode</li> <li>• Pkm by mode</li> <li>• Physical characteristics by mode (e.g. weight, life cycle)</li> <li>• Technology diffusion (internal combustion, hybrid, electric)</li> <li>• Fuel prices</li> <li>• Energy price elasticity relationships</li> </ul>	
	Key model outputs	<ul style="list-style-type: none"> <li>• Energy consumption by mode/vehicle type</li> <li>• Fuel-switching options</li> <li>• Technology diffusion</li> <li>• Impact of energy prices on mode/vehicle activity</li> <li>• GHG emissions</li> </ul>	
<b>Comments</b>	Main challenges	<ul style="list-style-type: none"> <li>• Lack of input data</li> <li>• Quality control issues with input data</li> </ul>	
	Additional information		
	Key best practice	The model was very successful at separating energy consumption depending on the technology (four types) and the fuel used in the vehicle (three types), as well as project the fuel choice of consumers in Brazil	
	Other documentation	Available: reference	

		T/Mo/O2
<b>Background</b>	Country	Canada
	Organisation	Natural Resources Canada
	Name of the model	Transportation End-Use Model (TEUM)
	Vehicle type covered	<ul style="list-style-type: none"> <li>● Passenger light-duty vehicles: car, van, SUV, pickup truck, other truck, taxi, motorhome (RV), motorcycle</li> <li>● Freight truck: up to 4.5 tonnes, 4.5 tonnes to 14.9 tonnes, 15 tonnes or more</li> <li>● Bus: city, intercity</li> <li>● Air: commercial, charter</li> <li>● Rail: subway, commuter, freight</li> <li>● Ship: freight</li> <li>● Off-road vehicles</li> </ul>
Model purpose	<ul style="list-style-type: none"> <li>● To estimate energy consumption by mode type</li> <li>● To estimate regional energy consumption profile by mode type</li> <li>● To evaluate fuel economy profile by mode influenced by a number of factors</li> <li>● To estimate total energy consumption in the transport sector</li> <li>● To estimate the energy efficiency and the GHG emissions</li> </ul>	
<b>Data inputs/outputs</b>	Model type	Bottom-up statistical model
	Results validated	Yes: reconciliation of data with the <i>National Inventory Report</i> from Environment Canada and the <i>Report on Energy Supply and Demand in Canada</i> from Statistics Canada.
	Frequency	Every year
	Key model inputs	<ul style="list-style-type: none"> <li>● Fuel economy by mode</li> <li>● Fuel consumption by mode</li> <li>● Pkm by mode</li> <li>● Tkm</li> <li>● Vehicle stock</li> <li>● GHG emissions factors</li> </ul>
	Key model outputs	<ul style="list-style-type: none"> <li>● Energy consumption by mode/vehicle type</li> <li>● Utilisation pattern and fuel economy by mode/vehicle type</li> <li>● Fuel-switching options</li> <li>● GHG emissions</li> <li>● Activity effect, structure effect, energy efficiency effect for freight and passenger movements</li> </ul>
<b>Comments</b>	Main challenges	<ul style="list-style-type: none"> <li>● Lack of input data</li> <li>● Lack of data limits the capacity to expand the model</li> </ul>
	Additional information	The TEUM of the Office of Energy Efficiency calculates preliminary estimates for road energy use by vehicle type as well as energy use in the air, rail and marine sectors. These preliminary estimates are then calibrated to match Statistics Canada's Report on Energy Supply and Demand in Canada (RESO, cat. No. 57-003-X) to obtain final road energy use estimates.
	Key best practice	
	Other documentation	Available: report



<b>Background</b>	Country	New Zealand	<b>T/Mo/03</b>
	Organisation	Ministry of Transport	
	Name of the model	Vehicle Fleet Emissions Model	
	Vehicle type covered	<ul style="list-style-type: none"> <li>• Passenger light-duty vehicles: car, van, SUV, pickup truck, other truck, taxi, motorcycle</li> <li>• Bus: city, intercity</li> </ul>	<ul style="list-style-type: none"> <li>• Freight truck: up to 4.5 tonnes, 4.5 tonnes to 14.9 tonnes, 15 tonnes or more</li> </ul>
	Model purpose	<ul style="list-style-type: none"> <li>• To estimate total energy consumption in the transport sector</li> <li>• To undertake policy scenario analysis</li> </ul>	
<b>Data inputs/outputs</b>	Model type	<ul style="list-style-type: none"> <li>• Bottom-up statistical model</li> <li>• Custom-built model</li> </ul>	
	Results validated	Yes: compare predicted figures with actual energy use	
	Frequency	Every year	
	Key model inputs	<ul style="list-style-type: none"> <li>• Vehicle penetration by mode</li> <li>• Fuel economy by mode</li> <li>• Fuel consumption by mode</li> <li>• Physical characteristics by mode (e.g. weight, life cycle)</li> <li>• Fuel prices</li> <li>• Transport demand (private, freight, public)</li> <li>• Energy price elasticity relationships</li> </ul>	
	Key model outputs	<ul style="list-style-type: none"> <li>• Energy consumption by mode/vehicle type</li> <li>• Technology evolution</li> <li>• Future fleet and energy use projections</li> </ul>	
<b>Comments</b>	Main challenges	Lack of input data	
	Additional information	Truck fuel use factors have been a data gap	
	Key best practice		
	Other documentation		

<b>Background</b>	<b>Country</b>	Switzerland	<b>T/Mo/04</b>
	<b>Organisation</b>	Swiss Federal Office of Energy; Infrast	
	<b>Name of the model</b>	Transport Energy Consumption Model	
	<b>Vehicle type covered</b>	<ul style="list-style-type: none"> <li>• Passenger light-duty vehicles: car, van, SUV, pickup truck, other truck, taxi, bicycle, motorhome (RV), motorcycle</li> <li>• Freight truck: up to 4.5 tonnes, 4.5 tonnes to 14.9 tonnes, 15 tonnes or more</li> <li>• Bus: city, intercity, tour</li> </ul>	<ul style="list-style-type: none"> <li>• Air: commercial, charter</li> <li>• Rail: subway, commuter, freight</li> <li>• Ship: freight, cruise, passenger ferry, sailboat</li> <li>• Other: off-road: vehicles used for construction, agriculture, forestry, gardening/hobby, military</li> </ul>
	<b>Model purpose</b>	<ul style="list-style-type: none"> <li>• To estimate energy consumption by mode type</li> <li>• To estimate energy consumption by determinant factors. The basic model was developed for energy perspectives, but also serves for the <i>ex post</i> analysis of energy consumption by end use (mode type) and by determinant factors. The model is calibrated to Swiss energy statistics from 1990 to the latest available year.</li> </ul>	
<b>Data inputs/outputs</b>	<b>Model type</b>	<ul style="list-style-type: none"> <li>• Bottom-up energy-economic model, close to bottom-up engineering model, but using further inputs such as fuel sales, vehicle stocks, mileage per person or tonnage, age and weight structures, life cycles, driving behaviour, vehicle turnover, etc. for passengers and freights, private and public transports, and different modes and different types of transport (road, rail, air, ship, off-road). The model is mainly based on administrative data (Federal Office of Statistics, etc.), but also uses data from utilities, manufacturers and national associations. The model is based on Swiss statistics on transport, fuel sales, electricity and population; federal vehicle register; vehicle information system; periodic survey on driving performance, performance-related heavy vehicle fee; gross domestic product (GDP); energy prices.</li> <li>• Custom-built model</li> </ul>	
	<b>Results validated</b>	Yes: calibration with Swiss overall energy statistics	
	<b>Frequency</b>	Every year	
	<b>Key model inputs</b>	<ul style="list-style-type: none"> <li>• Vehicle penetration by mode</li> <li>• Type of travel by mode</li> <li>• Fuel consumption by mode</li> <li>• Pkm by mode</li> </ul>	<ul style="list-style-type: none"> <li>• Physical characteristics by mode (e.g. weight, life cycle)</li> <li>• Fuel prices</li> <li>• Transport demand (private, freight, public)</li> </ul>
	<b>Key model outputs</b>	<ul style="list-style-type: none"> <li>• Energy consumption by mode/vehicle type</li> <li>• Energy consumption by determinant factors</li> </ul>	
<b>Comments</b>	<b>Main challenges</b>	<ul style="list-style-type: none"> <li>• Lack of input data</li> <li>• Including new trends whenever possible</li> </ul>	
	<b>Additional information</b>	The analysis of energy consumption by end use is based on the models developed for the energy perspectives. Fifteen years of experience and annual model runs have helped to increase the number of inputs in all fields of data sources.	
	<b>Key best practice</b>		
	<b>Other documentation</b>	Available: report	

<b>Background</b>	Country	United Kingdom	<b>T/Mo/05</b>
	Organisation	Department of Energy and Climate Change	
	Name of the model	AEA Surface Transport Consumption Model	
	Vehicle type covered	<ul style="list-style-type: none"> <li>• Passenger light-duty vehicle: car, van, SUV, pickup truck, other truck, taxi, motorhome (RV), motorcycle</li> </ul>	<ul style="list-style-type: none"> <li>• Freight truck</li> <li>• Bus: city, intercity, tour</li> <li>• Rail: subway, commuter, freight</li> </ul>
	Model purpose	To estimate energy consumption by mode type	
<b>Data inputs/outputs</b>	Model type	<ul style="list-style-type: none"> <li>• Bottom-up statistical model, bottom-up engineering model</li> <li>• Custom-built model</li> </ul>	
	Results validated	Yes: the results from the bottom-up model are compared with the total consumption for surface transport and are very consistent.	
	Frequency	Every year	
	Key model inputs	<ul style="list-style-type: none"> <li>• Vehicle penetration by mode</li> <li>• Fuel economy by mode</li> <li>• Fuel consumption by mode</li> <li>• Pkm by mode</li> <li>• Physical characteristics by mode (e.g. weight, life cycle)</li> <li>• Transport demand (private, freight, public)</li> </ul>	
	Key model outputs	<ul style="list-style-type: none"> <li>• Energy consumption by mode/vehicle type</li> <li>• GHG emissions</li> </ul>	
<b>Comments</b>	Main challenges		
	Additional information		
	Key best practice		
	Other documentation		

# Annex E

## References

De Almeida A., Fonseca P, Schломann B. and N. Feilberg (2011), Characterization of the household electricity consumption in the EU, potential energy savings and specific policy recommendations, *Journal of Energy and Buildings*, Vol. 43, No. 8, Elsevier, Amsterdam, pp. 1884-1894.

EIA (2012), *Derived annual estimates of residential energy consumption 2001 through 2006*, US Energy Information Administration, Washington DC.

Eurostat (2013), *Manual for statistics on energy consumption in households*, Eurostat, Luxembourg.

Fulton L., P. Cazzola and F. Cuenot (2009), *IEA Mobility Model (MoMo) and its use in the ETP 2008*, *Energy Policy*, Vol. 37, No. 10, Elsevier, Amsterdam, pp. 3758-3768.

IEA (2005), *Energy Statistics Manual*, International Energy Agency, OECD Publishing, Paris.

IEA (2007), *Tracking Industrial Energy Efficiency and CO<sub>2</sub> Emissions*, OECD Publishing, Paris.

IEA (2012), *Energy Technology Perspectives*, International Energy Agency, OECD Publishing, Paris.

IEA (2013), *Energy Efficiency Market Report*, International Energy Agency, OECD Publishing, Paris.

IEA (2013), *World Energy Outlook*, International Energy Agency, OECD Publishing, Paris.

IEA (2014), *Energy Efficiency Indicators: essentials for policy making*, International Energy Agency, OECD Publishing, Paris.

ICCT (International Council on Clean Transportation) (2013), *From Laboratory to Road*, ICCT, Washington DC. [http://www.theicct.org/sites/default/files/publications/ICCT\\_LabToRoad\\_20130527.pdf](http://www.theicct.org/sites/default/files/publications/ICCT_LabToRoad_20130527.pdf).

ITF (2009), *Illustrated Glossary for Transport Statistics*, fourth edition, International Transport Forum - Eurostat - United Nations Economic Commission for Europe, 2009. <http://www.internationaltransportforum.org/Pub/pdf/09GloStat.pdf>.

Masanet, E., M. Ting, E. Worrell, A.H. Sanstad, M. Marsidi, R. Bhavirkar, and M. Rufo (2009), *Estimation of Long-Term Energy Efficiency Potentials for California Buildings and Industry*. California Energy Commission, PIER-Energy-Related Environmental Research Program, Sacramento, California.

NREL (2000), *Impact of Vehicle Air-Conditioning on Fuel Economy, Tailpipe Emissions, and Electric Vehicle Range*, National Renewable Energy Laboratory, Golden, Colorado. <http://www.nrel.gov/docs/fy00osti/28960.pdf>.

UN (2005), Household Sample Survey in Developing and Transition Countries, United Nations, New York. <http://unstats.un.org/unsd/hhsurveys/>.

UN (2013), International Recommendations on Energy Statistics (IRES), United Nations, New York.

UNECE (2007), Handbook on Statistics on Road Traffic, United Nations Economic Commission for Europe: [http://www.unece.org/fileadmin/DAM/trans/doc/2007/wp6/handbook\\_final.pdf](http://www.unece.org/fileadmin/DAM/trans/doc/2007/wp6/handbook_final.pdf).

UNIDO (2013), International Yearbook of Industrial Statistics, UN Industrial Development Organisation, Vienna.

USDOT (2013), Traffic monitoring guide, US Department of Transportation, September 2013: [http://www.fhwa.dot.gov/policyinformation/tmgguide/tmg\\_fhwa\\_pl\\_13\\_015.pdf](http://www.fhwa.dot.gov/policyinformation/tmgguide/tmg_fhwa_pl_13_015.pdf).

WBCSD (2009) Energy Efficiency in Buildings - Transforming the Market, World Business Council for Sustainable Development, Geneva.

# Annex F

## Country Notes

### Cyprus

#### 1. Note by Turkey:

The information in this document with reference to “Cyprus” relates to the southern part of the Island. There is no single authority representing both Turkish and Greek Cypriot people on the Island. Turkey recognises the Turkish Republic of Northern Cyprus (TRNC). Until a lasting and equitable solution is found within the context of the United Nations, Turkey shall preserve its position concerning the “Cyprus issue”.

#### 2. Note by all the European Union Member States of the OECD and the European Union:

The Republic of Cyprus is recognised by all members of the United Nations with the exception of Turkey. The information in this document relates to the area under the effective control of the Government of the Republic of Cyprus.

### Israel

The statistical data for Israel are supplied by and under the responsibility of the relevant Israeli authorities. The use of such data by the OECD is without prejudice to the status of the Golan Heights, East Jerusalem and Israeli settlements in the West Bank under the terms of international law.



International  
Energy Agency

online  
bookshop

[www.iea.org/books](http://www.iea.org/books)

PDF versions  
at 20% discount

International Energy Agency  
9 rue de la Fédération  
75739 Paris Cedex 15, France

Tel: +33 (0)1 40 57 66 90  
E-mail: [books@iea.org](mailto:books@iea.org)



International  
Energy Agency  
1974•2014

Secure • Sustainable • Together

This document and any map included herein are without prejudice to the status of or sovereignty over any territory, to the delimitation of international frontiers and boundaries, and to the name of any territory, city or area.

This publication reflects the views of the IEA Secretariat but does not necessarily reflect those of individual IEA member countries. The IEA makes no representation or warranty, express or implied, in respect of the publication's contents (including its completeness or accuracy) and shall not be responsible for any use of, or reliance on, the publication.

**IEA PUBLICATIONS, 9 rue de la Fédération, 75739 Paris Cedex 15**  
**Layout by IEA and printed in France by Jouve, May 2014**  
**Cover design: IEA, photo credits: © GraphicObsession**

The paper used for this document has received certification from the Programme for the Endorsement of Forest Certification (PEFC) for being produced respecting PEFC's ecological, social and ethical standards. PEFC is an international non-profit, non-governmental organization dedicated to promoting Sustainable Forest Management (SFM) through independent third-party certification.