



A340-500/-600

AIRCRAFT CHARACTERISTICS AIRPORT AND MAINTENANCE PLANNING

AC

The content of this document is the property of Airbus.
It is supplied in confidence and commercial security on its contents must be maintained.
It must not be used for any purpose other than that for which it is supplied, nor may
information contained in it be disclosed to unauthorized persons.
It must not be reproduced in whole or in part without permission in writing from the owners of
the copyright. Requests for reproduction of any data in this document and the media authorized
for it must be addressed to Airbus.

© AIRBUS S.A.S. 2005. All rights reserved.

*AIRBUS S.A.S.
Customer Services
Technical Data Support and Services
31707 Blagnac Cedex
FRANCE*

A340-500/-600

AIRCRAFT CHARACTERISTICS - AIRPORT AND MAINTENANCE PLANNING

HIGHLIGHTS

Revision No. 19 - Jun 01/20

LOCATIONS	CHG CODE	DESCRIPTIONS OF CHANGE

LIST OF EFFECTIVE CONTENT
Revision No. 19 - Jun 01/20

CONTENT	CHG CODE	LAST REVISION DATE
<u>CHAPTER 1</u>		
Subject 1-1-0		
Introduction		Jan 01/17
Subject 1-2-1		
Glossary		Jan 01/17
<u>CHAPTER 2</u>		
Subject 2-1-1		
General Aircraft Characteristics Data		Apr 01/20
Subject 2-2-0		
General Aircraft Dimensions		Jan 01/17
FIGURE General Aircraft Dimensions		Jan 01/14
FIGURE General Aircraft Dimensions		Jan 01/14
Subject 2-3-0		
Ground Clearances		Jan 01/17
FIGURE Ground Clearances		Oct 01/15
FIGURE Ground Clearances		Oct 01/15
FIGURE Ground Clearances - Ailerons – Up		Oct 01/15
FIGURE Ground Clearances - Ailerons – Down		Oct 01/15
FIGURE Ground Clearances - Spoilers – Extended		Oct 01/15
FIGURE Ground Clearances - Leading Edge Slats – Extended		Oct 01/15
FIGURE Ground Clearances - Trailing Edge Flaps – Extended		Oct 01/15
FIGURE Ground Clearances - Flap Tracks – Extended		Oct 01/15
FIGURE Ground Clearances - Flap Tracks – Retracted		Oct 01/15
FIGURE Ground Clearances - Flap Tracks – 1 + F		Oct 01/15
Subject 2-4-1		
Interior Arrangements - Plan View		Jan 01/17

CONTENT	CHG CODE	LAST REVISION DATE
FIGURE Interior Arrangements - Plan View - Typical Configuration		Jan 01/17
FIGURE Interior Arrangements - Plan View - Typical Configuration		Jan 01/17
Subject 2-5-0		
Interior Arrangements - Cross Section		Jan 01/14
FIGURE Interior Arrangements - Cross Section - Typical Configuration		Jan 01/14
FIGURE Interior Arrangements - Cross Section - Typical Configuration		Jan 01/14
FIGURE Interior Arrangements - Cross Section - Typical Configuration		Jan 01/14
Subject 2-6-1		
Lower Deck Cargo Compartments		Oct 01/15
FIGURE Lower Deck Cargo Compartments - Location and Dimensions		Jan 01/14
FIGURE Lower Deck Cargo Compartments - Loading Combinations		Oct 01/15
FIGURE Lower Deck Cargo Compartments - Loading Combinations		Oct 01/15
Subject 2-7-0		
Door Clearances		Oct 01/15
FIGURE Door Clearances - Door Identification		Jul 01/18
FIGURE Door Clearances - Door Identification		Jul 01/18
FIGURE Door Clearances - Forward Passenger/Crew Doors		Oct 01/15
FIGURE Door Clearances - Mid Passenger/Crew Doors		Oct 01/15
FIGURE Door Clearances - Mid Passenger/Crew Doors		Oct 01/15
FIGURE Door Clearances - Emergency Exits		Oct 01/15
FIGURE Door Clearances - Emergency Exits		Oct 01/15
FIGURE Door Clearances - Aft Passenger/Crew Doors		Oct 01/15
FIGURE Door Clearances - Forward Cargo Compartment Door		Oct 01/15
FIGURE Door Clearances - Aft Cargo Compartment Door		Oct 01/15
FIGURE Door Clearances - Bulk Cargo Compartment Door		Oct 01/15
FIGURE Door Clearances - Radome		Oct 01/15
FIGURE Door Clearances - Main and Center Landing Gear Doors		Oct 01/15

CONTENT	CHG CODE	LAST REVISION DATE
FIGURE Door Clearances - Main and Center Landing Gear Doors		Oct 01/15
FIGURE Door Clearances - APU and Nose Landing Gear Doors		Oct 01/15
FIGURE Door Clearances - APU and Nose Landing Gear Doors		Oct 01/15
Subject 2-8-0		
Escape Slides		Oct 01/15
FIGURE Escape Slides - Location		Oct 01/15
FIGURE Escape Slides - Location		Oct 01/15
Subject 2-9-0		
Landing Gear Maintenance Pits		Jan 01/14
FIGURE Landing Gear Maintenance Pits - Maintenance Pit Envelopes		Jan 01/14
FIGURE Landing Gear Maintenance Pits - Maintenance Pit Envelopes		Jan 01/14
Landing Gear		Jan 01/17
FIGURE Main Landing Gear - General		Jan 01/14
FIGURE Centerline Landing Gear - General		Jan 01/14
FIGURE Nose Landing Gear - General		Jan 01/14
FIGURE Tow Truck Power		Jan 01/17
Subject 2-10-0		
Exterior Lighting		Jan 01/17
FIGURE Exterior Lighting		Jan 01/14
FIGURE Exterior Lighting		Jan 01/14
Subject 2-11-0		
Antennas and Probes Location		Jan 01/14
FIGURE Antennas and Probes - Location		Jan 01/14
FIGURE Antennas and Probes - Location		Jan 01/14
Subject 2-12-0		
Engine and Nacelle		Jan 01/14
FIGURE Engine and Nacelle - Engine Dimensions - TRENT 500		Jan 01/14
FIGURE Engine and Nacelle - Nacelle Dimensions - TRENT 500		Jan 01/14
FIGURE Engine and Nacelle - Fan Cowls - TRENT 500		Jan 01/14

CONTENT	CHG CODE	LAST REVISION DATE
FIGURE Engine and Nacelle - Thrust Reverser Cowls - TRENT 500 Subject 2-12-1 Auxiliary Power Unit		Jan 01/14
FIGURE Auxiliary Power Unit - Access Doors Subject 2-13-0		Jan 01/14
Leveling, Symmetry and Alignment		Jan 01/14
FIGURE Location of Leveling Points		Jan 01/14
FIGURE Location of Leveling Points		Jan 01/14
Subject 2-14-0		
Jacking for Maintenance		Jan 01/17
FIGURE Jacking for Maintenance - Jacking Points Location		Jan 01/14
FIGURE Jacking for Maintenance - Jacking Points Location		Jan 01/14
FIGURE Jacking for Maintenance - Forward Jacking Point		Jan 01/14
FIGURE Jacking for Maintenance - Wing Jacking Points		Jan 01/14
FIGURE Jacking for Maintenance - Auxiliary Jacking Point - Safety Stay		Jan 01/14
FIGURE Jacking for Maintenance - Jacking Dimensions		Jan 01/14
FIGURE Jacking for Maintenance - Jacking Dimensions		Jan 01/14
FIGURE Jacking for Maintenance - Load at the Aircraft Jacking Points		Jan 01/14
FIGURE Jacking for Maintenance - Load at the Aircraft Jacking Points		Jan 01/14
Subject 2-14-1		
Jacking of the Landing Gear		Oct 01/15
FIGURE Jacking of the Landing Gear - MLG Jacking Point Heights		Jul 01/18
FIGURE Jacking of the Landing Gear - Jacking of the NLG		Oct 01/15
FIGURE Jacking of the Landing Gear - CLG Jacking Point Heights		Oct 01/15
FIGURE Jacking of the Landing Gear - NLG Jacking Point Loads - (WV 001)		Oct 01/15
FIGURE Jacking of the Landing Gear - NLG Jacking Point Loads - (WV 101)		Oct 01/15

CONTENT	CHG CODE	LAST REVISION DATE
FIGURE Jacking of the Landing Gear - MLG Jacking Point Loads - (WV 001)		Oct 01/15
FIGURE Jacking of the Landing Gear - MLG Jacking Point Loads - (WV 101)		Oct 01/15
FIGURE Jacking of the Landing Gear - CLG Jacking Point Loads - (WV 001)		Oct 01/15
FIGURE Jacking of the Landing Gear - CLG Jacking Point Loads - (WV 101)		Oct 01/15
FIGURE Jacking of the Landing Gear - NLG Jacking Point Loads - (WV 001)		Oct 01/15
FIGURE Jacking of the Landing Gear - NLG Jacking Point Loads - (WV 101)		Oct 01/15
FIGURE Jacking of the Landing Gear - MLG Jacking Point Loads - (WV 001)		Oct 01/15
FIGURE Jacking of the Landing Gear - MLG Jacking Point Loads - (WV 101)		Oct 01/15
FIGURE Jacking of the Landing Gear - CLG Jacking Point Loads - (WV 001)		Oct 01/15
FIGURE Jacking of the Landing Gear - CLG Jacking Point Loads - (WV 101)		Oct 01/15
Subject 2-14-2		
Support of Aircraft		Jan 01/14
FIGURE Support of Aircraft - Location of Shoring Cradles		Jan 01/14
FIGURE Support of Aircraft - Location of Shoring Cradles		Jan 01/14
<u>CHAPTER 3</u>		
Subject 3-1-0		
General Information		Oct 01/15
Subject 3-2-1		
Payload / Range - ISA Conditions		Oct 01/15
FIGURE Payload / Range - ISA Conditions - RB 211 TRENT 556 engine		Oct 01/15

CONTENT	CHG CODE	LAST REVISION DATE
FIGURE Payload / Range - ISA Conditions - RB 211 TRENT 553 engine		Oct 01/15
Subject 3-3-1		
Take-Off Weight Limitation - ISA Conditions		Oct 01/15
FIGURE Take-Off Weight Limitation - ISA Conditions – RB 211 TRENT 556 engine		Oct 01/15
FIGURE Take-Off Weight Limitation - ISA Conditions – RB 211 TRENT 553 engine		Oct 01/15
Subject 3-3-2		
Take-Off Weight Limitation - ISA +15° C (+59° F) Conditions		Oct 01/15
FIGURE Take-Off Weight Limitation - ISA +15° C (+59° F) Conditions – RB 211 TRENT 556 engine		Oct 01/15
FIGURE Take-Off Weight Limitation - ISA +15° C (+59° F) Conditions – RB 211 TRENT 553 engine		Oct 01/15
Subject 3-4-1		
Landing Field Length - ISA Conditions		Oct 01/15
FIGURE Landing Field Length - ISA Conditions – RB 211 TRENT 556 engine		Oct 01/15
FIGURE Landing Field Length - ISA Conditions – RB 211 TRENT 553 engine		Oct 01/15
Subject 3-5-0		
Final Approach Speed		Jan 01/14
<u>CHAPTER 4</u>		
Subject 4-1-0		
General Information		Oct 01/15
Subject 4-2-0		
Turning Radii		Jan 01/17
FIGURE Turning Radii - (Sheet 1)		Jan 01/14
FIGURE Turning Radii - (Sheet 1)		Jan 01/14
Subject 4-3-0		
Minimum Turning Radii		Jan 01/17

CONTENT	CHG CODE	LAST REVISION DATE
FIGURE Minimum Turning Radii		Jan 01/14
FIGURE Minimum Turning Radii		Jan 01/14
Subject 4-4-0		
Visibility from Cockpit in Static Position		Jul 01/19
FIGURE Visibility from Cockpit in Static Position		Jul 01/19
FIGURE Binocular Visibility Through Windows from Captain Eye Position		Jan 01/14
Subject 4-5-0		
Runway and Taxiway Turn Paths		Jan 01/14
Subject 4-5-1		
135° Turn - Runway to Taxiway		Jan 01/14
FIGURE 135° Turn - Runway to Taxiway - Judgemental Oversteering Method		Jan 01/14
FIGURE 135° Turn - Runway to Taxiway - Cockpit Over Centerline Method		Jan 01/14
FIGURE 135° Turn - Runway to Taxiway - Judgemental Oversteering Method		Jan 01/14
FIGURE 135° Turn - Runway to Taxiway - Cockpit Over Centerline Method		Jan 01/14
Subject 4-5-2		
90° Turn - Runway to Taxiway		Jan 01/14
FIGURE 90° Turn - Runway to Taxiway - Judgement Oversteering Method		Jan 01/14
FIGURE 90° Turn - Runway to Taxiway - Cockpit Over Centerline Method		Jan 01/14
FIGURE 90° Turn - Runway to Taxiway - Judgement Oversteering Method		Jan 01/14
FIGURE 90° Turn - Runway to Taxiway - Cockpit Over Centerline Method		Jan 01/14
Subject 4-5-3		
180° Turn on a Runway		Jan 01/17
FIGURE 180° Turn on a Runway		Jan 01/14
FIGURE 180° Turn on a Runway		Jan 01/14

CONTENT	CHG CODE	LAST REVISION DATE
Subject 4-5-4 135° Turn - Taxiway to Taxiway FIGURE 135° Turn - Taxiway to Taxiway - Judgement Oversteering Method FIGURE 135° Turn - Taxiway to Taxiway - Cockpit Over Centerline Method FIGURE 135° Turn - Taxiway to Taxiway - Judgement Oversteering Method FIGURE 135° Turn - Taxiway to Taxiway - Cockpit Over Centerline Method		Jan 01/14 Jan 01/14 Jan 01/14 Jan 01/14 Jan 01/14
Subject 4-5-5 90° Turn - Taxiway to Taxiway FIGURE 90° Turn - Taxiway to Taxiway - Judgemental Oversteering Method FIGURE 90° Turn - Taxiway to Taxiway - Cockpit Over Centerline Method FIGURE 90° Turn - Taxiway to Taxiway - Judgemental Oversteering Method FIGURE 90° Turn - Taxiway to Taxiway - Cockpit Over Centerline Method		Jan 01/14 Jan 01/14 Jan 01/14 Jan 01/14 Jan 01/14
Subject 4-6-0 Runway Holding Bay (Apron) FIGURE Runway Holding Bay (Apron)		Oct 01/15 Oct 01/15
Subject 4-7-0 Minimum Line-Up Distance Corrections FIGURE Minimum Line-Up Distance Corrections - 90° Turn on Runway Entry FIGURE Minimum Line-Up Distance Corrections - 180° Turn on Runway Turn Pad FIGURE Minimum Line-Up Distance Corrections - 180° Turn on Runway Width		Jan 01/14 Jan 01/14 Jan 01/14 Jan 01/14
Subject 4-8-0 Aircraft Mooring		Oct 01/15

CONTENT	CHG CODE	LAST REVISION DATE
FIGURE Aircraft Mooring		Oct 01/15
<u>CHAPTER 5</u>		
Subject 5-1-0		
Aircraft Servicing Arrangements		Jan 01/14
Subject 5-1-1		
Symbols Used on Servicing Diagrams		Jan 01/14
Subject 5-1-2		
Typical Ramp Layout - Open Apron		Jan 01/17
FIGURE Typical Ramp Layout - Open Apron		Jan 01/14
FIGURE Typical Ramp Layout - Open Apron		Jan 01/14
Subject 5-1-3		
Typical Ramp Layout - Gate		Jan 01/17
FIGURE Typical Ramp Layout - Gate		Jan 01/14
FIGURE Typical Ramp Layout - Gate		Jan 01/14
Subject 5-2-0		
Terminal Operations - Full Servicing Turn Round Time		Oct 01/15
FIGURE Full Servicing Turn Round Time Chart		Oct 01/15
Terminal Operations - Full Servicing Turn Round Time		Oct 01/15
FIGURE Full Servicing Turn Round Time Chart		Oct 01/15
Subject 5-3-0		
Terminal Operations - Minimum Servicing Turn-Round Time		Jan 01/14
FIGURE Minimum Servicing Turn-Round Time		Jan 01/14
Terminal Operations - Minimum Servicing Turn-Round Time		Jan 01/14
FIGURE Minimum Servicing Turn-Round Time		Jan 01/14
Subject 5-4-1		
Ground Service Connections Layout		Oct 01/15
FIGURE Ground Service Connections Layout		Oct 01/15
FIGURE Ground Service Connections Layout		Oct 01/15
Subject 5-4-2		

CONTENT	CHG CODE	LAST REVISION DATE
Grounding (Earthing) Points		Oct 01/15
FIGURE Ground Service Connections - Grounding (Earthing) Points		Oct 01/15
Subject 5-4-3		
Hydraulic Servicing		Oct 01/15
FIGURE Ground Service Connections - Green System Ground Service Panel		Jan 01/14
FIGURE Ground Service Connections - Blue System Ground Service Panel		Jan 01/14
FIGURE Ground Service Connections - Yellow System Ground Service Panel		Jan 01/14
FIGURE Ground Service Connections - RAT		Oct 01/15
Subject 5-4-4		
Electrical Servicing		Jan 01/17
FIGURE Ground Service Connections - Electrical Service Panel		Oct 01/15
Subject 5-4-5		
Oxygen Servicing		Jan 01/17
FIGURE Ground Service Connections - Oxygen Servicing		Oct 01/15
Subject 5-4-6		
Fuel System		Jul 01/18
FIGURE Ground Service Connections - Refuel/Defuel Control Panel		Oct 01/15
FIGURE Ground Service Connections - Refuel/Defuel Coupling		Oct 01/15
FIGURE Ground Service Connections - Overpressure Protector and NACA Flame Arrestor - Wing		Oct 01/15
FIGURE Ground Service Connections - Overpressure Protector and NACA Flame Arrestor - Trim Tank		Oct 01/15
Subject 5-4-7		
Pneumatic Servicing		Jan 01/17
FIGURE Ground Service Connections - LP and HP Ground Connectors		Jan 01/14
Subject 5-4-8		
Oil Servicing		Oct 01/15

CONTENT	CHG CODE	LAST REVISION DATE
FIGURE Ground Service Connections - Engine Oil Tank - RR TRENT 500 Series Engine		Oct 01/15
FIGURE Ground Service Connections - IDG Oil Tank - RR TRENT 500 Series Engine		Oct 01/15
FIGURE Ground Service Connections - Starter Oil Tank - RR TRENT 500 Series Engine		Oct 01/15
APU Oil Servicing		Oct 01/15
FIGURE Ground Service Connections - APU Oil Servicing		Oct 01/15
Subject 5-4-9		
Potable Water Servicing		Oct 01/15
FIGURE Ground Service Connections - Potable-Water Ground Service Panels		Oct 01/15
FIGURE Ground Service Connections - Potable-Water Tanks Location		Oct 01/15
Potable Water Servicing		Oct 01/15
FIGURE Ground Service Connections - Potable-Water Ground Service Panels		Oct 01/15
FIGURE Ground Service Connections - Potable-Water Tanks Location		Oct 01/15
Subject 5-4-10		
Waste Water Servicing		Oct 01/15
FIGURE Ground Service Connections - Waste Water Ground Service Panel		Jan 01/14
FIGURE Ground Service Connections - Waste Tanks Location		Oct 01/15
Subject 5-4-11		
Cargo Control Panels		Oct 01/15
FIGURE Forward Cargo Control Panels		Oct 01/15
FIGURE Aft Cargo Control Panels		Oct 01/15
Subject 5-5-0		
Engine Starting Pneumatic Requirements		Jan 01/14
FIGURE Engine Starting Pneumatic Requirements		Jan 01/14
Subject 5-5-1		
Low Ambient Temperatures		Jan 01/14

CONTENT	CHG CODE	LAST REVISION DATE
FIGURE Engine Starting Pneumatic Requirements - Low Ambient Temperature -40° C (-40° F) – RB 211 TRENT 500 series engine Subject 5-5-2 Medium Ambient Temperatures		Jan 01/14
FIGURE Engine Starting Pneumatic Requirements - Medium Ambient Temperature +15° C (+59° F) – RB 211 TRENT 500 series engine Subject 5-5-3 High Ambient Temperatures		Jan 01/14
FIGURE Engine Starting Pneumatic Requirements - High Ambient Temperature +50° C (+122° F) – RB 211 TRENT 500 series engine Subject 5-6-0 Ground Pneumatic Power Requirements		Jan 01/14
FIGURE Ground Pneumatic Power Requirements - Heating		Oct 01/15
FIGURE Ground Pneumatic Power Requirements - Cooling		Oct 01/15
Subject 5-7-0 Preconditioned Airflow Requirements		Oct 01/15
FIGURE Preconditioned Airflow Requirements		Oct 01/15
Subject 5-8-0 Ground Towing Requirements		Jul 01/18
FIGURE Ground Towing Requirements		Jan 01/14
Subject 5-9-0 De-Icing and External Cleaning		Jan 01/17
<u>CHAPTER 6</u>		
Subject 6-1-0 Engine Exhaust Velocities and Temperatures		Jul 01/18
Subject 6-1-1 Engine Exhaust Velocities Contours - Ground Idle Power		Jan 01/14
FIGURE Engine Exhaust Velocities - Ground Idle Power - RR TRENT 500 series engine		Jan 01/14
Subject 6-1-2		

CONTENT	CHG CODE	LAST REVISION DATE
Engine Exhaust Temperatures Contours - Ground Idle Power		Jan 01/14
FIGURE Engine Exhaust Temperatures - Ground Idle Power - RR TRENT 500 series engine		Jan 01/14
Subject 6-1-3		
Engine Exhaust Velocities Contours - Breakaway Power		Jan 01/14
FIGURE Engine Exhaust Velocities - Breakaway Power - RR TRENT 500 series engine		Jan 01/14
Subject 6-1-4		
Engine Exhaust Temperatures Contours - Breakaway Power		Jan 01/14
FIGURE Engine Exhaust Temperatures - Breakaway Power - RR TRENT 500 series engine		Jan 01/14
Subject 6-1-5		
Engine Exhaust Velocities Contours - Takeoff Power		Jan 01/14
FIGURE Engine Exhaust Velocities - Takeoff Power - RR TRENT 500 series engine		Jan 01/14
Subject 6-1-6		
Engine Exhaust Temperatures Contours - Takeoff Power		Jan 01/14
FIGURE Engine Exhaust Temperatures - Takeoff Power - RR TRENT 500 series engine		Jan 01/14
Subject 6-3-0		
Danger Areas of Engines		Aug 01/19
Subject 6-3-1		
Ground Idle Power		Oct 01/15
FIGURE Danger Areas of Engines - RR TRENT 500 series engine		Jan 01/14
Subject 6-3-2		
Breakaway Power		Oct 01/15
FIGURE Danger Areas of Engines - RR TRENT 500 series engine		Jan 01/14
Subject 6-3-3		
Takeoff Power		Oct 01/15
FIGURE Danger Areas of Engines - RR TRENT 500 series engine		Jan 01/14
Subject 6-4-0		

CONTENT	CHG CODE	LAST REVISION DATE
APU Exhaust Velocities and Temperatures		Jan 01/14
Subject 6-4-1		
APU - GARRETT		Jan 01/14
FIGURE Exhaust Velocities and Temperatures - GARRETT GTCP 331-600 (A)		Jan 01/14
<u>CHAPTER 7</u>		
Subject 7-1-0		
General Information		Oct 01/15
Subject 7-2-0		
Landing Gear Footprint		Oct 01/15
FIGURE Landing Gear Footprint		Oct 01/15
FIGURE Landing Gear Footprint		Oct 01/15
Subject 7-3-0		
Maximum Pavement Loads		Oct 01/15
FIGURE Maximum Pavement Loads		Oct 01/15
FIGURE Maximum Pavement Loads		Oct 01/15
Subject 7-4-0		
Landing Gear Loading on Pavement		Oct 01/15
FIGURE Landing Gear Loading on Pavement - WV000, MRW 369 200 kg, CG 36.5%		Oct 01/15
FIGURE Landing Gear Loading on Pavement - WV101, MRW 381 200 kg, CG 34.7%		Oct 01/15
FIGURE Landing Gear Loading on Pavement - WV000, MRW 366 200 kg, CG 35%		Oct 01/15
FIGURE Landing Gear Loading on Pavement - WV101, MRW 381 200 kg, CG 30.2%		Oct 01/15
Subject 7-5-0		
Flexible Pavement Requirements - US Army Corps of Engineers Design Method		Jan 01/17
FIGURE Flexible Pavement Requirements - WV000, MRW 369 200 kg, CG 36.5% (Sheet 1 of 2)		Jan 01/17

CONTENT	CHG CODE	LAST REVISION DATE
FIGURE Flexible Pavement Requirements - WV101, MRW 381 200 kg, CG 34.7% (Sheet 2 of 2)		Jan 01/17
FIGURE Flexible Pavement Requirements - WV000, MRW 366 200 kg, CG 35% (Sheet 1 of 2)		Jan 01/17
FIGURE Flexible Pavement Requirements - WV101, MRW 381 200 kg, CG 30.2% (Sheet 2 of 2)		Jan 01/17
Subject 7-6-0		
Flexible Pavement Requirements - LCN Conversion		Oct 01/15
Subject 7-7-0		
Rigid Pavement Requirements - Portland Cement Association Design Method		Oct 01/15
FIGURE Rigid Pavement Requirements - WV000, MRW 369 200 kg, CG 36.5%		Jan 01/17
FIGURE Rigid Pavement Requirements - WV101, MRW 381 200 kg, CG 34.7%		Jan 01/17
FIGURE Rigid Pavement Requirements - WV000, MRW 366 200 kg, CG 35%		Jan 01/17
FIGURE Rigid Pavement Requirements - WV101, MRW 381 200 kg, CG 30.2%		Jan 01/17
Subject 7-8-0		
Rigid Pavement Requirements - LCN Conversion		Oct 01/15
Subject 7-9-0		
Aircraft Classification Number - Flexible and Rigid Pavements		Jan 01/17
FIGURE Aircraft Classification Number - ACN Table		Oct 01/15
FIGURE Aircraft Classification Number - Flexible Pavement - WV000, MRW 369 200 kg, CG 36.5%		Jan 01/17
FIGURE Aircraft Classification Number - Flexible Pavement - WV101, MRW 381 200 kg, CG 34.7%		Jan 01/17
FIGURE Aircraft Classification Number - ACN Table		Oct 01/15
FIGURE Aircraft Classification Number - Flexible Pavement - WV000, MRW 366 200 kg, CG 35%		Jan 01/17
FIGURE Aircraft Classification Number - Flexible Pavement - WV101, MRW 381 200 kg, CG 30.2%		Jan 01/17

CONTENT	CHG CODE	LAST REVISION DATE
<u>CHAPTER 8</u>		
Subject 8-0-0		
Scaled Drawings		Jan 01/14
FIGURE Scaled Drawing		Jan 01/17
FIGURE Scaled Drawing		Jan 01/17
<u>CHAPTER 10</u>		
Subject 10-0-0		
Aircraft Rescue and Fire Fighting		Oct 01/15
FIGURE Front Page		Jan 01/17
FIGURE Highly Flammable and Hazardous Materials and Components		Oct 01/15
FIGURE Batteries Location and Access		Oct 01/15
FIGURE Crew Rest Compartments Location		Jan 01/14
FIGURE Wheel/Brake Overheat - Wheel Safety Area		Jan 01/14
FIGURE Composite Materials Location		Jan 01/17
FIGURE Ground Lock Safety Devices		Jan 01/14
FIGURE Emergency Evacuation Devices		Oct 01/15
FIGURE Pax/Crew Doors and Emergency Exits		Jan 01/14
FIGURE FWD and AFT Lower Deck Cargo Doors		Jan 01/14
FIGURE Control Panels		Jan 01/14
FIGURE APU Compartment Access		Jan 01/14
FIGURE Ground Clearances		Oct 01/15
FIGURE Structural Break-in Points		Jan 01/14
Aircraft Rescue and Fire Fighting		Oct 01/15
FIGURE Front Page		Jan 01/17
FIGURE Highly Flammable and Hazardous Materials and Components		Oct 01/15
FIGURE Batteries Location and Access		Oct 01/15
FIGURE Crew Rest Compartments Location		Jan 01/14
FIGURE Wheel/Brake Overheat - Wheel Safety Area		Jan 01/14

A340-500/-600

AIRCRAFT CHARACTERISTICS - AIRPORT AND MAINTENANCE PLANNING

CONTENT	CHG CODE	LAST REVISION DATE
FIGURE Composite Materials Location		Jan 01/17
FIGURE Ground Lock Safety Devices		Jan 01/14
FIGURE Emergency Evacuation Devices		Oct 01/15
FIGURE Pax/Crew Doors and Emergency Exits		Jan 01/14
FIGURE FWD and AFT Lower Deck Cargo Doors		Jan 01/14
FIGURE Control Panels		Jan 01/14
FIGURE APU Compartment Access		Jan 01/14
FIGURE Ground Clearances		Oct 01/15
FIGURE Structural Break-in Points		Jan 01/14

TABLE OF CONTENTS

1	SCOPE
1-1-0	Purpose
1-2-1	Glossary
2	AIRCRAFT DESCRIPTION
2-1-1	General Aircraft Characteristics Data
2-2-0	General Aircraft Dimensions
2-3-0	Ground Clearances
2-4-1	Interior Arrangements - Plan View
2-5-0	Interior Arrangements - Cross Section
2-6-1	Lower Deck Cargo Compartments
2-7-0	Door Clearances
2-8-0	Escape Slides
2-9-0	Landing Gear
2-10-0	Exterior Lighting
2-11-0	Antennas and Probes Location
2-12-0	Engine and Nacelle
2-12-1	Auxiliary Power Unit
2-13-0	Levelling, symmetry and Alignment
2-14-0	Jacking for Maintenance
2-14-1	Jacking of the Landing Gear
2-14-2	Support of Aircraft
3	AIRCRAFT PERFORMANCE
3-1-0	General Information
3-2-1	Payload / Range - ISA Conditions
3-3-1	Take-Off Weight Limitation - ISA Conditions
3-3-2	Take-Off Weight Limitation - ISA +15 °C (+59 °F) Conditions
3-4-1	Landing Field Length - ISA Conditions
3-5-0	Final Approach Speed
4	GROUND MANEUVERING
4-1-0	General Information
4-2-0	Turning Radii
4-3-0	Minimum Turning Radii

4-4-0	Visibility from Cockpit in Static Position
4-5-0	Runway and Taxiway Turn Paths
4-5-1	135° Turn - Runway to Taxiway
4-5-2	90° Turn - Runway to Taxiway
4-5-3	180° Turn on a Runway
4-5-4	135° Turn - Taxiway to Taxiway
4-5-5	90° Turn - Taxiway to Taxiway
4-6-0	Runway Holding Bay (Apron)
4-7-0	Minimum Line-Up Distance Corrections
4-8-0	Aircraft Mooring

5 TERMINAL SERVICING

5-1-0	Aircraft Servicing Arrangements
5-1-1	Symbols Used on Servicing Diagrams
5-1-2	Typical Ramp Layout - Open Apron
5-1-3	Typical Ramp Layout - Gate
5-2-0	Terminal Operations - Full Servicing
5-3-0	Terminal Operations - Transit
5-4-1	Ground Service Connections Layout
5-4-2	Grounding Points
5-4-3	Hydraulic System
5-4-4	Electrical System
5-4-5	Oxygen System
5-4-6	Fuel System
5-4-7	Pneumatic System
5-4-8	Oil System
5-4-9	Potable Water System
5-4-10	Waste Water System
5-4-11	Cargo Control Panels
5-5-0	Engine Starting Pneumatic Requirements
5-5-1	Low Ambient Temperatures
5-5-2	Medium Ambient Temperatures
5-5-3	High Ambient Temperatures
5-6-0	Ground Pneumatic Power Requirements
5-7-0	Preconditioned Airflow Requirements
5-8-0	Ground Towing Requirements
5-9-0	De-Icing and External Cleaning

6	OPERATING CONDITIONS
6-1-0	Engine Exhaust Velocities and Temperatures
6-1-1	Engine Exhaust Velocities Contours - Ground Idle Power
6-1-2	Engine Exhaust Temperatures Contours - Ground Idle Power
6-1-3	Engine Exhaust Velocities Contours - Breakaway Power
6-1-4	Engine Exhaust Temperatures Contours - Breakaway Power
6-1-5	Engine Exhaust Velocities Contours - Takeoff Power
6-1-6	Engine Exhaust Temperatures Contours - Takeoff Power
6-3-0	Danger Areas of Engines
6-3-1	Ground Idle Power
6-3-2	Breakaway Power
6-3-3	Takeoff Power
6-4-0	APU Exhaust Velocities and Temperatures
6-4-1	APU
7	PAVEMENT DATA
7-1-0	General Information
7-2-0	Landing Gear Footprint
7-3-0	Maximum Pavement Loads
7-4-0	Landing Gear Loading on Pavement
7-5-0	Flexible Pavement Requirements - U.S. Army Corps of Engineers Design Method
7-6-0	Flexible Pavement Requirements - LCN Conversion
7-7-0	Rigid Pavement Requirements - Portland Cement Association Design Method
7-8-0	Rigid Pavement Requirements - LCN Conversion
7-9-0	ACN/PCN Reporting System - Flexible and Rigid Pavements
8	SCALED DRAWINGS
8-0-0	SCALED DRAWINGS
10	AIRCRAFT RESCUE AND FIRE FIGHTING
10-0-0	AIRCRAFT RESCUE AND FIRE FIGHTING

SCOPE**1-1-0 Purpose******ON A/C A340-500 A340-600**Introduction

1. General

The A340-500/-600 AIRCRAFT CHARACTERISTICS - AIRPORT AND MAINTENANCE PLANNING (AC) manual is issued for the A340-500 and A340-600 basic versions to provide necessary data to airport operators, airlines and Maintenance/Repair Organizations (MRO) for airport and maintenance facilities planning.

This document is not customized and must not be used for training purposes.

The A340 is part of an integrated family sharing the same modern technology as the A330 and maintaining the commonality that is integrated into the Airbus Fly-by-Wire family. It has undergone a program of continuous improvement and still delivers the value that airline customers expect, as the A340 has over 50 customers and operators with more than 350 A340s flying to over 150 airports every week.

The different models of the A340 family can carry from 250 to 440 passengers and are operating on some of the world's longest routes.

A stand-out benefit of the four-engine A340 is that it does not require any ETOPS certification. This allows quick start-up of long-haul operations. It also has good 'hot and high' capability at airports that would be off-limits to other aircraft.

The A340 has one of the quietest and most comfortable cabins in the sky, with state-of-the-art LED (Light Emitting Diode) lighting, mood styles of lighting and AVOD IFE systems.

The A340 combines good capability, economics and passenger product in one package.

Correspondence concerning this publication should be directed to:

AIRBUS S.A.S.
Customer Services
Technical Data Support and Services
1, Rond Point Maurice BELLONTE
31707 BLAGNAC CEDEX
FRANCE

1-2-1 Glossary

****ON A/C A340-500 A340-600**

Glossary

1. List of Abbreviations

A/C	Aircraft
ACN	Aircraft Classification Number
AMM	Aircraft Maintenance Manual
APU	Auxiliary Power Unit
B/C	Business Class
C/L	Center Line
CBR	California Bearing Ratio
CC	Cargo Compartment
CG	Center of Gravity
CKPT	Cockpit
CLG	Centerline Landing Gear
E	Young's Modulus
ELEC	Electric, Electrical, Electricity
ESWL	Equivalent Single Wheel Load
F/C	First Class
FAA	Federal Aviation Administration
FDL	Fuselage Datum Line
FR	Frame
FSTE	Full Size Trolley Equivalent
FWD	Forward
GPU	Ground Power Unit
GSE	Ground Support Equipment
HYD	Hydraulic
ICAO	International Civil Aviation Organisation
IDG	Integrated Drive Generator
ISA	International Standard Atmosphere
L	Radius of relative stiffness
LCN	Load Classification Number
LD	Load Device
LD	Lower Deck
L/G	Landing Gear
LH	Left Hand
LPS	Last Pax Seating

MAC	Mean Aerodynamic Chord
MAX	Maximum
MD	Main Deck
MIN	Minimum
MLG	Main Landing Gear
NLG	Nose Landing Gear
OAT	Outside Air Temperature
PAX	Passenger
PB/D	Passenger Boarding/Deboarding
PBB	Passenger Boarding Bridge
PCA	Portland Cement Association
PCN	Pavement Classification Number
PRM	Passenger with Reduced Mobility
RH	Right Hand
ULD	Unit Load Device
US	United States
WV	Weight Variant
Y/C	Economy Class

2. Design Weight Terminology

- Maximum Design Ramp Weight (MRW):
Maximum weight for ground maneuver (including weight of taxi and run-up fuel) as limited by aircraft strength and airworthiness requirements. It is also called Maximum Design Taxi Weight (MTW).
- Maximum Design Landing Weight (MLW):
Maximum weight for landing as limited by aircraft strength and airworthiness requirements.
- Maximum Design Take-Off Weight (MTOW):
Maximum weight for take-off as limited by aircraft strength and airworthiness requirements. (This is the maximum weight at start of the take-off run).
- Maximum Design Zero Fuel Weight (MZFW):
Maximum permissible weight of the aircraft without usable fuel.
- Maximum Seating Capacity:
Maximum number of passengers specifically certified or anticipated for certification.
- Usable Volume:
Usable volume available for cargo, pressurized fuselage, passenger compartment and cockpit.
- Water Volume:
Maximum volume of cargo compartment.
- Usable Fuel:
Fuel available for aircraft propulsion.

AIRCRAFT DESCRIPTION

2-1-1 General Aircraft Characteristics Data

****ON A/C A340-500 A340-600**

General Aircraft Characteristics Data

****ON A/C A340-600**

1. The following table provides characteristics of A340-600 Models, these data are specific to each Weight Variant:

Aircraft Characteristics		
	WV000	WV001
Maximum Taxi Weight (MTW)	366 200 kg	369 200 kg
Maximum Ramp Weight (MRW)	(807 333 lb)	(813 946 lb)
Maximum Take-Off Weight (MTOW)	365 000 kg (804 687 lb)	368 000 kg (811 301 lb)
Maximum Landing Weight (MLW)	256 000 kg (564 383 lb)	259 000 kg (570 997 lb)
Maximum Zero Fuel Weight (MZFW)	242 000 kg (533 519 lb)	245 000 kg (540 132 lb)
Usable Fuel Capacity (density = 0.785 kg/l)	195 010 l (51 516 US gal)	
	153 082 kg (337 488 lb)	

Aircraft Characteristics			
	WV101	WV102	WV103
Maximum Taxi Weight (MTW)	381 200 kg	369 200 kg	366 200 kg
Maximum Ramp Weight (MRW)	(840 402 lb)	(813 946 lb)	(807 333 lb)
Maximum Take-Off Weight (MTOW)	380 000 kg (837 756 lb)	368 000 kg (811 301 lb)	365 000 kg (804 687 lb)
Maximum Landing Weight (MLW)	265 000 kg (584 225 lb)	259 000 kg (570 997 lb)	265 000 kg (584 225 lb)
Maximum Zero Fuel Weight (MZFW)	251 000 kg (553 360 lb)	245 000 kg (540 132 lb)	251 000 kg (553 360 lb)

A340-500/-600

AIRCRAFT CHARACTERISTICS - AIRPORT AND MAINTENANCE PLANNING

Aircraft Characteristics			
	WV101	WV102	WV103
Usable Fuel Capacity (density = 0.785 kg/l)	198 139 l (1) - 208 939 l (2) (52 343 US gal (1) - 55 196 US gal (2))		
	155 539 kg (1) - 164 017 kg (2) (342 905 lb (1) - 361 595 lb (2))		

(1) Without forward ACT

(2) With forward ACT

2. The following table provides characteristics of A340-600 Models, these data are common to each Weight Variant:

Aircraft Characteristics	
Standard Seating Capacity	384
Pressurized Fuselage Volume (A/C non equipped)	1 305 m ³ (46 086 ft ³)
Passenger Compartment Volume	557 m ³ (19 670 ft ³)
Cockpit Volume	12 m ³ (424 ft ³)
Usable Volume, FWD CC (Based on LD3)	104 m ³ (3 672 ft ³)
Usable Volume, AFT CC (Based on LD3)	78 m ³ (2 754 ft ³)
Usable Volume, Bulk CC	19.7 m ³ (695 ft ³)
Water Volume, FWD CC	143 m ³ (5 050 ft ³)
Water Volume, AFT CC	102.3 m ³ (3 612 ft ³)
Water Volume, Bulk CC	22.7 m ³ (802 ft ³)

A340-500/-600

AIRCRAFT CHARACTERISTICS - AIRPORT AND MAINTENANCE PLANNING

**ON A/C A340-500

3. The following table provides characteristics of A340-500 Models, these data are specific to each Weight Variant:

Aircraft Characteristics					
	WV000	WV001	WV002	WV003	WV004
Maximum Taxi Weight (MTW) Maximum Ramp Weight (MRW)	369 200 kg (813 946 lb)	373 200 kg (822 765 lb)	373 200 kg (822 765 lb)	375 200 kg (827 174 lb)	375 200 kg (827 174 lb)
Maximum Take-Off Weight (MTOW)	368 000 kg (811 301 lb)	372 000 kg (820 119 lb)	372 000 kg (820 119 lb)	374 000 kg (824 529 lb)	374 000 kg (824 529 lb)
Maximum Landing Weight (MLW)	240 000 kg (529 109 lb)	243 000 kg (535 723 lb)	243 000 kg (535 723 lb)	231 000 kg (509 268 lb)	243 000 kg (535 723 lb)
Maximum Zero Fuel Weight (MZFW)	225 000 kg (496 040 lb)	230 000 kg (507 063 lb)	229 000 kg (504 858 lb)	218 000 kg (480 608 lb)	218 000 kg (480 608 lb)
Usable Fuel Capacity (density = 0.785 kg/l)	214 808 l (56 746 US gal)	215 108 l * - 223 078 l ** (56 826 US gal * - 58 931 US gal **)		214 066 l * - 222 036 l ** (56 550 US gal * - 58 656 US gal **)	
	168 624 kg (371 752 lb)	168 859 kg * - 175 116 kg ** (372 270 lb * - 386 065 lb **)		168 041 kg * - 174 298 kg ** (370 467 lb * - 384 261 lb **)	

Aircraft Characteristics			
	WV101	WV102	WV103
Maximum Taxi Weight (MTW) Maximum Ramp Weight (MRW)	381 200 kg (840 402 lb)	373 200 kg (822 765 lb)	373 200 kg (822 765 lb)
Maximum Take-Off Weight (MTOW)	380 000 kg (837 756 lb)	372 000 kg (820 119 lb)	372 000 kg (820 119 lb)
Maximum Landing Weight (MLW)	246 000 kg (542 337 lb)	243 000 kg (535 723 lb)	246 000 kg (542 337 lb)
Maximum Zero Fuel Weight (MZFW)	232 000 kg (511 472 lb)	230 000 kg (507 063 lb)	232 000 kg (511 472 lb)

A340-500/-600

AIRCRAFT CHARACTERISTICS - AIRPORT AND MAINTENANCE PLANNING

Aircraft Characteristics			
	WV101	WV102	WV103
Usable Fuel Capacity (density = 0.785 kg/l)	214 066 l * - 222 036 l ** (56 550 US gal * - 58 656 US gal **)	216 622 l * - 223 210 l ** (57 225 US gal * - 58 966 US gal **)	
	168 041 kg * - 174 298 kg ** (370 467 lb * - 384 261 lb **)	170 048 kg * - 175 219 kg ** (374 892 lb * - 386 292 lb **)	

* (Production model) RCT = 5 frames

** (Optional model) RCT = 7 frames

4. The following table provides characteristics of A340-500 Models, these data are common to each Weight Variant:

Aircraft Characteristics	
Standard Seating Capacity	313
Pressurized Fuselage Volume (A/C non equipped)	1 120 m ³ (39 552 ft ³)
Passenger Compartment Volume	490 m ³ (17 304 ft ³)
Cockpit Volume	12 m ³ (424 ft ³)
Usable Volume, FWD CC (Based on LD3)	78 m ³ (2 754 ft ³)
Usable Volume, AFT CC (Based on LD3)	52 m ³ (1 836 ft ³)
Usable Volume, Bulk CC	19.7 m ³ (695 ft ³)
Water Volume, FWD CC	107.1 m ³ (3 782 ft ³)
Water Volume, AFT CC	73.9 m ³ (2 610 ft ³)
Water Volume, Bulk CC	22.7 m ³ (802 ft ³)

2-2-0 General Aircraft Dimensions****ON A/C A340-500 A340-600**General Aircraft Dimensions

1. This section provides general aircraft dimensions.

A340-500/-600

AIRCRAFT CHARACTERISTICS - AIRPORT AND MAINTENANCE PLANNING

**ON A/C A340-600

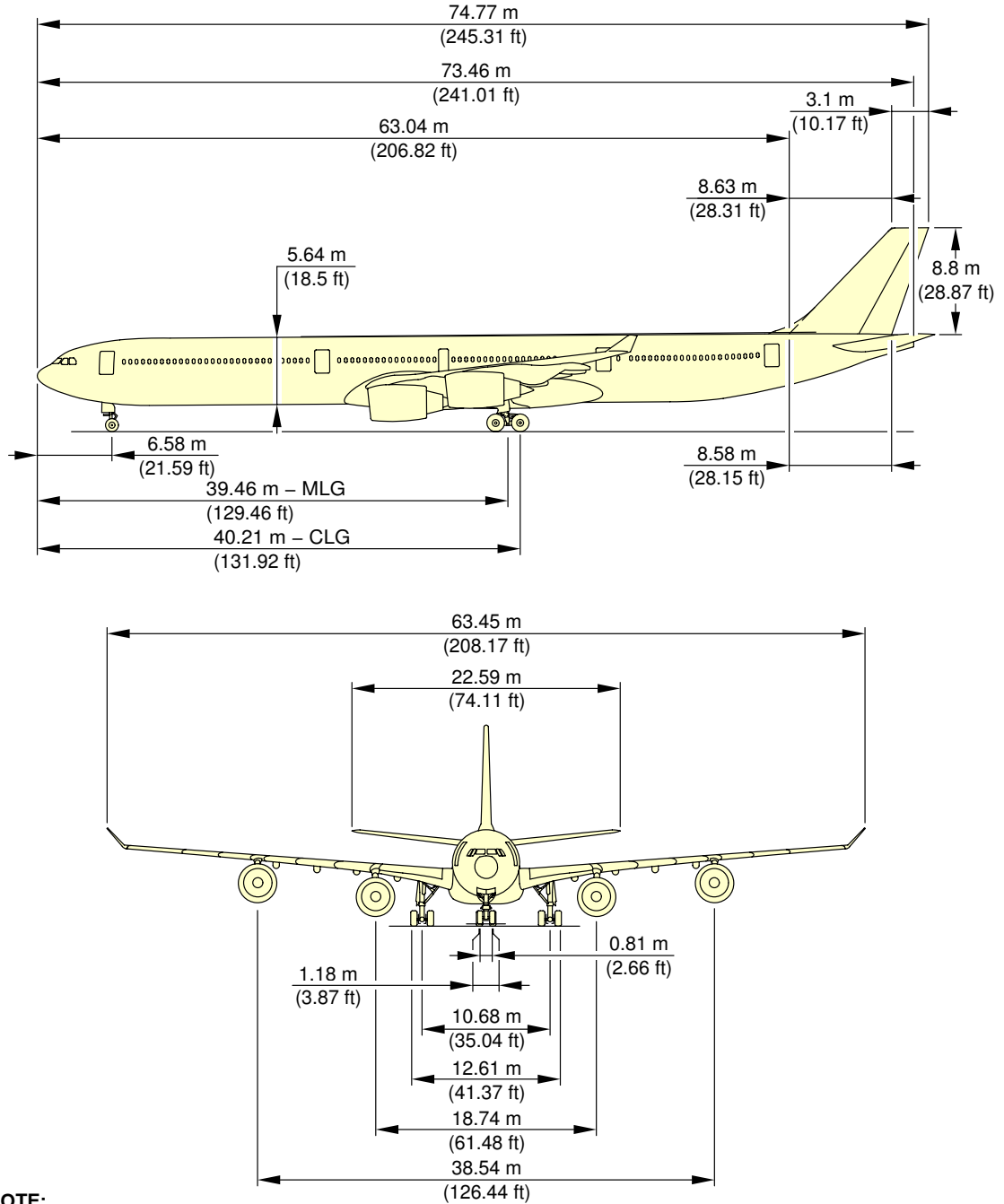

NOTE:
RELATED TO AIRCRAFT ATTITUDE AND WEIGHT.

F_AC_020200_1_0090101_01_01

General Aircraft Dimensions
(Sheet 1 of 2)
FIGURE-2-2-0-991-009-A01

A340-500/-600

AIRCRAFT CHARACTERISTICS - AIRPORT AND MAINTENANCE PLANNING

****ON A/C A340-600**

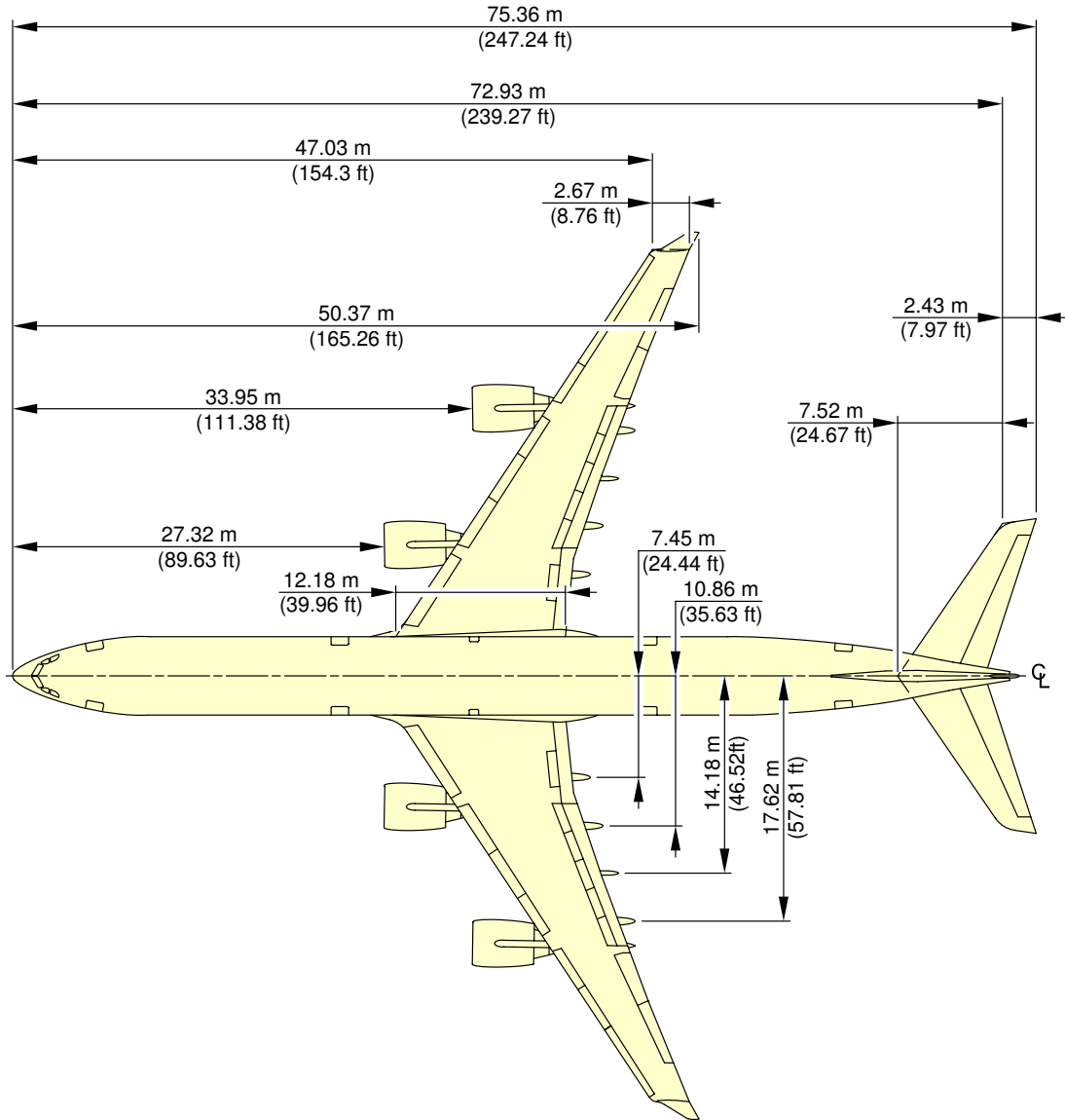

NOTE:
RELATED TO AIRCRAFT ATTITUDE AND WEIGHT.

F_AC_020200_1_0090102_01_00

General Aircraft Dimensions
(Sheet 2 of 2)
FIGURE-2-2-0-991-009-A01

A340-500/-600

AIRCRAFT CHARACTERISTICS - AIRPORT AND MAINTENANCE PLANNING

**ON A/C A340-500

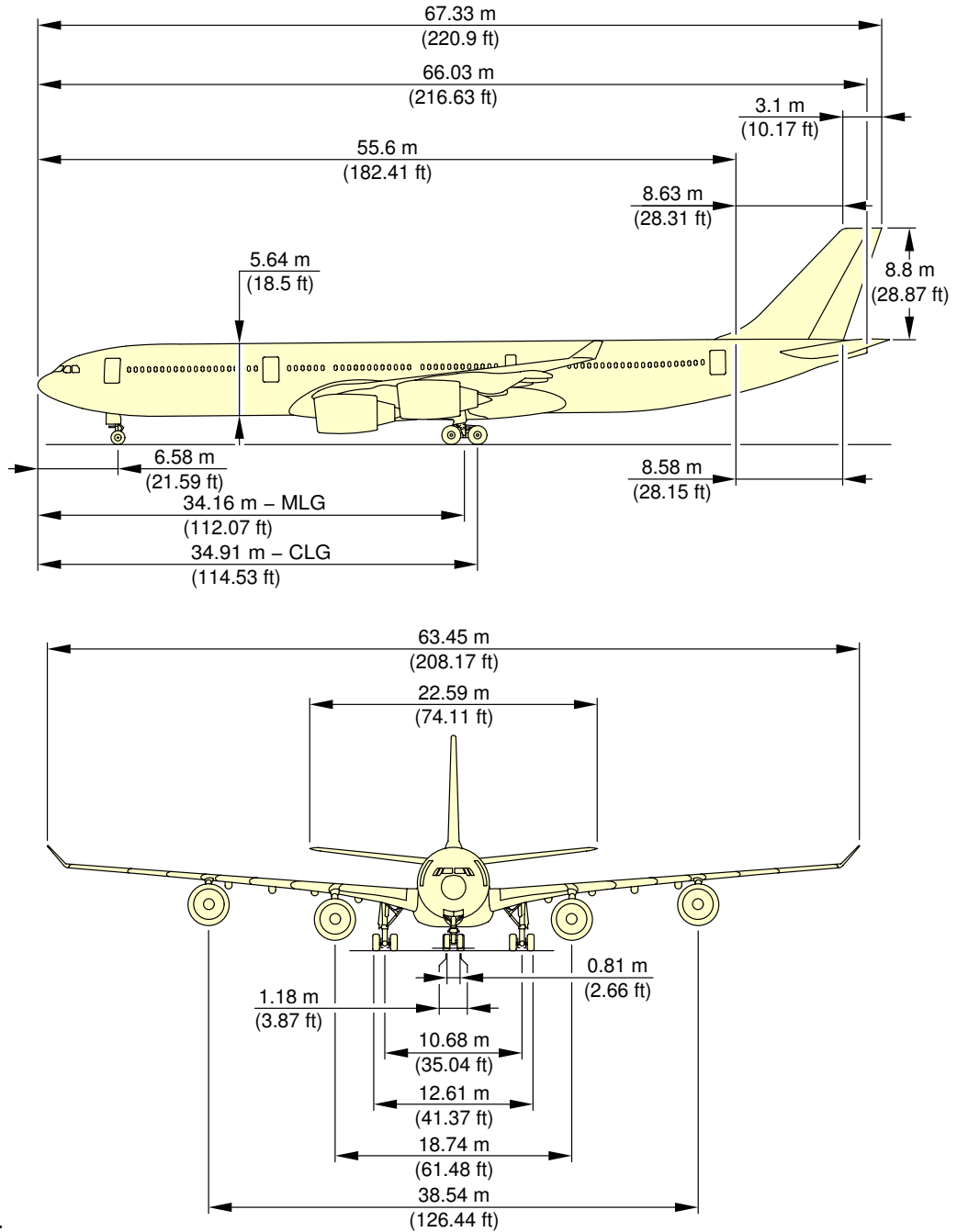

NOTE:
RELATED TO AIRCRAFT ATTITUDE AND WEIGHT.

F_AC_020200_1_0100101_01_01

General Aircraft Dimensions
(Sheet 1 of 2)
FIGURE-2-2-0-991-010-A01

A340-500/-600

AIRCRAFT CHARACTERISTICS - AIRPORT AND MAINTENANCE PLANNING

****ON A/C A340-500**

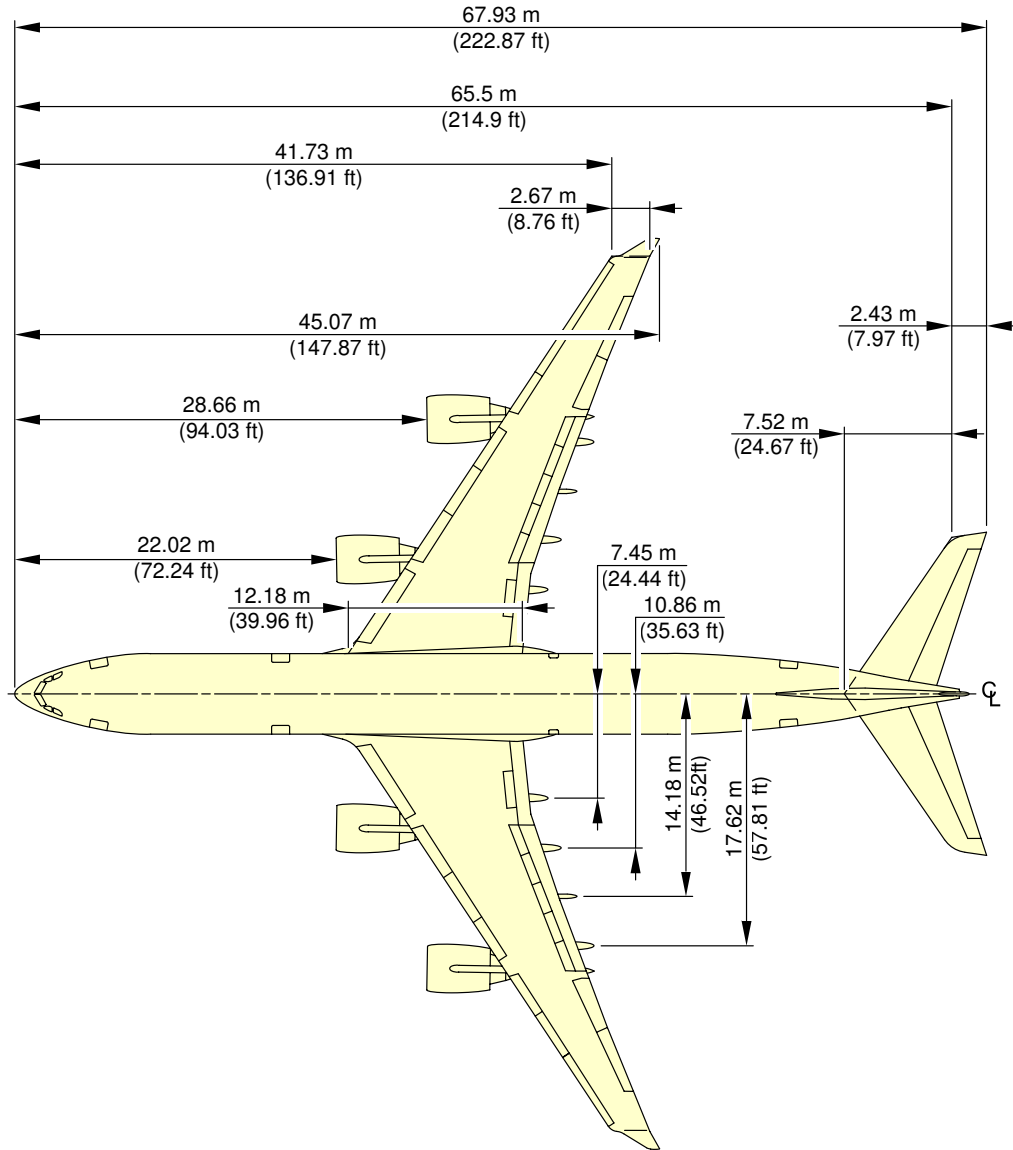

NOTE:
RELATED TO AIRCRAFT ATTITUDE AND WEIGHT.

F_AC_020200_1_0100102_01_00

General Aircraft Dimensions
(Sheet 2 of 2)
FIGURE-2-2-0-991-010-A01

2-3-0 Ground Clearances

****ON A/C A340-500 A340-600**

Ground Clearances

1. This section provides the height of various points of the aircraft, above the ground, for different aircraft configurations.
Dimensions in the tables are approximate and will vary with tire type, weight and balance and other special conditions.

The dimensions are given for:

- A light weight, for an A/C in maintenance configuration with a mid CG,
- An aircraft at Maximum Ramp Weight with a FWD CG and an AFT CG,
- Aircraft on jacks, FDL at 7.20 m (23.62 ft).

NOTE : Passenger and cargo door ground clearances are measured from the center of the door sill and from floor level.

A340-500/-600

AIRCRAFT CHARACTERISTICS - AIRPORT AND MAINTENANCE PLANNING

**ON A/C A340-600

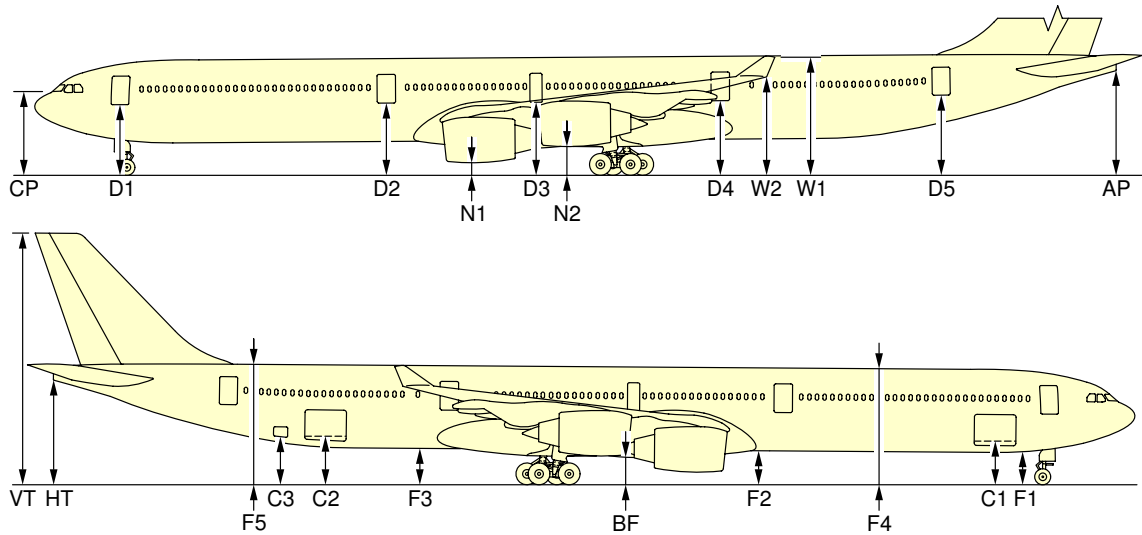

A/C CONFIGURATION		MRW				176 000 kg (380 013 lb)		A/C JACKED FDL = 7.20 m (23.62 ft)	
		FWD CG		AFT CG		MID CG		m	ft
		m	ft	m	ft	m	ft	m	ft
DOORS	D1	4.60	15.08	4.73	15.53	4.78	15.67	7.03	23.07
	D2	4.82	15.81	4.88	16.03	5.00	16.41	7.03	23.07
	D3	4.96	16.27	5.00	16.40	5.15	16.90	7.08	23.24
	D4	5.12	16.79	5.09	16.69	5.31	17.42	7.03	23.07
	D5	5.50	18.03	5.42	17.77	5.69	18.68	7.25	23.78
FUSELAGE	C1	2.70	8.86	2.82	9.27	2.88	9.46	5.09	16.71
	C2	3.31	10.84	3.25	10.66	3.50	11.49	5.14	16.86
	C3	3.40	11.14	3.33	10.92	3.59	11.79	5.19	17.03
	F1	1.99	6.53	2.11	6.93	2.17	7.12	4.38	14.37
	F2	2.17	7.11	2.23	7.33	2.35	7.71	4.38	14.37
	F3	2.47	8.09	2.44	7.99	2.66	8.72	4.38	14.37
WINGS	F4	7.81	25.61	7.87	25.83	7.99	26.22	10.02	32.87
	F5	8.27	27.12	8.19	26.86	8.47	27.77	10.02	32.87
	BF	1.66	5.46	1.70	5.57	1.85	6.07	3.78	12.40
	CP	5.72	18.77	5.87	19.27	5.90	19.35	8.20	26.90
	W1	7.56	24.81	7.53	24.70	7.76	25.45	9.46	31.04
TAILPLANE	W2	5.96	19.55	5.93	19.46	6.15	20.18	7.88	25.87
	HT	8.39	27.54	8.26	27.10	8.60	28.21	9.98	32.74
	AP	7.04	23.11	6.92	22.71	7.25	23.78	8.66	28.41
ENGINE/ NACELLE	VT	17.73	58.17	17.60	57.74	17.93	58.84	19.32	63.39
	N1	0.52	1.71	0.56	1.85	0.17	2.32	2.66	8.73
	N2	1.56	5.12	1.58	5.18	1.75	5.75	3.62	11.89

NOTE:

PASSENGER AND CARGO DOOR GROUND CLEARANCES ARE MEASURED FROM THE CENTER OF THE DOOR SILL AND FROM FLOOR LEVEL.

F_AC_020300_1_0120101_01_03

Ground Clearances
FIGURE-2-3-0-991-012-A01

A340-500/-600

AIRCRAFT CHARACTERISTICS - AIRPORT AND MAINTENANCE PLANNING

**ON A/C A340-500

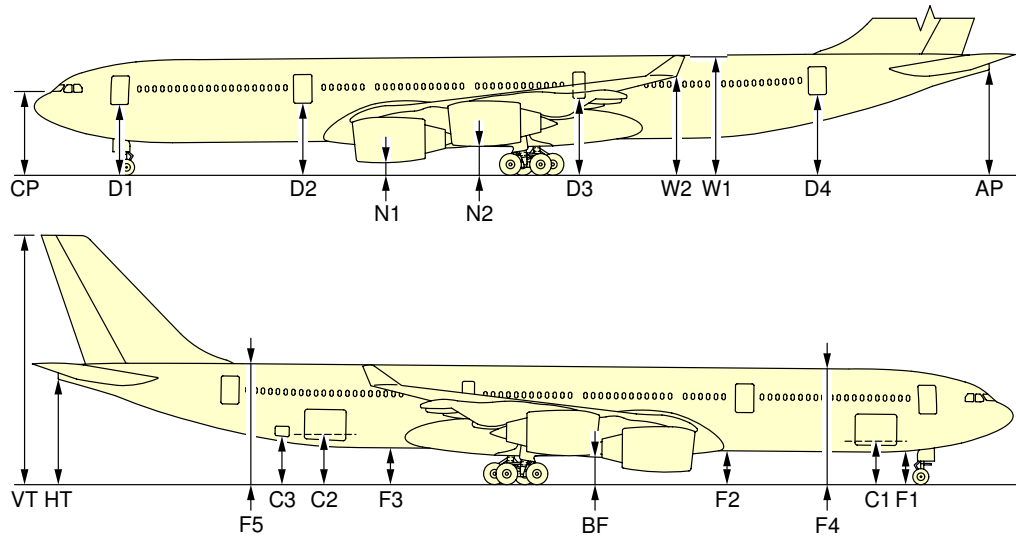

A/C CONFIGURATION		MRW				171 000 kg (376 990 lb)		A/C JACKED FDL = 7.20 m (23.62 ft)	
		FWD CG		AFT CG		MID CG		m	ft
		m	ft	m	ft	m	ft		
DOORS	D1	4.53	14.85	4.63	15.18	4.76	15.61	7.03	23.07
	D2	4.75	15.58	4.80	15.74	4.96	16.28	7.03	23.07
	D3	5.08	16.66	5.05	16.57	5.27	17.28	7.03	23.07
	D4	5.58	18.31	5.49	18.00	5.75	18.86	7.25	23.78
	C1	2.65	8.70	2.74	8.98	2.88	9.44	5.09	16.71
	C2	3.36	11.01	3.29	10.79	3.53	11.59	5.14	16.86
FUSELAGE	C3	3.46	11.35	3.38	11.09	3.63	11.92	5.19	17.03
	F1	1.94	6.36	2.03	6.64	2.16	7.10	4.38	14.37
	F2	2.10	6.89	2.15	7.04	2.31	7.58	4.38	14.37
	F3	2.10	6.89	2.07	6.79	2.29	7.51	4.05	13.30
	F4	7.74	25.38	7.79	25.54	7.95	26.08	10.02	32.87
	F5	8.35	27.40	8.26	27.09	8.52	27.95	10.02	32.87
WINGS	BF	1.63	5.36	1.65	5.42	1.84	6.03	3.78	12.40
	CP	5.63	18.48	5.75	18.86	5.87	19.25	8.20	26.90
TAILPLANE	W1	7.62	25.01	7.57	24.83	7.81	25.61	9.46	31.04
	W2	6.01	19.70	5.96	19.56	6.19	20.31	7.88	25.87
ENGINE/ NACELLE	HT	8.53	27.97	8.38	27.48	8.68	28.47	9.96	32.68
	AP	7.18	23.57	7.05	23.12	7.34	24.08	8.66	28.41
VT	VT	17.38	57.01	17.23	56.53	17.53	57.51	18.82	61.75
	N1	0.48	1.58	0.51	1.66	0.69	2.25	2.66	8.73
N2	N2	1.56	5.10	1.55	5.10	1.75	5.75	3.62	11.89

NOTE:

PASSENGER AND CARGO DOOR GROUND CLEARANCES ARE MEASURED FROM THE CENTER OF THE DOOR SILL AND FROM FLOOR LEVEL.

F_AC_020300_1_0120201_01_01

Ground Clearances
FIGURE-2-3-0-991-012-B01

A340-500/-600

AIRCRAFT CHARACTERISTICS - AIRPORT AND MAINTENANCE PLANNING

**ON A/C A340-500 A340-600

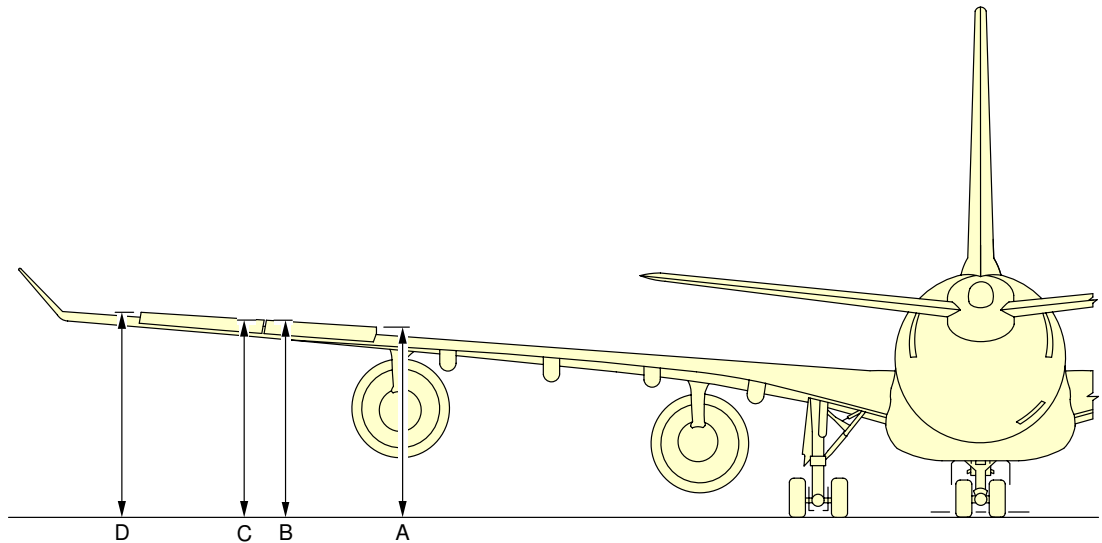

AILERONS UP							
DESCRIPTION		A/C IN MAINTENANCE CONFIGURATION MID CG		MRW FWD CG		MRW AFT CG	
		m	ft	m	ft	m	ft
AILERON 1 INBD	A	6.20	20.33	6.00	19.68	5.99	19.64
AILERON 1 OUTBD	B	6.29	20.63	6.09	19.99	6.07	19.92
AILERON 2 INBD	C	6.21	20.38	6.02	19.75	6.00	19.68
AILERON 2 OUTBD	D	6.40	21.01	6.21	20.37	6.18	20.28

F_AC_020300_1_0130101_01_03

Ground Clearances
Ailerons – Up
FIGURE-2-3-0-991-013-A01

A340-500/-600

AIRCRAFT CHARACTERISTICS - AIRPORT AND MAINTENANCE PLANNING

**ON A/C A340-500 A340-600

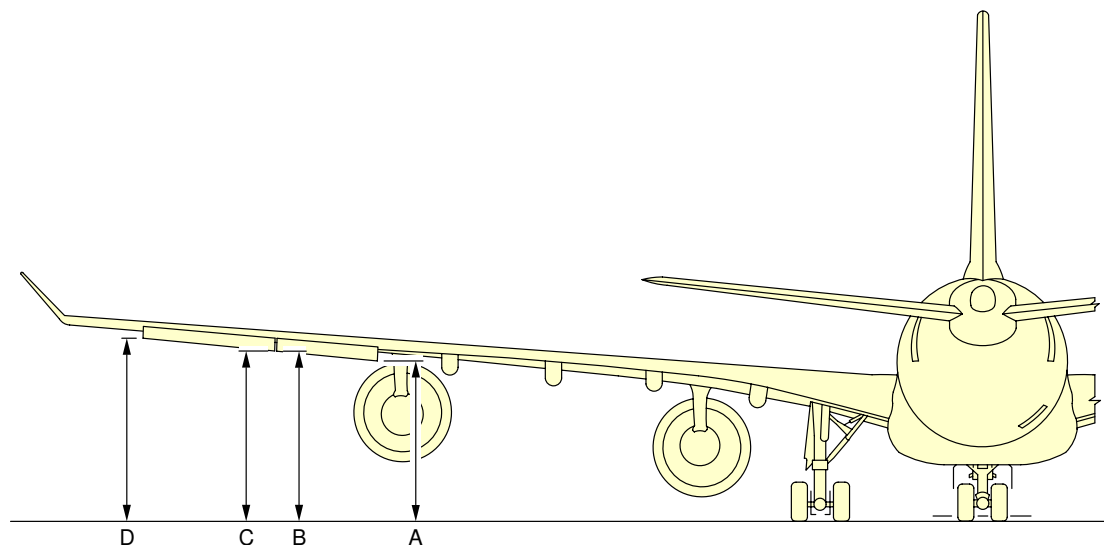

AILERONS DOWN							
DESCRIPTION		A/C IN MAINTENANCE CONFIGURATION MID CG		MRW FWD CG		MRW AFT CG	
		m	ft	m	ft	m	ft
AILERON 1 INBD	A	5.26	17.24	5.06	16.61	5.05	16.56
AILERON 1 OUTBD	B	5.60	18.38	5.41	17.74	5.39	17.67
AILERON 2 INBD	C	5.53	18.16	5.34	17.53	5.32	17.45
AILERON 2 OUTBD	D	5.91	19.38	5.71	18.74	5.68	18.65

F_AC_020300_1_0240101_01_01

Ground Clearances
Ailerons – Down
FIGURE-2-3-0-991-024-A01

A340-500/-600

AIRCRAFT CHARACTERISTICS - AIRPORT AND MAINTENANCE PLANNING

**ON A/C A340-500 A340-600

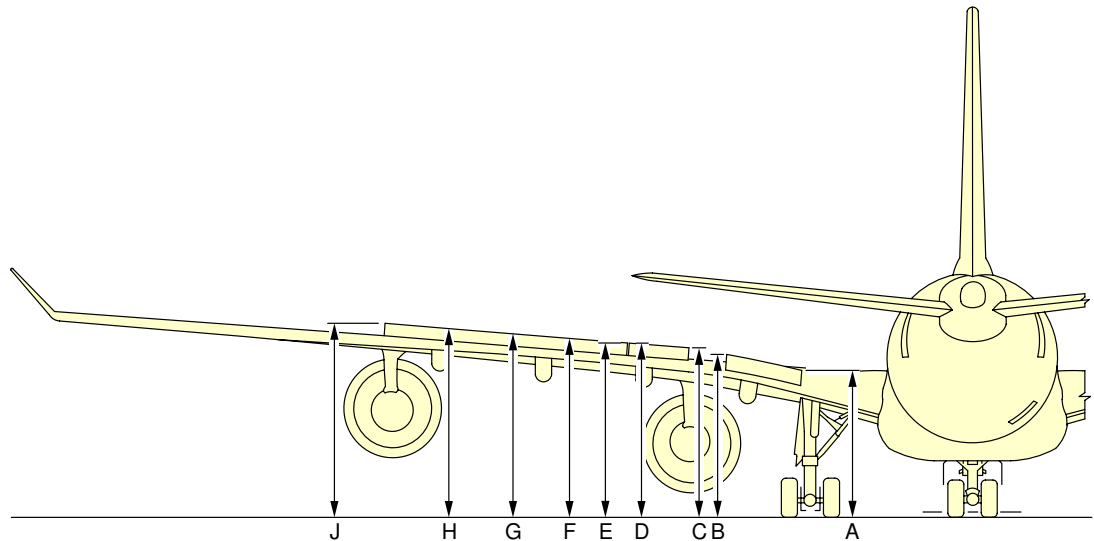

SPOILERS EXTENDED							
DESCRIPTION		A/C IN MAINTENANCE CONFIGURATION MID CG		MRW FWD CG		MRW AFT CG	
		m	ft	m	ft	m	ft
SPOILER 1 INBD	A	4.78	15.67	4.58	15.04	4.59	15.05
SPOILER 1 OUTBD	B	5.29	17.36	5.10	16.74	5.10	16.75
SPOILER 2 INBD	C	5.75	18.88	5.56	18.25	5.57	18.26
SPOILER 2 OUTBD	D	5.89	19.33	5.70	18.70	5.70	18.70
SPOILER 3 INBD	E	5.87	19.26	5.68	18.63	5.68	18.63
SPOILER 3/4	F	6.03	19.79	5.84	19.16	5.84	19.16
SPOILER 4/5	G	6.16	20.20	5.97	19.57	5.96	19.55
SPOILER 5/6	H	6.27	20.56	6.07	19.93	6.06	19.90
SPOILER 6 OUTBD	J	6.35	20.84	6.16	20.21	6.15	20.17

F_AC_020300_1_0250101_01_01

Ground Clearances
Spoilers – Extended
FIGURE-2-3-0-991-025-A01

A340-500/-600

AIRCRAFT CHARACTERISTICS - AIRPORT AND MAINTENANCE PLANNING

**ON A/C A340-500 A340-600

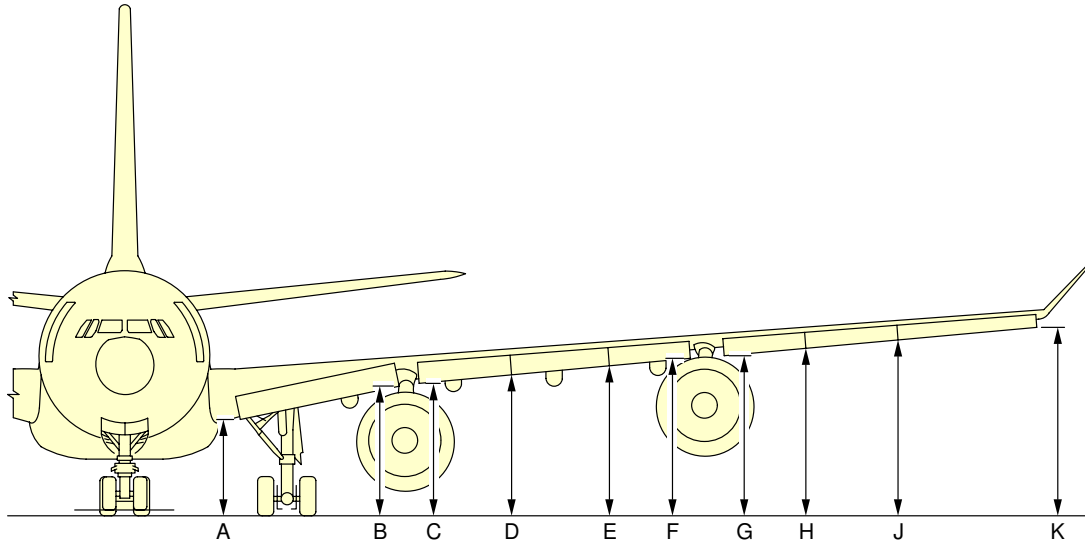

LEADING EDGE SLATS EXTENDED							
DESCRIPTION		A/C IN MAINTENANCE CONFIGURATION MID CG		MRW FWD CG		MRW AFT CG	
		m	ft	m	ft	m	ft
SLAT 1 INBD	A	3.58	11.74	3.37	11.06	3.40	11.15
SLAT 1 OUTBD	B	4.31	14.14	4.11	13.47	4.12	13.53
SLAT 2 INBD	C	4.34	14.25	4.14	13.58	4.15	13.63
SLAT 2/3	D	4.66	15.29	4.46	14.64	4.46	14.64
SLAT 3/4	E	4.91	16.12	4.72	15.47	4.71	15.46
SLAT 4 OUTBD	F	5.14	16.85	4.94	16.21	4.93	16.17
SLAT 5 INBD	G	5.22	17.12	5.02	16.48	5.01	16.44
SLAT 5/6	H	5.41	17.75	5.22	17.12	5.20	17.05
SLAT 6/7	J	5.61	18.39	5.42	17.78	5.39	17.68
SLAT 7 OUTBD	K	5.91	19.39	5.73	18.79	5.68	18.65

F_AC_020300_1_0260101_01_01

Ground Clearances
Leading Edge Slats – Extended
FIGURE-2-3-0-991-026-A01

A340-500/-600

AIRCRAFT CHARACTERISTICS - AIRPORT AND MAINTENANCE PLANNING

****ON A/C A340-500 A340-600**

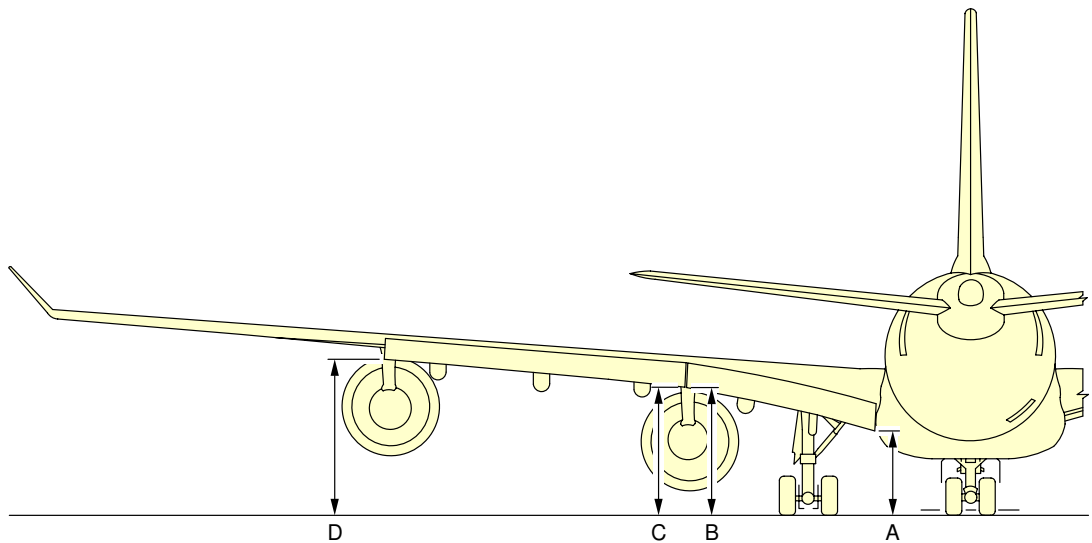

FLAP EXTENDED							
DESCRIPTION		A/C IN MAINTENANCE CONFIGURATION MID CG		MRW FWD CG		MRW AFT CG	
		m	ft	m	ft	m	ft
FLAP 1 INBD	A	2.76	9.06	2.57	8.43	2.57	8.43
FLAP 1 OUTBD	B	3.96	12.99	3.77	12.36	3.76	12.35
FLAP 2 INBD	C	3.95	12.95	3.76	12.32	3.75	12.31
FLAP 2 OUTBD	D	4.82	15.80	4.62	15.17	4.61	15.11

F_AC_020300_1_0270101_01_01

Ground Clearances
Trailing Edge Flaps – Extended
FIGURE-2-3-0-991-027-A01

A340-500/-600

AIRCRAFT CHARACTERISTICS - AIRPORT AND MAINTENANCE PLANNING

****ON A/C A340-500 A340-600**

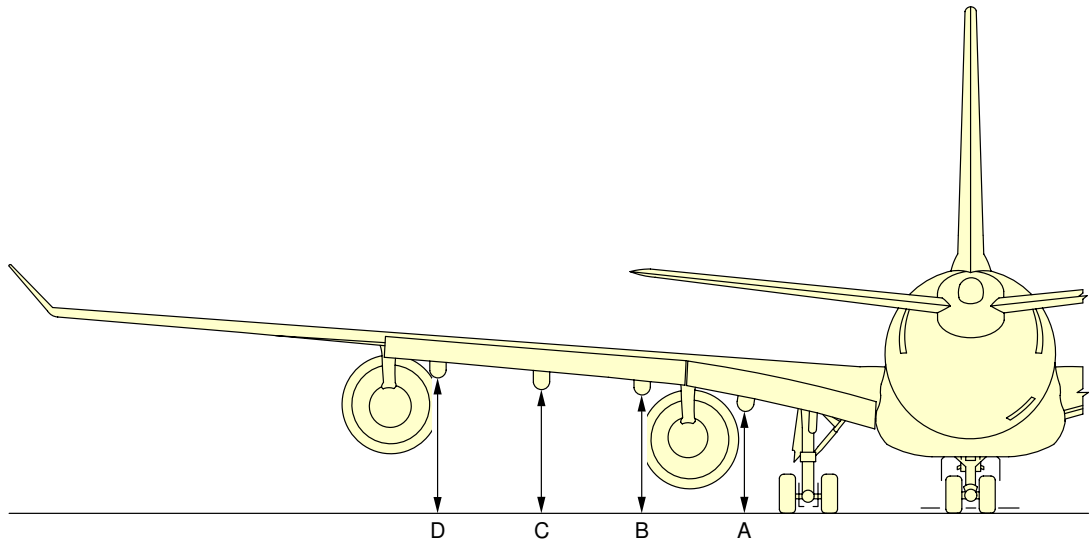

FLAP TRACKS EXTENDED							
DESCRIPTION		A/C IN MAINTENANCE CONFIGURATION MID CG		MRW FWD CG		MRW AFT CG	
		m	ft	m	ft	m	ft
FLAP TRACK 2	A	2.78	9.12	2.59	8.50	2.58	8.47
FLAP TRACK 3	B	3.25	10.66	3.06	10.03	3.05	10.00
FLAP TRACK 4	C	3.46	11.34	3.27	10.71	3.25	10.67
FLAP TRACK 5	D	3.72	12.21	3.53	11.58	3.51	11.52

F_AC_020300_1_0280101_01_01

Ground Clearances
Flap Tracks – Extended
FIGURE-2-3-0-991-028-A01

A340-500/-600

AIRCRAFT CHARACTERISTICS - AIRPORT AND MAINTENANCE PLANNING

**ON A/C A340-500 A340-600

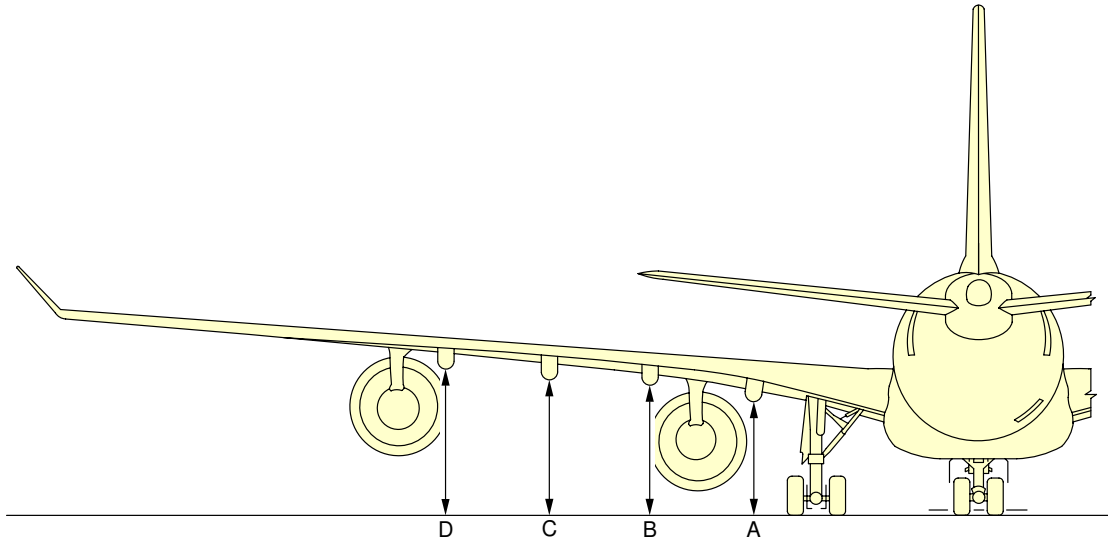

FLAP TRACKS RETRACTED								
AIRCRAFT TYPE	DESCRIPTION		A/C IN MAINTENANCE CONFIGURATION MID CG		MRW FWD CG		MRW AFT CG	
			m	ft	m	ft	m	ft
A340-600	FLAP TRACK 2	A	3.84	12.60	3.65	11.97	3.65	11.97
	FLAP TRACK 3	B	4.31	14.16	4.12	13.53	4.13	13.54
	FLAP TRACK 4	C	4.36	14.30	4.17	13.67	4.17	13.69
	FLAP TRACK 5	D	4.77	15.65	4.58	15.01	4.56	14.97
A340-500	FLAP TRACK 2	A	3.86	12.66	3.67	12.03	3.65	11.96
	FLAP TRACK 3	B	4.33	14.20	4.13	13.57	4.12	13.52
	FLAP TRACK 4	C	4.37	14.35	4.18	13.71	4.16	13.66
	FLAP TRACK 5	D	4.80	15.74	4.61	15.13	4.58	15.01

F_AC_020300_1_0310101_01_00

Ground Clearances
 Flap Tracks – Retracted
 FIGURE-2-3-0-991-031-A01

A340-500/-600

AIRCRAFT CHARACTERISTICS - AIRPORT AND MAINTENANCE PLANNING

**ON A/C A340-500 A340-600

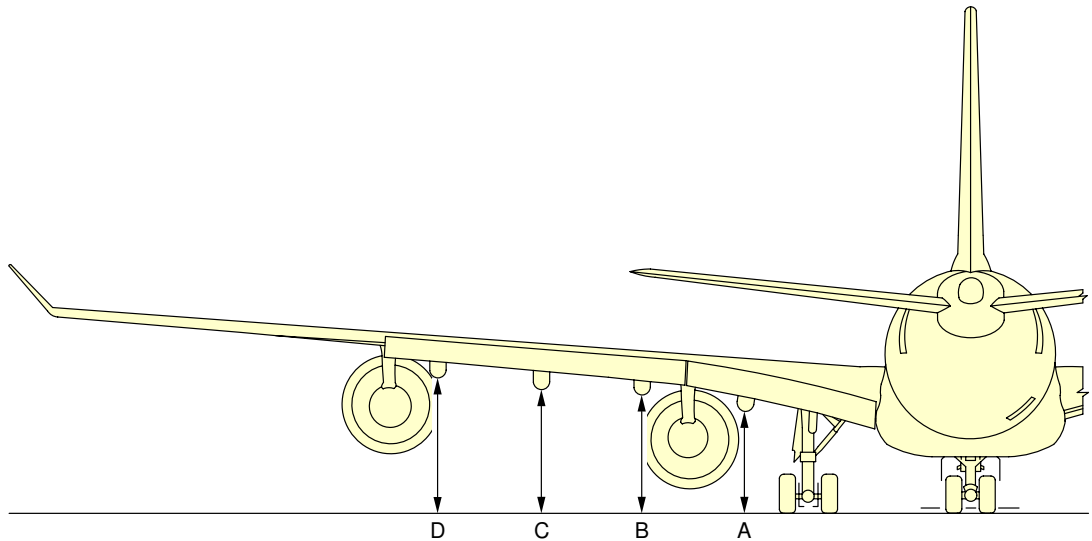

FLAP TRACKS 1+F								
AIRCRAFT TYPE	DESCRIPTION		A/C IN MAINTENANCE CONFIGURATION MID CG		MRW FWD CG		MRW AFT CG	
			m	ft	m	ft	m	ft
A340-600	FLAP TRACK 2	A	3.47	11.38	3.28	10.76	3.28	10.76
	FLAP TRACK 3	B	3.94	12.93	3.75	12.30	3.76	12.34
	FLAP TRACK 4	C	3.99	13.09	3.80	12.47	3.80	12.47
	FLAP TRACK 5	D	4.20	13.78	4.21	13.81	4.19	13.75
A340-500	FLAP TRACK 2	A	3.49	11.45	3.30	10.83	3.28	10.76
	FLAP TRACK 3	B	3.96	12.99	3.76	12.34	3.75	12.30
	FLAP TRACK 4	C	4.00	13.12	3.81	12.50	3.79	12.43
	FLAP TRACK 5	D	4.43	14.53	4.24	13.91	4.21	13.81

F_AC_020300_1_0340101_01_00

Ground Clearances
Flap Tracks - 1 + F
FIGURE-2-3-0-991-034-A01

2-4-1 Interior Arrangements - Plan View****ON A/C A340-500 A340-600**Interior Arrangements - Plan View

1. This section provides the typical interior configuration.

A340-500/-600

AIRCRAFT CHARACTERISTICS - AIRPORT AND MAINTENANCE PLANNING

**ON A/C A340-600

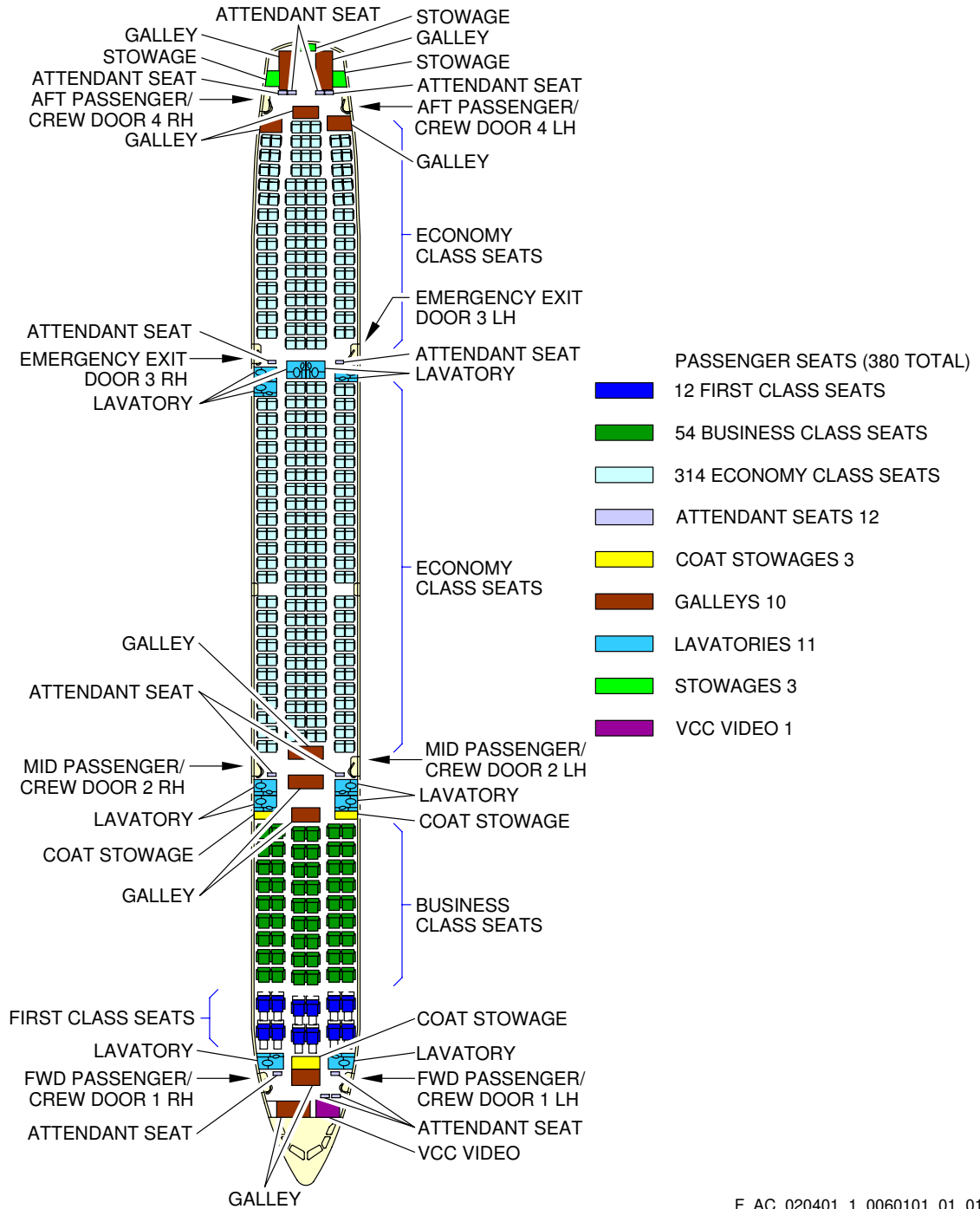

F_AC_020401_1_0060101_01_01

Interior Arrangements - Plan View
 Typical Configuration
 FIGURE-2-4-1-991-006-A01

A340-500/-600

AIRCRAFT CHARACTERISTICS - AIRPORT AND MAINTENANCE PLANNING

**ON A/C A340-500

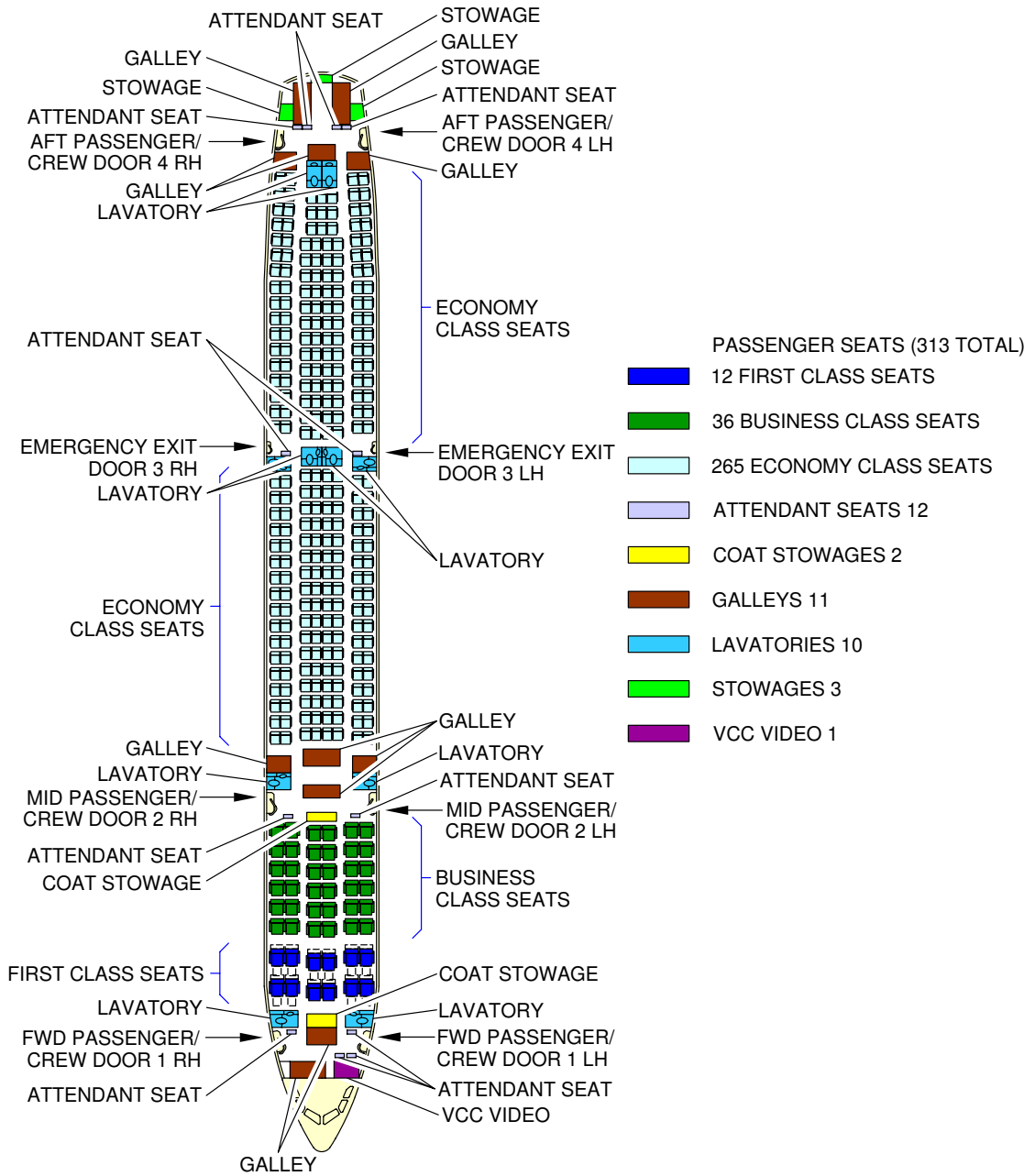

F_AC_020401_1_0070101_01_01

Interior Arrangements - Plan View
Typical Configuration
FIGURE-2-4-1-991-007-A01

2-5-0 Interior Arrangements - Cross Section****ON A/C A340-500 A340-600**Interior Arrangements - Cross Section

1. This section gives the typical configuration of A340-500/-600 models.

A340-500/-600

AIRCRAFT CHARACTERISTICS - AIRPORT AND MAINTENANCE PLANNING

**ON A/C A340-500 A340-600

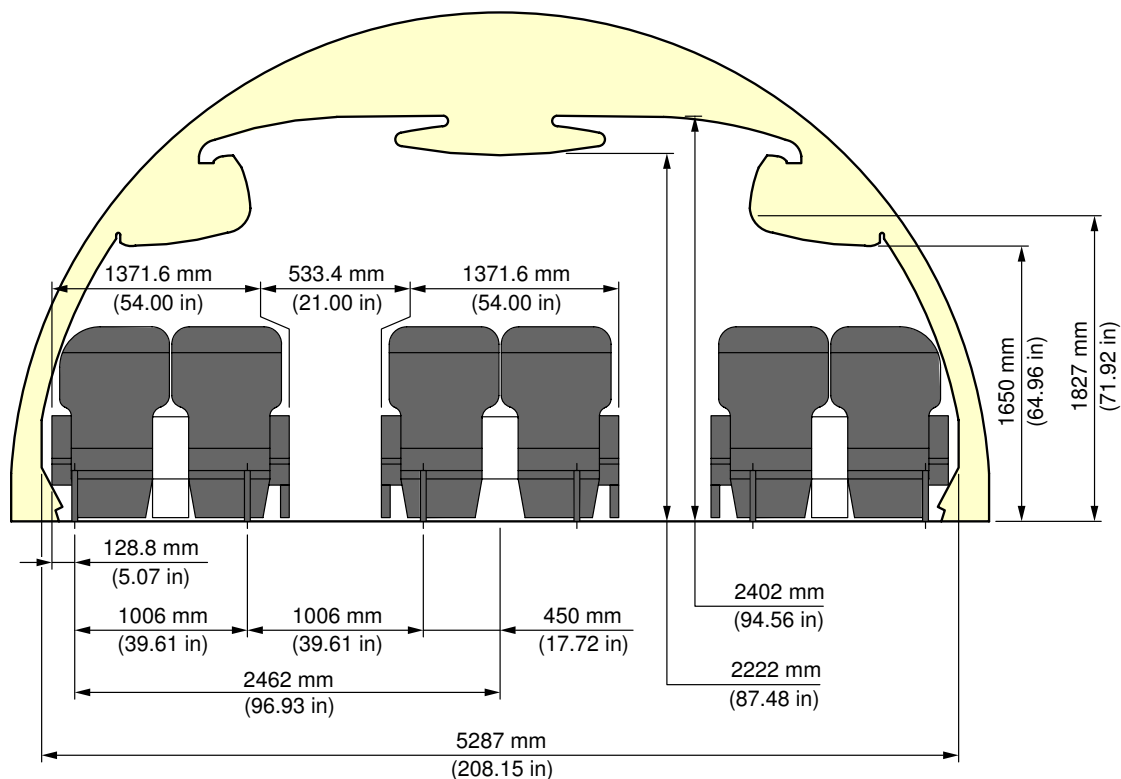

F_AC_020500_1_0030101_01_00

Interior Arrangements - Cross Section
 Typical Configuration
 FIGURE-2-5-0-991-003-A01

A340-500/-600

AIRCRAFT CHARACTERISTICS - AIRPORT AND MAINTENANCE PLANNING

**ON A/C A340-500 A340-600

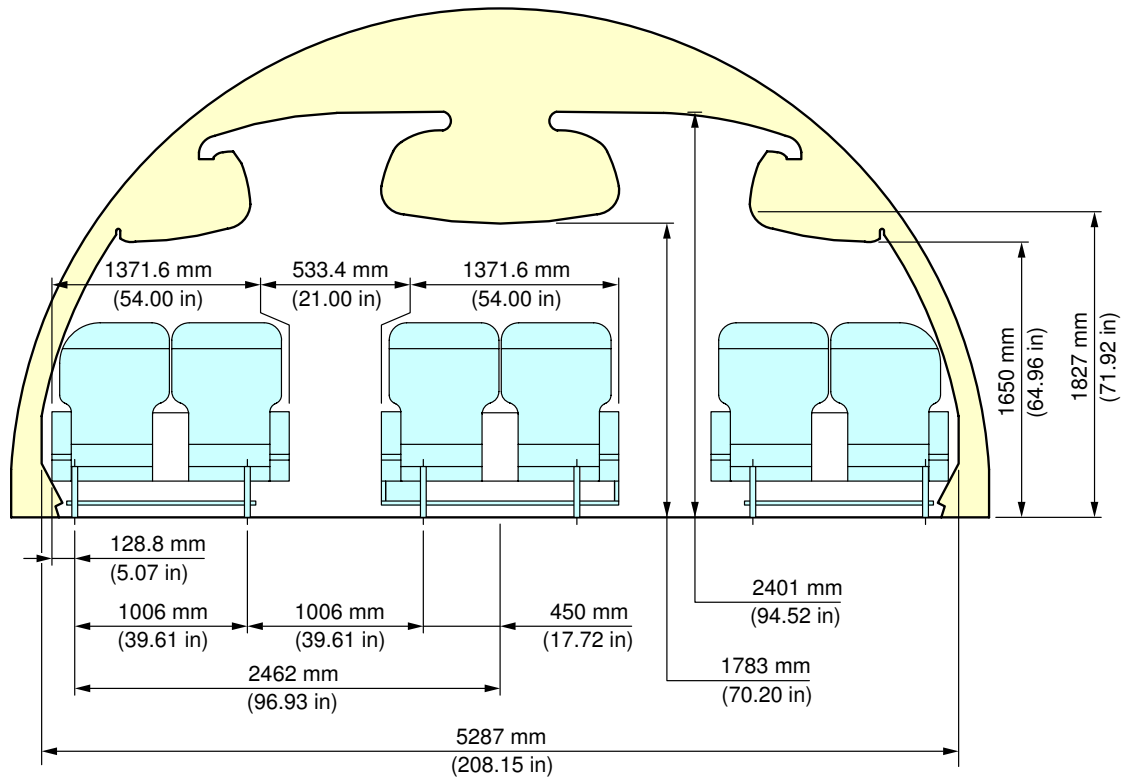

F_AC_020500_1_0040101_01_00

Interior Arrangements - Cross Section
Typical Configuration
FIGURE-2-5-0-991-004-A01

A340-500/-600

AIRCRAFT CHARACTERISTICS - AIRPORT AND MAINTENANCE PLANNING

**ON A/C A340-500 A340-600

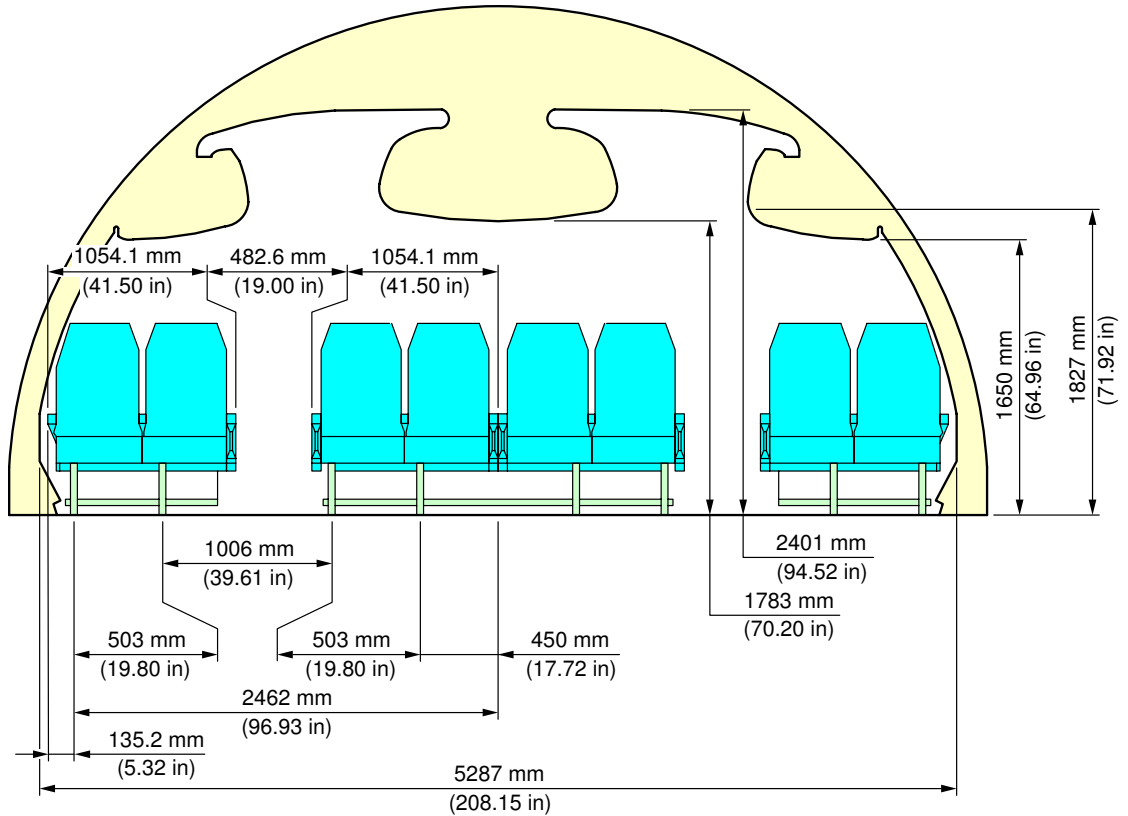

F_AC_020500_1_0050101_01_00

Interior Arrangements - Cross Section
Typical Configuration
FIGURE-2-5-0-991-005-A01

2-6-1 Lower Deck Cargo Compartments****ON A/C A340-500 A340-600**Lower Deck Cargo Compartments

1. This section provides the following data about lower deck cargo compartments:
 - Location and dimensions
 - Loading combinations.

A340-500/-600

AIRCRAFT CHARACTERISTICS - AIRPORT AND MAINTENANCE PLANNING

**ON A/C A340-500 A340-600

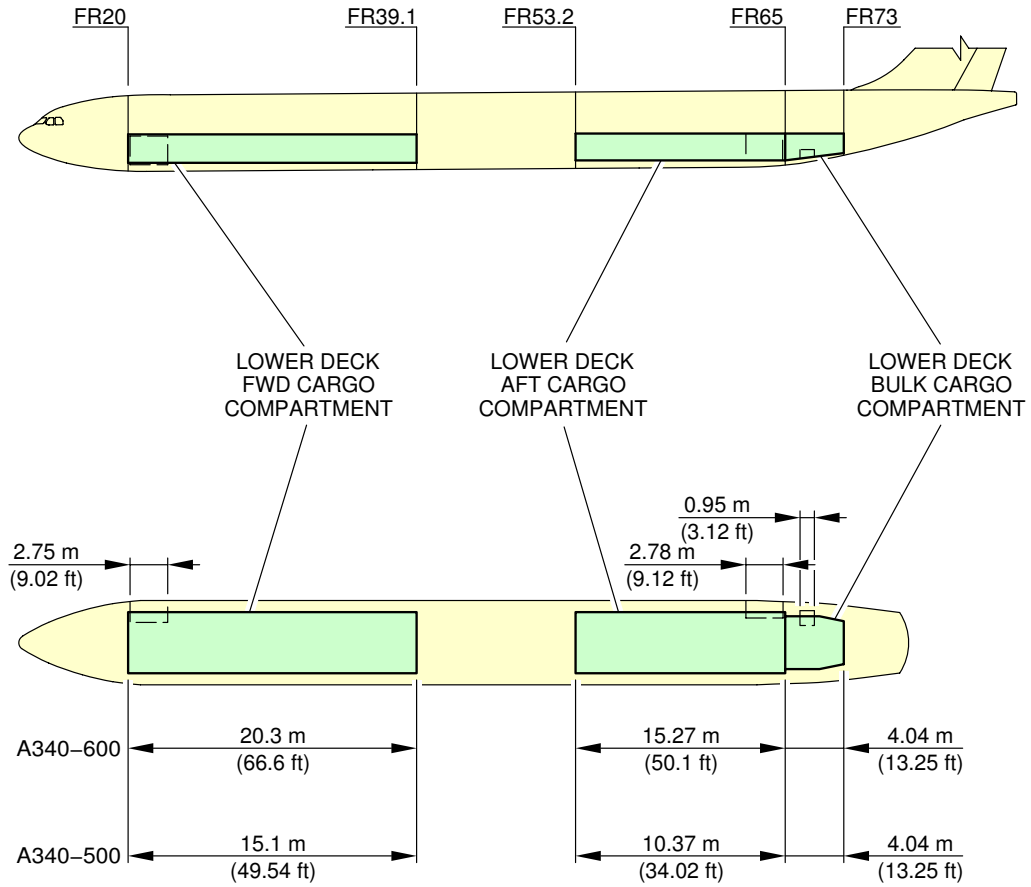

NOTE:
APPROXIMATE DIMENSIONS DEPENDING ON AIRCRAFT CONFIGURATION.

F_AC_020601_1_0070101_01_01

Lower Deck Cargo Compartments
Location and Dimensions
FIGURE-2-6-1-991-007-A01

A340-500/-600

AIRCRAFT CHARACTERISTICS - AIRPORT AND MAINTENANCE PLANNING

****ON A/C A340-500**

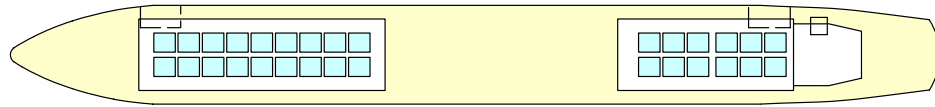

18 LD3 60.4 in X 61.5 in

12 LD3 60.4 in X 61.5 in



6 PALLETS 88 in X 125 in

4 PALLETS 88 in X 125 in

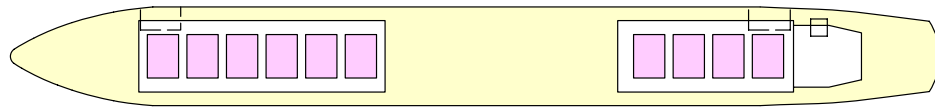

6 PALLETS 96 in X 125 in

4 PALLETS 96 in X 125 in

F_AC_020601_1_0080101_01_03

Lower Deck Cargo Compartments
Loading Combinations
FIGURE-2-6-1-991-008-A01

A340-500/-600

AIRCRAFT CHARACTERISTICS - AIRPORT AND MAINTENANCE PLANNING

****ON A/C A340-600**

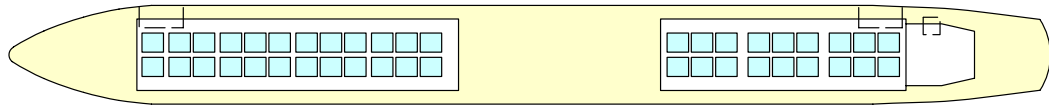

24 LD3 60.4 in X 61.5 in

18 LD3 60.4 in X 61.5 in



8 PALLETS 88 in X 125 in

6 PALLETS 88 in X 125 in

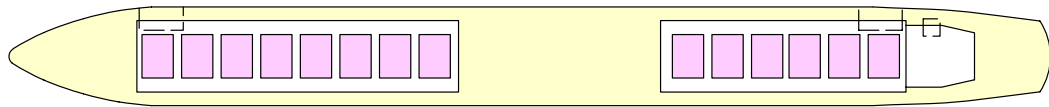

8 PALLETS 96 in X 125 in

6 PALLETS 96 in X 125 in

F_AC_020601_1_0080201_01_02

Lower Deck Cargo Compartments
Loading Combinations
FIGURE-2-6-1-991-008-B01

2-7-0 Door Clearances****ON A/C A340-500 A340-600**Door Clearances

1. This section provides door location, identification and clearances.

A340-500/-600

AIRCRAFT CHARACTERISTICS - AIRPORT AND MAINTENANCE PLANNING

****ON A/C A340-500**

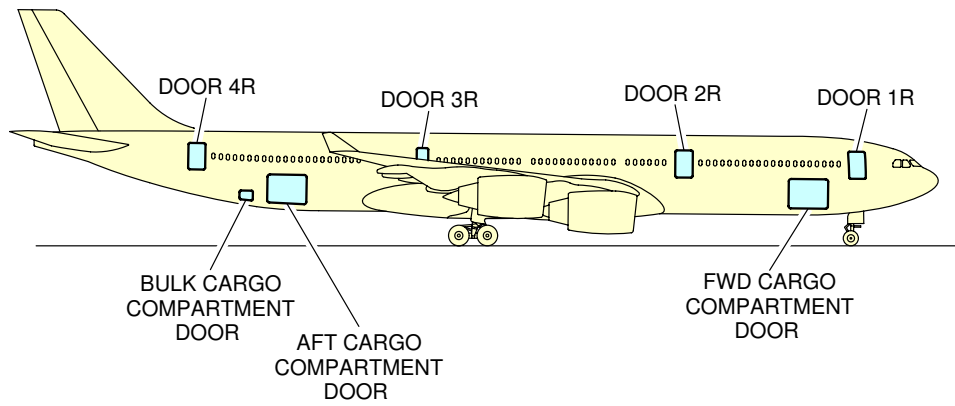
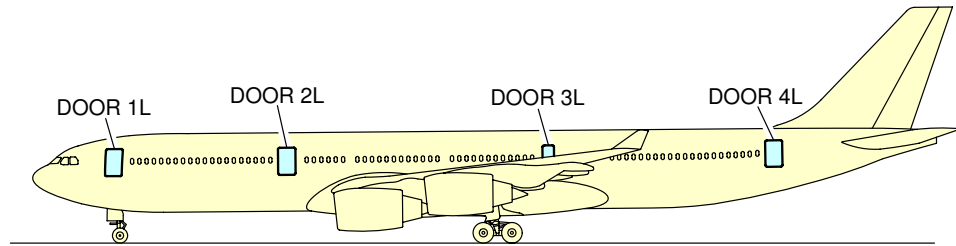

F_AC_020700_1_0100101_01_01

Door Clearances
Door Identification (Sheet 1 of 2)
FIGURE-2-7-0-991-010-A01

A340-500/-600

AIRCRAFT CHARACTERISTICS - AIRPORT AND MAINTENANCE PLANNING

****ON A/C A340-500**

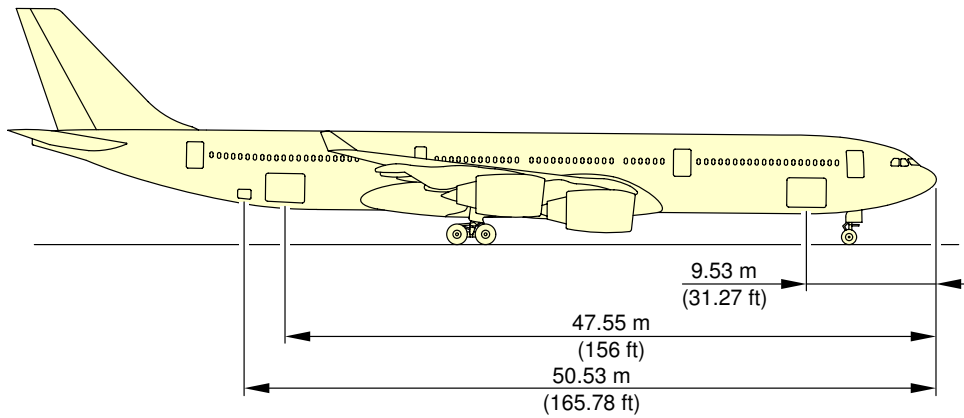
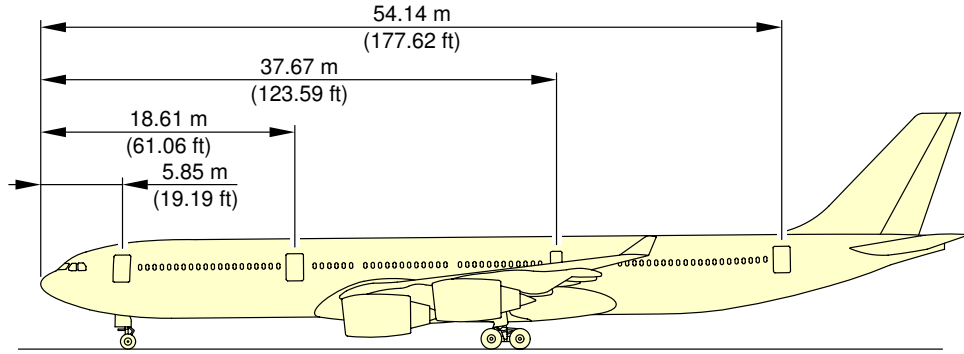

F_AC_020700_1_0100102_01_00

Door Clearances
Door Location (Sheet 2 of 2)
FIGURE-2-7-0-991-010-A01

A340-500/-600

AIRCRAFT CHARACTERISTICS - AIRPORT AND MAINTENANCE PLANNING

****ON A/C A340-600**

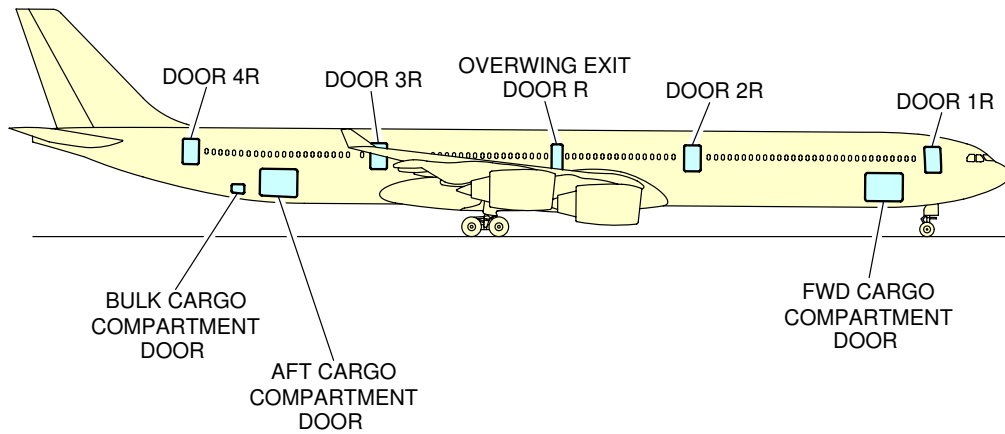
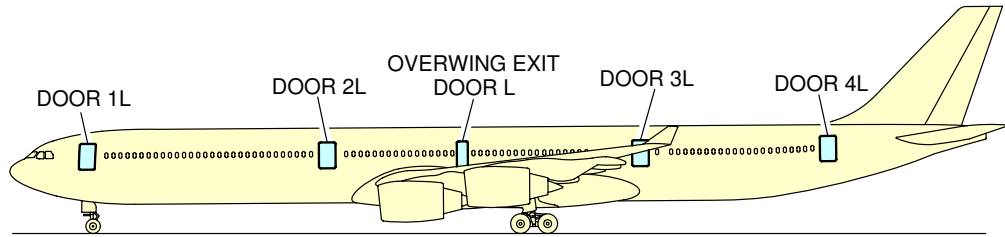

F_AC_020700_1_0100201_01_01

Door Clearances
Door Identification (Sheet 1 of 2)
FIGURE-2-7-0-991-010-B01

A340-500/-600

AIRCRAFT CHARACTERISTICS - AIRPORT AND MAINTENANCE PLANNING

**ON A/C A340-600

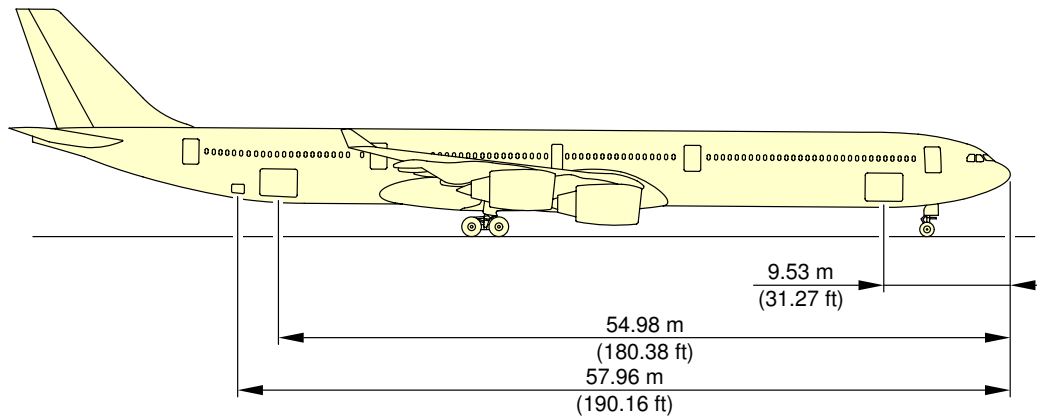
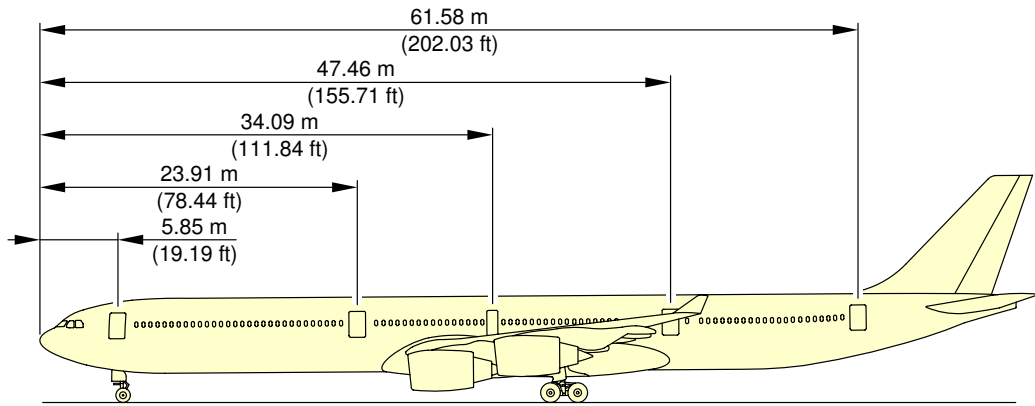

F_AC_020700_1_0100202_01_00

Door Clearances
Door Location (Sheet 2 of 2)
FIGURE-2-7-0-991-010-B01

A340-500/-600

AIRCRAFT CHARACTERISTICS - AIRPORT AND MAINTENANCE PLANNING

**ON A/C A340-500 A340-600

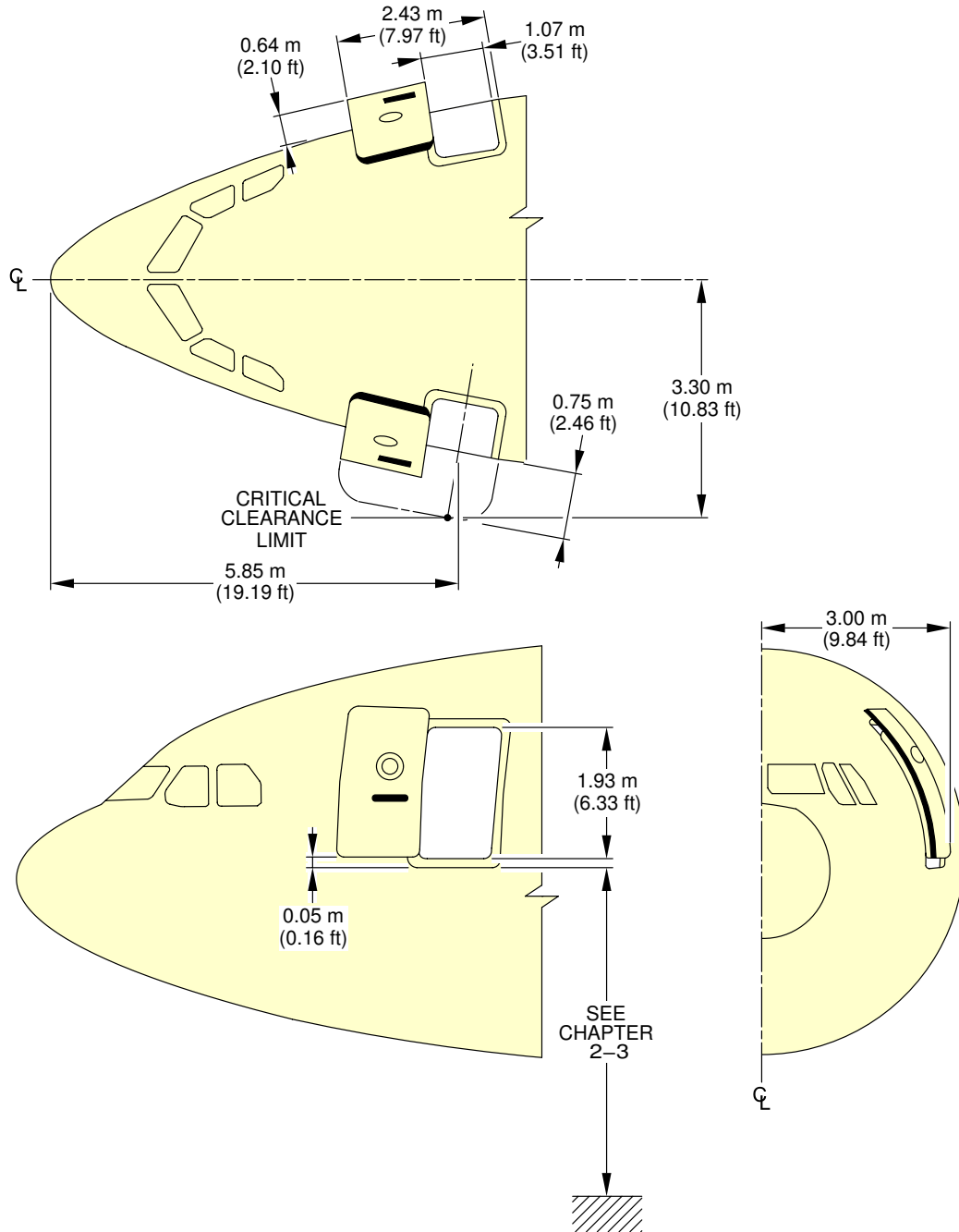

F_AC_020700_1_0410101_01_00

Door Clearances
Forward Passenger/Crew Doors
FIGURE-2-7-0-991-041-A01

A340-500/-600

AIRCRAFT CHARACTERISTICS - AIRPORT AND MAINTENANCE PLANNING

**ON A/C A340-500

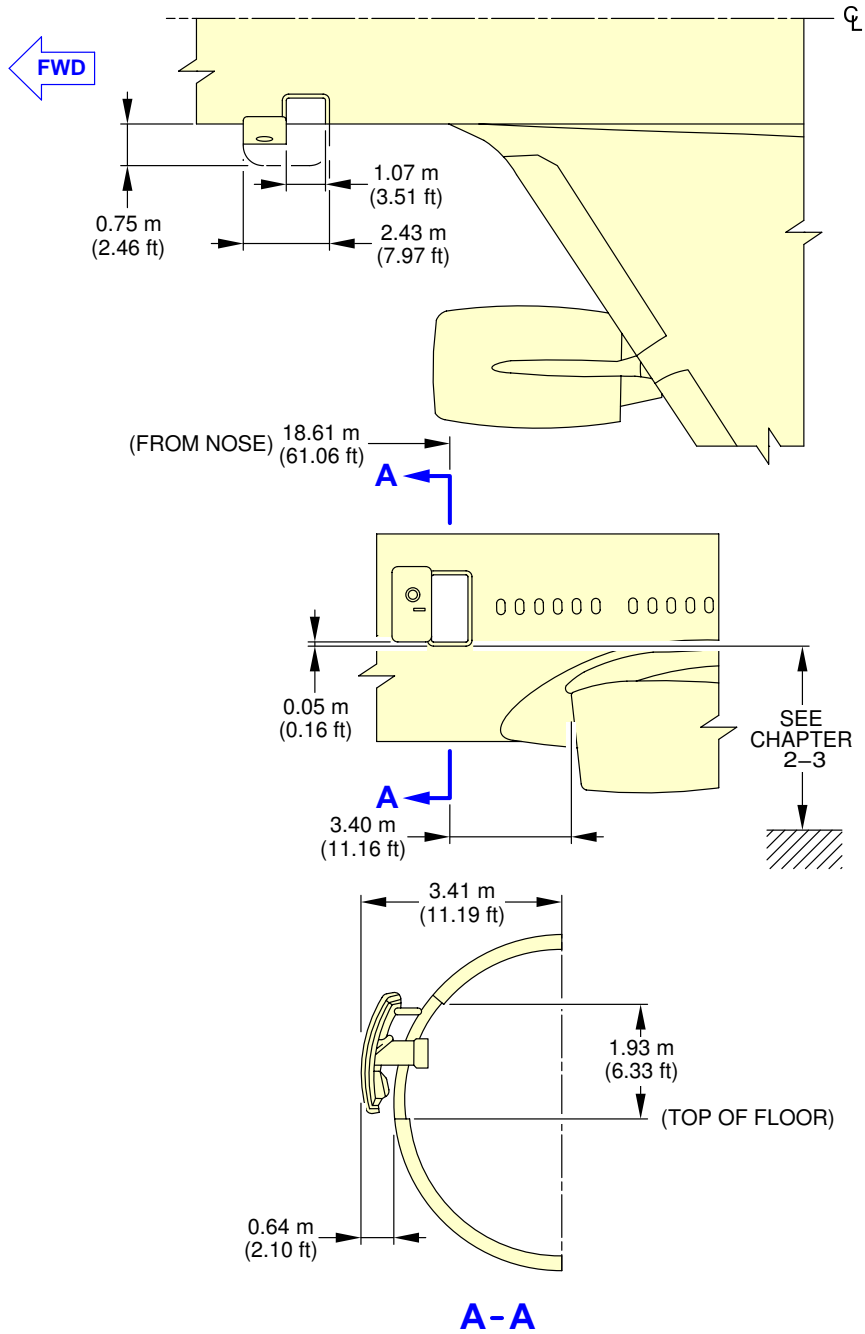

F_AC_020700_1_0420101_01_00

Door Clearances
Mid Passenger/Crew Doors
FIGURE-2-7-0-991-042-A01

A340-500/-600

AIRCRAFT CHARACTERISTICS - AIRPORT AND MAINTENANCE PLANNING

**ON A/C A340-600

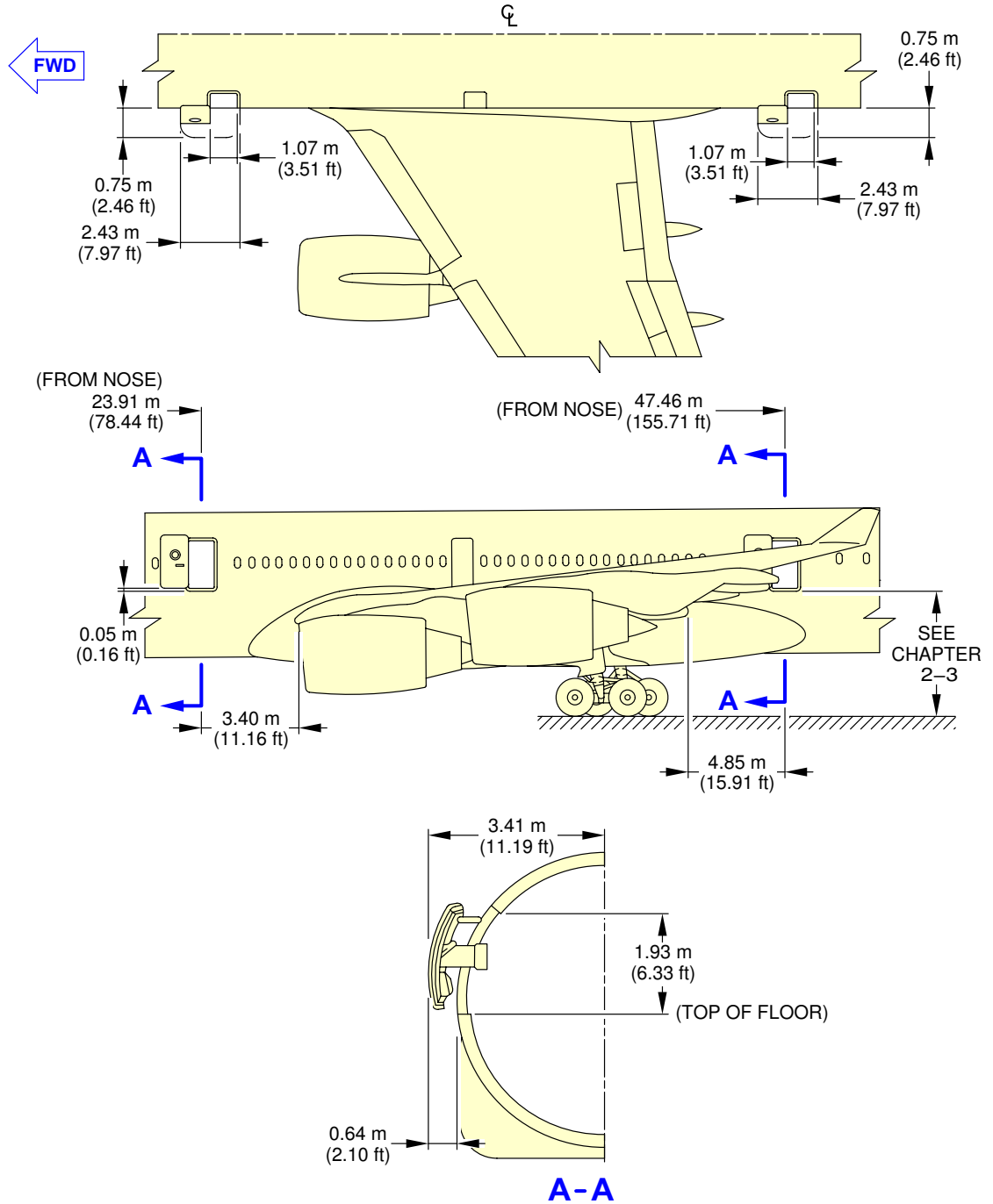

F_AC_020700_1_0430101_01_00

Door Clearances
Mid Passenger/Crew Doors
FIGURE-2-7-0-991-043-A01

A340-500/-600

AIRCRAFT CHARACTERISTICS - AIRPORT AND MAINTENANCE PLANNING

**ON A/C A340-500

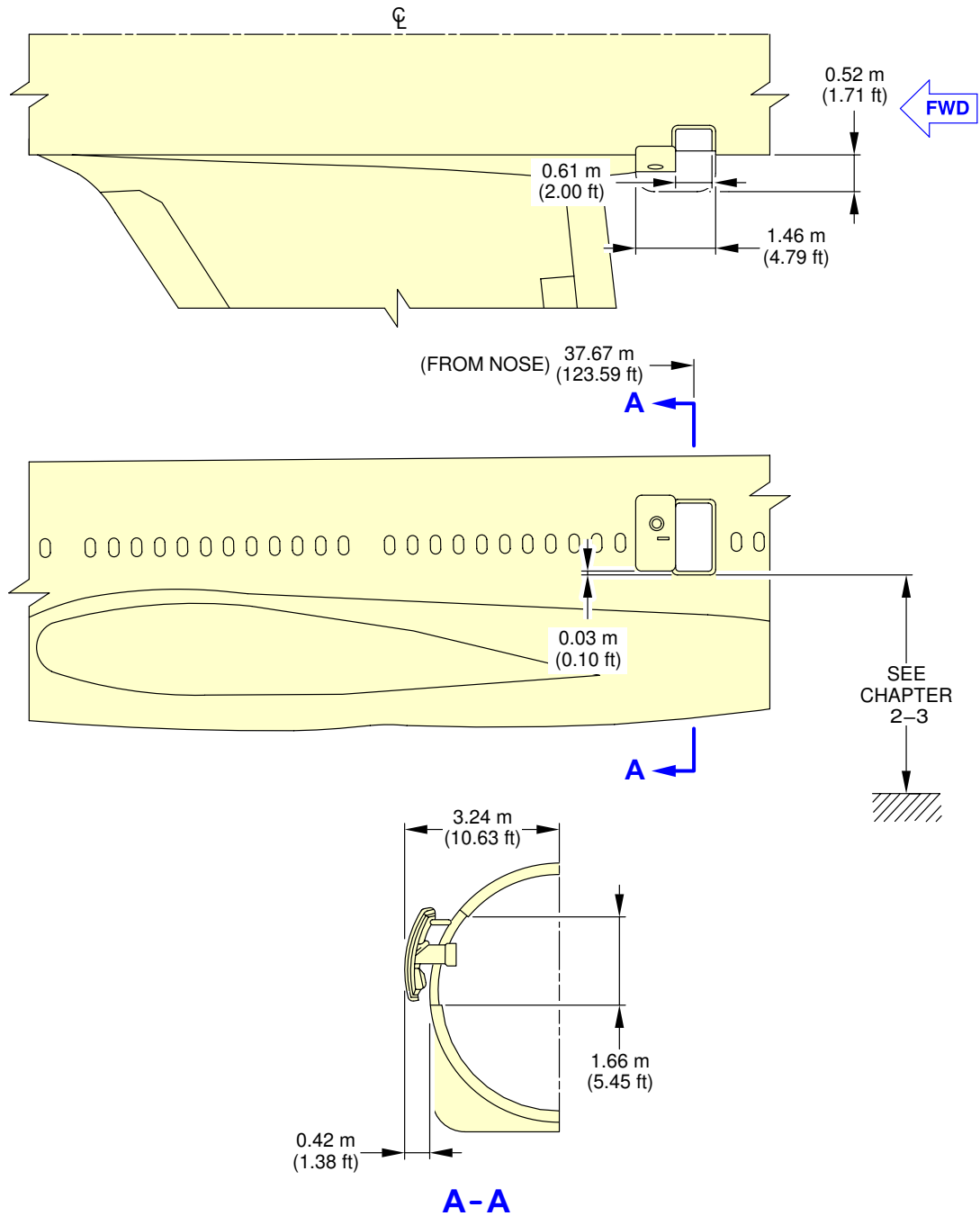

F_AC_020700_1_0440101_01_00

Door Clearances
Emergency Exits
FIGURE-2-7-0-991-044-A01

A340-500/-600

AIRCRAFT CHARACTERISTICS - AIRPORT AND MAINTENANCE PLANNING

**ON A/C A340-600

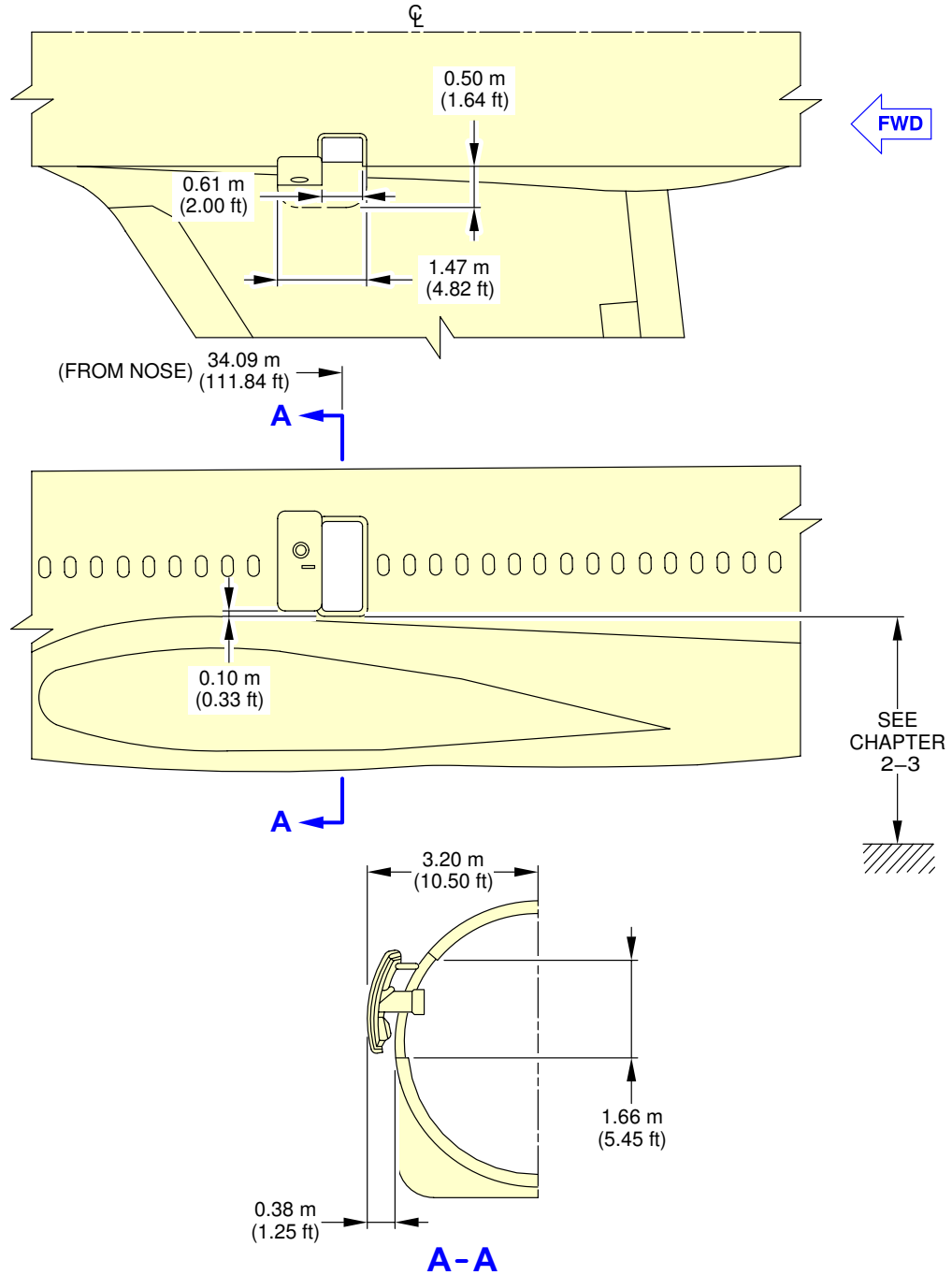

F_AC_020700_1_0450101_01_00

Door Clearances
Emergency Exits
FIGURE-2-7-0-991-045-A01

A340-500/-600

AIRCRAFT CHARACTERISTICS - AIRPORT AND MAINTENANCE PLANNING

**ON A/C A340-500 A340-600

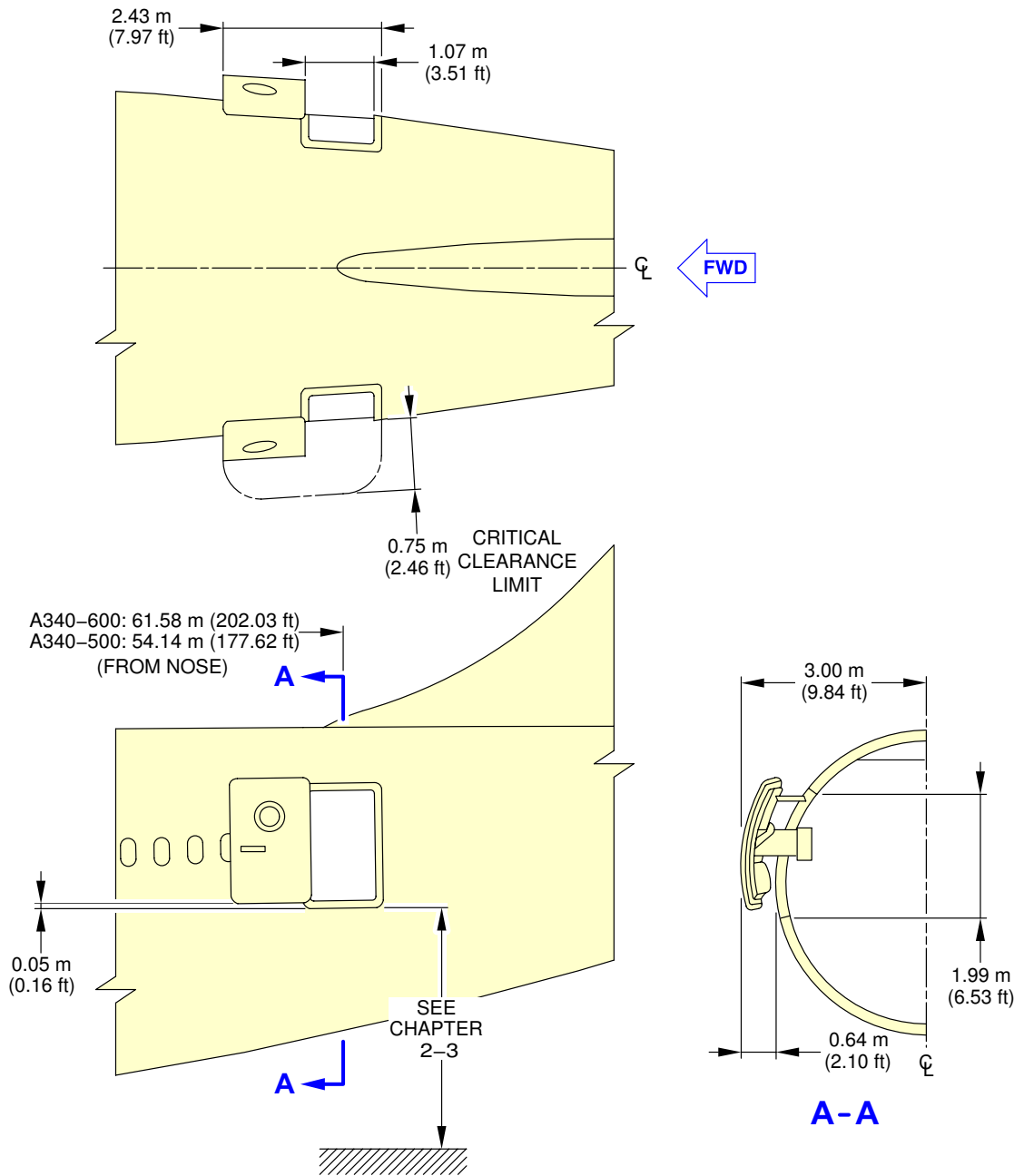

F_AC_020700_1_0460101_01_00

Door Clearances
Aft Passenger/Crew Doors
FIGURE-2-7-0-991-046-A01

A340-500/-600

AIRCRAFT CHARACTERISTICS - AIRPORT AND MAINTENANCE PLANNING

**ON A/C A340-500 A340-600

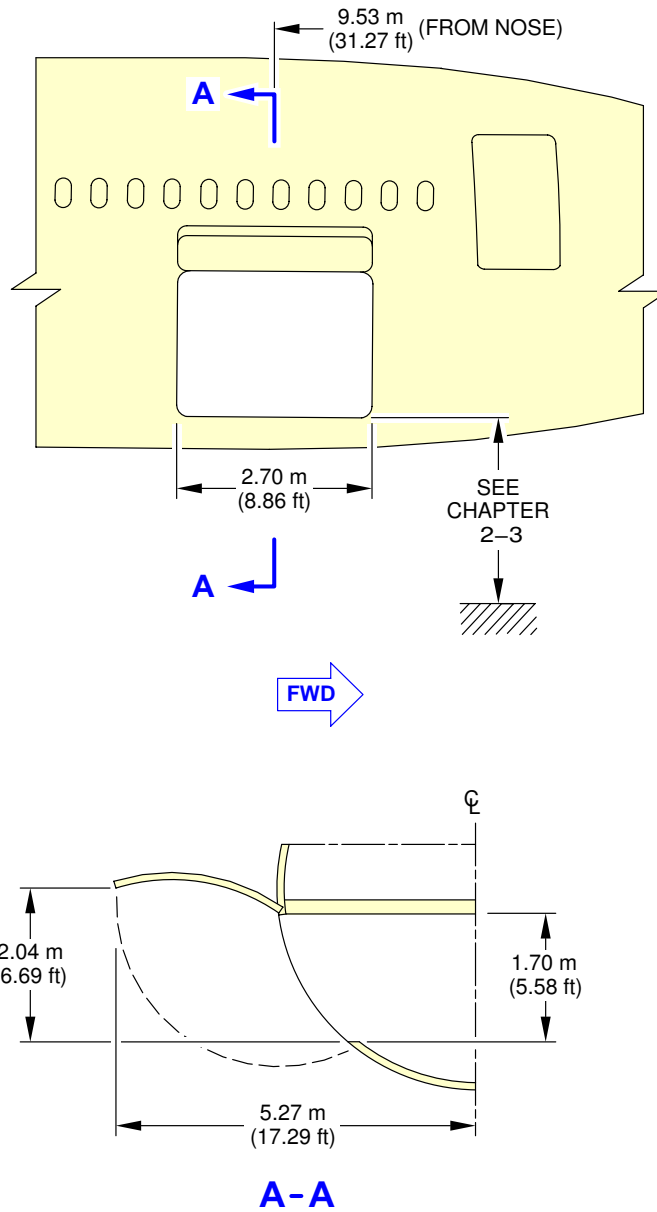

F_AC_020700_1_0470101_01_00

Door Clearances
Forward Cargo Compartment Door
FIGURE-2-7-0-991-047-A01

A340-500/-600

AIRCRAFT CHARACTERISTICS - AIRPORT AND MAINTENANCE PLANNING

**ON A/C A340-500 A340-600

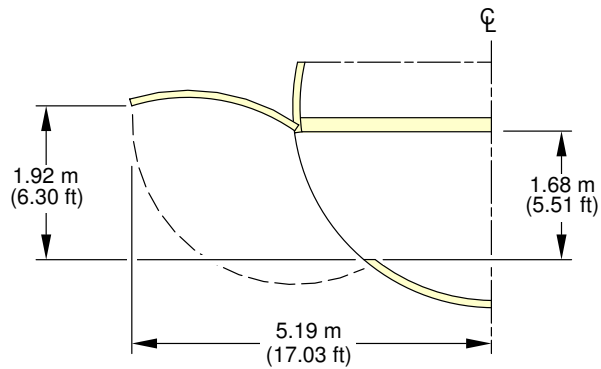
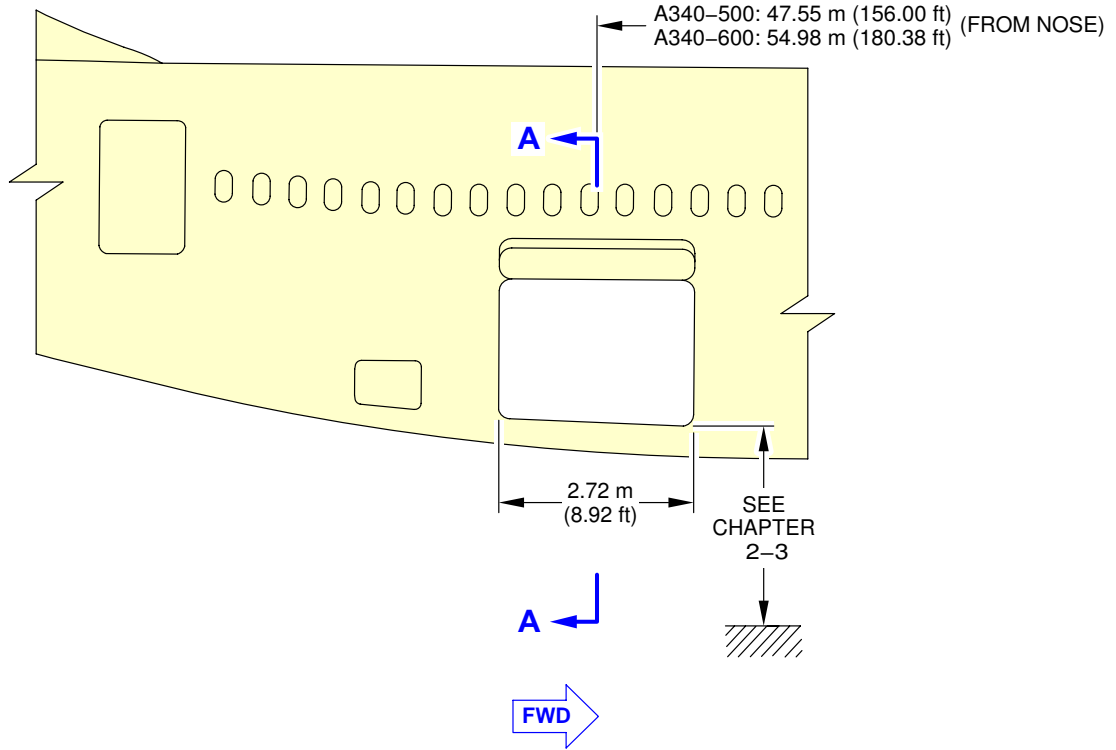

F_AC_020700_1_0480101_01_00

Door Clearances
Aft Cargo Compartment Door
FIGURE-2-7-0-991-048-A01

A340-500/-600

AIRCRAFT CHARACTERISTICS - AIRPORT AND MAINTENANCE PLANNING

**ON A/C A340-500 A340-600

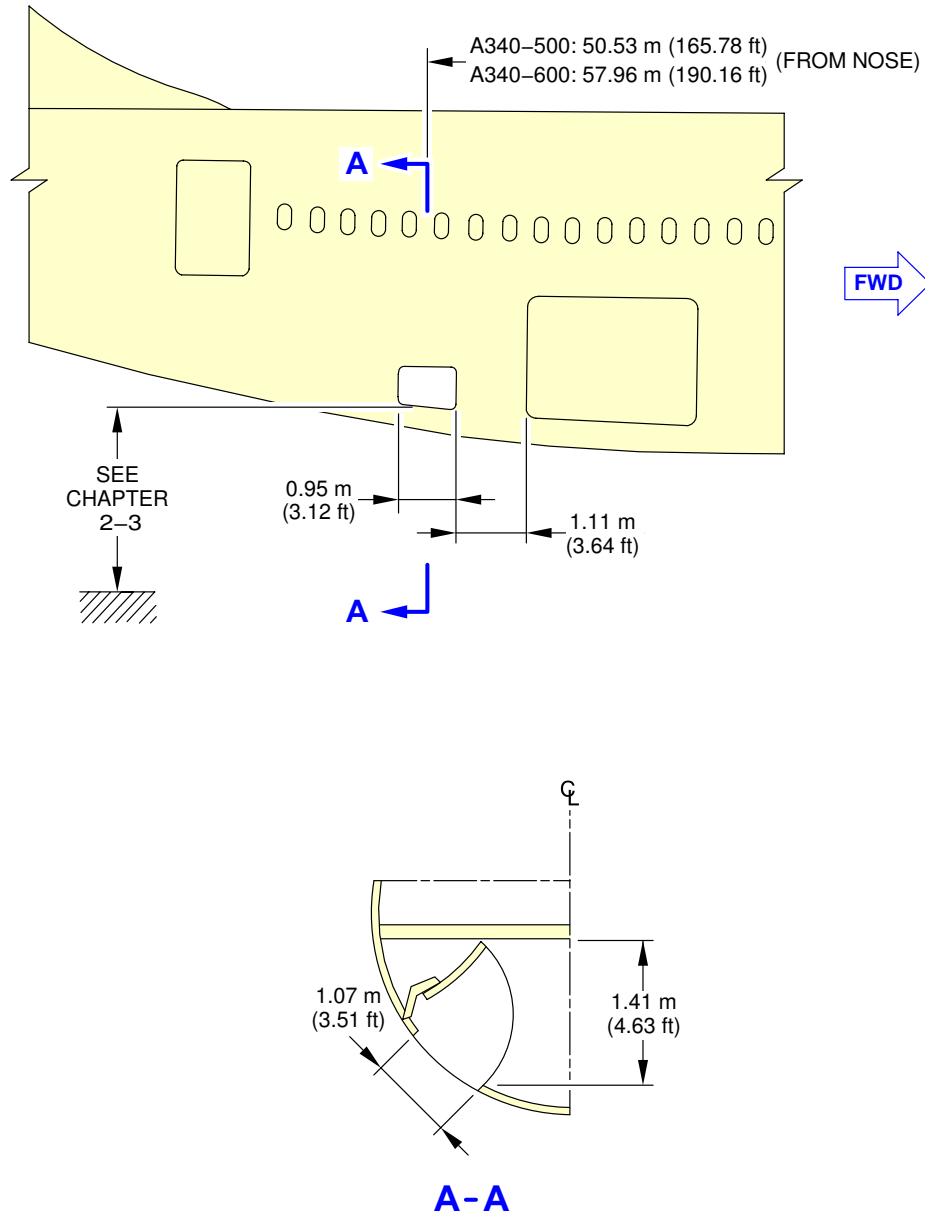

F_AC_020700_1_0490101_01_00

Door Clearances
Bulk Cargo Compartment Door
FIGURE-2-7-0-991-049-A01

A340-500/-600

AIRCRAFT CHARACTERISTICS - AIRPORT AND MAINTENANCE PLANNING

**ON A/C A340-500 A340-600

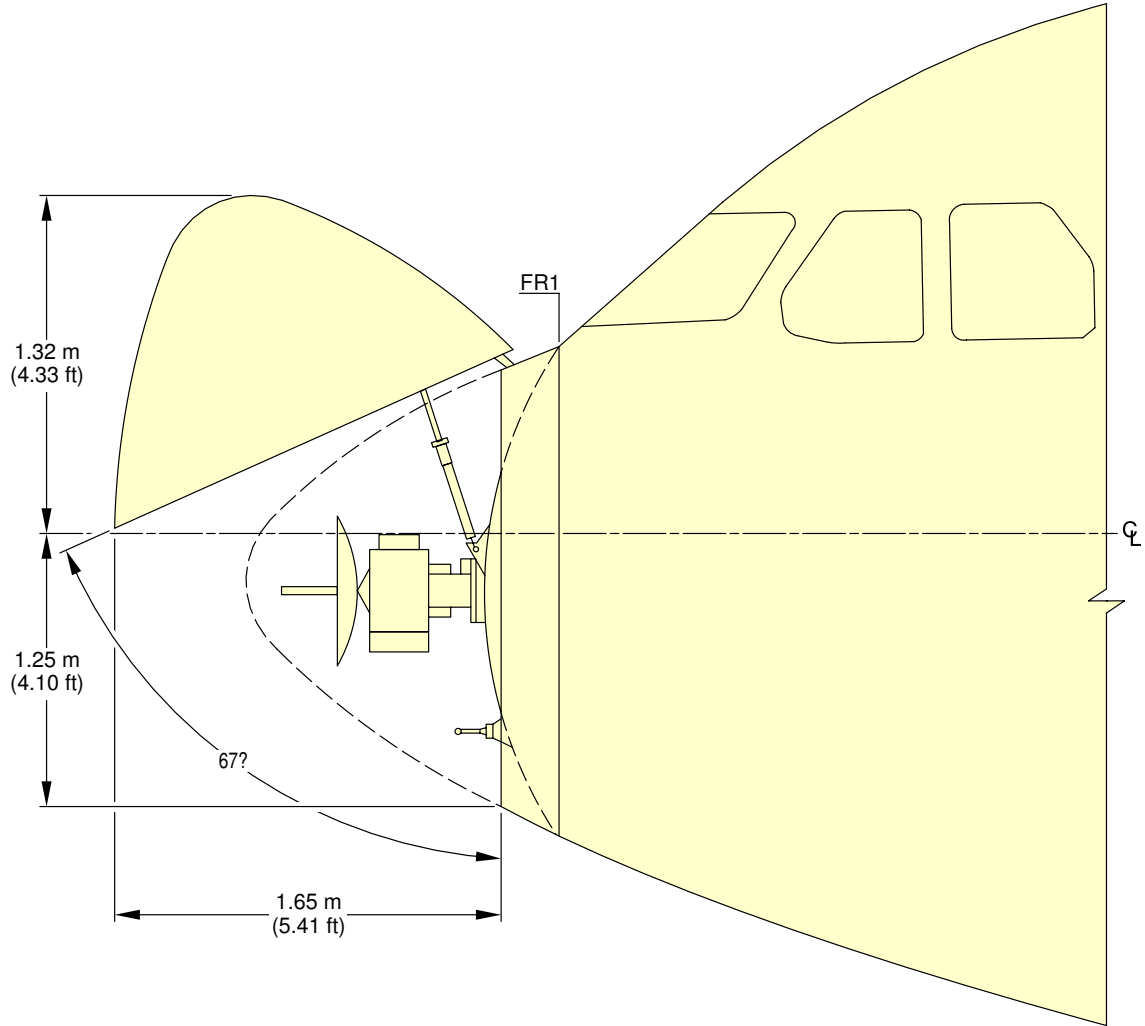

F_AC_020700_1_0500101_01_00

Door Clearances
Radome
FIGURE-2-7-0-991-050-A01

A340-500/-600

AIRCRAFT CHARACTERISTICS - AIRPORT AND MAINTENANCE PLANNING

**ON A/C A340-500

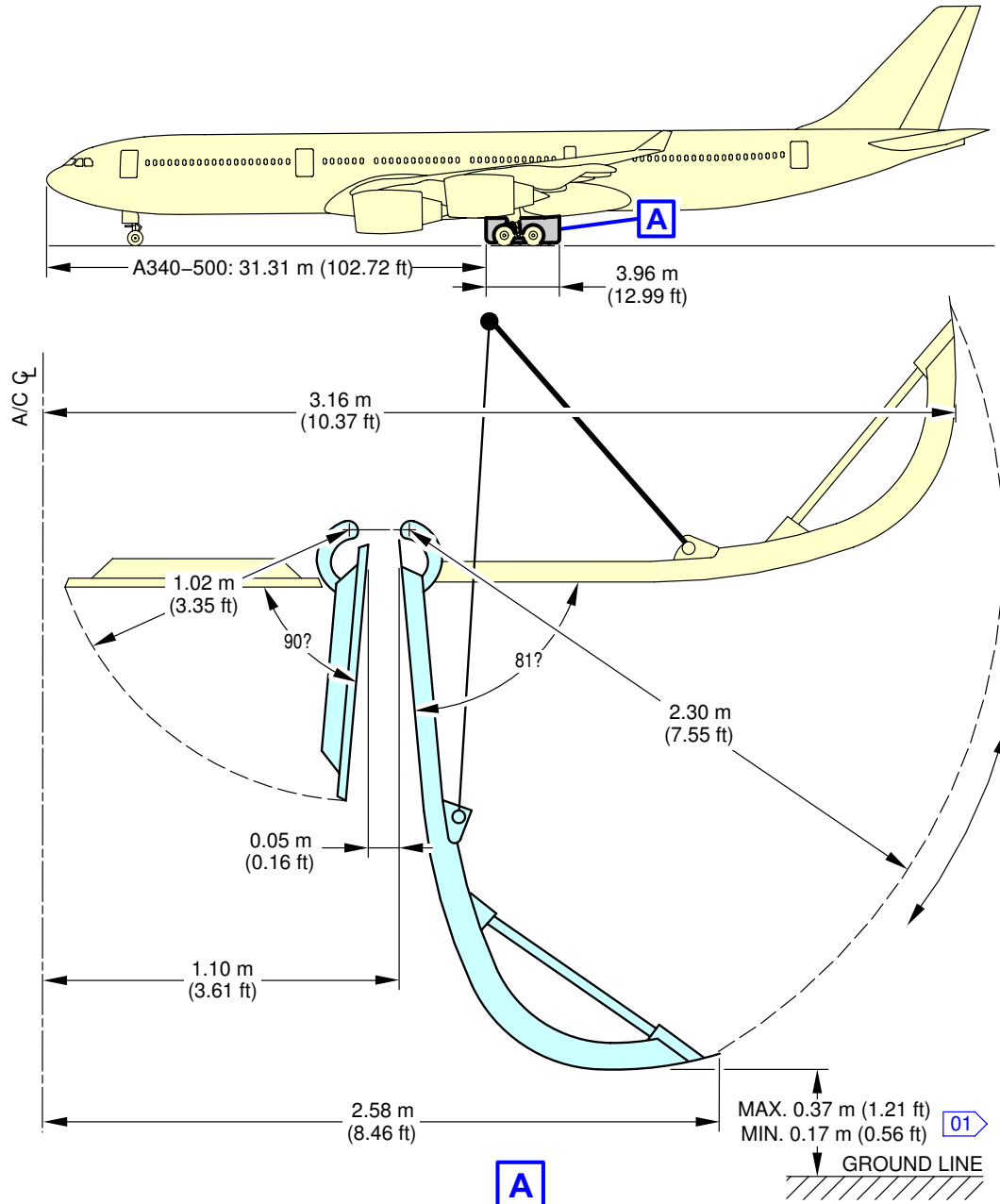

A
LH SHOWN
RH SYMMETRICAL

NOTE:
01 DEPENDING ON CG POSITION AND AIRCRAFT WEIGHT.

F_AC_020700_1_0510101_01_00

Door Clearances
Main and Center Landing Gear Doors
FIGURE-2-7-0-991-051-A01

A340-500/-600

AIRCRAFT CHARACTERISTICS - AIRPORT AND MAINTENANCE PLANNING

**ON A/C A340-600

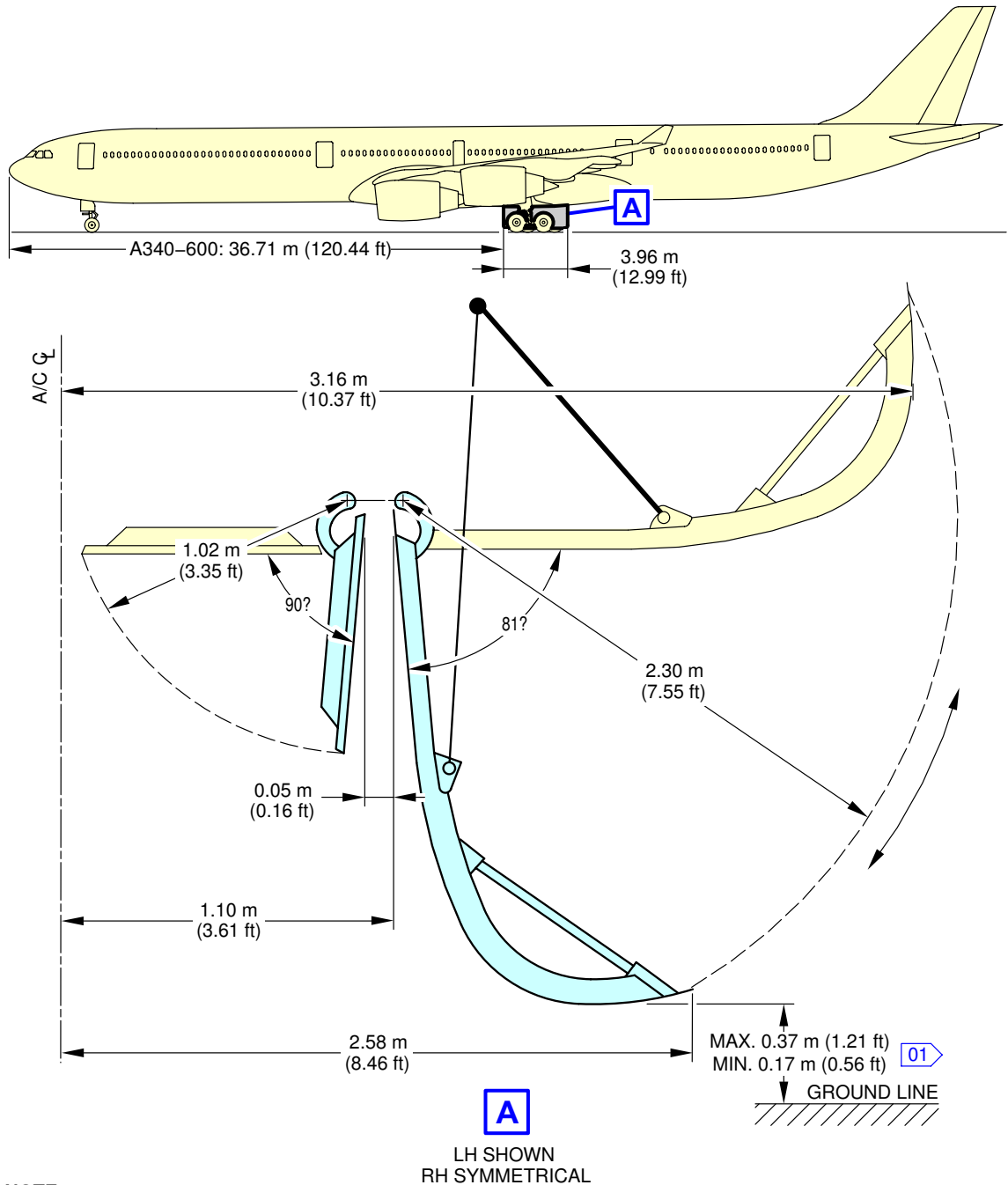

NOTE:

[01] DEPENDING ON CG POSITION AND AIRCRAFT WEIGHT.

F_AC_020700_1_0520101_01_00

Door Clearances
Main and Center Landing Gear Doors
FIGURE-2-7-0-991-052-A01

A340-500/-600

AIRCRAFT CHARACTERISTICS - AIRPORT AND MAINTENANCE PLANNING

**ON A/C A340-500

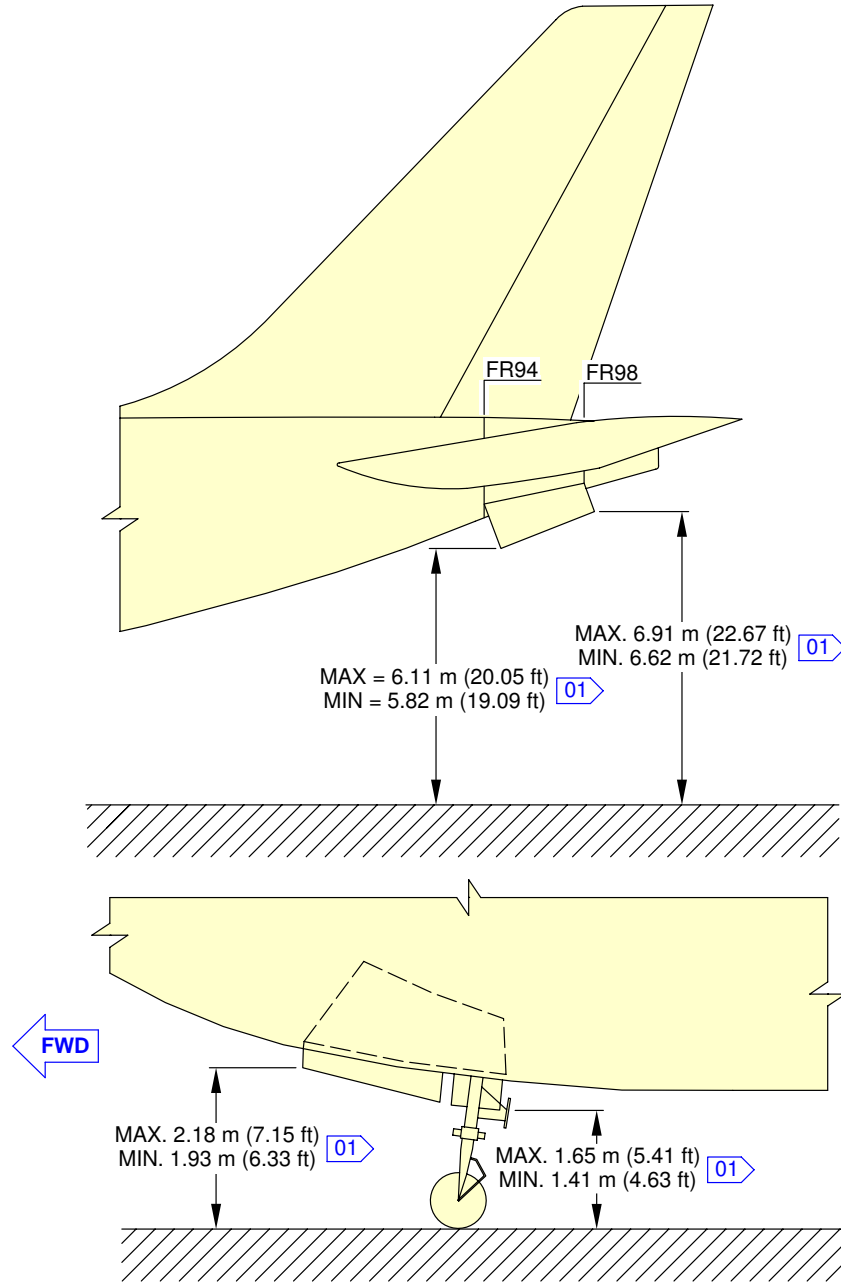

NOTE:
[01] DEPENDING ON CG POSITION AND AIRCRAFT WEIGHT.

F_AC_020700_1_0530101_01_00

Door Clearances
APU and Nose Landing Gear Doors
FIGURE-2-7-0-991-053-A01

A340-500/-600

AIRCRAFT CHARACTERISTICS - AIRPORT AND MAINTENANCE PLANNING

**ON A/C A340-600

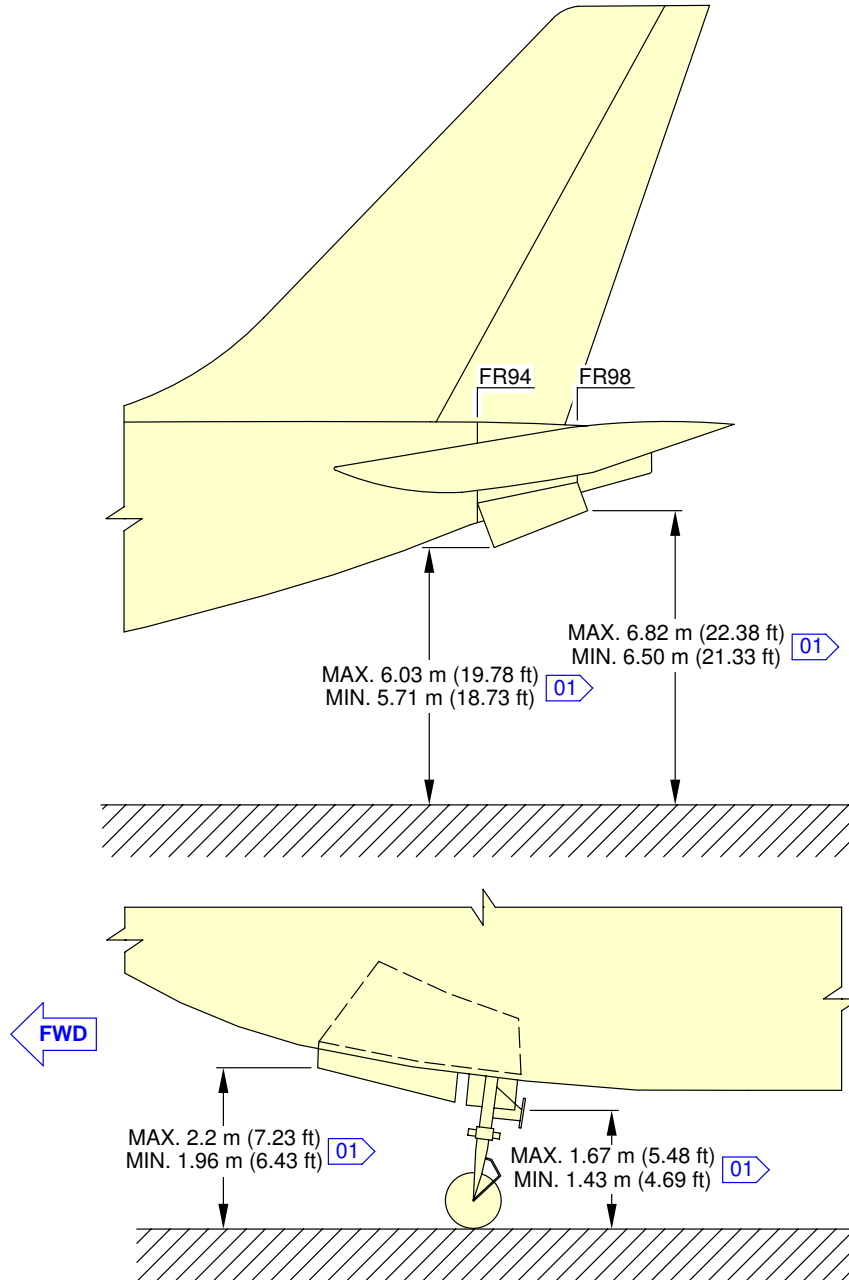

NOTE:
[01] DEPENDING ON CG POSITION AND AIRCRAFT WEIGHT.

F_AC_020700_1_0540101_01_00

Door Clearances
APU and Nose Landing Gear Doors
FIGURE-2-7-0-991-054-A01

2-8-0 Escape Slides

****ON A/C A340-500 A340-600**

Escape Slides

1. General

This section provides the location of the cabin escape facilities and their related clearances.

****ON A/C A340-500**

2. Location

Escape facilities are provided at the following locations:

A. Door Escape Facility

- One dual lane escape slide-raft at each passenger/crew door (total six)
- One single lane escape slide at each emergency exit door (total two).

The slides are installed in a container in the lower part of the door.

****ON A/C A340-600**

3. Location

Escape facilities are provided at the following locations:

A. Door Escape Facility

- One dual lane escape slide-raft at each passenger/crew door (total six)
- One dual lane escape slide-raft at each emergency exit door (total two).

The slides are installed in a container in the lower part of the door.

B. Off-Wing Escape Facility

- One single lane escape slide at each overwing emergency-exit door (total two).

The escape slide is installed in the left and right belly fairing above, and AFT of the wing trailing edge, between FR53.2 and FR53.4.

A340-500/-600

AIRCRAFT CHARACTERISTICS - AIRPORT AND MAINTENANCE PLANNING

****ON A/C A340-500**

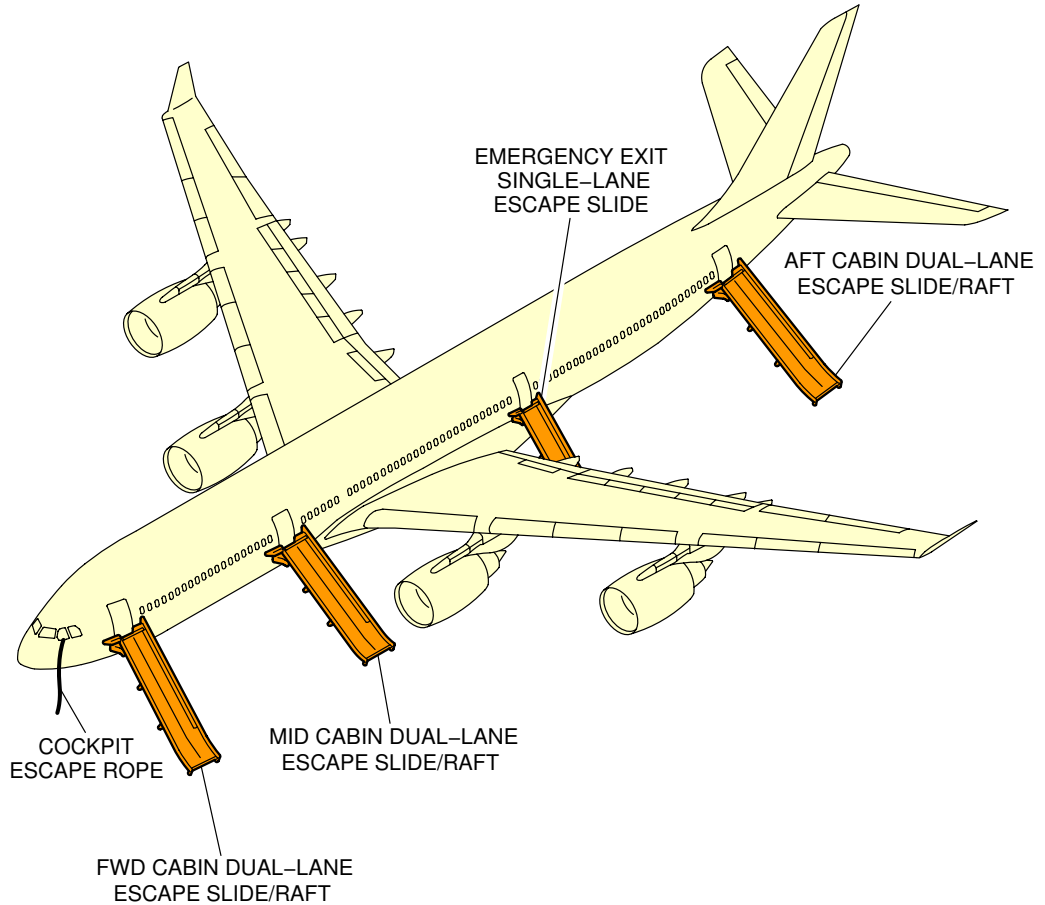

NOTE:
LH SHOWN, RH SYMMETRICAL.

F_AC_020800_1_0050101_01_01

Escape Slides
Location (Sheet 1 of 2)
FIGURE-2-8-0-991-005-A01

A340-500/-600

AIRCRAFT CHARACTERISTICS - AIRPORT AND MAINTENANCE PLANNING

**ON A/C A340-500

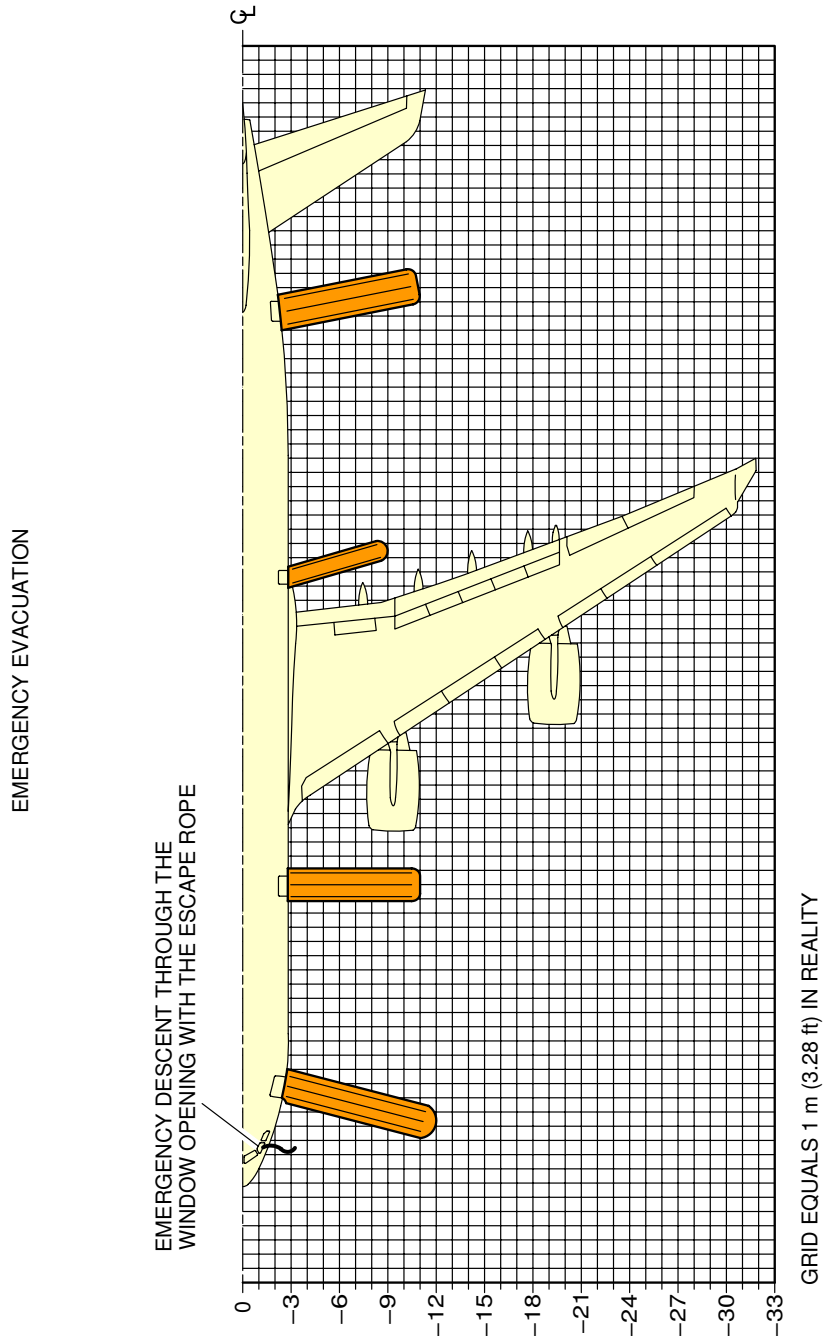

F_AC_020800_1_0050102_01_01

Escape Slides
 Dimensions (Sheet 2 of 2)
 FIGURE-2-8-0-991-005-A01

A340-500/-600

AIRCRAFT CHARACTERISTICS - AIRPORT AND MAINTENANCE PLANNING

****ON A/C A340-600**

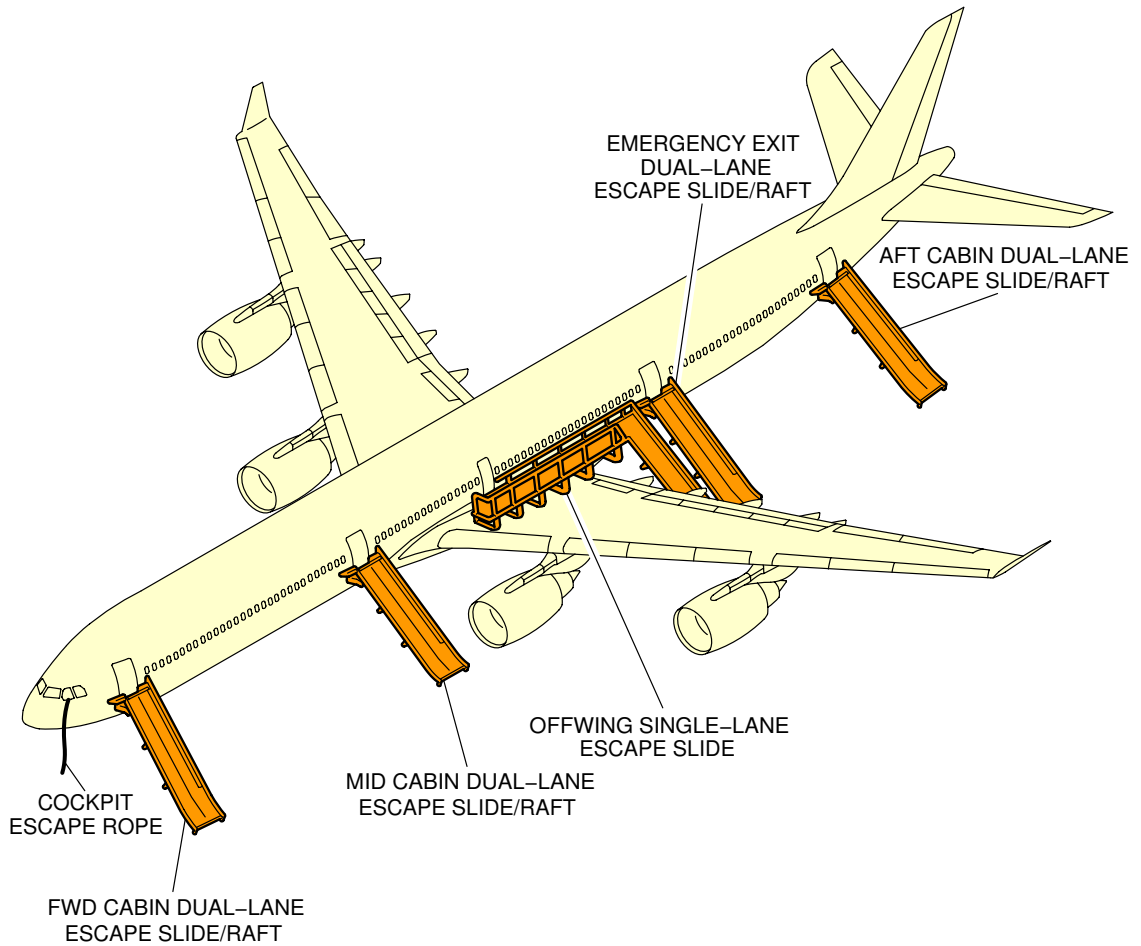

NOTE:
LH SHOWN, RH SYMMETRICAL.

F_AC_020800_1_0050201_01_01

Escape Slides
Location (Sheet 1 of 2)
FIGURE-2-8-0-991-005-B01

A340-500/-600

AIRCRAFT CHARACTERISTICS - AIRPORT AND MAINTENANCE PLANNING

**ON A/C A340-600

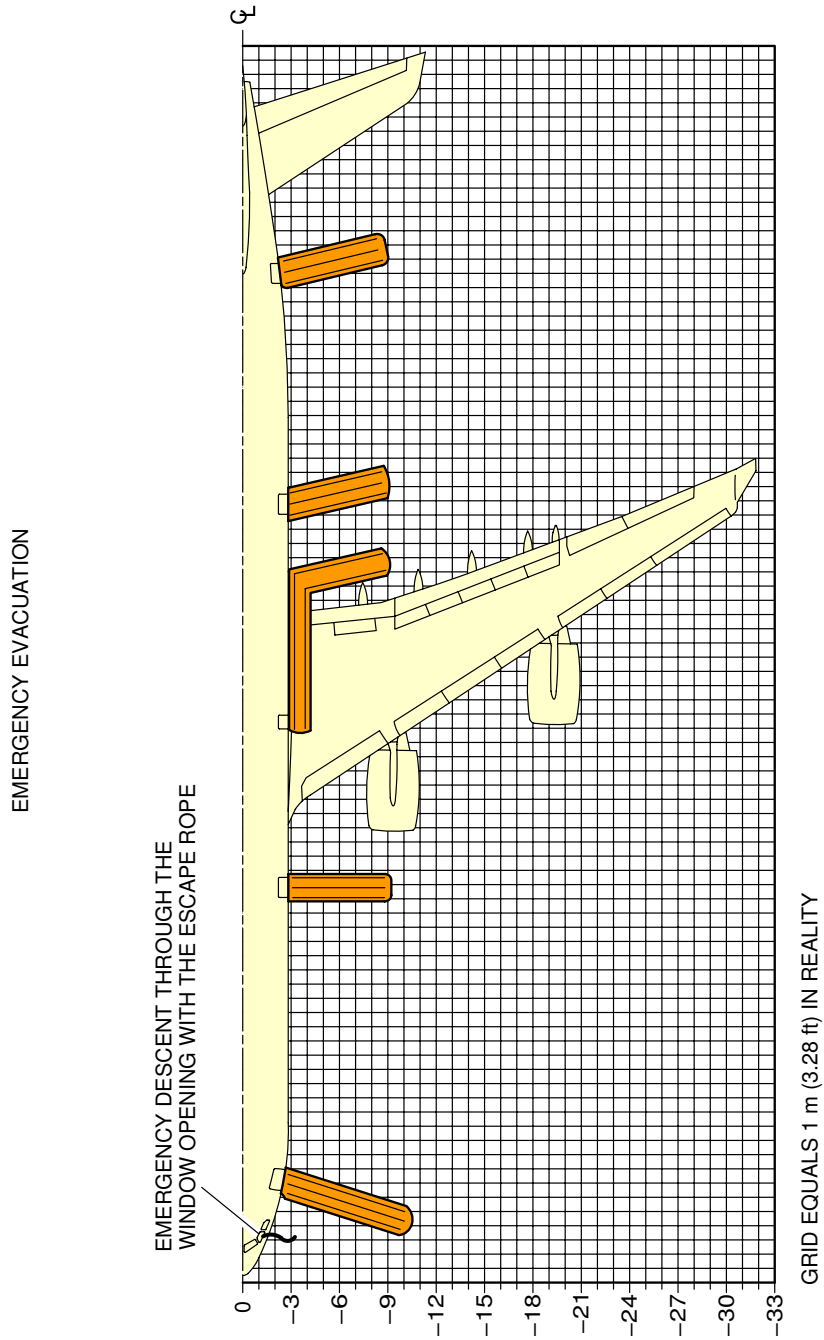

NOTE:
 - LH SHOWN, RH SYMMETRICAL.
 - DIMENSIONS ARE APPROXIMATE.

F_AC_020800_1_0050202_01_01

Escape Slides
 Dimensions (Sheet 2 of 2)
 FIGURE-2-8-0-991-005-B01

2-9-0 Landing Gear

****ON A/C A340-500 A340-600**

Landing Gear Maintenance Pits

1. General

The minimum maintenance pit envelopes for the main landing gear shock absorber removal are shown in Figures 1 and 2.

All dimensions shown are minimum dimensions with zero clearances.

The dimensions for the pits have been determined for these design factors:

- The length and width of the pits allow the gear to rotate as the weight is taken off the landing gear
- The depth of the pits allow the shock absorber to be removed when all the weight is taken off the landing gear.

Dimensions for elevators and associated mechanisms must be added to those in Figures 1 and 2.

A. Elevators

These can be either mechanical or hydraulic. Elevators are used to:

- permit easy movement of persons and equipment around the main landing gears
- to lift and remove landing gear assemblies out of the pits.

B. Jacking

The aircraft must be in position over the pits to put the gear on the elevators. Jacks must be installed and engaged with all the jacking points (Ref. Section 2-14 for Jacking).

Jacks must support the total aircraft weight, i.e. when the landing gears do not touch the elevators on retraction/extension tests.

When tripod support jacks are used, the tripod-base circle radius must be limited because the locations required for positioning the jacks are close to the sides of the pits.

A340-500/-600

AIRCRAFT CHARACTERISTICS - AIRPORT AND MAINTENANCE PLANNING

**ON A/C A340-600

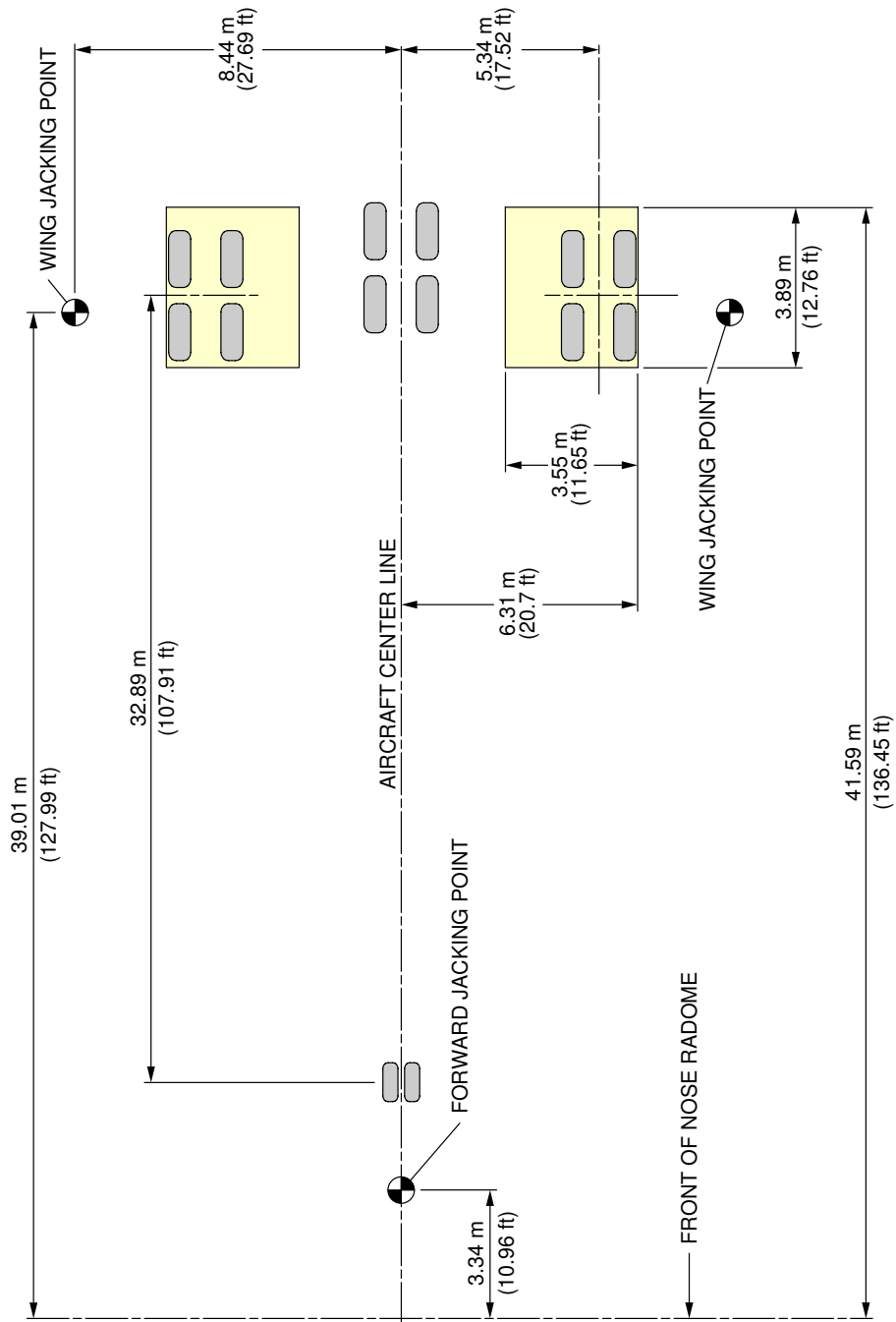

NOTE:
ENVELOPES SHOWN WITH ZERO CLEARANCE TO OUTSIDE EDGE OF TIRES.

F_AC_020900_1_0050101_01_00

Landing Gear Maintenance Pits
Maintenance Pit Envelopes (Sheet 1 of 2)
FIGURE-2-9-0-991-005-A01

A340-500/-600

AIRCRAFT CHARACTERISTICS - AIRPORT AND MAINTENANCE PLANNING

**ON A/C A340-600

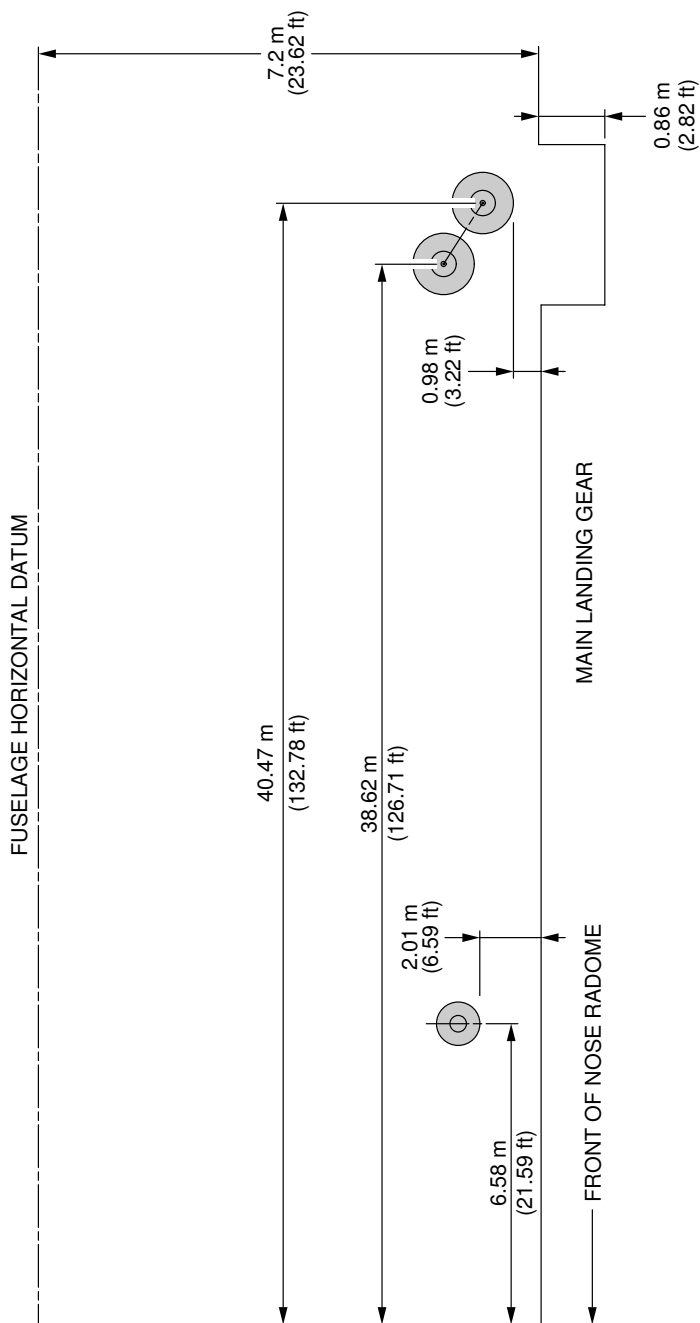

- NOTE:**
1. OUTBOARD EDGE OF PIT DEFINED BY ZERO CLEARANCE TO OUTBOARD GROWN TIRES.
 2. INBOARD EDGE OF PIT DEFINED BY THE POSITION OF THE OPEN BELLY FAIRING DOOR.
 3. DEPTH OF THE PIT IS THE SAME AS A340-300 MEASURED FROM THE FUSELAGE HORIZONTAL DATUM.
 4. NO PIT IS REQUIRED FOR NOSE LANDING GEAR OR CENTER LANDING GEAR.

F_AC_020900_1_0050102_01_00

Landing Gear Maintenance Pits
 Maintenance Pit Envelopes (Sheet 2 of 2)
 FIGURE-2-9-0-991-005-A01

A340-500/-600

AIRCRAFT CHARACTERISTICS - AIRPORT AND MAINTENANCE PLANNING

**ON A/C A340-500

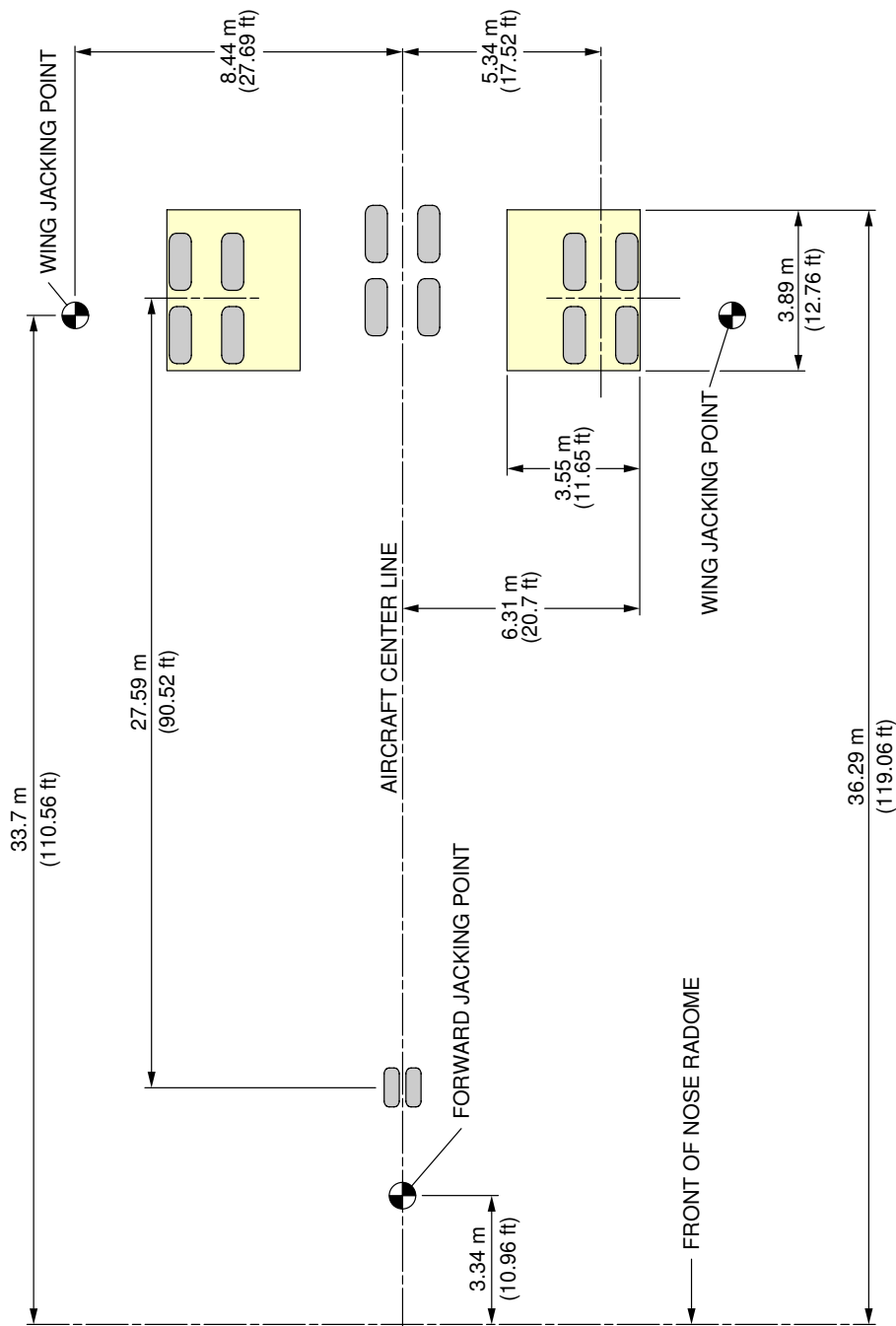

F_AC_020900_1_0050201_01_00

NOTE:
ENVELOPES SHOWN WITH ZERO CLEARANCE TO OUTSIDE EDGE OF TIRES.

Landing Gear Maintenance Pits
Maintenance Pit Envelopes (Sheet 1 of 2)
FIGURE-2-9-0-991-005-B01

A340-500/-600

AIRCRAFT CHARACTERISTICS - AIRPORT AND MAINTENANCE PLANNING

**ON A/C A340-500

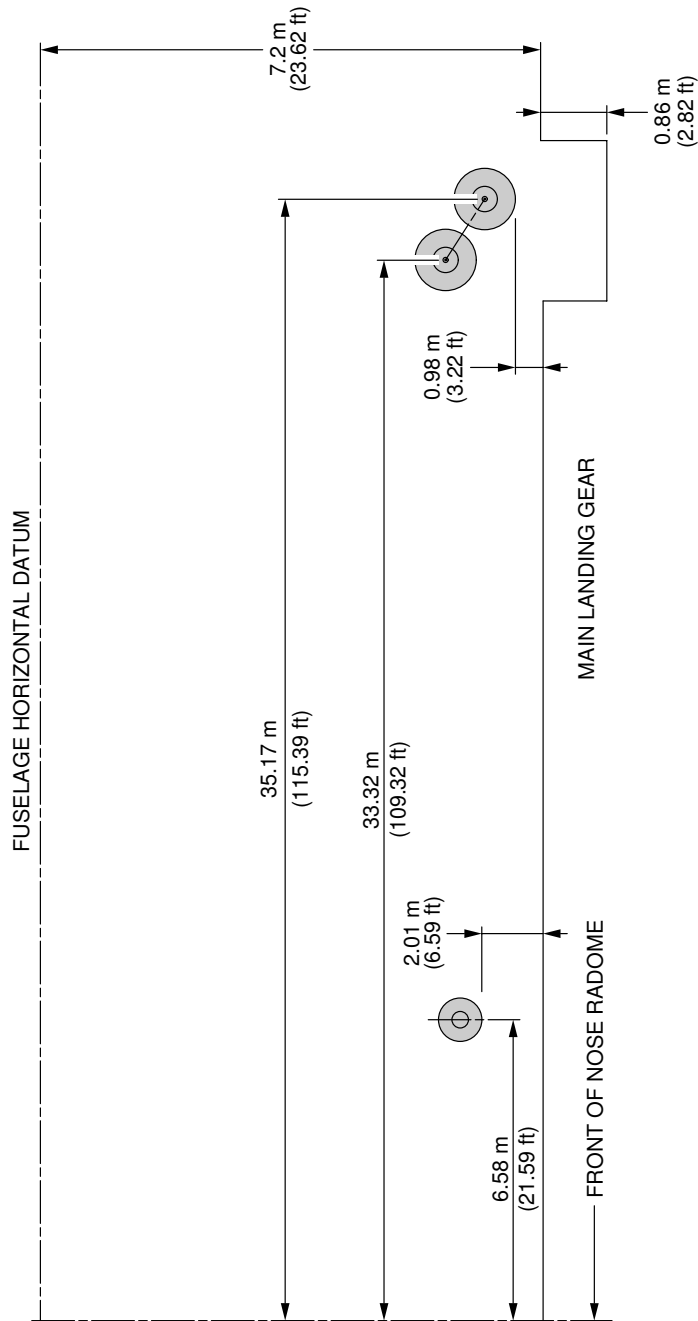

- NOTE:**
1. OUTBOARD EDGE OF PIT DEFINED BY ZERO CLEARANCE TO OUTBOARD GROWN TIRES.
 2. INBOARD EDGE OF PIT DEFINED BY THE POSITION OF THE OPEN BELLY FAIRING DOOR.
 3. DEPTH OF THE PIT IS THE SAME AS A340-300 MEASURED FROM THE FUSELAGE HORIZONTAL DATUM.
 4. NO PIT IS REQUIRED FOR NOSE LANDING GEAR OR CENTER LANDING GEAR.

F_AC_020900_1_0050202_01_00

Landing Gear Maintenance Pits
 Maintenance Pit Envelopes (Sheet 2 of 2)
 FIGURE-2-9-0-991-005-B01

****ON A/C A340-500 A340-600**

Landing Gear

1. General

The aircraft has:

- Two Main Landing Gears (MLG) with four wheel bogie assembly and related doors,
- A Centerline Landing Gear (CLG) with four wheel bogie assembly and related doors,
- A Nose Landing Gear (NLG) with twin wheel assembly and related doors.

The main landing gears are located under each wing and retract sideways towards the fuselage centerline.

The centerline landing gear is located on the belly and retract forward into a bay in the fuselage.

The nose landing gear retracts forward into a fuselage compartment below the cockpit.

The retraction and extension of the landing gears and landing gear doors are operated hydraulically and mechanically. The control, sequence and indication are electrical.

In abnormal operation, the landing gears can be extended by gravity.

For the dimensions of the landing gear footprint and tire size, refer to 07-02-00.

2. Main Landing Gear and Doors

Each MLG has a leg assembly and a four-wheel bogie beam. The MLG leg includes a shortening mechanism, a bogie pitch trimmer and an oleo-pneumatic shock absorber. In-flight, with the MLG extended, the bogie is held in a trailing condition (rear wheels low) by an articulation linkage and a pitch trimmer. The folding sidestay is locked mechanically by a lockstay (which is operated by the downlock actuator) when the MLG is fully extended.

Each MLG bay has the following doors:

- A hydraulically-operated main door,
- A mechanically-operated hinged door,
- A fairing door on the MLG leg.

All the doors close when the MLG retracts. When the MLG is extended the main door closes and the hinged door stays open. A manually operated mechanism (for maintenance personnel) lets the main doors be opened for access to the MLG bay when the aircraft is on the ground.

3. Centerline Landing Gear and Doors

The CLG has a four-wheel bogie beam assembly and a leg assembly that includes an oleo-pneumatic shock absorber. The CLG is supported longitudinally by a two-piece folding dragstay. The dragstay is locked mechanically by the lock links when the CLG is fully extended.

Each CLG bay has the following doors:

- Two hydraulically-operated center doors (each door includes a manually-operated maintenance door attached with hinges to the rear of the center door),
- A fairing door attached to the CLG leg, and an articulated door attached with a hinge to the fairing door.

4. Nose Landing Gear and Doors

The NLG includes a twin-wheel axle assembly and an oleo-pneumatic shock-absorber. The NLG is supported longitudinally by a two-piece dragstay. The dragstay is locked mechanically by the lock links when the NLG is fully extended.

Each NLG bay has the following doors:

- Two hydraulically-operated FWD doors,
- Two mechanically-operated AFT doors,
- A fixed fairing door on the NLG leg.

All the doors close when the NLG retracts. When the NLG is extended the FWD doors close and the AFT doors stay open. A door opening mechanism lets the FWD doors be opened on the ground for access to the NLG bay.

5. Nose Wheel Steering (NWS)

Nose wheel steering system is a computer controlled electro-hydraulic system. The system uses the green main hydraulic power system to operate the hydraulic components.

The steering is controlled by two hand wheel transmitters in the cockpit, which supply the primary steering inputs to the BSCU (Brake and Steering Control Unit).

A steering disconnection box is installed on the NLG to disconnect the steering for towing.

For the operation and control of nose wheel steering, refer to AMM 32-51-00.

For the steering angle limits, refer to AMM 09-10-00.

6. Tow Truck Power

Electric power to the navigation lights can be provided through the tow truck power connector on the 5GC service panel, see FIGURE 2-9-0-991-017-A and for connector definition, see 05-04-04.

7. Landing Gear Servicing Points

A. General

Fluid filling and gas charging of the MLG, CLG and NLG shock absorbers are accomplished through MS28889 standard valves.

B. Charging Pressures

For charging of the landing gear shock absorbers, refer to AMM 12-14-32.

8. Landing Gear Control

The landing gear and door operation is controlled electrically by one of the two Landing Gear Control and Interface Units (LGCIU). Control changes from one LGCIU to the other after each extension cycle.

In normal operation, the landing gears and doors are operated by the green hydraulic system.

In abnormal operation, the landing gears can be extended by the operation of electro-hydraulic free-fall-system. A switch in the cockpit disengage the doors and the landing gear uplocks. The landing gears then extend by free-fall, and lock down.

9. Braking

A. General

Carbon multi-disc brakes are installed on each wheel of the MLG and the CLG. Each brake assembly has two wear indicators installed.

The braking system has four braking modes with autobrake and anti-skid systems:

- Normal braking with anti-skid,
- Alternate braking with anti-skid,
- Alternate braking without anti-skid,
- Parking brake with full brake pressure.

B. In-Flight Wheel Braking

Braking occurs automatically during the retraction of the landing gears. This stops the rotation of the MLG and CLG wheels before the landing gears go into their related bays.

The wheels of the NLG are braked by spring loaded pads.

10. Tire Pressure Indicating System (TPIS)

The TPIS automatically monitors the tire pressures and shows these values on Test Equipment (BITE) and also supplies other data and warnings on the WHEEL page of the System Display (SD).

11. Built In Test Equipment (BITE)

The BITE has hardware and software for these functions:

- to automatically do a self test at power-up,
- to continuously monitor the related systems for failures,
- to continuously monitor the interface with other specified systems in the aircraft,
- to keep a record of each failure and defect and send this data to other systems in the aircraft,
- to automatically do a functional test of some related systems before a landing,
- to do specified system tests during ground maintenance.

The BITE for the following systems is described in these chapters:

- The Brakes and Steering AMM 32-46-00,
- The TPIS AMM 32-49-00,
- The Landing Gear AMM 32-69-00.

A340-500/-600

AIRCRAFT CHARACTERISTICS - AIRPORT AND MAINTENANCE PLANNING

**ON A/C A340-500 A340-600

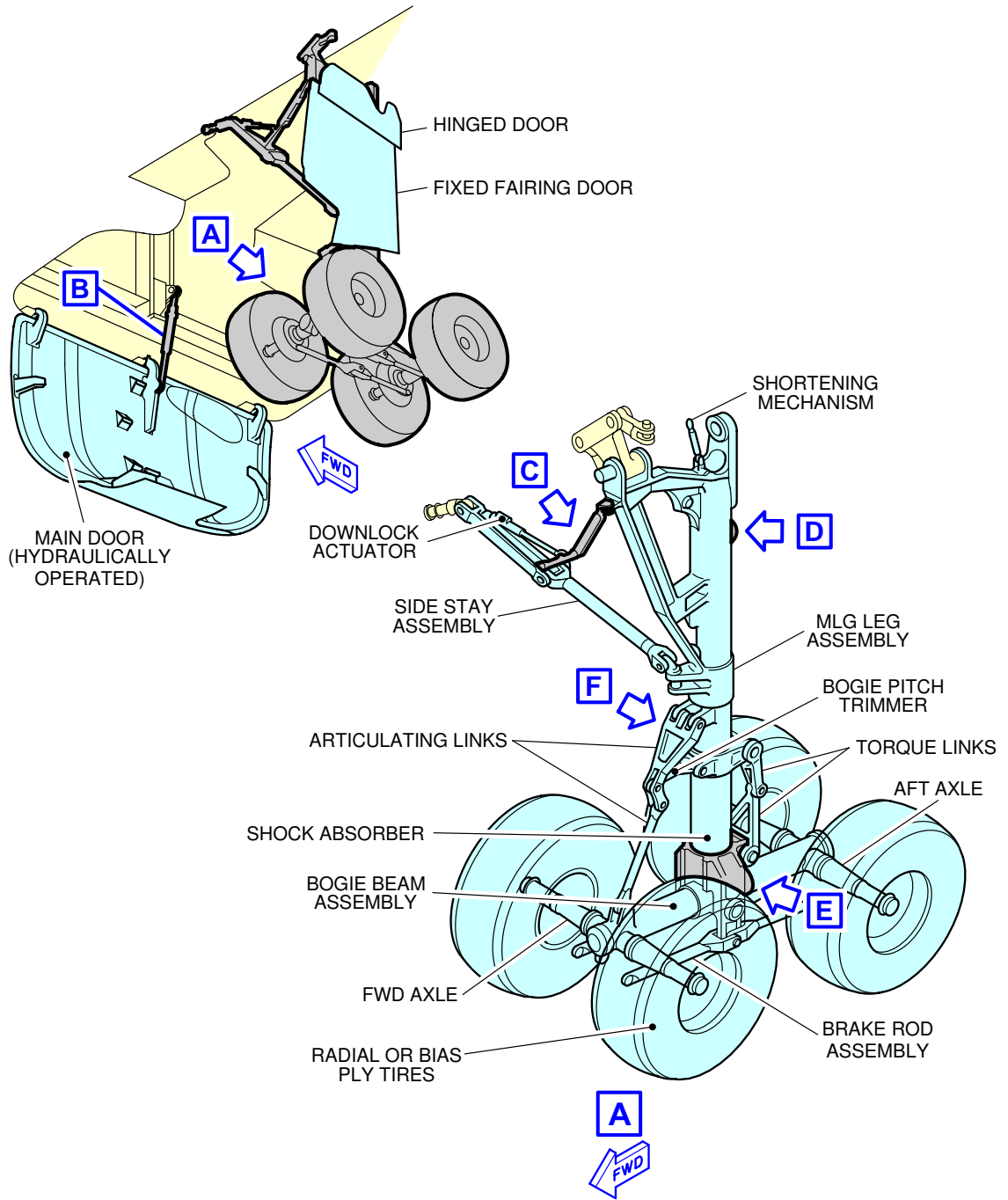

F_AC_020900_1_0120101_01_00

Main Landing Gear
General (Sheet 1 of 3)
FIGURE-2-9-0-991-012-A01

A340-500/-600

AIRCRAFT CHARACTERISTICS - AIRPORT AND MAINTENANCE PLANNING

**ON A/C A340-500 A340-600

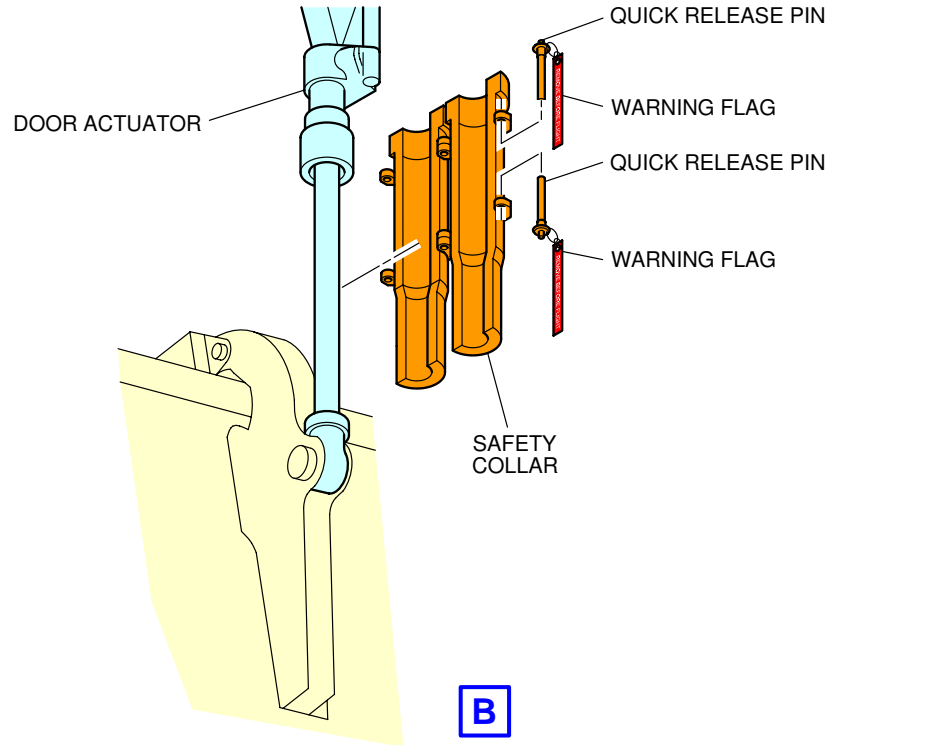

B

LH SHOWN
RH SYMMETRICAL

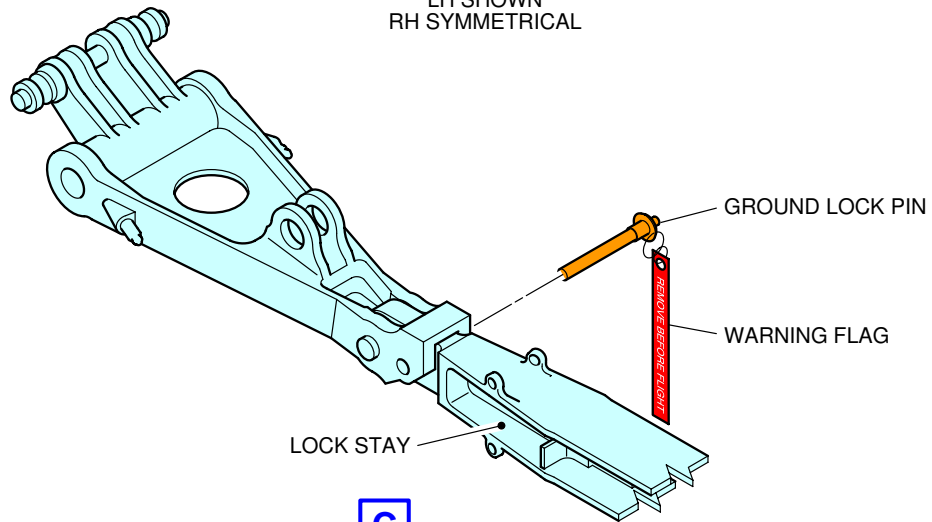

C



F_AC_020900_1_0120102_01_00

Main Landing Gear
Safety Devices (Sheet 2 of 3)
FIGURE-2-9-0-991-012-A01

A340-500/-600

AIRCRAFT CHARACTERISTICS - AIRPORT AND MAINTENANCE PLANNING

**ON A/C A340-500 A340-600

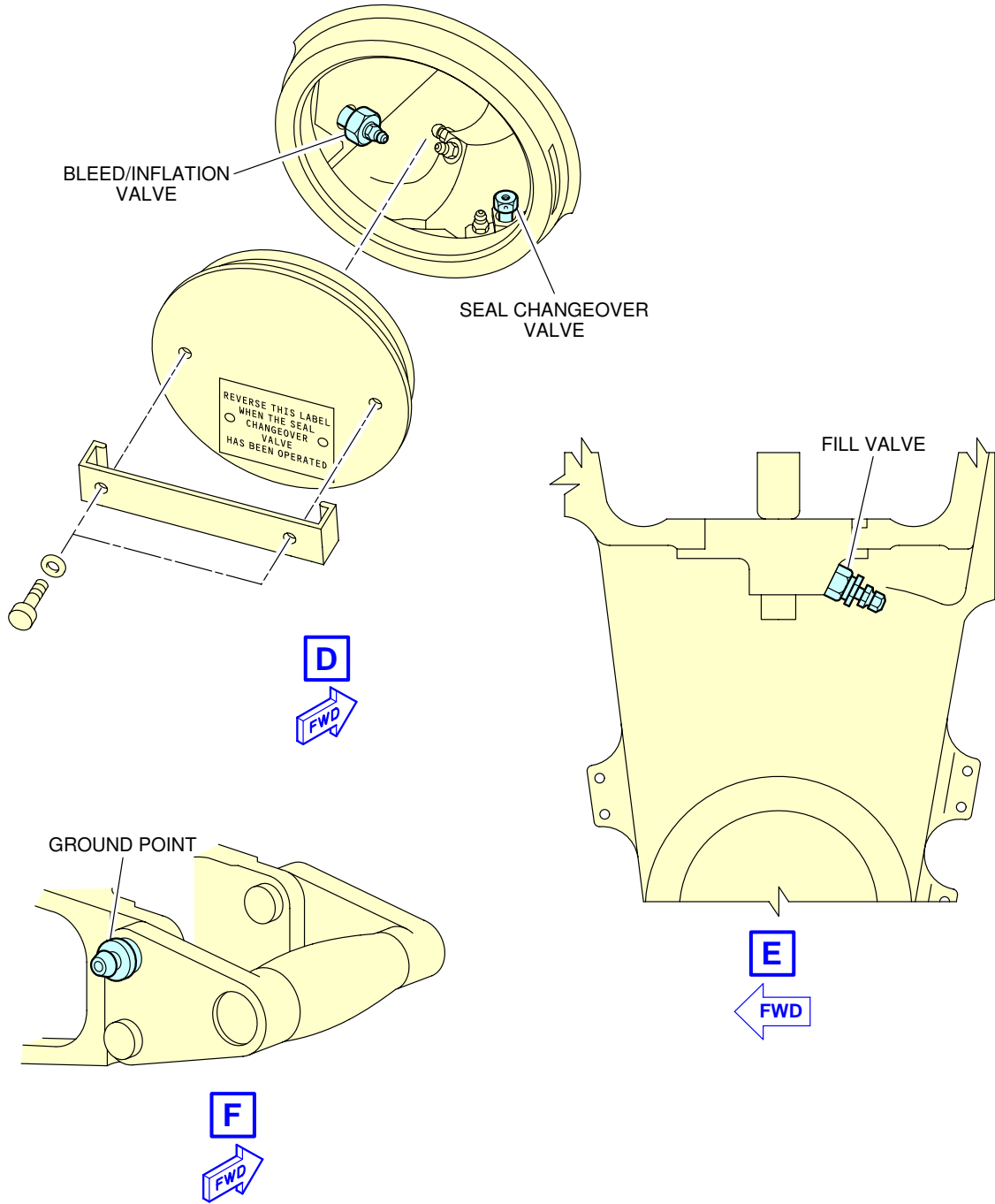

F_AC_020900_1_0120103_01_00

Main Landing Gear
Servicing (Sheet 3 of 3)
FIGURE-2-9-0-991-012-A01

A340-500/-600

AIRCRAFT CHARACTERISTICS - AIRPORT AND MAINTENANCE PLANNING

**ON A/C A340-500 A340-600

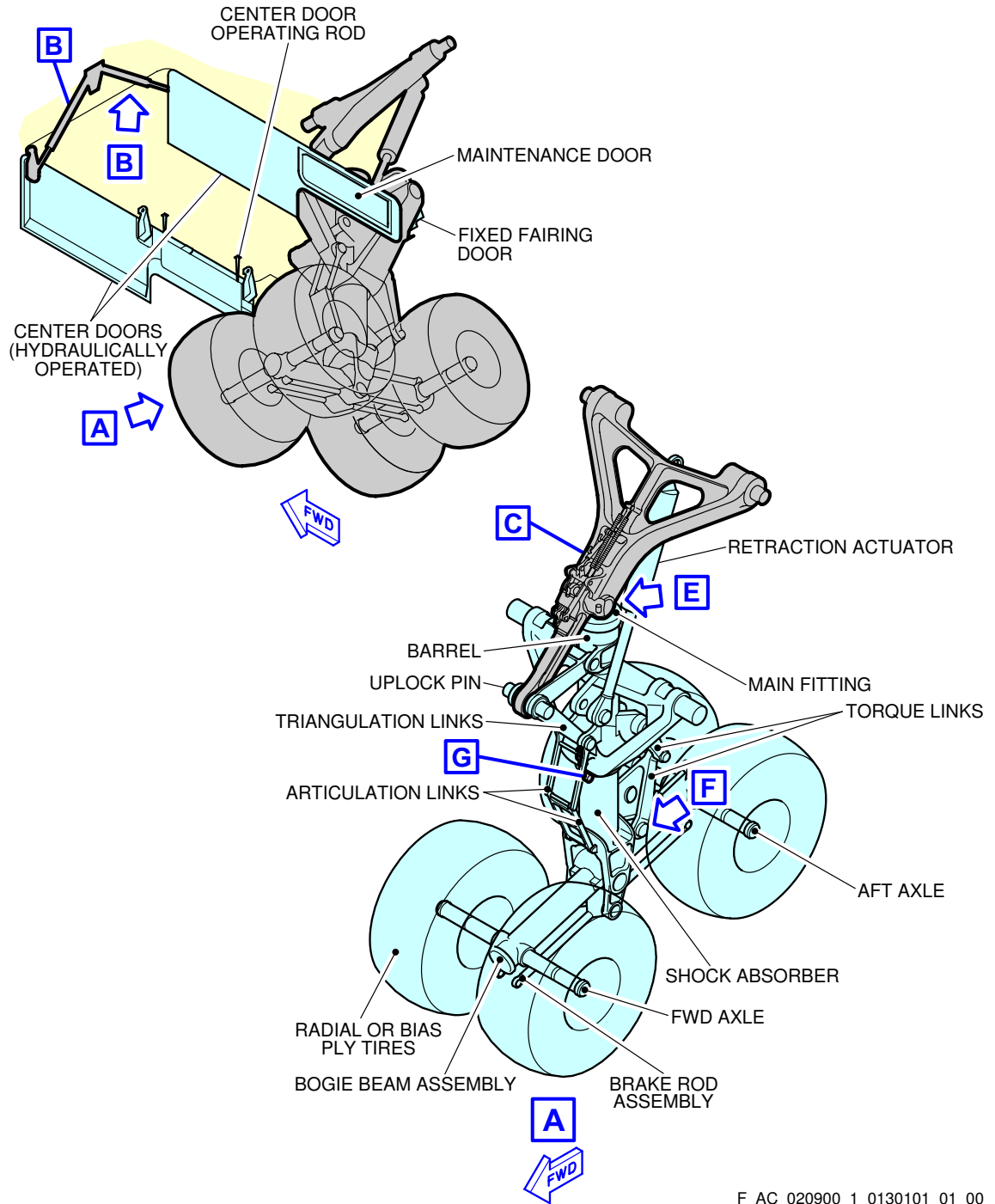

Centerline Landing Gear
General (Sheet 1 of 3)
FIGURE-2-9-0-991-013-A01

A340-500/-600

AIRCRAFT CHARACTERISTICS - AIRPORT AND MAINTENANCE PLANNING

**ON A/C A340-500 A340-600

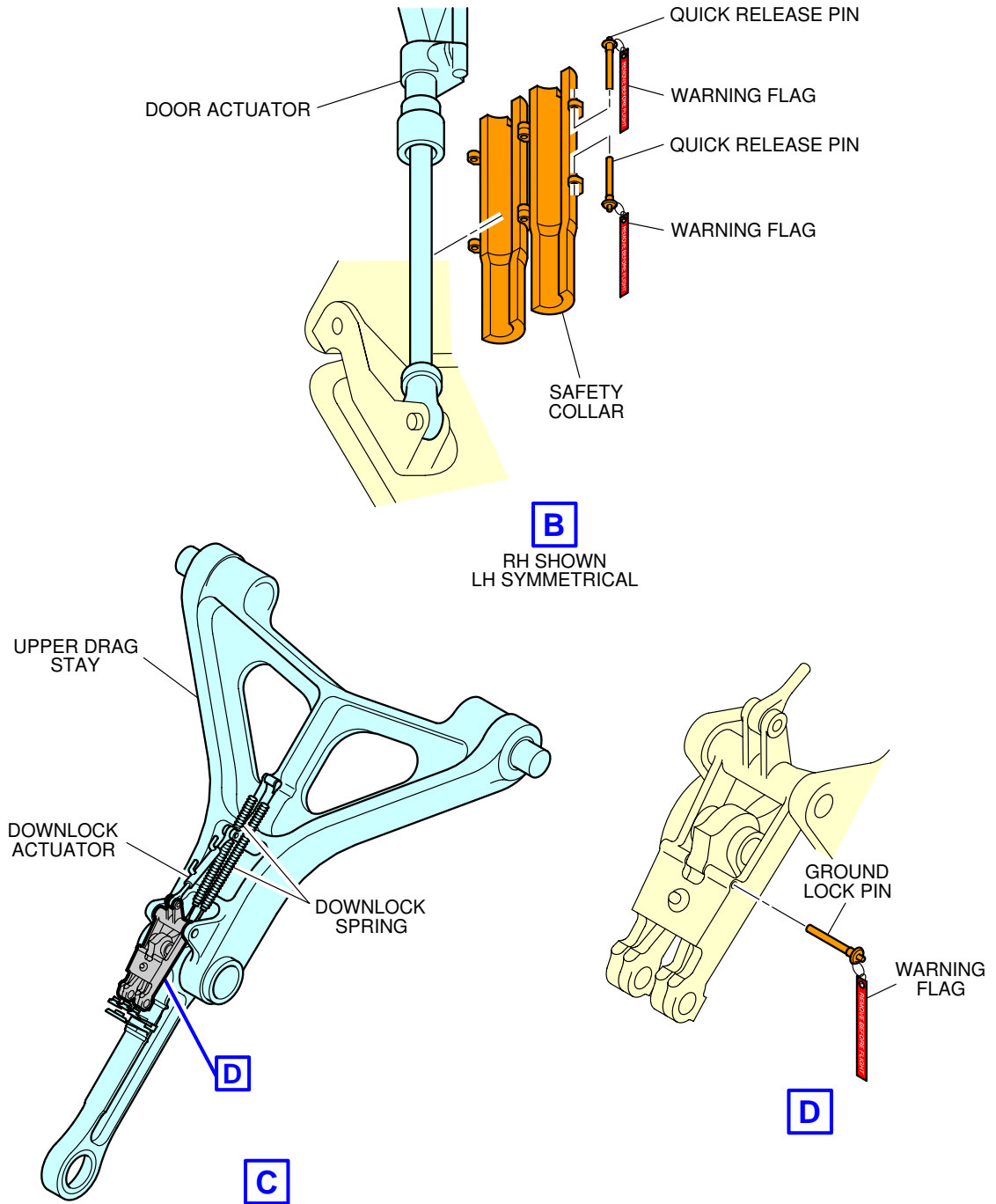

F_AC_020900_1_0130102_01_00

Centerline Landing Gear
Safety Devices (Sheet 2 of 3)
FIGURE-2-9-0-991-013-A01

A340-500/-600

AIRCRAFT CHARACTERISTICS - AIRPORT AND MAINTENANCE PLANNING

**ON A/C A340-500 A340-600

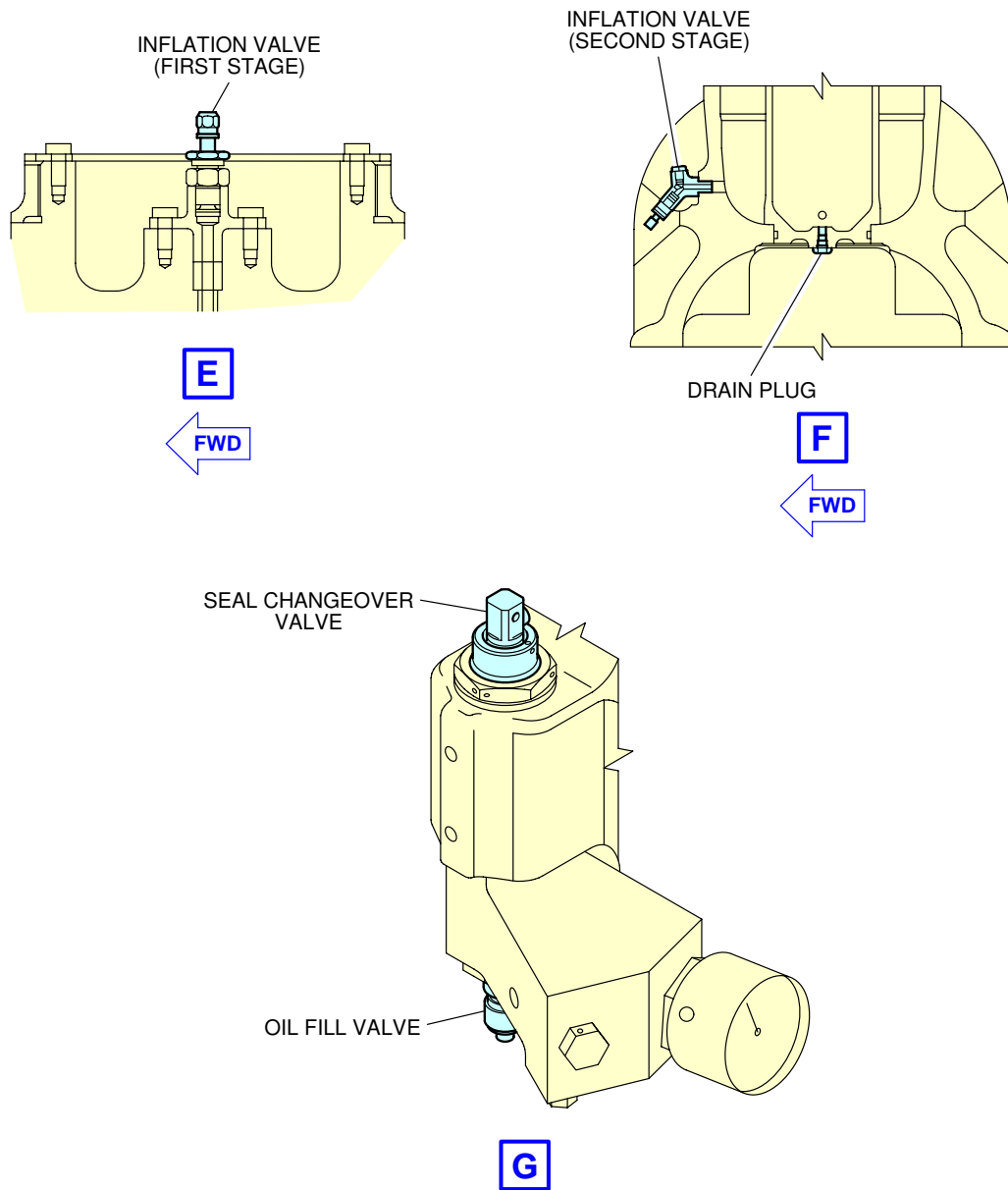

F_AC_020900_1_0130103_01_00

Centerline Landing Gear
Servicing (Sheet 3 of 3)
FIGURE-2-9-0-991-013-A01

A340-500/-600

AIRCRAFT CHARACTERISTICS - AIRPORT AND MAINTENANCE PLANNING

**ON A/C A340-500 A340-600

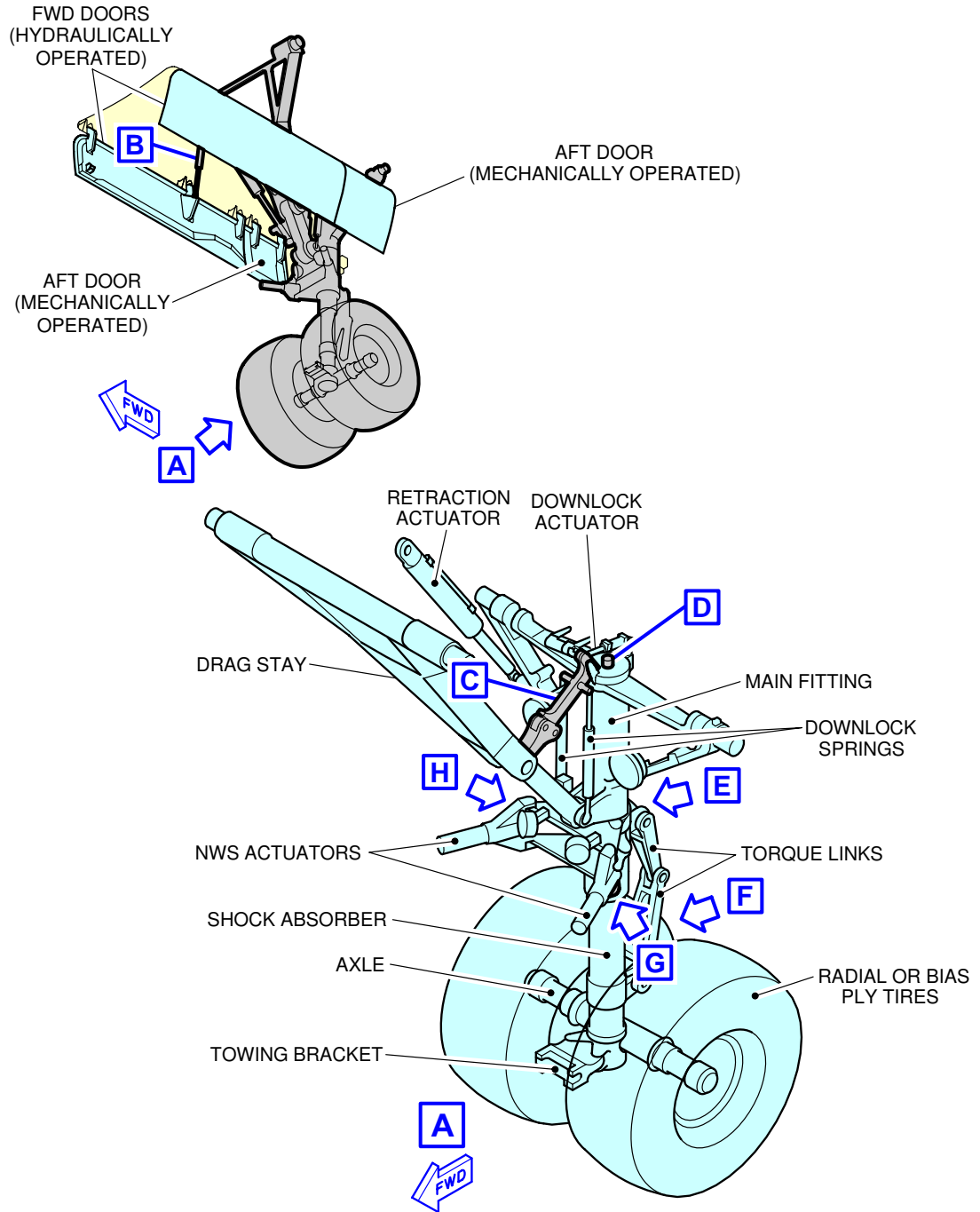

F_AC_020900_1_0140101_01_00

Nose Landing Gear
General (Sheet 1 of 4)
FIGURE-2-9-0-991-014-A01

A340-500/-600

AIRCRAFT CHARACTERISTICS - AIRPORT AND MAINTENANCE PLANNING

**ON A/C A340-500 A340-600

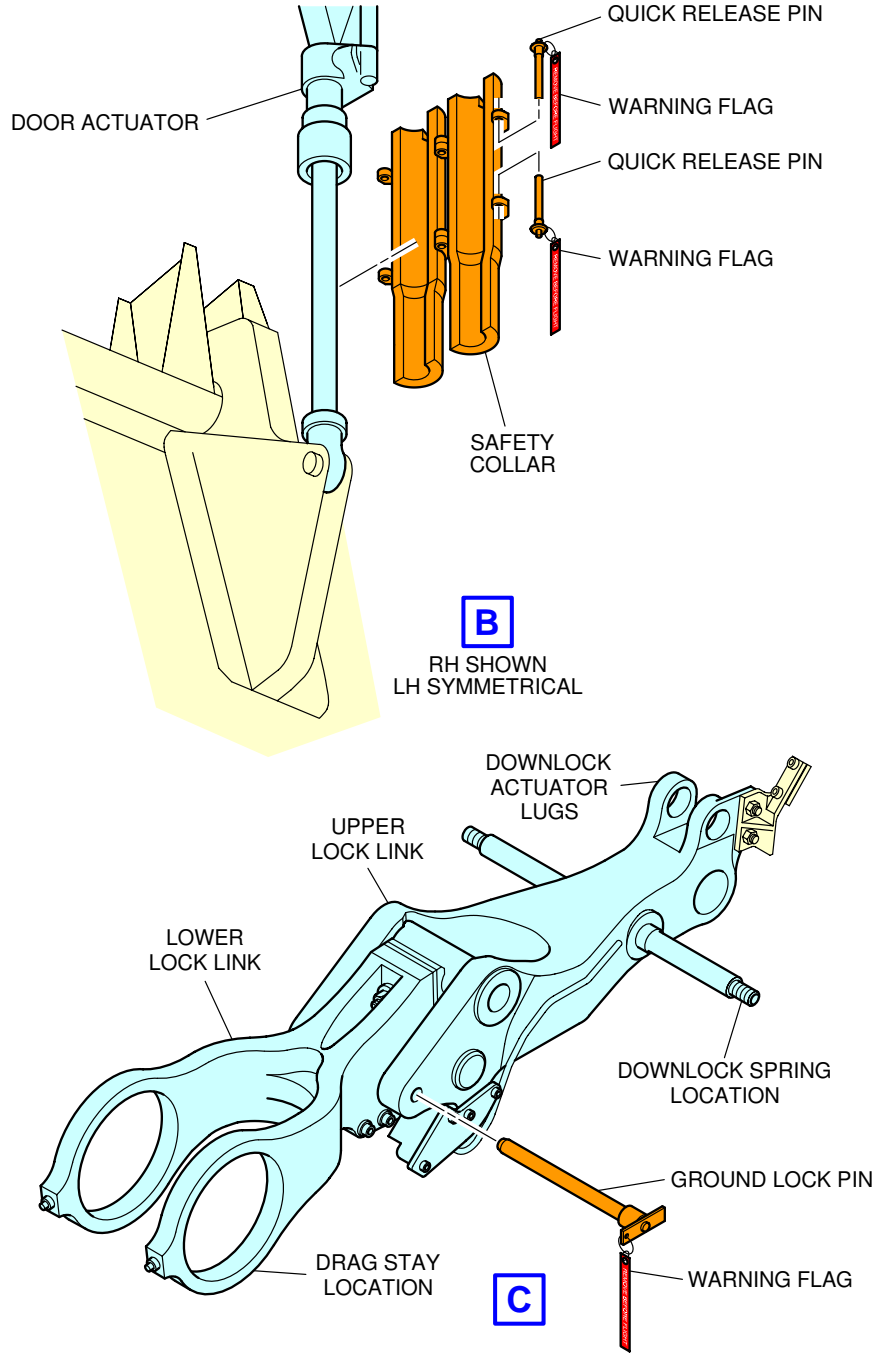

F_AC_020900_1_0140102_01_00

Nose Landing Gear
Safety Devices (Sheet 2 of 4)
FIGURE-2-9-0-991-014-A01

A340-500/-600

AIRCRAFT CHARACTERISTICS - AIRPORT AND MAINTENANCE PLANNING

**ON A/C A340-500 A340-600

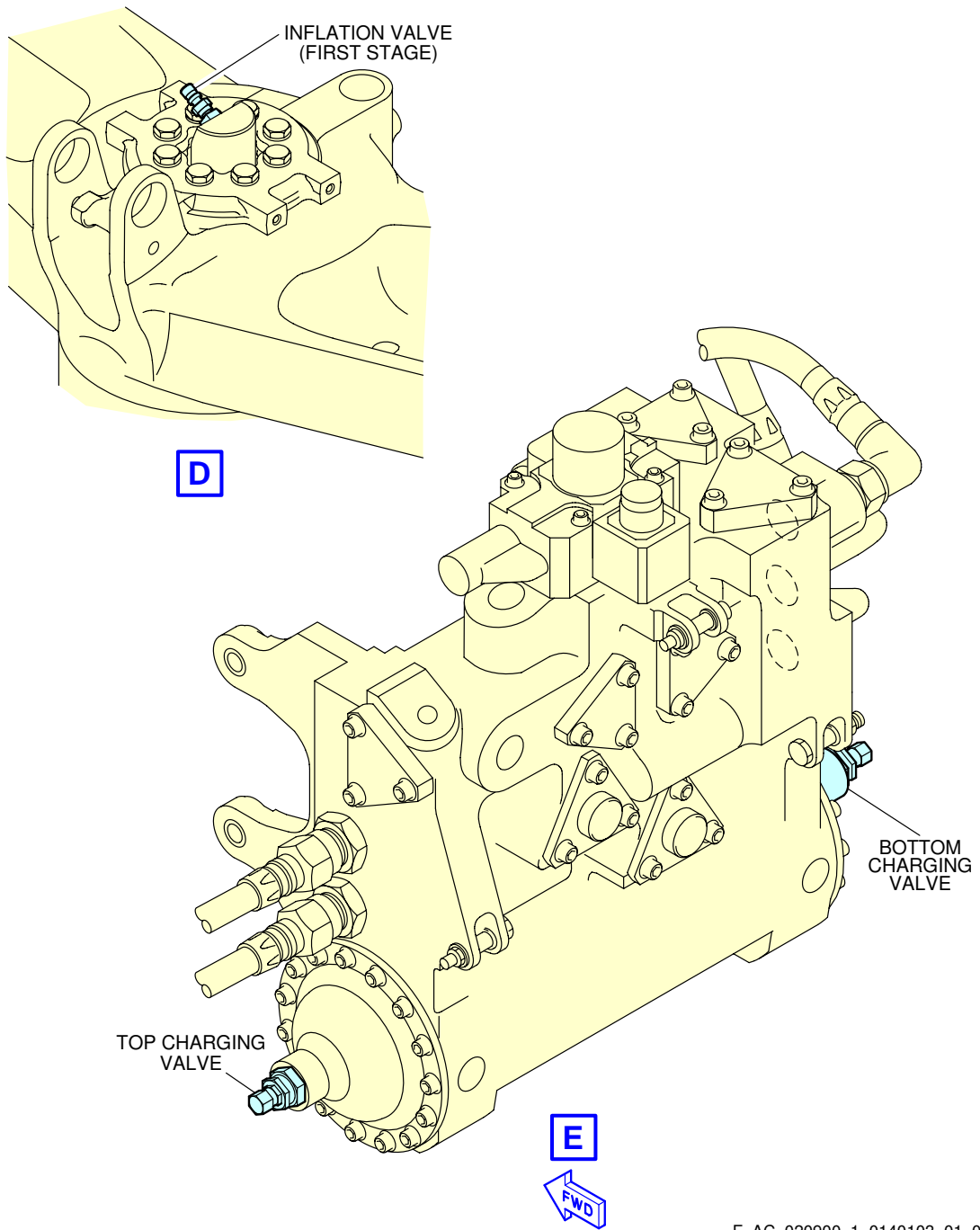

F_AC_020900_1_0140103_01_00

Nose Landing Gear
Servicing (Sheet 3 of 4)
FIGURE-2-9-0-991-014-A01

A340-500/-600

AIRCRAFT CHARACTERISTICS - AIRPORT AND MAINTENANCE PLANNING

**ON A/C A340-500 A340-600

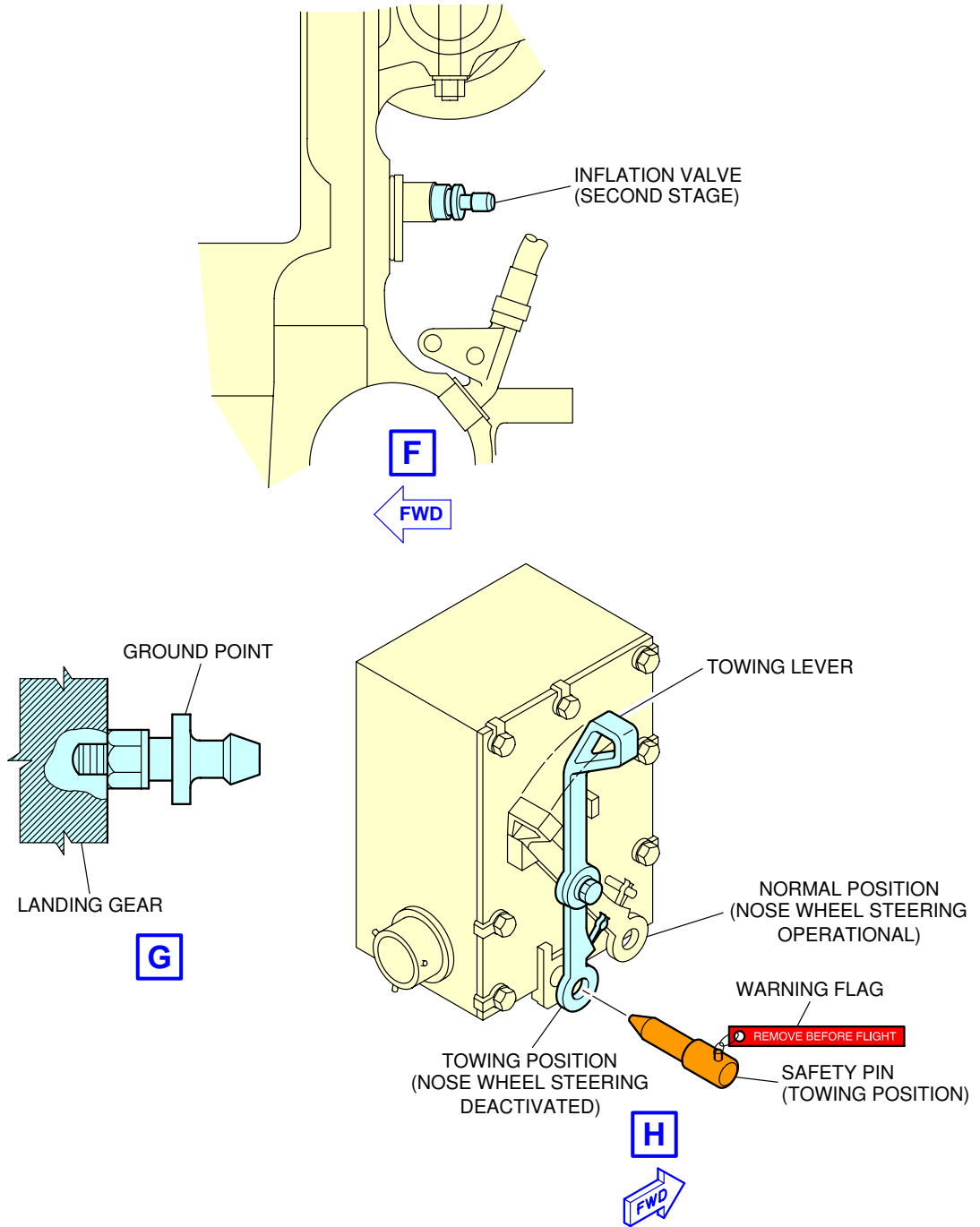

F_AC_020900_1_0140104_01_00

Nose Landing Gear
Servicing and Steering Disconnection Box (Sheet 4 of 4)
FIGURE-2-9-0-991-014-A01

A340-500/-600

AIRCRAFT CHARACTERISTICS - AIRPORT AND MAINTENANCE PLANNING

**ON A/C A340-500 A340-600

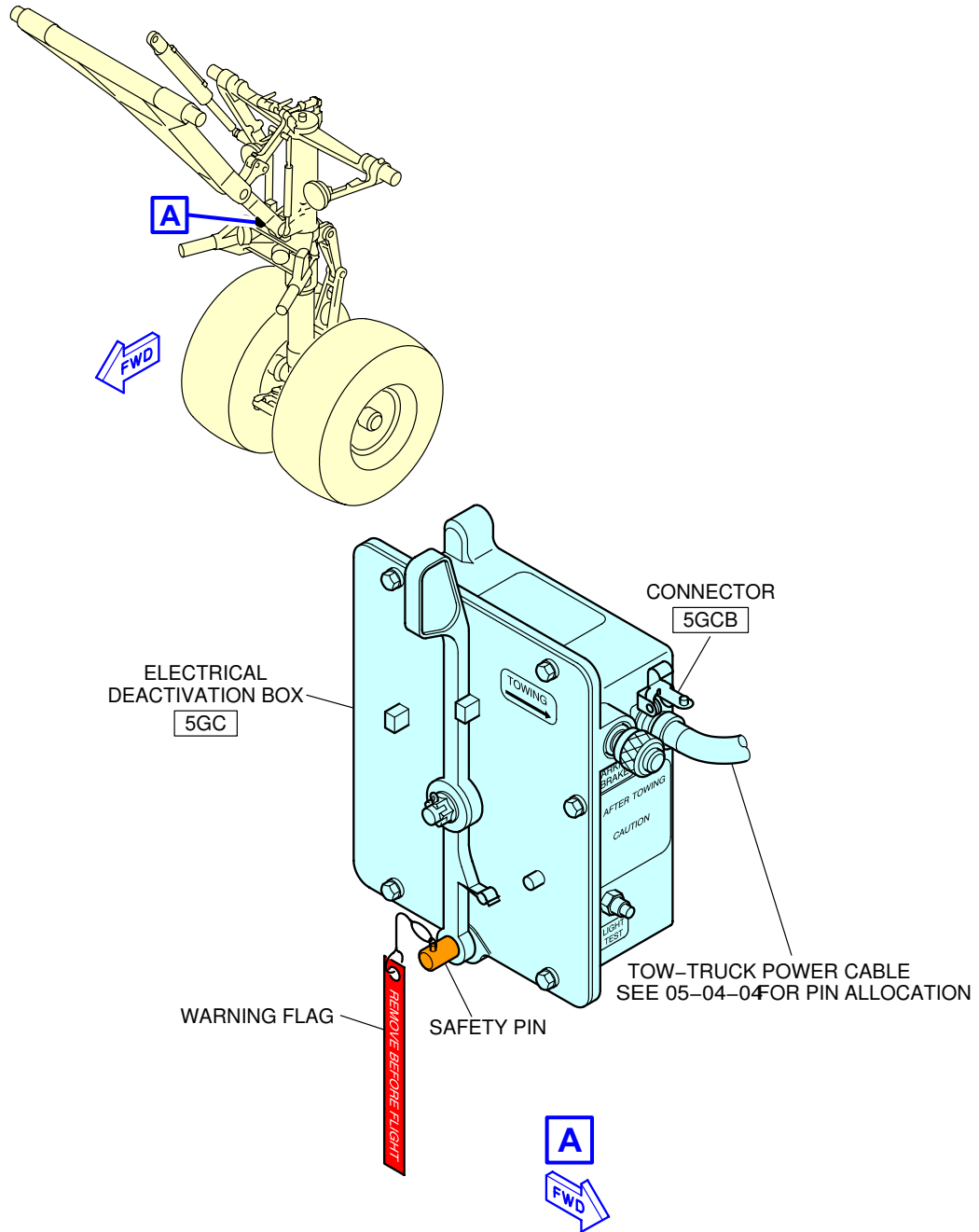

F_AC_020900_1_0170101_01_01

Tow Truck Power
FIGURE-2-9-0-991-017-A01

2-10-0 Exterior Lighting

****ON A/C A340-500 A340-600**

Exterior Lighting

1. General

This section provides the location of the aircraft exterior lighting.

EXTERIOR LIGHTING	
ITEM	DESCRIPTION
1	RIGHT NAVIGATION LIGHT (GREEN)
2	LEFT NAVIGATION LIGHT (RED)
3	TAIL NAVIGATION LIGHT (WHITE)
4	UPPER ANTI-COLLISION LIGHT/BEACON (RED)
5	LOWER ANTI-COLLISION LIGHT/BEACON (RED)
6	LOGO LIGHTS
7	ENGINE SCAN LIGHTS
8	WING SCAN LIGHTS
9	WING STROBE LIGHT (HIGH INTENSITY, WHITE)
10	TAIL STROBE LIGHT (HIGH INTENSITY, WHITE)
11	LANDING LIGHTS
12	RUNWAY TURN-OFF LIGHTS
13	TAXI LIGHTS
14	TAKE-OFF LIGHTS
15	CARGO COMPARTMENT FLOOD LIGHTS
16	LANDING GEAR BAY/WELL LIGHTS (DOME)
17 (A340-600 only)	FWD TAXI CAMERA LIGHTS
18 (A340-600 only)	AFT TAXI CAMERA LIGHTS

A340-500/-600

AIRCRAFT CHARACTERISTICS - AIRPORT AND MAINTENANCE PLANNING

****ON A/C A340-500**

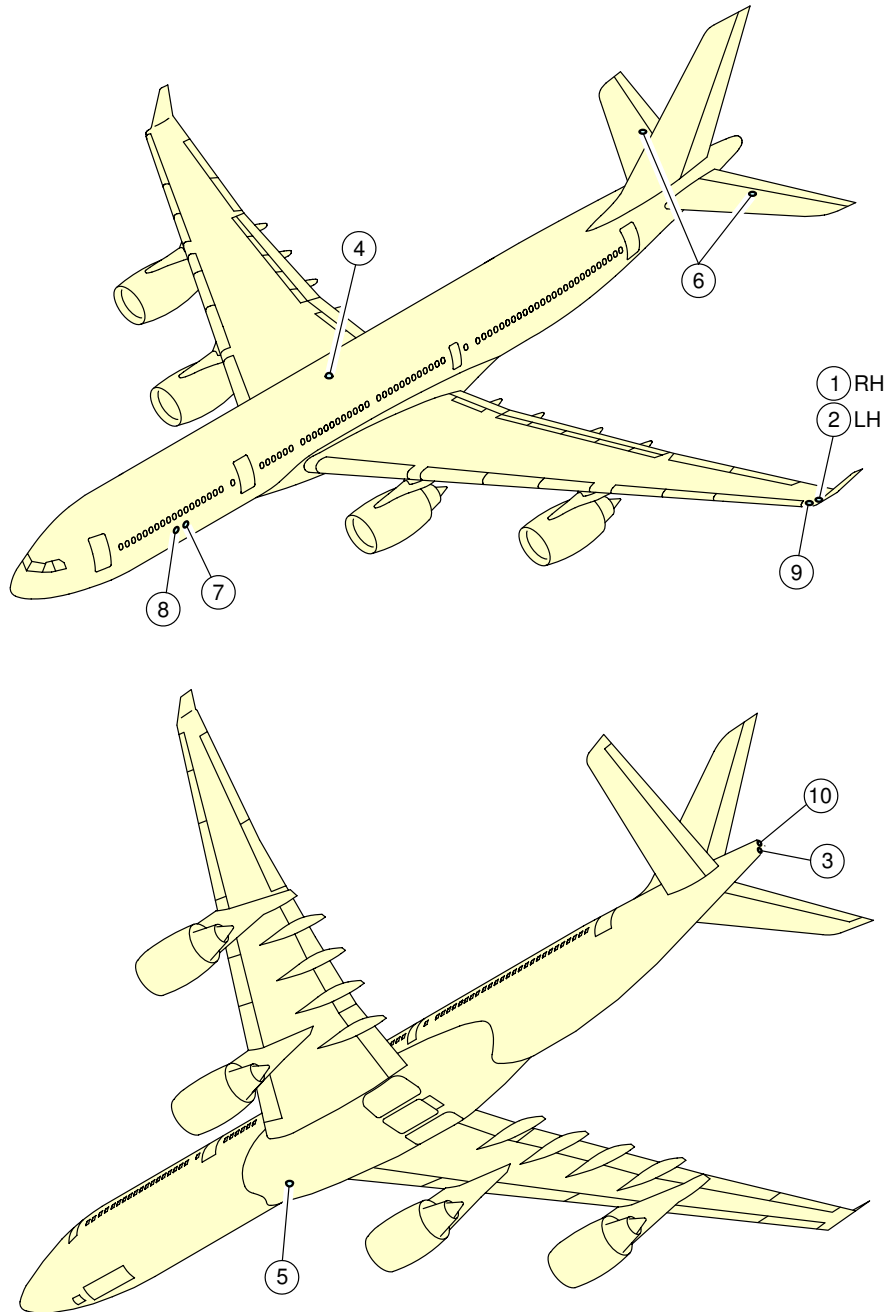

F_AC_021000_1_0060101_01_00

Exterior Lighting
(Sheet 1 of 5)
FIGURE-2-10-0-991-006-A01

A340-500/-600

AIRCRAFT CHARACTERISTICS - AIRPORT AND MAINTENANCE PLANNING

****ON A/C A340-500**

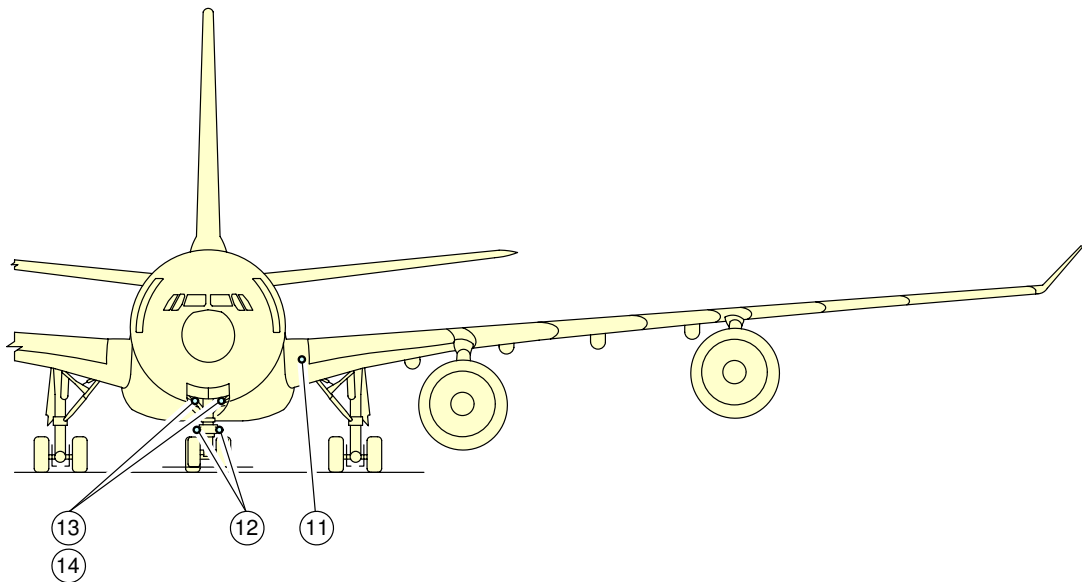

NOTE:

LIGHTS 13 AND 14 ARE THE SAME, BUT THEY OPERATE WITH DIFFERENT POWER SETTINGS.

F_AC_021000_1_0060102_01_00

Exterior Lighting
(Sheet 2 of 5)
FIGURE-2-10-0-991-006-A01

A340-500/-600

AIRCRAFT CHARACTERISTICS - AIRPORT AND MAINTENANCE PLANNING

**ON A/C A340-500

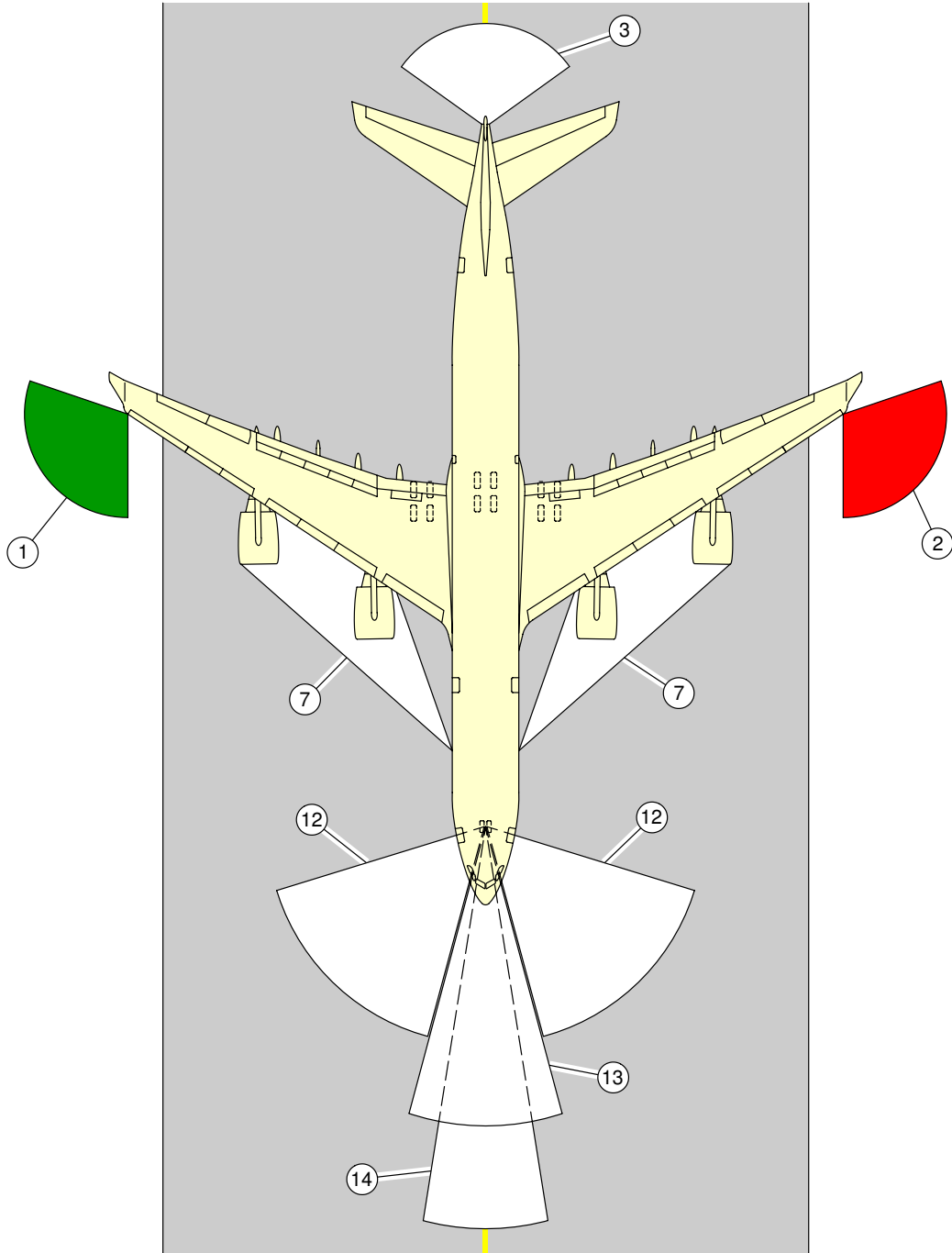

F_AC_021000_1_0060103_01_00

Exterior Lighting
(Sheet 3 of 5)
FIGURE-2-10-0-991-006-A01

A340-500/-600

AIRCRAFT CHARACTERISTICS - AIRPORT AND MAINTENANCE PLANNING

**ON A/C A340-500

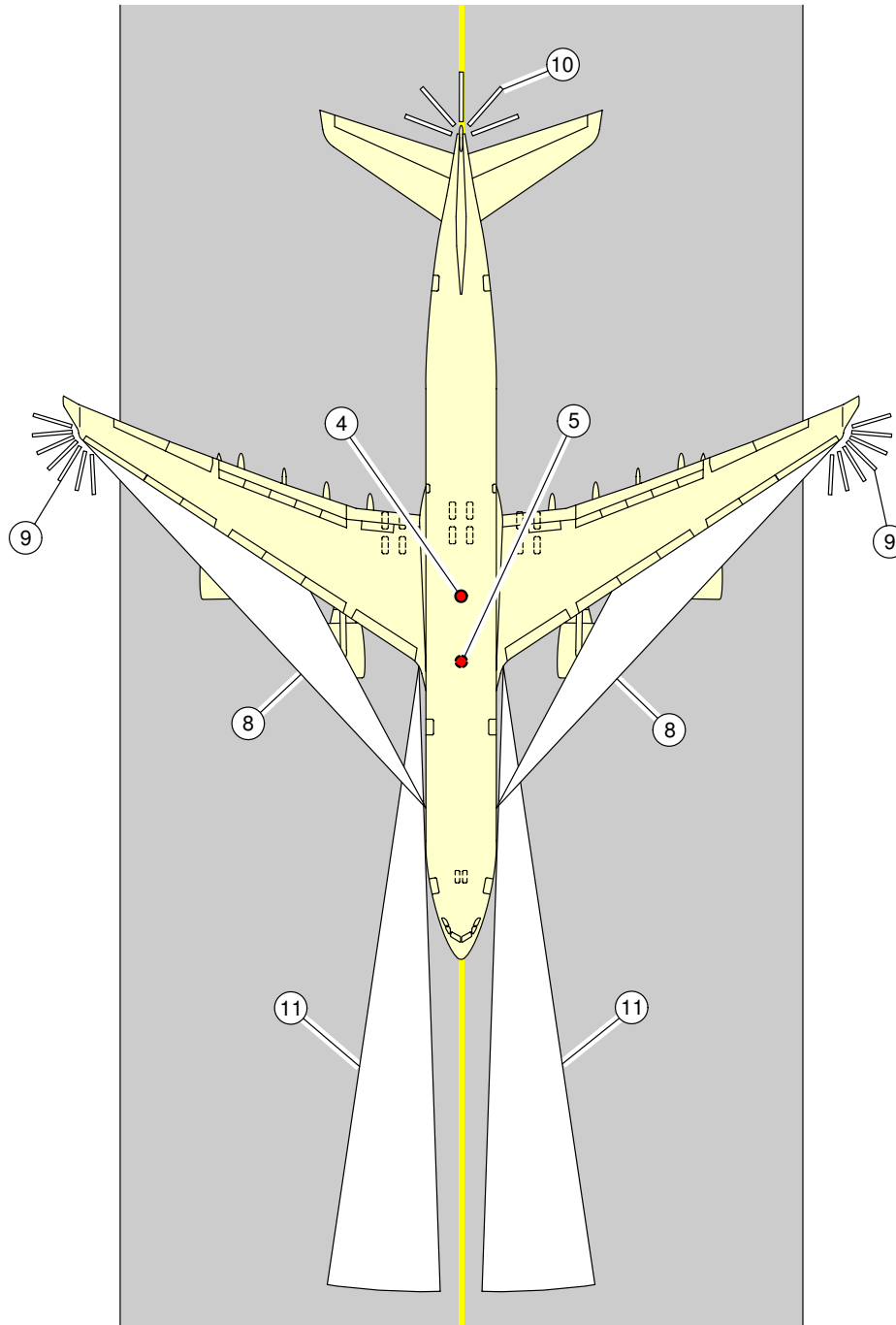

F_AC_021000_1_0060104_01_00

Exterior Lighting
(Sheet 4 of 5)
FIGURE-2-10-0-991-006-A01

A340-500/-600

AIRCRAFT CHARACTERISTICS - AIRPORT AND MAINTENANCE PLANNING

****ON A/C A340-500**

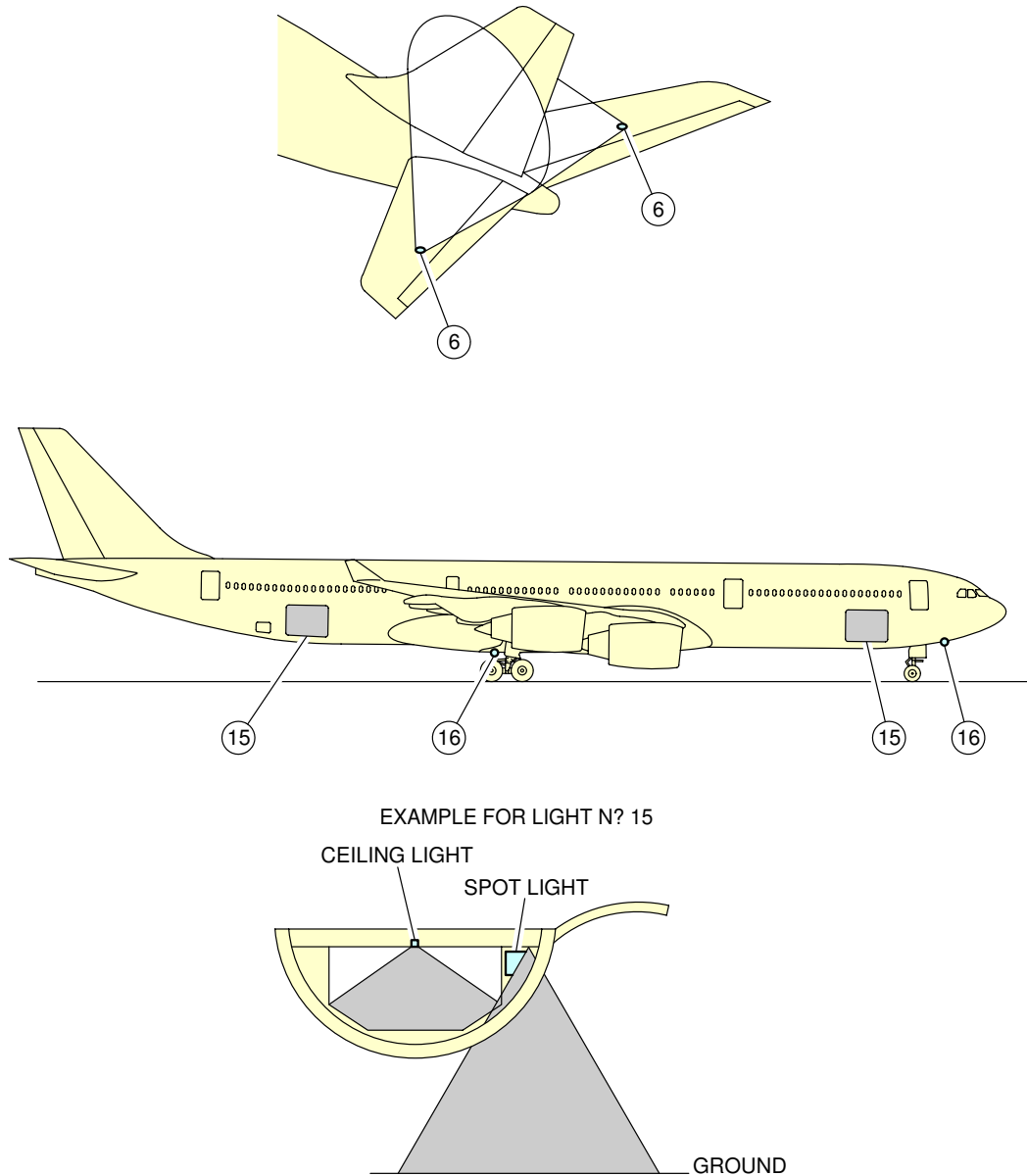

F_AC_021000_1_0060105_01_00

Exterior Lighting
(Sheet 5 of 5)
FIGURE-2-10-0-991-006-A01

A340-500/-600

AIRCRAFT CHARACTERISTICS - AIRPORT AND MAINTENANCE PLANNING

**ON A/C A340-600

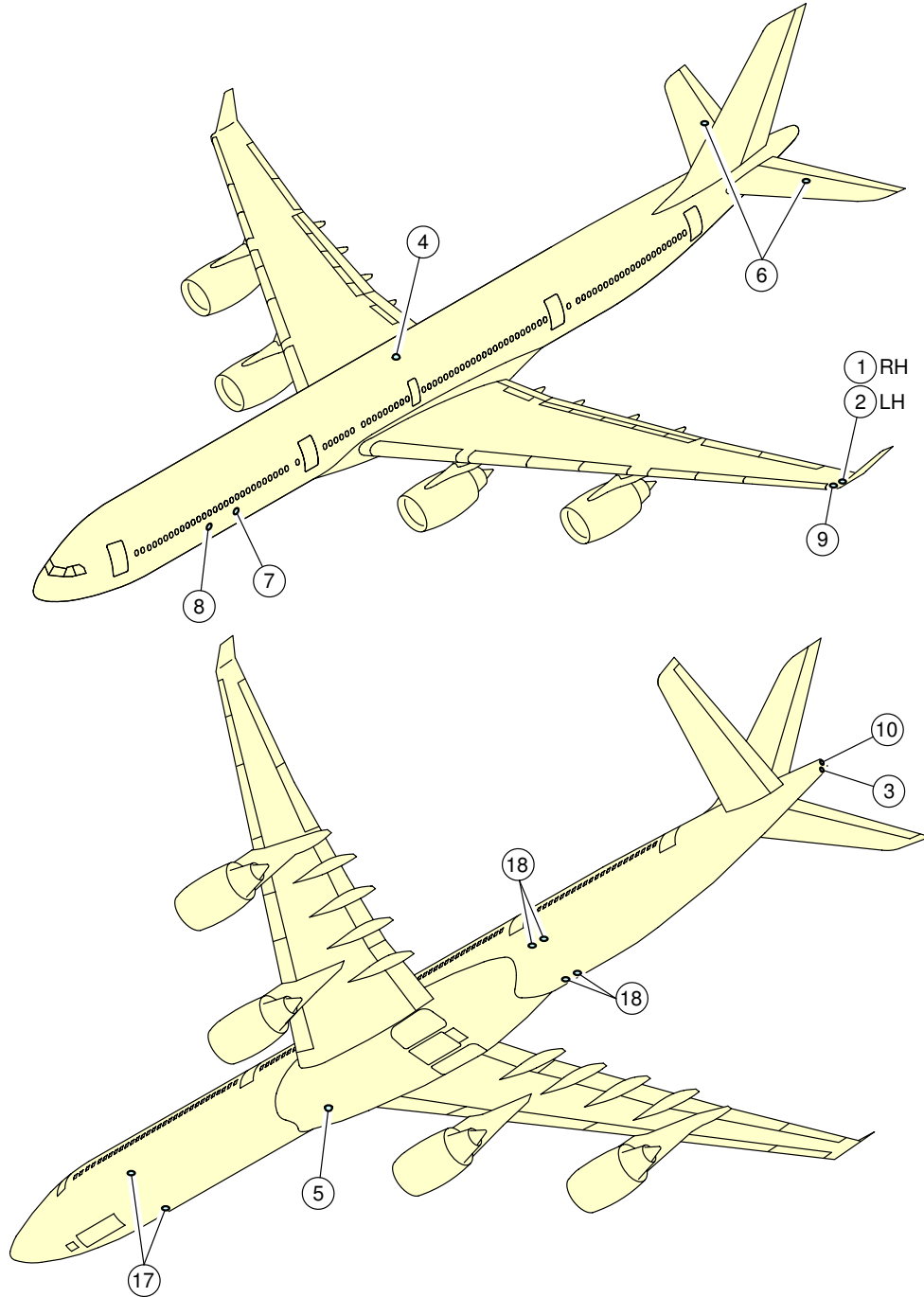

F_AC_021000_1_0070101_01_00

Exterior Lighting
(Sheet 1 of 6)
FIGURE-2-10-0-991-007-A01

A340-500/-600

AIRCRAFT CHARACTERISTICS - AIRPORT AND MAINTENANCE PLANNING

****ON A/C A340-600**

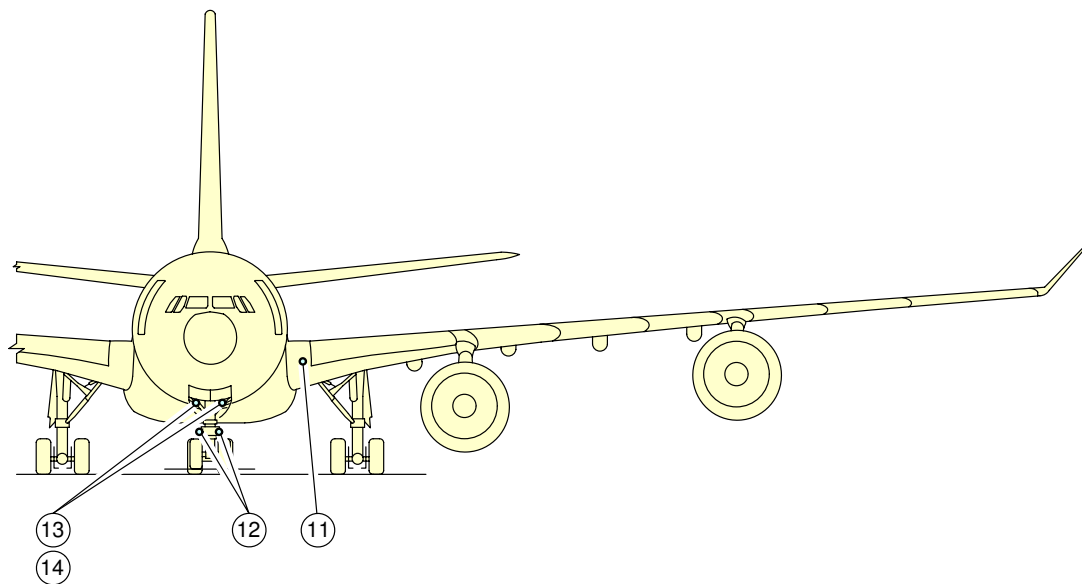

NOTE:

LIGHTS 13 AND 14 ARE THE SAME, BUT THEY OPERATE WITH DIFFERENT POWER SETTINGS.

F_AC_021000_1_0070102_01_00

Exterior Lighting
(Sheet 2 of 6)
FIGURE-2-10-0-991-007-A01

A340-500/-600

AIRCRAFT CHARACTERISTICS - AIRPORT AND MAINTENANCE PLANNING

**ON A/C A340-600

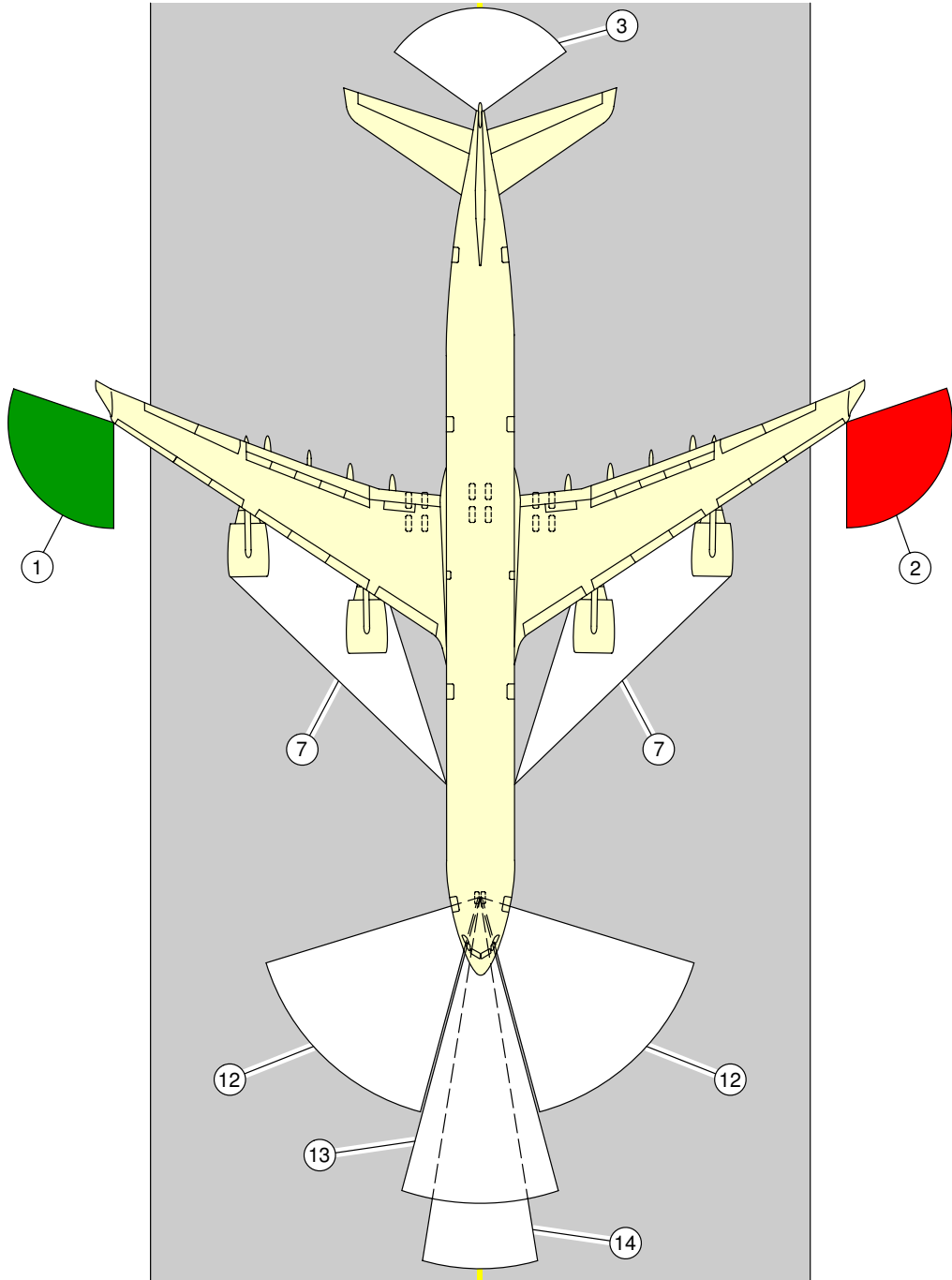

F_AC_021000_1_0070103_01_00

Exterior Lighting
(Sheet 3 of 6)
FIGURE-2-10-0-991-007-A01

A340-500/-600

AIRCRAFT CHARACTERISTICS - AIRPORT AND MAINTENANCE PLANNING

**ON A/C A340-600

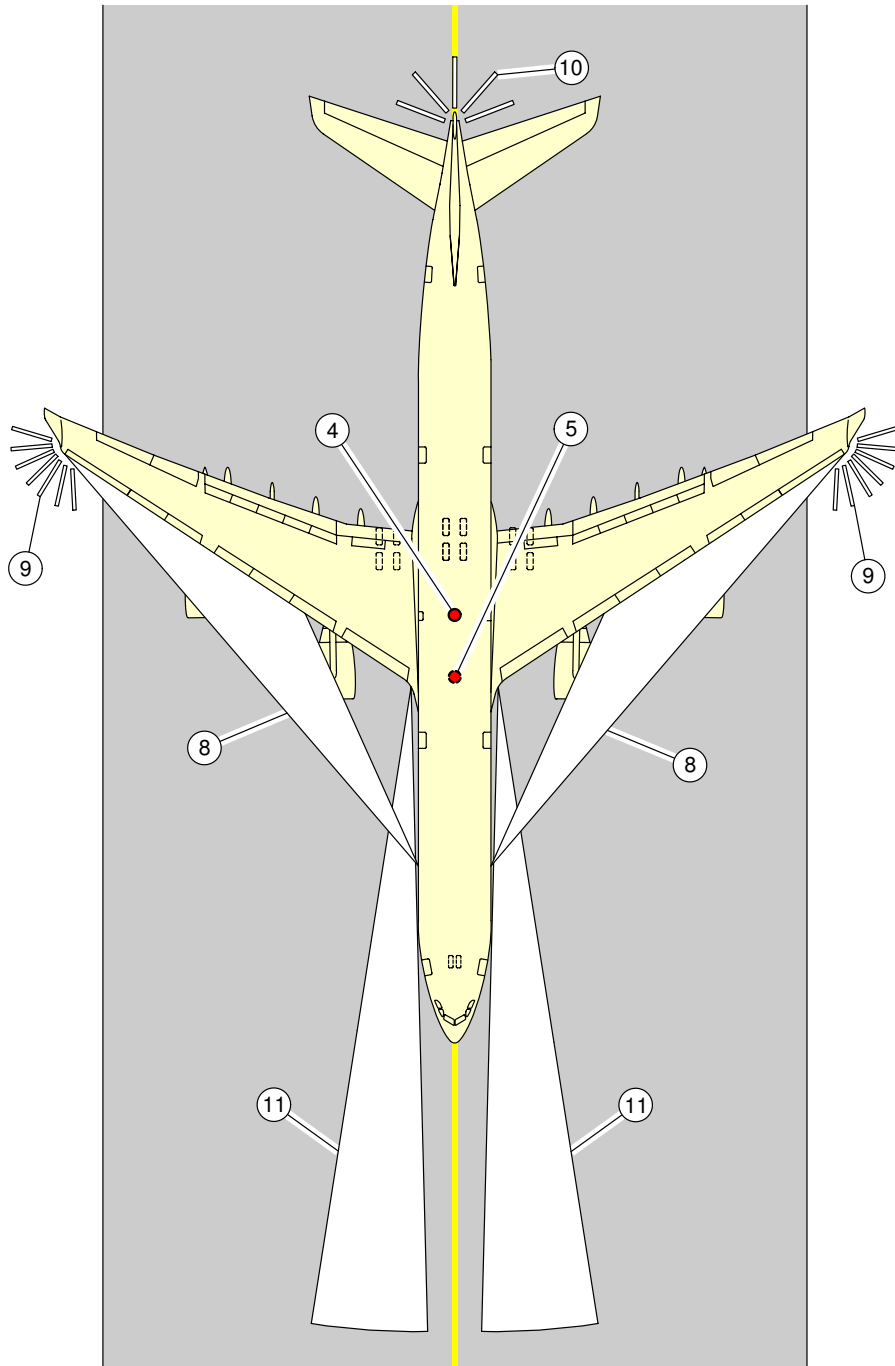

F_AC_021000_1_0070104_01_00

Exterior Lighting
(Sheet 4 of 6)
FIGURE-2-10-0-991-007-A01

A340-500/-600

AIRCRAFT CHARACTERISTICS - AIRPORT AND MAINTENANCE PLANNING

****ON A/C A340-600**

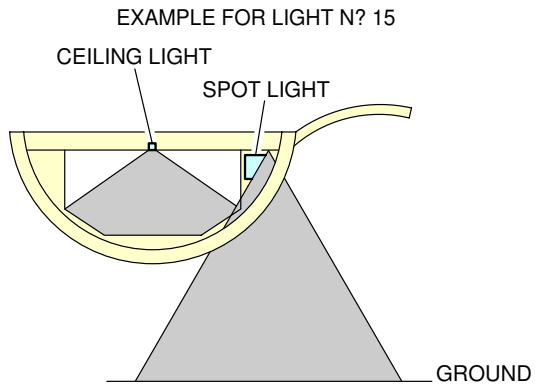
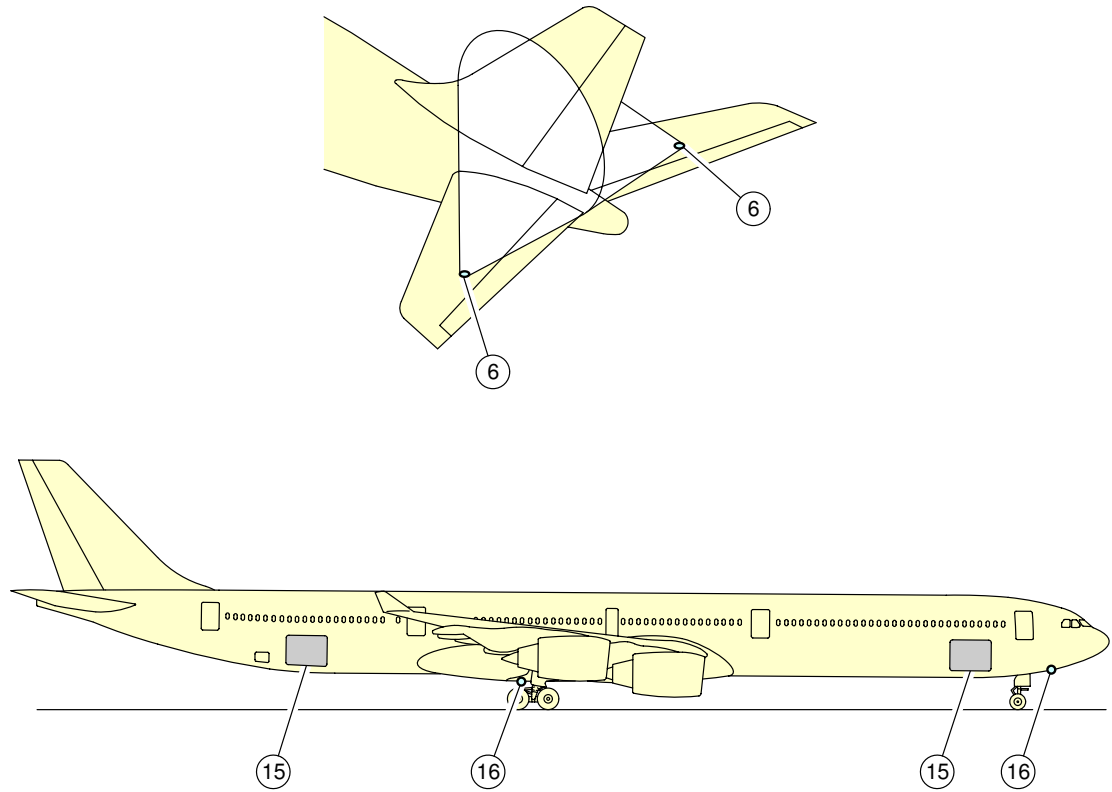

F_AC_021000_1_0070105_01_00

Exterior Lighting
(Sheet 5 of 6)
FIGURE-2-10-0-991-007-A01

A340-500/-600

AIRCRAFT CHARACTERISTICS - AIRPORT AND MAINTENANCE PLANNING

****ON A/C A340-600**

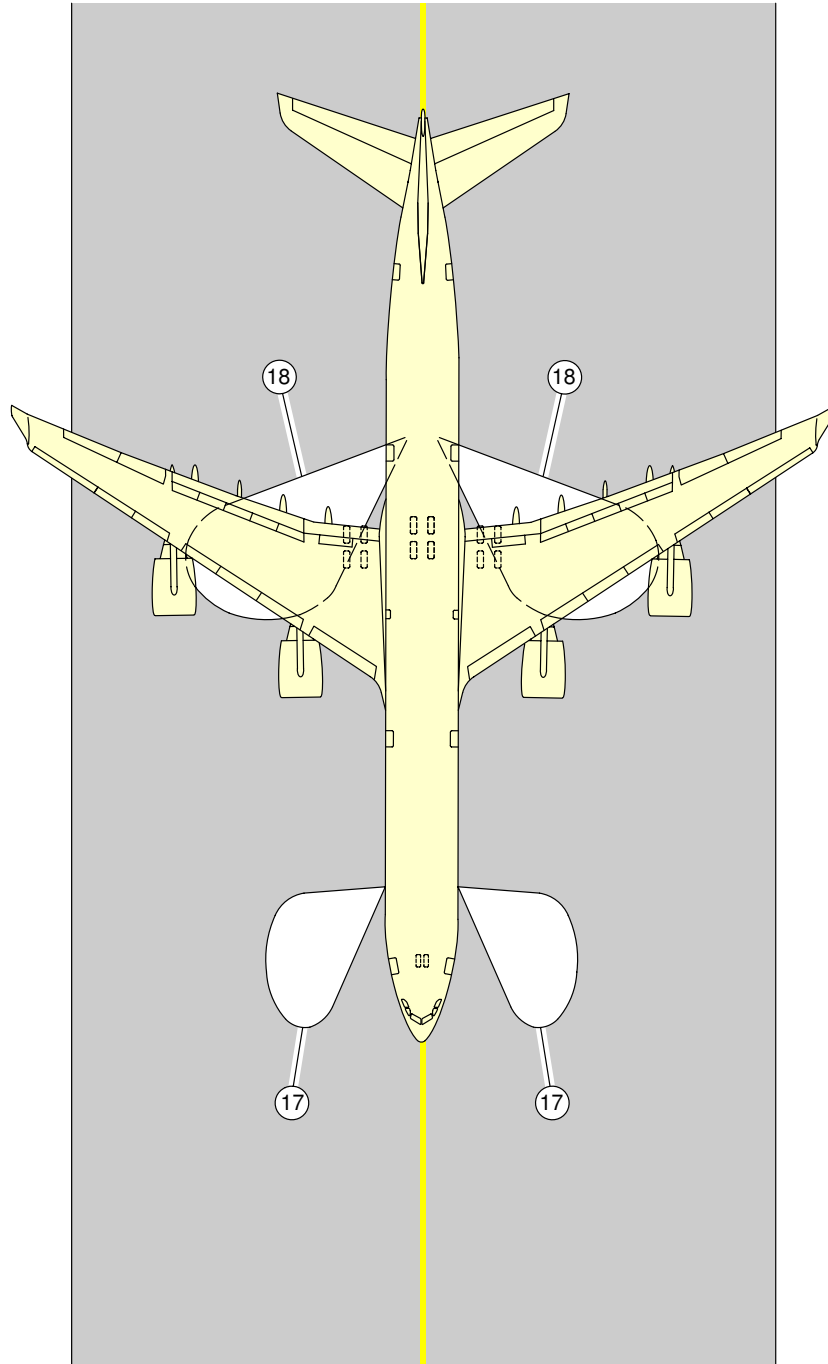

F_AC_021000_1_0070106_01_00

Exterior Lighting
(Sheet 6 of 6)
FIGURE-2-10-0-991-007-A01

2-11-0 Antennas and Probes Location****ON A/C A340-500 A340-600**Antennas and Probes Location

1. This section gives the location of antennas and probes.

A340-500/-600

AIRCRAFT CHARACTERISTICS - AIRPORT AND MAINTENANCE PLANNING

**ON A/C A340-500

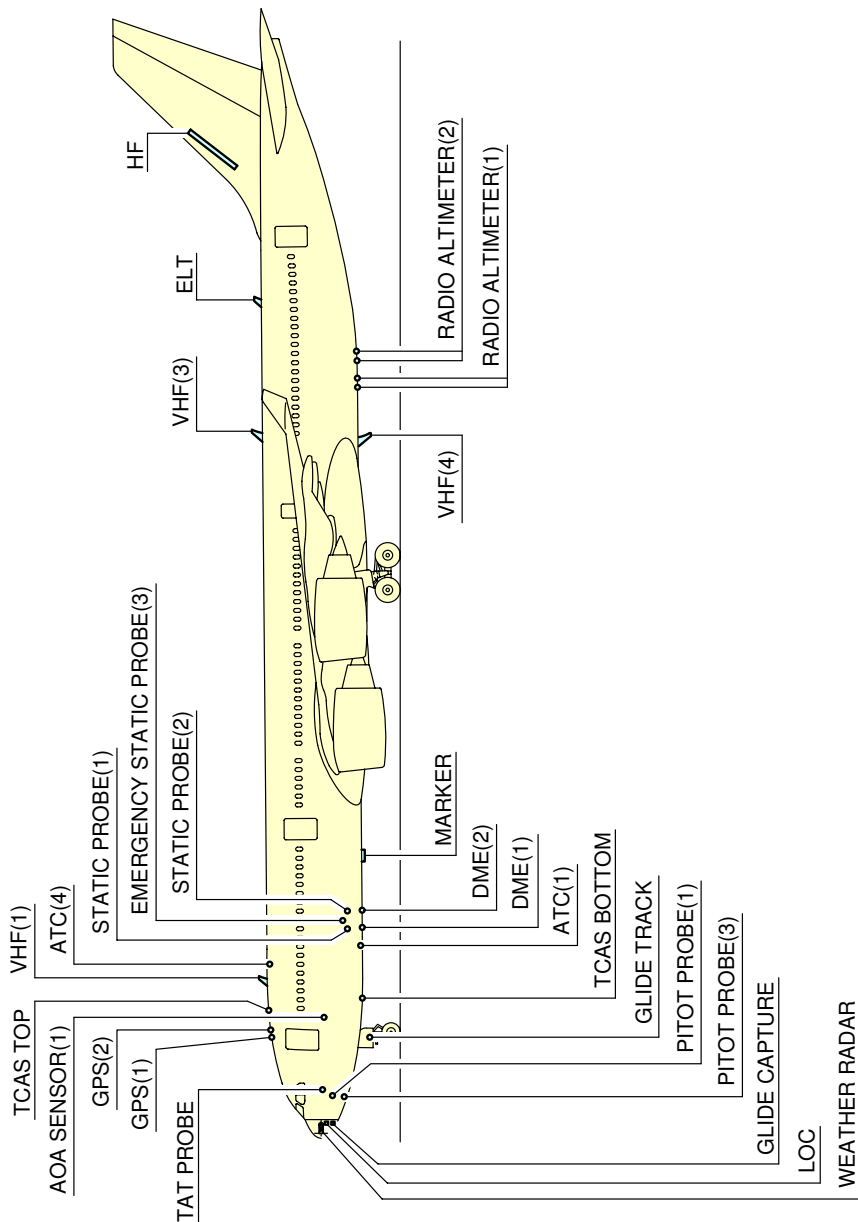

NOTE:
DEPENDENT ON AIRCRAFT CONFIGURATION

F_AC_021100_1_0060101_01_00

Antennas and Probes
Location (Sheet 1 of 2)
FIGURE-2-11-0-991-006-A01

A340-500/-600

AIRCRAFT CHARACTERISTICS - AIRPORT AND MAINTENANCE PLANNING

**ON A/C A340-500

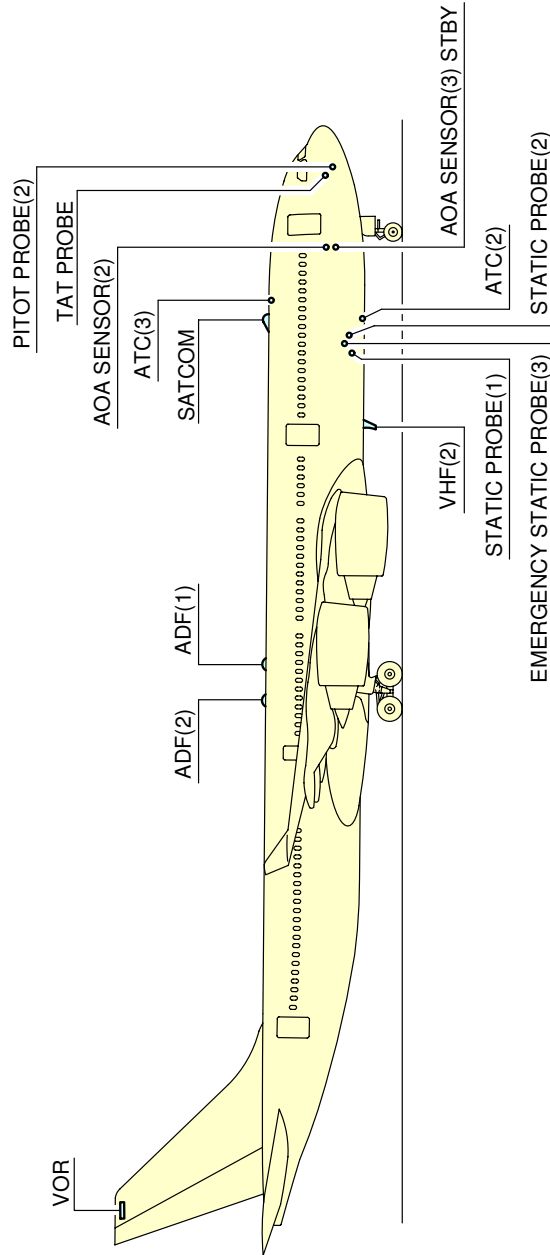

NOTE:
DEPENDENT ON AIRCRAFT CONFIGURATION

F_AC_021100_1_0060102_01_00

Antennas and Probes
Location (Sheet 2 of 2)
FIGURE-2-11-0-991-006-A01

A340-500/-600

AIRCRAFT CHARACTERISTICS - AIRPORT AND MAINTENANCE PLANNING

**ON A/C A340-600

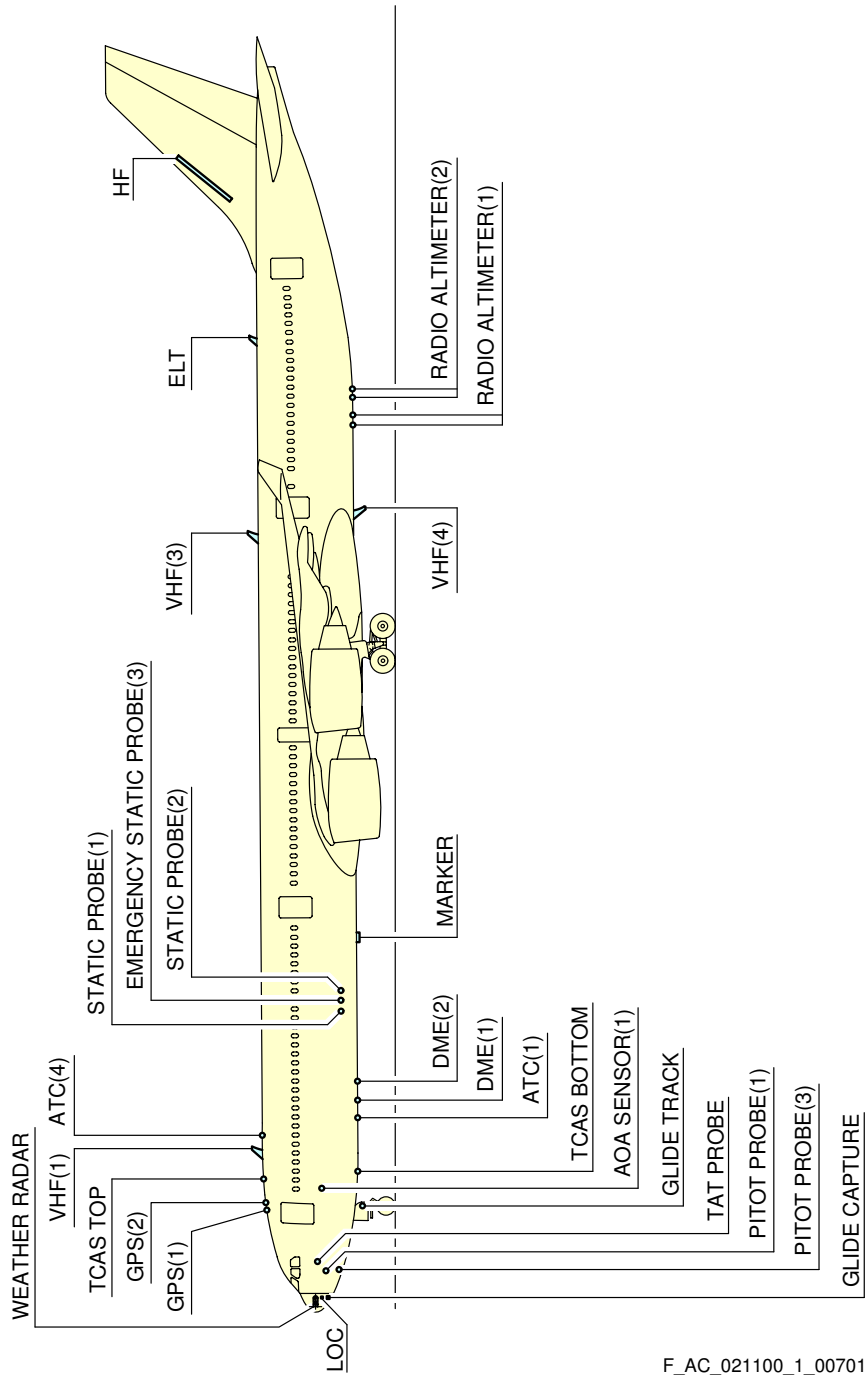

F_AC_021100_1_0070101_01_00

NOTE:
DEPENDENT ON AIRCRAFT CONFIGURATION

Antennas and Probes
Location (Sheet 1 of 2)
FIGURE-2-11-0-991-007-A01

A340-500/-600

AIRCRAFT CHARACTERISTICS - AIRPORT AND MAINTENANCE PLANNING

**ON A/C A340-600

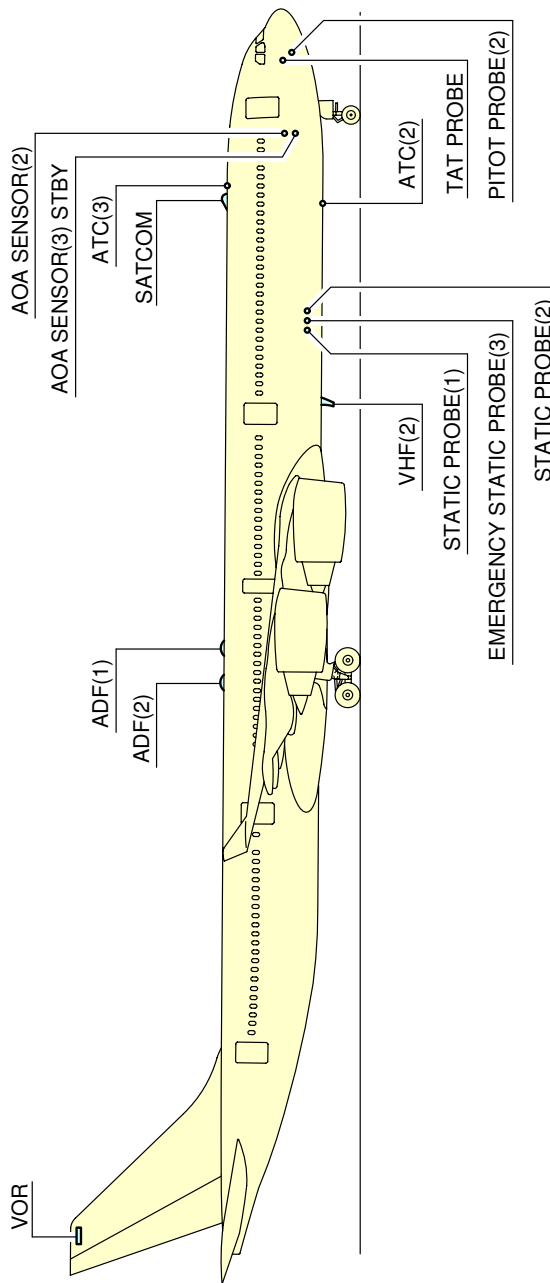

NOTE:
DEPENDENT ON AIRCRAFT CONFIGURATION

F_AC_021100_1_0070102_01_00

Antennas and Probes
Location (Sheet 2 of 2)
FIGURE-2-11-0-991-007-A01

2-12-0 Engine and Nacelle

****ON A/C A340-500 A340-600**

Engine and Nacelle

1. Engine and Nacelle – TRENT 500 Engine

A. Engine

The RB211-TRENT 500 engine is a high bypass ratio, triple spool turbofan.

The principal modules of the engine are:

- The Low Pressure Compressor (LPC) rotor
- The Intermediate Pressure (IP) compressor
- The intermediate case
- The HP system (this includes the High Pressure Compressor (HPC), the combustion system and the High Pressure Turbine (HPT))
- The IP turbine
- The external gearbox.

The compressor system has three axial flow compressors in a triple spool configuration. The compressors are turned independently by their related turbines, each at its most satisfactory speed. The LP system has a single-stage compressor installed at the front of the engine. A shaft connects the compressor to a five-stage turbine at the rear of the gas generator. The gas generator also includes an eight-stage IP compressor, a six-stage HPC and a combustion system. Each of the compressors in the gas generator is connected to, and turned by, a different single-stage turbine. Between the HPC and the HPT is the annular combustion system which burns a mixture of fuel and air to supply energy as heat. Behind the LP turbine there is a collector nozzle assembly through which the hot gas exhaust flows. The external gearbox module is installed below the fan case. It has a gear train that decreases and increases the speed to meet the specified drive requirements of each accessory.

B. Nacelle

A nacelle gives the engine an aerodynamic shape and supports the thrust reverser system. Each engine is housed in a nacelle suspended from a pylon attached below the wing. The nacelle consists of the following major components:

(1) Air Intake Cowl Assembly

The air intake cowl is an interchangeable aerodynamic cowl installed at the front of the engine. It ducts airflow to the fan and the engine core. The cowl has panels for easy access to the components. Acoustic materials are used in the manufacture of the cowl to help decrease the engine noise.

(2) Fan Cowl Assembly

The fan cowl assembly has two semicircular panels, the left fan cowl and the right fan cowl, that enclose the engine fan case between the air intake cowl and the thrust reverser. There are four assemblies for each aircraft. Each fan cowl panel is interchangeable from one engine to a different engine, when the strakes are removed or installed.

(3) Thrust Reverser

The thrust reverser is a component of the aircraft engine nacelle. The thrust reverser is a conventional fixed-cascade, translating-cowl type. The thrust reverser provides an aerodynamic flow path and uses the outer mobile structure, which is hydraulically powered, to provide a fan exhaust duct and a nozzle exit. In stow mode, the thrust reverser is an aerodynamic structure. In reverse mode, it is used to deflect and redirect part of the engine fan exhaust air by the blocker doors and in a forward direction through the cascades. The thrust reverser increases the aircraft wheel braking and the speed braking systems to reduce the landing distance.

(4) Exhaust System

The turbine exhaust system consists of one exhaust nozzle and one exhaust plug. The exhaust nozzle is bolted to the engine low pressure turbine frame flange outer flange. It is acoustically treated. The exhaust plug is bolted to the engine low pressure turbine frame flange inner flange. It is a two-piece conical structure. The turbine exhaust flow path is formed by the inner wall of the exhaust nozzle and the outer wall of the exhaust plug.

A340-500/-600

AIRCRAFT CHARACTERISTICS - AIRPORT AND MAINTENANCE PLANNING

**ON A/C A340-500 A340-600

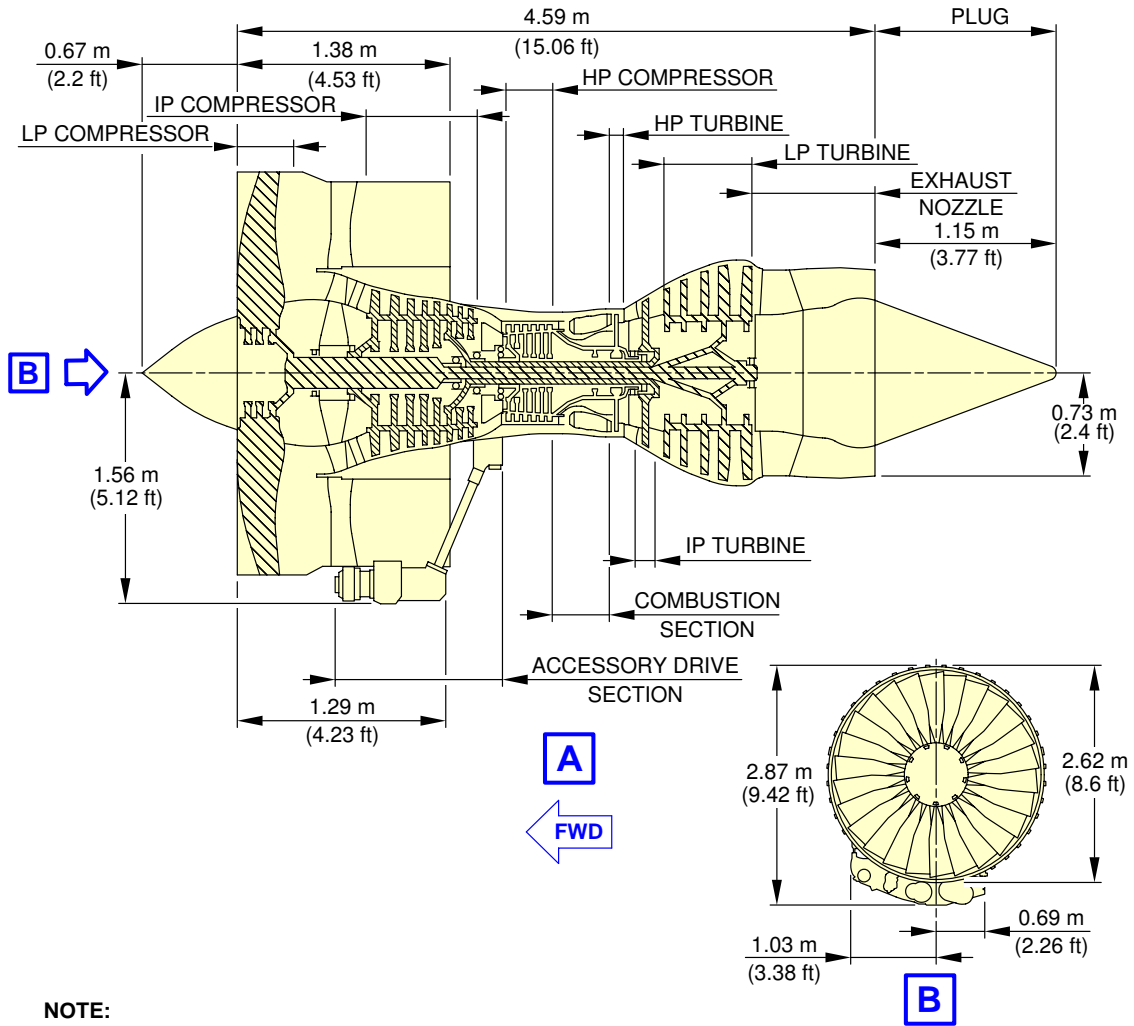
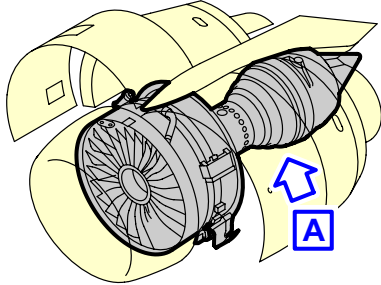

NOTE:
APPROXIMATE DIMENSIONS

F_AC_021200_1_0210101_01_00

Engine and Nacelle
Engine Dimensions - TRENT 500
FIGURE-2-12-0-991-021-A01

A340-500/-600

AIRCRAFT CHARACTERISTICS - AIRPORT AND MAINTENANCE PLANNING

****ON A/C A340-500 A340-600**

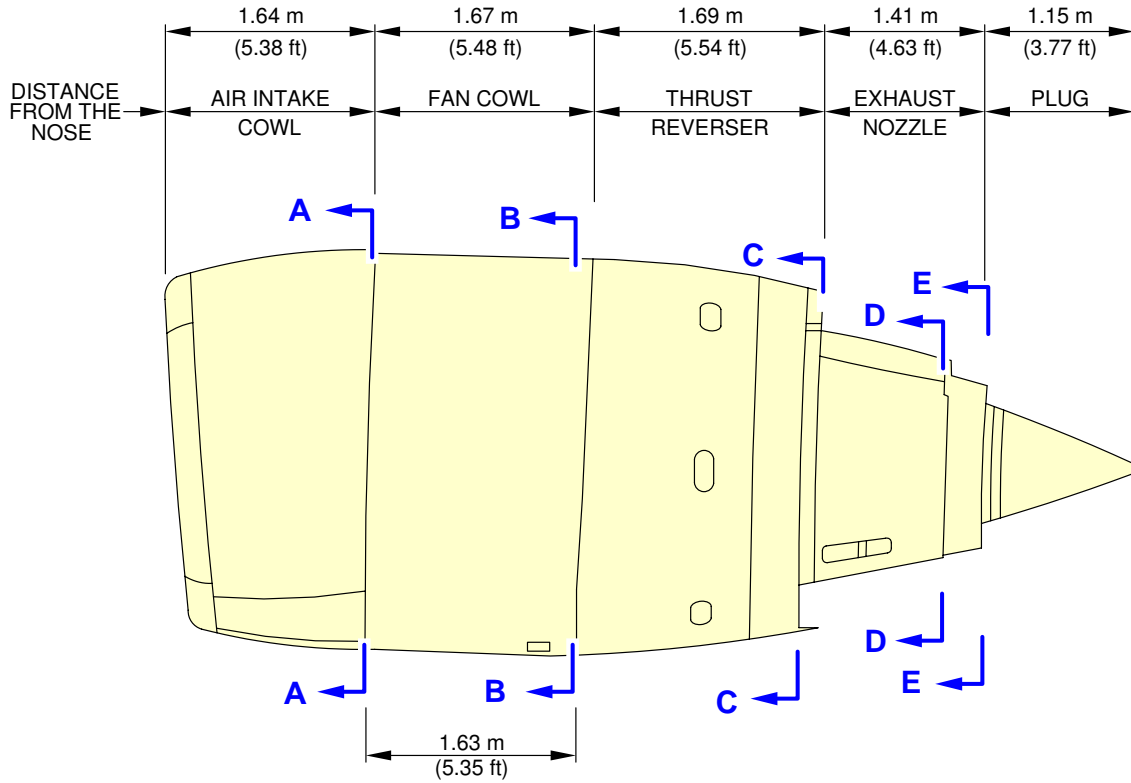

	W	U	V
A-A	3.14 m (10.3 ft)	1.49 m (4.89 ft)	1.63 m (5.35 ft)
B-B	3.14 m (10.3 ft)	1.49 m (4.89 ft)	1.63 m (5.35 ft)
C-C	2.69 m (8.83 ft)	1.34 m (4.4 ft)	1.34 m (4.4 ft)
D-D	1.51 m (4.95 ft)	0.78 m (2.56 ft)	0.75 m (2.46 ft)
E-E	1.35 m (4.43 ft)	0.67 m (2.2 ft)	0.67 m (2.2 ft)

DISTANCE FROM THE NOSE	A340-600	A340-500
INBOARD ENGINE	27.32 m (89.63 ft)	22.02 m (72.24 ft)
OUTBOARD ENGINE	33.95 m (111.38 ft)	28.66 m (94.03 ft)

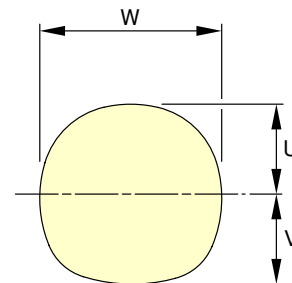

NOTE:
APPROXIMATE DIMENSIONS

F_AC_021200_1_0220101_01_00

Engine and Nacelle
Nacelle Dimensions - TRENT 500
FIGURE-2-12-0-991-022-A01

A340-500/-600

AIRCRAFT CHARACTERISTICS - AIRPORT AND MAINTENANCE PLANNING

**ON A/C A340-500 A340-600

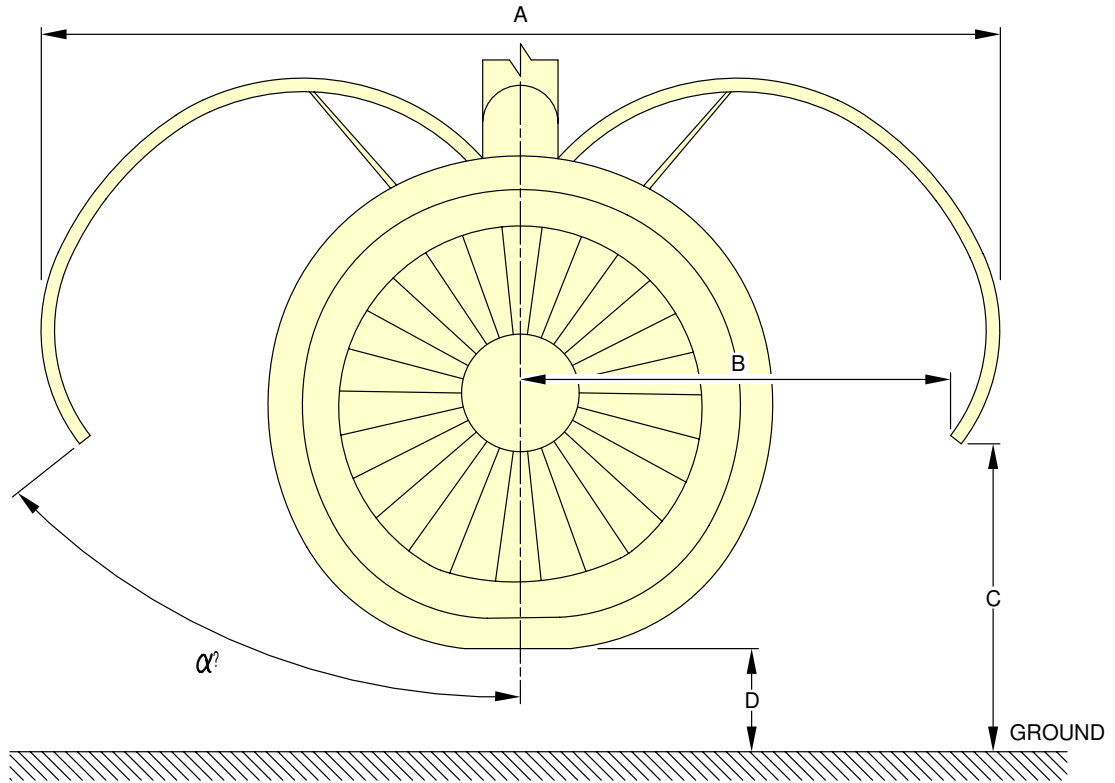

A/C CONFIGURATION	α°	DIM."C"		DIM."D"	
		INBOARD ENG.	OUTBOARD ENG.	INBOARD ENG.	OUTBOARD ENG.
OEW	38?	1.36 m (4.46 ft)	2.4 m (7.87 ft)	0.71 m (2.33 ft)	1.75 m (5.74 ft)
	55?	2.03 m (6.66 ft)	3.07 m (10.07 ft)		
MTW	38?	1.17 m (3.84 ft)	2.21 m (7.25 ft)	0.52 m (1.71 ft)	1.56 m (5.12 ft)
	55?	1.84 m (6.04 ft)	2.88 m (9.45 ft)		

α°	DIM."A"	DIM."B"
38?	5.41 m (17.75 ft)	2.15 m (7.05 ft)
55?	6.12 m (20.08 ft)	2.78 m (9.12 ft)

NOTE:

APPROXIMATE DIMENSIONS

FOR OTHER VALUES OF DIM. "D" REFER TO CHAPTER 2-3.

F_AC_021200_1_0230101_01_00

Engine and Nacelle
Fan Cowls - TRENT 500
FIGURE-2-12-0-991-023-A01

A340-500/-600

AIRCRAFT CHARACTERISTICS - AIRPORT AND MAINTENANCE PLANNING

****ON A/C A340-500 A340-600**

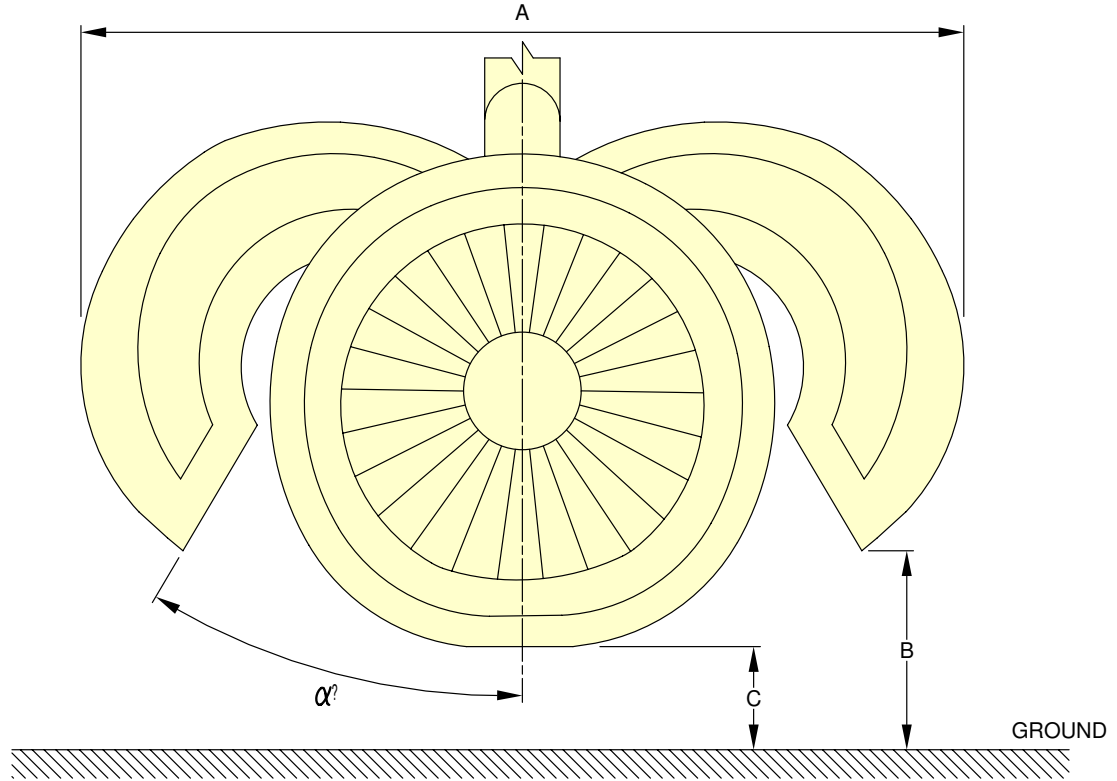

A/C CONFIGURATION	α	DIM."B"		DIM."C"	
		INBOARD ENG.	OUTBOARD ENG.	INBOARD ENG.	OUTBOARD ENG.
OEW	33?	1.04 m (3.41 ft)	2.08 m (6.82 ft)	0.71 m (2.33 ft)	1.75 m (5.74 ft)
	45?	1.4 m (4.59 ft)	2.44 m (8.01 ft)		
MTW	33?	0.85 m (2.79 ft)	1.89 m (6.2 ft)	0.52 m (1.71 ft)	1.56 m (5.12 ft)
	45?	1.21 m (3.97 ft)	2.25 m (7.38 ft)		

α	DIM."A"
33?	4.92 m (16.14 ft)
45?	5.5 m (18.04 ft)

NOTE:

APPROXIMATE DIMENSIONS

FOR OTHER VALUES OF DIM. "C" REFER TO CHAPTER 2-3.

F_AC_021200_1_0240101_01_00

Engine and Nacelle
Thrust Reverser Cowls - TRENT 500
FIGURE-2-12-0-991-024-A01

2-12-1 Auxiliary Power Unit

****ON A/C A340-500 A340-600**

Auxiliary Power Unit

1. General

The Auxiliary Power Unit (APU) and its related mechanical components are installed at the rear part of the fuselage in the tailcone section. The APU compartment is a fireproof area (identified as the Fire Zone).

The APU is a pneumatic and shaft-power gas-turbine engine and is used for the ground and in-flight power supply of the aircraft.

The APU supplies:

- mechanical shaft-power to operate a generator
- bleed-air to the Main Engine Start (MES) and the Environmental Control System (ECS).

A part of the automatic system, with the pneumatic and the electromechanical controls, operates the start and the acceleration functions of the APU.

An air intake system with a flap-type door is installed in front of the APU compartment. The exhaust gases pass overboard at the end of the fuselage cone.

2. Powerplant

The APU is the Garrett Gas-Turbine Compressor Power-unit (GTCP) 331-600A with a single shaft engine.

The engine is the primary component of the APU, which is of the modular design. The modules of the engine are:

- The power section
- The load compressor
- The accessory drive gearbox with LRU(s).

The power section has a two-stage centrifugal compressor, a reverse-flow annular combustion chamber and a three-stage axial turbine. The power section directly operates the one-stage centrifugal load-compressor which supplies the bleed-air to the pneumatic system. The inlet guide vanes as part of the load compressor, control the airflow.

The power section also operates the gearbox which is attached to the load compressor. The following LRU's are mounted on the gearbox :

- the APU generator,
- the starter motor,
- the oil pump,
- the Fuel Control Unit (FCU),

The APU has a gearbox-driven oil-cooled AC generator.

The cooling air and ventilation system of the APU supplies the air for cooling of the APU and the equipment on the APU. It also supplies the air for ventilation of the APU compartment.

A340-500/-600

AIRCRAFT CHARACTERISTICS - AIRPORT AND MAINTENANCE PLANNING

3. Control circuit

The Electronic Control Box (ECB), which controls the Fuel Control Unit (FCU) and the Inlet Guide Vanes (IGV), keeps the APU at a constant speed. The control circuit is used to start the APU, to shut it down, to control it and to prevent internal failure.

4. Controls and Indication

The primary APU controls and indications are installed in the overhead panel, on the center pedestal panel and on the forward center panel. External APU panels are also installed on the nose landing gear and on the refuel/defuel panel, to initiate an APU emergency shut-down.

A340-500/-600

AIRCRAFT CHARACTERISTICS - AIRPORT AND MAINTENANCE PLANNING

**ON A/C A340-500 A340-600

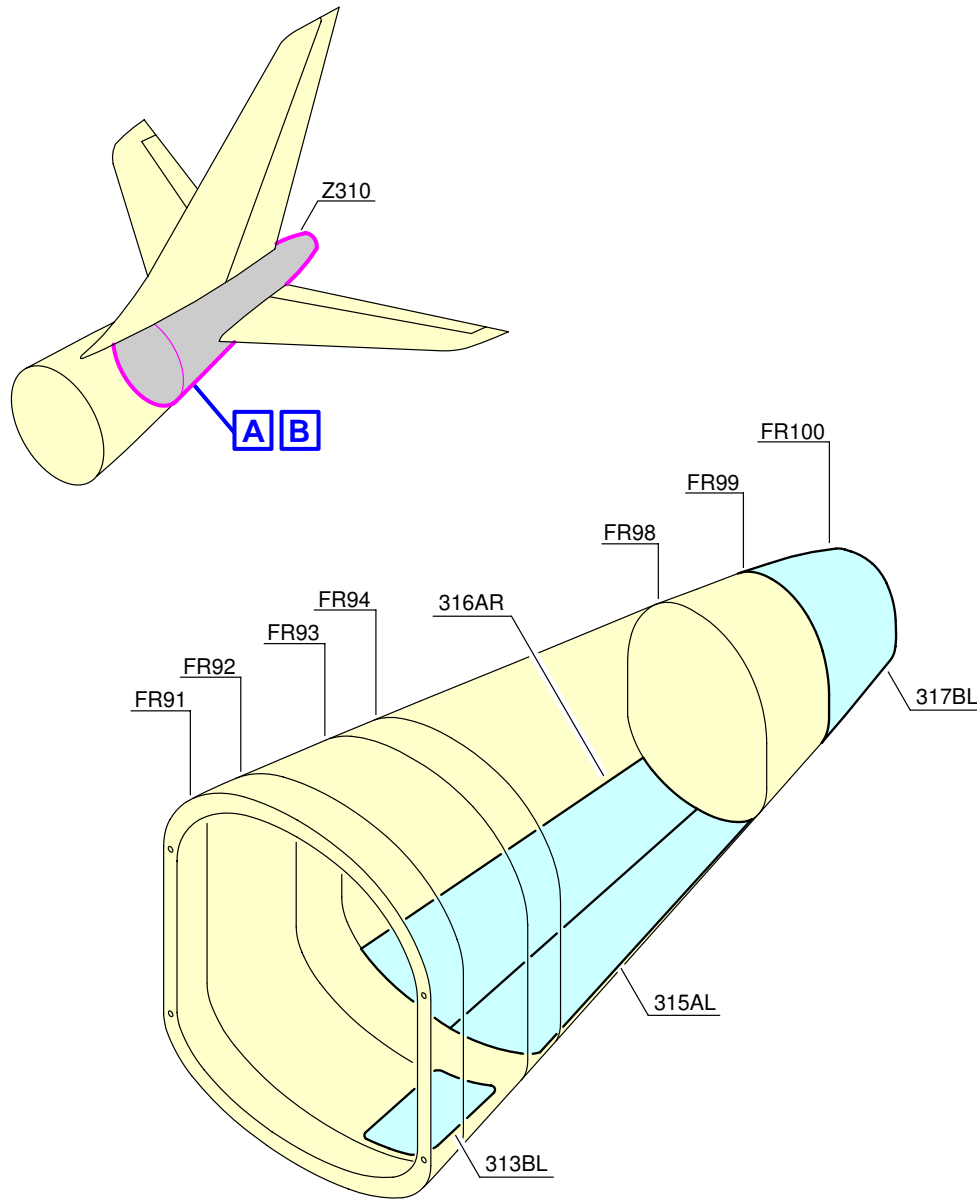

A

F_AC_021201_1_0020201_01_00

Auxiliary Power Unit
Access Doors (Sheet 1 of 2)
FIGURE-2-12-1-991-002-B01

A340-500/-600

AIRCRAFT CHARACTERISTICS - AIRPORT AND MAINTENANCE PLANNING

**ON A/C A340-500 A340-600

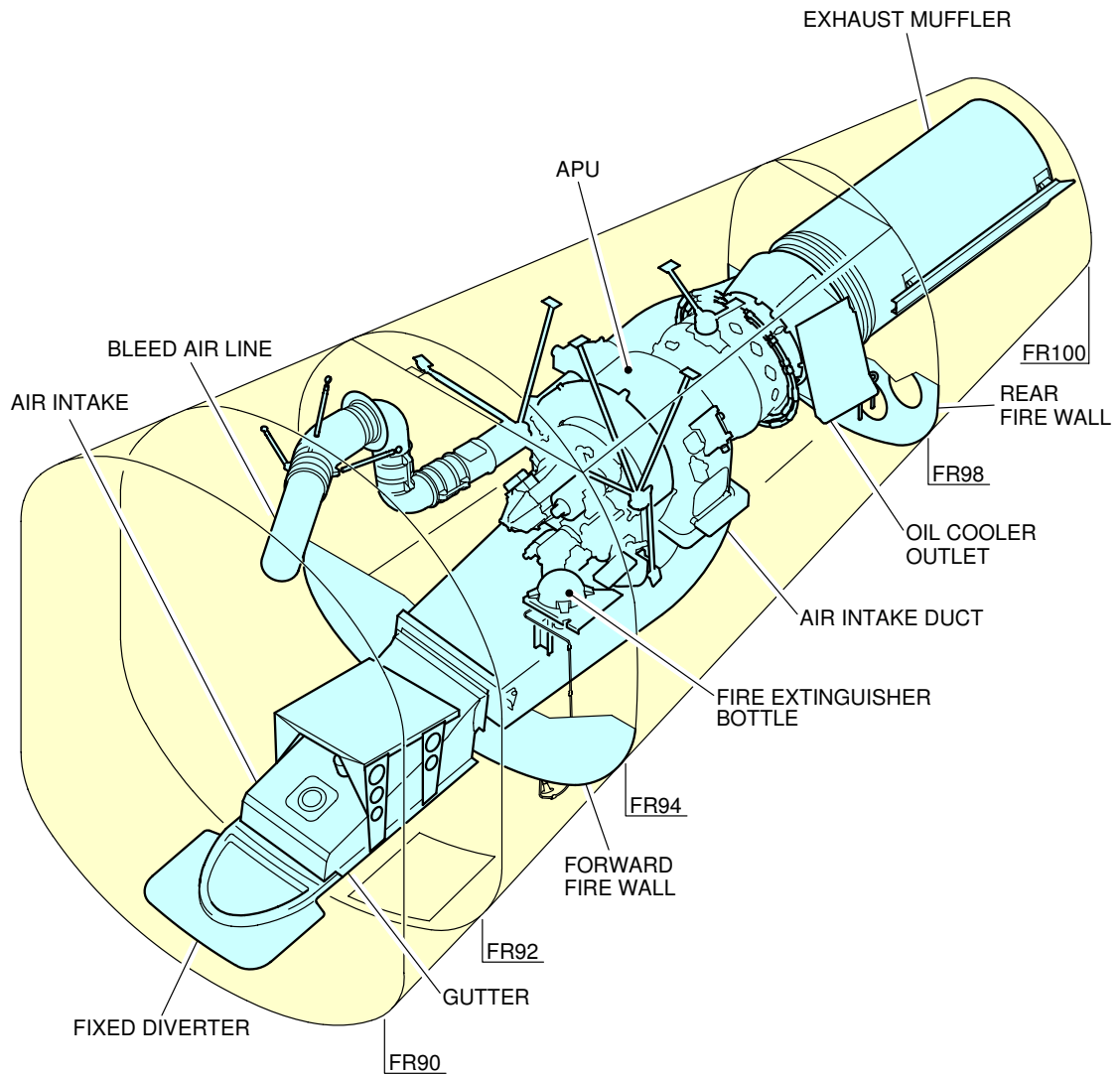

B

F_AC_021201_1_0020202_01_00

Auxiliary Power Unit
General Layout (Sheet 2 of 2)
FIGURE-2-12-1-991-002-B01

2-13-0 Levelling, symmetry and Alignment

****ON A/C A340-500 A340-600**

Leveling, Symmetry and Alignment

1. Quick Leveling

There are three alternative procedures to level the aircraft:

- Quick leveling procedure with Air Data/Inertial Reference System (ADIRS)
- Quick leveling procedure with a spirit level in the passenger compartment
- Quick leveling procedure with a spirit level in the FWD cargo compartment.

2. Precision Leveling

For precise leveling, it is necessary to install sighting rods in the receptacles located under the fuselage (points 12 and 13 for longitudinal leveling) and under the wings (points 2LH and 2RH for lateral leveling) and use a sighting tube. With the aircraft on jacks, adjust the jacks until the reference marks on the sighting rods are aligned in the sighting plane (aircraft level).

3. Symmetry and Alignment Check

Possible deformation of the aircraft is measured by photogrammetry.

A340-500/-600

AIRCRAFT CHARACTERISTICS - AIRPORT AND MAINTENANCE PLANNING

****ON A/C A340-500**

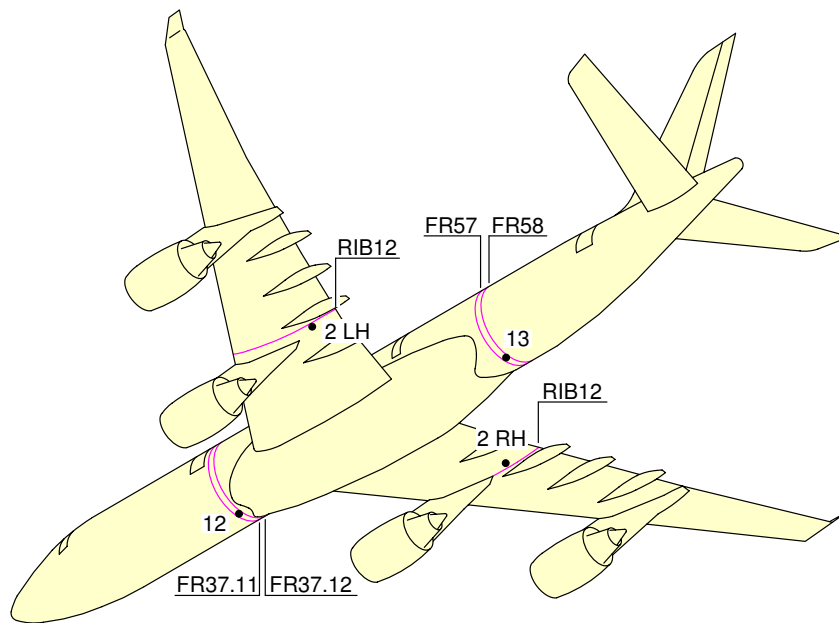

F_AC_021300_1_0060101_01_00

Location of Leveling Points
FIGURE-2-13-0-991-006-A01

A340-500/-600

AIRCRAFT CHARACTERISTICS - AIRPORT AND MAINTENANCE PLANNING

****ON A/C A340-600**

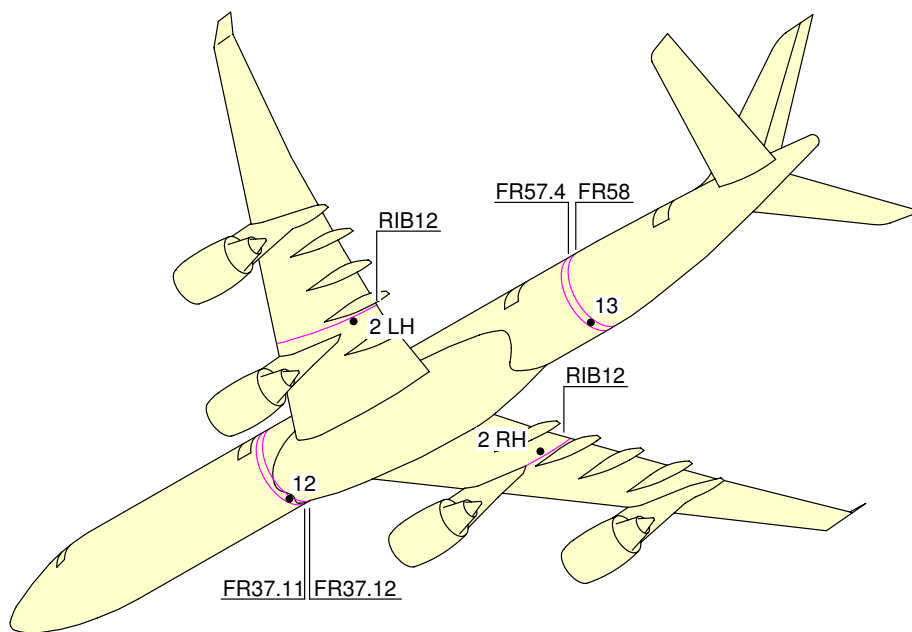

F_AC_021300_1_0070101_01_00

Location of Leveling Points
FIGURE-2-13-0-991-007-A01

2-14-0 Jacking for Maintenance

****ON A/C A340-500 A340-600**

Jacking for Maintenance

1. Aircraft Jacking Points for Maintenance

A. General

- (1) The A340-500/-600 can be jacked:
 - At not more than 200 000 kg (440 924 lb),
 - Within the limits of the permissible wind speed when the aircraft is jacked outside a closed environment.

B. Primary Jacking Points

- (1) The aircraft is provided with three primary jacking points:
 - One located under the forward fuselage (after FR10),
 - Two located under the wings (one under each wing), at the intersection of RIB10 and the rear of the spar-datum.
- (2) Three jack adapters (ground equipment) are used as intermediary parts between the aircraft jacking points and the jacks:
 - One male spherical jack adapter at the forward fuselage,
 - Two female spherical jack pad adapters at the wings (one at each wing).

C. Auxiliary Jacking Point (Safety Stay)

- (1) When the aircraft is on jacks, a safety stay is placed under the fuselage at FR87 to prevent tail tipping caused by accidental displacement of the aircraft center of gravity.
- (2) The safety point must not be used for lifting the aircraft.
- (3) One male spherical stay adapter (ground equipment) is used as an intermediary part between the aircraft safety point and the stay.

2. Jacks and Safety Stay

A. Jack Design

- (1) The maximum eligible loads given in the table (Ref. FIGURE 2-14-0-991-015-A/FIGURE 2-14-0-991-015-B) are the maximum loads applicable on jack fittings.
- (2) In fully retracted position (jack stroke at minimum), the height of the jack is such that the jack may be placed beneath the aircraft under the most adverse conditions, namely, tires deflated and shock absorbers depressurized, with sufficient clearance between the aircraft jacking point and the jack upper end.
- (3) The lifting jack stroke enables the aircraft to be jacked up so that the Fuselage Datum Line (FDL) may be positioned up to 7.2 m (23.62 ft) from the ground to allow all required maintenance procedures and in particular, the removal/installation of the landing-gear shock absorbers.

A340-500/-600

AIRCRAFT CHARACTERISTICS - AIRPORT AND MAINTENANCE PLANNING

B. Safety Stay

The stay stroke enables the aircraft tail to be supported up to the Fuselage Datum Line (FDL) positioned 7.2 m (23.62 ft) from the ground.

A340-500/-600

AIRCRAFT CHARACTERISTICS - AIRPORT AND MAINTENANCE PLANNING

**ON A/C A340-500

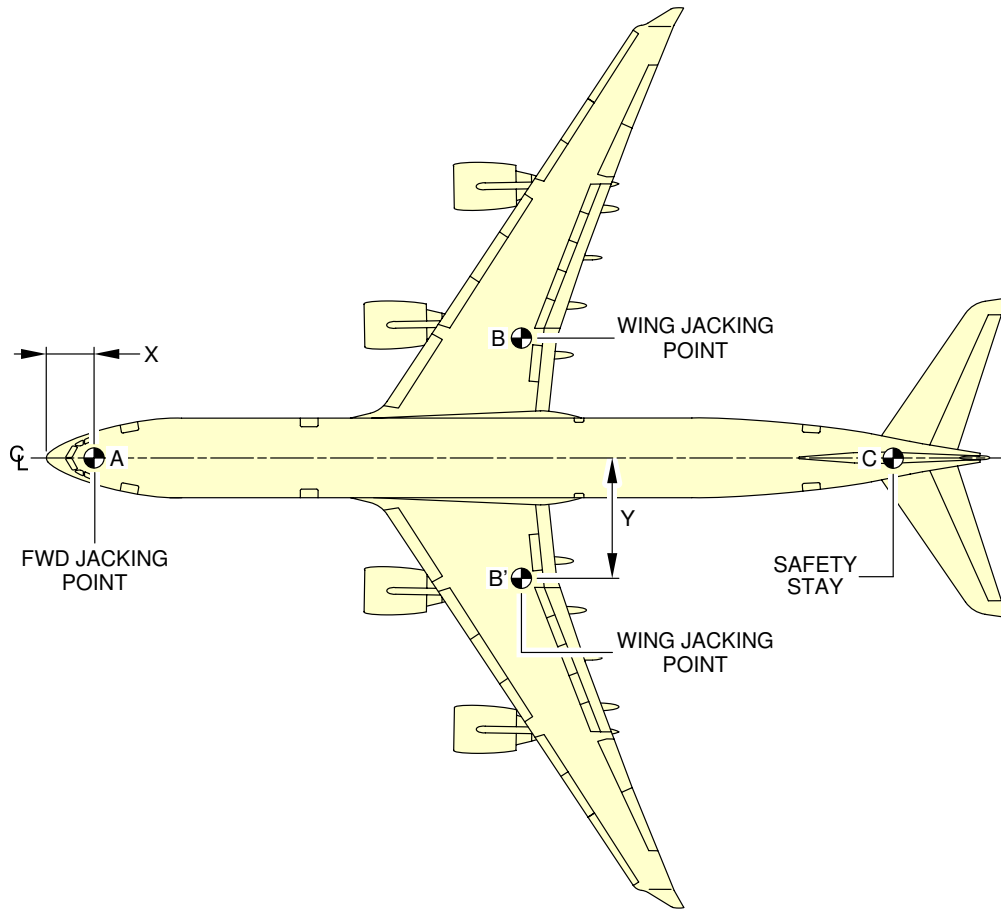

		X		Y		MAXIMUM LOAD ELIGIBLE daN
		m	ft	m	ft	
FORWARD FUSELAGE JACKING POINT	A	3.34	10.96	0	0	17 273
WING JACKING POINT	B	33.71	110.56	8.44	27.69	95 505
	B'	33.71	110.56	-8.44	-27.69	95 505
SAFETY STAY	C	60.05	197.01	0	0	4 775

NOTE:

SAFETY STAY IS NOT USED FOR JACKING.

F_AC_021400_1_0150101_01_00

Jacking for Maintenance
Jacking Points Location
FIGURE-2-14-0-991-015-A01

A340-500/-600

AIRCRAFT CHARACTERISTICS - AIRPORT AND MAINTENANCE PLANNING

**ON A/C A340-600

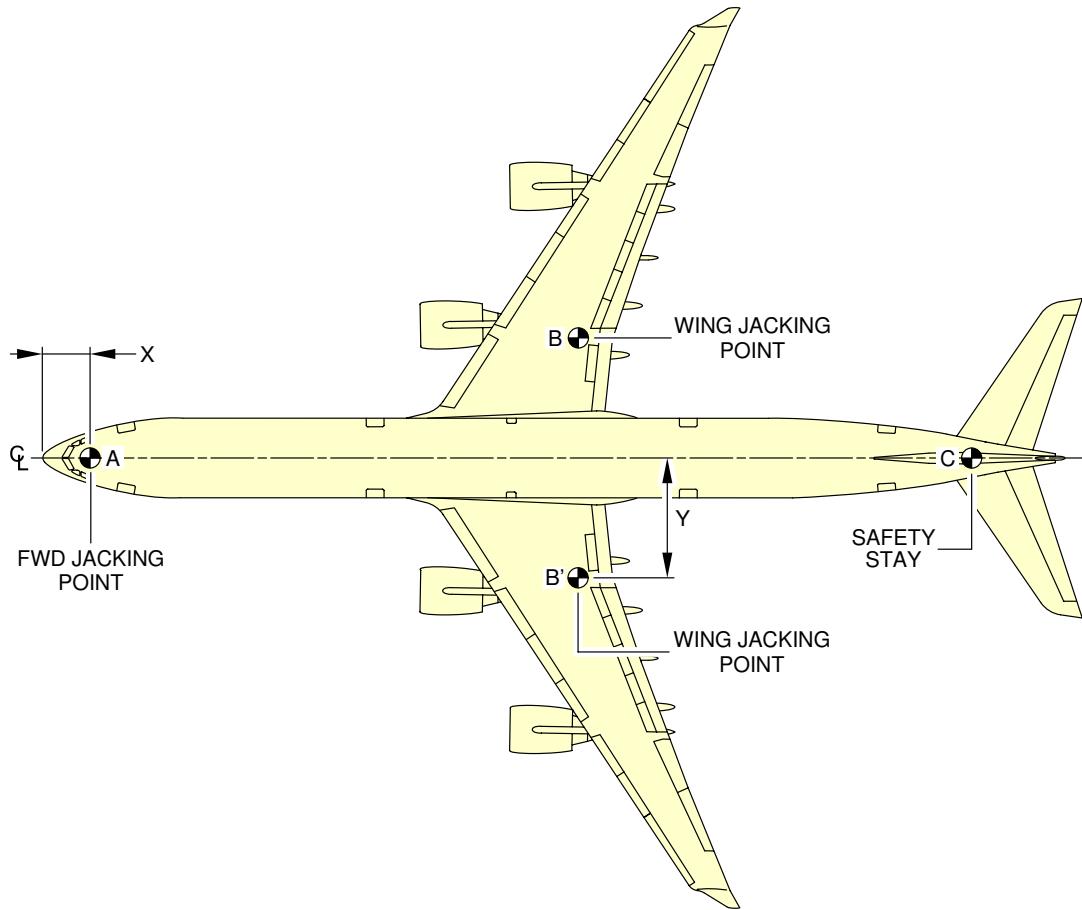

		X		Y		MAXIMUM LOAD ELIGIBLE daN
		m	ft	m	ft	
FORWARD FUSELAGE JACKING POINT	A	3.34	10.96	0	0	17 971
WING JACKING POINT	B	39.01	127.99	8.44	27.69	96 105
	B'	39.01	127.99	-8.44	-27.69	96 105
SAFETY STAY	C	67.48	221.39	0	0	4 805

NOTE:

SAFETY STAY IS NOT USED FOR JACKING.

F_AC_021400_1_0150201_01_00

Jacking for Maintenance
Jacking Points Location
FIGURE-2-14-0-991-015-B01

A340-500/-600

AIRCRAFT CHARACTERISTICS - AIRPORT AND MAINTENANCE PLANNING

**ON A/C A340-500 A340-600

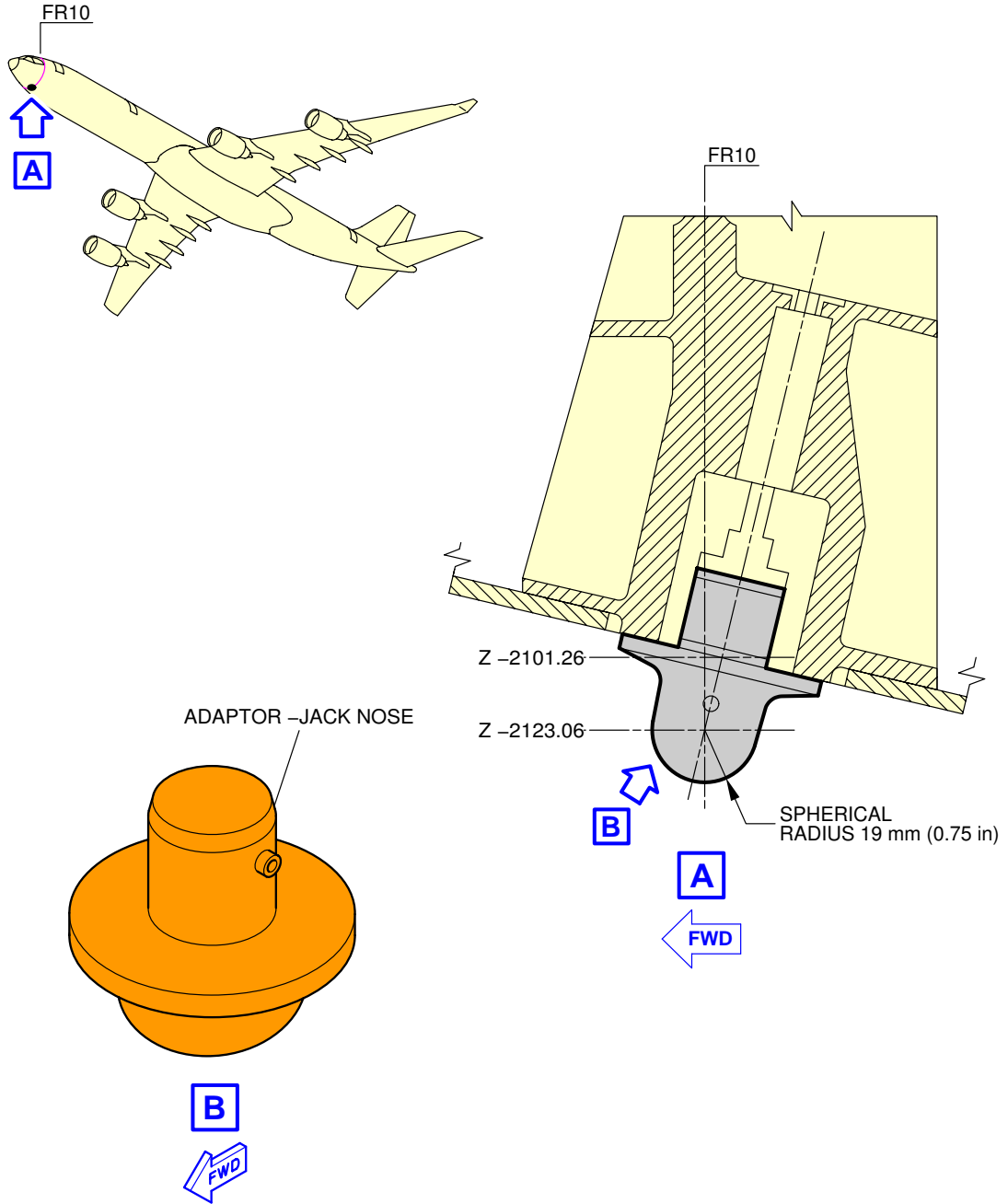

F_AC_021400_1_0160101_01_00

Jacking for Maintenance
Forward Jacking Point
FIGURE-2-14-0-991-016-A01

A340-500/-600

AIRCRAFT CHARACTERISTICS - AIRPORT AND MAINTENANCE PLANNING

**ON A/C A340-500 A340-600

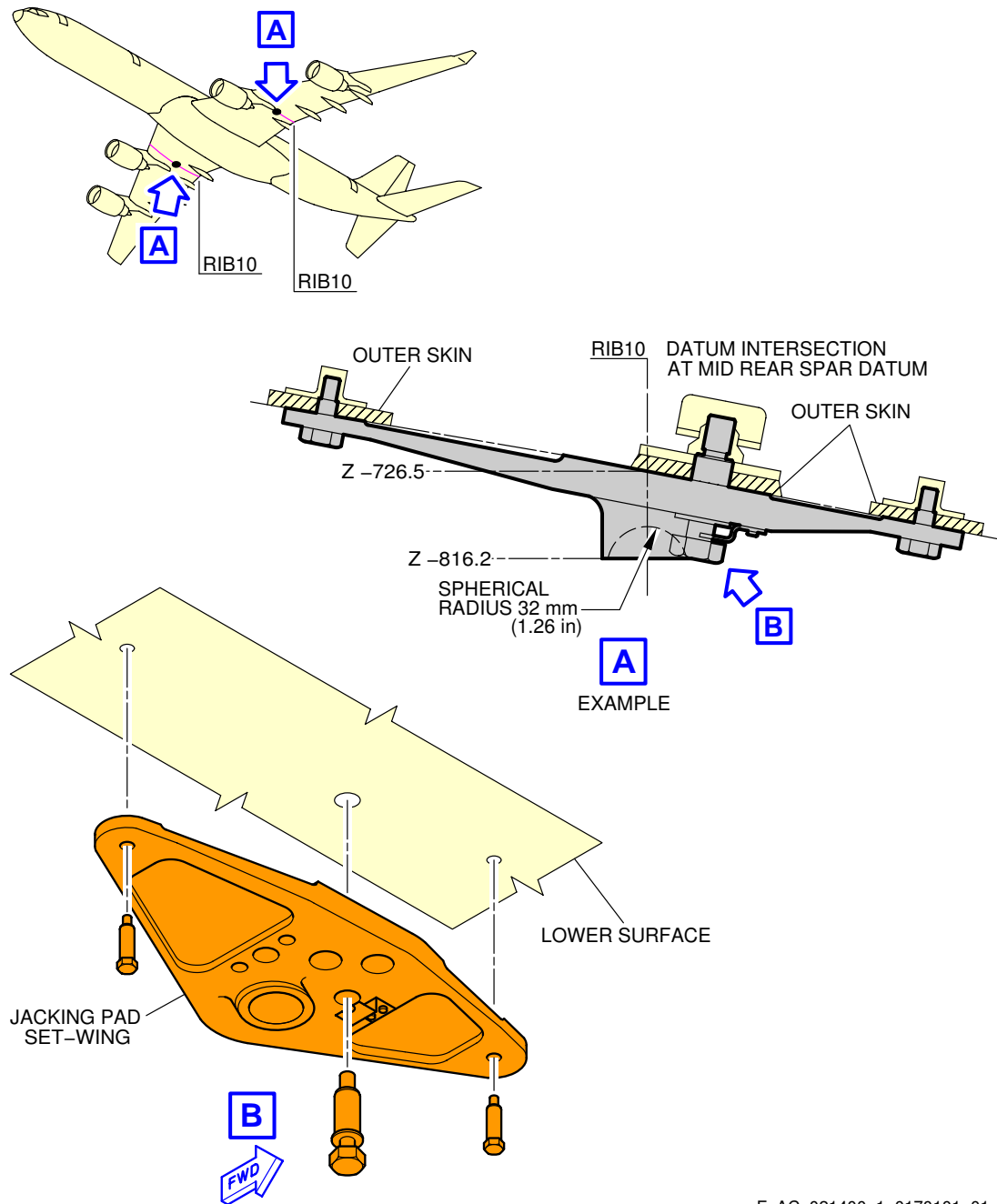

F_AC_021400_1_0170101_01_00

Jacking for Maintenance
Wing Jacking Points
FIGURE-2-14-0-991-017-A01

A340-500/-600

AIRCRAFT CHARACTERISTICS - AIRPORT AND MAINTENANCE PLANNING

**ON A/C A340-500 A340-600

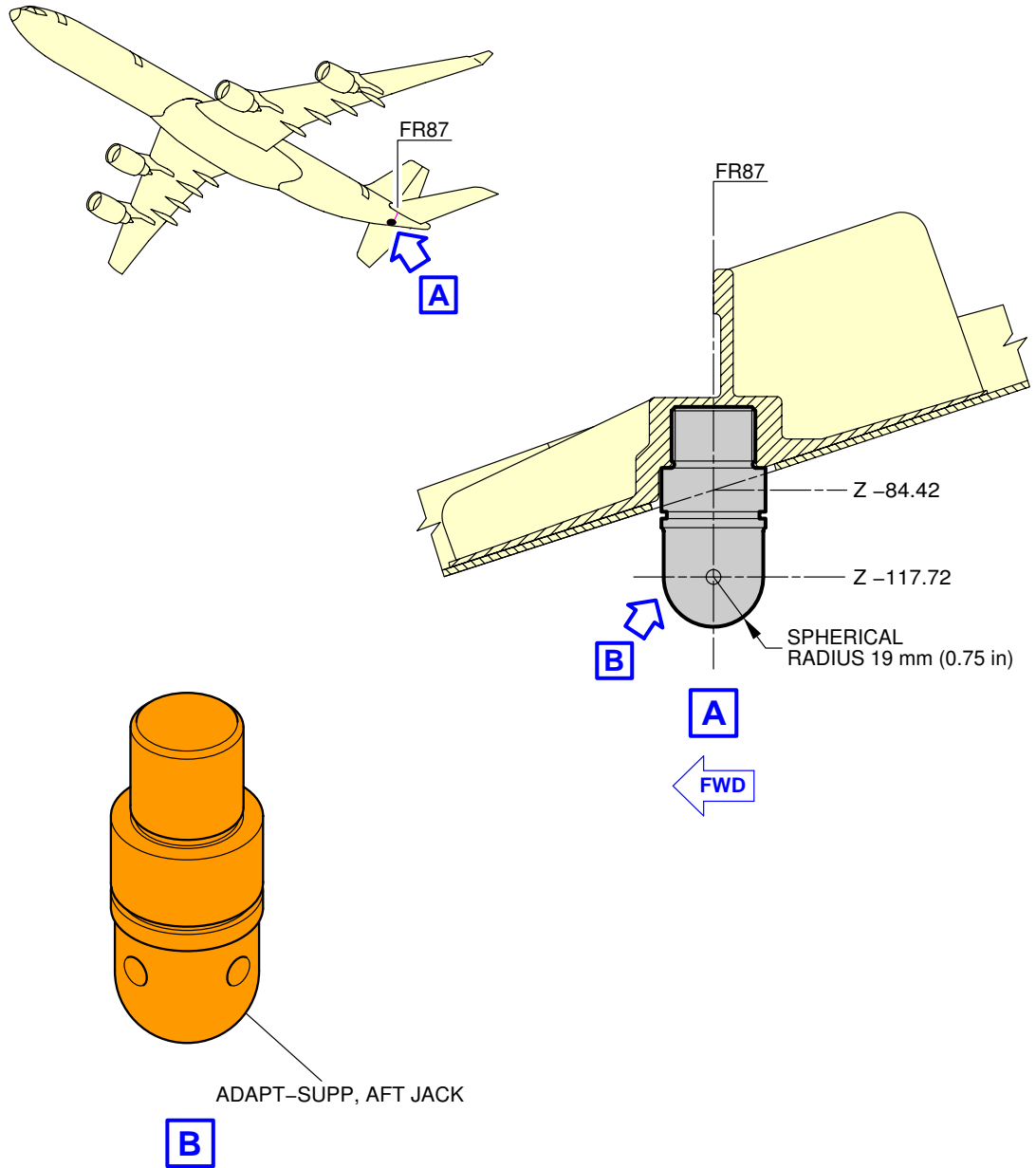

F_AC_021400_1_0180101_01_00

Jacking for Maintenance
Auxiliary Jacking Point - Safety Stay
FIGURE-2-14-0-991-018-A01

A340-500/-600

AIRCRAFT CHARACTERISTICS - AIRPORT AND MAINTENANCE PLANNING

**ON A/C A340-500

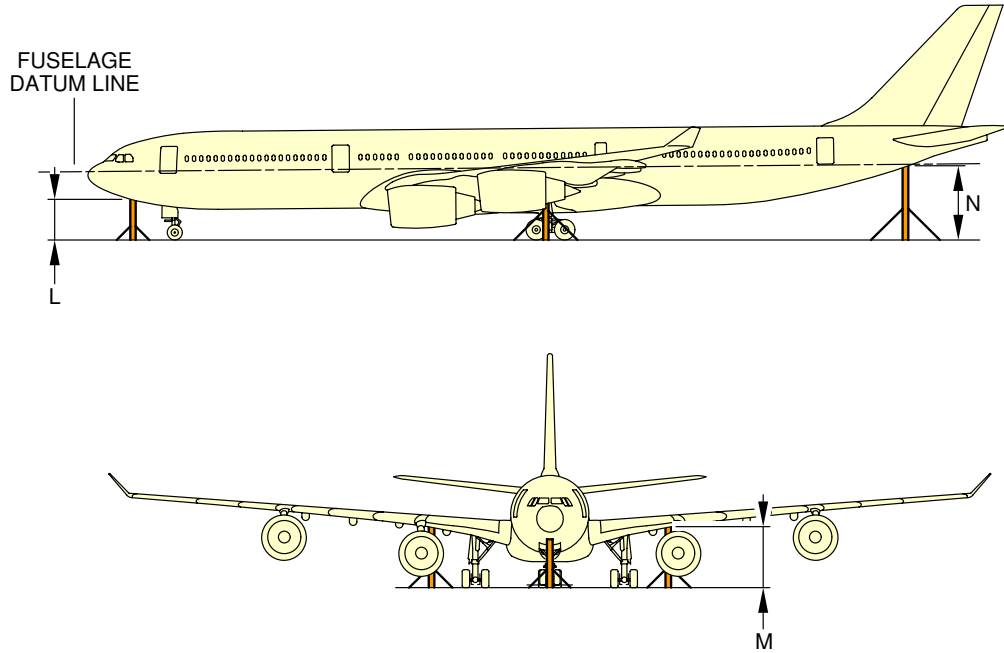

	L	M	N
AIRCRAFT ON WHEELS WITH STANDARD TIRES, MAX. JACK WEIGHT 200 000 kg (440 924 lb)	2.74 m (8.99 ft)	4.56 m (14.96 ft)	5.6 m (18.37 ft)
AIRCRAFT ON WHEELS WITH STANDARD TIRES, OEW 175 377 kg (386 640 lb)	2.74 m (8.99 ft)	4.56 m (14.96 ft)	5.6 m (18.37 ft)
AIRCRAFT ON WHEELS, SHOCK ABSORBERS DEFLATED AND FLAT TIRES	2.22 m (7.28 ft)	4.01 m (13.16 ft)	5.04 m (16.54 ft)
AIRCRAFT ON JACKS, FUSELAGE DATUM LINE PARALLEL TO GROUND AT 6.5 m (21.33 ft) FOR LANDING GEARS EXTENSION/RETRACTION	4.42 m (14.5 ft)	5.77 m (18.93 ft)	6.42 m (21.06 ft)
AIRCRAFT ON JACKS, FUSELAGE DATUM LINE PARALLEL TO GROUND AT 7.2 m (23.62 ft) FOR LANDING GEARS REMOVAL/INSTALLATION	5.12 m (16.8 ft)	6.47 m (16.8 ft)	7.12 m (16.8 ft)

F_AC_021400_1_0190101_01_00

Jacking for Maintenance
Jacking Dimensions
FIGURE-2-14-0-991-019-A01

A340-500/-600

AIRCRAFT CHARACTERISTICS - AIRPORT AND MAINTENANCE PLANNING

****ON A/C A340-600**

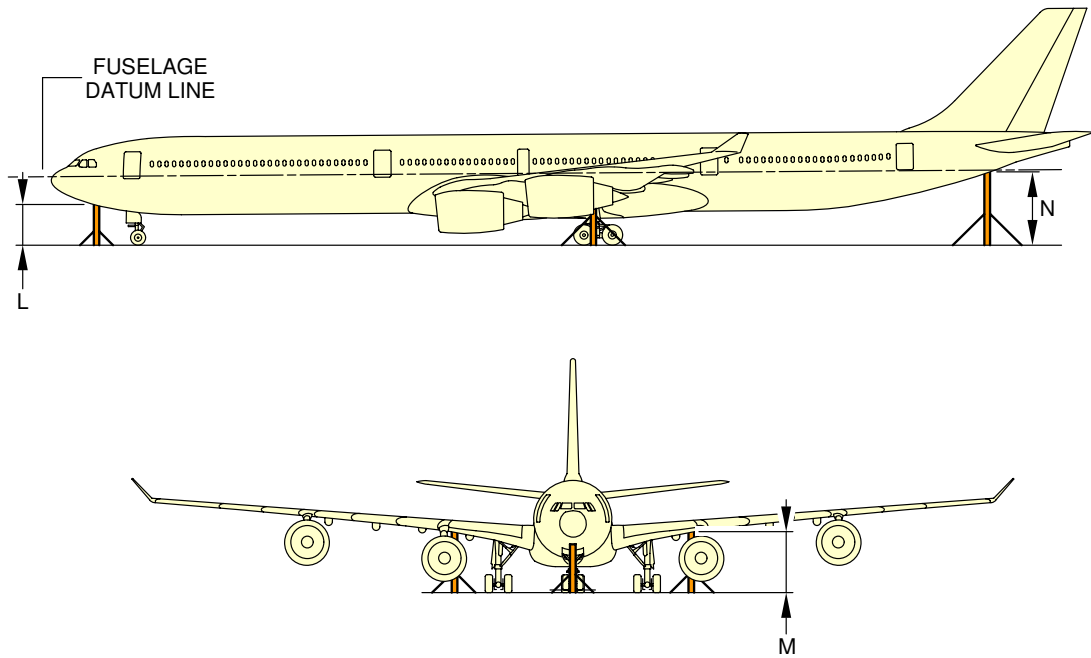

	L	M	N
AIRCRAFT ON WHEELS WITH STANDARD TIRES, MAX. JACK WEIGHT 200 000 kg (440 924 lb)	2.75 m (9.02 ft)	4.56 m (14.96 ft)	5.57 m (18.27 ft)
AIRCRAFT ON WHEELS WITH STANDARD TIRES, OEW 181 606 kg (400 373 lb)	2.75 m (9.02 ft)	4.56 m (14.96 ft)	5.46 m (17.91 ft)
AIRCRAFT ON WHEELS, SHOCK ABSORBERS DEFLATED AND FLAT TIRES	2.22 m (7.28 ft)	4.01 m (13.16 ft)	5 m (16.4 ft)
AIRCRAFT ON JACKS, FUSELAGE DATUM LINE PARALLEL TO GROUND AT 6.5 m (21.33 ft) FOR LANDING GEARS EXTENSION/RETRACTION	4.42 m (14.5 ft)	5.77 m (18.93 ft)	6.42 m (21.06 ft)
AIRCRAFT ON JACKS, FUSELAGE DATUM LINE PARALLEL TO GROUND AT 7.2 m (23.62 ft) FOR LANDING GEARS REMOVAL/INSTALLATION	5.12 m (16.8 ft)	6.47 m (21.23 ft)	7.12 m (23.36 ft)

F_AC_021400_1_0190201_01_00

Jacking for Maintenance
Jacking Dimensions
FIGURE-2-14-0-991-019-B01

A340-500/-600

AIRCRAFT CHARACTERISTICS - AIRPORT AND MAINTENANCE PLANNING

****ON A/C A340-500**

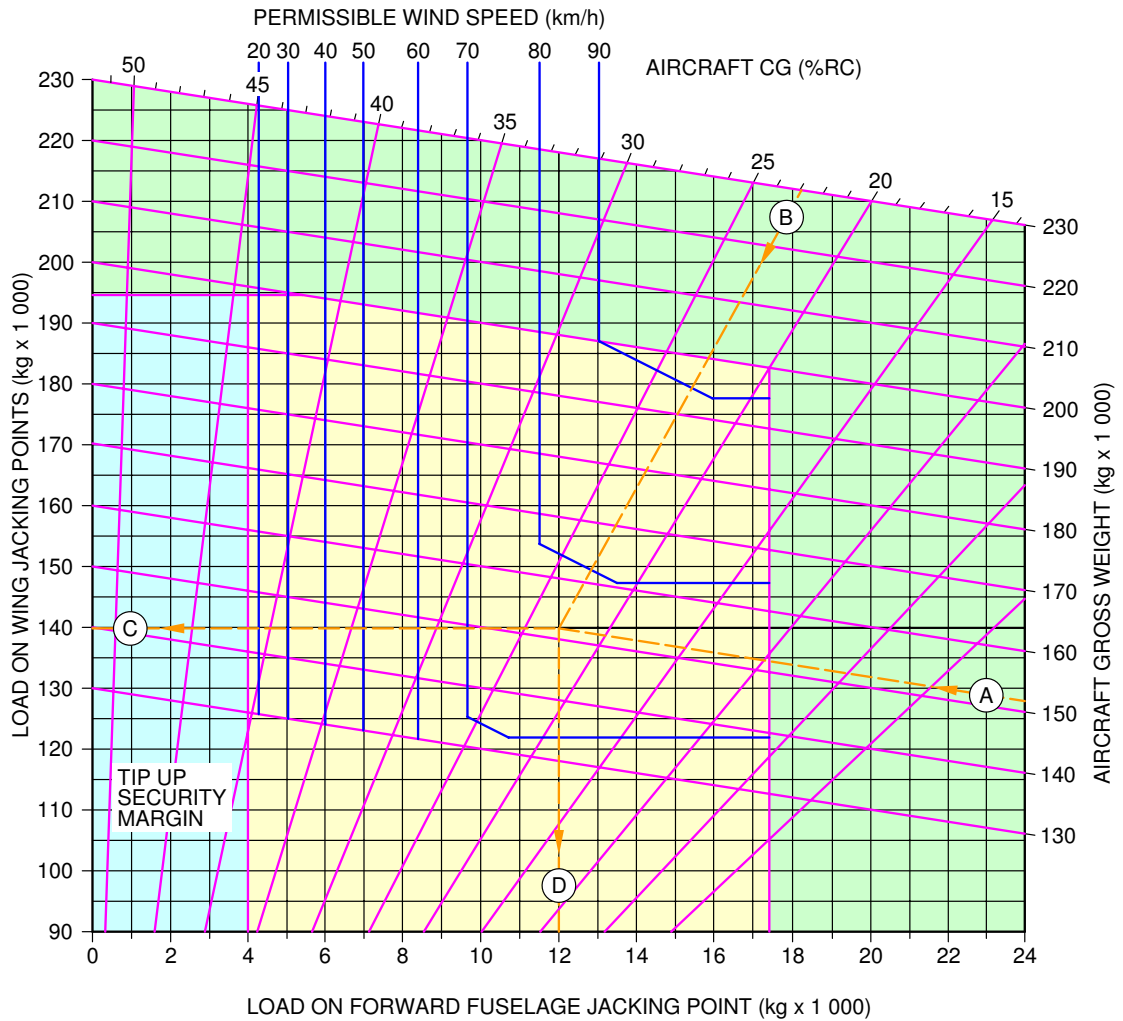

EXAMPLE:

ASSUME AIRCRAFT WITH A GROSS WEIGHT OF 152 000 kg (A) AND CENTER OF GRAVITY AT 23% RC (B). THE REACTION AT THE WING JACKING POINTS IS 140 000 kg (70 000 kg PER SIDE) (C) AND THE REACTION AT THE FORWARD FUSELAGE JACKING POINT IS 12 000 kg (D). IF THE AIRCRAFT MUST BE LIFTED OUTSIDE, THE WIND SPEED MUST NOT BE IN EXCESS OF 70 km/h.

F_AC_021400_1_0200101_01_00

Jacking for Maintenance
Load at the Aircraft Jacking Points
FIGURE-2-14-0-991-020-A01

A340-500/-600

AIRCRAFT CHARACTERISTICS - AIRPORT AND MAINTENANCE PLANNING

****ON A/C A340-600**

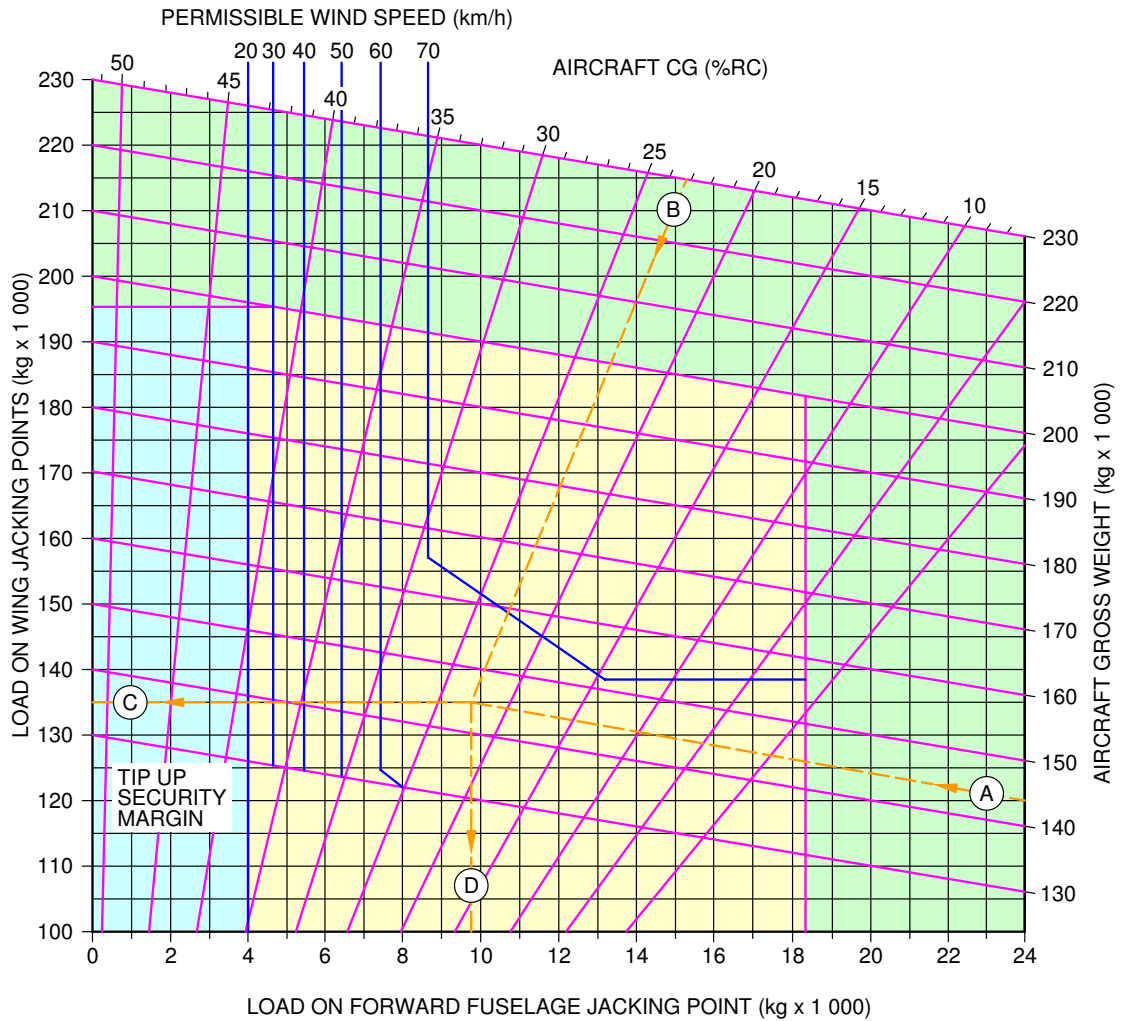

EXAMPLE:

ASSUME AIRCRAFT WITH A GROSS WEIGHT OF 143 500 kg (A) AND CENTER OF GRAVITY AT 23% RC (B). THE REACTION AT THE WING JACKING POINTS IS 134 000 kg (67 000 kg PER SIDE) (C) AND THE REACTION AT THE FORWARD FUSELAGE JACKING POINT IS 9 600 kg (D). IF THE AIRCRAFT MUST BE LIFTED OUTSIDE, THE WIND SPEED MUST NOT BE IN EXCESS OF 60 km/h.

F_AC_021400_1_0200201_01_00

Jacking for Maintenance
 Load at the Aircraft Jacking Points
 FIGURE-2-14-0-991-020-B01

2-14-1 Jacking of the Landing Gear****ON A/C A340-500 A340-600**Jacking of the Landing Gear

1. General

Landing gear jacking will be required to lift the landing gear wheels off the ground.

NOTE : You can lift the aircraft at Maximum Ramp Weight (MRW).

NOTE : The load at each jacking position is the load required to give 25.4 mm (1 in) clearance between the ground and the tire.

2. Main Gear Jacking

The main gears are normally jacked up by placing a jack directly under the ball pad.

The ball spherical radius is 19 mm (0.75 in).

It is also possible to jack the main gear using a cantilever jack.

3. Nose Gear Jacking

For nose gear jacking, a 19 mm (0.75 in) radius ball pad is fitted under the lower end of the shock-absorber sliding tube. Jacking can be accomplished either by placing a jack directly under the ball pad, or using an adapter fitting provided with an identical ball pad.

4. Center Gear Jacking

For center gear jacking, a 19 mm (0.75 in) radius ball pad is fitted under the lower end of the shock-absorber sliding tube. Jacking can be accomplished either by placing a jack directly under the ball pad, or using an adapter fitting provided with an identical ball pad.

A340-500/-600

AIRCRAFT CHARACTERISTICS - AIRPORT AND MAINTENANCE PLANNING

****ON A/C A340-500 A340-600**

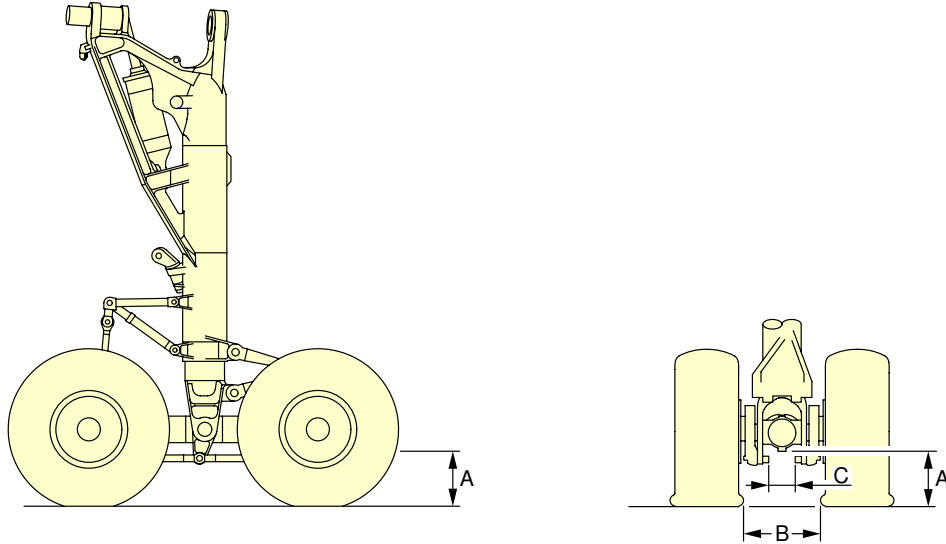

MLG JACKING

	CONFIGURATION	DIM.A	DIM.B	DIM.C	COMMENTS
1	4 INFLATED TIRES	367 mm (14.45 in)	> 697 mm (27.44 in)	347 mm (13.66 in)	ONLY FLAT TIRE DATA AVAILABLE
2	1 DEFLATED TIRE ON ANY AXLE	279 mm (10.98 in)	> 697 mm (27.44 in)	347 mm (13.66 in)	ONLY FLAT TIRE DATA AVAILABLE
3	2 DEFLATED TIRES ON DIFFERENT AXLES	279 mm (10.98 in)	> 697 mm (27.44 in)	347 mm (13.66 in)	ONLY FLAT TIRE DATA AVAILABLE
4A	2 DEFLATED TIRES ON THE SAME AXLE	165 mm (6.5 in)	> 697 mm (27.44 in)	347 mm (13.66 in)	ONLY FLAT TIRE DATA AVAILABLE
4B	2 RIMS ON THE SAME AXLE	100 mm (3.94 in)	> 697 mm (27.44 in)	347 mm (13.66 in)	
5A	3 DEFLATED TIRES	178 mm (7 in)	> 697 mm (27.44 in)	347 mm (13.66 in)	
5B	3 RIMS	113 mm (4.45 in)	> 697 mm (27.44 in)	347 mm (13.66 in)	
6A	4 DEFLATED TIRES	192 mm (7.56 in)	> 697 mm (27.44 in)	347 mm (13.66 in)	
6B	4 RIMS	134 mm (5.28 in)	> 697 mm (27.44 in)	347 mm (13.66 in)	DIM "A" DEFINED WITH FLANGES WORN BY 50%
7	MAXIMUM JACKING HEIGHT TO CHANGE WHEELS	570 mm (22.44 in)	842 mm (33.15 in)	347 mm (13.66 in)	WITH 25.4 mm (1 in) GROUND CLEARANCE

NOTE:

VALUES WITH 1 400 x 530 R23 TIRES ONLY.

F_AC_021401_1_0110102_01_00

Jacking of the Landing Gear
MLG Jacking Point Heights
FIGURE-2-14-1-991-011-A01

A340-500/-600

AIRCRAFT CHARACTERISTICS - AIRPORT AND MAINTENANCE PLANNING

****ON A/C A340-500 A340-600**

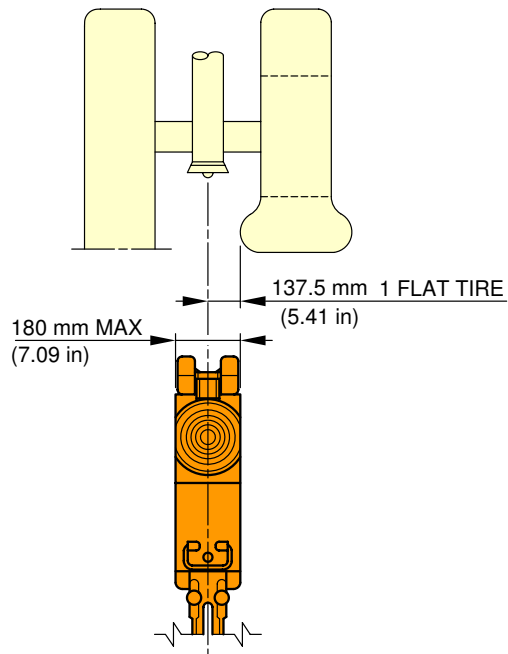
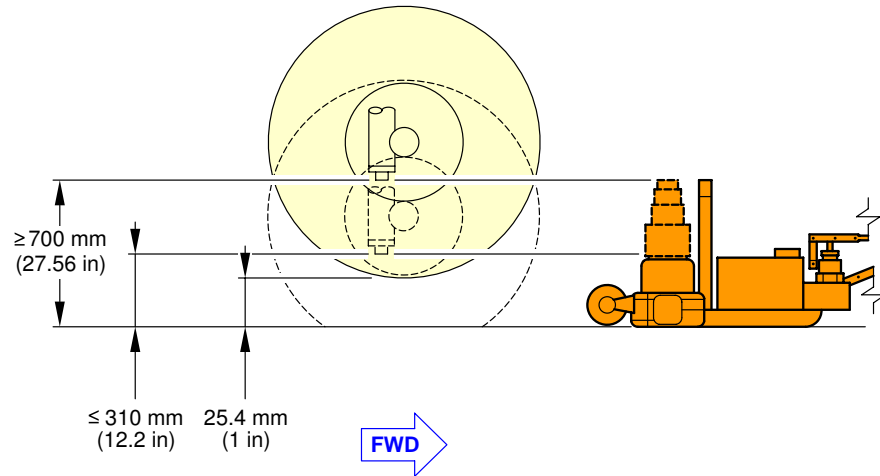

F_AC_021401_1_0120101_01_00

Jacking of the Landing Gear
Jacking of the NLG (Sheet 1 of 2)
FIGURE-2-14-1-991-012-A01

A340-500/-600

AIRCRAFT CHARACTERISTICS - AIRPORT AND MAINTENANCE PLANNING

**ON A/C A340-500 A340-600

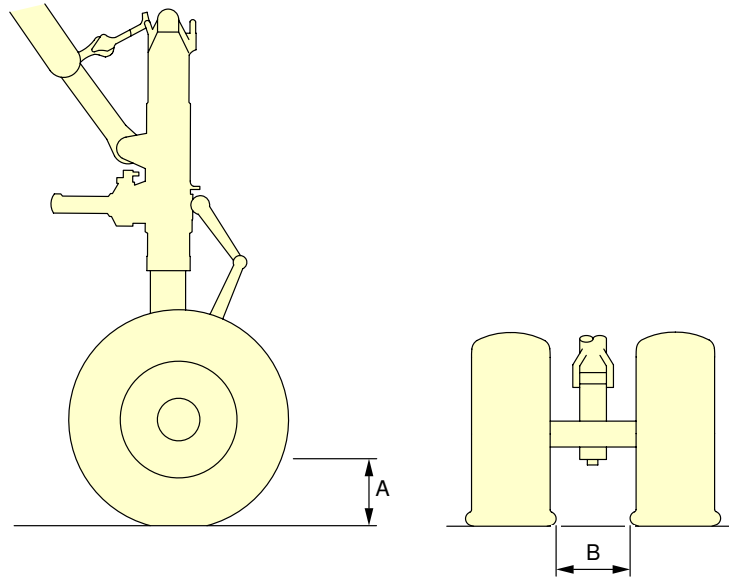

NLG JACKING

	CONFIGURATION	DIM.A	DIM.B	COMMENTS
1	2 INFLATED TIRES	340 mm (13.39 in)	304 mm (11.97 in)	
2	1 DEFLATED TIRE	183 mm (7.2 in)	249 mm (9.8 in)	
3	2 DEFLATED TIRES	255 mm (10.04 in)	275 mm (10.83 in)	
4	ON 2 RIMS	244 mm (9.61 in)	382 mm (15.04 in)	DIM "A" DEFINED WITH FLANGES WORN BY 50%
5	MAXIMUM JACKING HEIGHT TO CHANGE WHEELS	475 mm (18.7 in)	N/A	WITH 25.4 mm (1 in) GROUND CLEARANCE

NOTE:

VALUES WITH 45 x 18 R17 TIRES ONLY.

F_AC_021401_1_0120102_01_00

Jacking of the Landing Gear
NLG Jacking Point Heights (Sheet 2 of 2)
FIGURE-2-14-1-991-012-A01

A340-500/-600

AIRCRAFT CHARACTERISTICS - AIRPORT AND MAINTENANCE PLANNING

**ON A/C A340-500 A340-600

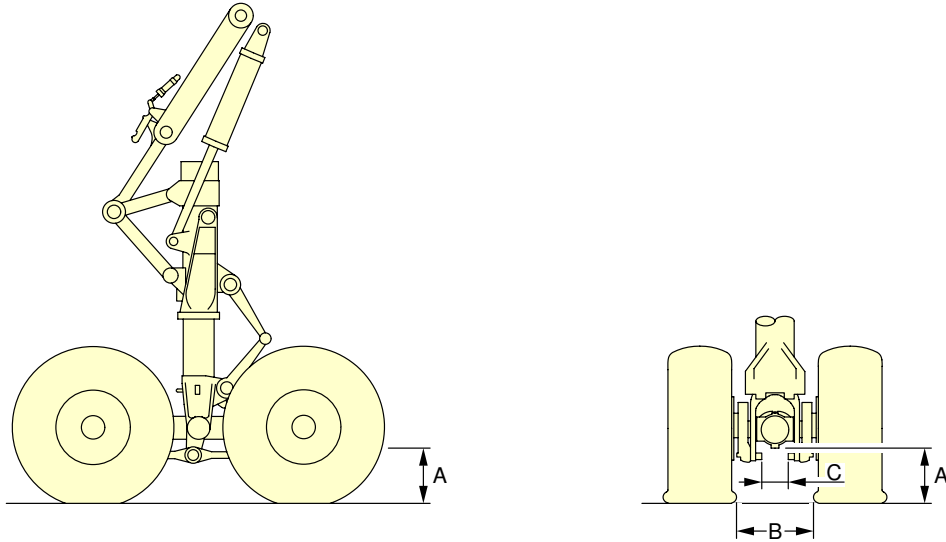

CLG JACKING

	CONFIGURATION	DIM.A	DIM.B	DIM.C	COMMENTS
1	4 INFLATED TIRES	380 mm (14.96 in)	> 476 mm (18.74 in)	N/A	ONLY FLAT TIRE DATA AVAILABLE
2	1 DEFLATED TIRE ON ANY AXLE	292 mm (11.5 in)	> 476 mm (18.74 in)	N/A	ONLY FLAT TIRE DATA AVAILABLE
3	2 DEFLATED TIRES ON DIFFERENT AXLES	292 mm (11.5 in)	> 476 mm (18.74 in)	N/A	ONLY FLAT TIRE DATA AVAILABLE
4A	2 DEFLATED TIRES ON THE SAME AXLE	199 mm (7.83 in)	> 476 mm (18.74 in)	N/A	ONLY FLAT TIRE DATA AVAILABLE
4B	2 RIMS ON THE SAME AXLE	134 mm (5.28 in)	> 476 mm (18.74 in)	N/A	
5A	3 DEFLATED TIRES	212 mm (8.35 in)	> 476 mm (18.74 in)	N/A	
5B	3 RIMS	147 mm (5.79 in)	> 476 mm (18.74 in)	N/A	
6A	4 DEFLATED TIRES	226 mm (8.9 in)	> 476 mm (18.74 in)	N/A	
6B	4 RIMS	168 mm (6.61 in)	> 476 mm (18.74 in)	N/A	DIM "A" DEFINED WITH FLANGES WORN BY 50%
7	MAXIMUM JACKING HEIGHT TO CHANGE WHEELS	653 mm (25.71 in)	621 mm (24.45 in)	N/A	WITH 25.4 mm (1 in) GROUND CLEARANCE

NOTE:

VALUES WITH 1 400 x 530 R23 TIRES ONLY.

F_AC_021401_1_0130101_01_00

Jacking of the Landing Gear
CLG Jacking Point Heights
FIGURE-2-14-1-991-013-A01

A340-500/-600

AIRCRAFT CHARACTERISTICS - AIRPORT AND MAINTENANCE PLANNING

**ON A/C A340-600

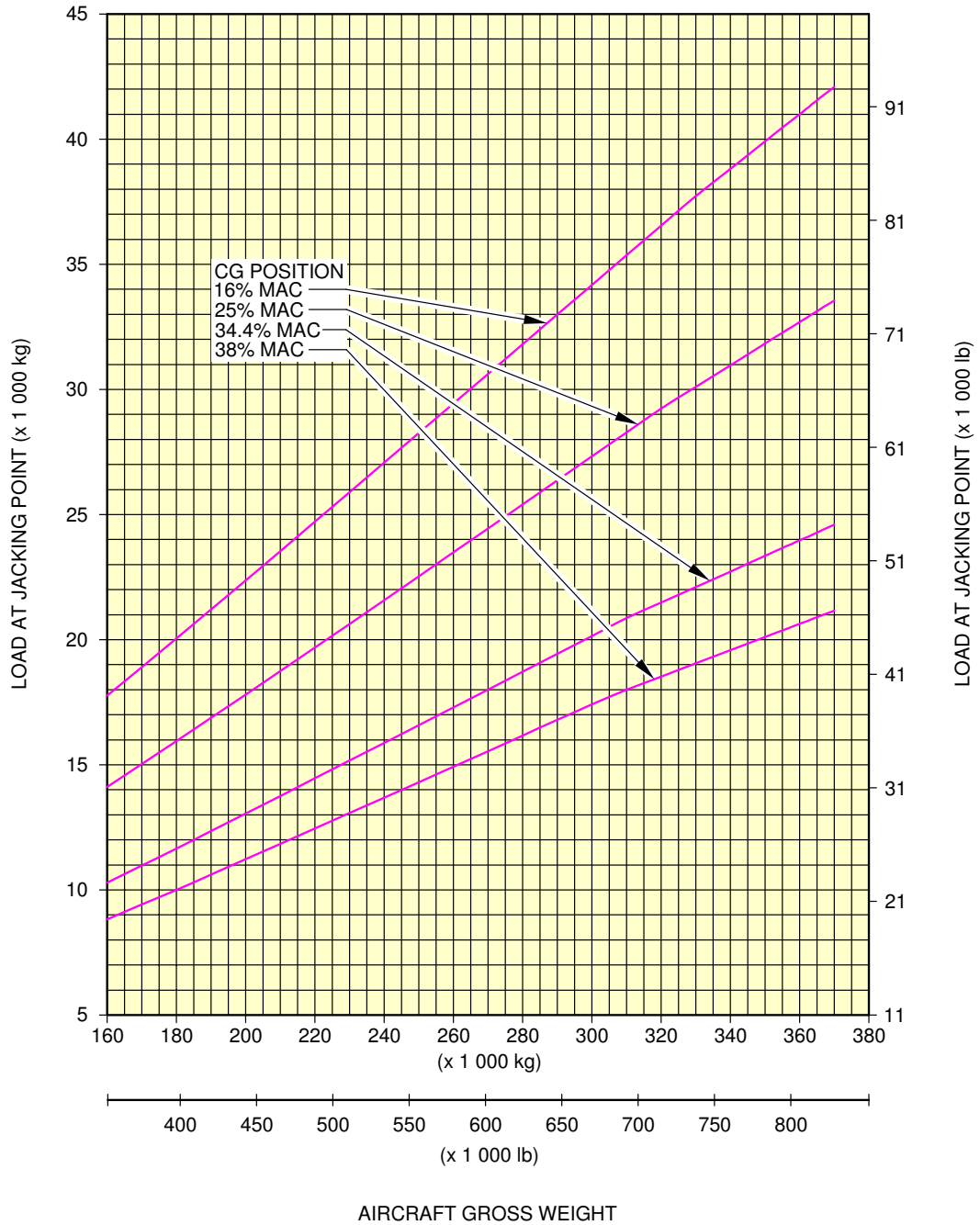

F_AC_021401_1_0140101_01_00

Jacking of the Landing Gear
 NLG Jacking Point Loads - (WV 001)
 FIGURE-2-14-1-991-014-A01

A340-500/-600

AIRCRAFT CHARACTERISTICS - AIRPORT AND MAINTENANCE PLANNING

**ON A/C A340-600

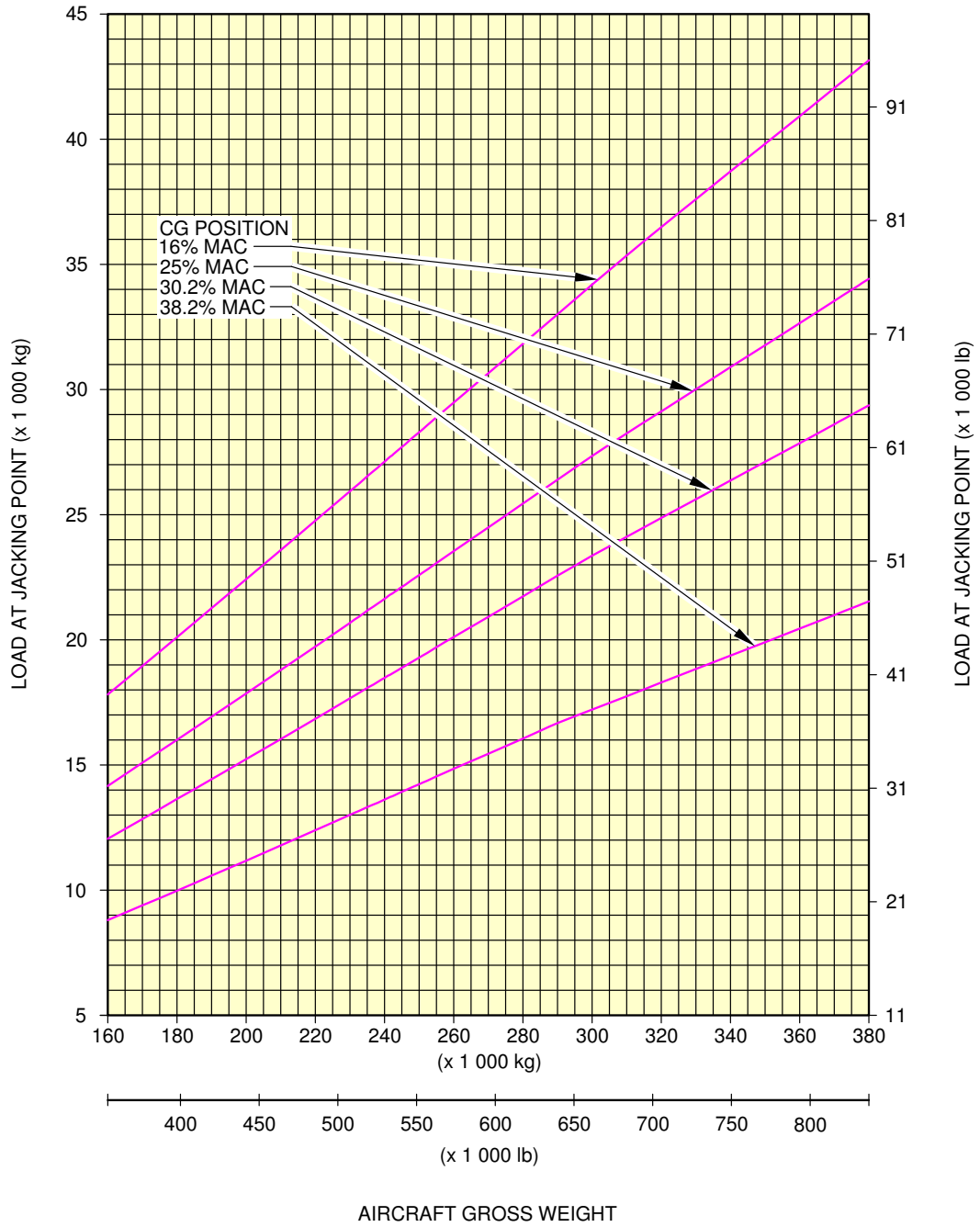

F_AC_021401_1_0150101_01_00

Jacking of the Landing Gear
 NLG Jacking Point Loads - (WV 101)
 FIGURE-2-14-1-991-015-A01

A340-500/-600

AIRCRAFT CHARACTERISTICS - AIRPORT AND MAINTENANCE PLANNING

**ON A/C A340-600

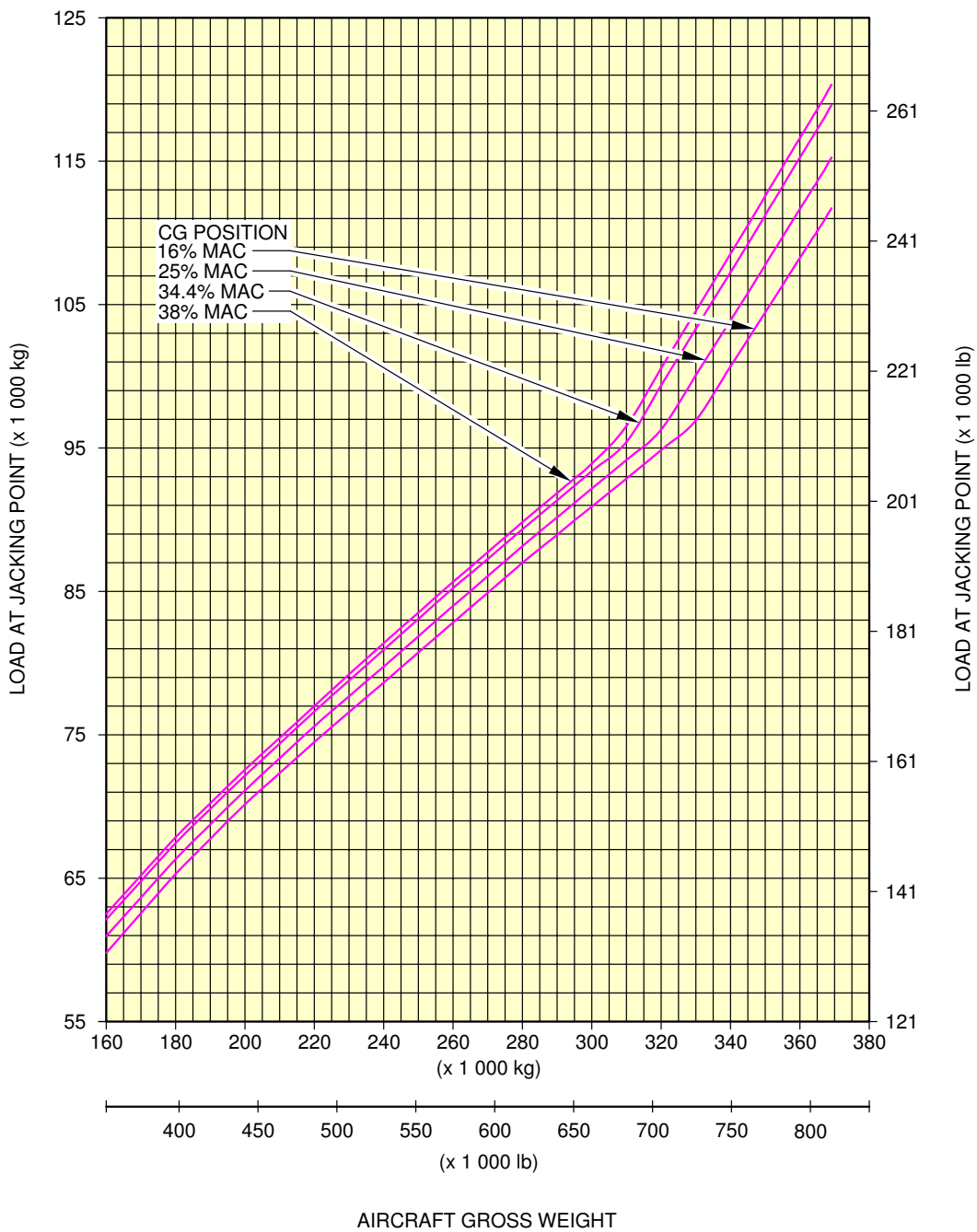

F_AC_021401_1_0160101_01_00

Jacking of the Landing Gear
MLG Jacking Point Loads - (WV 001)
FIGURE-2-14-1-991-016-A01

A340-500/-600

AIRCRAFT CHARACTERISTICS - AIRPORT AND MAINTENANCE PLANNING

**ON A/C A340-600

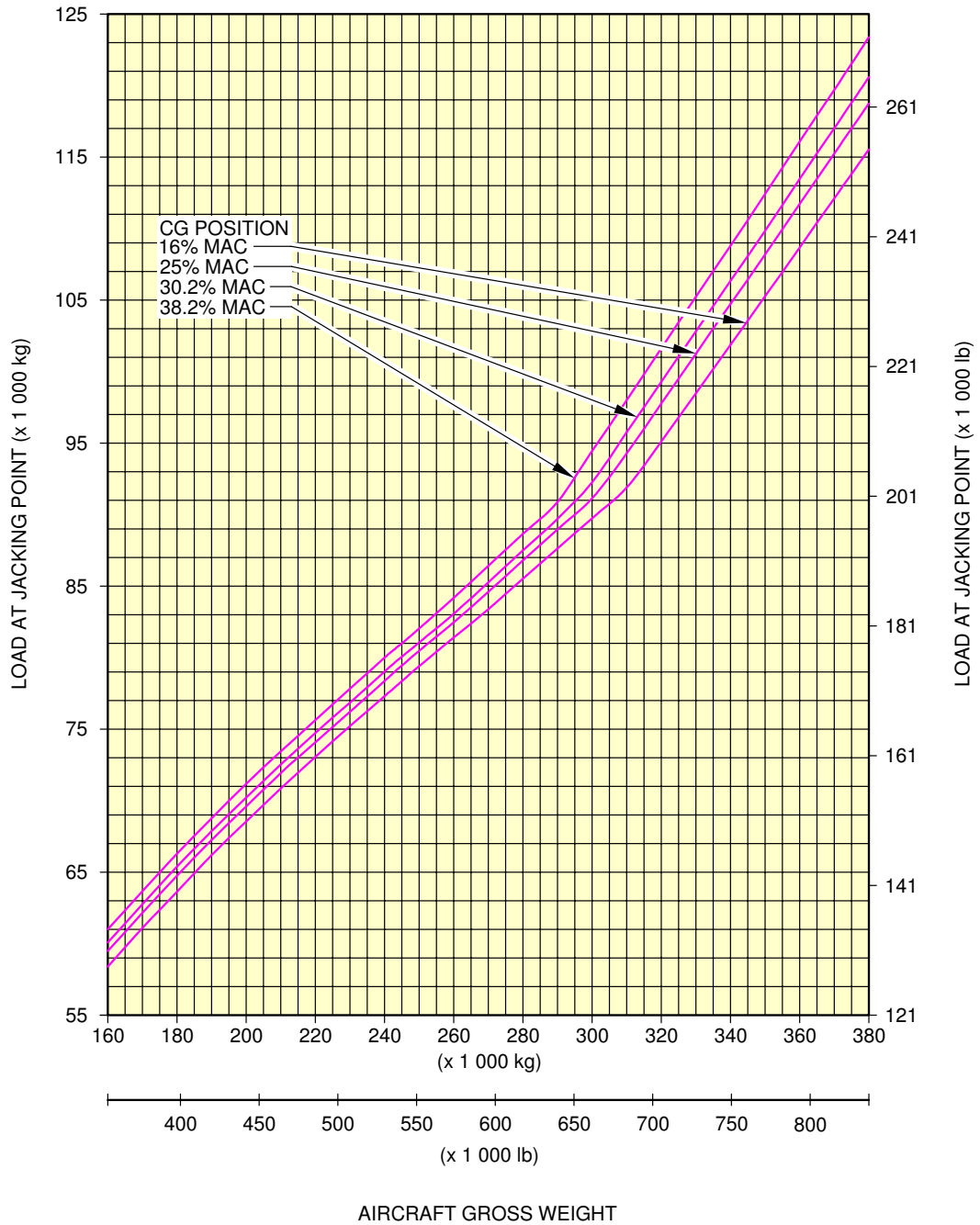

F_AC_021401_1_0170101_01_00

Jacking of the Landing Gear
MLG Jacking Point Loads - (WV 101)
FIGURE-2-14-1-991-017-A01

A340-500/-600

AIRCRAFT CHARACTERISTICS - AIRPORT AND MAINTENANCE PLANNING

**ON A/C A340-600

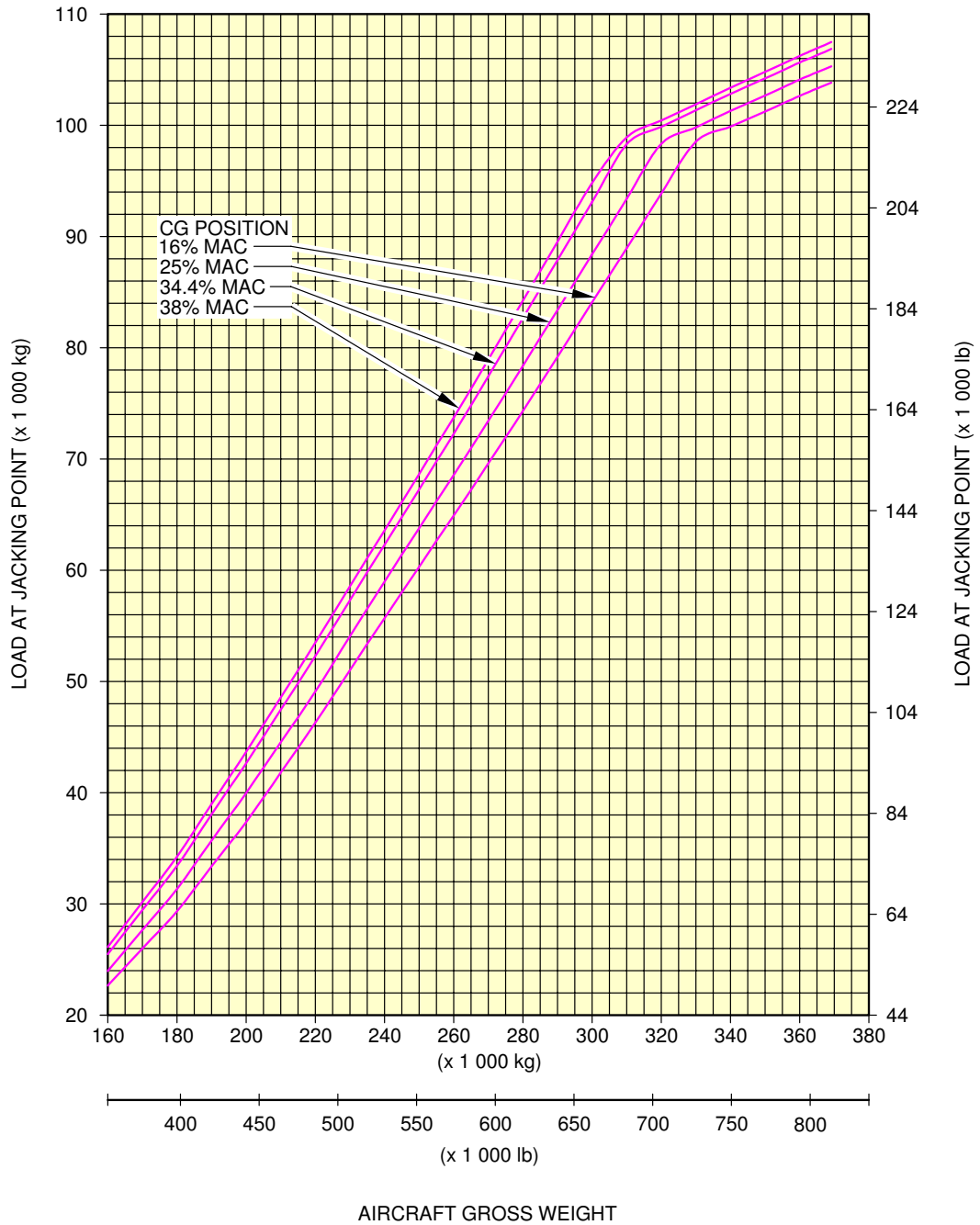

F_AC_021401_1_0180101_01_00

Jacking of the Landing Gear
CLG Jacking Point Loads - (WV 001)
FIGURE-2-14-1-991-018-A01

A340-500/-600

AIRCRAFT CHARACTERISTICS - AIRPORT AND MAINTENANCE PLANNING

**ON A/C A340-600

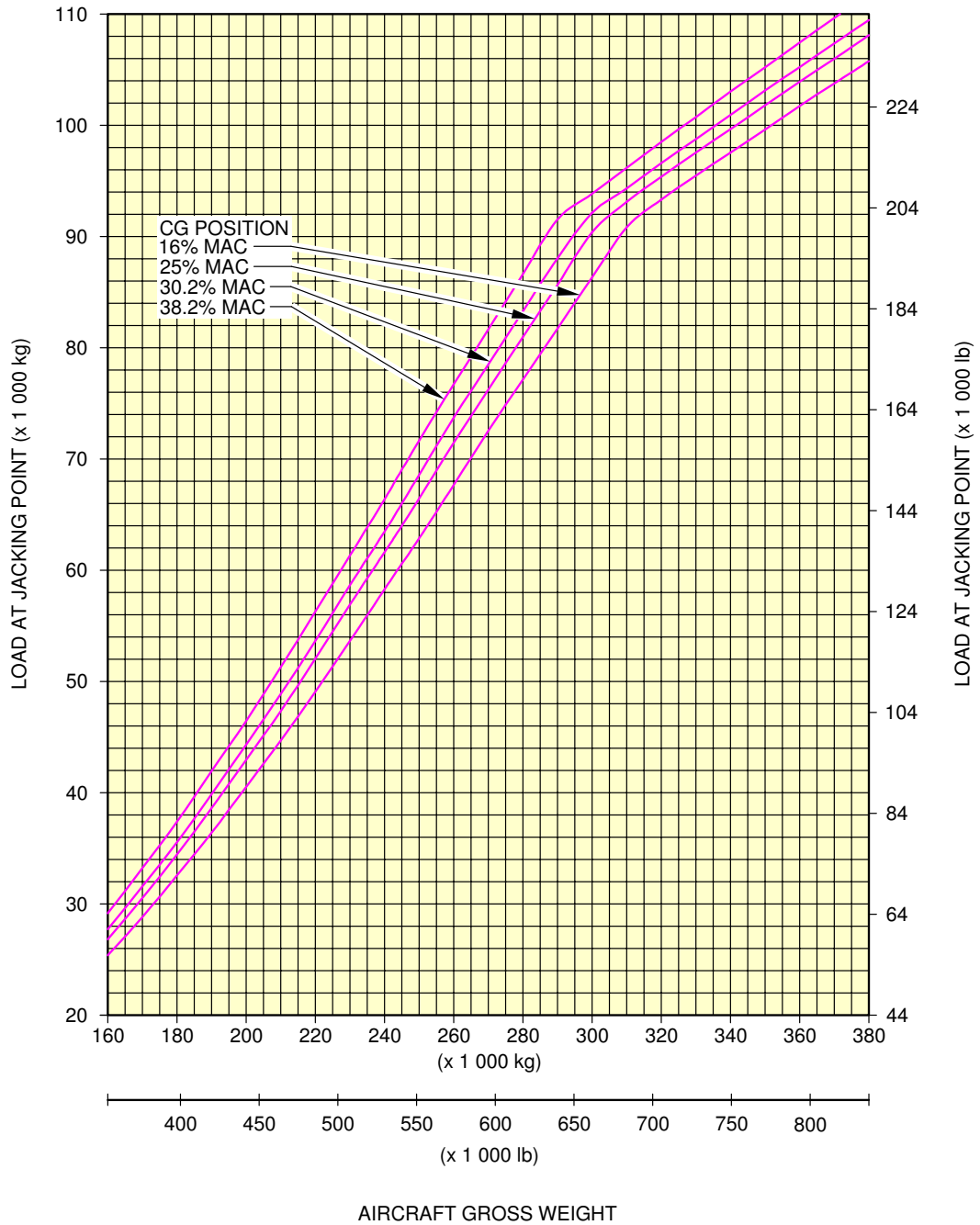

F_AC_021401_1_0190101_01_00

Jacking of the Landing Gear
 CLG Jacking Point Loads - (WV 101)
 FIGURE-2-14-1-991-019-A01

A340-500/-600

AIRCRAFT CHARACTERISTICS - AIRPORT AND MAINTENANCE PLANNING

**ON A/C A340-500

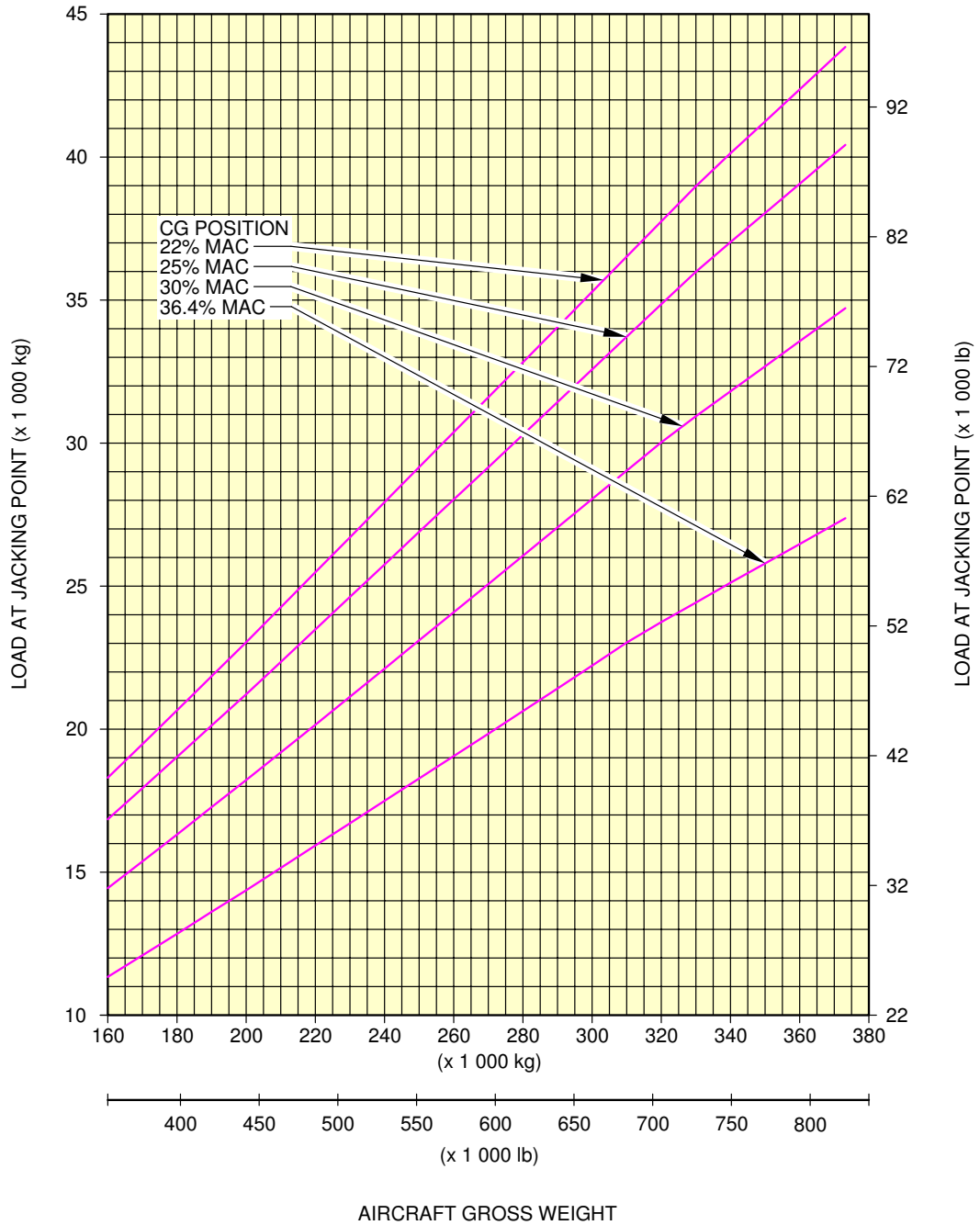

F_AC_021401_1_0200101_01_00

Jacking of the Landing Gear
 NLG Jacking Point Loads - (WV 001)
 FIGURE-2-14-1-991-020-A01

A340-500/-600

AIRCRAFT CHARACTERISTICS - AIRPORT AND MAINTENANCE PLANNING

**ON A/C A340-500

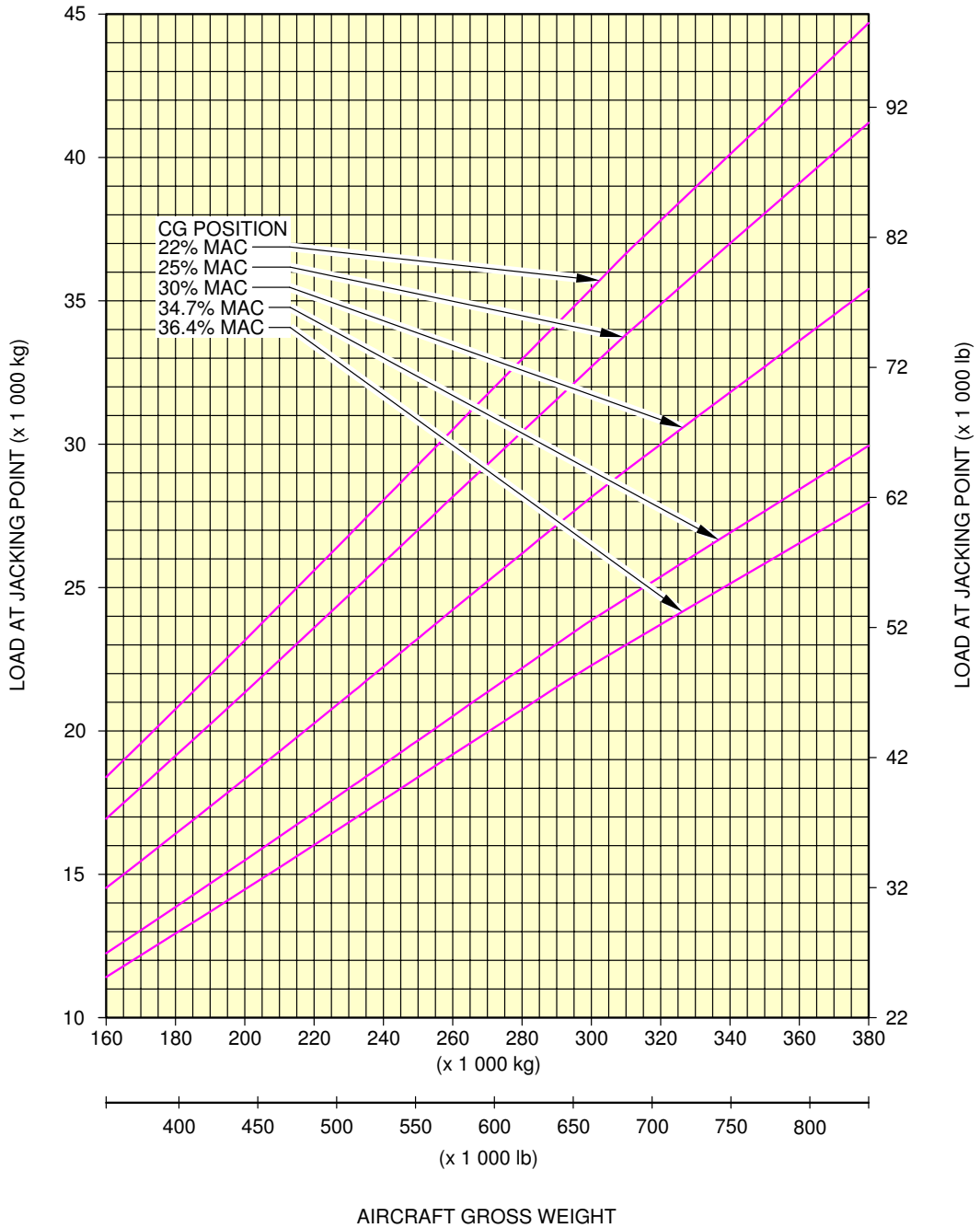

F_AC_021401_1_0210101_01_00

Jacking of the Landing Gear
NLG Jacking Point Loads - (WV 101)
FIGURE-2-14-1-991-021-A01

A340-500/-600

AIRCRAFT CHARACTERISTICS - AIRPORT AND MAINTENANCE PLANNING

**ON A/C A340-500

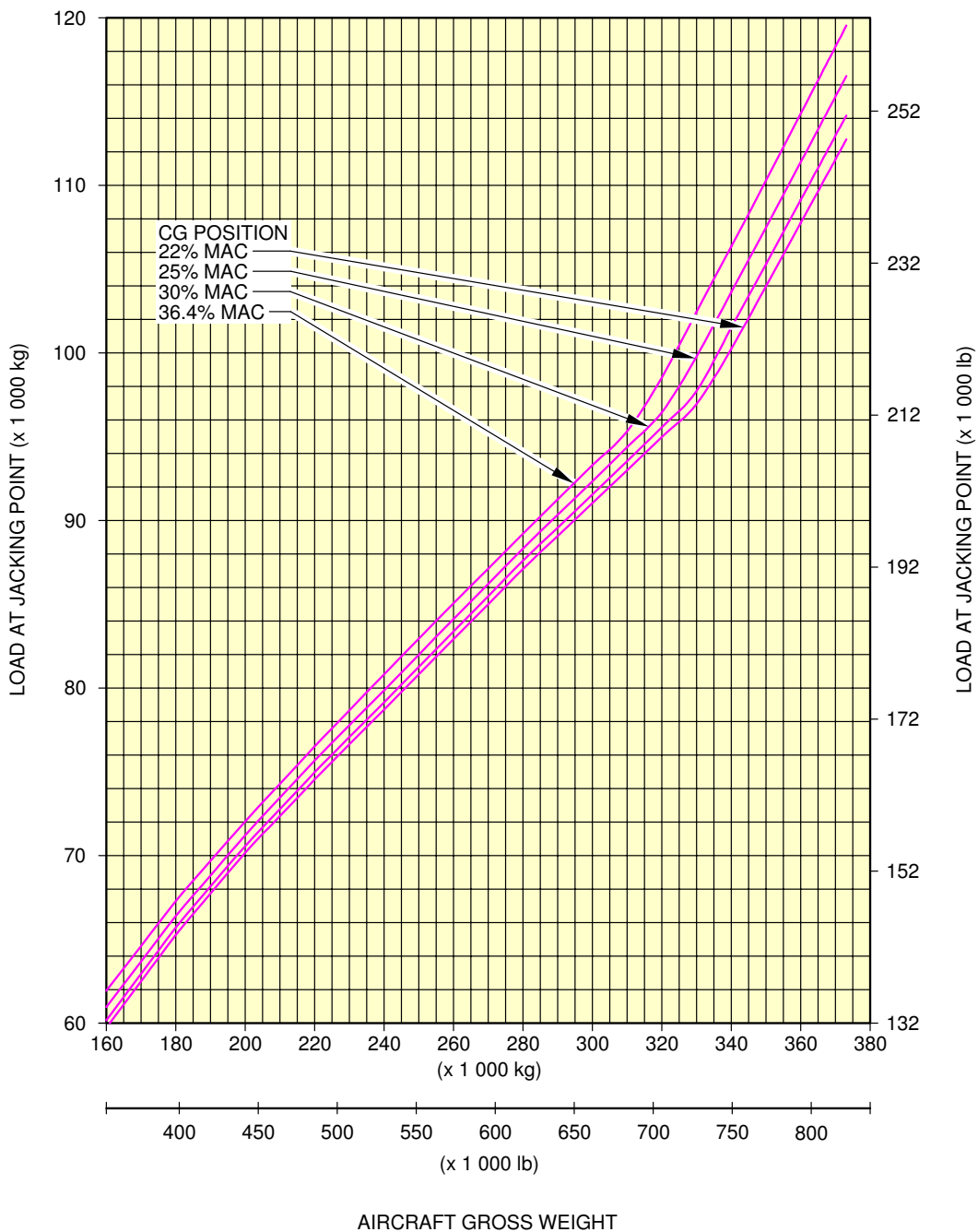

F_AC_021401_1_0220101_01_00

Jacking of the Landing Gear
MLG Jacking Point Loads - (WV 001)
FIGURE-2-14-1-991-022-A01

A340-500/-600

AIRCRAFT CHARACTERISTICS - AIRPORT AND MAINTENANCE PLANNING

****ON A/C A340-500**

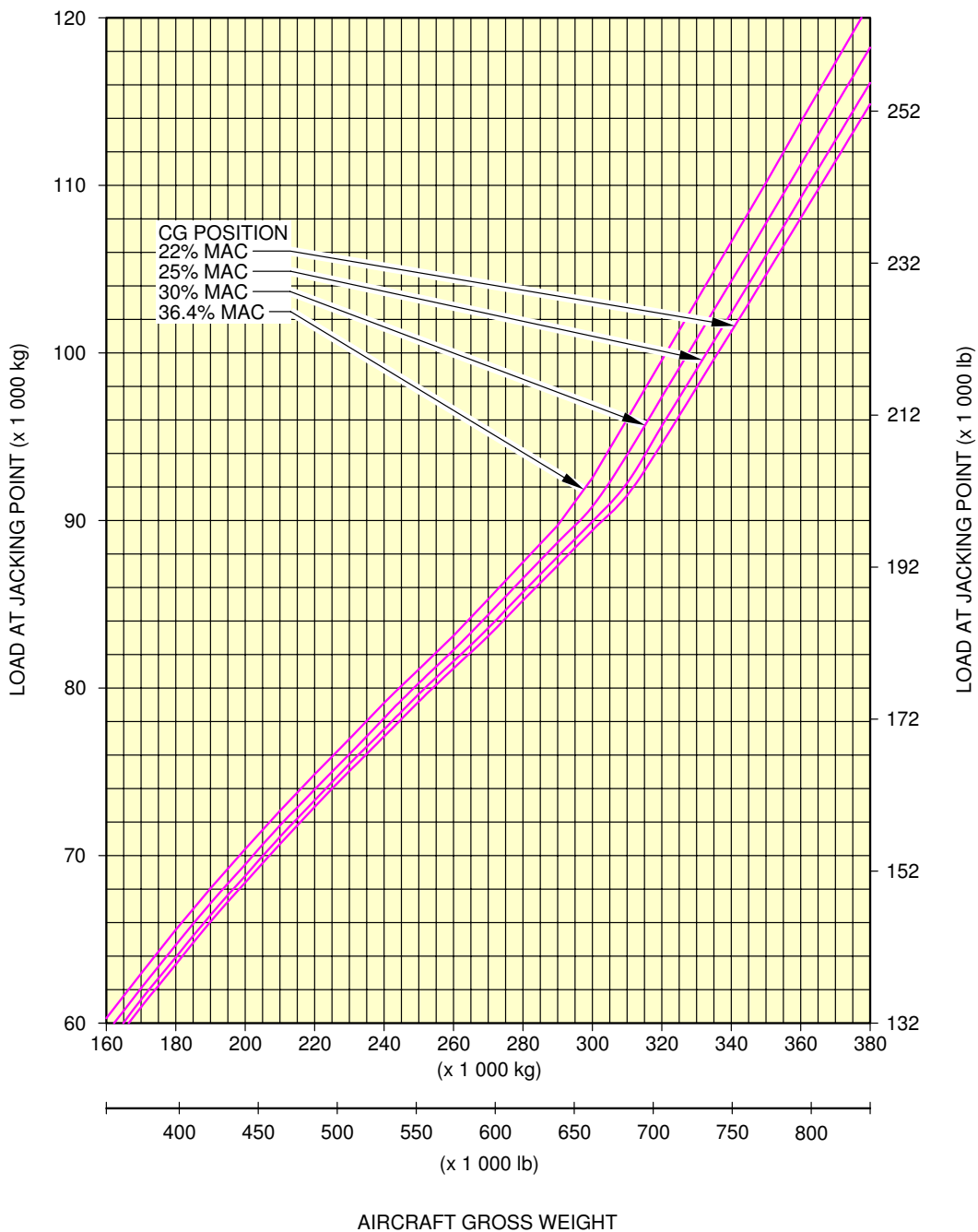

F_AC_021401_1_0230101_01_00

Jacking of the Landing Gear
MLG Jacking Point Loads - (WV 101)
FIGURE-2-14-1-991-023-A01

A340-500/-600

AIRCRAFT CHARACTERISTICS - AIRPORT AND MAINTENANCE PLANNING

**ON A/C A340-500

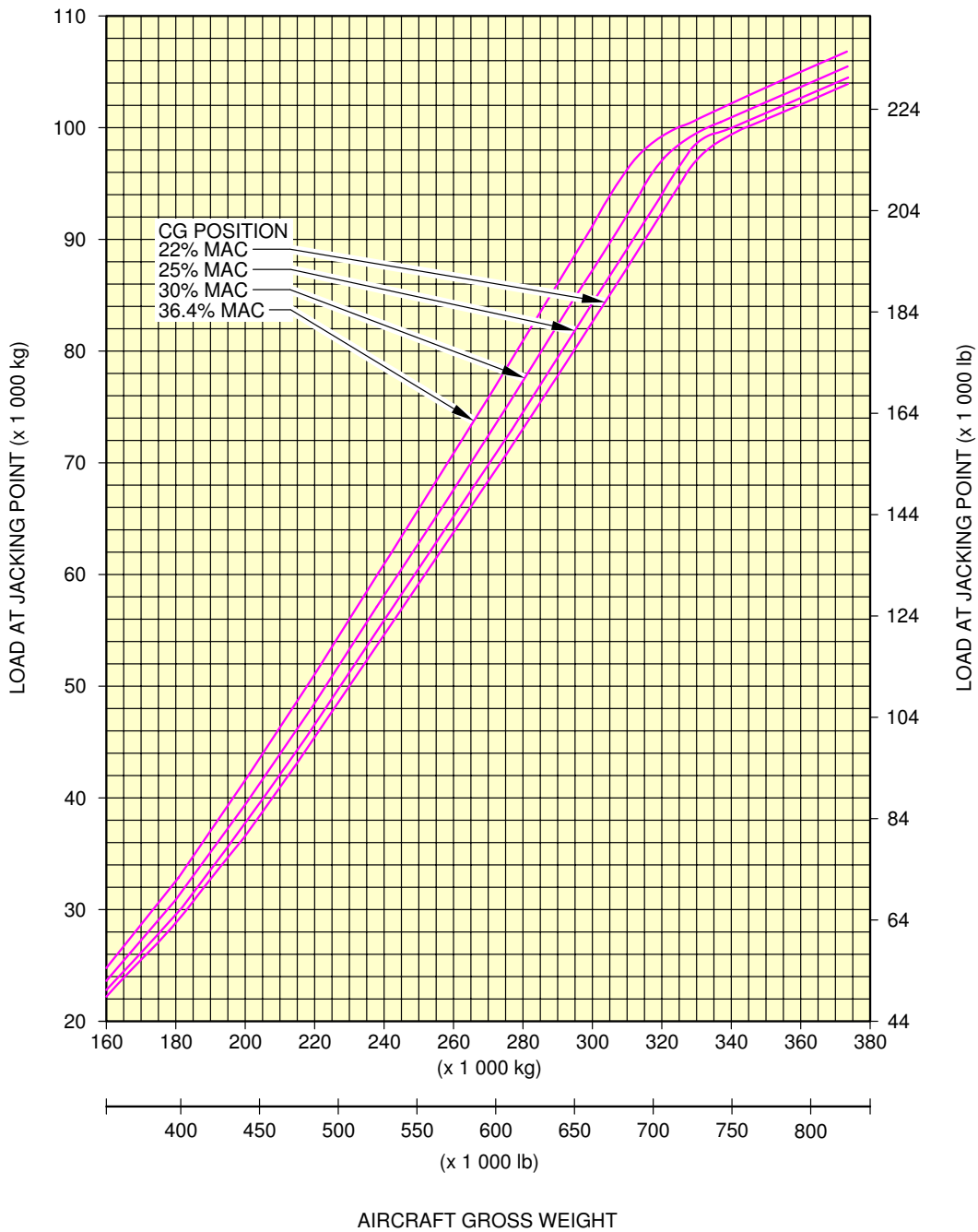

F_AC_021401_1_0240101_01_00

Jacking of the Landing Gear
CLG Jacking Point Loads - (WV 001)
FIGURE-2-14-1-991-024-A01

A340-500/-600

AIRCRAFT CHARACTERISTICS - AIRPORT AND MAINTENANCE PLANNING

**ON A/C A340-500

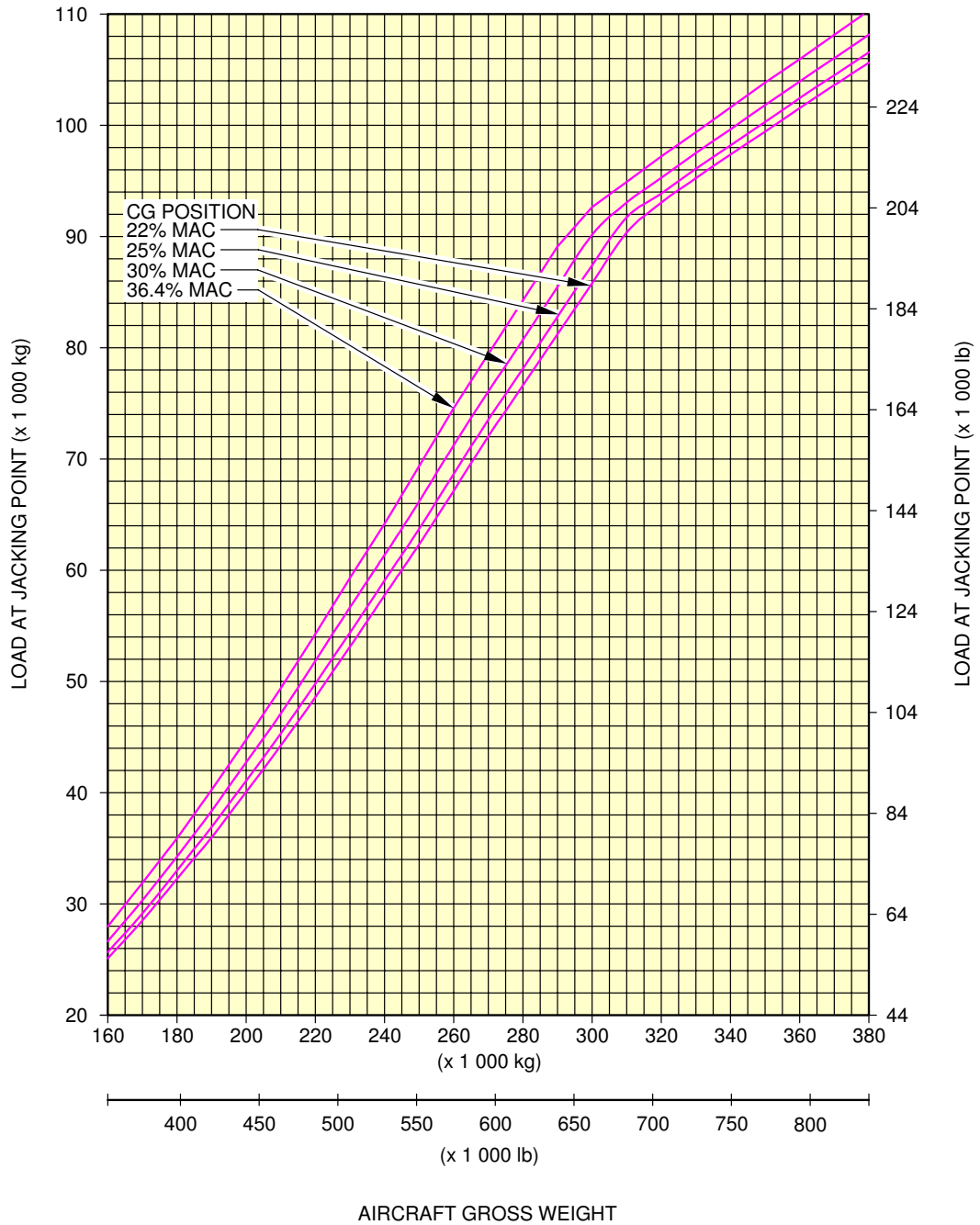

F_AC_021401_1_0250101_01_00

Jacking of the Landing Gear
CLG Jacking Point Loads - (WV 101)
FIGURE-2-14-1-991-025-A01

2-14-2 Support of Aircraft

****ON A/C A340-500 A340-600**

Support of Aircraft

1. Support of Aircraft

When it is necessary to support the aircraft in order to relieve the loads on the structure for the accomplishment of modifications or major work, it is advisable to provide adapters under the wings and the fuselage for an alternative means of lifting.

The aircraft must not be lifted or supported by the wings or fuselage alone. It is important to support the aircraft fuselage and wings at the same time to prevent structural damage.

A. Shoring Cradles

Shoring cradles are used when it is necessary to stress-jack the aircraft to carry out maintenance and repair work. These are used to oppose the deflections of the wings and reduce the stresses to an acceptable level at the area of maintenance and repair.

The shoring cradles, each with two adjustable pads, 152.4 mm (6 in) square, are positioned at four locations under each wing.

The adjustable pads are faced with thin rubber and are in contact with the wing profile at the datum intersections of the ribs and the front and rear spars (F/S and R/S).

A340-500/-600

AIRCRAFT CHARACTERISTICS - AIRPORT AND MAINTENANCE PLANNING

**ON A/C A340-500

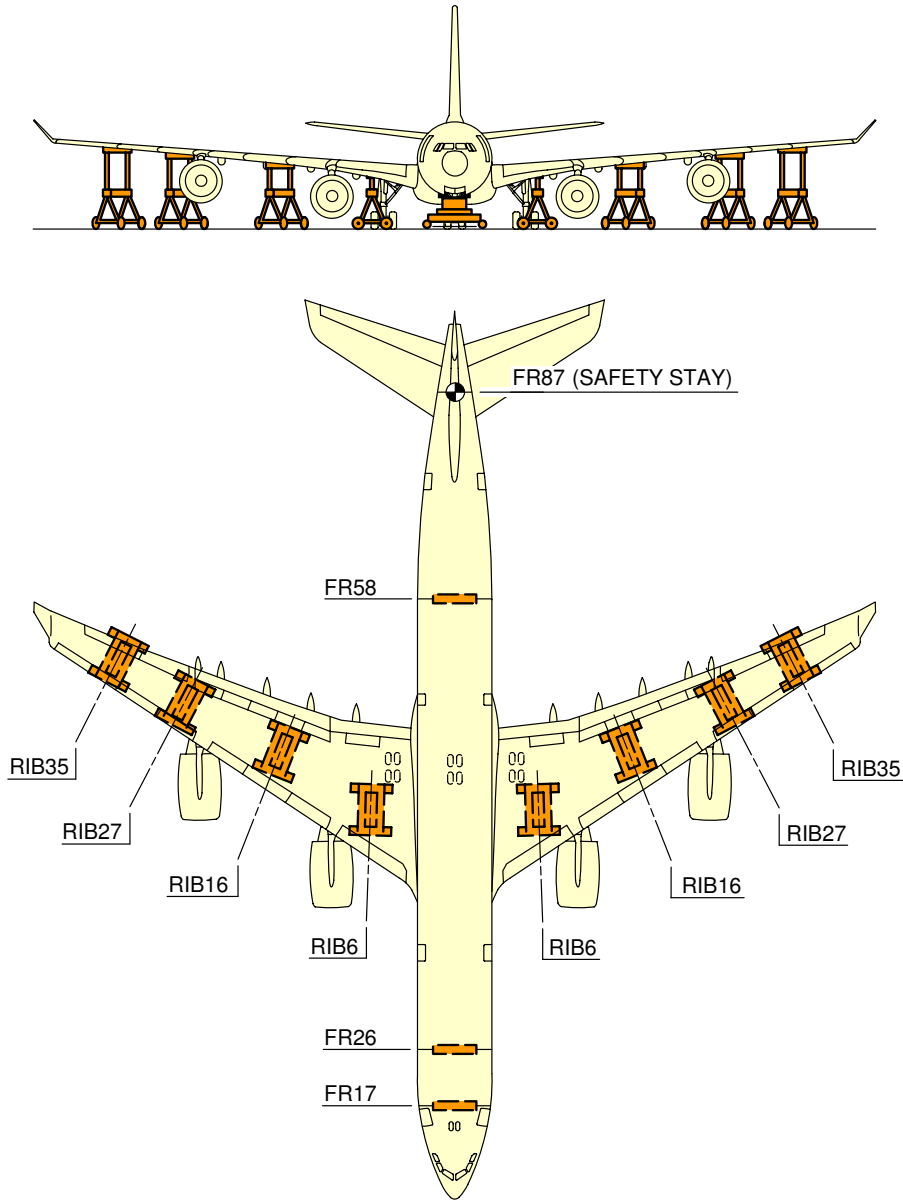

NOTE:

THE SHORING CRADLE MUST BE INSTALLED AT THE EXACT LOCATION OF THE FRAME.

F_AC_021402_1_0030101_01_00

Support of Aircraft
Location of Shoring Cradles (Sheet 1 of 2)
FIGURE-2-14-2-991-003-A01

A340-500/-600

AIRCRAFT CHARACTERISTICS - AIRPORT AND MAINTENANCE PLANNING

**ON A/C A340-500

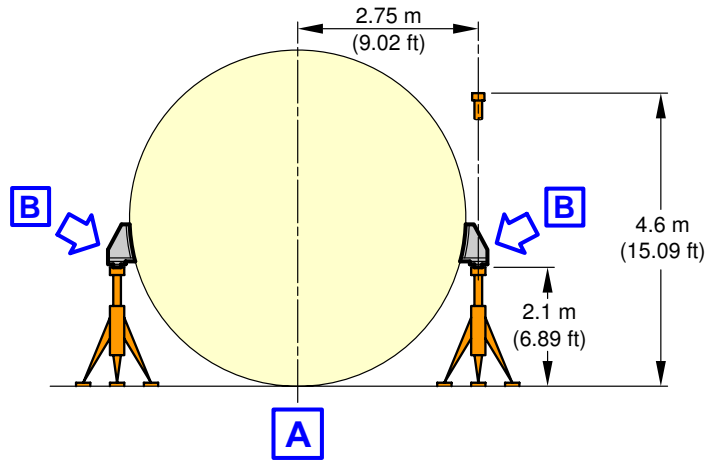
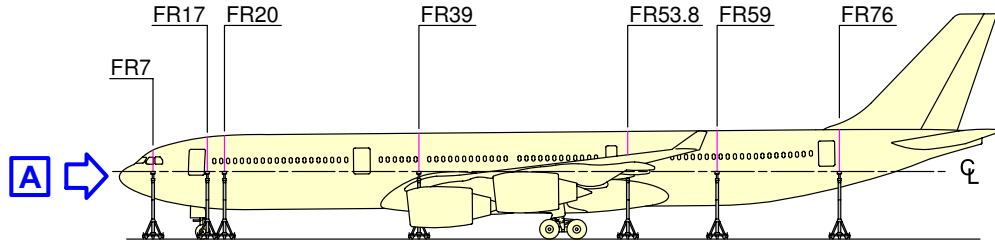

EXAMPLE

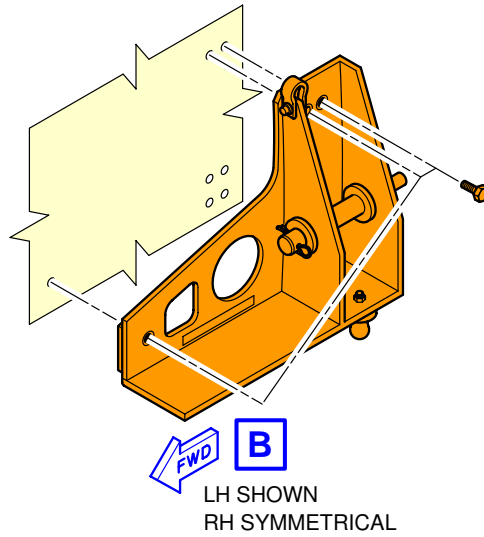

F_AC_021402_1_0030102_01_00

Support of Aircraft
Location of Auxiliary Jacking Points (Sheet 2 of 2)
FIGURE-2-14-2-991-003-A01

A340-500/-600

AIRCRAFT CHARACTERISTICS - AIRPORT AND MAINTENANCE PLANNING

**ON A/C A340-600

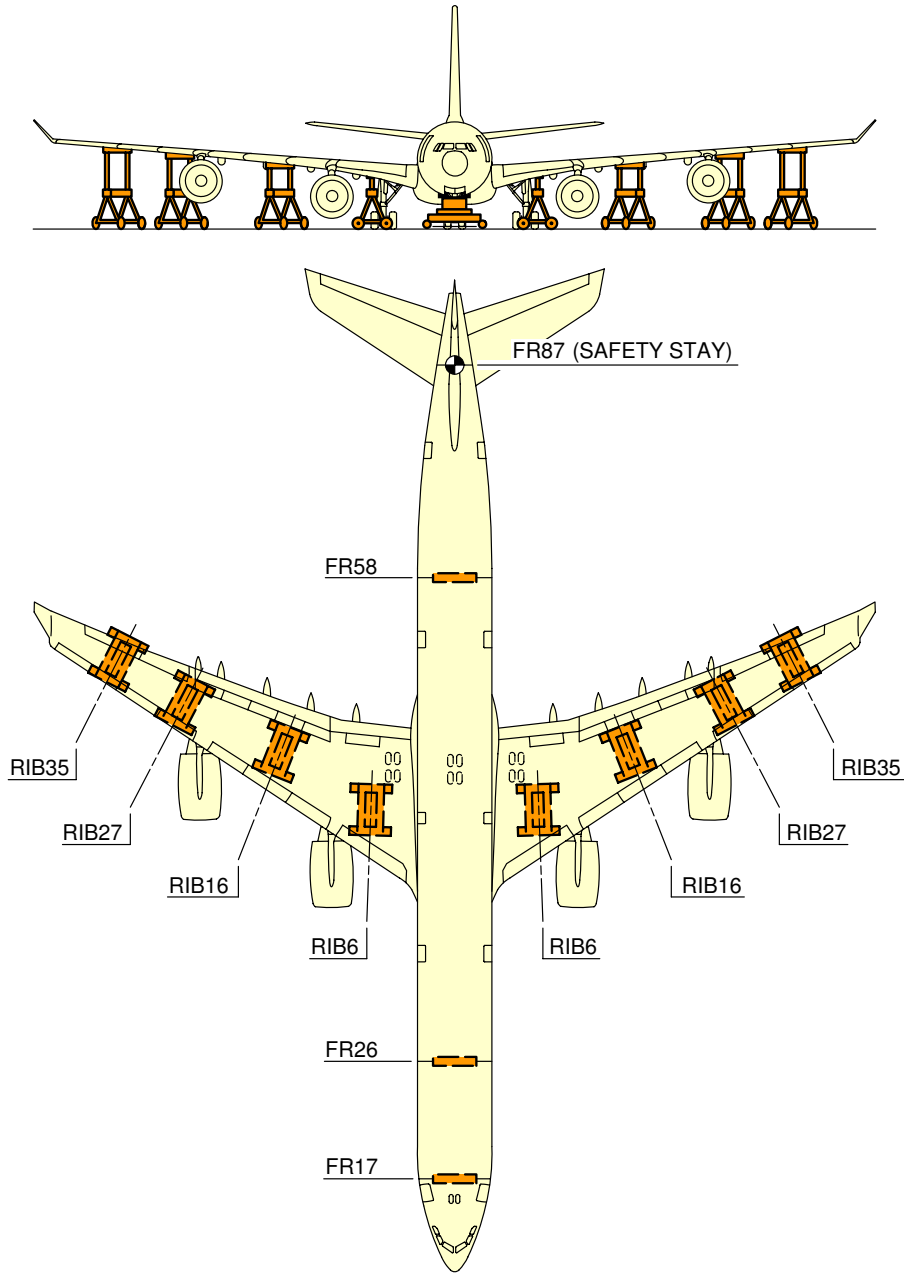

NOTE:

THE SHORING CRADLE MUST BE INSTALLED AT THE EXACT LOCATION OF THE FRAME.

F_AC_021402_1_0030201_01_00

Support of Aircraft
Location of Shoring Cradles (Sheet 1 of 2)
FIGURE-2-14-2-991-003-B01

A340-500/-600

AIRCRAFT CHARACTERISTICS - AIRPORT AND MAINTENANCE PLANNING

**ON A/C A340-600

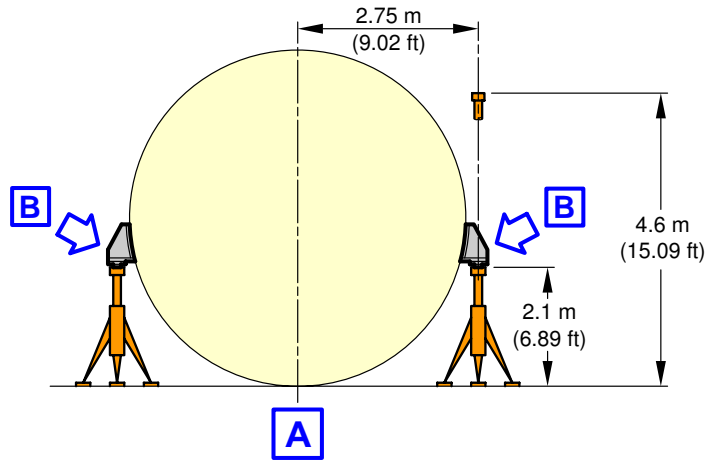
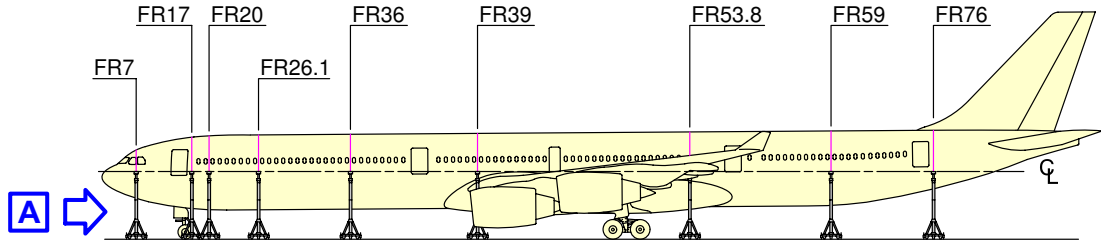

EXAMPLE

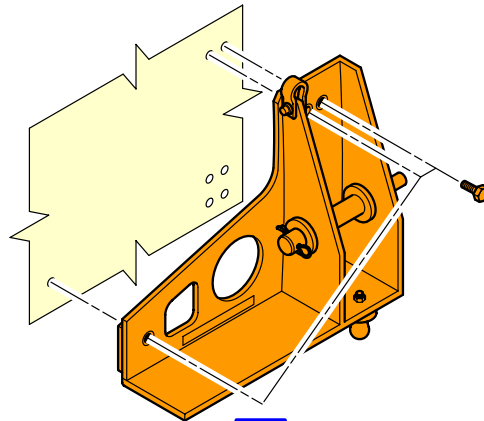

LH SHOWN
RH SYMMETRICAL

F_AC_021402_1_0030202_01_00

Support of Aircraft
Location of Auxiliary Jacking Points (Sheet 2 of 2)
FIGURE-2-14-2-991-003-B01

AIRCRAFT PERFORMANCE

3-1-0 General Information

****ON A/C A340-500 A340-600**

General Information

1. Standard day temperatures for the altitude shown are tabulated below:

Standard day temperatures for the altitude			
Altitude		Standard Day Temperature	
FEET	METERS	°F	°C
0	0	59.0	15.0
2000	610	51.9	11.1
4000	1220	44.7	7.1
6000	1830	37.6	3.1
8000	2440	30.5	-0.8

3-2-1 Payload / Range - ISA Conditions****ON A/C A340-500 A340-600**Payload / Range - ISA Conditions

1. This section gives the payload / range at ISA conditions.

A340-500/-600

AIRCRAFT CHARACTERISTICS - AIRPORT AND MAINTENANCE PLANNING

****ON A/C A340-600**

NOTE: THESE CURVES ARE GIVEN FOR INFORMATION ONLY.
THE APPROVED VALUES ARE STATED IN THE "OPERATING
MANUALS" SPECIFIC TO THE AIRLINE OPERATING THE AIRCRAFT.

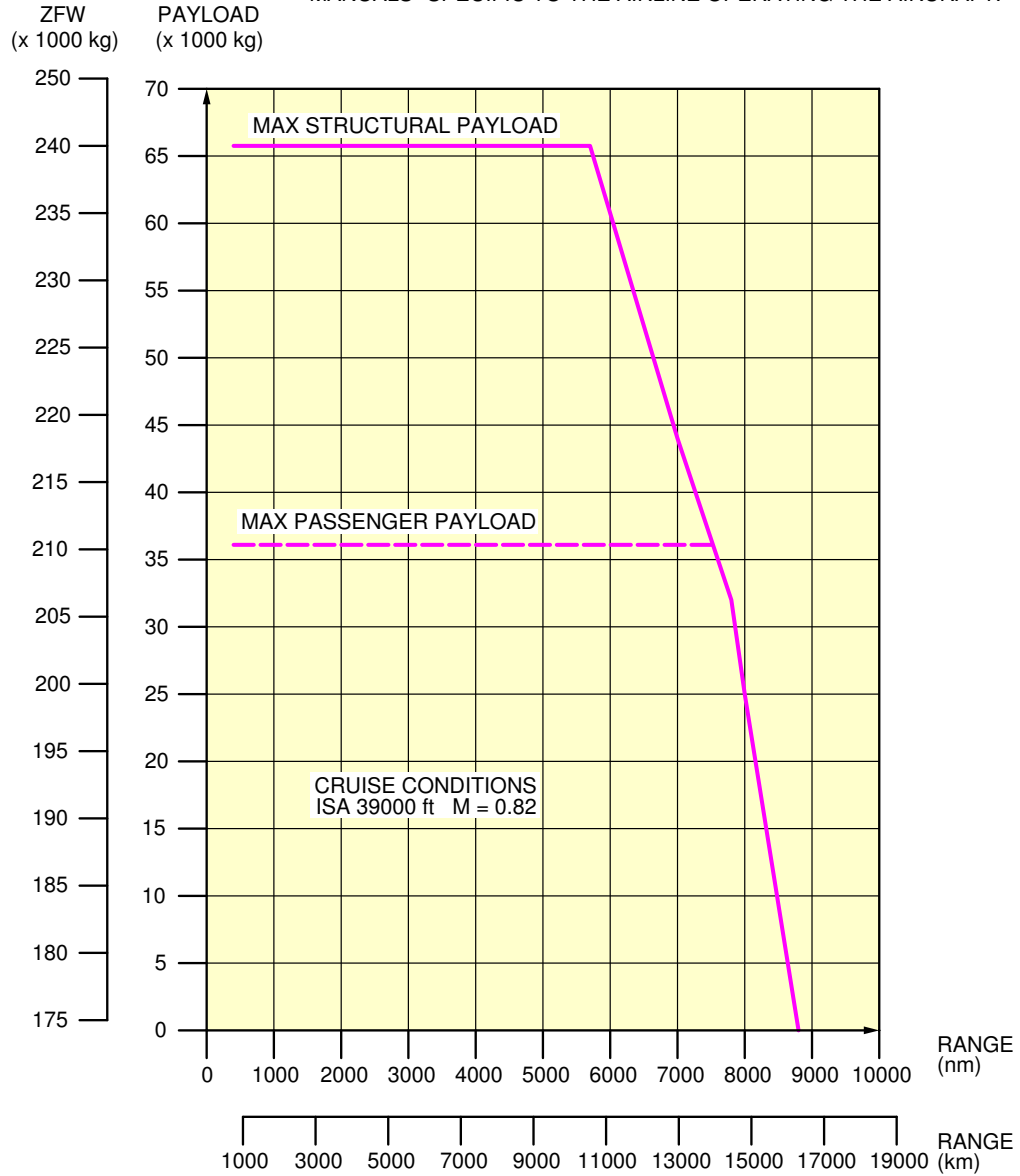

F_AC_030201_1_0180101_01_01

Payload / Range - ISA Conditions
RB 211 TRENT 556 engine
FIGURE-3-2-1-991-018-A01

A340-500/-600

AIRCRAFT CHARACTERISTICS - AIRPORT AND MAINTENANCE PLANNING

****ON A/C A340-500**

NOTE: THESE CURVES ARE GIVEN FOR INFORMATION ONLY.
THE APPROVED VALUES ARE STATED IN THE "OPERATING
MANUALS" SPECIFIC TO THE AIRLINE OPERATING THE AIRCRAFT.

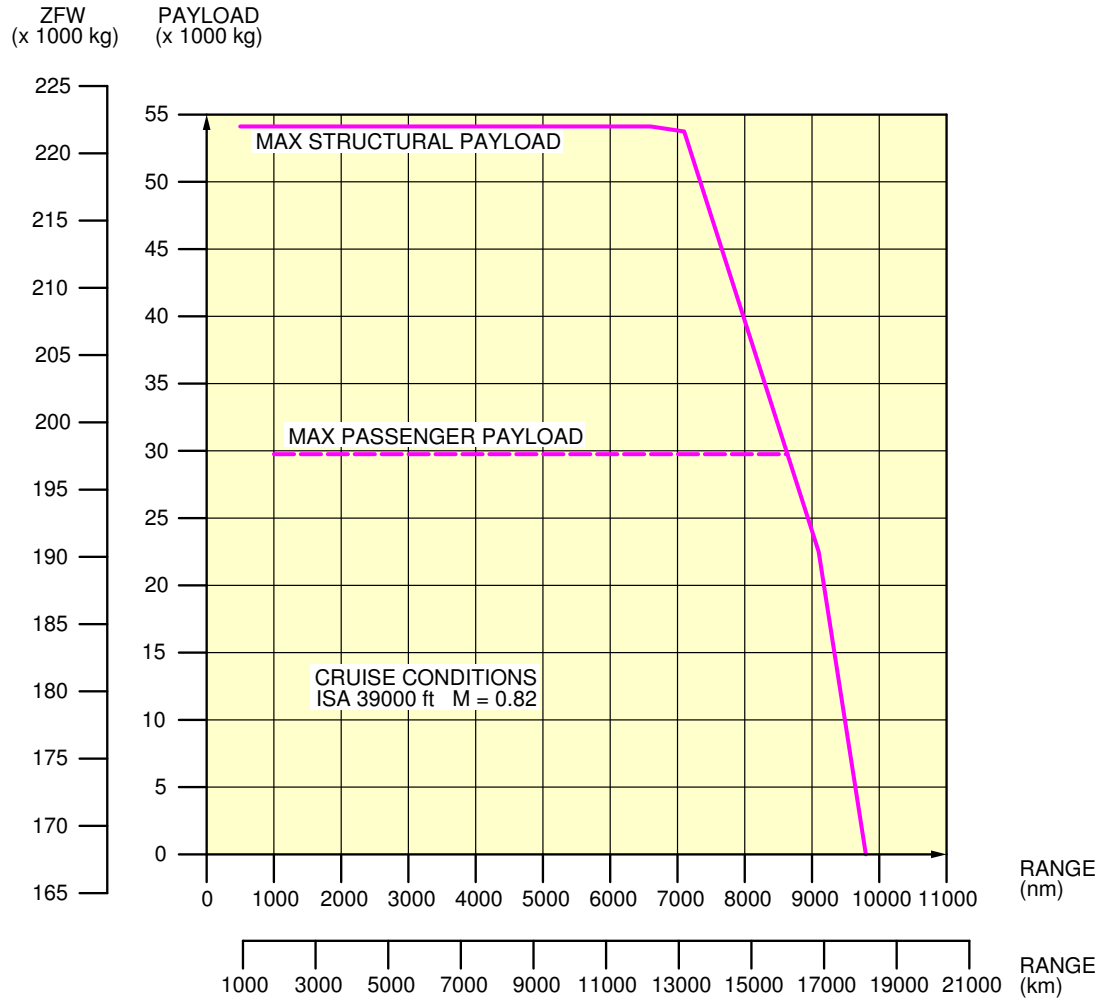

F_AC_030201_1_0190101_01_01

Payload / Range - ISA Conditions
RB 211 TRENT 553 engine
FIGURE-3-2-1-991-019-A01

3-3-1 Take-Off Weight Limitation - ISA Conditions****ON A/C A340-500 A340-600**Take-Off Weight Limitation - ISA Conditions

1. This section gives the take-off weight limitation at ISA conditions.

A340-500/-600

AIRCRAFT CHARACTERISTICS - AIRPORT AND MAINTENANCE PLANNING

****ON A/C A340-600**

NOTE: THESE CURVES ARE GIVEN FOR INFORMATION ONLY.
THE APPROVED VALUES ARE STATED IN THE "OPERATING
MANUALS" SPECIFIC TO THE AIRLINE OPERATING THE AIRCRAFT.

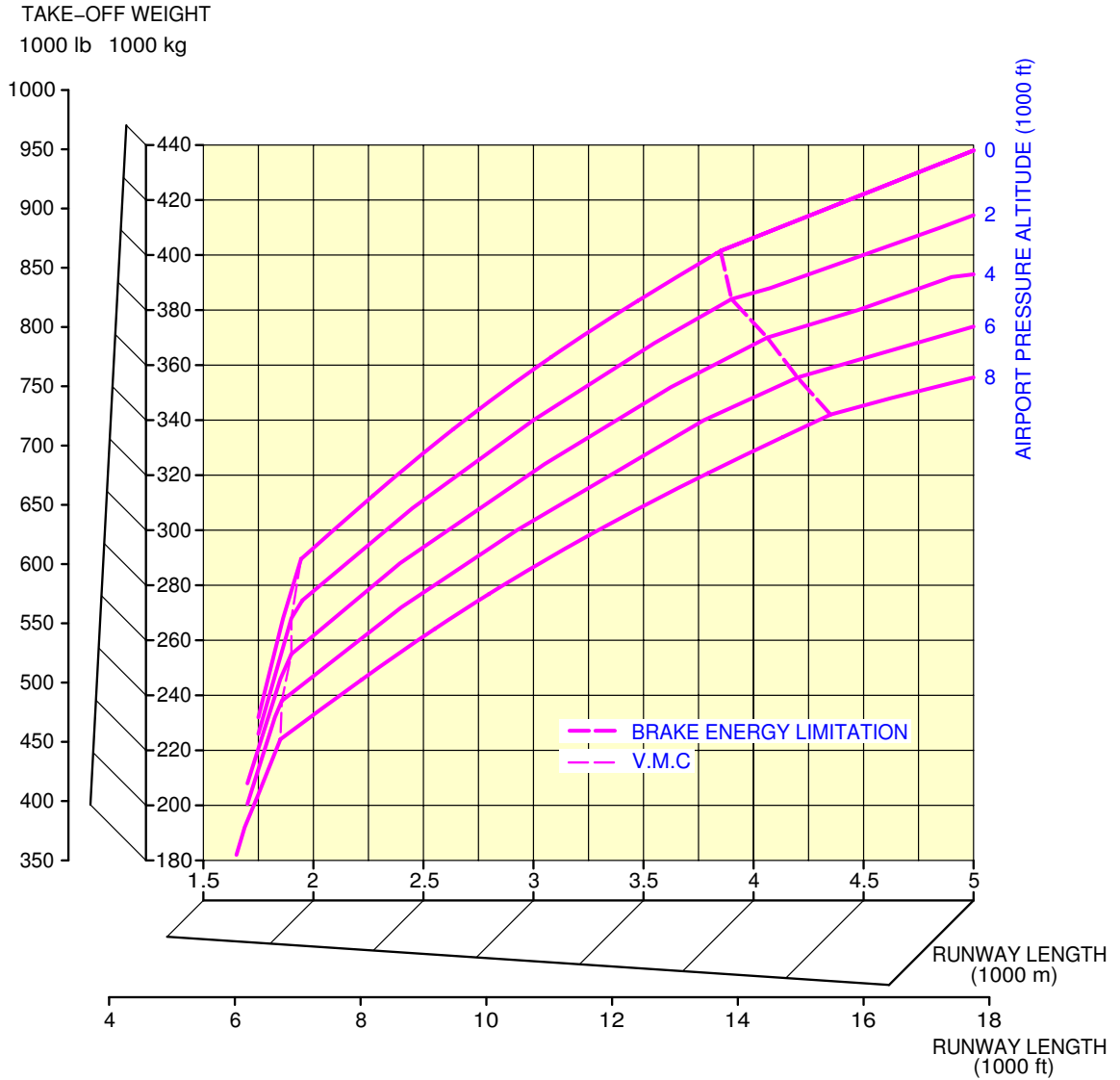

F_AC_030301_1_0100101_01_00

Take-Off Weight Limitation
ISA Conditions – RB 211 TRENT 556 engine
FIGURE-3-3-1-991-010-A01

A340-500/-600

AIRCRAFT CHARACTERISTICS - AIRPORT AND MAINTENANCE PLANNING

****ON A/C A340-500**

NOTE: THESE CURVES ARE GIVEN FOR INFORMATION ONLY.
THE APPROVED VALUES ARE STATED IN THE "OPERATING
MANUALS" SPECIFIC TO THE AIRLINE OPERATING THE AIRCRAFT.

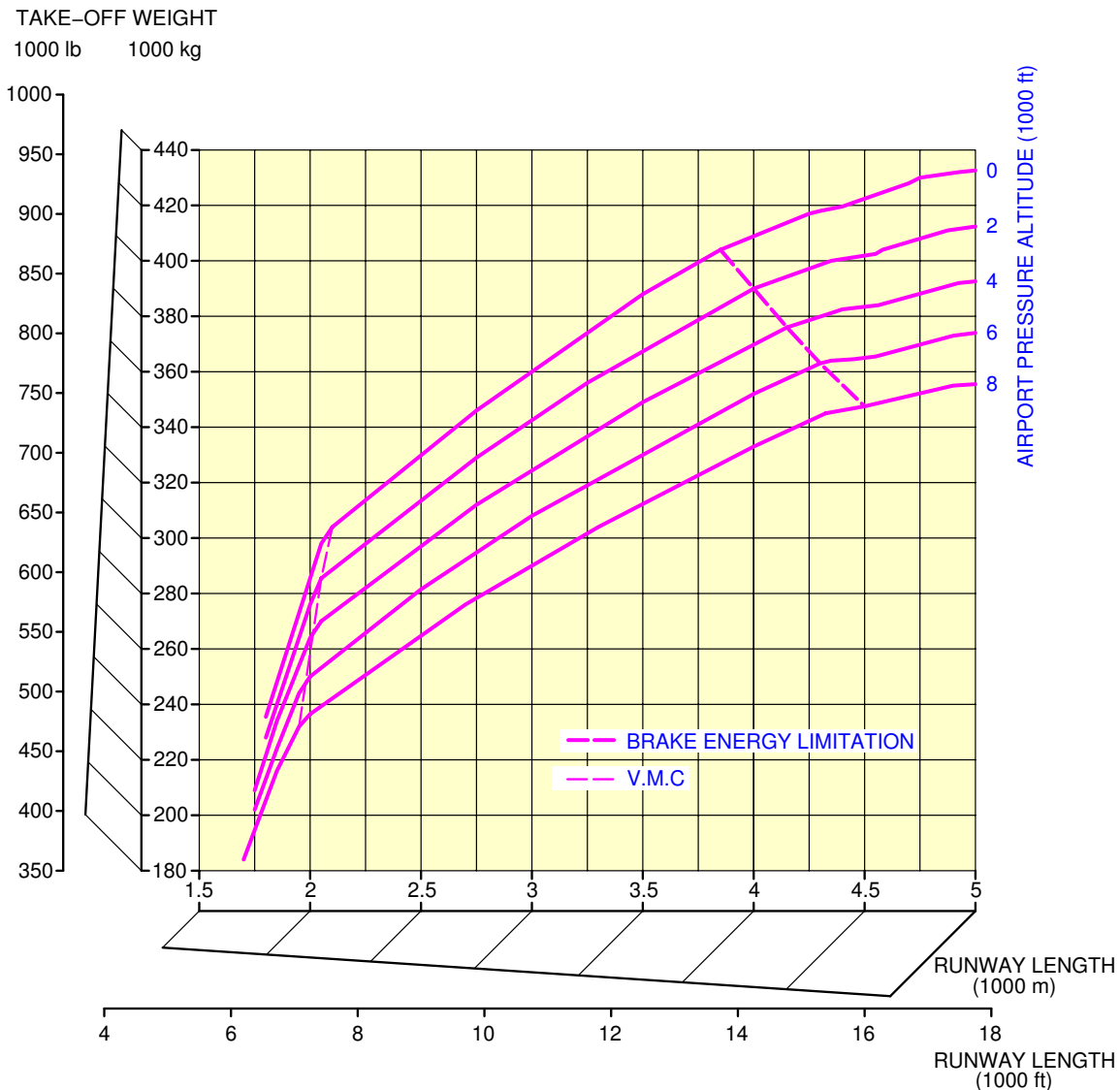

F_AC_030301_1_0110101_01_00

Take-Off Weight Limitation
ISA Conditions – RB 211 TRENT 553 engine
FIGURE-3-3-1-991-011-A01

A340-500/-600

AIRCRAFT CHARACTERISTICS - AIRPORT AND MAINTENANCE PLANNING

3-3-2 Take-Off Weight Limitation - ISA +15 ° C (+59 ° F) Conditions

****ON A/C A340-500 A340-600**

Take-Off Weight Limitation - ISA +15 ° C (+59 ° F) Conditions

1. This section gives the take-off weight limitation at ISA +15 ° C (+59 ° F) conditions.

A340-500/-600

AIRCRAFT CHARACTERISTICS - AIRPORT AND MAINTENANCE PLANNING

****ON A/C A340-600**

NOTE: THESE CURVES ARE GIVEN FOR INFORMATION ONLY.
THE APPROVED VALUES ARE STATED IN THE "OPERATING
MANUALS" SPECIFIC TO THE AIRLINE OPERATING THE AIRCRAFT.

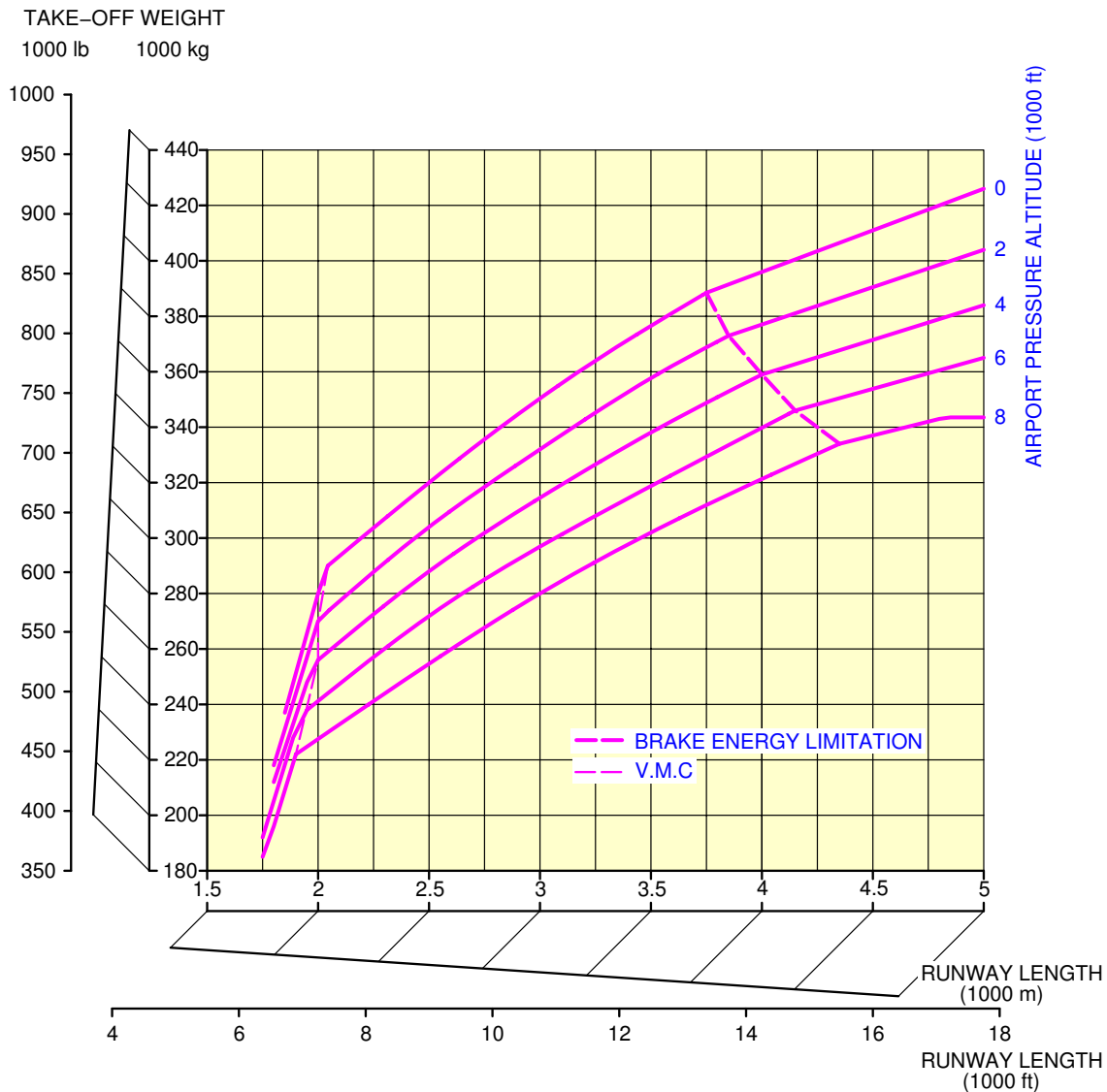

F_AC_030302_1_0100101_01_00

Take-Off Weight Limitation
ISA +15 °C (+59 °F) Conditions – RB 211 TRENT 556 engine
FIGURE-3-3-2-991-010-A01

A340-500/-600

AIRCRAFT CHARACTERISTICS - AIRPORT AND MAINTENANCE PLANNING

****ON A/C A340-500**

NOTE: THESE CURVES ARE GIVEN FOR INFORMATION ONLY.
THE APPROVED VALUES ARE STATED IN THE "OPERATING
MANUALS" SPECIFIC TO THE AIRLINE OPERATING THE AIRCRAFT.

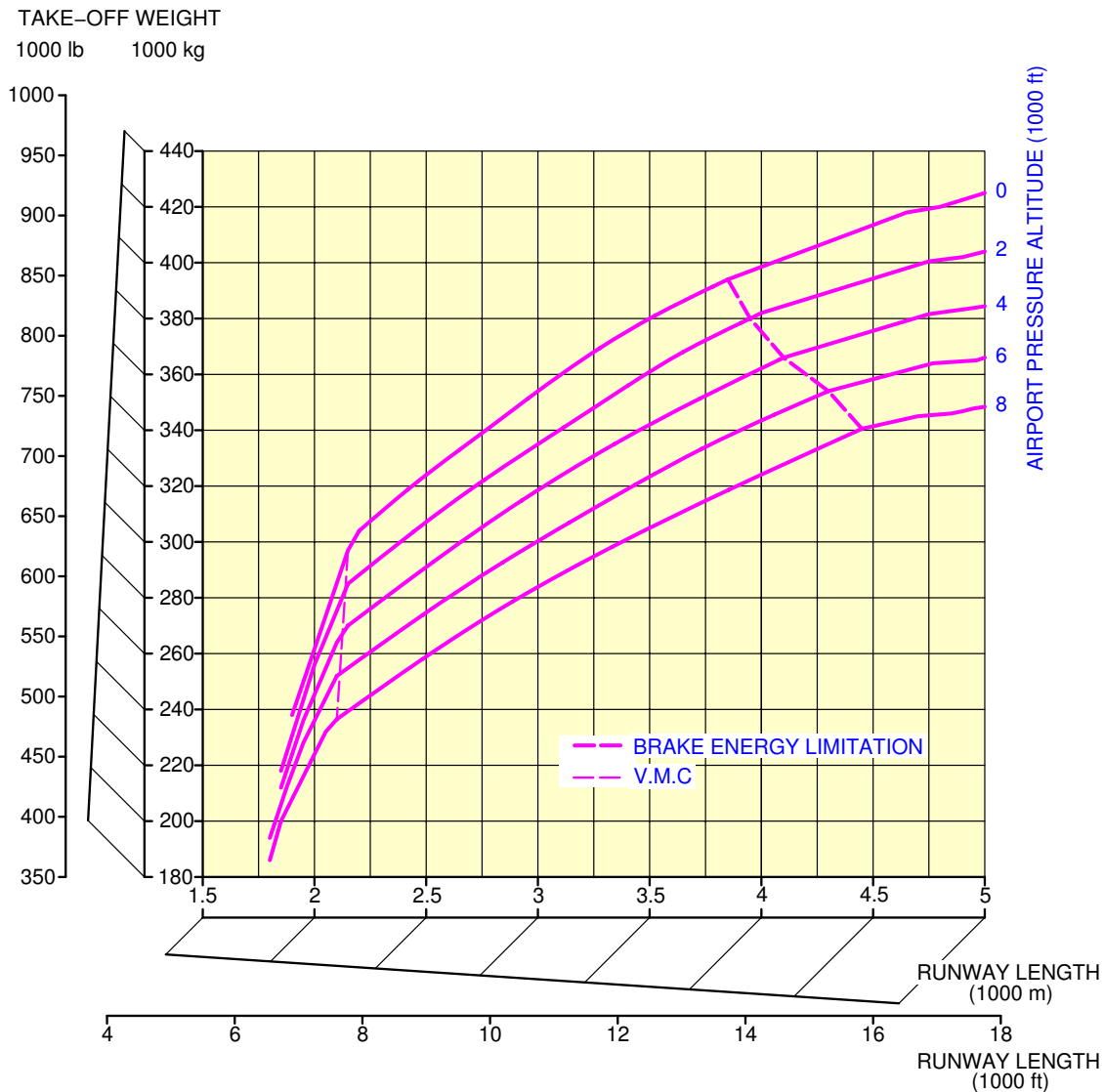

F_AC_030302_1_0110101_01_00

Take-Off Weight Limitation
ISA +15 °C (+59 °F) Conditions – RB 211 TRENT 553 engine
FIGURE-3-3-2-991-011-A01

3-4-1 Landing Field Length - ISA Conditions****ON A/C A340-500 A340-600**Landing Field Length - ISA Conditions

1. This section gives the landing field length.

A340-500/-600

AIRCRAFT CHARACTERISTICS - AIRPORT AND MAINTENANCE PLANNING

****ON A/C A340-600**

NOTE: THESE CURVES ARE GIVEN FOR INFORMATION ONLY. THE APPROVED VALUES ARE STATED IN THE "OPERATING MANUALS" SPECIFIC TO THE AIRLINE OPERATING THE AIRCRAFT.

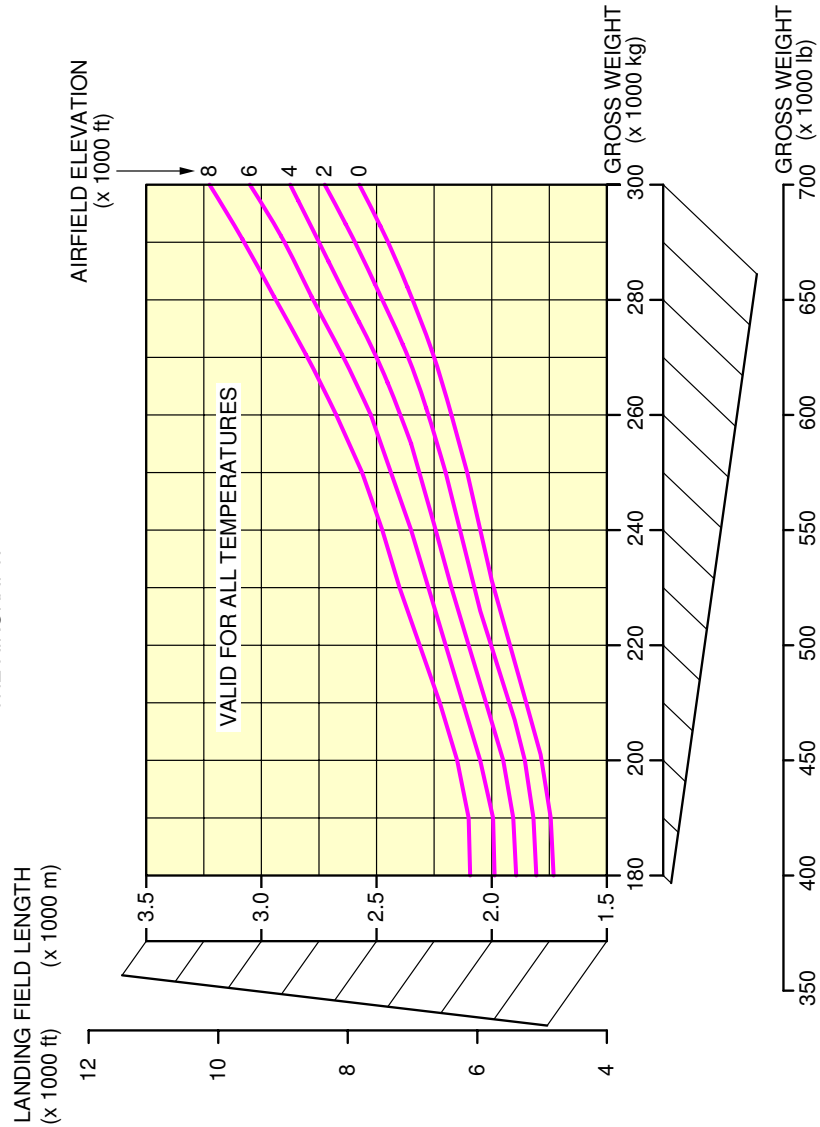

F_AC_030401_1_0100101_01_01

Landing Field Length
ISA Conditions – RB 211 TRENT 556 engine
FIGURE-3-4-1-991-010-A01

A340-500/-600

AIRCRAFT CHARACTERISTICS - AIRPORT AND MAINTENANCE PLANNING

**ON A/C A340-500

NOTE: THESE CURVES ARE GIVEN FOR INFORMATION ONLY. THE APPROVED VALUES ARE STATED IN THE "OPERATING MANUALS" SPECIFIC TO THE AIRLINE OPERATING THE AIRCRAFT.

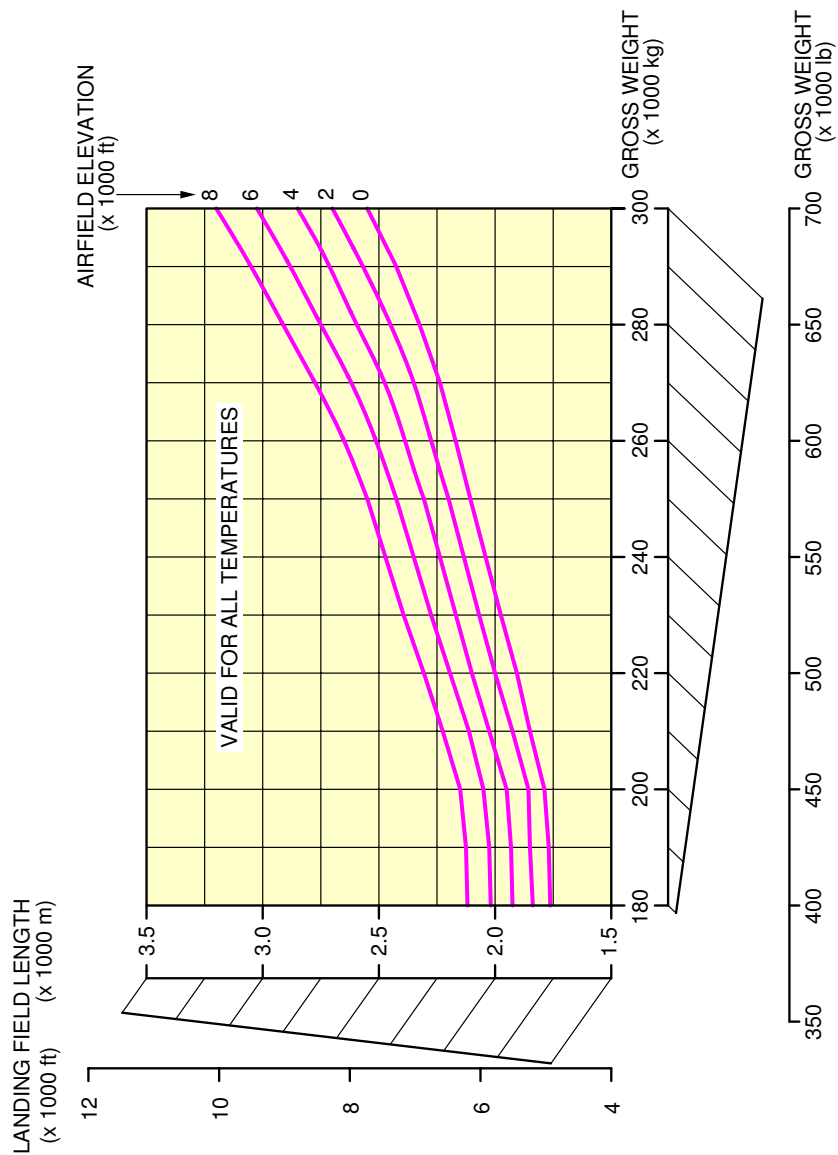

F_AC_030401_1_0110101_01_01

Landing Field Length
 ISA Conditions – RB 211 TRENT 553 engine
 FIGURE-3-4-1-991-011-A01

3-5-0 Final Approach Speed****ON A/C A340-500 A340-600**Final Approach Speed****ON A/C A340-500**

1. Final Approach Speed

- A. This section gives the final approach speed. This is the indicated airspeed at threshold in the landing configuration, at the certificated maximum flap setting and maximum landing weight, in standard atmospheric conditions. The approach speed is used to classify the aircraft into an Aircraft Approach Category, a grouping of aircraft based on the indicated airspeed at threshold.
- B. The final approach speed is 146 kt at a Maximum Landing Weight (MLW) of 246 000 kg (542 337 lb) and classifies the aircraft into the Aircraft Approach Category D.

NOTE : This value is given for information only.

****ON A/C A340-600**

2. Final Approach Speed

- A. This section gives the final approach speed. This is the indicated airspeed at threshold in the landing configuration, at the certificated maximum flap setting and maximum landing weight, in standard atmospheric conditions. The approach speed is used to classify the aircraft into an Aircraft Approach Category, a grouping of aircraft based on the indicated airspeed at threshold.
- B. The final approach speed is 153 kt at a Maximum Landing Weight (MLW) of 265 000 kg (584 225 lb) and classifies the aircraft into the Aircraft Approach Category D.

NOTE : This value is given for information only.

GROUND MANEUVERING**4-1-0 General Information******ON A/C A340-500 A340-600****General Information**

1. This section provides aircraft turning capability and maneuvering characteristics.

For ease of presentation, this data has been determined from the theoretical limits imposed by the geometry of the aircraft, and where noted, provides for a normal allowance for tire slippage. As such, it reflects the turning capability of the aircraft in favorable operating circumstances. This data should only be used as guidelines for the method of determination of such parameters and for the maneuvering characteristics of this aircraft type.

In the ground operating mode, varying airline practices may demand that more conservative turning procedures be adopted to avoid excessive tire wear and reduce possible maintenance problems. Airline operating techniques will vary in the level of performance, over a wide range of operating circumstances throughout the world. Variations from standard aircraft operating patterns may be necessary to satisfy physical constraints within the maneuvering area, such as adverse grades, limited area or high risk of jet blast damage. For these reasons, ground maneuvering requirements should be coordinated with the airlines in question prior to layout planning

4-2-0 Turning Radii

****ON A/C A340-500 A340-600**

Turning Radii

1. This section provides the turning radii.

A340-500/-600

AIRCRAFT CHARACTERISTICS - AIRPORT AND MAINTENANCE PLANNING

****ON A/C A340-600**

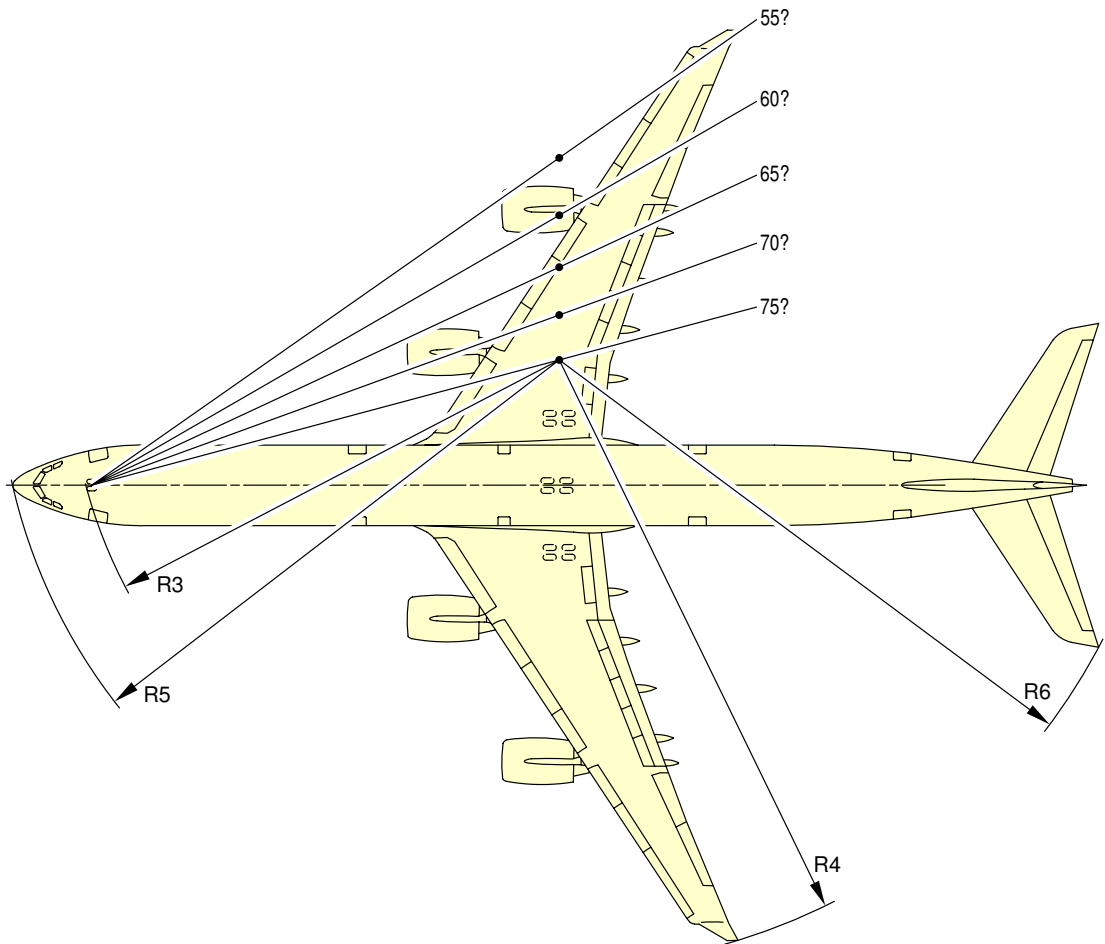

NOTE:
FOR TURNING RADII VALUES, REFER TO SHEET 2.

F_AC_040200_1_0080101_01_02

Turning Radii
(Sheet 1) (Sheet 1 of 2)
FIGURE-4-2-0-991-008-A01

A340-500/-600

AIRCRAFT CHARACTERISTICS - AIRPORT AND MAINTENANCE PLANNING

****ON A/C A340-600**

A340-600 TURNING RADII						
STEERING ANGLE (deg)	EFFECTIVE STEERING ANGLE (deg)		R3 NLG	R4 WING	R5 NOSE	R6 TAIL
20	19.7	m	98.9	124.8	98.2	109.9
		ft	325	409	322	361
25	24.6	m	80.2	104.7	82.8	91.1
		ft	263	344	272	299
30	29.5	m	67.9	91	70.9	78.6
		ft	223	299	233	258
35	34.4	m	59.3	80.9	62.8	69.7
		ft	195	265	206	229
40	39.2	m	53	73.2	56.9	63.1
		ft	174	240	187	207
45	44	m	48.3	66.9	52.6	58
		ft	159	220	173	190
50	48.8	m	44.7	61.7	49.3	53.9
		ft	147	202	162	177
55	53.4	m	41.9	57.4	46.8	50.7
		ft	138	188	154	166
60	57.9	m	39.8	53.6	44.9	48
		ft	131	176	147	158
65	62	m	38.2	50.5	43.5	45.9
		ft	125	166	143	151
70	65.6	m	37.1	48	42.5	44.4
		ft	122	158	139	146
75	67.4	m	36.6	46.8	42.1	43.6
		ft	120	153	138	143

NOTE:
SYMMETRIC THRUST- NO BRAKING.

F_AC_040200_1_0080102_01_00

Turning Radii
(Sheet 2) (Sheet 2 of 2)
FIGURE-4-2-0-991-008-A01

A340-500/-600

AIRCRAFT CHARACTERISTICS - AIRPORT AND MAINTENANCE PLANNING

****ON A/C A340-500**

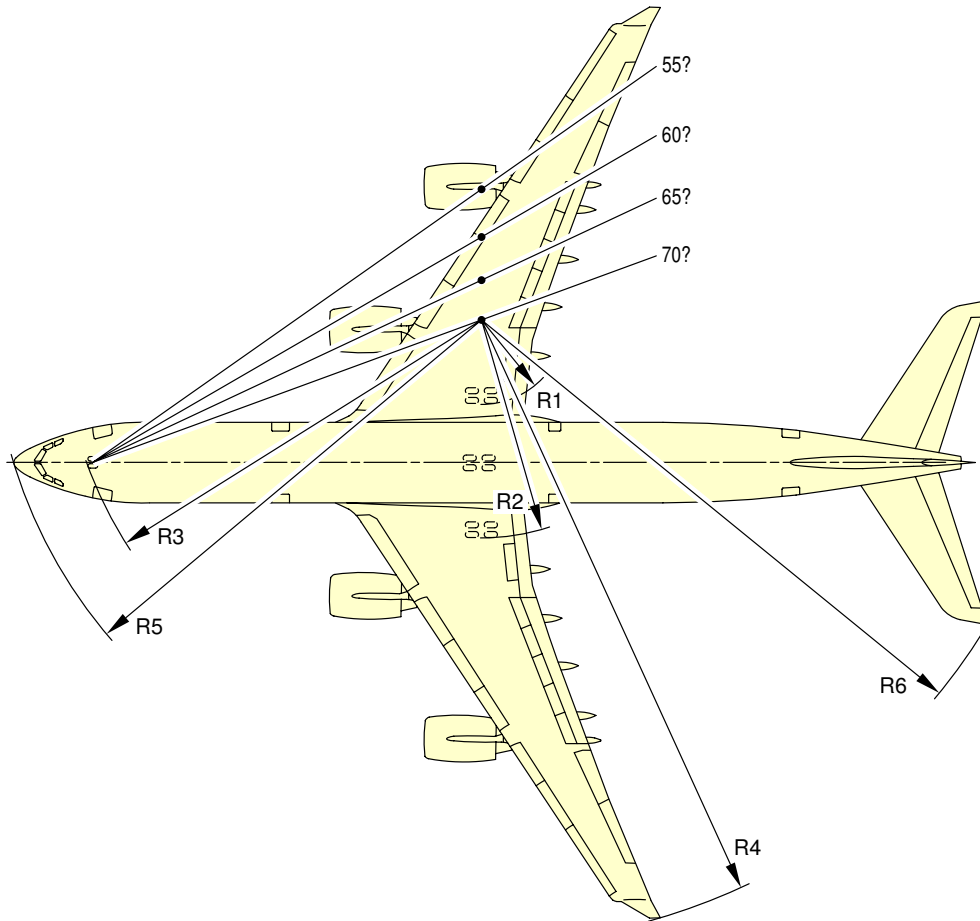

NOTE:
FOR TURNING RADII VALUES, REFER TO SHEET 2.

F_AC_040200_1_0090101_01_02

Turning Radii
(Sheet 1) (Sheet 1 of 2)
FIGURE-4-2-0-991-009-A01

A340-500/-600

AIRCRAFT CHARACTERISTICS - AIRPORT AND MAINTENANCE PLANNING

****ON A/C A340-500**

A340-500 TURNING RADII									
TYPE OF TURN	STEERING ANGLE (deg)	EFFECTIVE STEERING ANGLE (deg)		R1 RMLG	R2 LMLG	R3 NLG	R4 WING	R5 NOSE	R6 TAIL
2	20	19.5	m	78.7	84.4	83.5	110.4	85.3	94.9
			ft	258	277	274	362	280	311
2	25	24.3	m	63.1	67.4	67.6	93.5	70.0	79.2
			ft	207	221	222	307	230	260
2	30	29.1	m	52.9	55.9	57.3	82.0	60.2	68.8
			ft	174	183	188	269	198	226
2	35	33.9	m	45.9	47.3	50.0	73.6	53.4	61.5
			ft	151	155	164	241	175	202
2	40	38.7	m	40.8	40.8	44.6	67.1	48.5	56.1
			ft	134	134	146	220	159	184
2	45	43.4	m	37.1	35.5	40.6	61.9	44.9	51.9
			ft	122	116	133	203	147	170
2	50	48.0	m	34.3	31.1	37.5	57.6	42.2	48.7
			ft	113	102	123	189	138	160
2	55	52.6	m	32.3	27.4	35.1	53.9	40.1	46.0
			ft	106	90	115	177	132	151
2	60	57.0	m	30.7	24.2	33.3	50.8	38.6	43.9
			ft	101	79	109	167	127	144
2	65	61.1	m	29.7	21.6	31.8	48.2	37.4	42.2
			ft	97	71	104	158	123	138
2	70	64.5	m	29.0	19.5	30.9	46.2	36.6	40.9
			ft	95	64	101	152	120	134
1	50	49.3	m	33.7	30.0	36.8	56.5	41.6	47.9
			ft	111	98	121	185	136	157
1	55	54.0	m	31.7	26.3	34.5	52.9	39.6	45.3
			ft	104	86	113	174	130	149
1	60	58.8	m	30.2	23.0	32.6	49.7	38.0	43.1
			ft	99	75	107	163	125	141
1	65	63.5	m	29.1	20.1	31.1	46.8	36.8	41.3
			ft	95	66	102	154	121	135
1	70	68.0	m	28.4	17.4	30.0	44.2	35.9	39.8
			ft	93	57	98	145	118	131

NOTE:

ABOVE 50?, AIRLINES MAY USE TYPE 1 OR TYPE 2 TURNS DEPENDING ON THE SITUATION.

TYPE 1 TURNS USE:

ASYMMETRIC THRUST DURING THE WHOLE TURN; AND

DIFFERENTIAL BRAKING TO INITIATE THE TURN ONLY.

TYPE 2 TURNS USE:

SYMMETRIC THRUST DURING THE WHOLE TURN; AND NO DIFFERENTIAL BRAKING AT ALL.

IT IS POSSIBLE TO GET LOWER VALUES THAN THOSE FROM TYPE 1 BY APPLYING

DIFFERENTIAL BRAKING DURING THE WHOLE TURN.

F_AC_040200_1_0090102_01_00

Turning Radii
(Sheet 2) (Sheet 2 of 2)
FIGURE-4-2-0-991-009-A01

4-3-0 Minimum Turning Radii****ON A/C A340-500 A340-600**Minimum Turning Radii

1. This section provides the minimum turning radii.

A340-500/-600

AIRCRAFT CHARACTERISTICS - AIRPORT AND MAINTENANCE PLANNING

**ON A/C A340-600

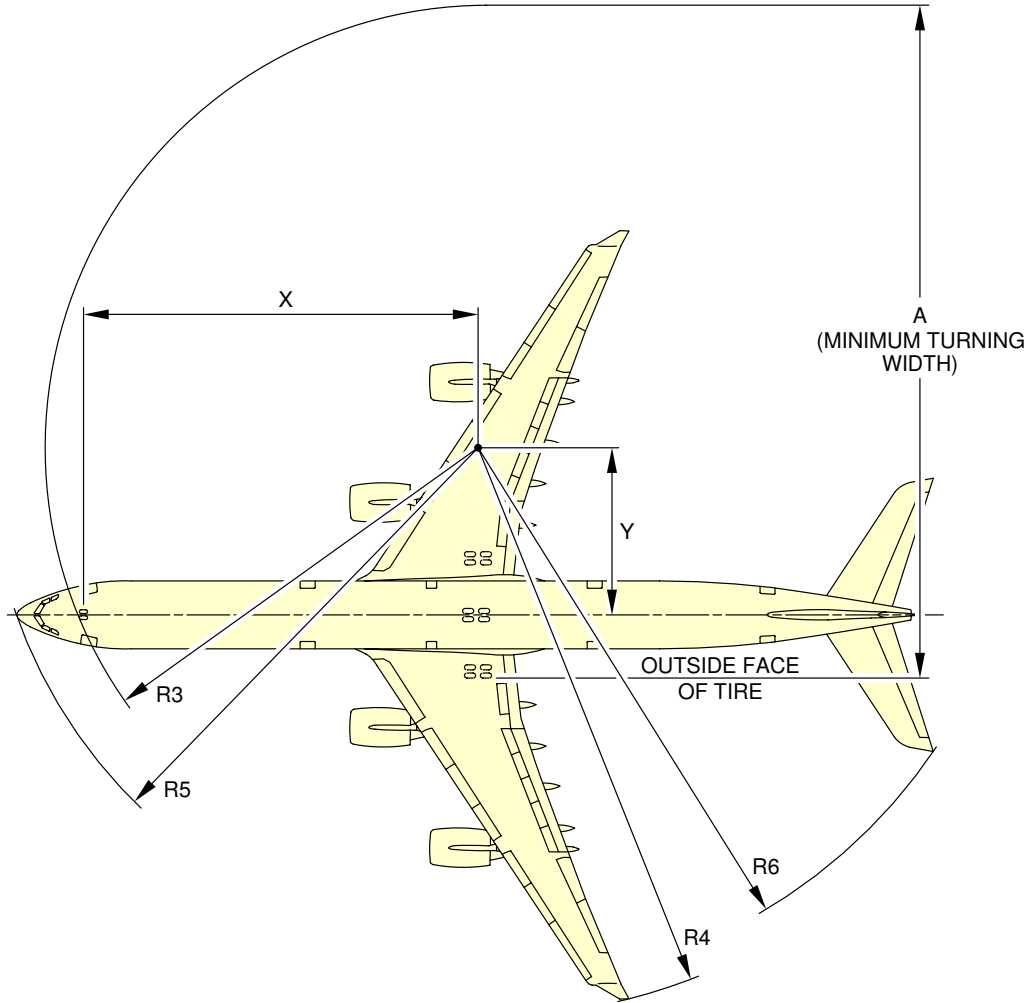

A340-600 MINIMUM TURNING RADII									
TYPE OF TURN	EFFECTIVE STEERING ANGLE (deg)		X	Y	A	R3 NLG	R4 WING	R5 NOSE	R6 TAIL
		2	67.4	m	33.2	13.7	56.7	36.6	46.8
		ft	109	45	186	120	154	138	143

NOTE:
 TYPE 2 TURNS USE:
 SYMMETRIC THRUST DURING THE WHOLE TURN;
 AND NO DIFFERENTIAL BRAKING AT ALL.

F_AC_040300_1_0050101_01_01

Minimum Turning Radii
 FIGURE-4-3-0-991-005-A01

A340-500/-600

AIRCRAFT CHARACTERISTICS - AIRPORT AND MAINTENANCE PLANNING

**ON A/C A340-500

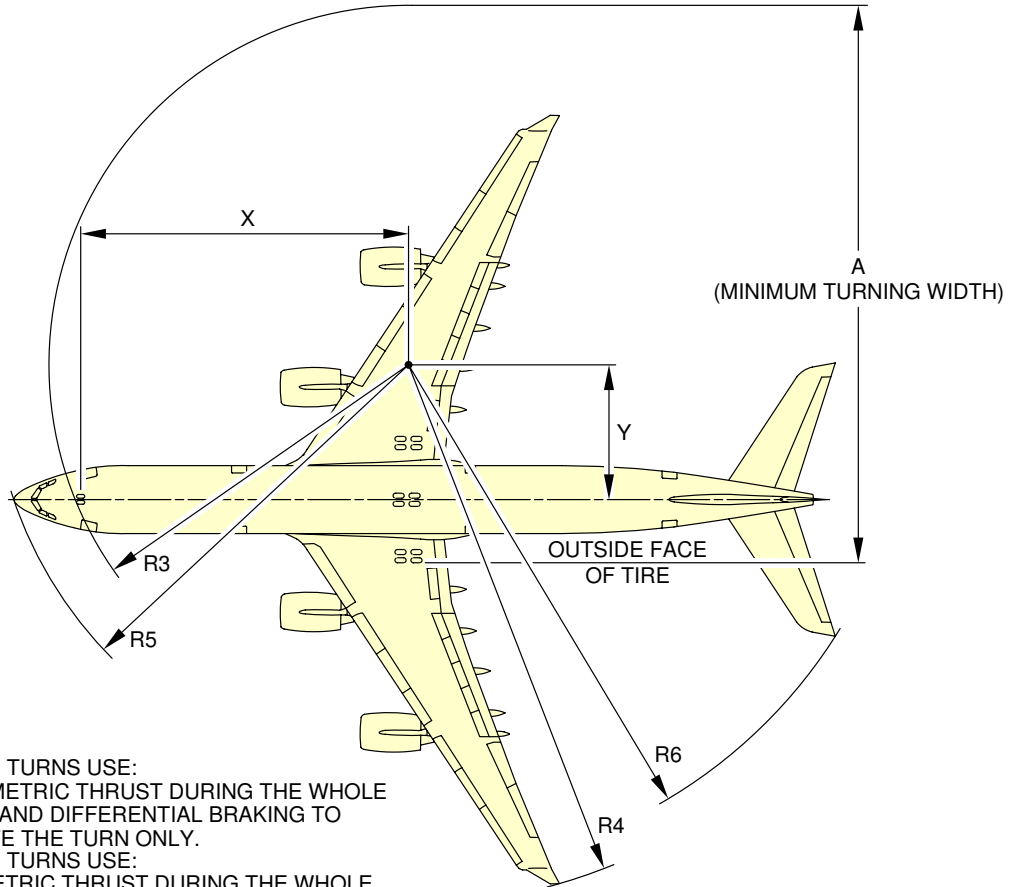

NOTE:
 TYPE 1 TURNS USE:
 ASYMMETRIC THRUST DURING THE WHOLE TURN; AND DIFFERENTIAL BRAKING TO INITIATE THE TURN ONLY.
 TYPE 2 TURNS USE:
 SYMMETRIC THRUST DURING THE WHOLE TURN; AND NO DIFFERENTIAL BRAKING AT ALL.

A340-500 MINIMUM TURNING RADII										
TYPE OF TURN	STEERING ANGLE (deg)	EFFECTIVE STEERING ANGLE (deg)		X	Y	A	R3 NLG	R4 WING	R5 NOSE	R6 TAIL
1	70 (MAX)	68.0	m	27.6	11.1	47.8	30.0	44.2	35.9	39.8
			ft	91	36	157	98	145	118	131
2	70 (MAX)	64.5	m	27.6	13.2	50.7	30.9	46.2	36.6	40.9
			ft	91	43	166	101	152	120	134

NOTE:
 IT IS POSSIBLE TO GET LOWER VALUES THAN THOSE FROM TYPE 1 BY APPLYING DIFFERENTIAL BRAKING DURING THE WHOLE TURN.

F_AC_040300_1_0060101_01_01

Minimum Turning Radii
 FIGURE-4-3-0-991-006-A01

4-4-0 Visibility from Cockpit in Static Position****ON A/C A340-500 A340-600**Visibility from Cockpit in Static Position

1. This section gives the visibility from cockpit in static position.

A340-500/-600

AIRCRAFT CHARACTERISTICS - AIRPORT AND MAINTENANCE PLANNING

**ON A/C A340-500 A340-600

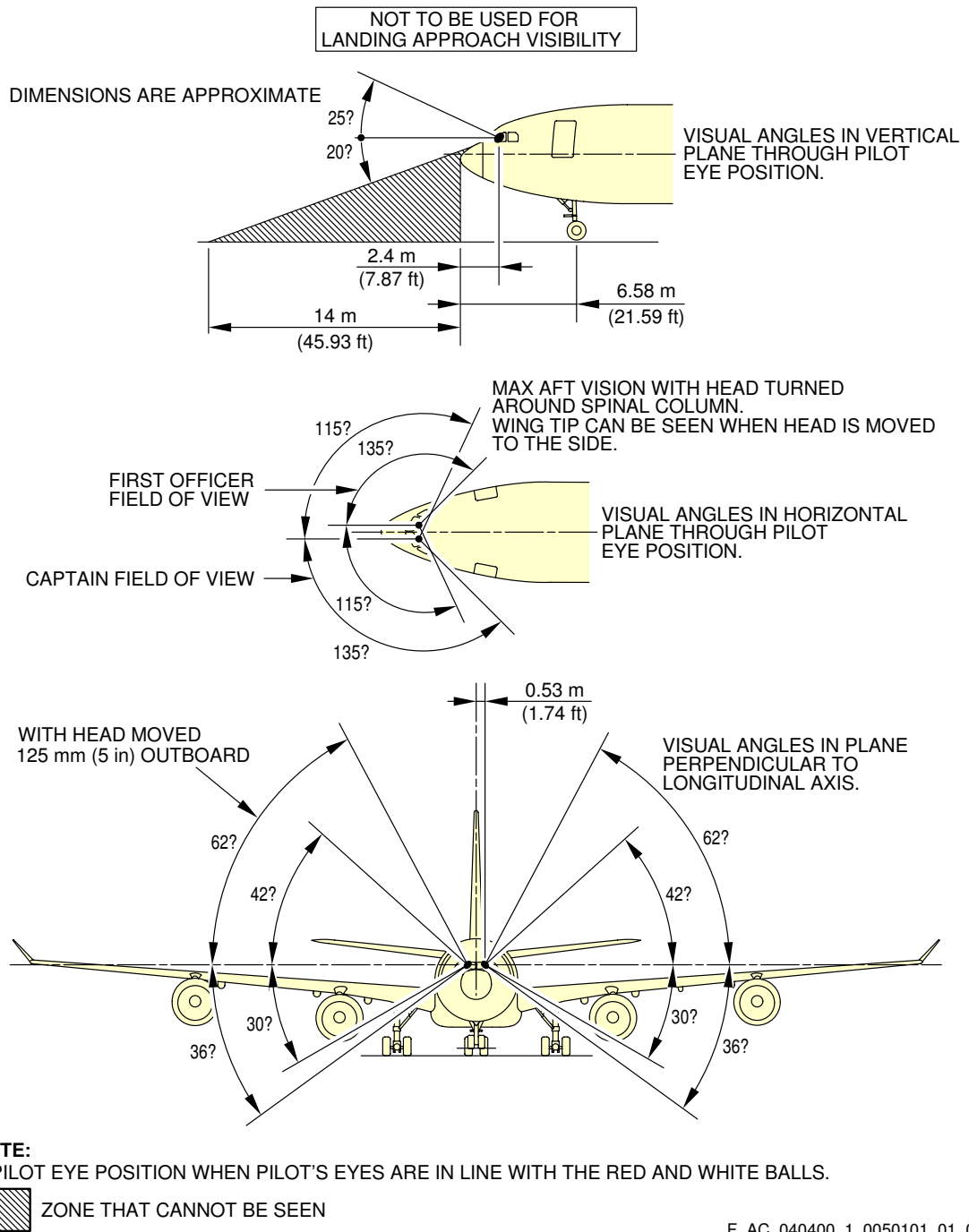

F_AC_040400_1_0050101_01_02

Visibility from Cockpit in Static Position
FIGURE-4-4-0-991-005-A01

A340-500/-600

AIRCRAFT CHARACTERISTICS - AIRPORT AND MAINTENANCE PLANNING

**ON A/C A340-500 A340-600

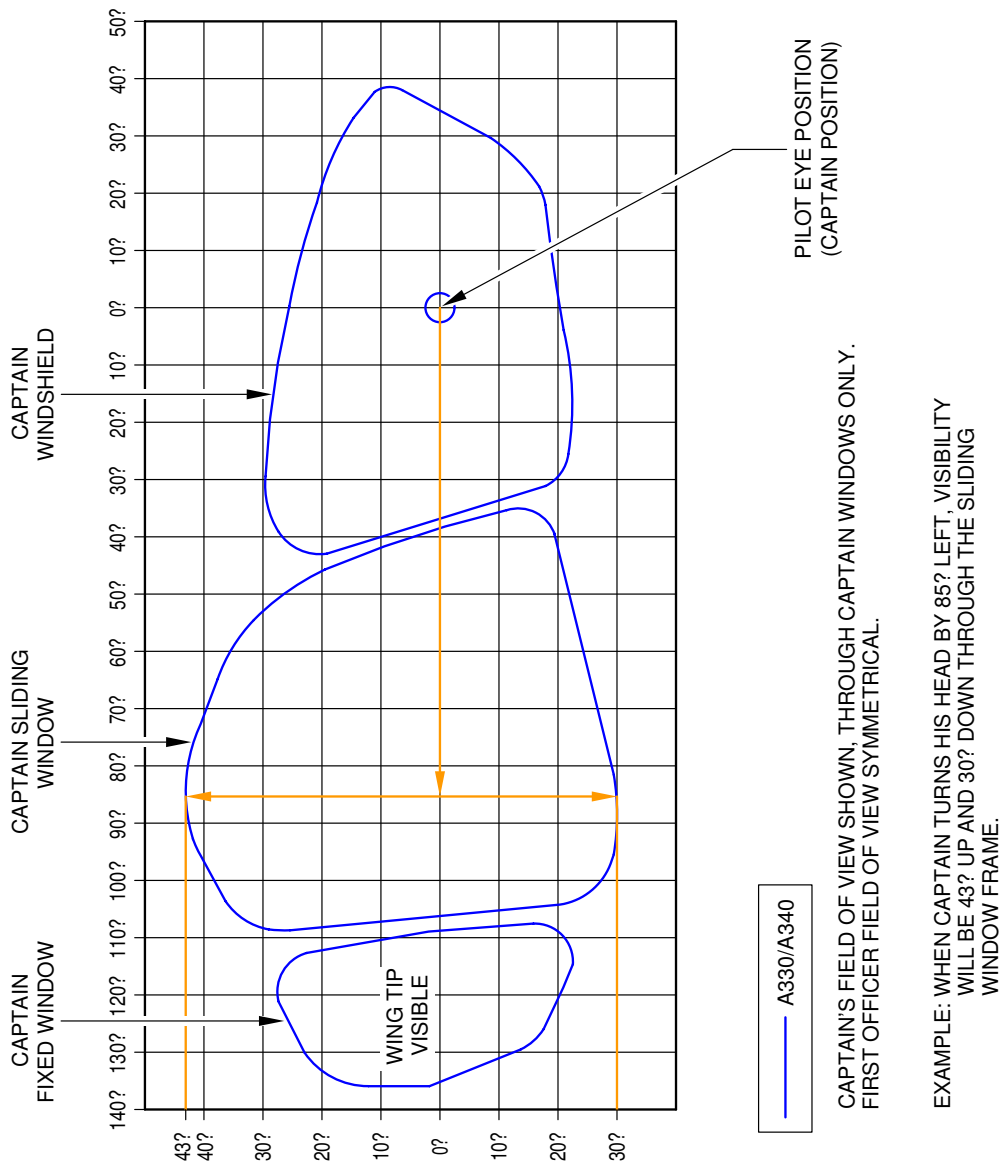

F_AC_040400_1_0090101_01_00

Binocular Visibility Through Windows from Captain Eye Position
FIGURE-4-4-0-991-009-A01

4-5-0 Runway and Taxiway Turn Paths****ON A/C A340-500 A340-600**Runway and Taxiway Turn Paths

1. Runway and Taxiway Turn Paths.

4-5-1 135° Turn - Runway to Taxiway****ON A/C A340-500 A340-600**135° Turn - Runway to Taxiway

1. This section gives the 135° turn - runway to taxiway.

A340-500/-600

AIRCRAFT CHARACTERISTICS - AIRPORT AND MAINTENANCE PLANNING

**ON A/C A340-600

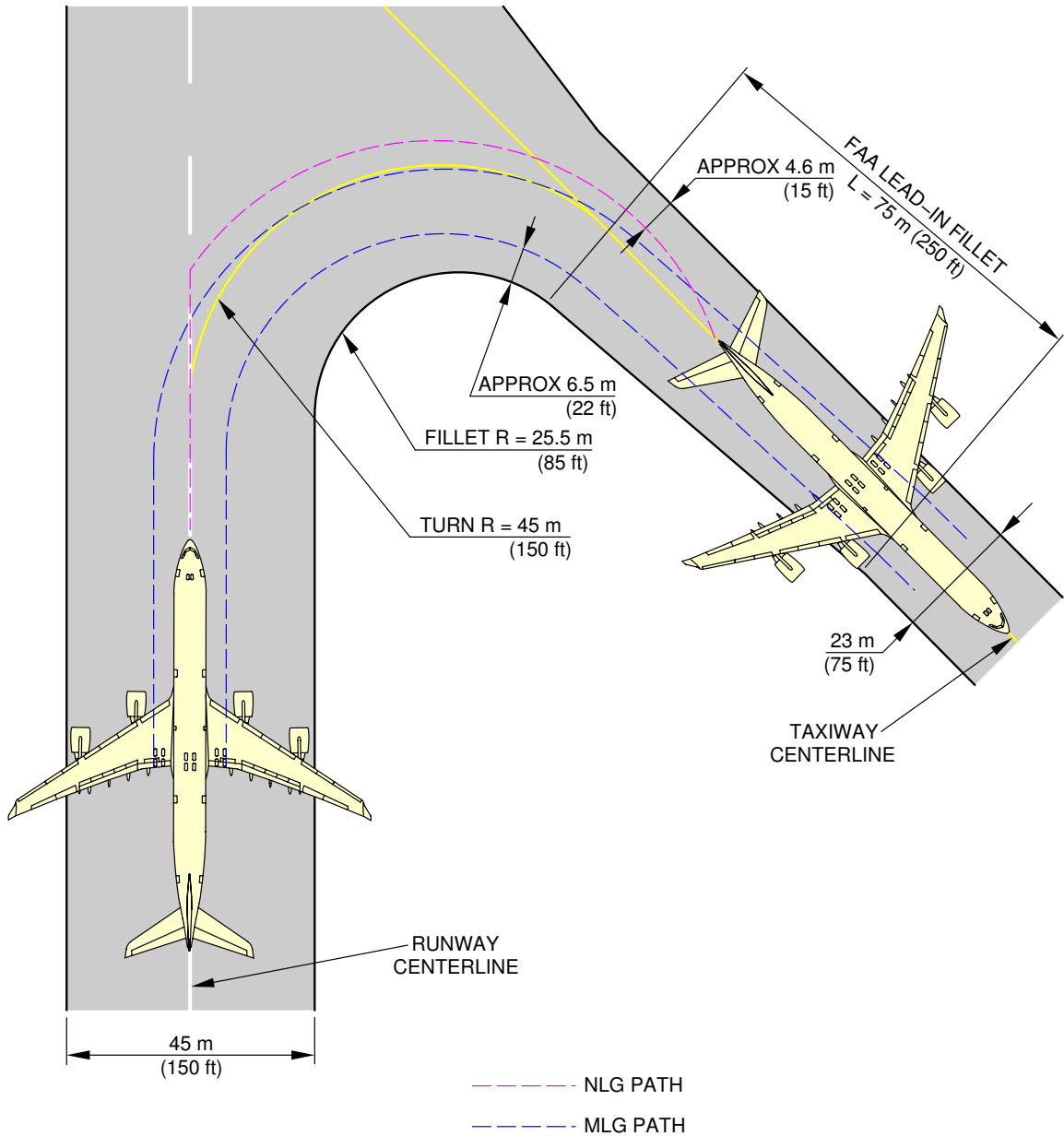

F_AC_040501_1_0040101_01_01

135° Turn - Runway to Taxiway
Judgemental Oversteering Method
FIGURE-4-5-1-991-004-A01

A340-500/-600

AIRCRAFT CHARACTERISTICS - AIRPORT AND MAINTENANCE PLANNING

**ON A/C A340-600

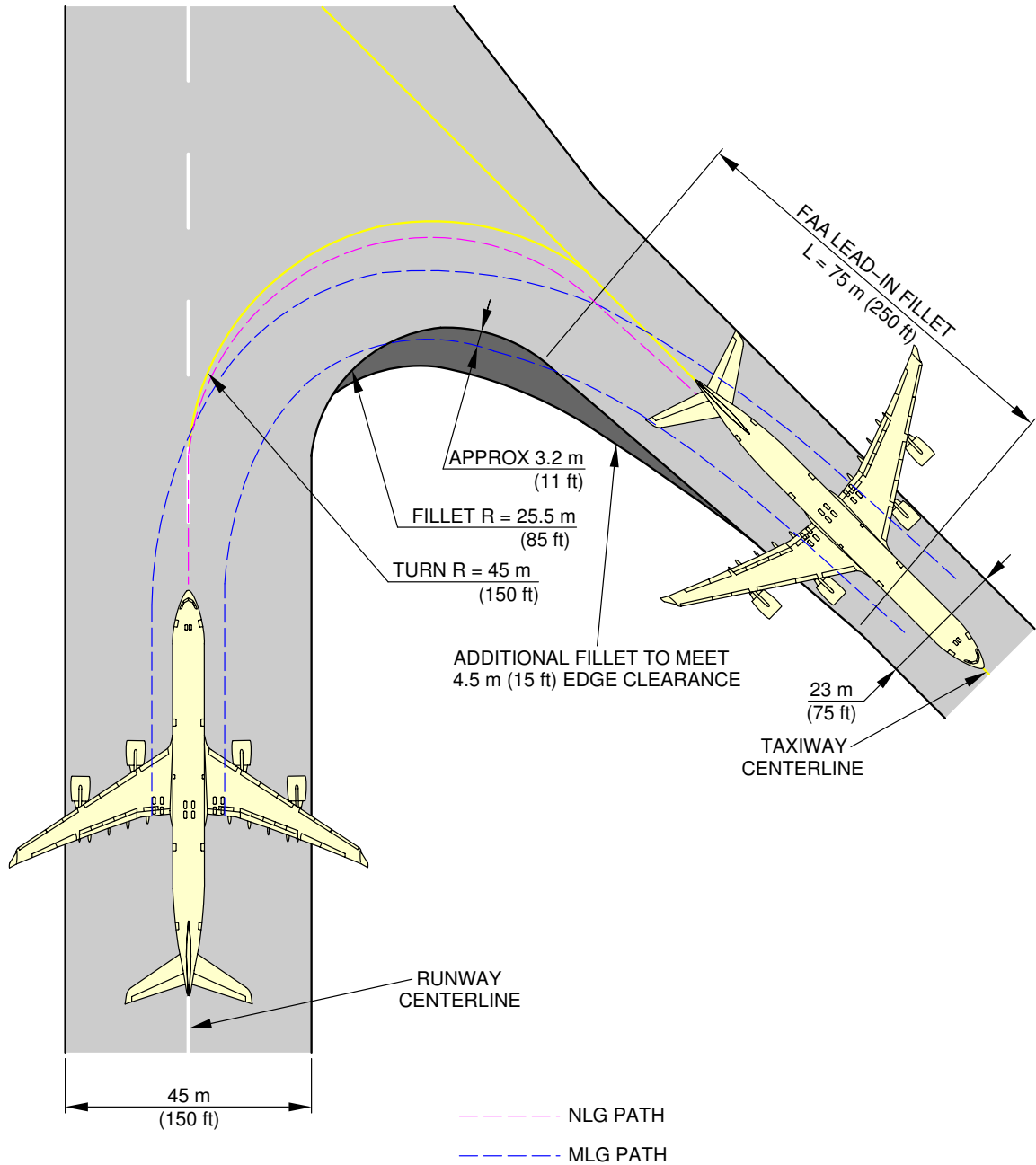

F_AC_040501_1_0110101_01_00

135° Turn - Runway to Taxiway
Cockpit Over Centerline Method
FIGURE-4-5-1-991-011-A01

A340-500/-600

AIRCRAFT CHARACTERISTICS - AIRPORT AND MAINTENANCE PLANNING

**ON A/C A340-500

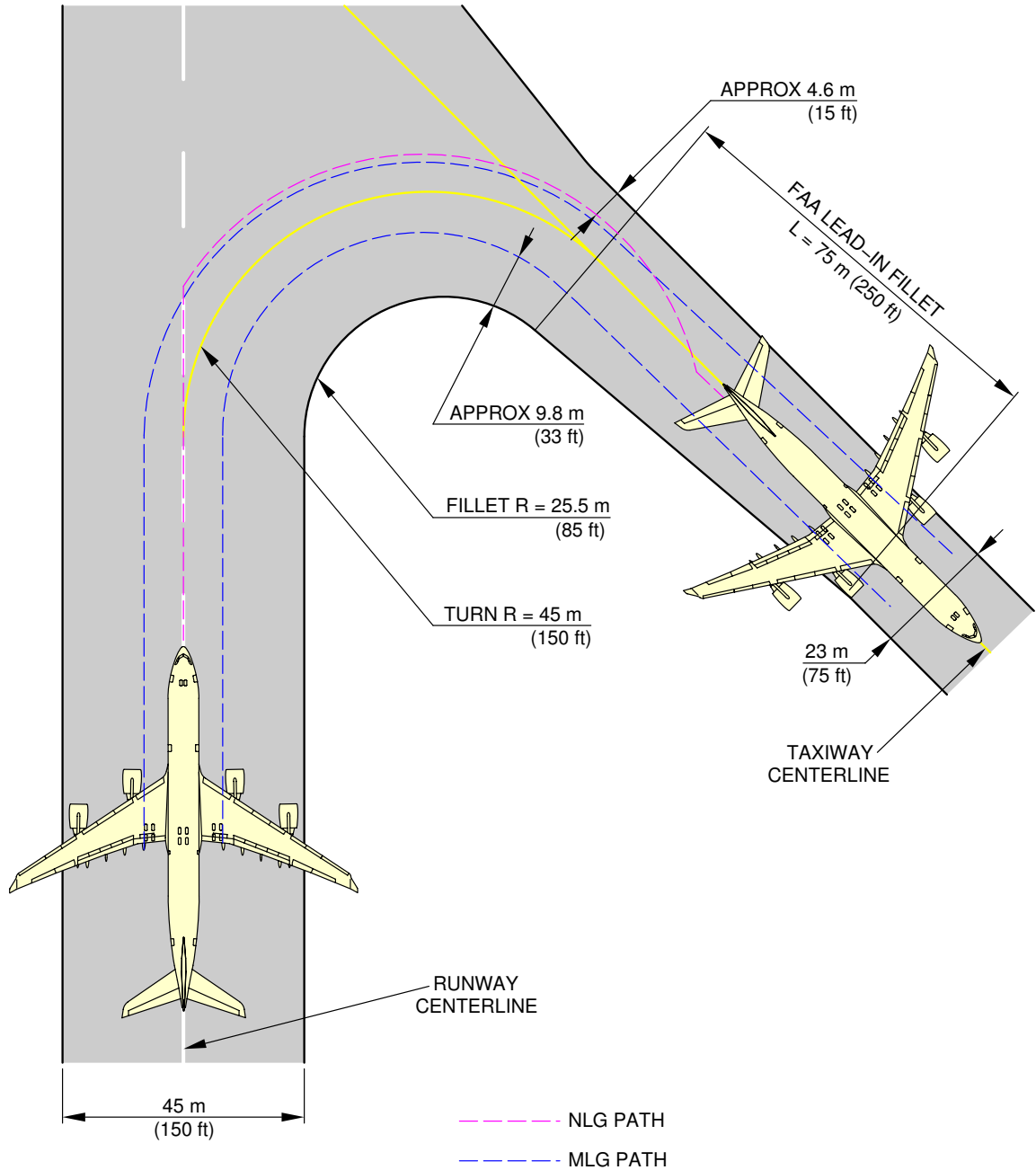

F_AC_040501_1_0050101_01_01

135° Turn - Runway to Taxiway
Judgemental Oversteering Method
FIGURE-4-5-1-991-005-A01

A340-500/-600

AIRCRAFT CHARACTERISTICS - AIRPORT AND MAINTENANCE PLANNING

**ON A/C A340-500

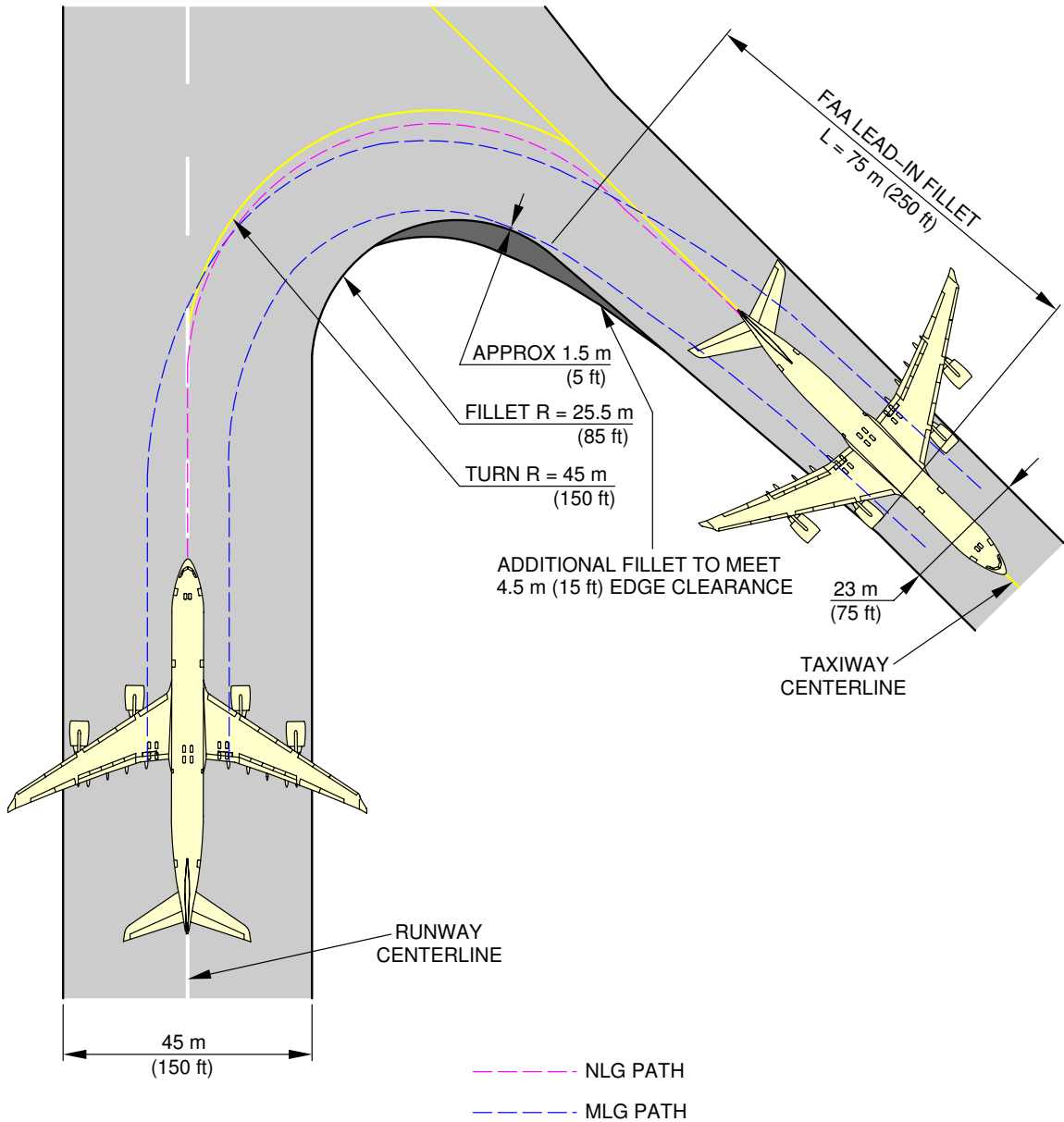

F_AC_040501_1_0120101_01_00

135° Turn - Runway to Taxiway
Cockpit Over Centerline Method
FIGURE-4-5-1-991-012-A01

A340-500/-600

AIRCRAFT CHARACTERISTICS - AIRPORT AND MAINTENANCE PLANNING

4-5-2 90 ° Turn - Runway to Taxiway

****ON A/C A340-500 A340-600**

90 ° Turn - Runway to Taxiway

1. This section gives the 90 ° turn - runway to taxiway.

A340-500/-600

AIRCRAFT CHARACTERISTICS - AIRPORT AND MAINTENANCE PLANNING

**ON A/C A340-600

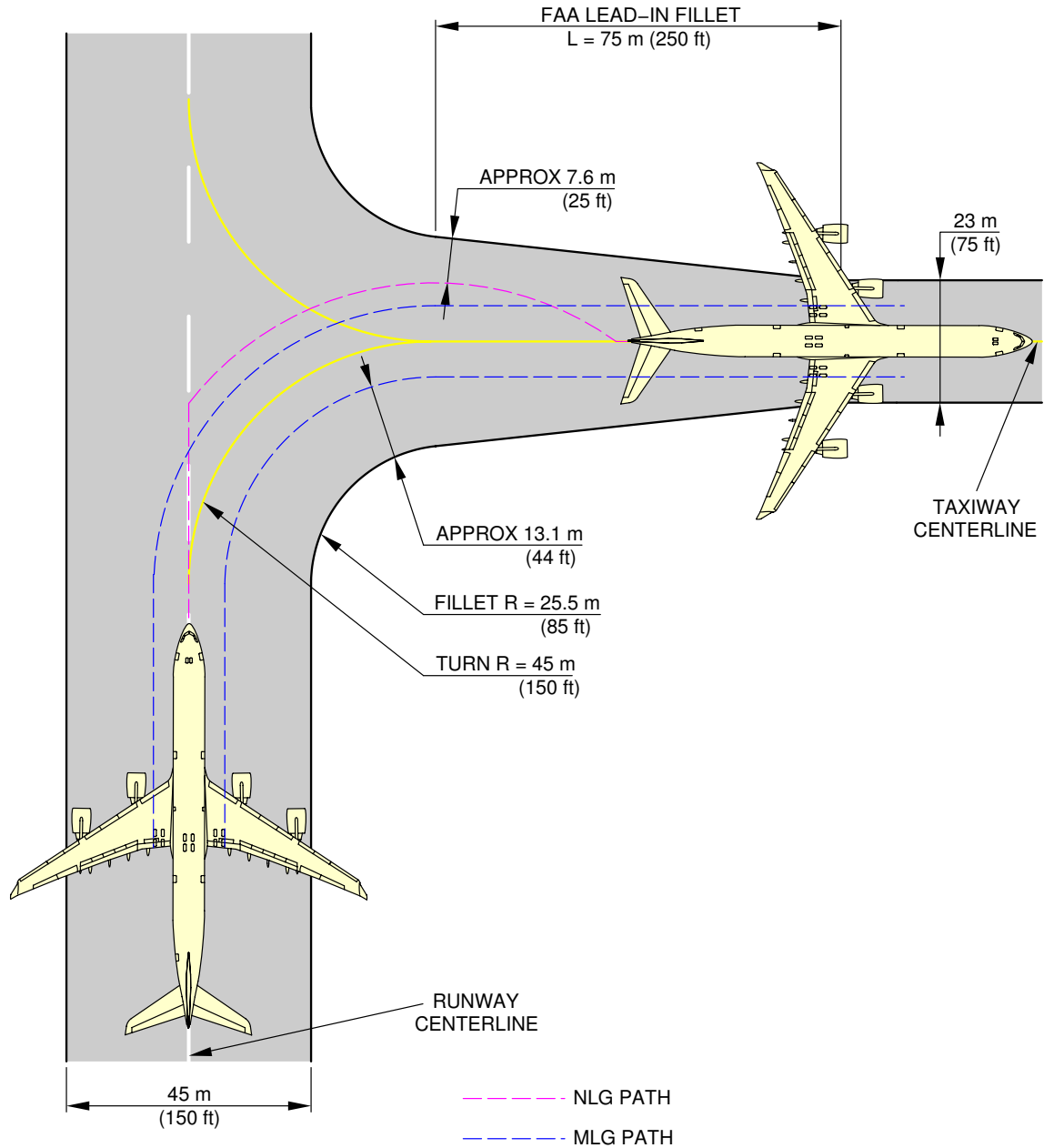

F_AC_040502_1_0040101_01_01

90° Turn - Runway to Taxiway
Judgement Oversteering Method
FIGURE-4-5-2-991-004-A01

A340-500/-600

AIRCRAFT CHARACTERISTICS - AIRPORT AND MAINTENANCE PLANNING

**ON A/C A340-600

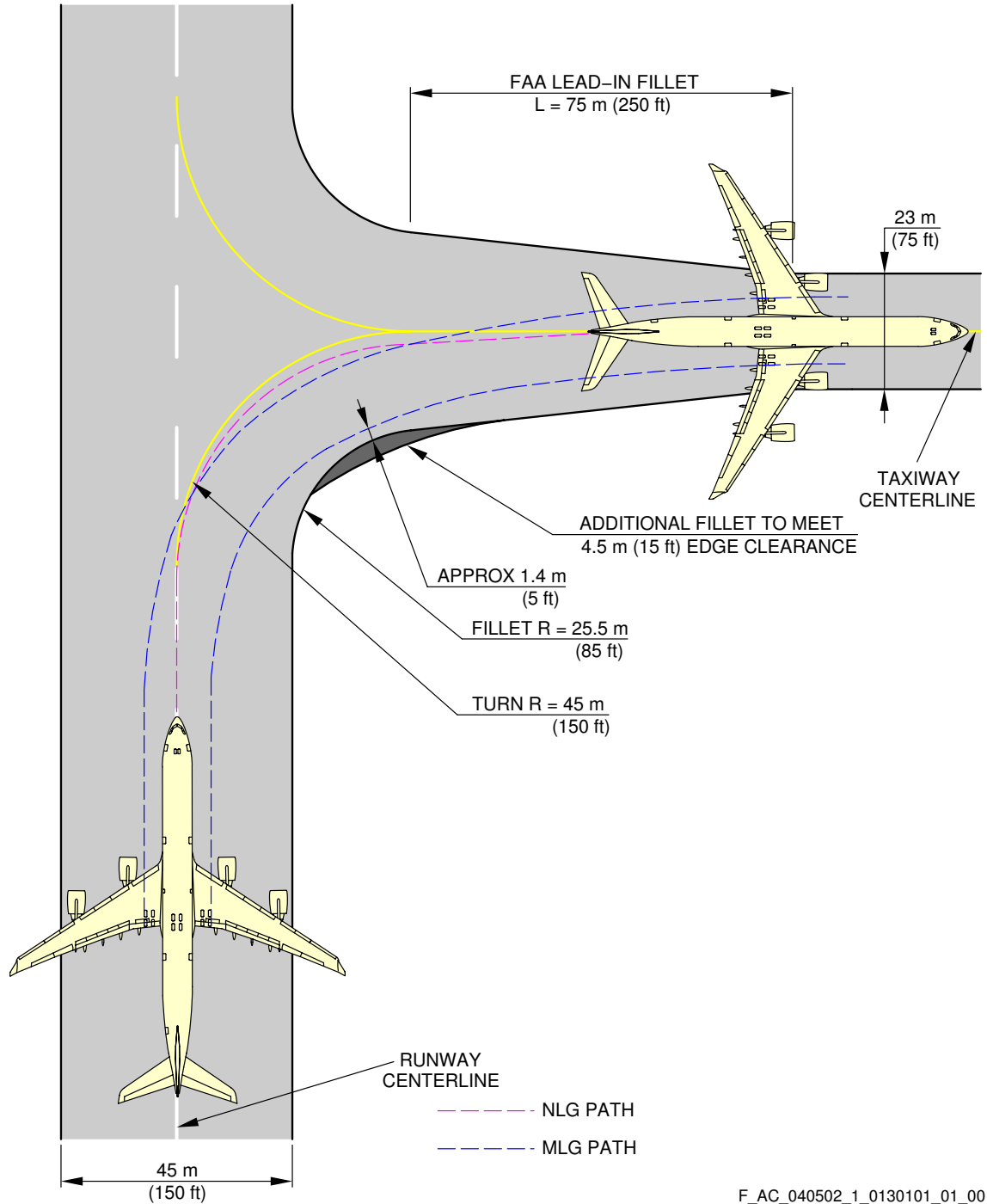

F_AC_040502_1_0130101_01_00

90° Turn - Runway to Taxiway
Cockpit Over Centerline Method
FIGURE-4-5-2-991-013-A01

A340-500/-600

AIRCRAFT CHARACTERISTICS - AIRPORT AND MAINTENANCE PLANNING

**ON A/C A340-500

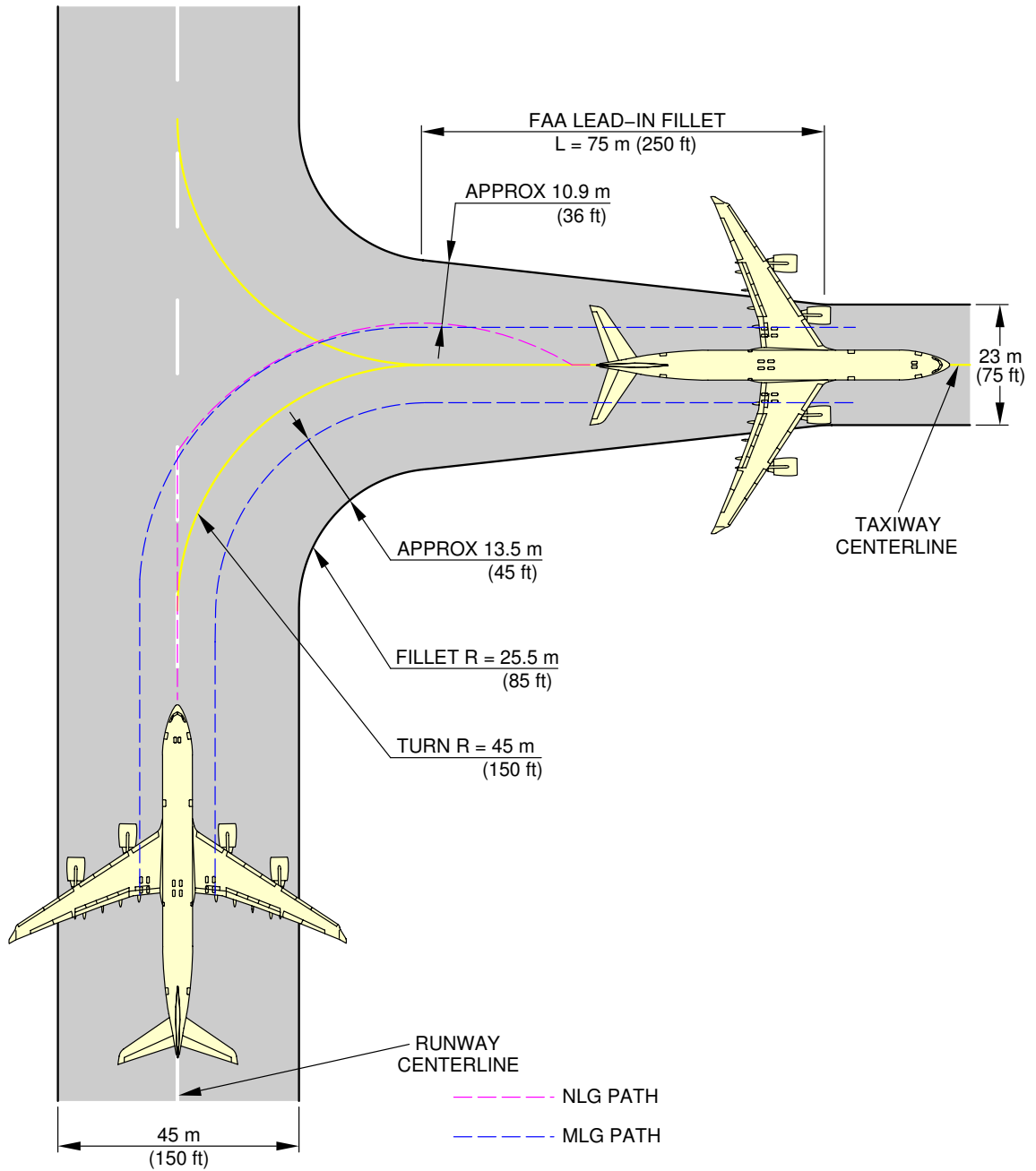

F_AC_040502_1_0050101_01_01

90° Turn - Runway to Taxiway
Judgement Oversteering Method
FIGURE-4-5-2-991-005-A01

A340-500/-600

AIRCRAFT CHARACTERISTICS - AIRPORT AND MAINTENANCE PLANNING

**ON A/C A340-500

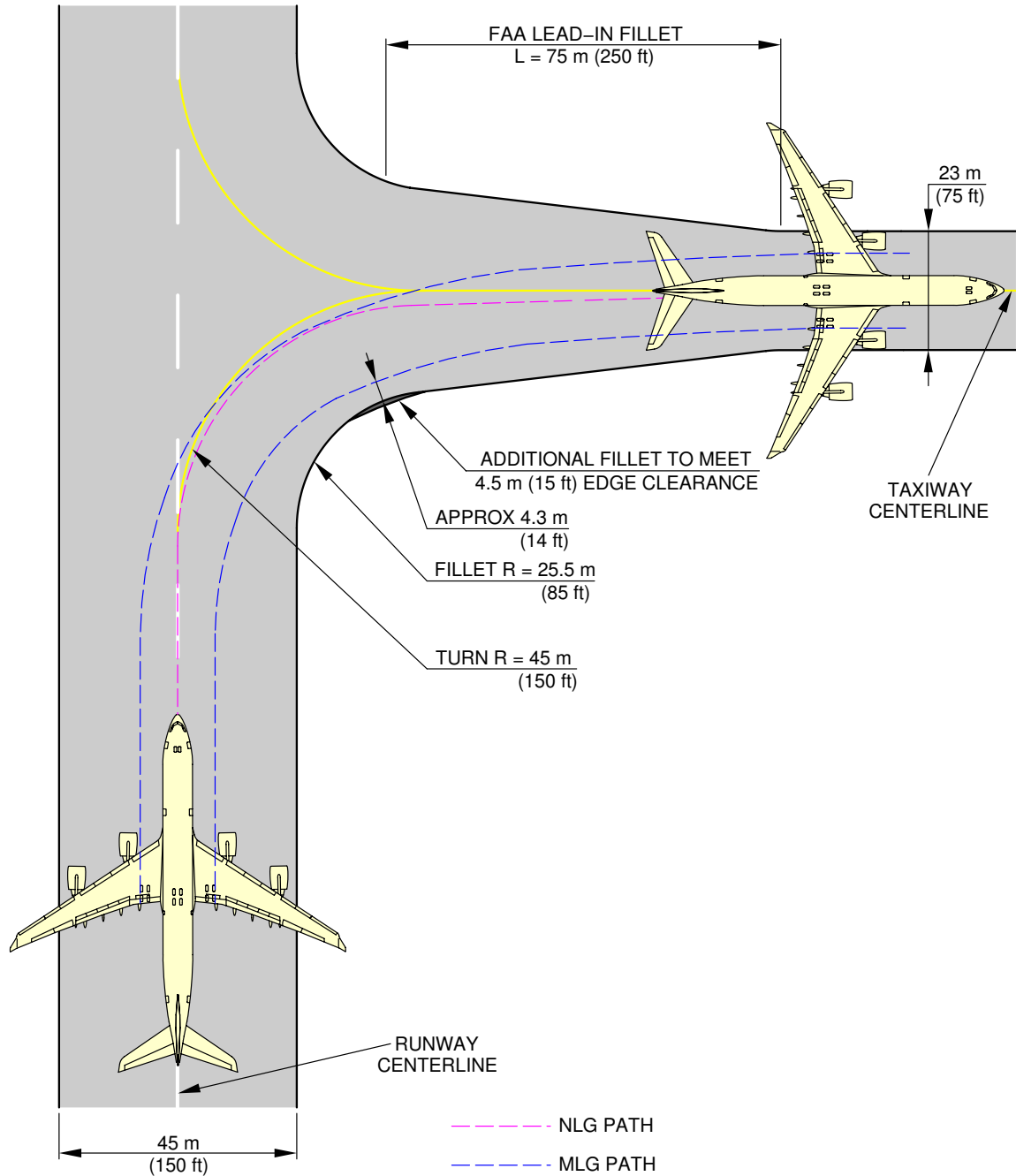

F_AC_040502_1_0140101_01_00

90° Turn - Runway to Taxiway
Cockpit Over Centerline Method
FIGURE-4-5-2-991-014-A01

4-5-3 180° Turn on a Runway****ON A/C A340-500 A340-600**180° Turn on a Runway

1. This section provides the 180° turn on a runway.

A340-500/-600

AIRCRAFT CHARACTERISTICS - AIRPORT AND MAINTENANCE PLANNING

****ON A/C A340-600**

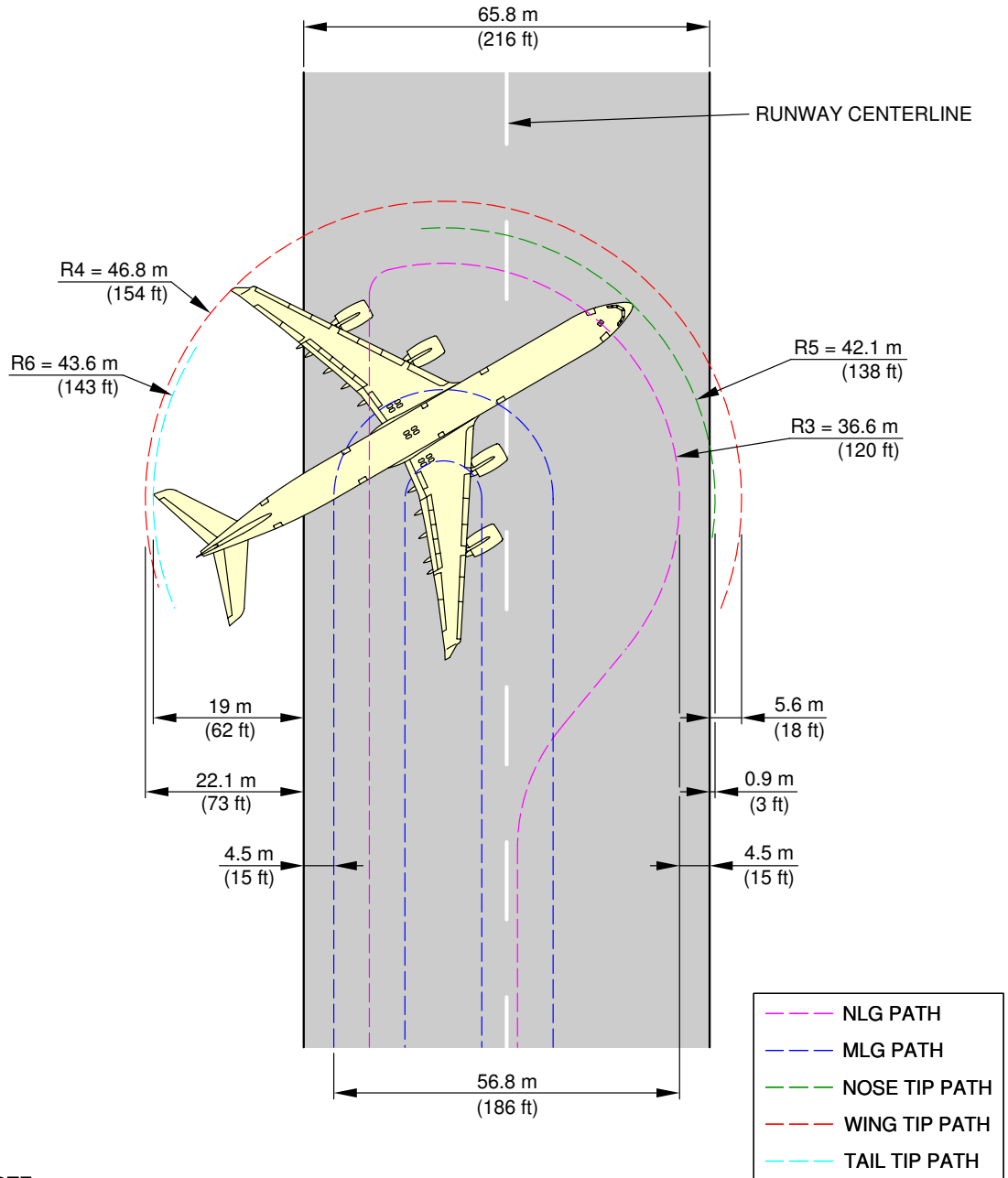

NOTE:

TYPE 2 VALUES FOR MAX STEERING ANGLE = 75°.

F_AC_040503_1_0090101_01_03

180° Turn on a Runway
FIGURE-4-5-3-991-009-A01

A340-500/-600

AIRCRAFT CHARACTERISTICS - AIRPORT AND MAINTENANCE PLANNING

**ON A/C A340-500

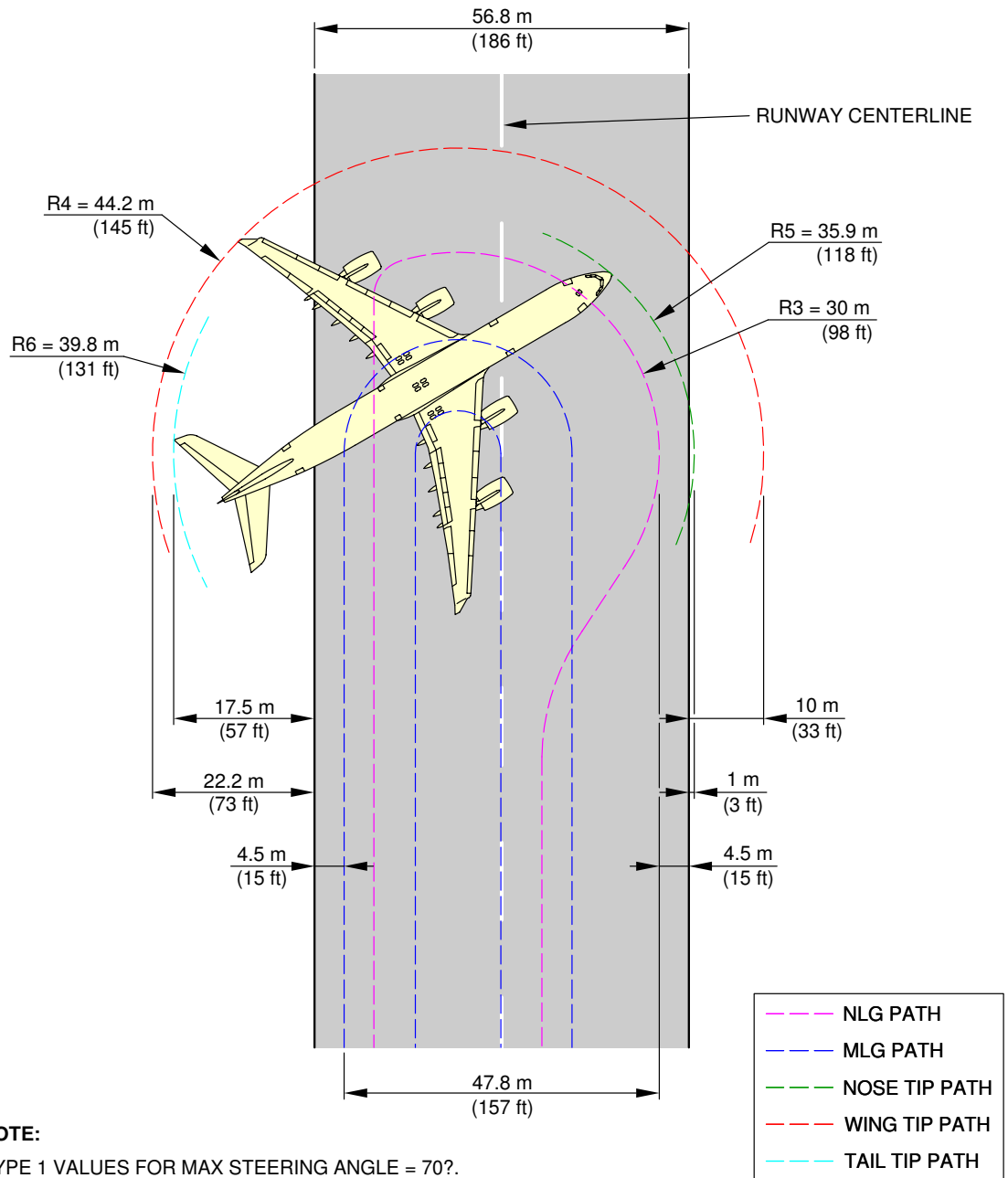

NOTE:

TYPE 1 VALUES FOR MAX STEERING ANGLE = 70°.
IT IS POSSIBLE TO GET LOWER VALUES THAN THOSE FROM TYPE 1
BY APPLYING DIFFERENTIAL BRAKING DURING THE WHOLE TURN.

F_AC_040503_1_0100101_01_03

180° Turn on a Runway
FIGURE-4-5-3-991-010-A01

4-5-4 135 ° Turn - Taxiway to Taxiway

****ON A/C A340-500 A340-600**

135 ° Turn - Taxiway to Taxiway

1. This section gives the 135 ° turn - taxiway to taxiway.

A340-500/-600

AIRCRAFT CHARACTERISTICS - AIRPORT AND MAINTENANCE PLANNING

**ON A/C A340-600

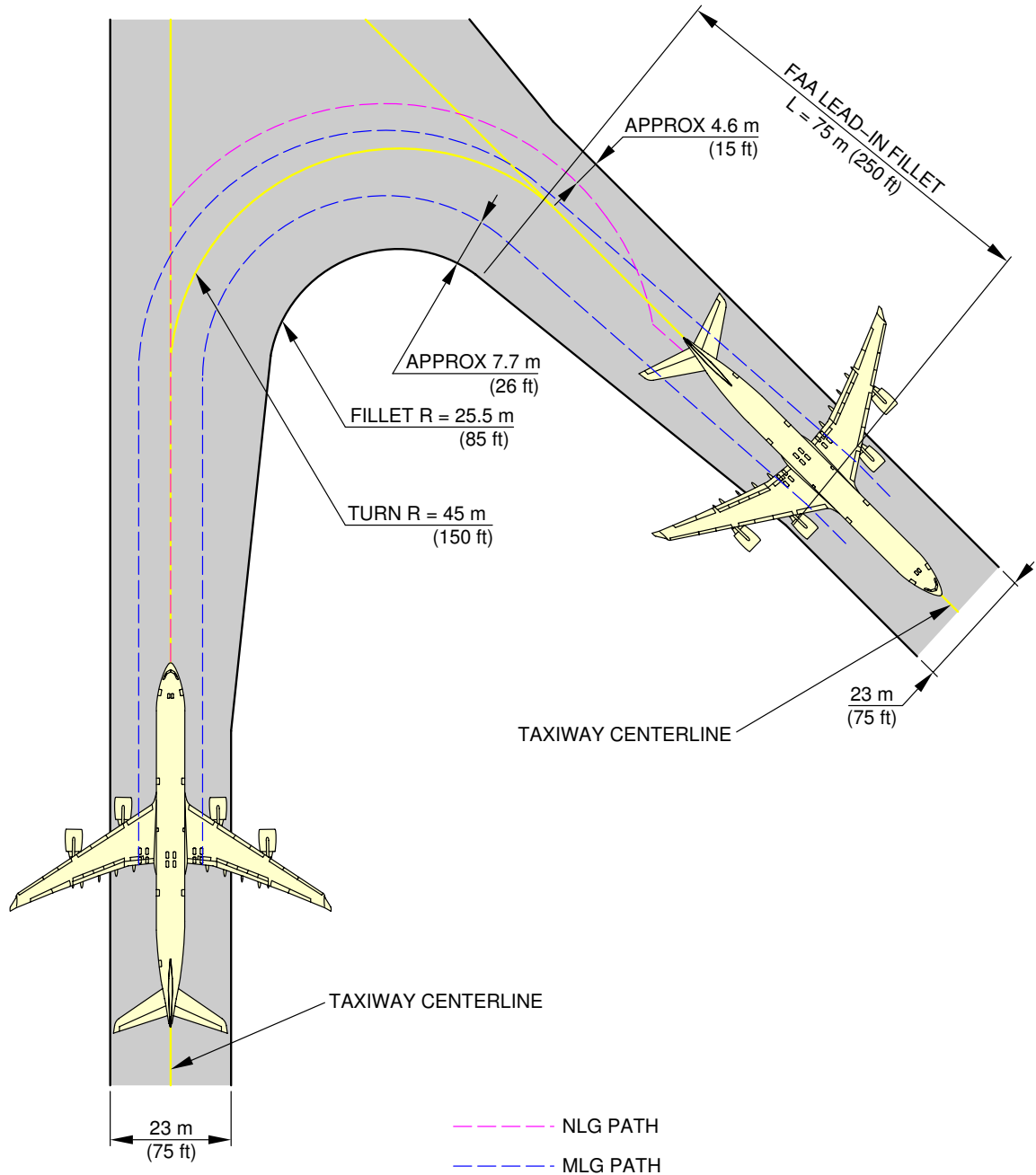

F_AC_040504_1_0050101_01_01

135° Turn - Taxiway to Taxiway
Judgement Oversteering Method
FIGURE-4-5-4-991-005-A01

A340-500/-600

AIRCRAFT CHARACTERISTICS - AIRPORT AND MAINTENANCE PLANNING

**ON A/C A340-600

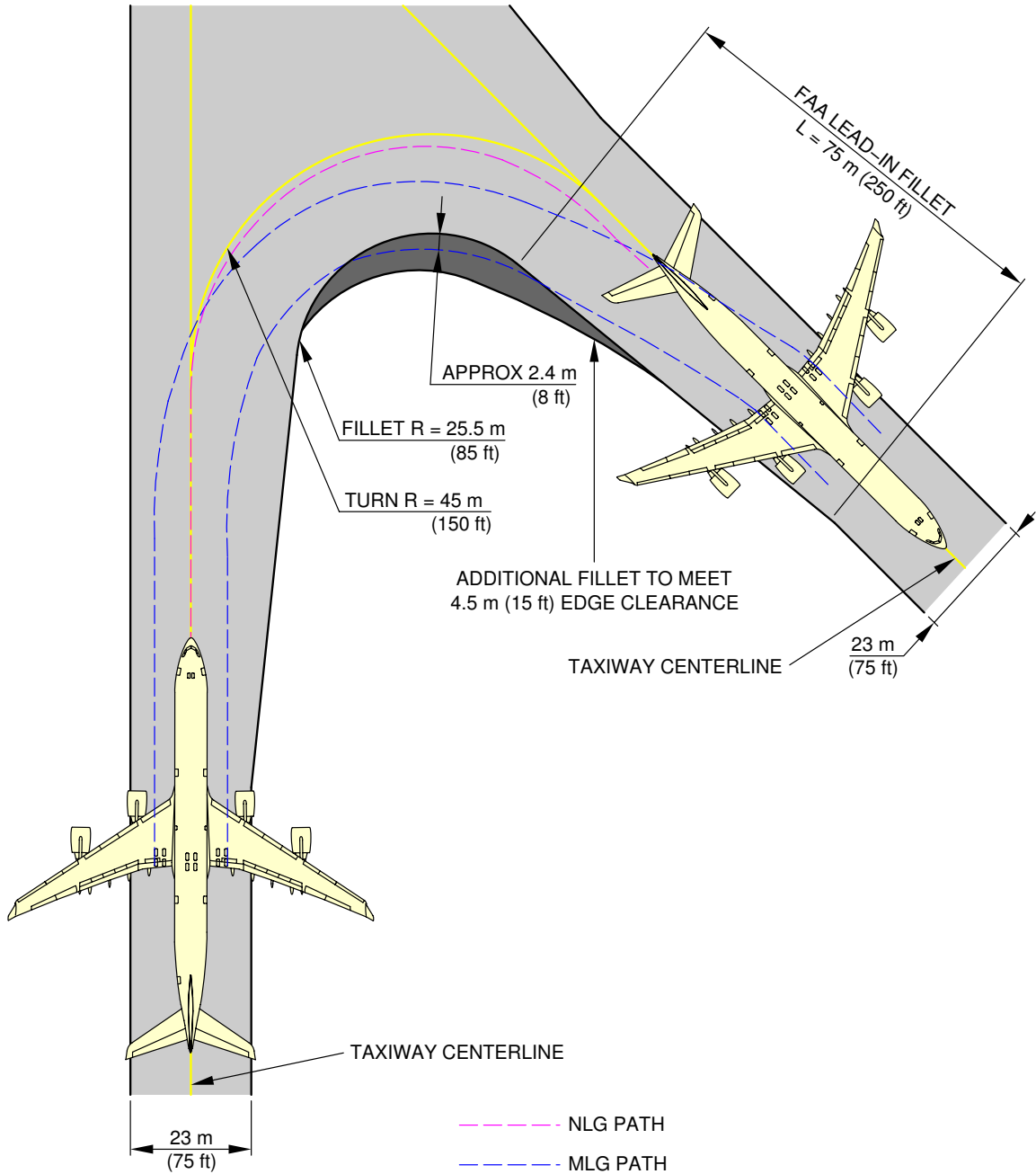

F_AC_040504_1_0130101_01_00

135° Turn - Taxiway to Taxiway
Cockpit Over Centerline Method
FIGURE-4-5-4-991-013-A01

A340-500/-600

AIRCRAFT CHARACTERISTICS - AIRPORT AND MAINTENANCE PLANNING

**ON A/C A340-500

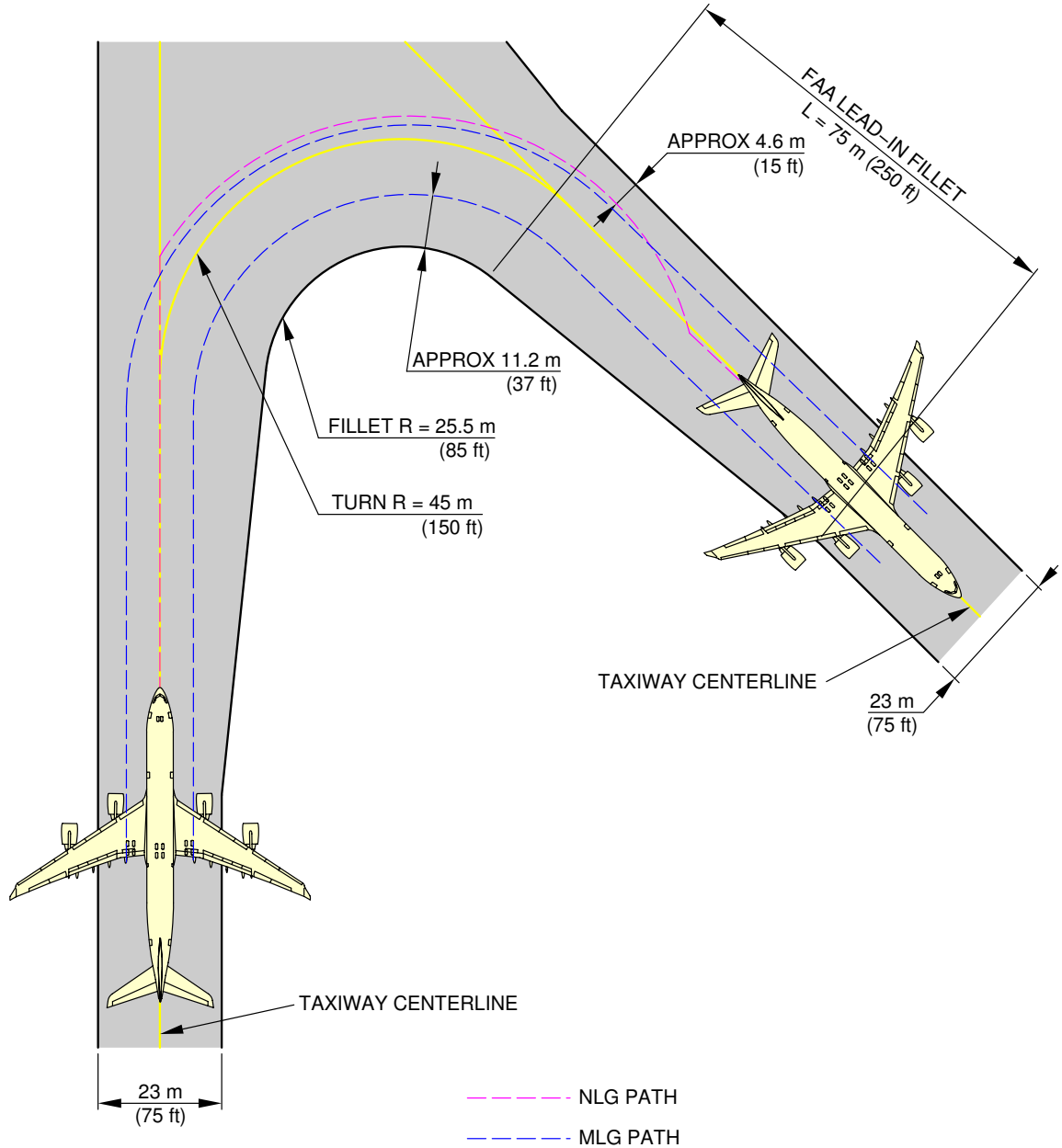

F_AC_040504_1_0060101_01_01

135° Turn - Taxiway to Taxiway
Judgement Oversteering Method
FIGURE-4-5-4-991-006-A01

A340-500/-600

AIRCRAFT CHARACTERISTICS - AIRPORT AND MAINTENANCE PLANNING

**ON A/C A340-500

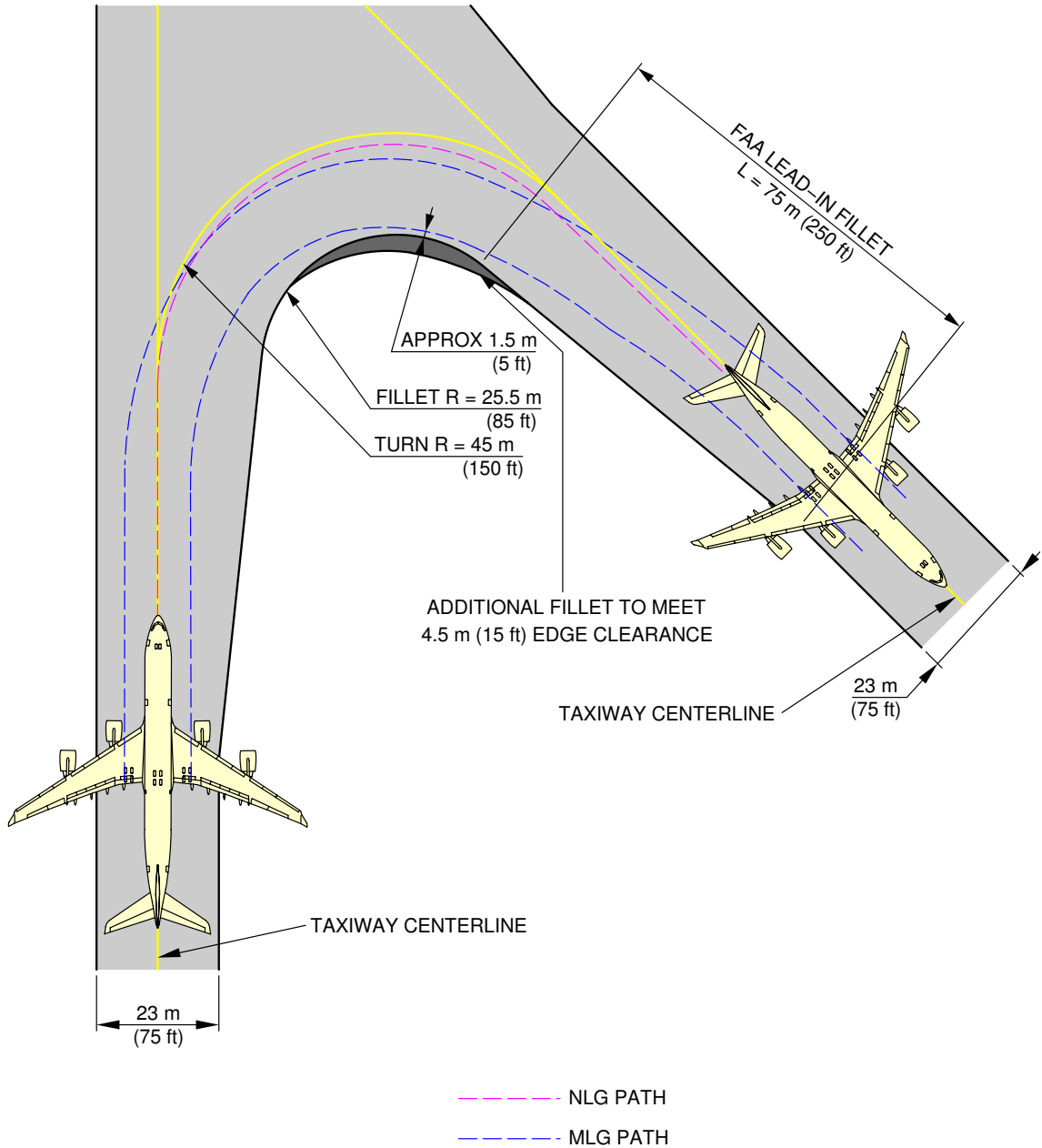

F_AC_040504_1_0140101_01_00

135° Turn - Taxiway to Taxiway
Cockpit Over Centerline Method
FIGURE-4-5-4-991-014-A01

A340-500/-600

AIRCRAFT CHARACTERISTICS - AIRPORT AND MAINTENANCE PLANNING

4-5-5 90° Turn - Taxiway to Taxiway

****ON A/C A340-500 A340-600**

90° Turn - Taxiway to Taxiway

1. This section gives the 90° turn - taxiway to taxiway.

A340-500/-600

AIRCRAFT CHARACTERISTICS - AIRPORT AND MAINTENANCE PLANNING

**ON A/C A340-600

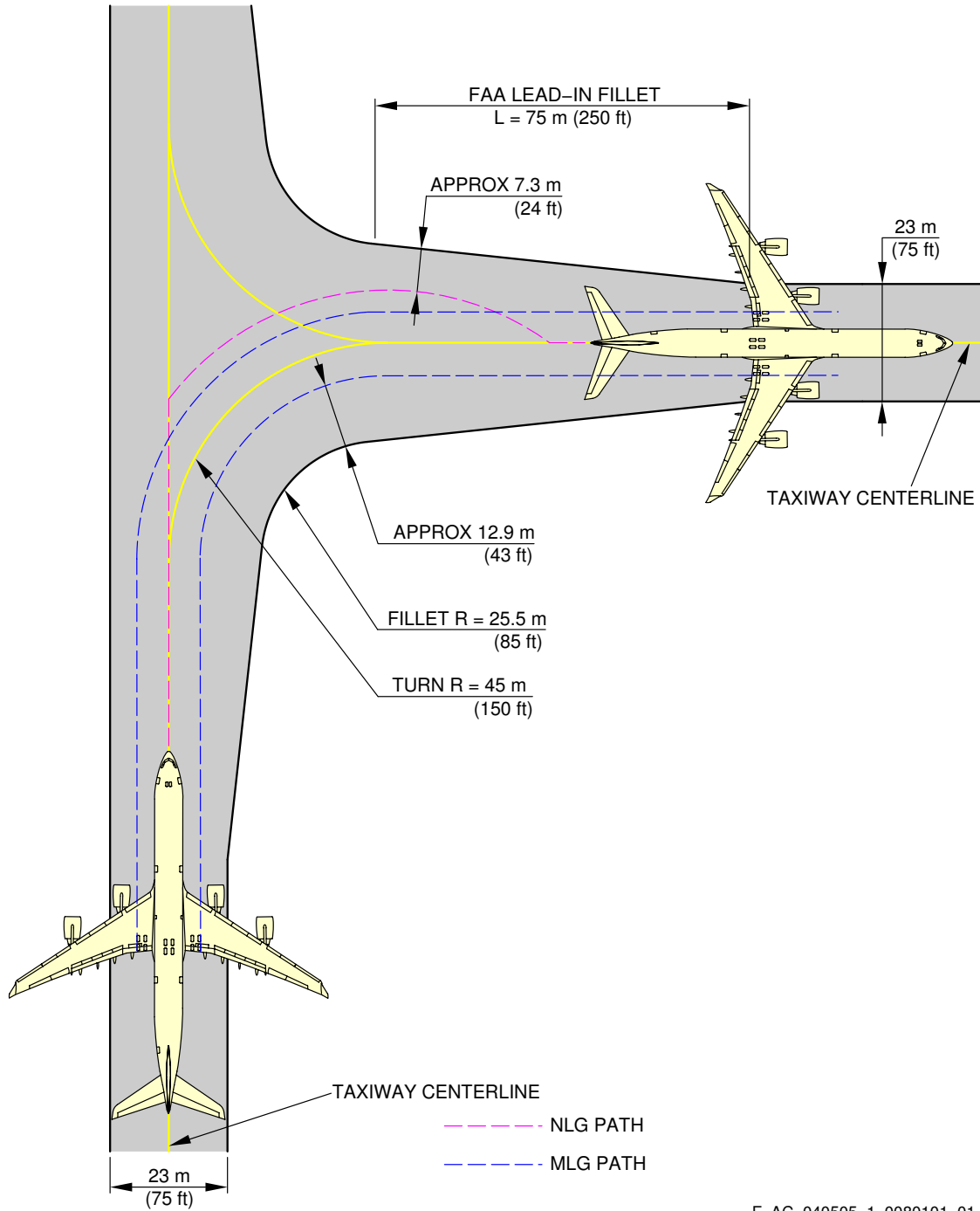

F_AC_040505_1_0080101_01_01

90° Turn - Taxiway to Taxiway
Judgemental Oversteering Method
FIGURE-4-5-5-991-008-A01

A340-500/-600

AIRCRAFT CHARACTERISTICS - AIRPORT AND MAINTENANCE PLANNING

**ON A/C A340-600

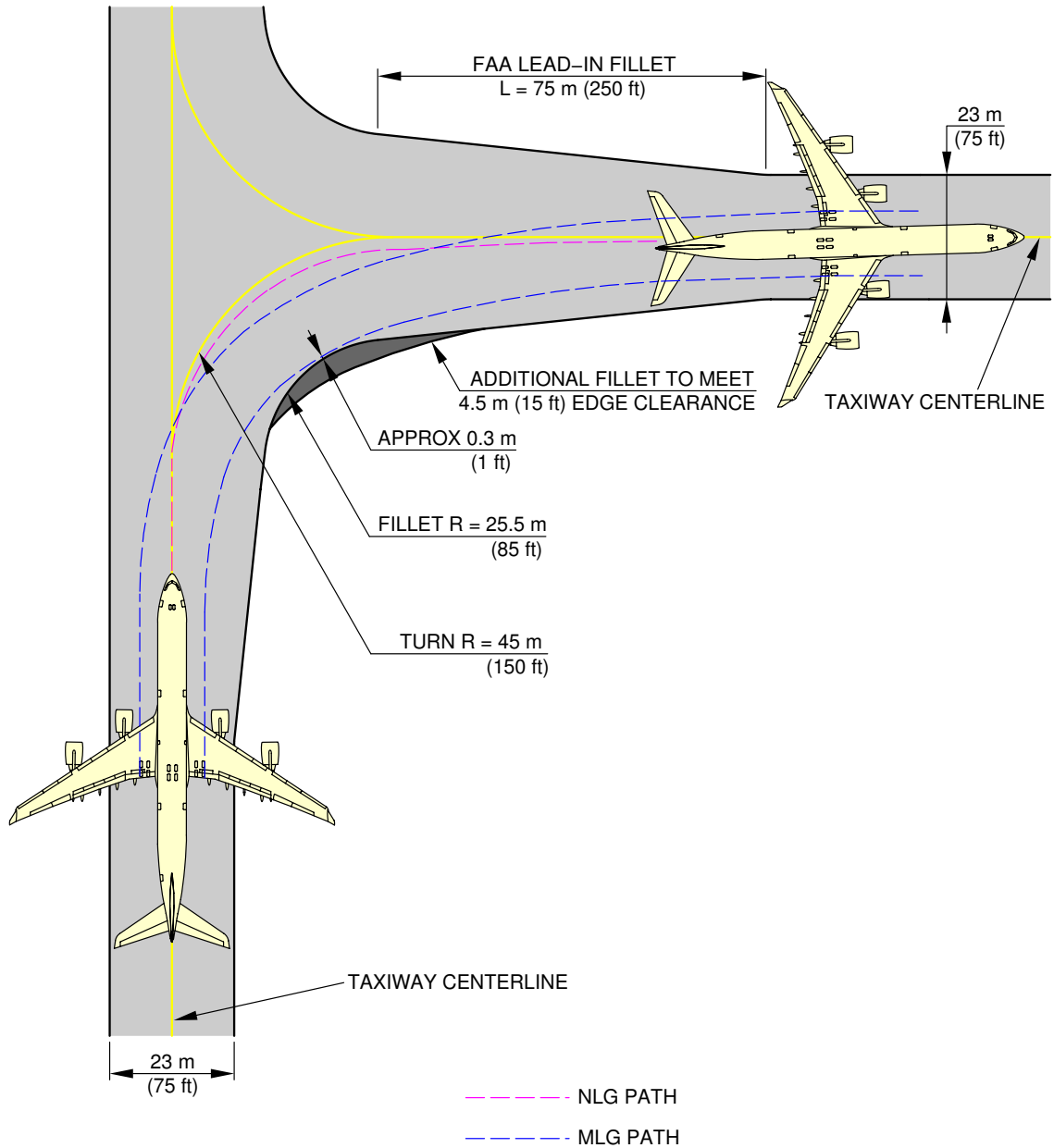

F_AC_040505_1_0150101_01_00

90° Turn - Taxiway to Taxiway
Cockpit Over Centerline Method
FIGURE-4-5-5-991-015-A01

A340-500/-600

AIRCRAFT CHARACTERISTICS - AIRPORT AND MAINTENANCE PLANNING

**ON A/C A340-500

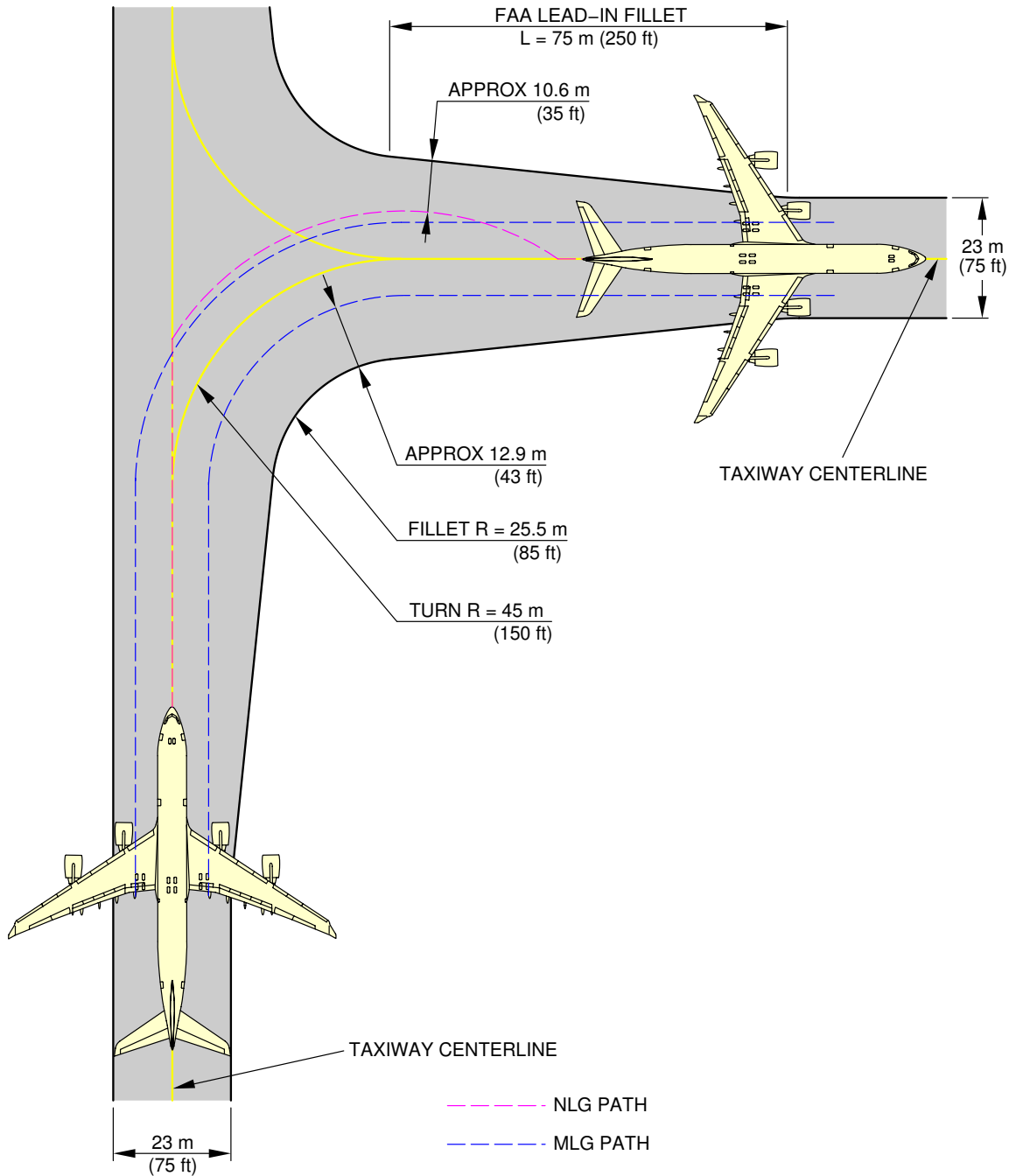

F_AC_040505_1_0090101_01_01

90° Turn - Taxiway to Taxiway
Judgemental Oversteering Method
FIGURE-4-5-5-991-009-A01

A340-500/-600

AIRCRAFT CHARACTERISTICS - AIRPORT AND MAINTENANCE PLANNING

**ON A/C A340-500

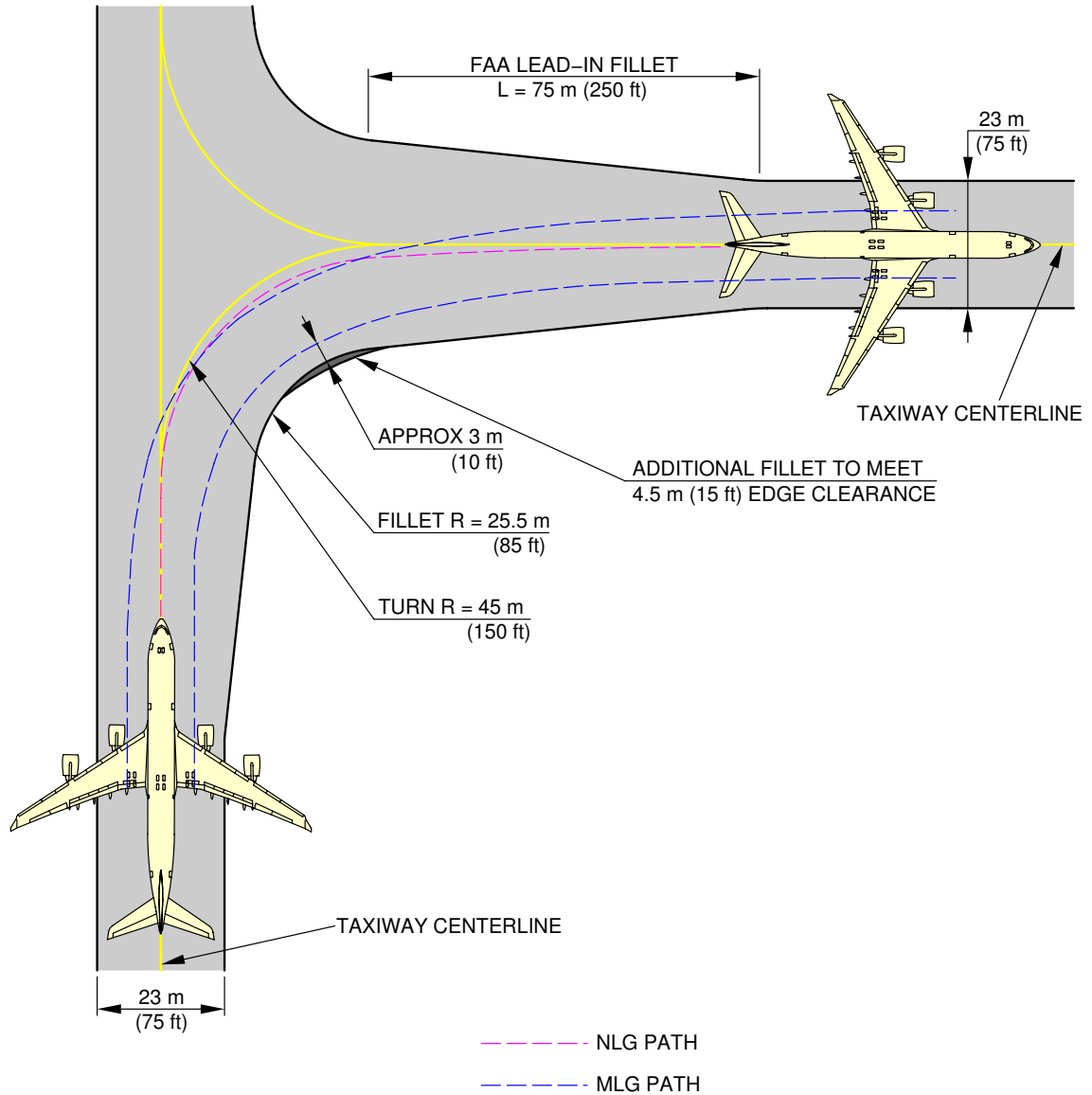

F_AC_040505_1_0160101_01_00

90° Turn - Taxiway to Taxiway
Cockpit Over Centerline Method
FIGURE-4-5-5-991-016-A01

4-6-0 Runway Holding Bay (Apron)****ON A/C A340-500 A340-600**Runway Holding Bay (Apron)

1. This section provides the runway holding bay (Apron).

A340-500/-600

AIRCRAFT CHARACTERISTICS - AIRPORT AND MAINTENANCE PLANNING

**ON A/C A340-500 A340-600

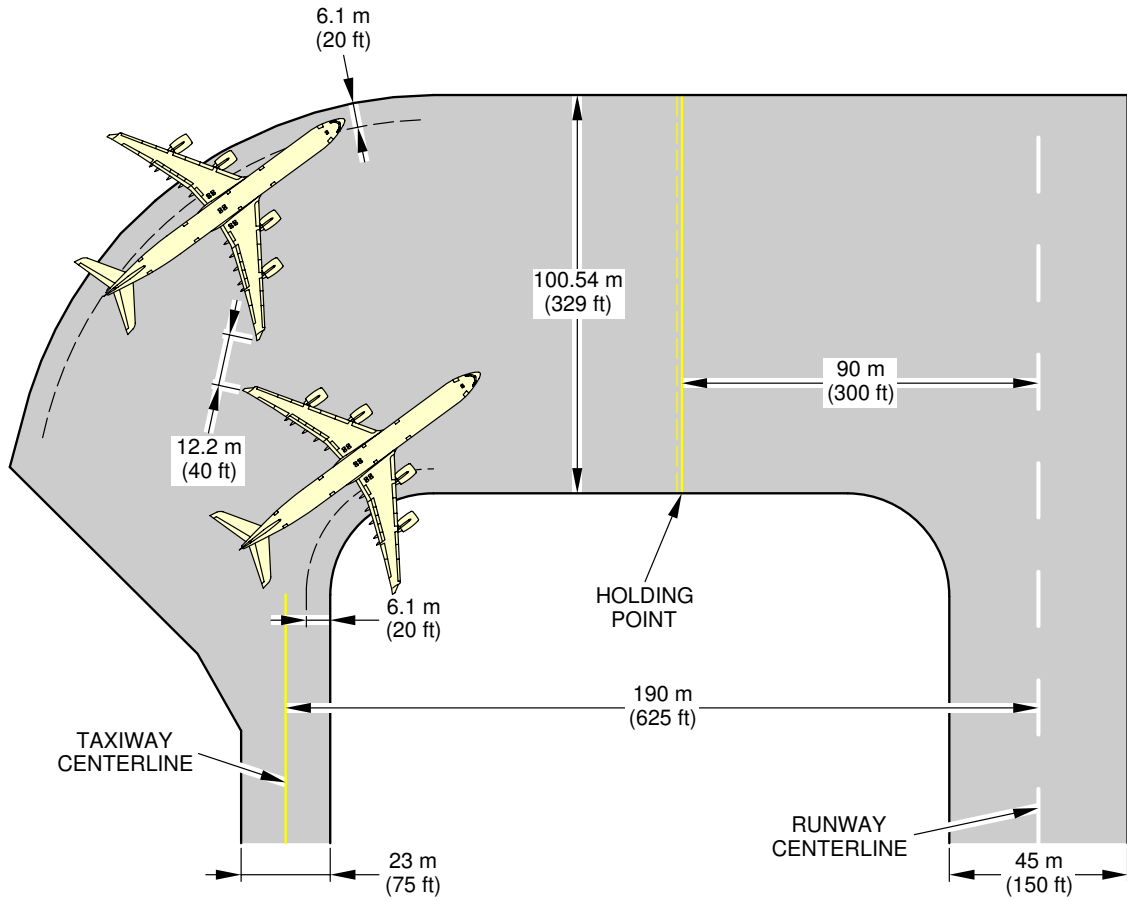

NOTE:

20° NOSE-WHEEL STEERING ANGLE.
COORDINATE WITH USING AIRLINE FOR SPECIFIC PLANNED OPERATING PROCEDURES.

F_AC_040600_1_0040101_01_02

Runway Holding Bay (Apron)
FIGURE-4-6-0-991-004-A01

4-7-0 Minimum Line-Up Distance Corrections

****ON A/C A340-500 A340-600**

Minimum Line-Up Distance Corrections

1. The ground maneuvers were performed using asymmetric thrust and differential-only braking to initiate the turn.
TODA: Take-Off Distance Available
ASDA: Acceleration-Stop Distance Available
2. 90° Turn on Runway Entry
This section gives the minimum line-up distance correction for a 90° turn on runway entry. This maneuver consists in a 90° turn at minimum turn radius. It starts with the edge of the MLG at a distance of 4.5 m (15 ft) from the taxiway edge, and finishes with the aircraft aligned on the centerline of the runway, see FIGURE 4-7-0-991-025-A.
During the turn, all the clearances must meet the minimum value of 4.5 m (15 ft) for this category of aircraft as recommended in ICAO Annex 14.
3. 180° Turn on Runway Turn Pad
This section gives the minimum line-up distance correction for a 180° turn on the runway turn pad. This maneuver consists in a 180° turn at minimum turn radius on a runway turn pad with standard ICAO geometry.
It starts with the edge of the MLG at a distance of 4.5 m (15 ft) from the pavement edge, and it finishes with the aircraft aligned on the centerline of the runway, see FIGURE 4-7-0-991-026-A.
During the turn, all the clearances must meet the minimum value of 4.5 m (15 ft) for this category of aircraft as recommended in ICAO Annex 14.
4. 180° Turn on Runway Width
This section gives the minimum line-up distance correction for a 180° turn on the runway width. For this maneuver, the pavement width is considered to be the runway width, which is a frozen parameter (45 m (150 ft) and 60 m (200 ft)).
As per the standard operating procedures for the "180° turn on runway" (described in the Flight Crew Operating Manual), the aircraft is initially angled with respect to the runway centerline when starting the 180° turn, see FIGURE 4-7-0-991-027-A.
The value of this angle depends on the aircraft type and is mentioned in the FCOM.
During the turn, all the clearances must meet the minimum value of 4.5 m (15 ft) for this category of aircraft as recommended in ICAO Annex 14.

A340-500/-600

AIRCRAFT CHARACTERISTICS - AIRPORT AND MAINTENANCE PLANNING

****ON A/C A340-500 A340-600**

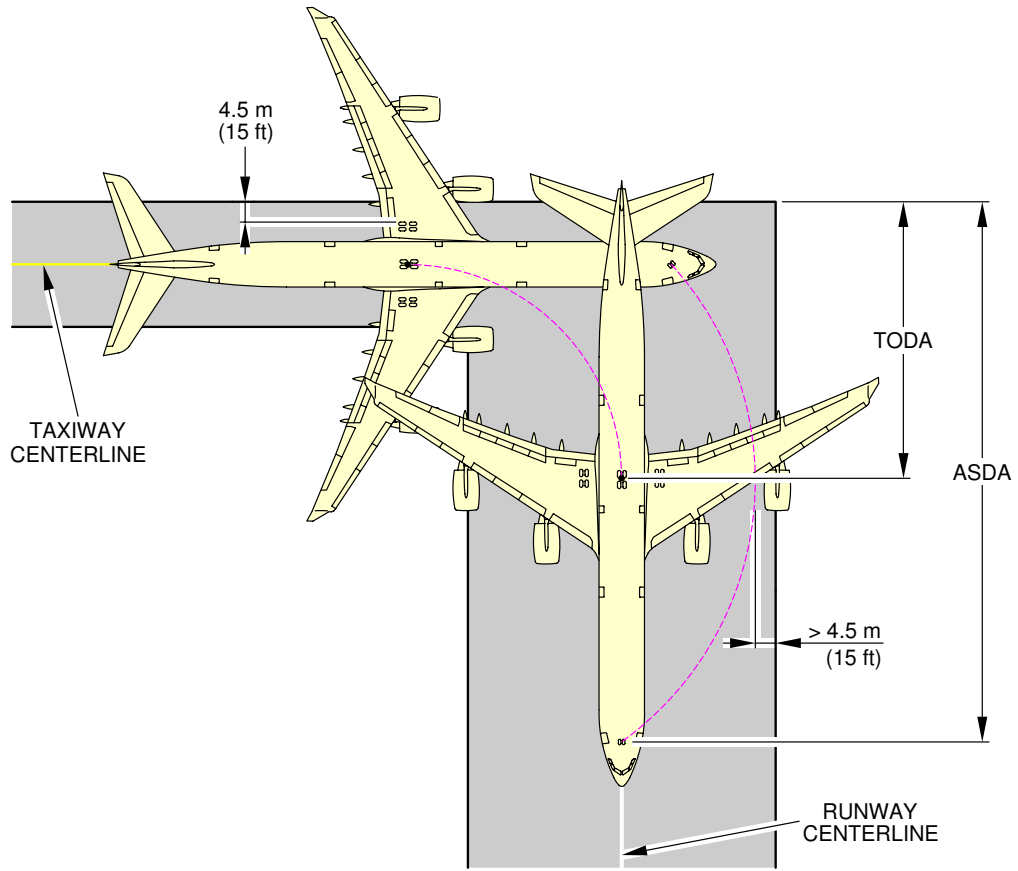

		90° TURN ON RUNWAY ENTRY							
AIRCRAFT TYPE	MAX STEERING ANGLE	45 m (150 ft) WIDE RUNWAY (STANDARD WIDTH)				60 m (200 ft) WIDE RUNWAY			
		MINIMUM LINE-UP DISTANCE CORRECTION				MINIMUM LINE-UP DISTANCE CORRECTION			
		ON TODA		ON ASDA		ON TODA		ON ASDA	
A340-500	70°	24.5 m	80 ft	52.5 m	172 ft	22.1 m	73 ft	50.1 m	164 ft
A340-600	76°	33.6 m	110 ft	66.8 m	219 ft	20.5 m	67 ft	53.7 m	176 ft

NOTE:

ASDA: ACCELERATION-STOP DISTANCE AVAILABLE
TODA: TAKE-OFF DISTANCE AVAILABLE

F_AC_040700_1_0250101_01_00

Minimum Line-Up Distance Corrections
90° Turn on Runway Entry
FIGURE-4-7-0-991-025-A01

A340-500/-600

AIRCRAFT CHARACTERISTICS - AIRPORT AND MAINTENANCE PLANNING

**ON A/C A340-500 A340-600

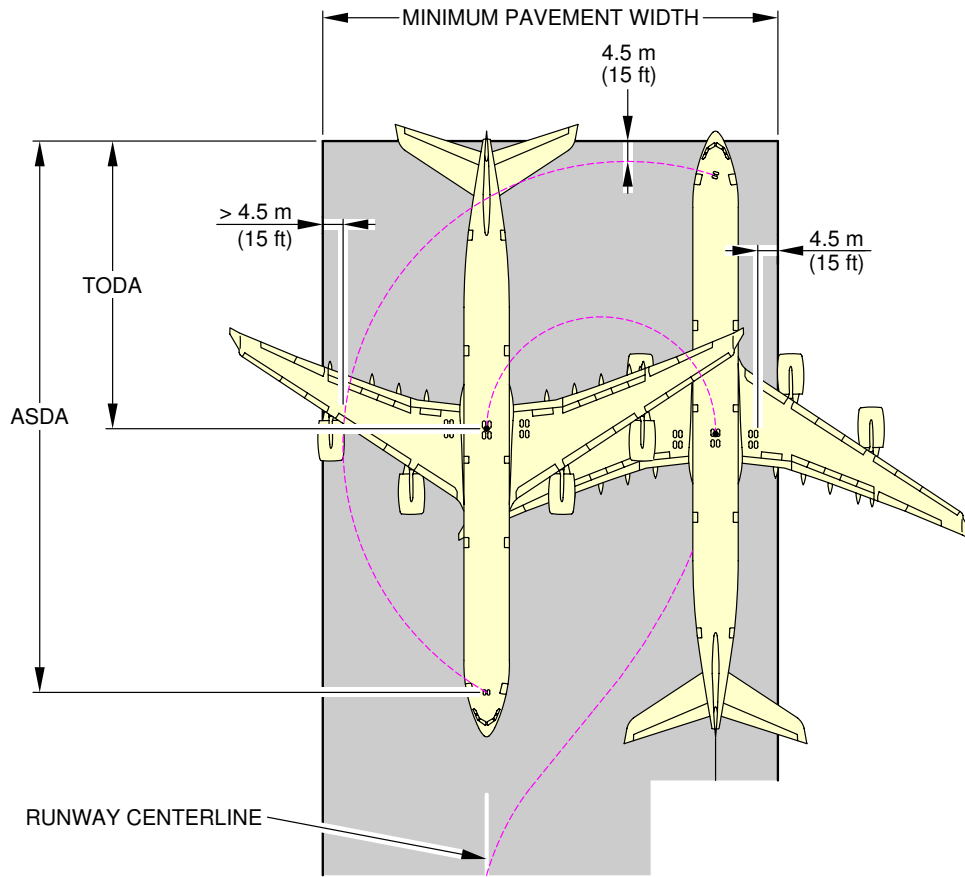

180° TURN ON RUNWAY TURNPAD													
AIRCRAFT TYPE	MAX STEERING ANGLE	45 m (150 ft) WIDE RUNWAY (STANDARD WIDTH)						60 m (200 ft) WIDE RUNWAY					
		MINIMUM LINE-UP DISTANCE CORRECTION				REQUIRED MINIMUM PAVEMENT WIDTH	MINIMUM LINE-UP DISTANCE CORRECTION			REQUIRED MINIMUM PAVEMENT WIDTH			
		ON TODA		ON ASDA			ON TODA		ON ASDA				
A340-500	70°	36.2 m	119 ft	64.2 m	210 ft	60.7 m	199 ft	35.2 m	116 ft	63.2 m	207 ft	63.4 m	208 ft
A340-600	76°	45.3 m	149 ft	78.5 m	258 ft	78.9 m	259 ft	39.7 m	130 ft	72.9 m	239 ft	60.2 m	198 ft

NOTE:

ASDA: ACCELERATION-STOP DISTANCE AVAILABLE
TODA: TAKE-OFF DISTANCE AVAILABLE

F_AC_040700_1_0260101_01_00

Minimum Line-Up Distance Corrections
180° Turn on Runway Turn Pad
FIGURE-4-7-0-991-026-A01

A340-500/-600

AIRCRAFT CHARACTERISTICS - AIRPORT AND MAINTENANCE PLANNING

**ON A/C A340-500 A340-600

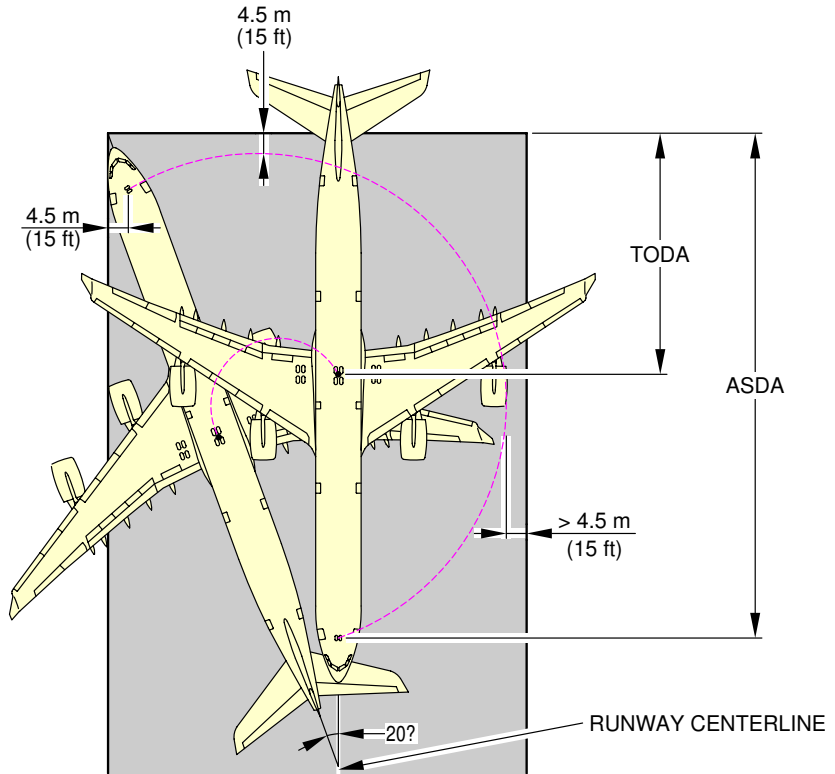

		180° TURN ON RUNWAY WIDTH					
AIRCRAFT TYPE	MAX STEERING ANGLE	45 m (150 ft) WIDE RUNWAY (STANDARD WIDTH)		60 m (200 ft) WIDE RUNWAY			
		MINIMUM LINE-UP DISTANCE CORRECTION		MINIMUM LINE-UP DISTANCE CORRECTION			
		ON TODA	ON ASDA	ON TODA	ON ASDA		
A340-500	70°	NOT POSSIBLE		48.2 m	158 ft	76.2 m	250 ft
A340-600	76°	NOT POSSIBLE		NOT POSSIBLE			

NOTE:

ASDA: ACCELERATION-STOP DISTANCE AVAILABLE

TODA: TAKE-OFF DISTANCE AVAILABLE

F_AC_040700_1_0270101_01_00

Minimum Line-Up Distance Corrections
180° Turn on Runway Width
FIGURE-4-7-0-991-027-A01

A340-500/-600

AIRCRAFT CHARACTERISTICS - AIRPORT AND MAINTENANCE PLANNING

4-8-0 Aircraft Mooring

****ON A/C A340-500 A340-600**

Aircraft Mooring

1. This section provides information on aircraft mooring.

A340-500/-600

AIRCRAFT CHARACTERISTICS - AIRPORT AND MAINTENANCE PLANNING

**ON A/C A340-500 A340-600

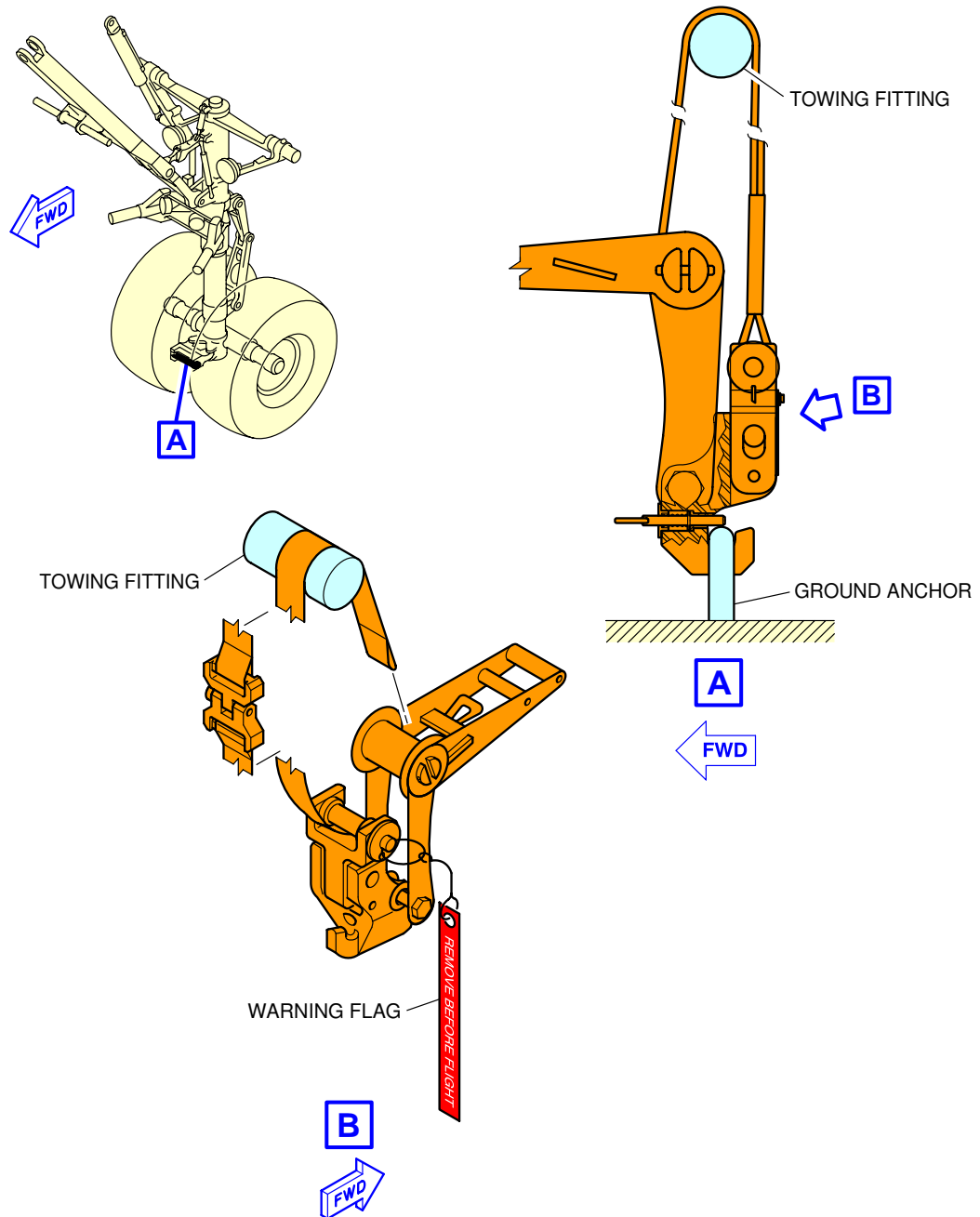

F_AC_040800_1_0010101_01_00

Aircraft Mooring
FIGURE-4-8-0-991-001-A01

TERMINAL SERVICING

5-1-0 Aircraft Servicing Arrangements

****ON A/C A340-500 A340-600**

Aircraft Servicing Arrangements

1. This section provides typical ramp layouts, showing the various GSE items in position during typical turn-round scenarios for passenger aircraft.

These ramp layouts show typical arrangements only. Each operator will have its own specific requirements/regulations for positioning and operation on the ramp.

5-1-1 Symbols Used on Servicing Diagrams

****ON A/C A340-500 A340-600**

Symbols Used on Servicing Diagrams

1. This table gives the symbols used on servicing diagrams.

Ground Support Equipment	
AC	AIR CONDITIONING UNIT
AS	AIR START UNIT
BULK	BULK TRAIN
CAT	CATERING TRUCK
CB	CONVEYOR BELT
CLEAN	CLEANING TRUCK
FUEL	FUEL HYDRANT DISPENSER or TANKER
GPU	GROUND POWER UNIT
LD CL	LOWER DECK CARGO LOADER
LV	LAVATORY VEHICLE
PBB	PASSENGER BOARDING BRIDGE
PS	PASSENGER STAIRS
TOW	TOW TRACTOR
ULD	ULD TRAIN
WV	POTABLE WATER VEHICLE

5-1-2 Typical Ramp Layout - Open Apron

****ON A/C A340-500 A340-600**

Typical Ramp Layout - Open Apron

1. This section provides the typical servicing arrangements on the open apron, for the passenger version of the aircraft.
The Stand Safety Line delimits the Aircraft Safety Area (minimum distance of 7.5 m (24.61 ft) from the aircraft). No vehicle must be parked in this area before complete stop of the aircraft (wheel chocks in position on landing gears).

A340-500/-600

AIRCRAFT CHARACTERISTICS - AIRPORT AND MAINTENANCE PLANNING

**ON A/C A340-600

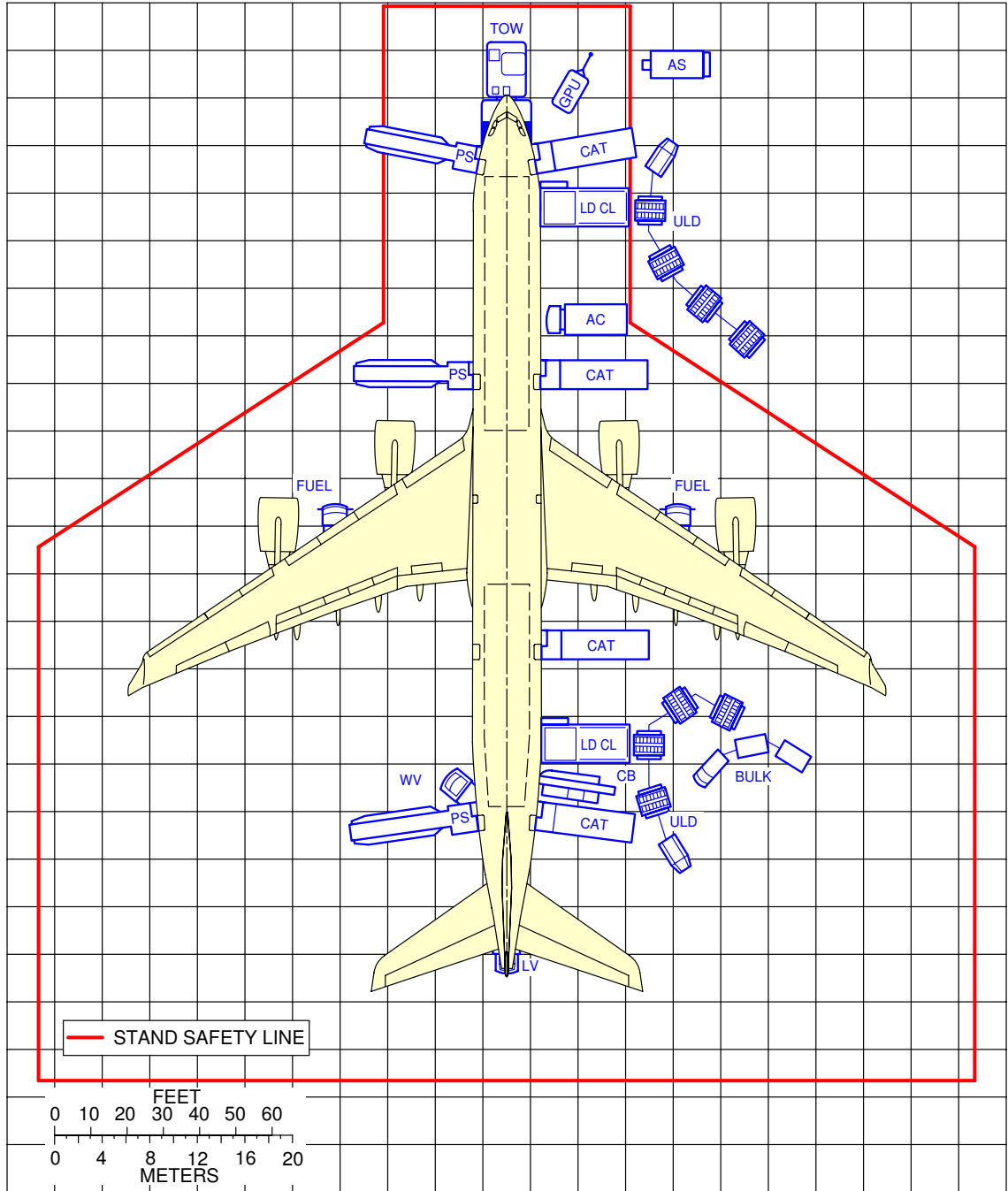

F_AC_050102_1_0080101_01_01

Typical Ramp Layout
Open Apron
FIGURE-5-1-2-991-008-A01

A340-500/-600

AIRCRAFT CHARACTERISTICS - AIRPORT AND MAINTENANCE PLANNING

**ON A/C A340-500

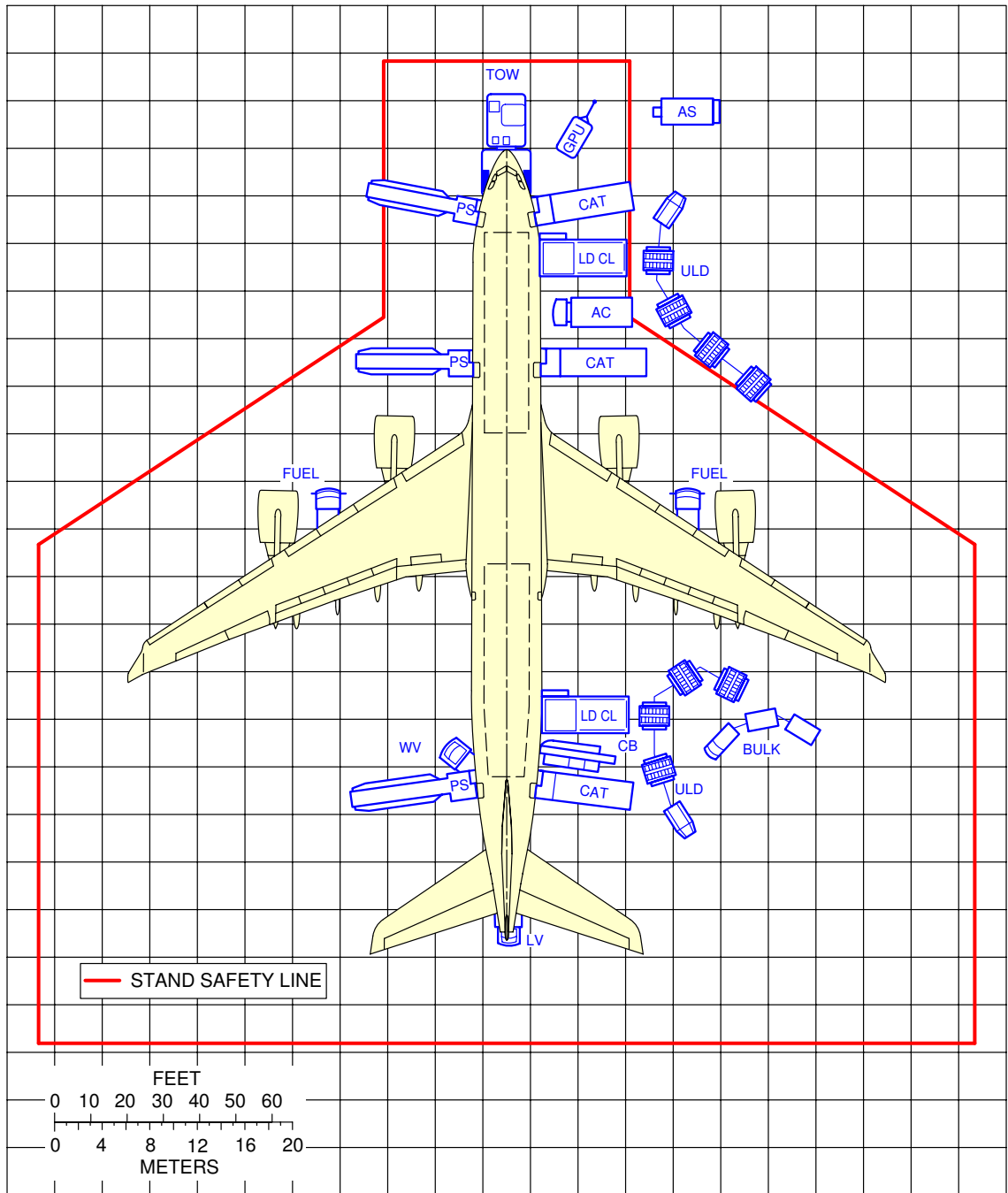

F_AC_050102_1_0090101_01_01

Typical Ramp Layout
Open Apron
FIGURE-5-1-2-991-009-A01

5-1-3 Typical Ramp Layout - Gate

****ON A/C A340-500 A340-600**

Typical Ramp Layout - Gate

1. This section provides the typical servicing arrangements in the gate area for the passenger version of the aircraft, with two Passenger Boarding Bridges.
The Stand Safety Line delimits the Aircraft Safety Area (minimum distance of 7.5 m (24.61 ft) from the aircraft). No vehicle must be parked in this area before complete stop of the aircraft (wheel chocks in position on landing gears).

A340-500/-600

AIRCRAFT CHARACTERISTICS - AIRPORT AND MAINTENANCE PLANNING

**ON A/C A340-600

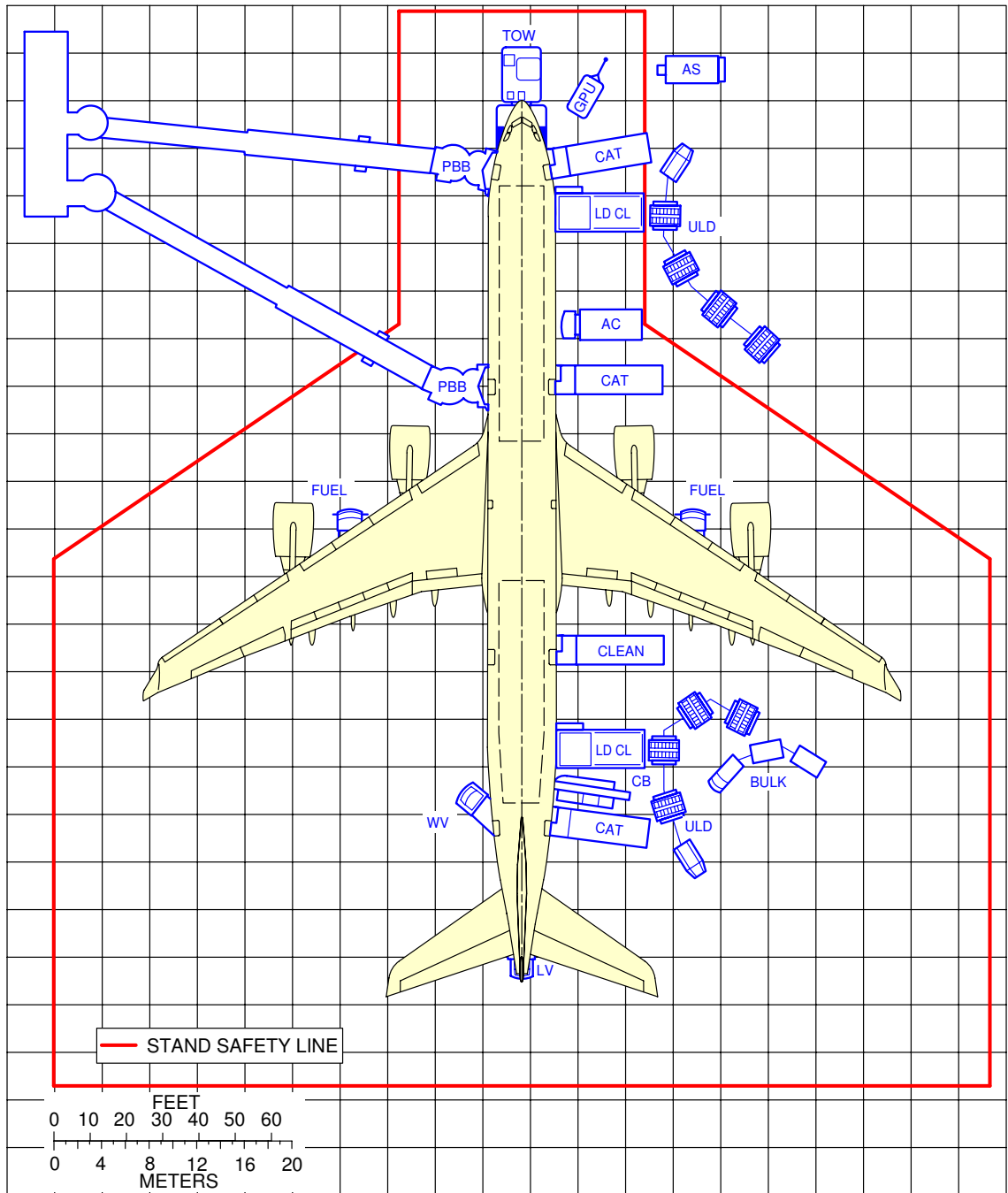

F_AC_050103_1_0040101_01_03

Typical Ramp Layout
Gate
FIGURE-5-1-3-991-004-A01

A340-500/-600

AIRCRAFT CHARACTERISTICS - AIRPORT AND MAINTENANCE PLANNING

**ON A/C A340-500

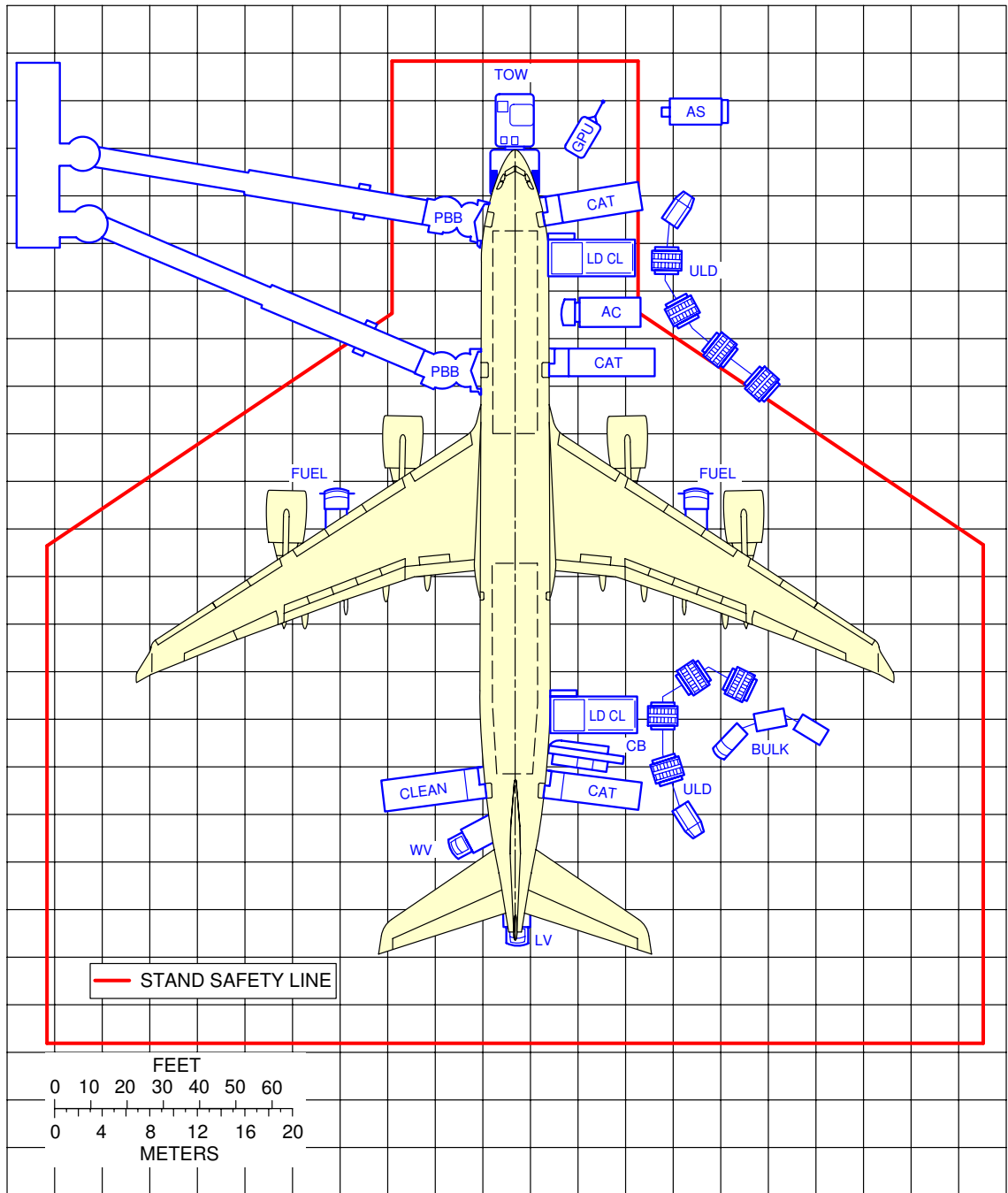

F_AC_050103_1_0050101_01_03

Typical Ramp Layout
Gate
FIGURE-5-1-3-991-005-A01

5-2-0 Terminal Operations - Full Servicing

****ON A/C A340-600**

Terminal Operations - Full Servicing Turn Round Time

1. This section provides a typical turn round time charts showing the typical time for ramp activities during aircraft turn round.
Actual times may vary due to each operator's specific practices, resources, equipment and operating conditions.

2. Assumptions used for full servicing turn round time chart

A. PASSENGER HANDLING

319 pax: 12 F/C + 42 B/C + 265 Y/C.

All passengers deplane and board the aircraft.

2 Passenger Boarding Bridges (PBB) used at doors L1 and L2.

Equipment positioning + opening door = +3 min.

Closing door + equipment removal = +3 min.

No Passenger with Reduced Mobility (PRM) on board.

Deplaning:

- 160 pax at door L1 (12 F/C + 42 B/C + 106 Y/C)
- 159 pax at door L2 (159 Y/C)
- Deplaning rate = 25 pax/min per door
- Priority deplaning for premium passengers.

Boarding:

- 160 pax at door L1 (12 F/C + 42 B/C + 106 Y/C)
- 159 pax at door L2 (159 Y/C)
- Boarding rate = 15 pax/min per door
- Last Pax Seating allowance (LPS) + headcounting = +4 min.

B. CARGO

2 cargo loaders + 1 belt loader.

Opening door + equipment positioning = +2.5 min.

Equipment removal + closing door = +2.5 min.

Cargo exchange:

- FWD cargo compartment: 20 LD3
- AFT cargo compartment: 6 pallets
- Bulk cargo compartment: 1 000 kg (2 205 lb).

LD3 unloading/loading times:

- Unloading = 1.2 min/LD3
- Loading = 1.4 min/LD3.

Pallet unloading/loading times:

- Unloading = 2.4 min/pallet
- Loading = 2.8 min/pallet.

Bulk unloading/loading times:

- Unloading = 9.2 min/t
- Loading = 10.5 min/t.

C. REFUELING

Block-fuel quantity for nominal range through 4 nozzles.

178 000 l (47 023 US gal) at 50 psi (3.45 bar).

Dispenser positioning + connection = +3 min.

Disconnection + dispenser removal = +3 min.

D. CLEANING

Cleaning is performed in available time.

E. CATERING

3 catering trucks for servicing galleys at doors R1, R2 and R5.

Equipment positioning + opening door = +5 min.

Closing door + equipment removal = +3 min.

Full Size Trolley Equivalent (FSTE) to unload and load: 45 FSTE

- 9 FSTE at door R1
- 9 FSTE at door R2
- 27 FSTE at door R5.

Time for trolley exchange = 1.5 min per FSTE.

F. GROUND HANDLING/GENERAL SERVICING

Start of operations:

- Bridges: $t_0 = 0$
- Others: $t_0 + 1$ min.

Vehicle positioning/removal = +2 min (except for fuel and catering trucks).

Ground Power Unit (GPU): up to 2×90 kVA.

Air conditioning: two hoses.

Potable water servicing: 100% uplift, 700 l (185 US gal) at 60 l/min (15.85 US gal/min).

Waste water servicing: draining + rinsing.

A340-500/-600

AIRCRAFT CHARACTERISTICS - AIRPORT AND MAINTENANCE PLANNING

**ON A/C A340-600

TRT: 68 min

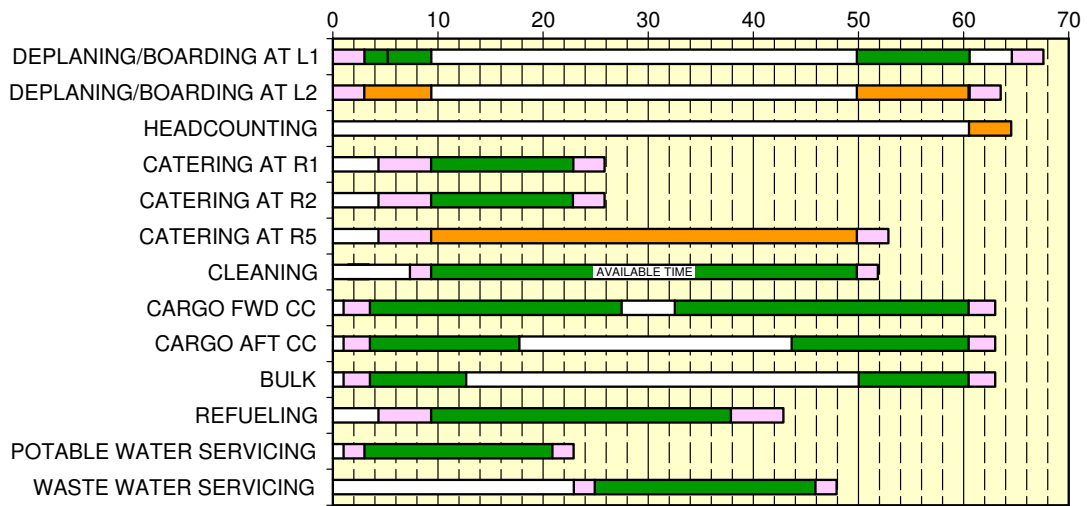

F_AC_050200_1_0060101_01_01

Full Servicing Turn Round Time Chart
FIGURE-5-2-0-991-006-A01

****ON A/C A340-500**

Terminal Operations - Full Servicing Turn Round Time

1. This section provides a typical turn round time charts showing the typical time for ramp activities during aircraft turn round.
Actual times may vary due to each operator's specific practices, resources, equipment and operating conditions.

2. Assumptions used for full servicing turn round time chart

A. PASSENGER HANDLING

246 pax: 8 F/C + 42 B/C + 196 Y/C.

All passengers deplane and board the aircraft.

2 Passenger Boarding Bridges (PBB) used at doors L1 and L2.

Equipment positioning + opening door = +3 min.

Closing door + equipment removal = +3 min.

No Passenger with Reduced Mobility (PRM) on board.

Deplaning:

- 123 pax at door L1 (8 F/C + 42 B/C + 73 Y/C)
- 123 pax at door L2 (123 Y/C)
- Deplaning rate = 25 pax/min per door
- Priority deplaning for premium passengers.

Boarding:

- 123 pax at door L1 (8 F/C + 42 B/C + 73 Y/C)
- 123 pax at door L2 (123 Y/C)
- Boarding rate = 15 pax/min per door
- Last Pax Seating allowance (LPS) + headcounting = +4 min.

B. CARGO

2 cargo loaders + 1 belt loader.

Opening door + equipment positioning = +2.5 min.

Equipment removal + closing door = +2.5 min.

Cargo exchange:

- FWD cargo compartment: 16 LD3
- AFT cargo compartment: 4 pallets
- Bulk cargo compartment: 1 000 kg (2 205 lb).

LD3 unloading/loading times:

- Unloading = 1.2 min/LD3
- Loading = 1.4 min/LD3.

Pallet unloading/loading times:

- Unloading = 2.4 min/pallet
- Loading = 2.8 min/pallet.

Bulk unloading/loading times:

- Unloading = 9.2 min/t
- Loading = 10.5 min/t.

C. REFUELING

Block-fuel quantity for nominal range through 4 nozzles.

191 000 l (50 457 US gal) at 50 psi (3.45 bar).

Dispenser positioning + connection = +3 min.

Disconnection + dispenser removal = +3 min.

D. CLEANING

Cleaning is performed in available time.

E. CATERING

3 catering trucks for servicing galleys at doors R1, R2 and R4.

Equipment positioning + opening door = +5 min.

Closing door + equipment removal = +3 min.

Full Size Trolley Equivalent (FSTE) to unload and load: 39 FSTE

- 8 FSTE at door R1
- 9 FSTE at door R2
- 22 FSTE at door R4.

Time for trolley exchange = 1.5 min per FSTE.

F. GROUND HANDLING/GENERAL SERVICING

Start of operations:

- Bridges: $t_0 = 0$
- Others: $t_0 + 1$ min.

Vehicle positioning/removal = +2 min (except for fuel and catering trucks).

Ground Power Unit (GPU): up to 2×90 kVA.

Air conditioning: two hoses.

Potable water servicing: 100% uplift, 700 l (185 US gal) at 60 l/min (15.85 US gal/min).

Waste water servicing: draining + rinsing.

A340-500/-600

AIRCRAFT CHARACTERISTICS - AIRPORT AND MAINTENANCE PLANNING

**ON A/C A340-500

TRT: 56 min

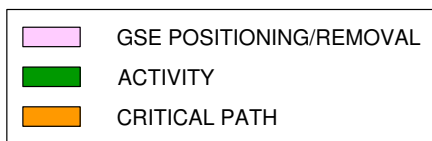
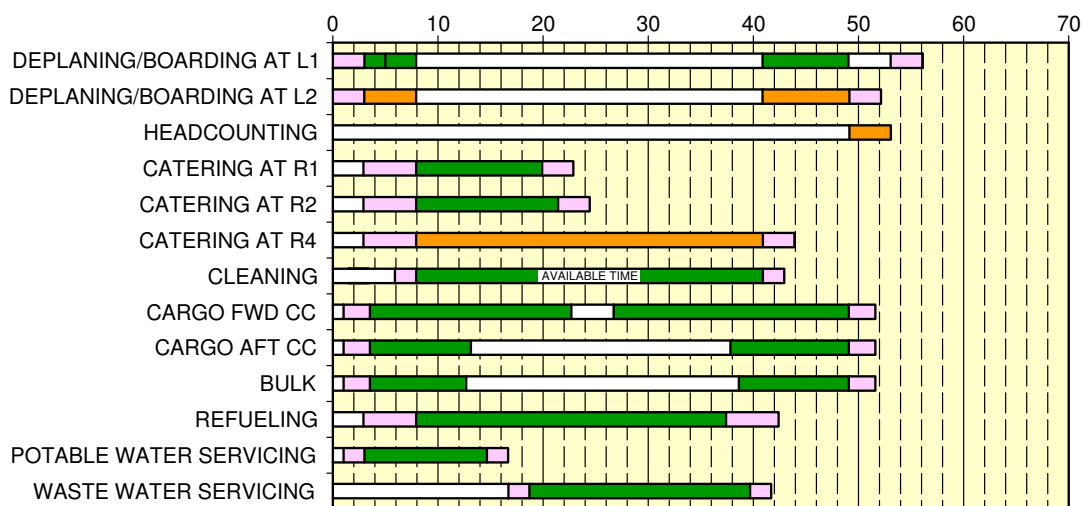

F_AC_050200_1_0070101_01_01

Full Servicing Turn Round Time Chart
FIGURE-5-2-0-991-007-A01

5-3-0 Terminal Operations - Transit

****ON A/C A340-600**

Terminal Operations - Minimum Servicing Turn-Round Time

1. This section provides typical turn-round time chart showing the typical times for ramp activities during aircraft turn-round.

Actual times may vary due to each operator's specific practice and operating conditions.

2. Assumptions for minimum servicing turn-round time chart

A. PASSENGER HANDLING

319 pax (12 F/C + 42 B/C + 265 Y/C)

50% of passengers deboard and board the aircraft

1 Passenger Boarding Bridge (PBB) used at door L1

Equipment positioning/removal + opening/closing door = 3 min

No Passenger with Reduced Mobility (PRM) on board

Deboarding:

- 160 pax at door L1

- Deboarding rate = 25 pax/min per door

Boarding:

- 160 pax at door L1

- Boarding rate = 15 pax/min per door

- Last Pax Seating allowance (LPS) + headcounting = +4 min

B. CARGO

1 cargo loader + 1 belt loader

Equipment positioning/removal + opening/closing door = 2.5 min

Cargo exchange:

- 6 LD3 in AFT cargo compartment

- 500 kg (1 102 lb) in bulk cargo compartment

LD3 off-loading/loading times:

- Off-loading = 1.2 min/LD3

- Loading = 1.4 min/LD3

Bulk off-loading/loading times:

- Off-loading = 9.2 min/t

- Loading = 10.5 min/t

C. REFUELLING

Refuelling through 2 nozzles

30% of max capacity at 50 psi (3.45 bar)

A340-500/-600

AIRCRAFT CHARACTERISTICS - AIRPORT AND MAINTENANCE PLANNING

Dispenser positioning/removal = 3 min

D. CLEANING

Performed in available time

E. CATERING

1 catering truck for servicing galleys as required

Equipment positioning + door opening = 5 min

Equipment removal + door closing = 3 min

Performed in available time

Time for trolley exchange = 1.5 min per FSTE

F. GROUND HANDLING/SERVICING

Start of operations:

- Bridges: $t_0 = 0$

- Others: $t_0 + 1$ min

Vehicle positioning/removal = 2 min (except for fuel and catering trucks)

Ground Power Unit (GPU): up to 2×90 kVA

Air conditioning: two hoses

No potable water servicing

No toilet servicing

A340-500/-600

AIRCRAFT CHARACTERISTICS - AIRPORT AND MAINTENANCE PLANNING

**ON A/C A340-600

TRT: 34 min

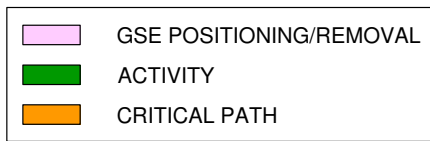
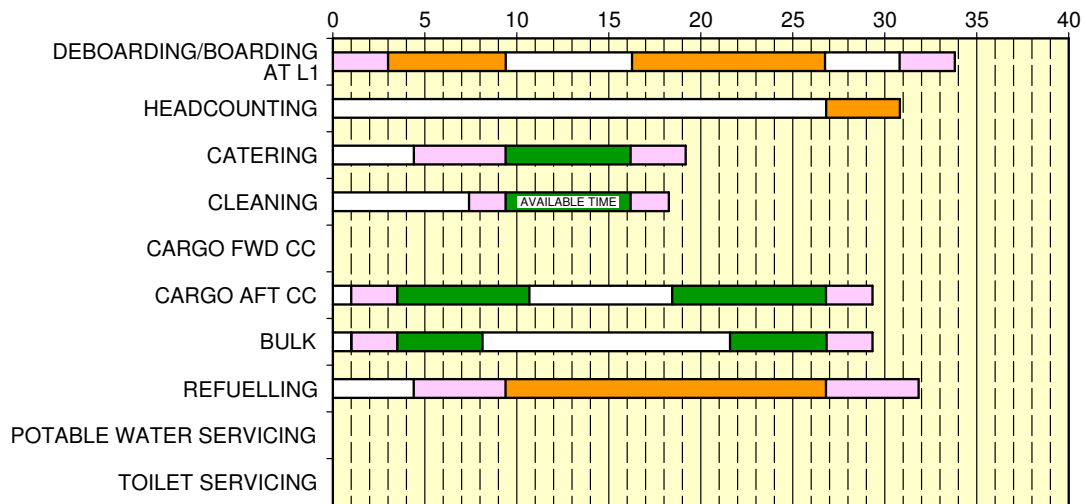

F_AC_050300_1_0070101_01_00

Minimum Servicing Turn-Round Time
FIGURE-5-3-0-991-007-A01

****ON A/C A340-500**

Terminal Operations - Minimum Servicing Turn-Round Time

1. This section provides typical turn-round time chart showing the typical times for ramp activities during aircraft turn-round.

Actual times may vary due to each operator's specific practice and operating conditions.

2. Assumptions for minimum servicing turn-round time chart

A. PASSENGER HANDLING

246 pax (8 F/C + 42 B/C + 196 Y/C)

50% of passengers deboard and board the aircraft

1 Passenger Boarding Bridge (PBB) used at door L1

Equipment positioning/removal + opening/closing door = 3 min

No Passenger with Reduced Mobility (PRM) on board

Deboarding:

- 123 pax at door L1

- Deboarding rate = 25 pax/min per door

Boarding:

- 123 pax at door L1

- Boarding rate = 15 pax/min per door

- Last Pax Seating allowance (LPS) + headcounting = +4 min

B. CARGO

1 cargo loader + 1 belt loader

Equipment positioning/removal + opening/closing door = 2.5 min

Cargo exchange:

- 4 LD3 in AFT cargo compartment

- 500 kg (1 102 lb) in bulk cargo compartment

LD3 off-loading/loading times:

- Off-loading = 1.2 min/LD3

- Loading = 1.4 min/LD3

Bulk off-loading/loading times:

- Off-loading = 9.2 min/t

- Loading = 10.5 min/t

C. REFUELLING

Refuelling through 2 nozzles

30% of max capacity at 50 psi (3.45 bar)

Dispenser positioning/removal = 3 min

D. CLEANING

Performed in available time

E. CATERING

1 catering truck for servicing galleys as required

Equipment positioning + door opening = 5 min

Equipment removal + door closing = 3 min

Performed in available time

Time for trolley exchange = 1.5 min per FSTE

F. GROUND HANDLING/SERVICING

Start of operations:

- Bridges: $t_0 = 0$

- Others: $t_0 + 1$ min

Vehicle positioning/removal = 2 min (except for fuel and catering trucks)

Ground Power Unit (GPU): up to 2×90 kVA

Air conditioning: two hoses

No potable water servicing

No toilet servicing

A340-500/-600

AIRCRAFT CHARACTERISTICS - AIRPORT AND MAINTENANCE PLANNING

**ON A/C A340-500

TRT: 32 min

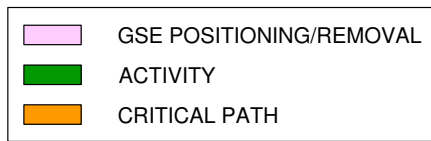
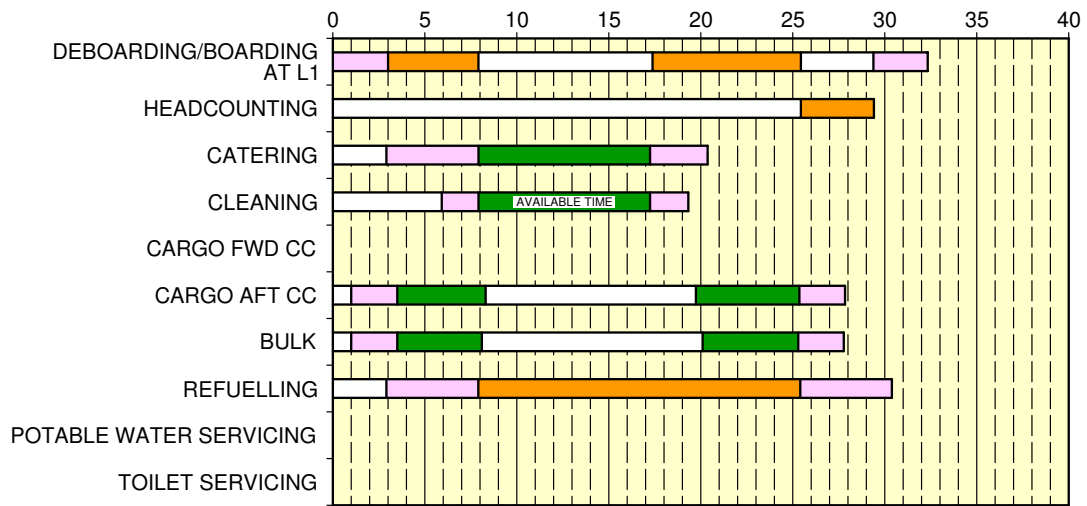

F_AC_050300_1_0080101_01_00

Minimum Servicing Turn-Round Time
FIGURE-5-3-0-991-008-A01

5-4-1 Ground Service Connections Layout****ON A/C A340-500 A340-600**Ground Service Connections Layout

1. This section provides the ground service connections layout.

A340-500/-600

AIRCRAFT CHARACTERISTICS - AIRPORT AND MAINTENANCE PLANNING

****ON A/C A340-600**

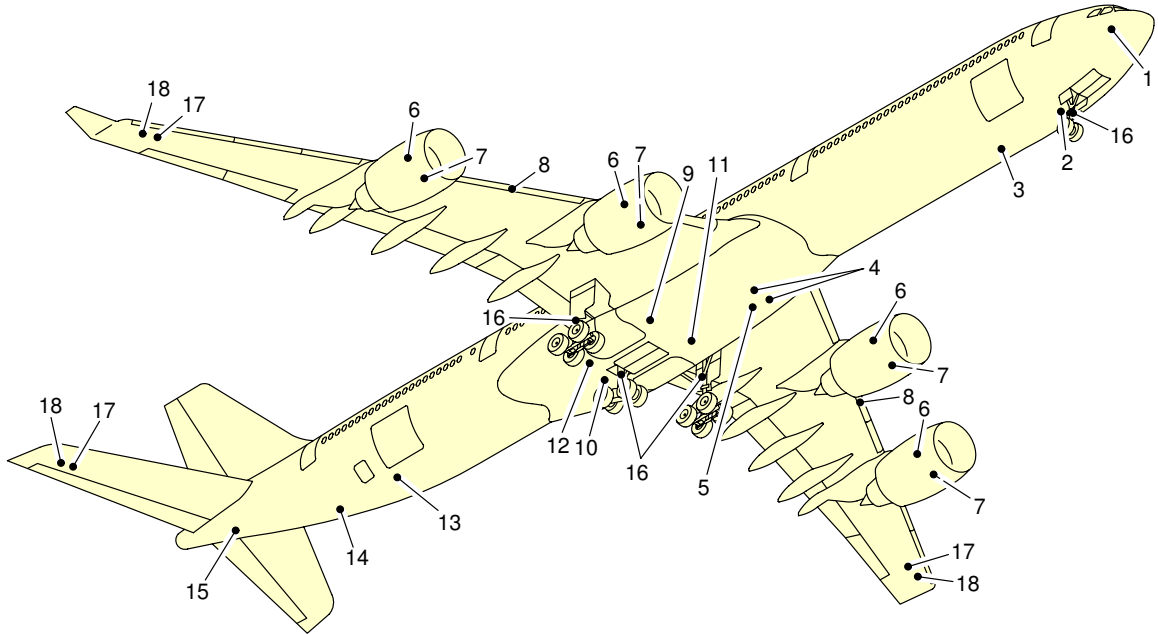

- | | |
|--|--|
| 1 - OXYGEN SERVICING | 10 - HYDRAULIC RESERVOIR FILLING AND GROUND POWER SUPPLY (GREEN) |
| 2 - GROUND ELECTRICAL POWER CONNECTORS | 11 - HYDRAULIC RESERVOIR AIR PRESSURIZATION AND GROUND POWER SUPPLY (BLUE) |
| 3 - POTABLE WATER DRAIN | 12 - REFUEL/DEFUEL PANEL |
| 4 - LOW PRESSURE AIR PRE-CONDITIONING | 13 - POTABLE WATER SERVICE PANEL |
| 5 - HIGH PRESSURE AIR PRE-CONDITIONING AND ENGINE STARTING | 14 - WASTE WATER SERVICE PANEL |
| 6 - ENGINE OIL FILLING | 15 - APU OIL FILLING |
| 7 - IDG OIL FILLING | 16 - GROUNDING (EARTHING) POINT |
| 8 - PRESSURE REFUEL/DEFUEL COUPLINGS | 17 - NACA FLAME ARRESTOR |
| 9 - HYDRAULIC GROUND POWER SUPPLY (YELLOW) | 18 - OVERPRESSURE PROTECTOR |

F_AC_050401_1_0040101_01_04

Ground Service Connections Layout
FIGURE-5-4-1-991-004-A01

A340-500/-600

AIRCRAFT CHARACTERISTICS - AIRPORT AND MAINTENANCE PLANNING

****ON A/C A340-500**

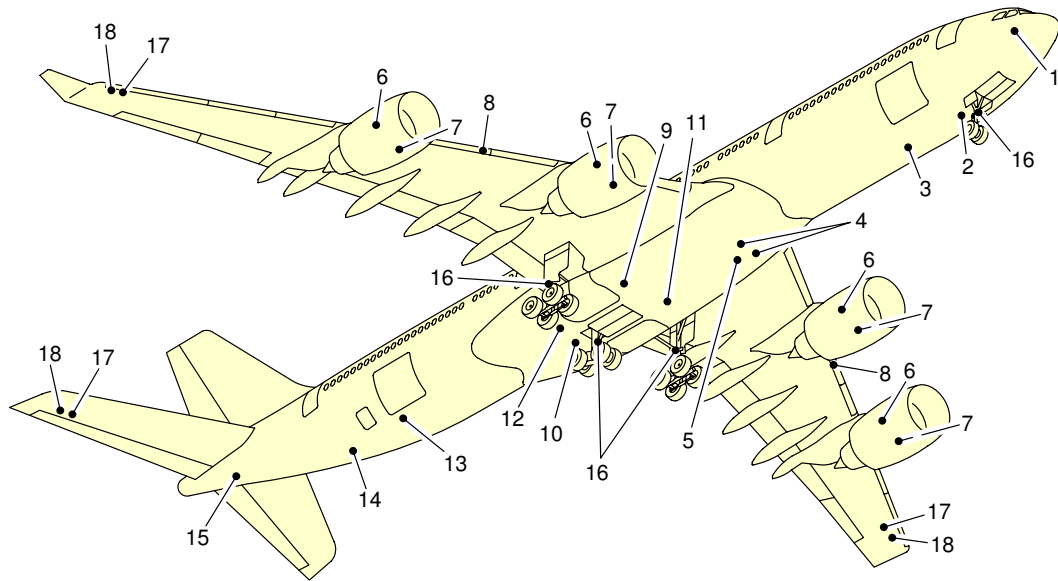

- | | |
|--|--|
| 1 - OXYGEN SERVICING | 10 - HYDRAULIC RESERVOIR FILLING AND GROUND POWER SUPPLY (GREEN) |
| 2 - GROUND ELECTRICAL POWER CONNECTORS | 11 - HYDRAULIC RESERVOIR AIR PRESSURIZATION AND GROUND POWER SUPPLY (BLUE) |
| 3 - POTABLE WATER DRAIN | 12 - REFUEL/DEFUEL PANEL |
| 4 - LOW PRESSURE AIR PRE-CONDITIONING | 13 - POTABLE WATER SERVICE PANEL |
| 5 - HIGH PRESSURE AIR PRE-CONDITIONING AND ENGINE STARTING | 14 - WASTE WATER SERVICE PANEL |
| 6 - ENGINE OIL FILLING | 15 - APU OIL FILLING |
| 7 - IDG OIL FILLING | 16 - GROUNDING (EARTHING) POINT |
| 8 - PRESSURE REFUEL/DEFUEL COUPLINGS | 17 - NACA FLAME ARRESTOR |
| 9 - HYDRAULIC GROUND POWER SUPPLY (YELLOW) | 18 - OVERPRESSURE PROTECTOR |

F_AC_050401_1_0050101_01_04

Ground Service Connections Layout
FIGURE-5-4-1-991-005-A01

5-4-2 Grounding Points

****ON A/C A340-500 A340-600**

Grounding (Earthing) Points

****ON A/C A340-600**

1. Grounding (Earthing) Points

ACCESS	DISTANCE			MEAN HEIGHT FROM GROUND
	AFT OF NOSE	FROM AIRCRAFT CENTERLINE		
		LH SIDE	RH SIDE	
On Nose Landing Gear leg:	6.57 m (21.56 ft)	On centerline		1.40 m (4.59 ft)
On left Main Landing Gear leg:	39.45 m (129.43 ft)	5.34 m (17.52 ft)		1.50 m (4.92 ft)
On right Main Landing Gear leg:	39.45 m (129.43 ft)		5.34 m (17.52 ft)	1.50 m (4.92 ft)

- A. The grounding (earthing) stud on each landing gear leg is designed for use with a clip-on connector (such as Appleton TGR).
- B. The grounding (earthing) studs are used to connect the aircraft to an approved ground (earth) connection on the ramp or in the hangar for:
 - Refuel/defuel operations
 - Maintenance operations
 - Bad weather conditions.

NOTE : In all other conditions, the electrostatic discharge through the tire is sufficient.

****ON A/C A340-500**

2. Grounding (Earthing) Points

ACCESS	DISTANCE			MEAN HEIGHT FROM GROUND
	AFT OF NOSE	FROM AIRCRAFT CENTERLINE		
		LH SIDE	RH SIDE	
On Nose Landing Gear leg:	6.57 m (21.56 ft)	On centerline		1.40 m (4.59 ft)
On left Main Landing Gear leg:	34.15 m (112.04 ft)	5.34 m (17.52 ft)		1.50 m (4.92 ft)

A340-500/-600

AIRCRAFT CHARACTERISTICS - AIRPORT AND MAINTENANCE PLANNING

ACCESS	DISTANCE			
	AFT OF NOSE	FROM AIRCRAFT CENTERLINE		MEAN HEIGHT FROM GROUND
		LH SIDE	RH SIDE	
On right Main Landing Gear leg:	34.15 m (112.04 ft)		5.34 m (17.52 ft)	1.50 m (4.92 ft)

- A. The grounding (earthing) stud on each landing gear leg is designed for use with a clip-on connector (such as Appleton TGR).
- B. The grounding (earthing) studs are used to connect the aircraft to an approved ground (earth) connection on the ramp or in the hangar for:
- Refuel/defuel operations
 - Maintenance operations
 - Bad weather conditions.

NOTE : In all other conditions, the electrostatic discharge through the tire is sufficient.

A340-500/-600

AIRCRAFT CHARACTERISTICS - AIRPORT AND MAINTENANCE PLANNING

**ON A/C A340-500 A340-600

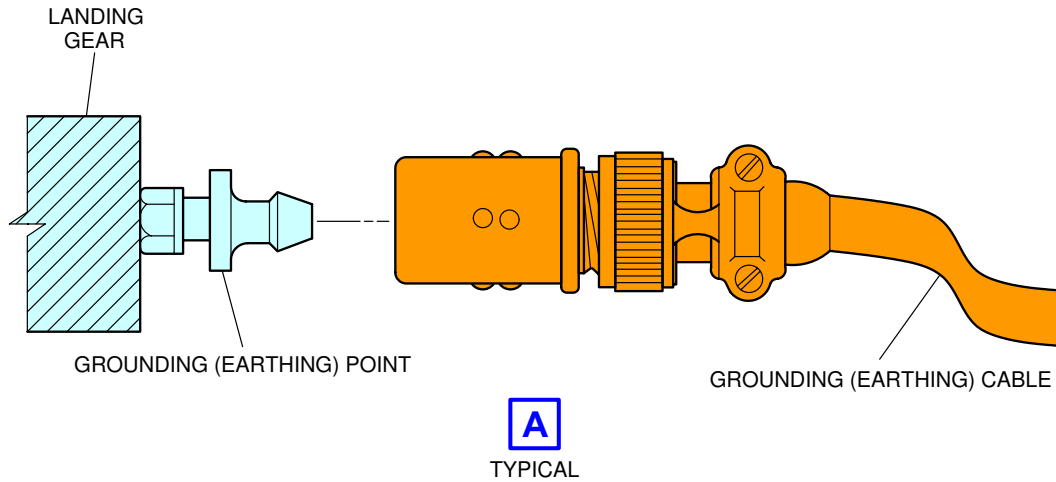
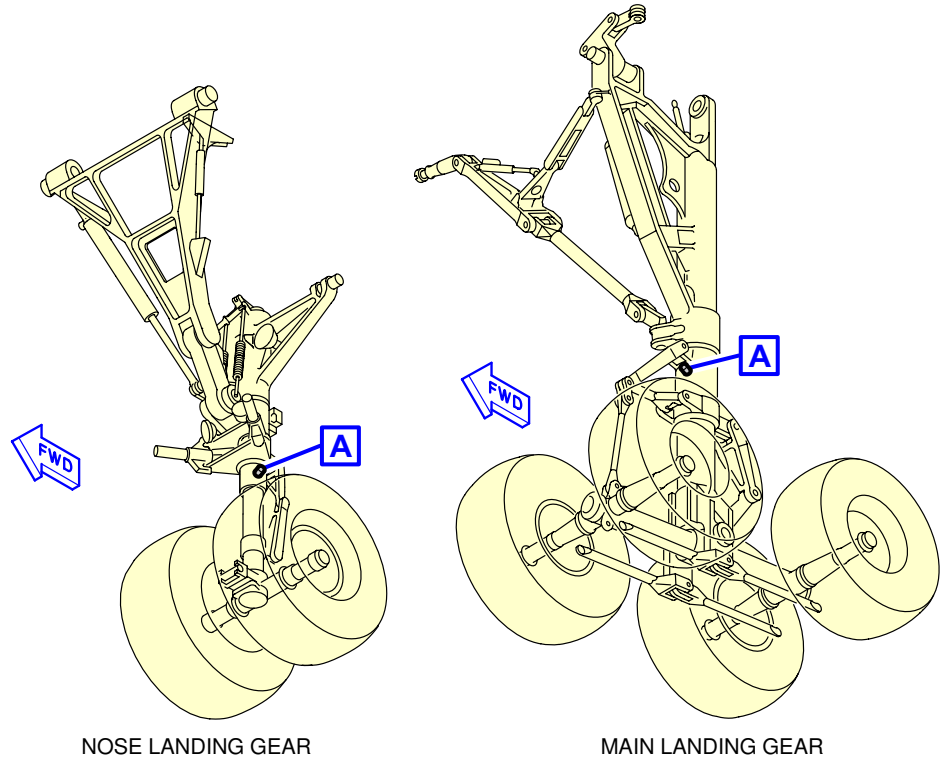

F_AC_050402_1_0050101_01_02

Ground Service Connections
Grounding (Earthing) Points
FIGURE-5-4-2-991-005-A01

5-4-3 Hydraulic System

****ON A/C A340-500 A340-600**

Hydraulic Servicing

****ON A/C A340-600**

1. Ground Service Panels

ACCESS	DISTANCE			
	AFT OF NOSE	FROM AIRCRAFT CENTERLINE		MEAN HEIGHT FROM GROUND
		LH SIDE	RH SIDE	
Green System: Access Door 197FB	35.62 m (116.86 ft)	1.50 m (4.92 ft)		2.10 m (6.89 ft)
Yellow System: Access Door 196PB	30.32 m (99.48 ft)		1.70 m (5.58 ft)	1.80 m (5.91 ft)
Blue System: Access Door 195MB	27.82 m (91.27 ft)	1.50 m (4.92 ft)		1.75 m (5.74 ft)

A. Reservoir pressurization

On the Blue ground service panel:

- One self-sealing connector - Green reservoir pressurization.
- One self-sealing connector - Blue and Yellow reservoir pressurization.

B. Reservoir filling

On the Green ground service panel:

- One self-sealing connector - reservoir filling.
- One self-sealing connector - reservoir filling (hand pump).

C. Ground test

On each ground service panel:

- One self-sealing connector - suction.
- One self-sealing connector - delivery.

D. Accumulator charging

On each ground service panel:

- One nitrogen charging connector - power accumulator.

On the Blue ground service panel:

- Two nitrogen charging connectors - parking/ultimate emergency brake accumulators.

NOTE : The nitrogen charging connectors for the normal and alternate braking systems are installed on the accumulators located on the main and center landing gear legs.

****ON A/C A340-500**

2. Ground Service Panels

ACCESS	DISTANCE			
	AFT OF NOSE	FROM AIRCRAFT CENTERLINE		MEAN HEIGHT FROM GROUND
		LH SIDE	RH SIDE	
Green System: Access Door 197FB	30.32 m (99.48 ft)	1.50 m (4.92 ft)		2.10 m (6.89 ft)
Yellow System: Access Door 196PB	25.02 m (82.09 ft)		1.70 m (5.58 ft)	1.80 m (5.91 ft)
Blue System: Access Door 195MB	22.47 m (73.72 ft)	1.50 m (4.92 ft)		1.75 m (5.74 ft)

A. Reservoir pressurization

On the Blue ground service panel:

- One self-sealing connector - Green reservoir pressurization.
- One self-sealing connector - Blue and Yellow reservoir pressurization.

B. Reservoir filling

On the Green ground service panel:

- One self-sealing connector - reservoir filling.
- One self-sealing connector - reservoir filling (hand pump).

C. Ground test

On each ground service panel:

- One self-sealing connector - suction.
- One self-sealing connector - delivery.

D. Accumulator charging

On each ground service panel:

- One nitrogen charging connector - power accumulator.

On the Blue ground service panel:

- Two nitrogen charging connectors - parking/ultimate emergency brake accumulators.

A340-500/-600

AIRCRAFT CHARACTERISTICS - AIRPORT AND MAINTENANCE PLANNING

NOTE : The nitrogen charging connectors for the normal and alternate braking systems are installed on the accumulators located on the main and center landing gear legs.

****ON A/C A340-500 A340-600**

3. A/C Emergency Generation

ACCESS	DISTANCE			MEAN HEIGHT FROM GROUND
	AFT OF NOSE	FROM AIRCRAFT CENTERLINE		
		LH SIDE	RH SIDE	
RAT Safety-Pin Installation: Access Panel 633SL	42.00 m (137.80 ft)		14.20 m (46.59 ft)	4.15 m (13.62 ft)

A340-500/-600

AIRCRAFT CHARACTERISTICS - AIRPORT AND MAINTENANCE PLANNING

**ON A/C A340-500 A340-600

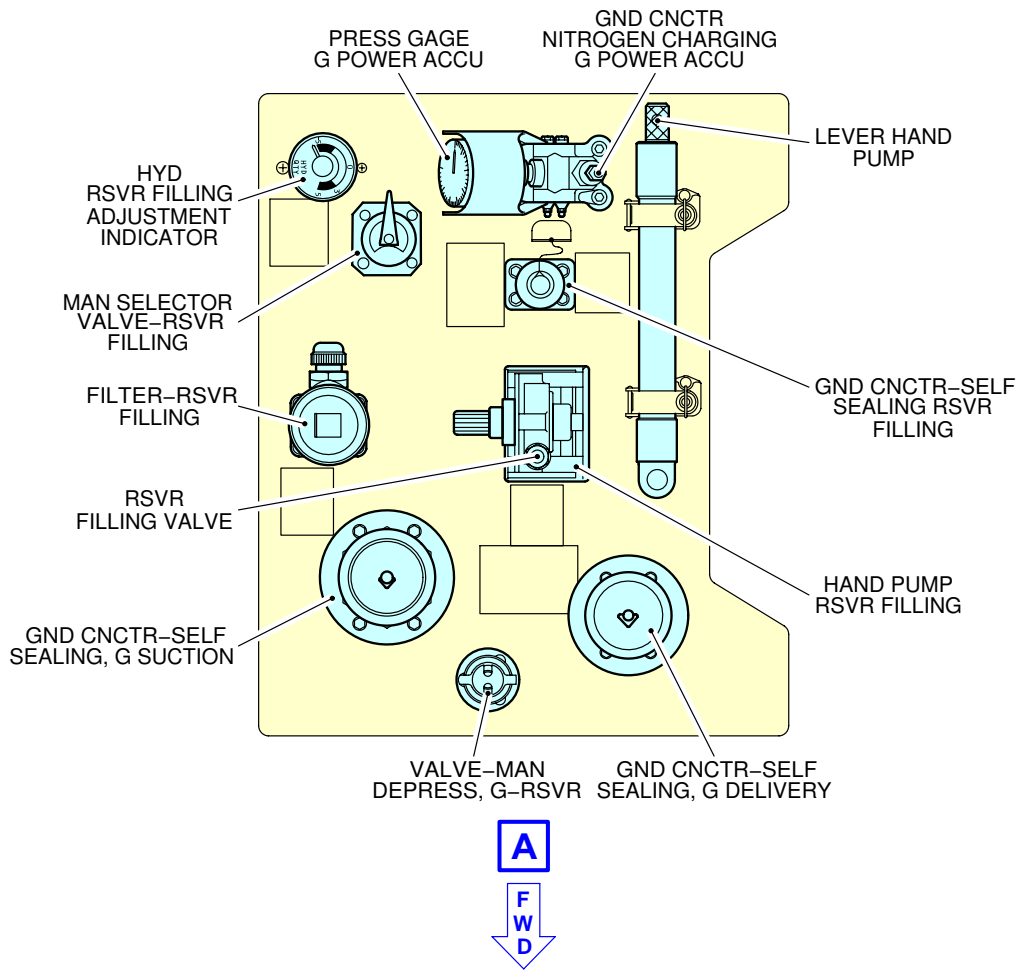
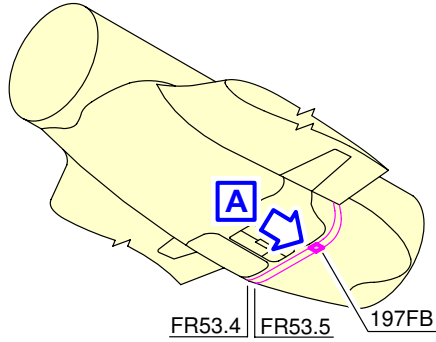

F_AC_050403_1_0070101_01_00

Ground Service Connections
Green System Ground Service Panel
FIGURE-5-4-3-991-007-A01

A340-500/-600

AIRCRAFT CHARACTERISTICS - AIRPORT AND MAINTENANCE PLANNING

**ON A/C A340-500 A340-600

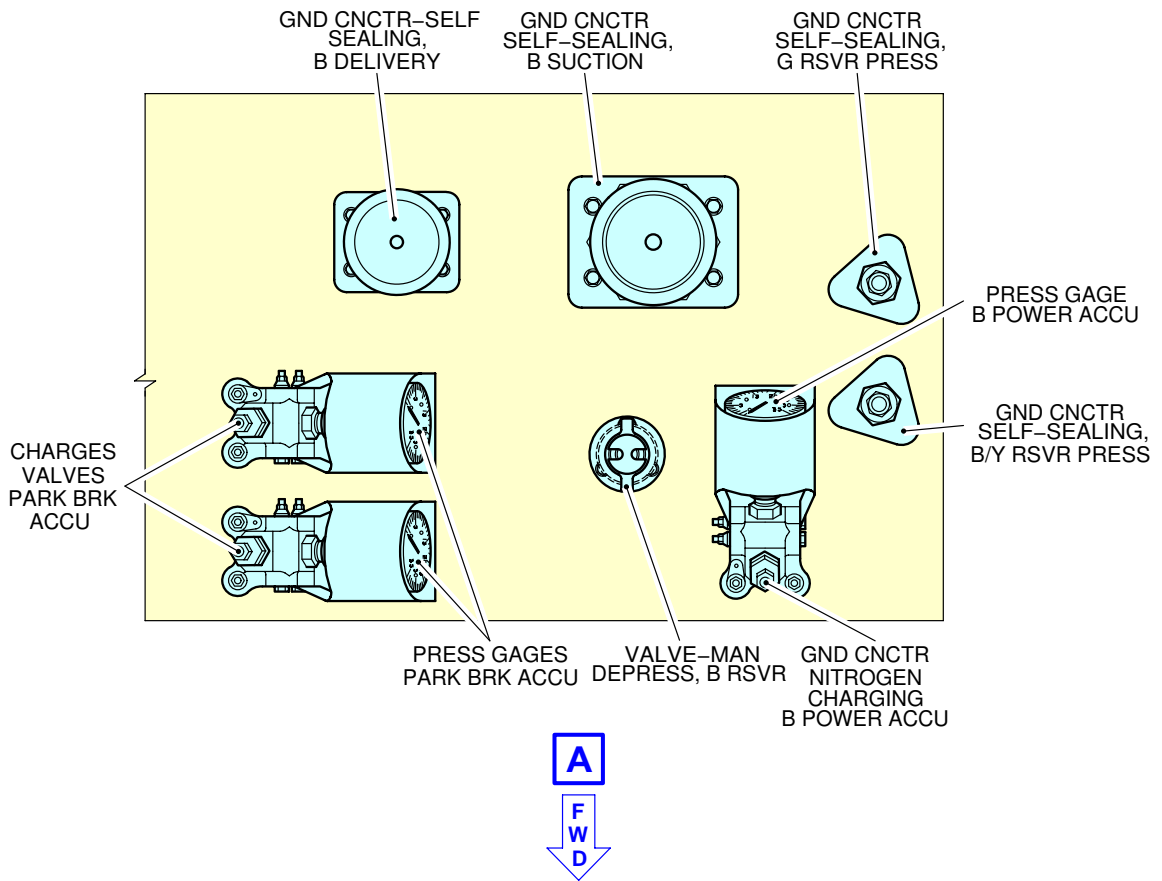
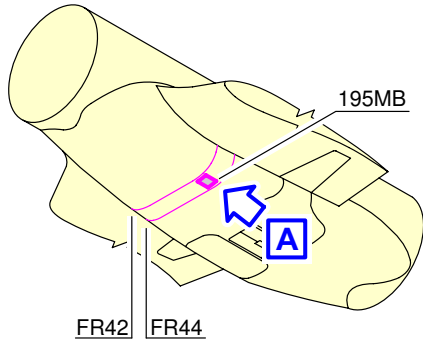

F_AC_050403_1_0080101_01_00

Ground Service Connections
 Blue System Ground Service Panel
 FIGURE-5-4-3-991-008-A01

A340-500/-600

AIRCRAFT CHARACTERISTICS - AIRPORT AND MAINTENANCE PLANNING

**ON A/C A340-500 A340-600

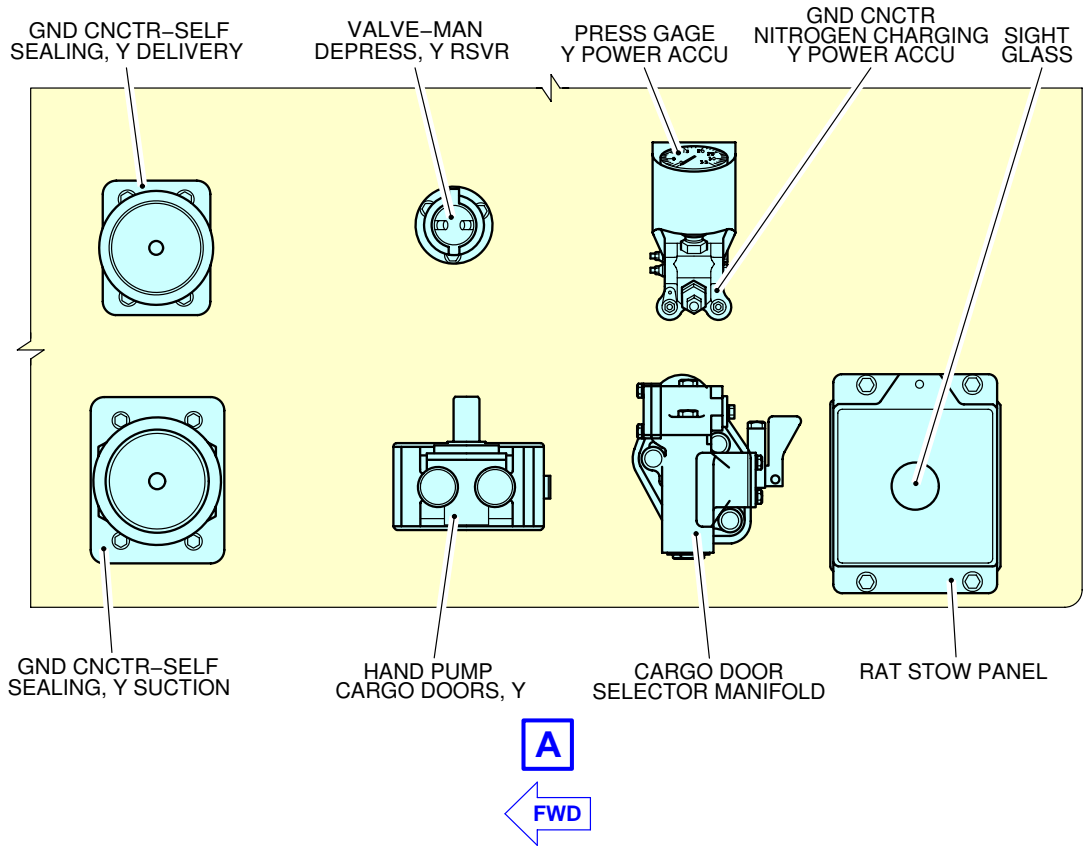
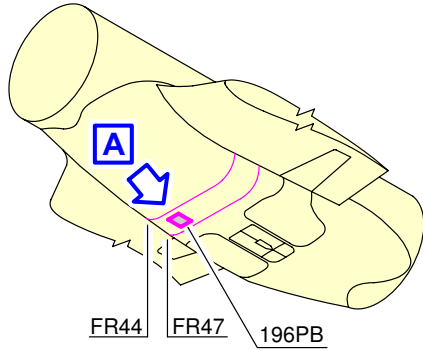

F_AC_050403_1_0090101_01_00

Ground Service Connections
 Yellow System Ground Service Panel
 FIGURE-5-4-3-991-009-A01

A340-500/-600

AIRCRAFT CHARACTERISTICS - AIRPORT AND MAINTENANCE PLANNING

**ON A/C A340-500 A340-600

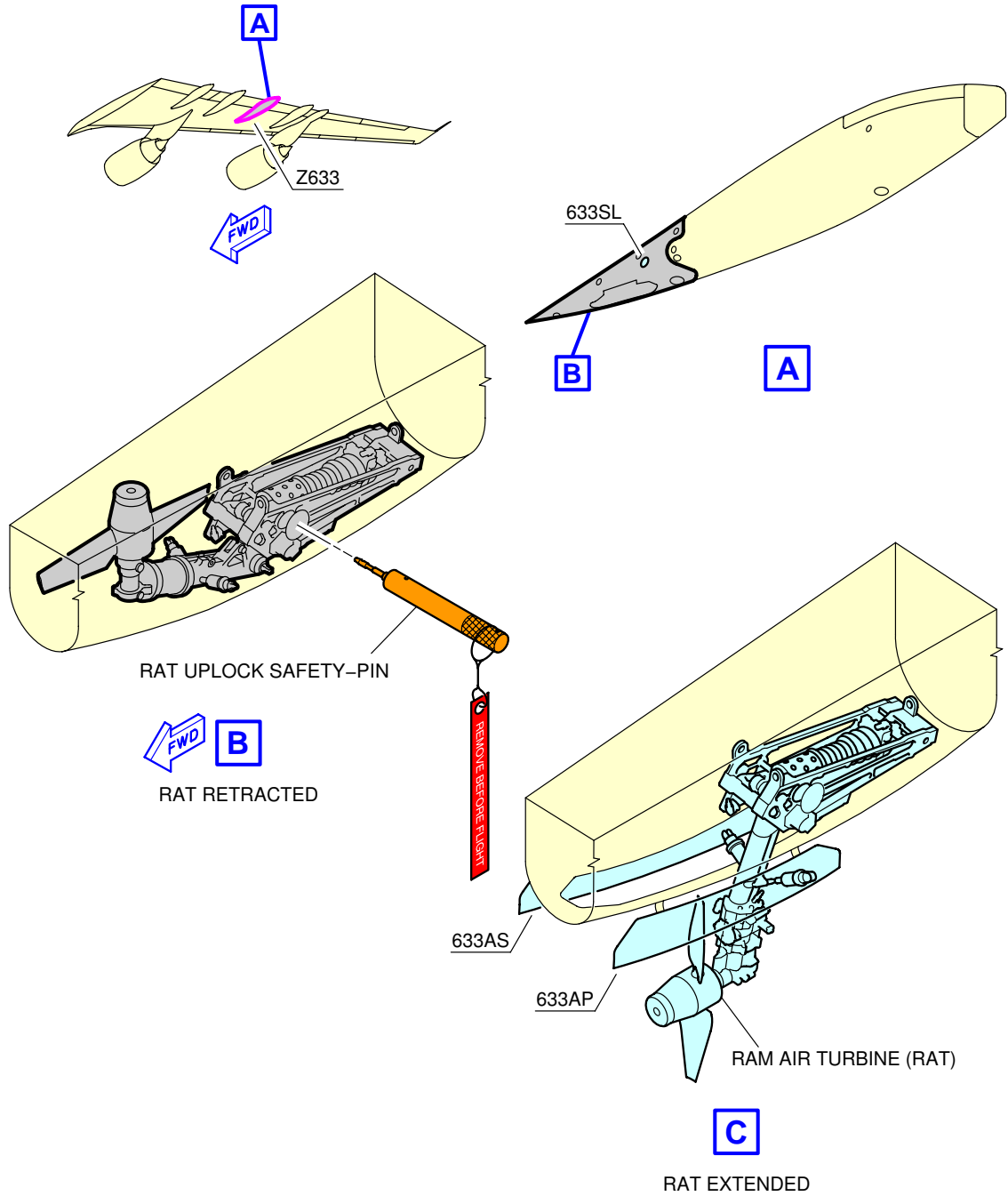

F_AC_050403_1_0120101_01_00

Ground Service Connections
RAT
FIGURE-5-4-3-991-012-A01

5-4-4 Electrical System

****ON A/C A340-500 A340-600**

Electrical Servicing

1. A/C External Power

ACCESS	DISTANCE			MEAN HEIGHT FROM GROUND
	AFT OF NOSE	FROM AIRCRAFT CENTERLINE		
		LH SIDE	RH SIDE	
A/C External Power: Access Door 121EL	7.00 m (22.97 ft)	On centerline		2.00 m (6.56 ft)

NOTE : Distances are approximate.

2. Technical Specifications

A. External Power Receptacles:

- Two receptacles according to MS 90362-3 - 90 kVA.

B. Power Supply:

- Three-phase, 115 V, 400 Hz.

C. Electrical Connectors for Servicing:

- AC outlets: HUBBELL 5258
- DC outlets: HUBBELL 7472.

3. Tow Truck Power

ACCESS	DISTANCE			MEAN HEIGHT FROM GROUND
	AFT OF NOSE	FROM AIRCRAFT CENTERLINE		
		LH SIDE	RH SIDE	
NLG Service Panel: 5GC	6.58 m (21.59 ft)		0.50 m (1.64 ft)	TBD

4. Technical Specifications

A. Power Supply:

- Two-phase, 115 V, 400 Hz
- 28V DC.

B. Electrical Connector for Servicing:

- Bernier, 22-11-10-13 Connector.

C. Pin Allocation:

Pin Identification	
A	28V DC
B	0V DC
D	115V AC
E	0V AC
G	PWR SPLY
H	INT LOCK

NOTE : The power cable should be extendable in order to guarantee fit and non-interference with nose gear nor tow vehicle during the pick-up and the towing process. The connector shall be secured against pull-out by means of straps against the nose gear.

A340-500/-600

AIRCRAFT CHARACTERISTICS - AIRPORT AND MAINTENANCE PLANNING

**ON A/C A340-500 A340-600

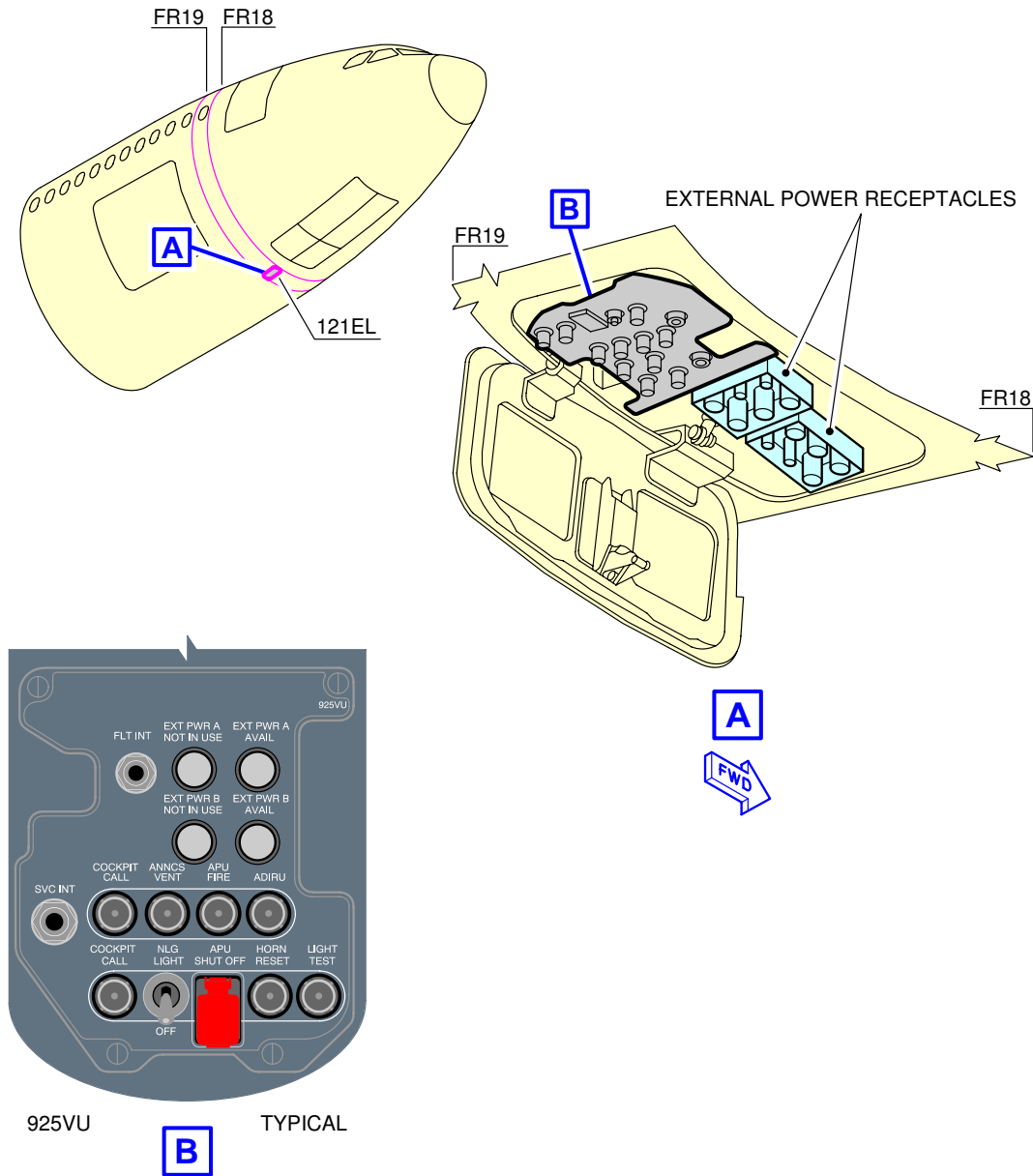

F_AC_050404_1_0040101_01_01

Ground Service Connections
Electrical Service Panel
FIGURE-5-4-4-991-004-A01

5-4-5 Oxygen System

****ON A/C A340-500 A340-600**

Oxygen Servicing

1. Oxygen Servicing

ACCESS	DISTANCE			MEAN HEIGHT FROM GROUND
	AFT OF NOSE	FROM AIRCRAFT CENTERLINE		
		LH SIDE	RH SIDE	
Oxygen Replenishment (Option 1): Access Door 811	2.50 m (8.20 ft)		0.53 m (1.74 ft)	3.20 m (10.50 ft)
Oxygen Replenishment (Option 2): Access Door 811	2.50 m (8.20 ft)		0.68 m (2.23 ft)	3.20 m (10.50 ft)

- 0 – Basic: Replenishment by replacement of oxygen cylinders in the avionic compartment
- 1 – Option: External charging in the avionic compartment
- 2 – Option: External charging in the avionic compartment.

One or two MIL-DTL 7891 standard service connections (external charging in the avionics compartment).

NOTE : Internal charging connection provided.

A340-500/-600

AIRCRAFT CHARACTERISTICS - AIRPORT AND MAINTENANCE PLANNING

**ON A/C A340-500 A340-600

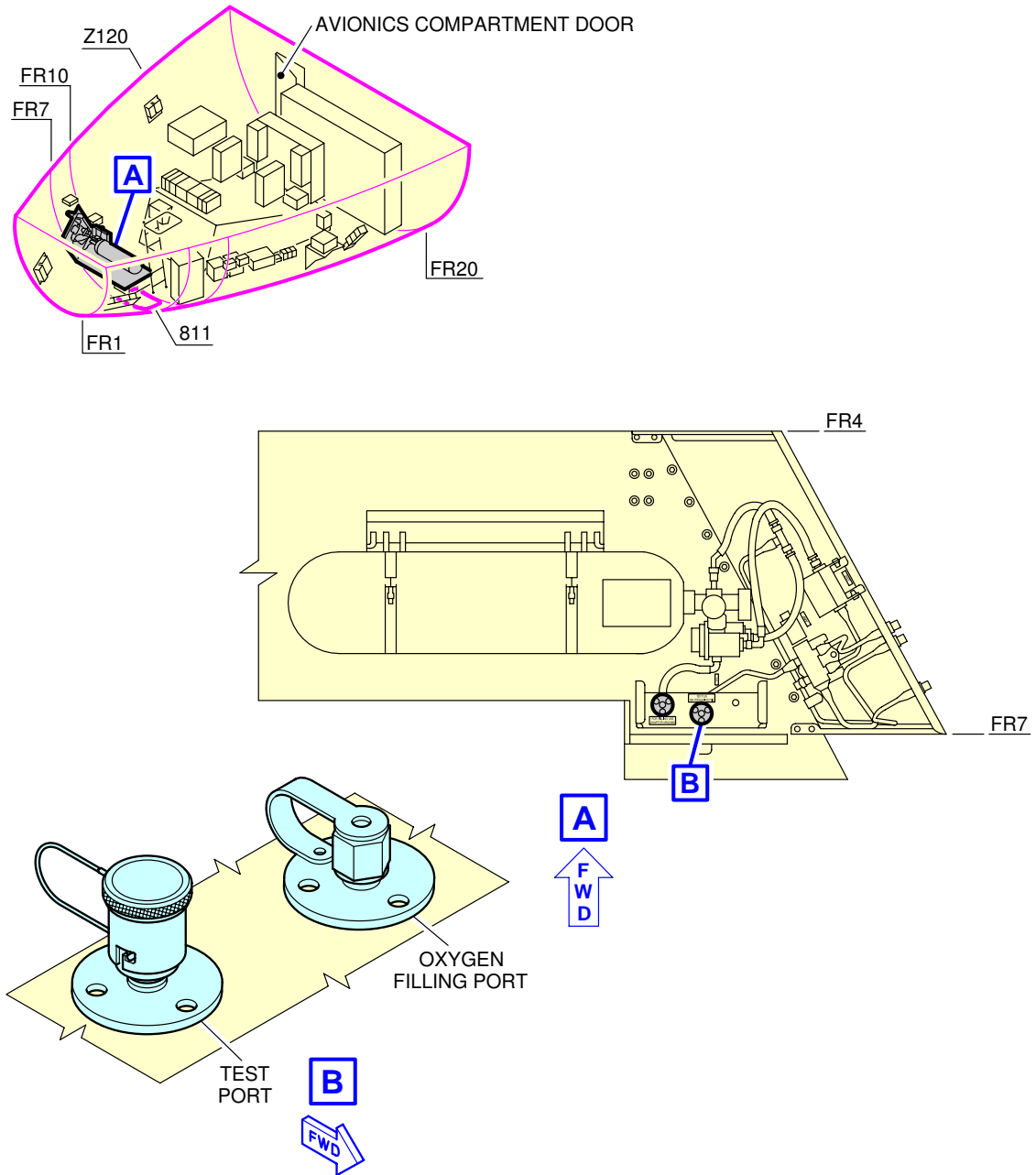

NOTE:

THE NUMBER OF OXYGEN CYLINDERS DEPENDS ON THE SYSTEM CONFIGURATION.

F_AC_050405_1_0040101_01_01

Ground Service Connections
Oxygen Servicing
FIGURE-5-4-5-991-004-A01

5-4-6 Fuel System

****ON A/C A340-500 A340-600**

Fuel System

****ON A/C A340-600**

1. Refuel/Defuel Control Panel

ACCESS	DISTANCE			
	AFT OF NOSE	FROM AIRCRAFT CENTERLINE		MEAN HEIGHT FROM GROUND
		LH SIDE	RH SIDE	
Refuel/Defuel Control Panel: Access Door 198FB	42.5 m (139.44 ft)	-	1.4 m (4.59 ft)	2 m (6.56 ft)

- A. Refuel/Defuel pressure/suction:
 - Maximum pressure: 50 psi (3.45 bar)
 - Maximum suction: 11 psi (0.76 bar).
- B. Flow rate:
 - 2 couplings (total/min): 1576 l (416 US gal)
 - 4 couplings (total/min): 1438 l (380 US gal).

2. Refuel/Defuel Connectors

ACCESS	DISTANCE			
	AFT OF NOSE	FROM AIRCRAFT CENTERLINE		MEAN HEIGHT FROM GROUND
		LH SIDE	RH SIDE	
Refuel/Defuel Coupling, Left: Access Door 522HB	37.1 m (121.72 ft)	-	12.6 m (41.34 ft)	5 m (16.4 ft)
Refuel/Defuel Coupling, Right: Access Door 622HB	37.1 m (121.72 ft)	12.6 m (41.34 ft)	-	5 m (16.4 ft)

- A. Refuel/Defuel couplings:
 - Four standard 2.5 in. ISO 45 connections.

3. Overpressure Protector and NACA Flame Arrestor

ACCESS	DISTANCE			
	AFT OF NOSE	FROM AIRCRAFT CENTERLINE		MEAN HEIGHT FROM GROUND
		LH SIDE	RH SIDE	
Overpressure Protector (Wing) Access Panel 550DB (650DB)	47.03 m (154.3 ft)	28.7 m (94.16 ft)	28.7 m (94.16 ft)	5.75 m (18.86 ft)
NACA Flame Arrestor (Wing) Access Panel 550DB (650DB)	47.03 m (154.3 ft)	28.1 m (92.19 ft)	28.1 m (92.19 ft)	5.7 m (18.7 ft)
Overpressure Protector (Trim Tank) Access Panel 346AB	72.93 m (239.27 ft)	7.10 m (23.29 ft)	7.10 m (23.29 ft)	5.7 m (18.7 ft)
NACA Flame Arrestor (Trim Tank) Access Panel 346AB	72.93 m (239.27 ft)	7.10 m (23.29 ft)	7.10 m (23.29 ft)	5.7 m (18.7 ft)

**ON A/C A340-500

4. Refuel/Defuel Control Panel

ACCESS	DISTANCE			
	AFT OF NOSE	FROM AIRCRAFT CENTERLINE		MEAN HEIGHT FROM GROUND
		LH SIDE	RH SIDE	
Refuel/Defuel Control Panel: Access Door 198FB	37.2 m (122.05 ft)	-	1.4 m (4.59 ft)	2 m (6.56 ft)

- A. Refuel/Defuel pressure/suction:
 - Maximum pressure: 50 psi (3.45 bar)
 - Maximum suction: 11 psi (0.76 bar).
- B. Flow rate:
 - 2 couplings (total/min): 1576 l (416 US gal)
 - 4 couplings (total/min): 1438 l (380 US gal).

5. Refuel/Defuel Connectors

ACCESS	DISTANCE			
	AFT OF NOSE	FROM AIRCRAFT CENTERLINE		MEAN HEIGHT FROM GROUND
		LH SIDE	RH SIDE	
Refuel/Defuel Coupling, Left: Access Door 522HB	31.4 m (103.02 ft)	12.6 m (41.34 ft)	-	5 m (16.4 ft)
Refuel/Defuel Coupling, Right: Access Door 622HB	31.4 m (103.02 ft)	-	12.6 m (41.34 ft)	5 m (16.4 ft)

A. Refuel/Defuel couplings:

- Four standard 2.5 in. ISO 45 connections.

6. Overpressure Protector and NACA Flame Arrestor

ACCESS	DISTANCE			
	AFT OF NOSE	FROM AIRCRAFT CENTERLINE		MEAN HEIGHT FROM GROUND
		LH SIDE	RH SIDE	
Overpressure Protector (Wing) Access Panel 550DB (650DB)	41.73 m (136.91 ft)	28.7 m (94.16 ft)	28.7 m (94.16 ft)	5.75 m (18.86 ft)
NACA Flame Arrestor (Wing) Access Panel 550DB (650DB)	41.73 m (136.91 ft)	28.1 m (92.19 ft)	28.1 m (92.19 ft)	5.7 m (18.7 ft)
Overpressure Protector (Trim Tank) Access Panel 346AB	65.5 m (214.9 ft)	7.10 m (23.29 ft)	7.10 m (23.29 ft)	5.7 m (18.7 ft)
NACA Flame Arrestor (Trim Tank) Access Panel 346AB	65.5 m (214.9 ft)	7.10 m (23.29 ft)	7.10 m (23.29 ft)	5.7 m (18.7 ft)

A340-500/-600

AIRCRAFT CHARACTERISTICS - AIRPORT AND MAINTENANCE PLANNING

**ON A/C A340-500 A340-600

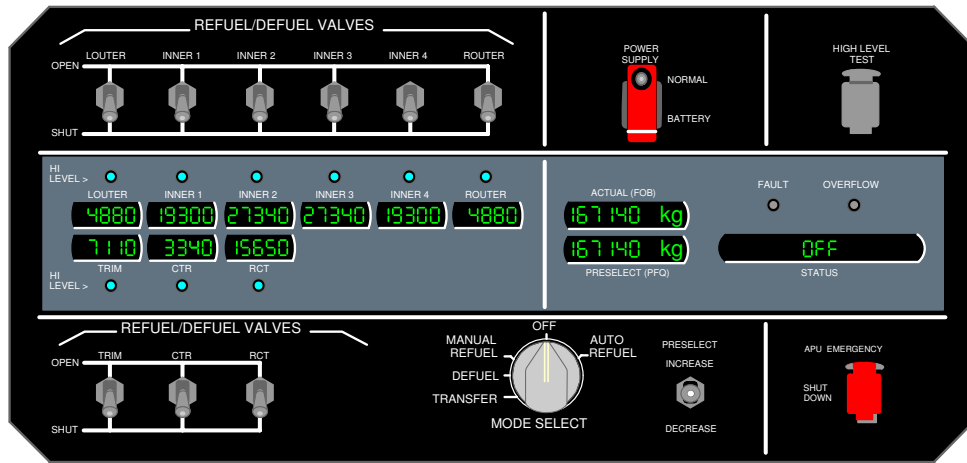
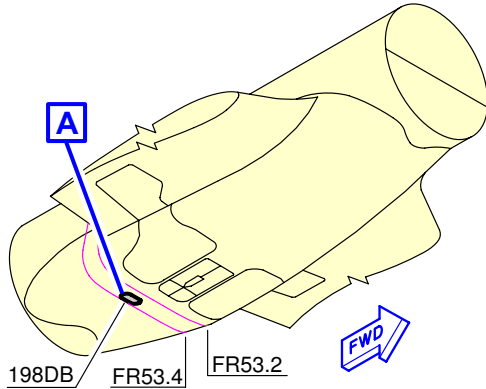

01

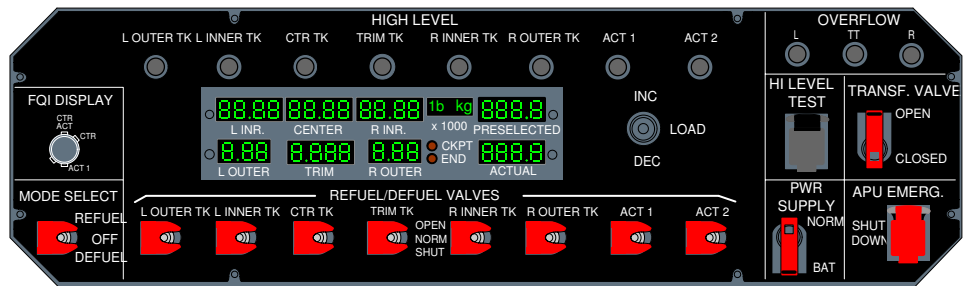

A 02

NOTE:

01 ON A/C A340-500

02 ON A/C A340-600

F_AC_050406_1_0170101_01_00

Ground Service Connections
Refuel/Defuel Control Panel
FIGURE-5-4-6-991-017-A01

A340-500/-600

AIRCRAFT CHARACTERISTICS - AIRPORT AND MAINTENANCE PLANNING

**ON A/C A340-500 A340-600

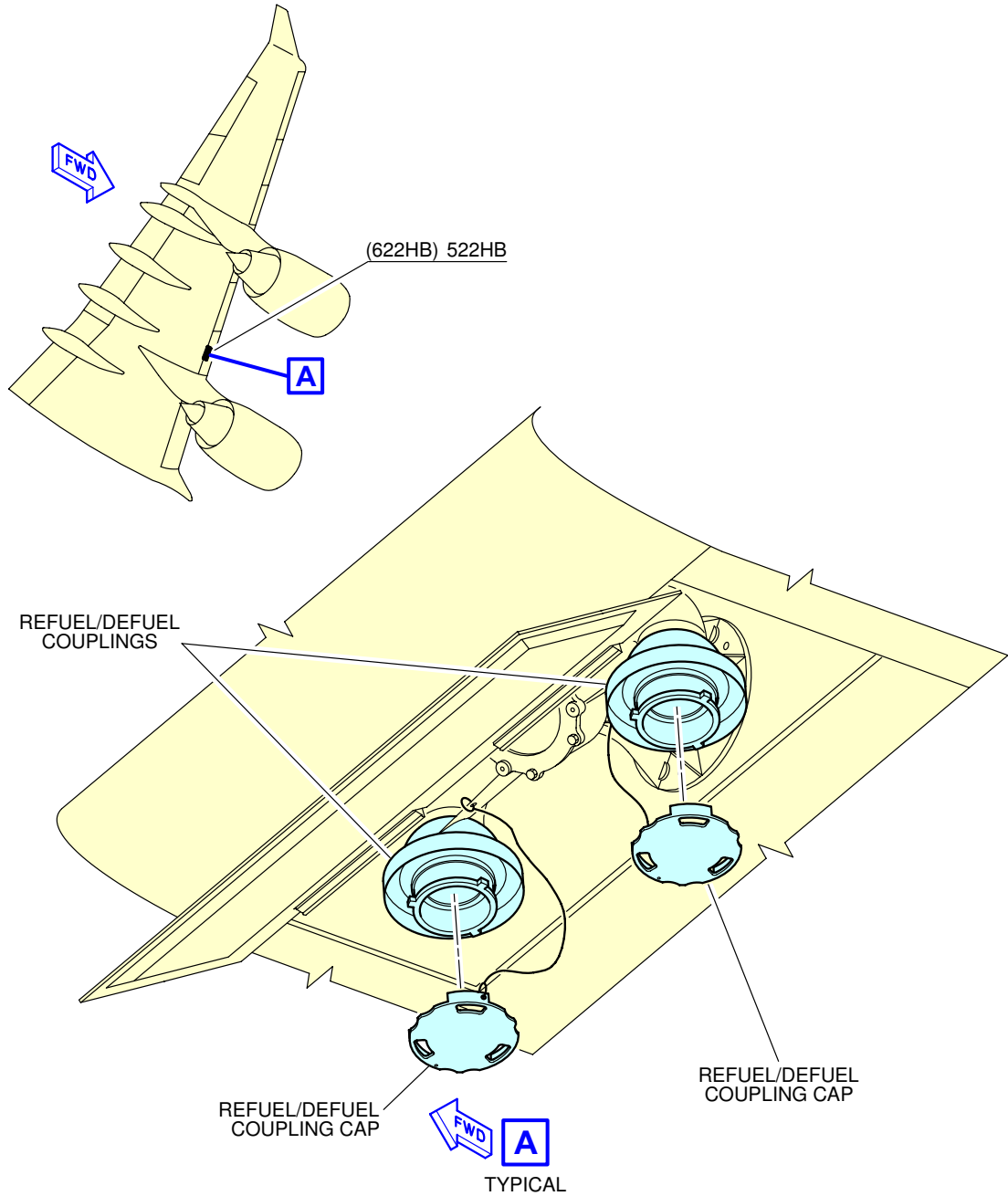

F_AC_050406_1_0190101_01_01

Ground Service Connections
Refuel/Defuel Coupling
FIGURE-5-4-6-991-019-A01

A340-500/-600

AIRCRAFT CHARACTERISTICS - AIRPORT AND MAINTENANCE PLANNING

**ON A/C A340-500 A340-600

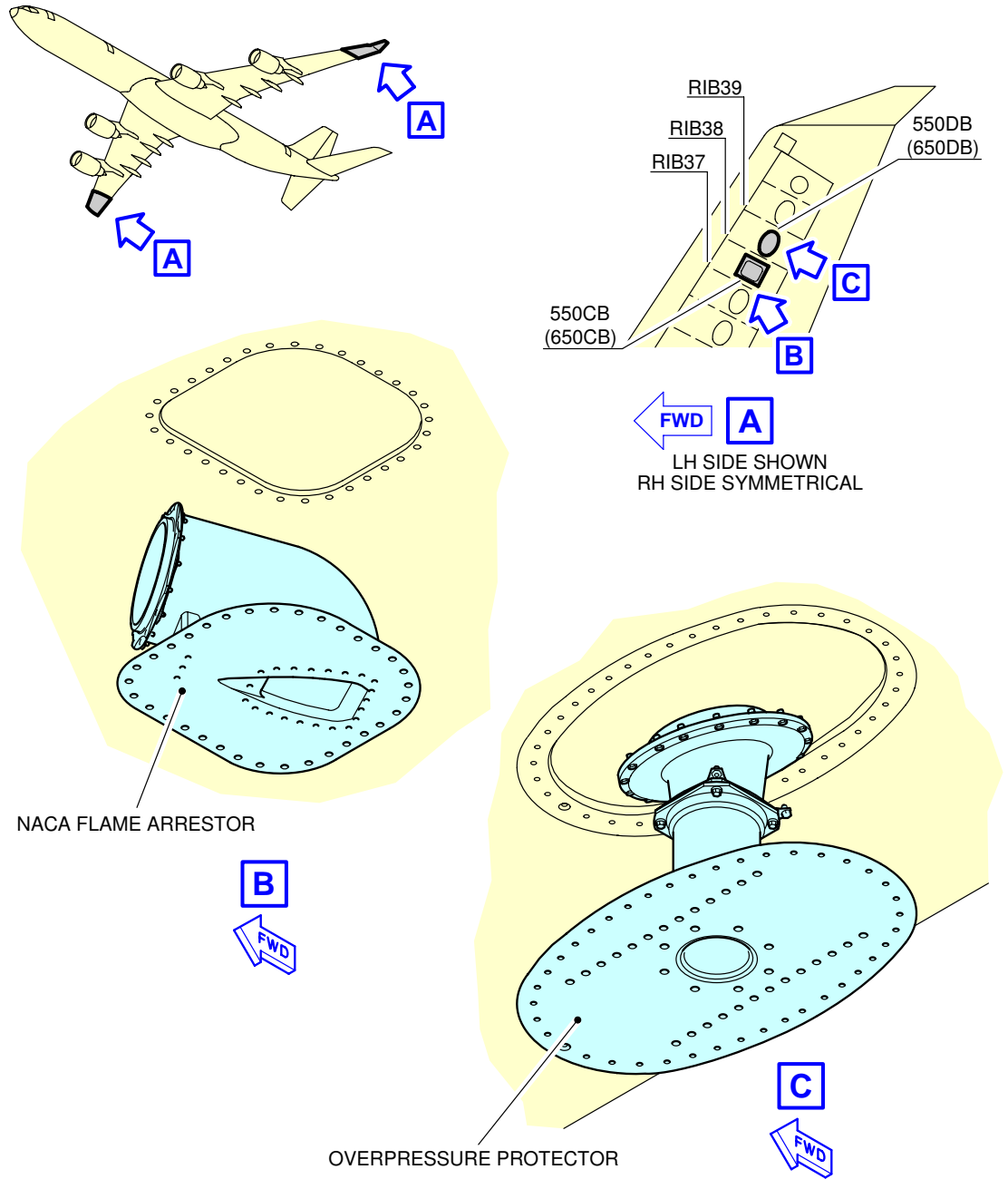

F_AC_050406_1_0040101_01_00

Ground Service Connections
Overpressure Protector and NACA Flame Arrestor - Wing
FIGURE-5-4-6-991-004-A01

A340-500/-600

AIRCRAFT CHARACTERISTICS - AIRPORT AND MAINTENANCE PLANNING

**ON A/C A340-500 A340-600

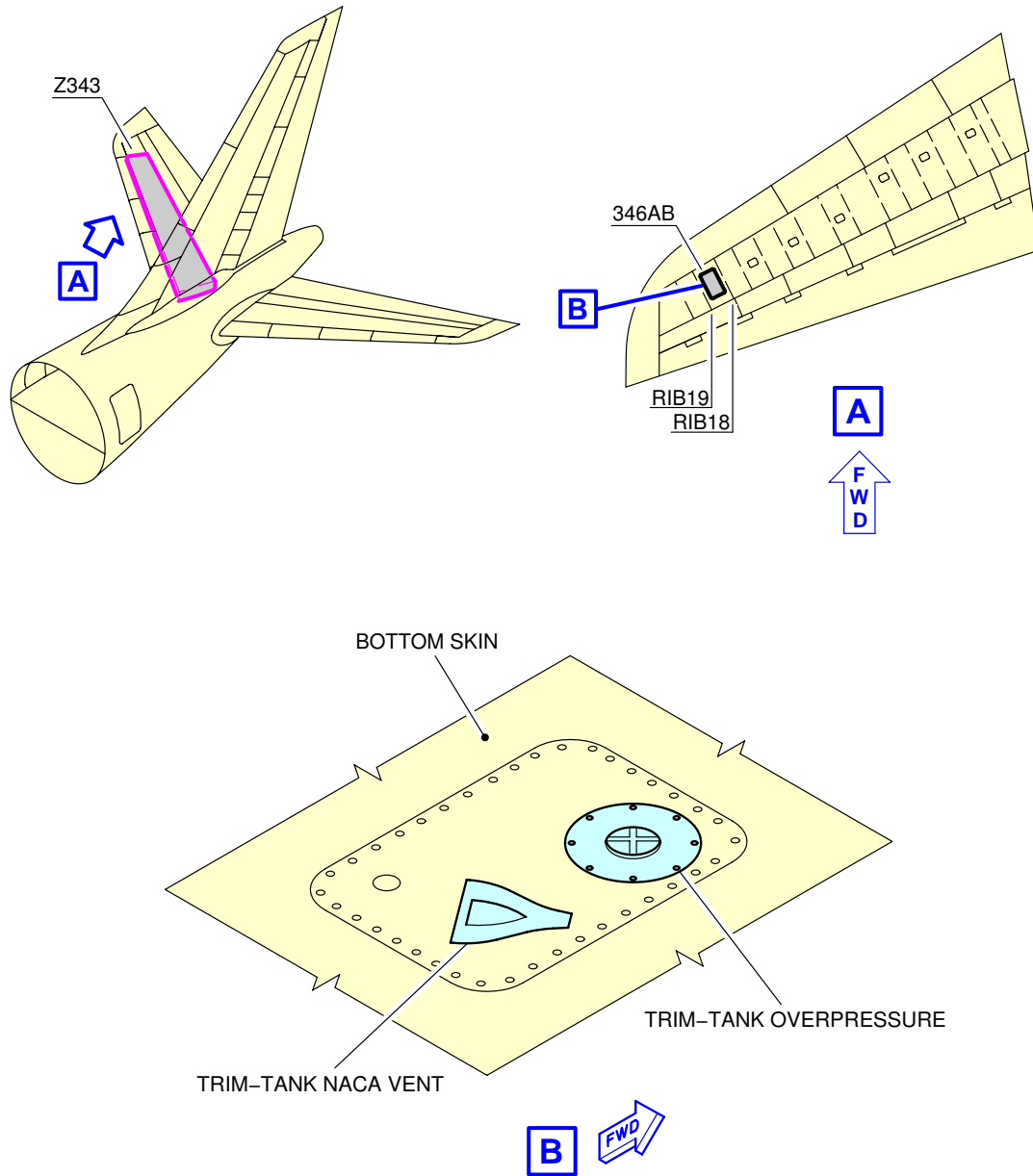

F_AC_050406_1_0200101_01_00

Ground Service Connections
Overpressure Protector and NACA Flame Arrestor - Trim Tank
FIGURE-5-4-6-991-020-A01

5-4-7 Pneumatic System

****ON A/C A340-500 A340-600**

Pneumatic Servicing

****ON A/C A340-600**

1. High Pressure Air Connection

ACCESS	DISTANCE			
	AFT OF NOSE	FROM AIRCRAFT CENTERLINE		MEAN HEIGHT FROM GROUND
		LH SIDE	RH SIDE	
HP Connectors: Access Door 193DB	29.71 m (97.47 ft)	0.35 m (1.15 ft)		1.75 m (5.74 ft)

A. Connectors:

- Two standard 3 in. ISO 2026 connections.

2. Low Pressure Air Connection

ACCESS	DISTANCE			
	AFT OF NOSE	FROM AIRCRAFT CENTERLINE		MEAN HEIGHT FROM GROUND
		LH SIDE	RH SIDE	
LP Connector: Access Door 193BB	28.75 m (94.32 ft)	On centerline		1.8 m (5.91 ft)
LP Connector: Access Door 193GB	28.75 m (94.32 ft)	0.63 m (2.07 ft)		1.8 m (5.91 ft)

A. Connectors:

- Two standard 8 in. SAE AS4262 connections.

A340-500/-600

AIRCRAFT CHARACTERISTICS - AIRPORT AND MAINTENANCE PLANNING

**ON A/C A340-500

3. High Pressure Air Connection

ACCESS	DISTANCE			
	AFT OF NOSE	FROM AIRCRAFT CENTERLINE		MEAN HEIGHT FROM GROUND
		LH SIDE	RH SIDE	
HP Connectors: Access Door 193DB	23.41 m (76.8 ft)	0.35 m (1.15 ft)		1.75 m (5.74 ft)

- A. Connectors:
 - Two standard 3 in. ISO 2026 connections.

4. Low Pressure Air Connection

ACCESS	DISTANCE			
	AFT OF NOSE	FROM AIRCRAFT CENTERLINE		MEAN HEIGHT FROM GROUND
		LH SIDE	RH SIDE	
LP Connector: Access Door 193BB	23.45 m (76.94 ft)	On centerline		1.8 m (5.91 ft)
LP Connector: Access Door 193GB	23.45 m (76.94 ft)	0.63 m (2.07 ft)		1.8 m (5.91 ft)

- A. Connectors:
 - Two standard 8 in. SAE AS4262 connections.

A340-500/-600

AIRCRAFT CHARACTERISTICS - AIRPORT AND MAINTENANCE PLANNING

**ON A/C A340-500 A340-600

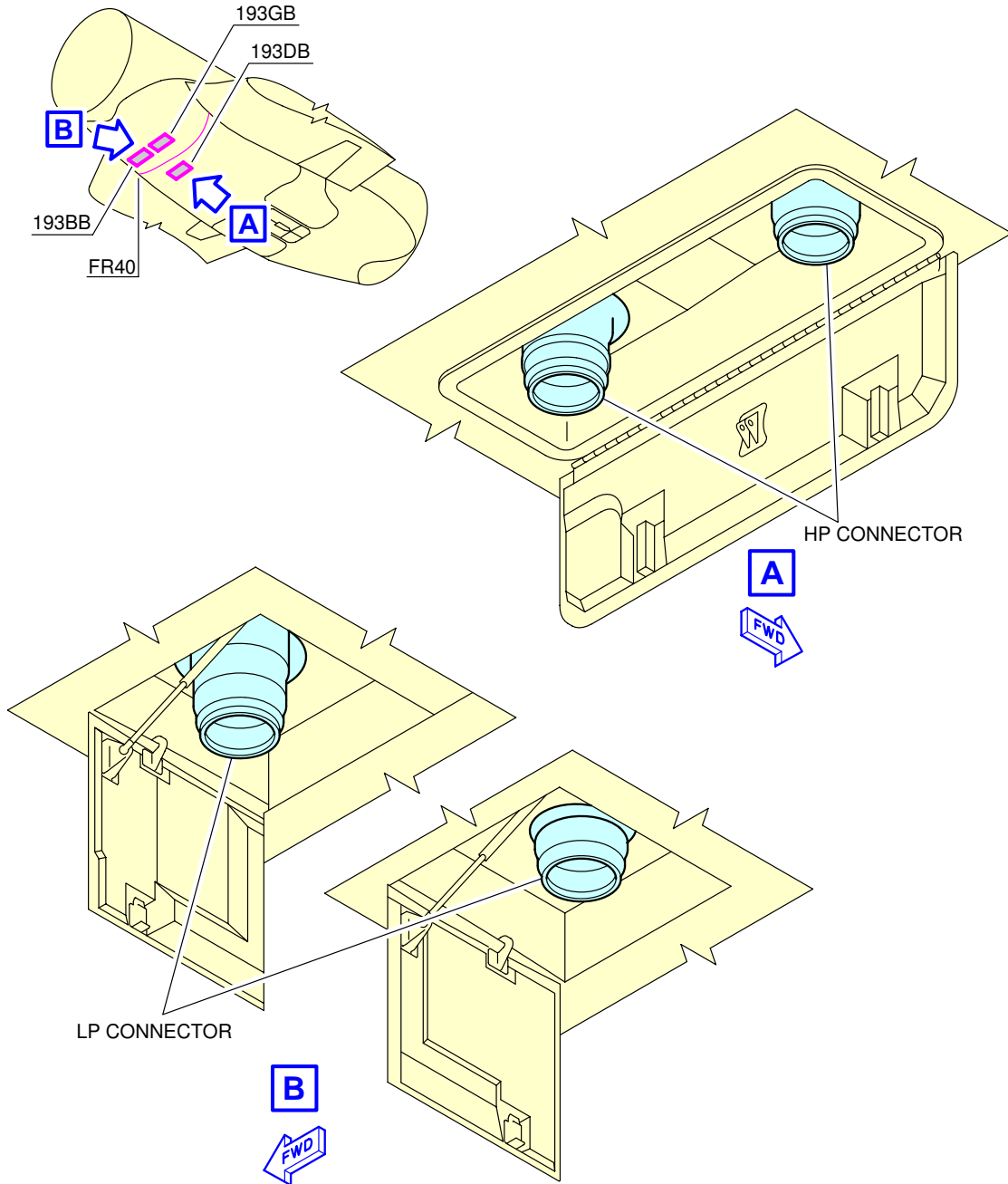

F_AC_050407_1_0030101_01_00

Ground Service Connections
LP and HP Ground Connectors
FIGURE-5-4-7-991-003-A01

A340-500/-600

AIRCRAFT CHARACTERISTICS - AIRPORT AND MAINTENANCE PLANNING

5-4-8 Oil System

****ON A/C A340-500 A340-600**

Oil Servicing

****ON A/C A340-600**

1. RR TRENT 500 Series Engine

A. Engine Oil Replenishment:

One gravity filling cap and one pressure filling connection per engine.

ACCESS	DISTANCE			MEAN HEIGHT FROM GROUND
	AFT OF NOSE	FROM AIRCRAFT CENTERLINE		
		LH SIDE	RH SIDE	
Engine 1: Access Door: 416BR	36.30 m (119.09 ft)	17.85 m (58.56 ft)		3.15 m (10.33 ft)
Engine 2: Access Door: 426BR	29.70 m (97.44 ft)	7.95 m (26.08 ft)		1.60 m (5.25 ft)
Engine 3: Access Door: 436BR	29.70 m (97.44 ft)		10.80 m (35.43 ft)	1.60 m (5.25 ft)
Engine 4: Access Door: 446BR	36.30 m (119.09 ft)		20.70 m (67.91 ft)	3.15 m (10.33 ft)

(1) Approximate tank capacity:

- Full level: 23.70 l (6.26 US gal).
- Usable: 15.90 l (4.20 US gal).

B. IDG Oil Replenishment:

One pressure filling connection per engine.

ACCESS	DISTANCE			MEAN HEIGHT FROM GROUND
	AFT OF NOSE	FROM AIRCRAFT CENTERLINE		
		LH SIDE	RH SIDE	
Engine 1: Access Door: 415CL	36.97 m (121.29 ft)	19.66 m (64.50 ft)		1.85 m (6.07 ft)

A340-500/-600

AIRCRAFT CHARACTERISTICS - AIRPORT AND MAINTENANCE PLANNING

ACCESS	DISTANCE			MEAN HEIGHT FROM GROUND
	AFT OF NOSE	FROM AIRCRAFT CENTERLINE		
		LH SIDE	RH SIDE	
Engine 2: Access Door: 425CL	30.36 m (99.61 ft)	9.76 m (32.02 ft)		0.80 m (2.62 ft)
Engine 3: Access Door: 435CL	30.36 m (99.61 ft)		8.98 m (29.46 ft)	0.80 m (2.62 ft)
Engine 4: Access Door: 445CL	36.97 m (121.29 ft)		18.87 m (61.91 ft)	1.85 m (6.07 ft)

- (1) IDG oil replenishment:
 - one ozone self-sealing pressure fill and overfill connector.
- (2) Max delivery pressure:
 - 2.41 bar (34.95 psi).
- (3) Approximate max oil capacity of the IDG:
 - 6.80 l (1.80 US gal).

C. Starter Oil Replenishment:
One filling connection per engine.

ACCESS	DISTANCE			MEAN HEIGHT FROM GROUND
	AFT OF NOSE	FROM AIRCRAFT CENTERLINE		
		LH SIDE	RH SIDE	
Engine 1: Access Door: 415AL (416AR)	36.30 m (119.09 ft)	19.72 m (64.70 ft)		1.80 m (5.91 ft)
Engine 2: Access Door: 425AL (426AR)	29.70 m (97.44 ft)	9.82 m (32.22 ft)		0.77 m (2.53 ft)
Engine 3: Access Door: 435AL (436AR)	29.70 m (97.44 ft)		8.92 m (29.27 ft)	0.77 m (2.53 ft)
Engine 4: Access Door: 445AL (446AR)	36.30 m (119.09 ft)		18.82 m (61.75 ft)	1.80 m (5.91 ft)

- (1) Pneumatic starter, oil replenishment:
 - one gravity filling plug.

A340-500/-600

AIRCRAFT CHARACTERISTICS - AIRPORT AND MAINTENANCE PLANNING

- (2) Approximate max oil capacity of the starter:
 - 0.40 l (0.11 US gal).

****ON A/C A340-500**

2. RR TRENT 500 Series Engine

A. Engine Oil Replenishment:

One gravity filling cap and one pressure filling connection per engine.

ACCESS	DISTANCE			MEAN HEIGHT FROM GROUND
	AFT OF NOSE	FROM AIRCRAFT CENTERLINE		
		LH SIDE	RH SIDE	
Engine 1: Access Door: 416BR	31.00 m (101.71 ft)	17.85 m (58.56 ft)		3.15 m (10.33 ft)
Engine 2: Access Door: 426BR	24.42 m (80.12 ft)	7.95 m (26.08 ft)		1.60 m (5.25 ft)
Engine 3: Access Door: 436BR	24.42 m (80.12 ft)		10.80 m (35.43 ft)	1.60 m (5.25 ft)
Engine 4: Access Door: 446BR	31.00 m (101.71 ft)		20.70 m (67.91 ft)	3.15 m (10.33 ft)

- (1) Approximate tank capacity:
 - Full level: 23.70 l (6.26 US gal).
 - Usable: 15.90 l (4.20 US gal).

B. IDG Oil Replenishment:

One pressure filling connection per engine.

ACCESS	DISTANCE			MEAN HEIGHT FROM GROUND
	AFT OF NOSE	FROM AIRCRAFT CENTERLINE		
		LH SIDE	RH SIDE	
Engine 1: Access Door: 415CL	31.66 m (103.87 ft)	19.66 m (64.50 ft)		1.85 m (6.07 ft)
Engine 2: Access Door: 425CL	25.05 m (82.19 ft)	9.76 m (32.02 ft)		0.80 m (2.62 ft)

ACCESS	DISTANCE			
	AFT OF NOSE	FROM AIRCRAFT CENTERLINE		MEAN HEIGHT FROM GROUND
		LH SIDE	RH SIDE	
Engine 3: Access Door: 435CL	25.05 m (82.19 ft)		8.98 m (29.46 ft)	0.80 m (2.62 ft)
Engine 4: Access Door: 445CL	31.66 m (103.87 ft)		18.87 m (61.91 ft)	1.85 m (6.07 ft)

- (1) IDG oil replenishment:
 - one ozone self-sealing pressure fill and overfill connector.
- (2) Max delivery pressure:
 - 2.41 bar (34.95 psi).
- (3) Approximate max oil capacity of the IDG:
 - 6.80 l (1.80 US gal).

C. Starter Oil Replenishment:
One filling connection per engine.

ACCESS	DISTANCE			
	AFT OF NOSE	FROM AIRCRAFT CENTERLINE		MEAN HEIGHT FROM GROUND
		LH SIDE	RH SIDE	
Engine 1: Access Door: 415AL (416AR)	31.00 m (101.71 ft)	19.72 m (64.70 ft)		1.80 m (5.91 ft)
Engine 2: Access Door: 425AL (426AR)	24.42 m (80.12 ft)	9.82 m (32.22 ft)		0.77 m (2.53 ft)
Engine 3: Access Door: 435AL (436AR)	24.42 m (80.12 ft)		8.92 m (29.27 ft)	0.77 m (2.53 ft)
Engine 4: Access Door: 445AL (446AR)	31.00 m (101.71 ft)		18.82 m (61.75 ft)	1.80 m (5.91 ft)

- (1) Pneumatic starter, oil replenishment:
 - one gravity filling plug.
- (2) Approximate max oil capacity of the starter:
 - 0.40 l (0.11 US gal).

A340-500/-600

AIRCRAFT CHARACTERISTICS - AIRPORT AND MAINTENANCE PLANNING

**ON A/C A340-500 A340-600

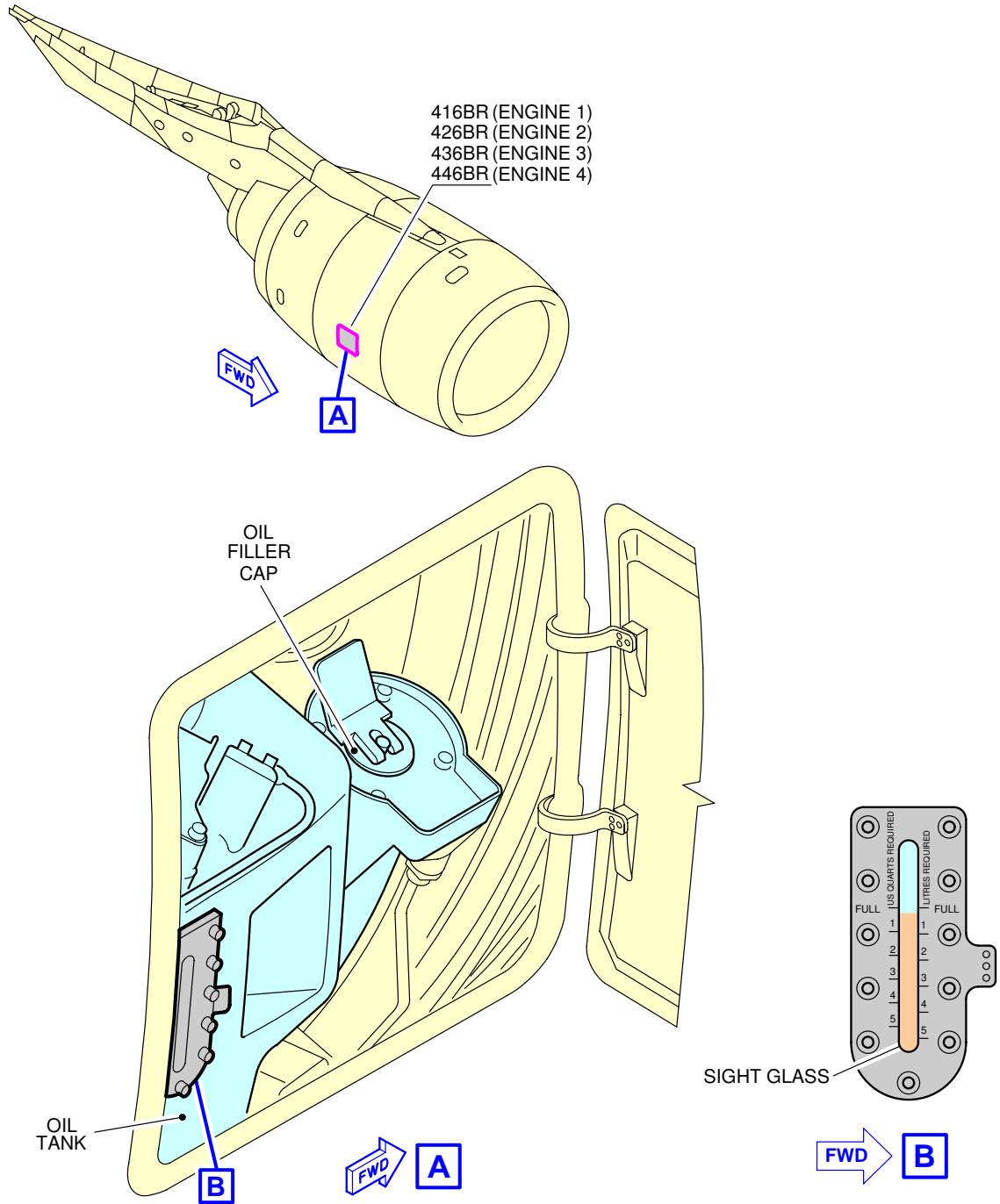

Ground Service Connections
Engine Oil Tank - RR TRENT 500 Series Engine
FIGURE-5-4-8-991-019-A01

F_AC_050408_1_0190101_01_00

A340-500/-600

AIRCRAFT CHARACTERISTICS - AIRPORT AND MAINTENANCE PLANNING

**ON A/C A340-500 A340-600

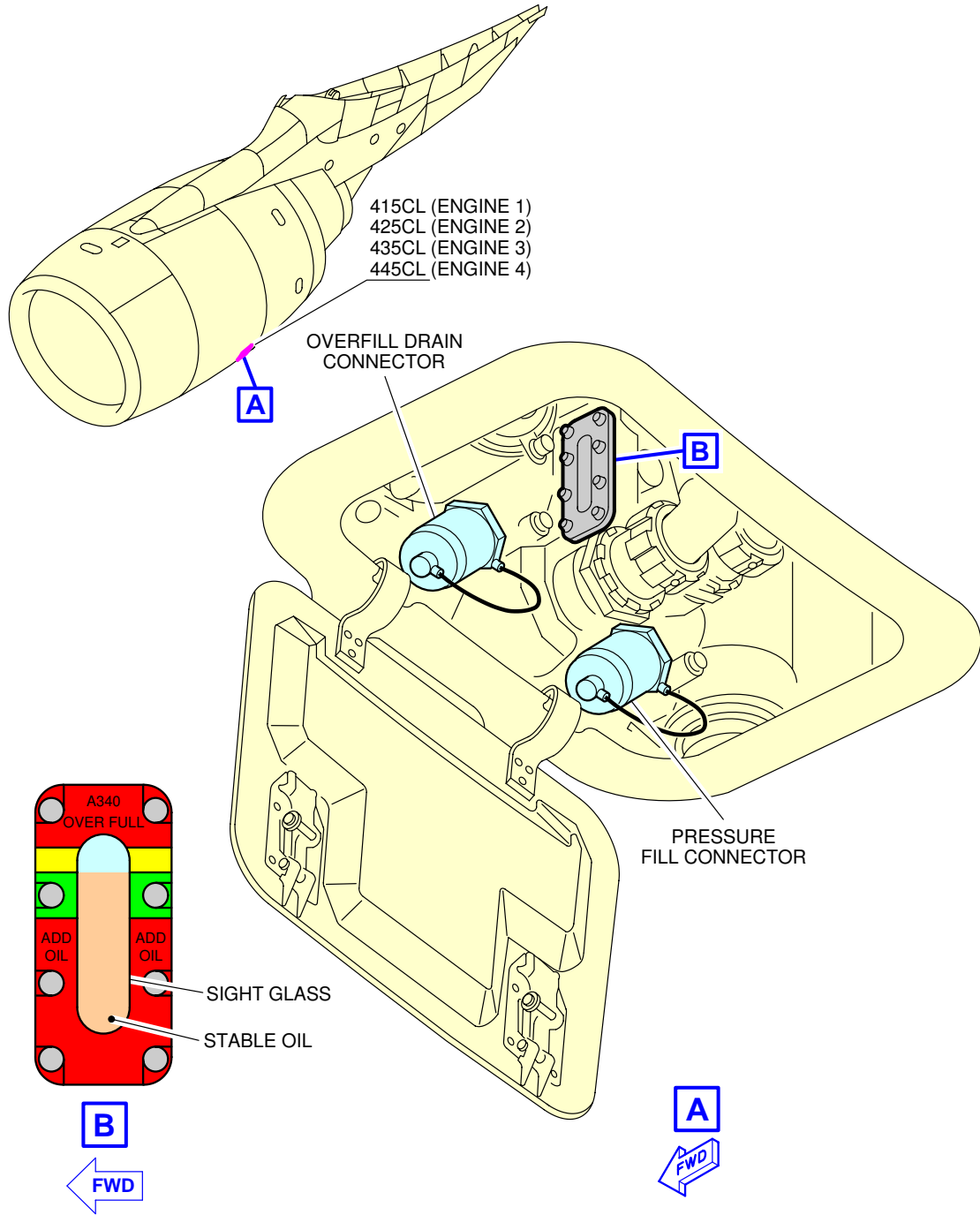

F_AC_050408_1_0200101_01_00

Ground Service Connections
IDG Oil Tank - RR TRENT 500 Series Engine
FIGURE-5-4-8-991-020-A01

A340-500/-600

AIRCRAFT CHARACTERISTICS - AIRPORT AND MAINTENANCE PLANNING

**ON A/C A340-500 A340-600

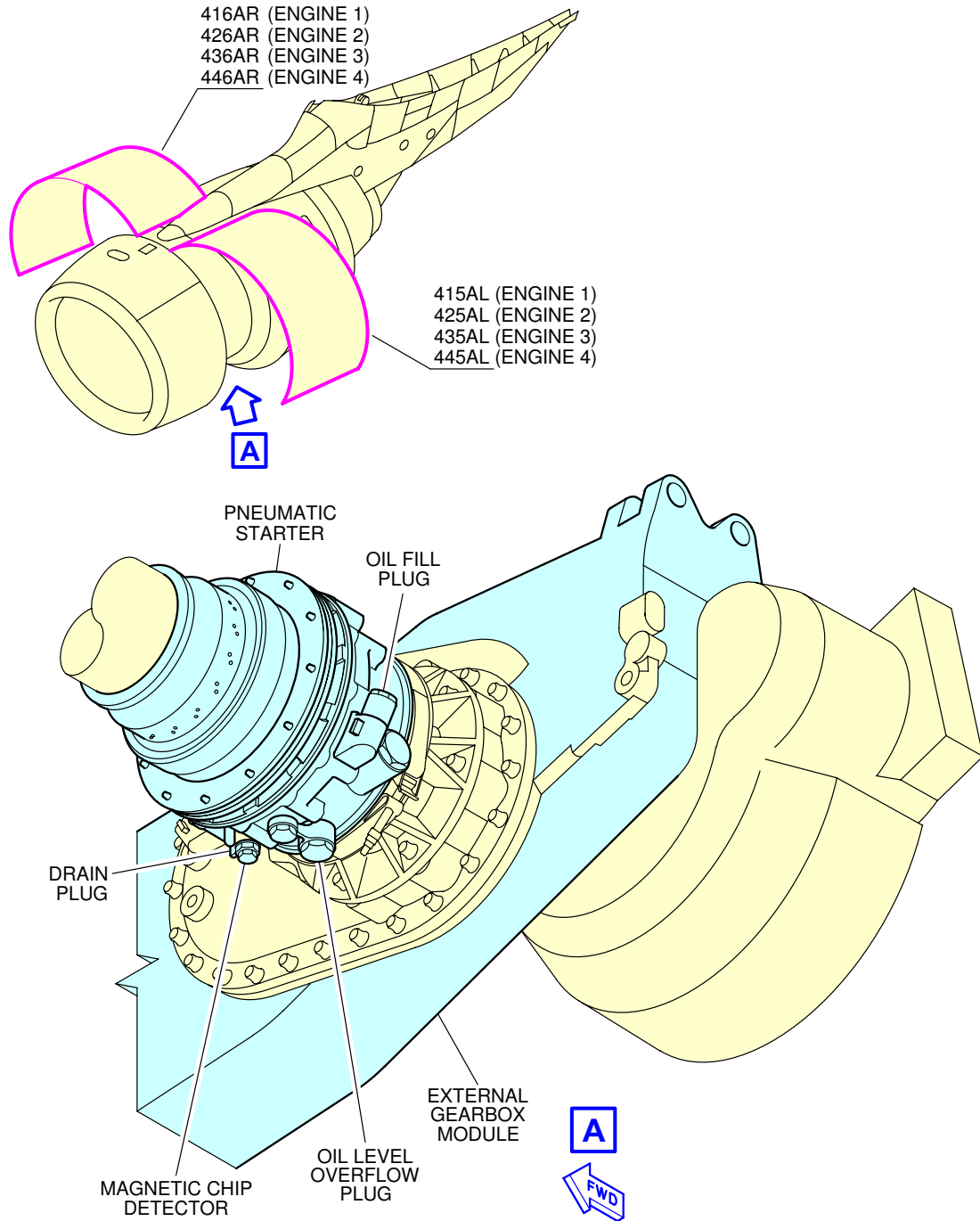

F_AC_050408_1_0210101_01_00

Ground Service Connections
Starter Oil Tank - RR TRENT 500 Series Engine
FIGURE-5-4-8-991-021-A01

A340-500/-600

AIRCRAFT CHARACTERISTICS - AIRPORT AND MAINTENANCE PLANNING

****ON A/C A340-500 A340-600**

APU Oil Servicing

****ON A/C A340-600**

1. APU Oil Servicing:
APU oil gravity filling cap.

ACCESS	DISTANCE			MEAN HEIGHT FROM GROUND
	AFT OF NOSE	FROM AIRCRAFT CENTERLINE		
		LH SIDE	RH SIDE	
APU Oil Replenishment: Access Doors: 316AR, 315AL	71 m (232.94 ft)	0.4 m (1.31 ft)		8 m (26.25 ft)

- A. Tank capacity (usable):
 - APU Type: 331-350: 7.3 l (1.93 US gal)
 - APU Type: 331-600: 11 l (2.91 US gal).

****ON A/C A340-500**

2. APU Oil Servicing:
APU oil gravity filling cap.

ACCESS	DISTANCE			MEAN HEIGHT FROM GROUND
	AFT OF NOSE	FROM AIRCRAFT CENTERLINE		
		LH SIDE	RH SIDE	
APU Oil Replenishment: Access Doors: 316AR, 315AL	63.5 m (208.33 ft)	0.4 m (1.31 ft)		8 m (26.25 ft)

- A. Tank capacity (usable):
 - APU Type: 331-350: 7.3 l (1.93 US gal)
 - APU Type: 331-600: 11 l (2.91 US gal).

A340-500/-600

AIRCRAFT CHARACTERISTICS - AIRPORT AND MAINTENANCE PLANNING

**ON A/C A340-500 A340-600

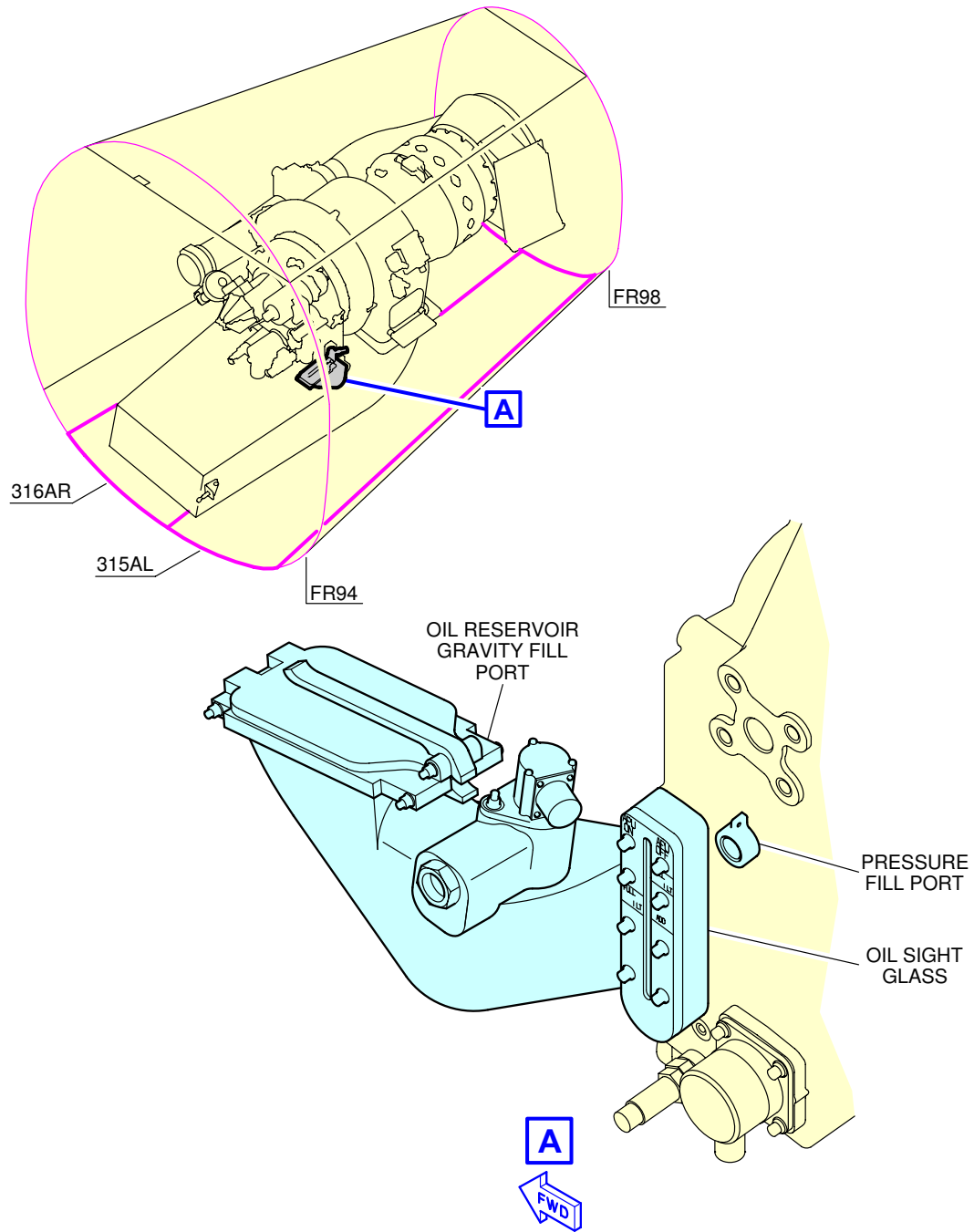

F_AC_050408_1_0230101_01_00

Ground Service Connections
APU Oil Servicing
FIGURE-5-4-8-991-023-A01

5-4-9 Potable Water System

****ON A/C A340-600**

Potable Water Servicing

1. Potable Water Servicing

ACCESS	DISTANCE			MEAN HEIGHT FROM GROUND
	AFT OF NOSE	FROM AIRCRAFT CENTERLINE		
		LH SIDE	RH SIDE	
Potable-Water Service Panel: Access Door 154BR	58.75 m (192.75 ft)		0.5 m (1.64 ft)	3.5 m (11.48 ft)

NOTE : Distances are approximate.

2. Technical Specifications

- A. Connectors
 - Roylin, 3/4 in. (ISO 17775).
- B. Capacity
 - 1070 l (282.66 US gal).
- C. Filling Pressure and Flow Rate
 - Filling pressure: 1.72/2.07 bar (25/30 psi)
 - Flow rate: 87.5 l/min (23.12 US gal/min).

A340-500/-600

AIRCRAFT CHARACTERISTICS - AIRPORT AND MAINTENANCE PLANNING

**ON A/C A340-600

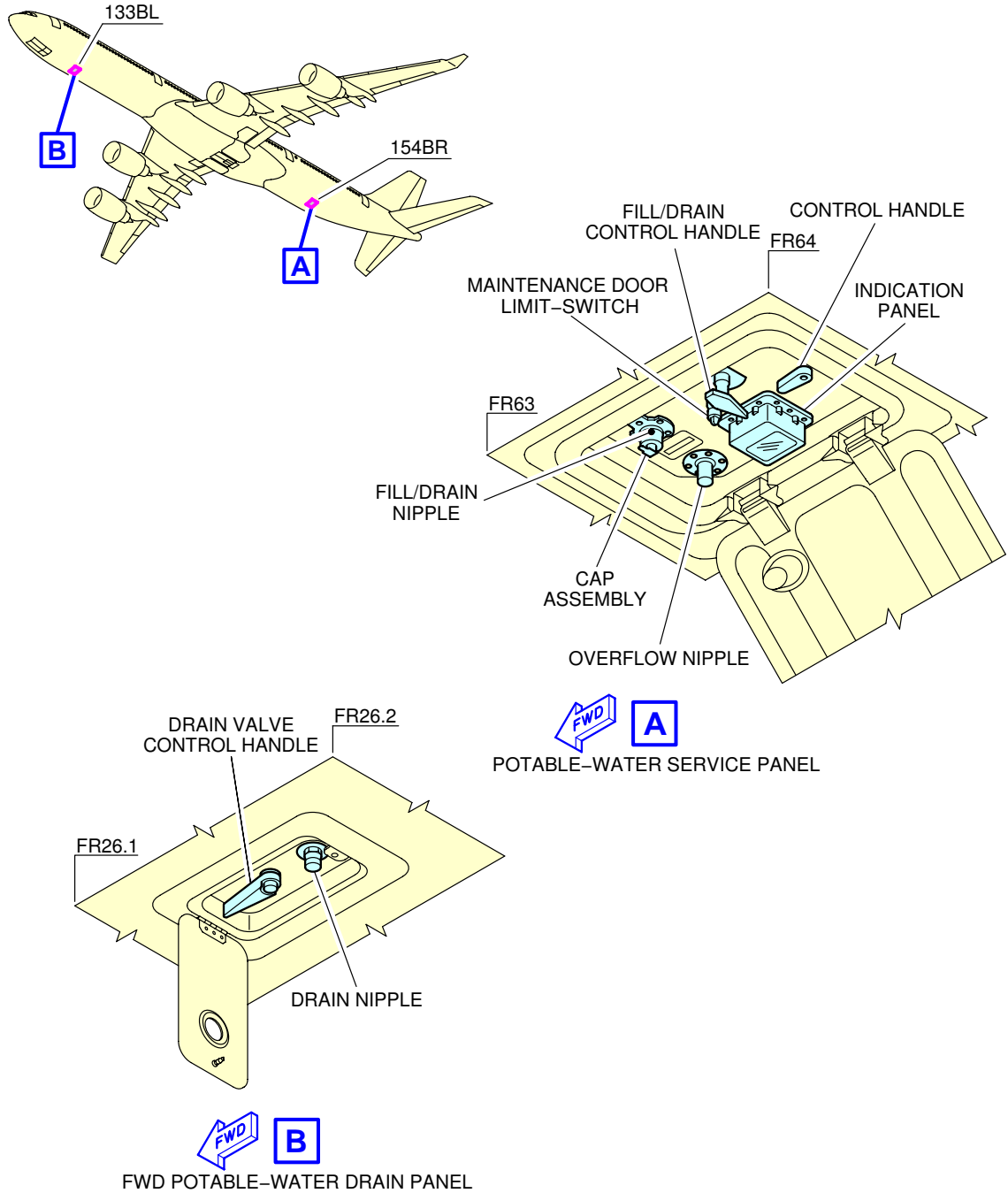

F_AC_050409_1_0330101_01_00

Ground Service Connections
Potable-Water Ground Service Panels
FIGURE-5-4-9-991-033-A01

A340-500/-600

AIRCRAFT CHARACTERISTICS - AIRPORT AND MAINTENANCE PLANNING

**ON A/C A340-600

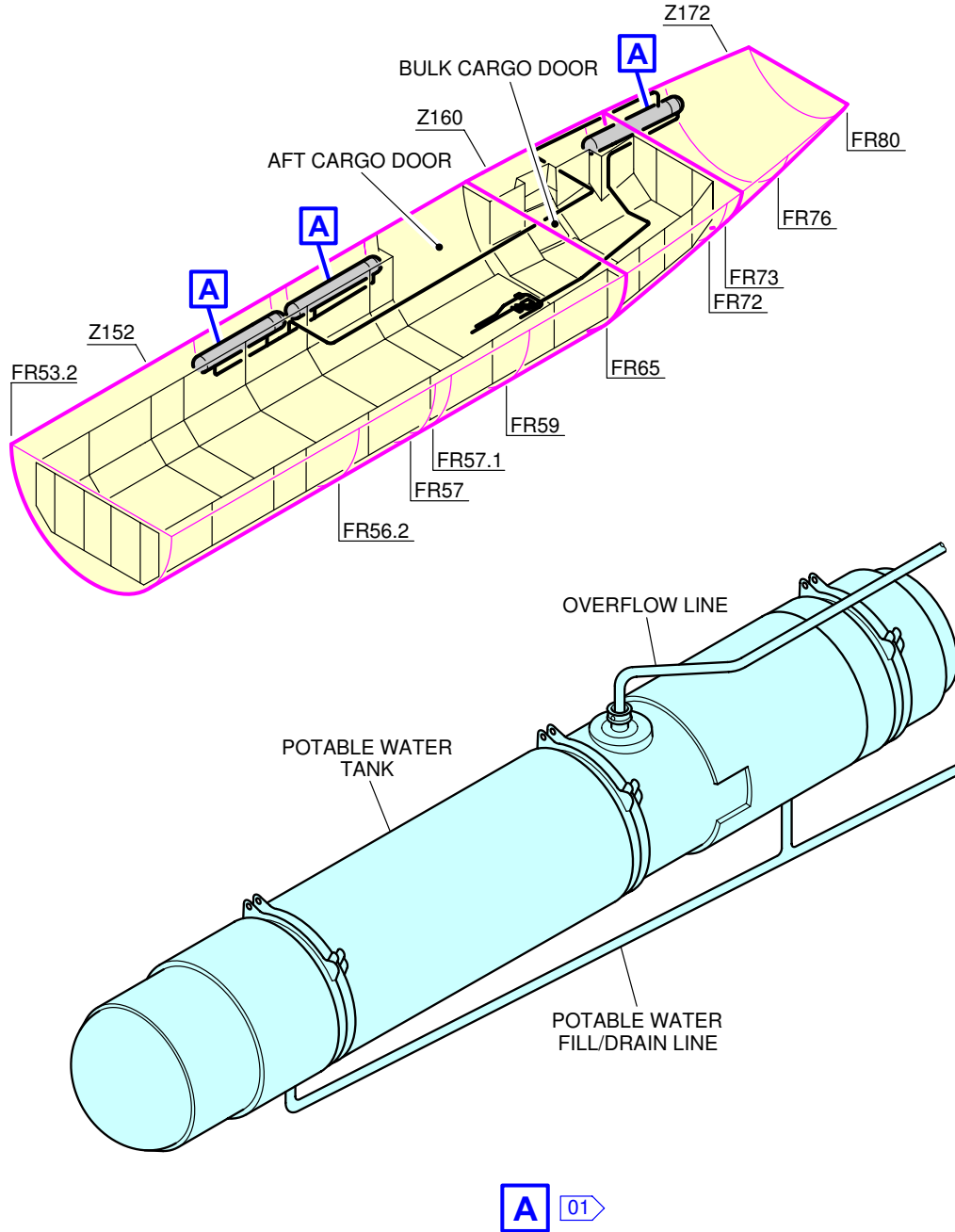

NOTE:
01 TYPICAL

F_AC_050409_1_0340101_01_00

Ground Service Connections
Potable-Water Tanks Location
FIGURE-5-4-9-991-034-A01

****ON A/C A340-500**

Potable Water Servicing

1. Potable Water Servicing

ACCESS	DISTANCE			MEAN HEIGHT FROM GROUND
	AFT OF NOSE	FROM AIRCRAFT CENTERLINE		
		LH SIDE	RH SIDE	
Potable-Water Service Panel: Access Door 154BR	51.32 m (168.37 ft)		0.5 m (1.64 ft)	3.5 m (11.48 ft)

NOTE : Distances are approximate.

2. Technical Specifications

- A. Connectors
 - Roylin, 3/4 in. (ISO 17775)
- B. Capacity
 - 700 l (184.92 US gal).
- C. Filling Pressure and Flow Rate
 - Filling pressure: 1.72/2.07 bar (25/30 psi)
 - Flow rate: 87.5 l/min (23.12 US gal/min).

A340-500/-600

AIRCRAFT CHARACTERISTICS - AIRPORT AND MAINTENANCE PLANNING

**ON A/C A340-500

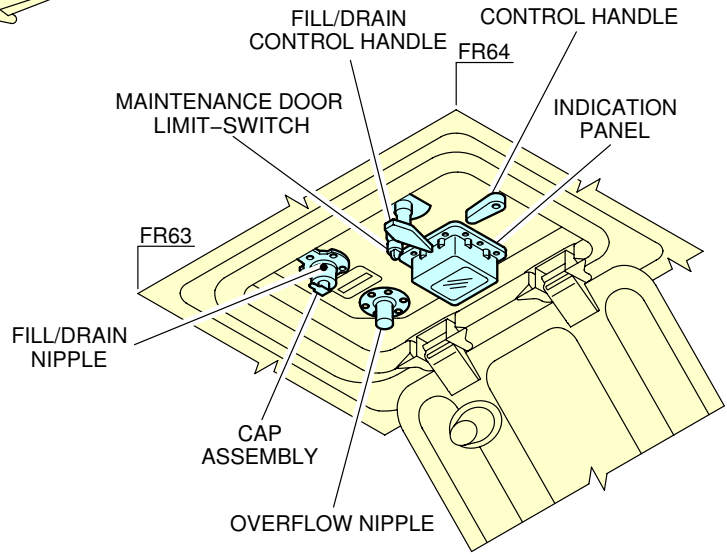
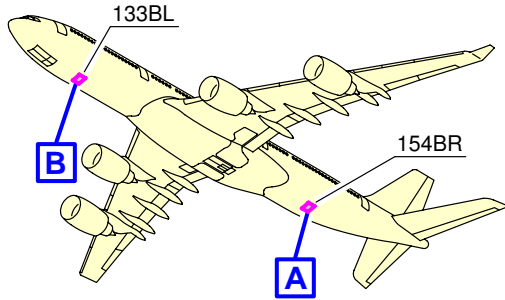

FWD **A**
POTABLE-WATER SERVICE PANEL

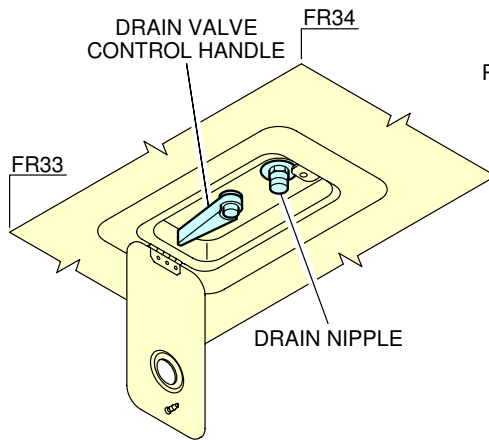

FWD **B**
FWD POTABLE-WATER DRAIN PANEL

F_AC_050409_1_0350101_01_00

Ground Service Connections
Potable-Water Ground Service Panels
FIGURE-5-4-9-991-035-A01

A340-500/-600

AIRCRAFT CHARACTERISTICS - AIRPORT AND MAINTENANCE PLANNING

**ON A/C A340-500

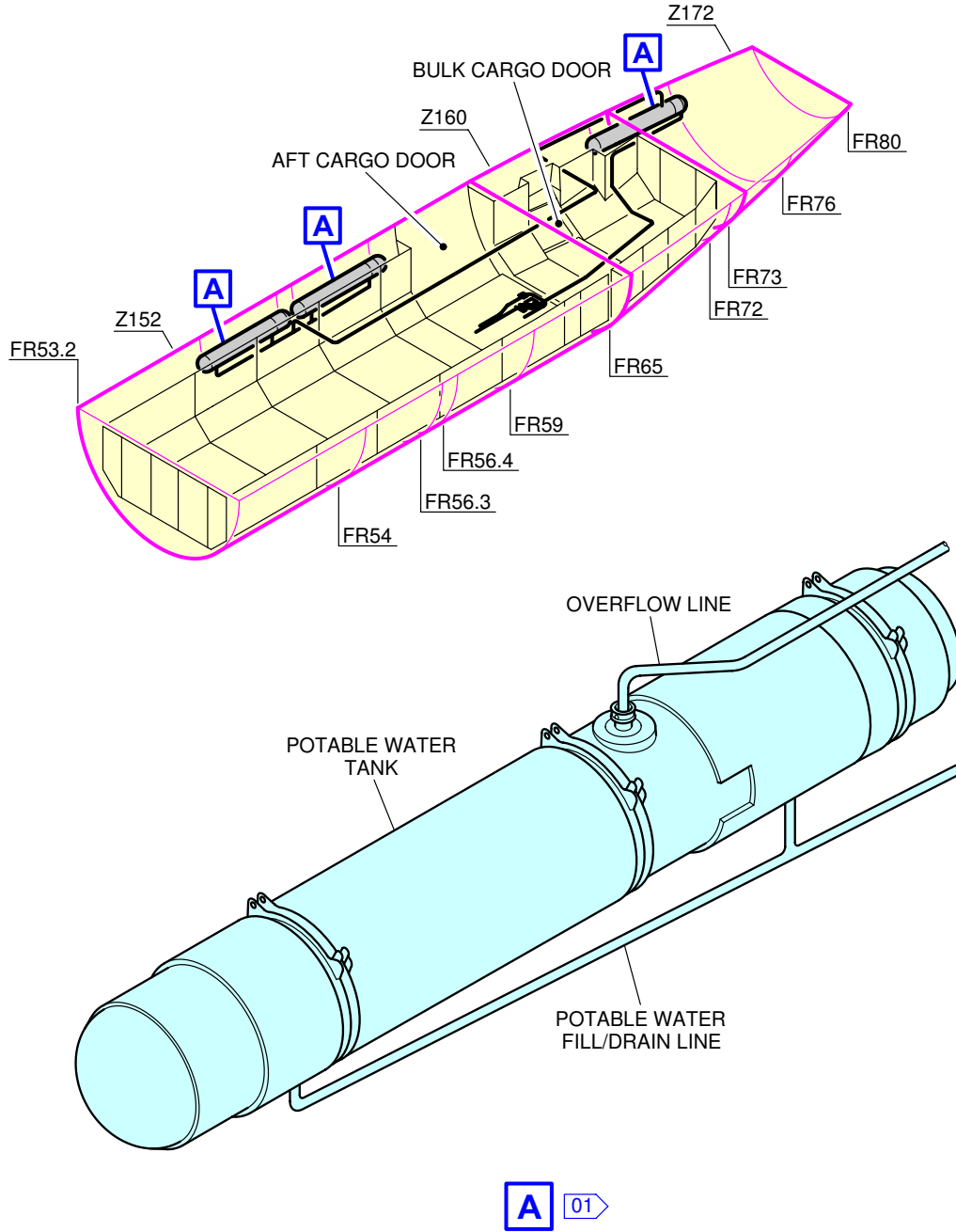

NOTE:
01 TYPICAL

F_AC_050409_1_0360101_01_00

Ground Service Connections
Potable-Water Tanks Location
FIGURE-5-4-9-991-036-A01

5-4-10 Waste Water System

****ON A/C A340-500 A340-600**

Waste Water Servicing

****ON A/C A340-600**

1. Waste Water Servicing

ACCESS	DISTANCE			MEAN HEIGHT FROM GROUND
	AFT OF NOSE	FROM AIRCRAFT CENTERLINE		
		LH SIDE	RH SIDE	
Waste Water Ground Service Panel: Access Door 171AL	60.61 m (198.85 ft)	0.10 m (0.33 ft)		4.00 m (13.12 ft)

- A. Connectors:
 - Flushing and filling: Roylin, 1 in. (ISO 17775).
 - Draining: Roylin, 4 in. (ISO 17775).
- B. Capacity (four tanks - basic configuration):
 - 1050 l (277.38 US gal).
- C. Operating pressure:
 - 0.07 bar (1.02 psi)/0.70 bar (10.15 psi).
- D. Flow rate:
 - 87.5 l/min (23.1 US gal/min).

****ON A/C A340-500**

2. Waste Water Servicing

ACCESS	DISTANCE			MEAN HEIGHT FROM GROUND
	AFT OF NOSE	FROM AIRCRAFT CENTERLINE		
		LH SIDE	RH SIDE	
Waste Water Ground Service Panel: Access Door 171AL	53.18 m (174.48 ft)	0.10 m (0.33 ft)		4.00 m (13.12 ft)

- A. Connectors:
 - Flushing and filling: Roylin, 1 in. (ISO 17775).
 - Draining: Roylin, 4 in. (ISO 17775).

A340-500/-600

AIRCRAFT CHARACTERISTICS - AIRPORT AND MAINTENANCE PLANNING

- B. Capacity (four tanks - basic configuration):
 - 1050 l (277.38 US gal).
- C. Operating pressure:
 - 0.07 bar (1.02 psi)/0.70 bar (10.15 psi).
- D. Flow rate:
 - 87.5 l/min (23.1 US gal/min).

A340-500/-600

AIRCRAFT CHARACTERISTICS - AIRPORT AND MAINTENANCE PLANNING

**ON A/C A340-500 A340-600

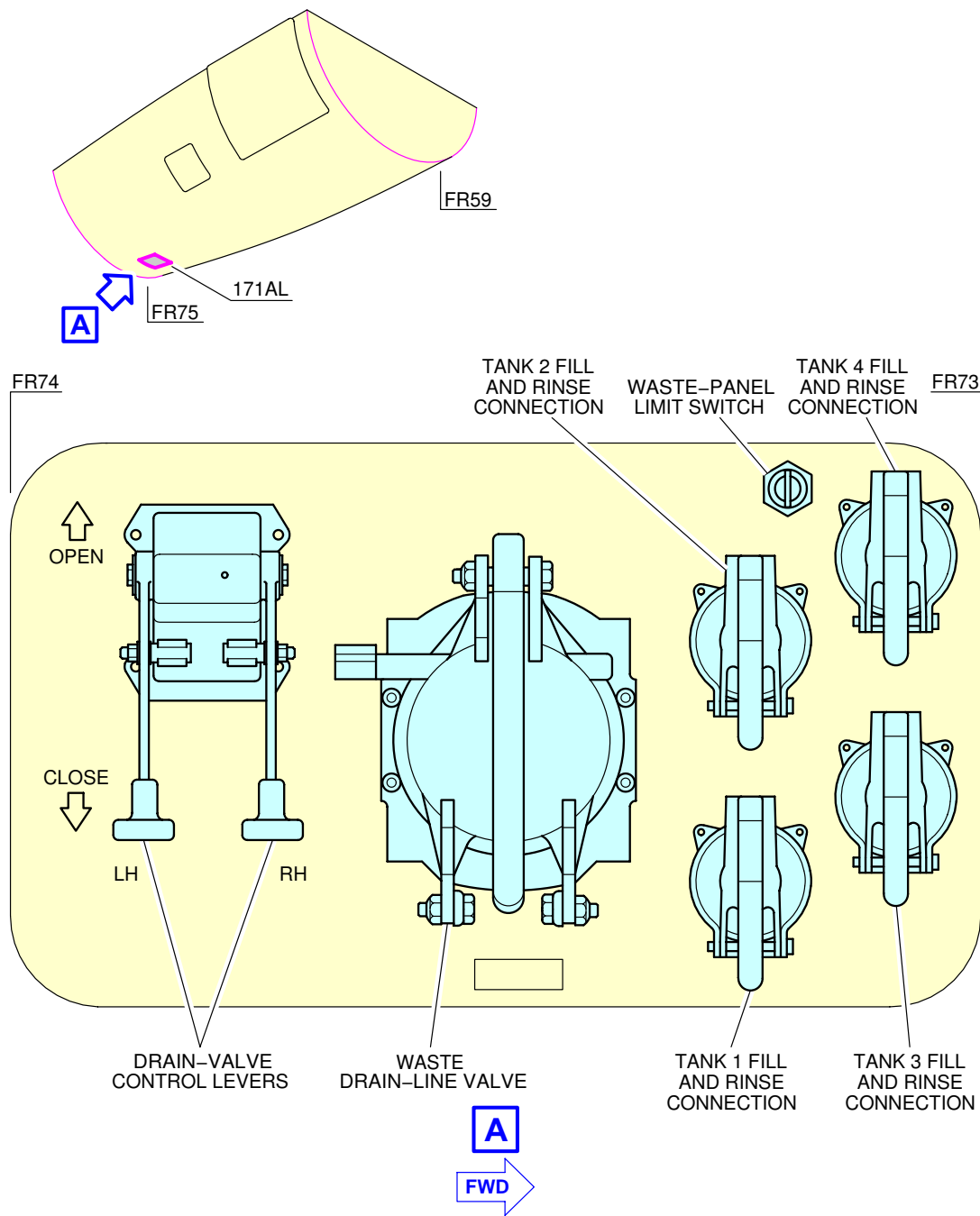

F_AC_050410_1_0030101_01_00

Ground Service Connections
 Waste Water Ground Service Panel
 FIGURE-5-4-10-991-003-A01

A340-500/-600

AIRCRAFT CHARACTERISTICS - AIRPORT AND MAINTENANCE PLANNING

**ON A/C A340-500 A340-600

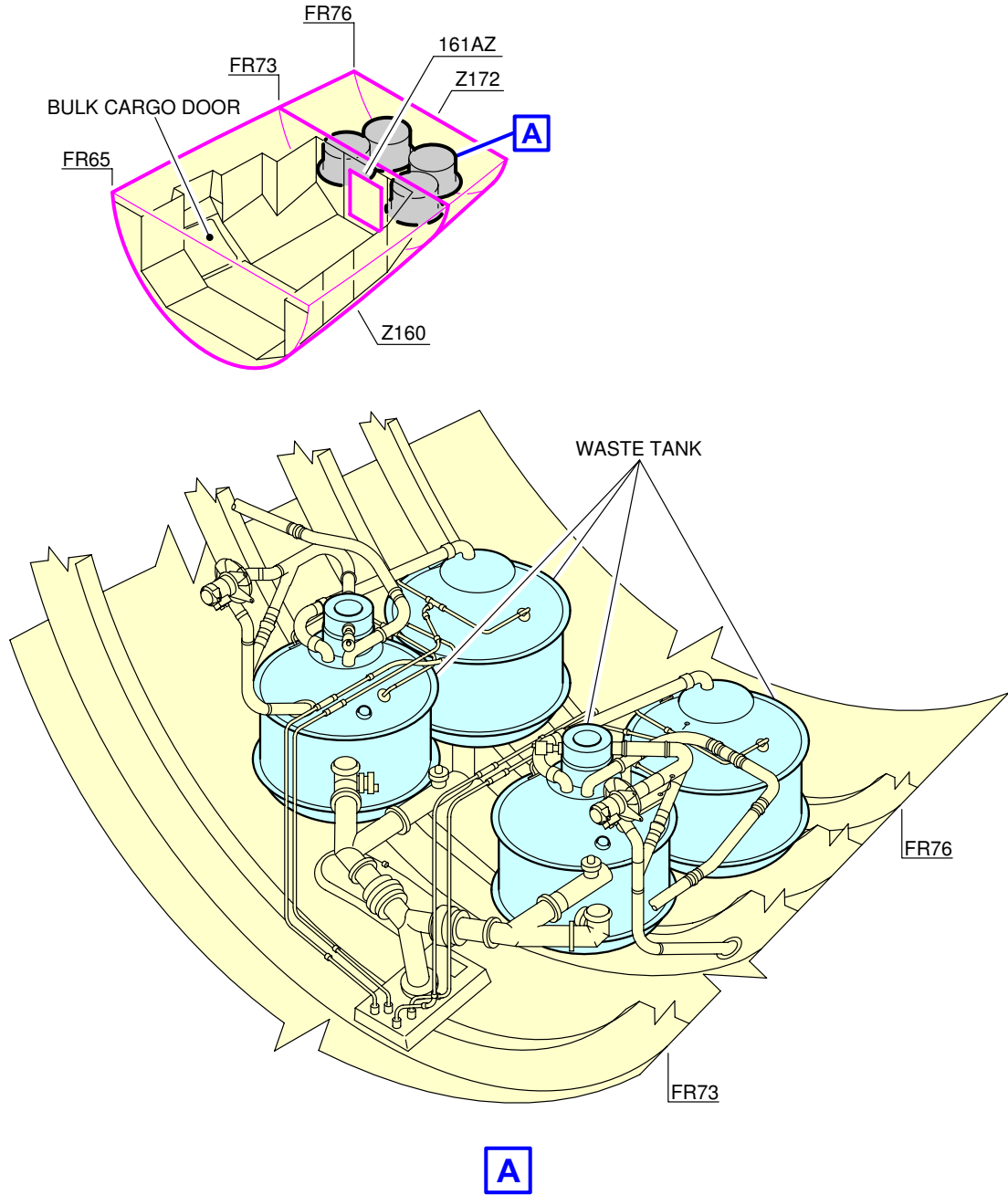

F_AC_050410_1_0070101_01_00

Ground Service Connections
Waste Tanks Location
FIGURE-5-4-10-991-007-A01

5-4-11 Cargo Control Panels

****ON A/C A340-500 A340-600**

Cargo Control Panels

****ON A/C A340-600**

1. Cargo Control Panels

ACCESS	DISTANCE			
	AFT OF NOSE	FROM AIRCRAFT CENTERLINE		MEAN HEIGHT FROM GROUND
		LH SIDE	RH SIDE	
FWD CLS* Panel: Access Door 122DR	14.17 m (46.49 ft)		2.60 m (8.53 ft)	3.10 m (10.17 ft)
FWD Cargo Door Panel: Access Door 122CR	13.87 m (45.51 ft)		2.40 m (7.87 ft)	3.50 m (11.48 ft)
AFT CLS* Panel: Access Door 152MR	59.60 m (195.54 ft)		2.60 m (8.53 ft)	4.70 m (15.42 ft)
AFT Cargo Door Panel: Access Door 152NR	59.20 m (194.23 ft)		2.40 m (7.87 ft)	4.10 m (13.45 ft)

NOTE : * CLS - CARGO LOADING SYSTEMS

****ON A/C A340-500**

2. Cargo Control Panels

ACCESS	DISTANCE			
	AFT OF NOSE	FROM AIRCRAFT CENTERLINE		MEAN HEIGHT FROM GROUND
		LH SIDE	RH SIDE	
FWD CLS* Panel: Access Door 122DR	14.17 m (46.49 ft)		2.60 m (8.53 ft)	3.10 m (10.17 ft)
FWD Cargo Door Panel: Access Door 122CR	13.87 m (45.51 ft)		2.40 m (7.87 ft)	3.50 m (11.48 ft)
AFT CLS* Panel: Access Door 152MR	51.94 m (170.41 ft)		2.60 m (8.53 ft)	4.70 m (15.42 ft)

A340-500/-600

AIRCRAFT CHARACTERISTICS - AIRPORT AND MAINTENANCE PLANNING

ACCESS	DISTANCE			
	AFT OF NOSE	FROM AIRCRAFT CENTERLINE		MEAN HEIGHT FROM GROUND
		LH SIDE	RH SIDE	
AFT Cargo Door Panel: Access Door 152NR	51.64 m (169.42 ft)		2.40 m (7.87 ft)	4.10 m (13.45 ft)

NOTE : * CLS - CARGO LOADING SYSTEMS

A340-500/-600

AIRCRAFT CHARACTERISTICS - AIRPORT AND MAINTENANCE PLANNING

****ON A/C A340-500 A340-600**

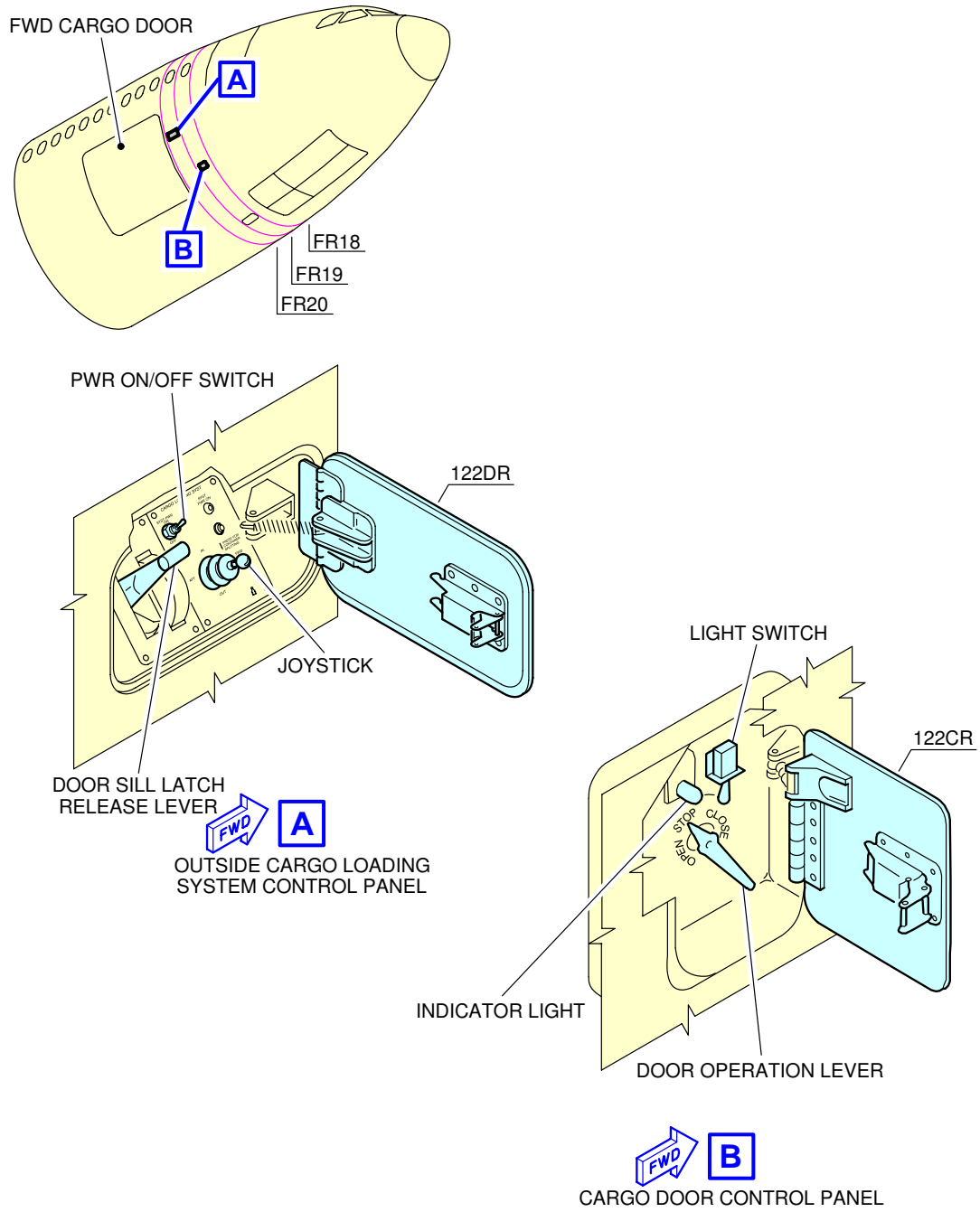

F_AC_050411_1_0060101_01_00

Forward Cargo Control Panels
FIGURE-5-4-11-991-006-A01

A340-500/-600

AIRCRAFT CHARACTERISTICS - AIRPORT AND MAINTENANCE PLANNING

**ON A/C A340-500 A340-600

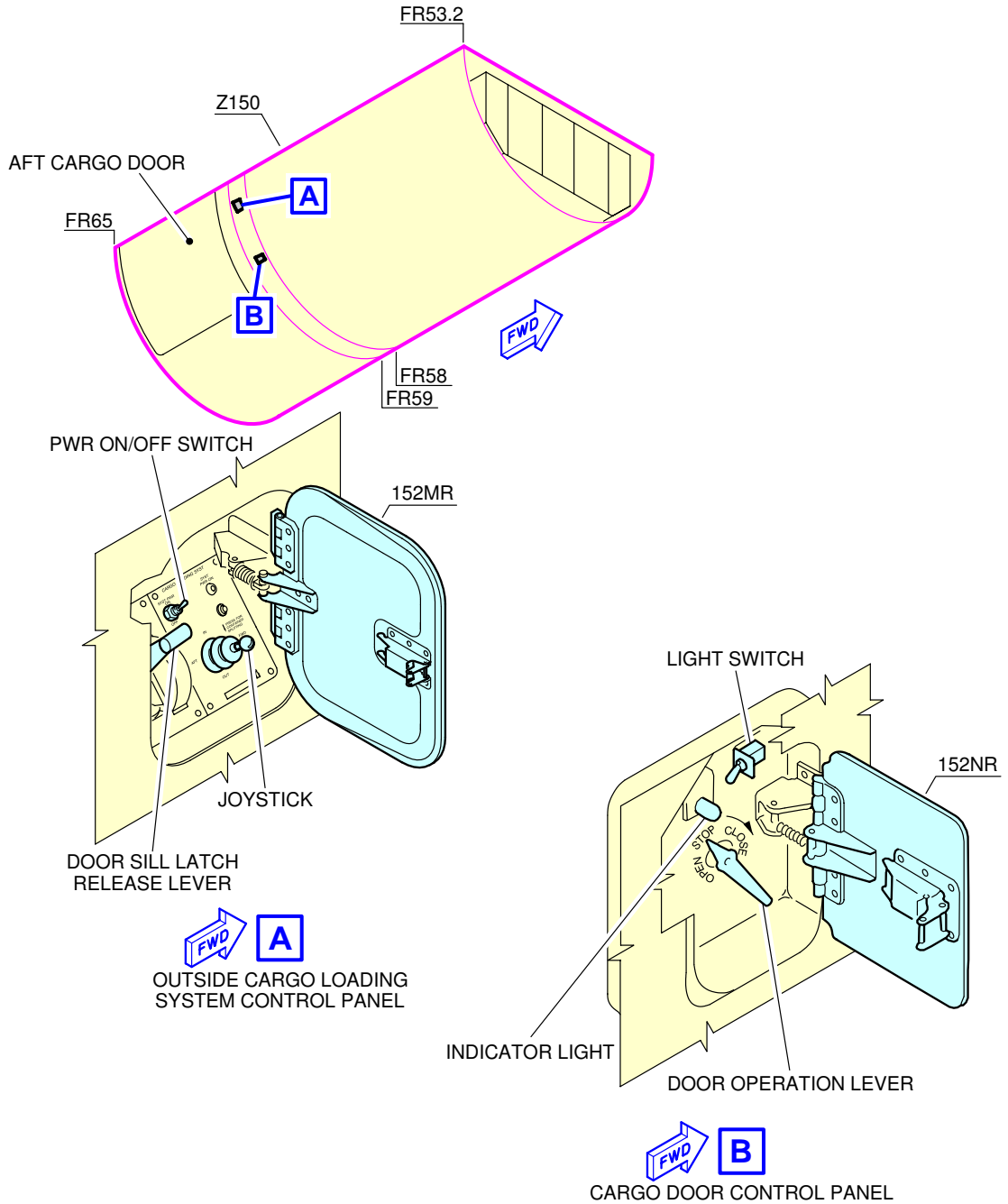

F_AC_050411_1_0070101_01_00

Aft Cargo Control Panels
FIGURE-5-4-11-991-007-A01

5-5-0 Engine Starting Pneumatic Requirements

****ON A/C A340-500 A340-600**

Engine Starting Pneumatic Requirements

1. Engine Starting Pneumatic Requirements.

To determinate the airflow required at ground connection, refer to the example given in FIGURE 5-5-0-991-003-A.

For engine starting pneumatic requirements for:

- Low ambient temperatures, refer to 05-05-01,
- Medium ambient temperatures, refer to 05-05-02,
- High ambient temperatures, refer to 05-05-03.

A340-500/-600

AIRCRAFT CHARACTERISTICS - AIRPORT AND MAINTENANCE PLANNING

**ON A/C A340-500 A340-600

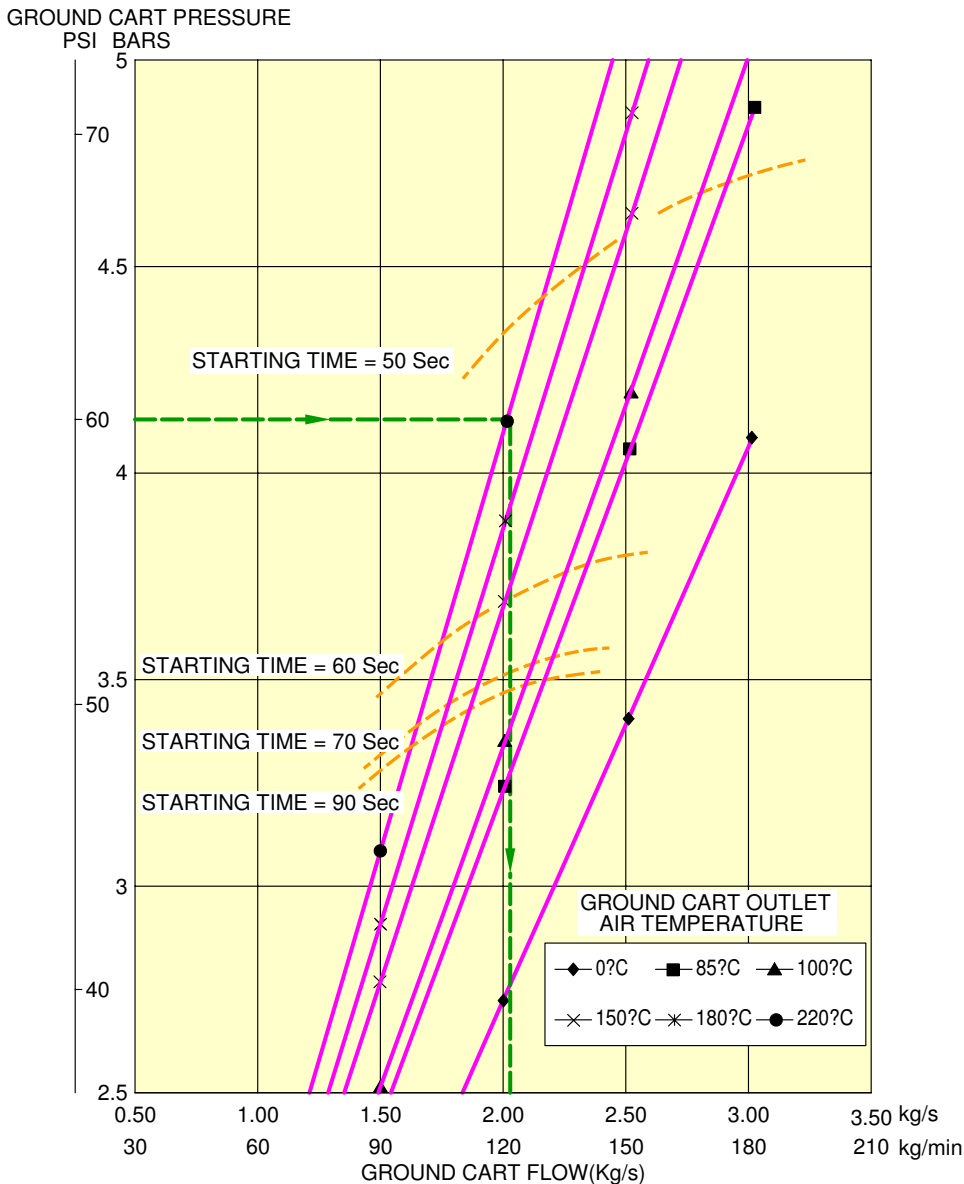

EXAMPLE TO DETERMINATE THE AIRFLOW REQUIRED AT THE FUSELAGE CONNECTION:
 -FOR AN AIR START UNIT DELIVERING 60 PSIA (4.14 BARS) AIR PRESSURE AT THE FUSELAGE CONNECTOR
 -AT A SUPPLIED AIR TEMPERATURE OF 220°C (428°F) AT THE FUSELAGE CONNECTOR

1. DRAW AN HORIZONTAL LINE FROM THE SUPPLIED AIR PRESSURE (60 PSIA (4.14 BARS)).
2. FROM THE INTERSECTION WITH THE AIR SUPPLY TEMPERATURE AT FUSELAGE CONNECTION (220°C (428°F)), DRAW A VERTICAL LINE.
3. THE INTERSECTION WITH THE HORIZONTAL AXIS GIVES THE REQUIRED AIRFLOW AT GROUND CONNECTION (125 kg/min (2.08 kg/s)).

F_AC_050500_1_0030101_01_00

Engine Starting Pneumatic Requirements
 FIGURE-5-5-0-991-003-A01

5-5-1 Low Ambient Temperatures****ON A/C A340-500 A340-600**Low Ambient Temperatures

1. This section provides the engine starting pneumatic requirements for a temperature of -40 °C (-40 °F).

A340-500/-600

AIRCRAFT CHARACTERISTICS - AIRPORT AND MAINTENANCE PLANNING

****ON A/C A340-500 A340-600**

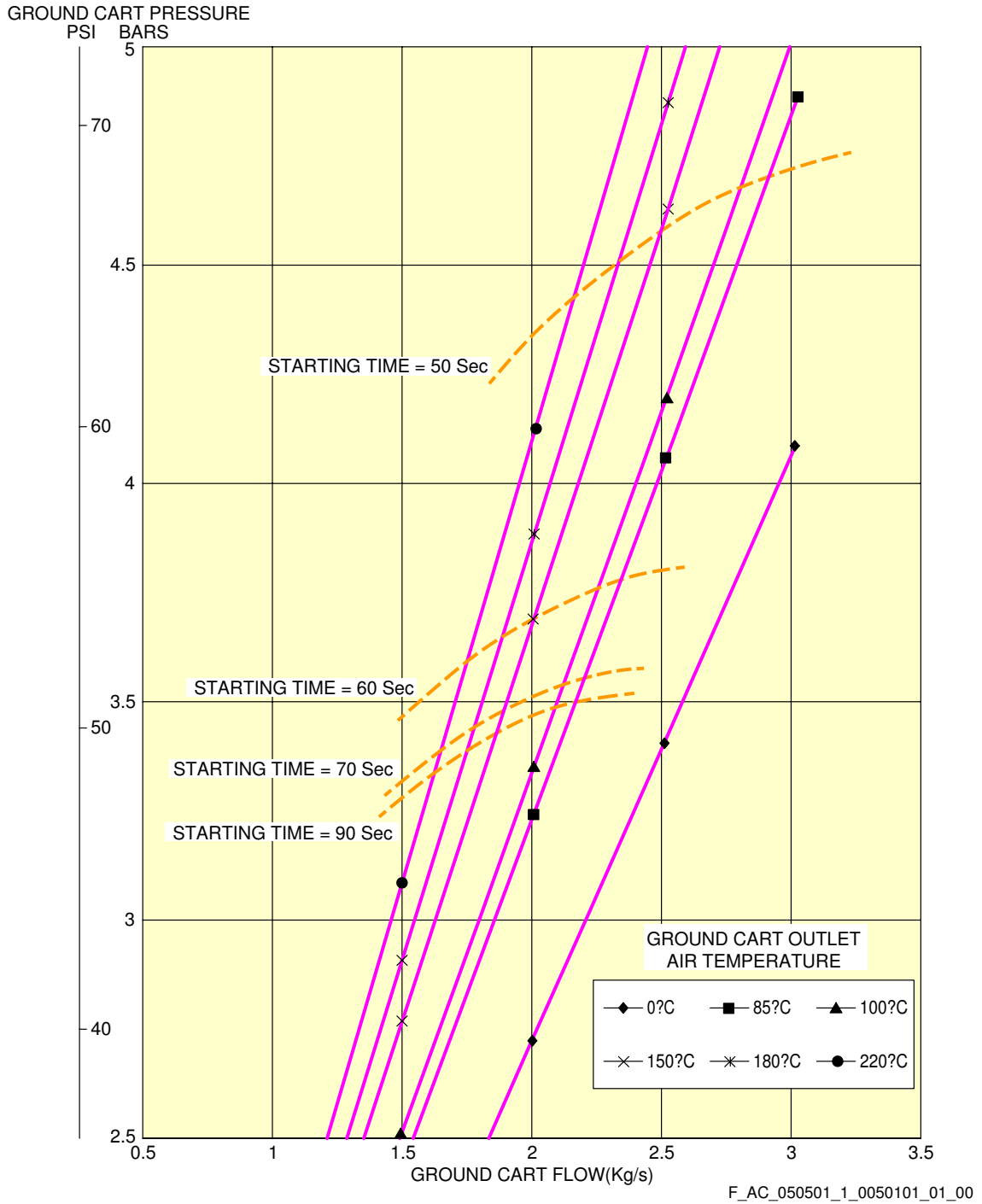

Engine Starting Pneumatic Requirements
 Low Ambient Temperature -40° C (-40° F) – RB 211 TRENT 500 series engine
 FIGURE-5-5-1-991-005-A01

5-5-2 Medium Ambient Temperatures****ON A/C A340-500 A340-600**Medium Ambient Temperatures

1. This section provides the engine starting pneumatic requirements for a temperature of +15 °C (+59 °F).

A340-500/-600

AIRCRAFT CHARACTERISTICS - AIRPORT AND MAINTENANCE PLANNING

****ON A/C A340-500 A340-600**

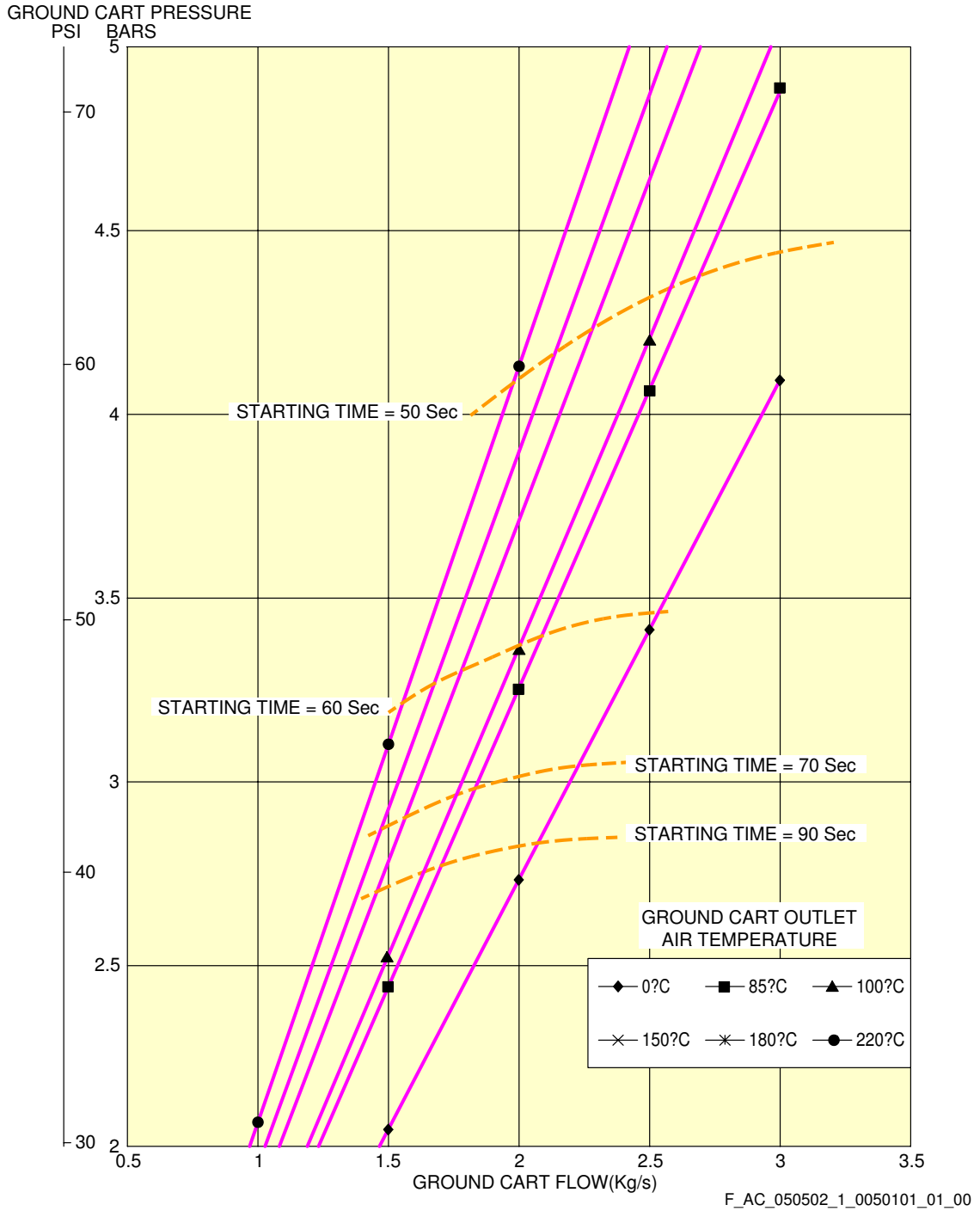

Engine Starting Pneumatic Requirements
 Medium Ambient Temperature +15 °C (+59 °F) – RB 211 TRENT 500 series engine
 FIGURE-5-5-2-991-005-A01

5-5-3 High Ambient Temperatures

****ON A/C A340-500 A340-600**

High Ambient Temperatures

1. This section provides the engine starting pneumatic requirements for a temperature upper +50 °C (+122 ° F).

A340-500/-600

AIRCRAFT CHARACTERISTICS - AIRPORT AND MAINTENANCE PLANNING

**ON A/C A340-500 A340-600

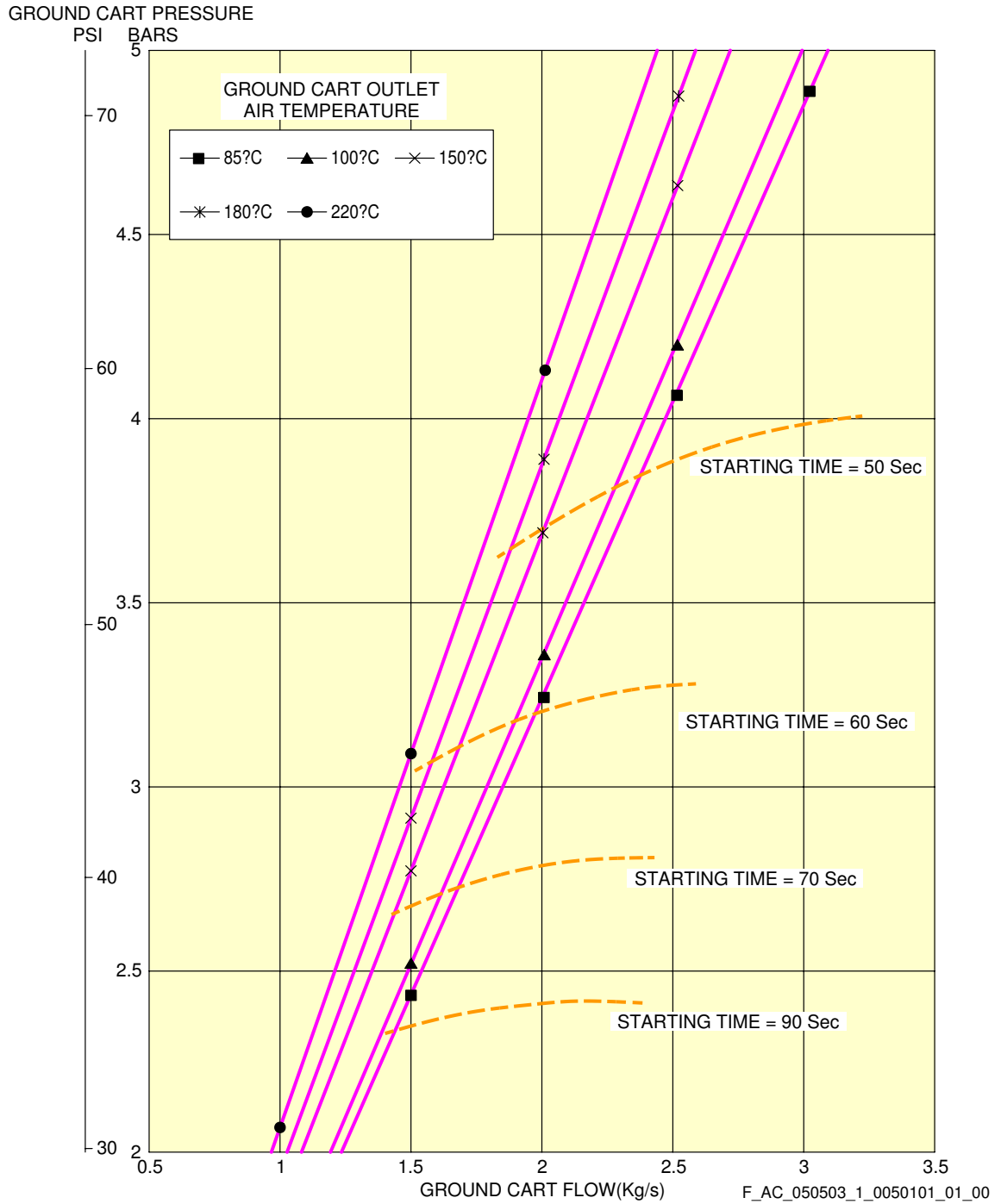

Engine Starting Pneumatic Requirements
 High Ambient Temperature +50 °C (+122 °F) – RB 211 TRENT 500 series engine
 FIGURE-5-5-3-991-005-A01

5-6-0 Ground Pneumatic Power Requirements

****ON A/C A340-500 A340-600**

Ground Pneumatic Power Requirements

1. General

This section describes the required performance for the ground equipment to maintain the cabin temperature at 27 °C (80.6 °F) for the cooling or 21 °C (69.8 °F) for heating cases after boarding (Section 5.7 - steady state), and provides the time needed to cool down or heat up the aircraft cabin to the required temperature (Section 5.6 - dynamic cases with aircraft empty).

ABBREVIATION	DEFINITION
A/C	Aircraft
AHM	Aircraft Handling Manual
GC	Ground Connection
GSE	Ground Service Equipment
IFE	In-Flight Entertainment
LP	Low Pressure
LPGC	Low Pressure Ground Connection
OAT	Outside Air Temperature
PCA	Pre-Conditioned Air

- A. The air flow rates and temperature requirements for the GSE, provided in Sections 5.6 and 5.7, are given at A/C ground connection.

NOTE : The cooling capacity of the equipment (kW) is only indicative and is not sufficient by itself to ensure the performance (outlet temperature and flow rate combinations are the requirements needed for ground power).

An example of cooling capacity calculation is given in Section 5.7.

- B. The air flow rates and temperature requirements for the GSE are given for the A/C in the configuration "2 LP ducts connected".

NOTE : The maximum air flow is driven by pressure limitation at LPGC.

- C. For temperatures at ground connection below +2 °C (+35.6 °F) (Subfreezing), the ground equipment shall be compliant with the Airbus document "Subfreezing PCA Carts – Compliance Document for Suppliers" (contact Airbus to obtain this document) defining all the requirements with which Subfreezing Pre-Conditioning Air equipment must comply to allow its use on Airbus aircraft. These requirements are in addition to the functional specifications included in the IATA AHM997.

2. Ground Pneumatic Power Requirements

This section provides the ground pneumatic power requirements for:

- Heating (pull up) the cabin, initially at OAT, up to 21 °C (69.8 °F) (see FIGURE 5-6-0-991-005-A)
- Cooling (pull down) the cabin, initially at OAT, down to 27 °C (80.6 °F) (see FIGURE 5-6-0-991-006-A).

A340-500/-600

AIRCRAFT CHARACTERISTICS - AIRPORT AND MAINTENANCE PLANNING

**ON A/C A340-500 A340-600

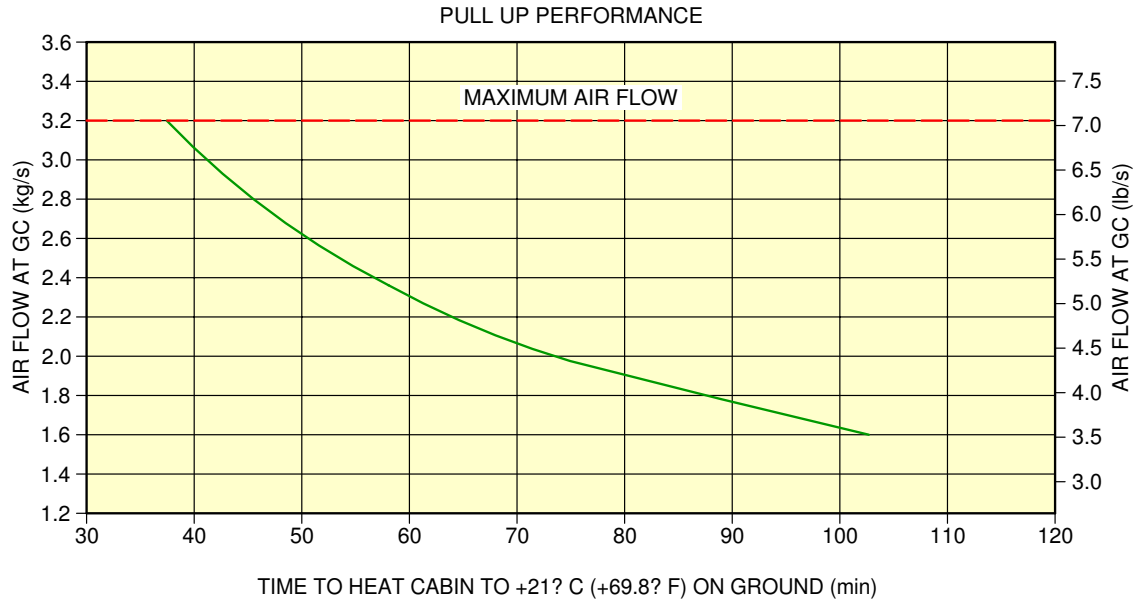

— OAT ISA -38°C (-36.4°F); GC INLET +70°C (+158°F); EMPTY CABIN; IFE OFF; NO SOLAR LOAD; LIGHTS ON; GALLEYS OFF; RECIRCULATION FANS ON

F_AC_050600_1_0050101_01_00

Ground Pneumatic Power Requirements
Heating
FIGURE-5-6-0-991-005-A01

A340-500/-600

AIRCRAFT CHARACTERISTICS - AIRPORT AND MAINTENANCE PLANNING

**ON A/C A340-500 A340-600

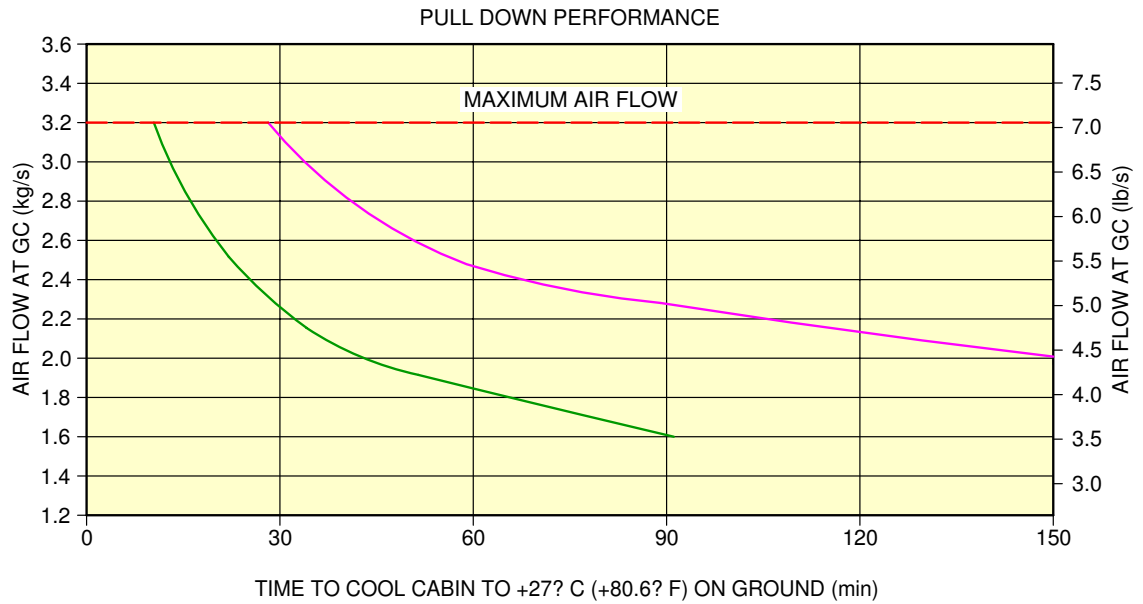

- OAT ISA +23° C (+73.4° F); GC INLET +2° C (+35.6° F); EMPTY CABIN; IFE OFF; NO SOLAR LOAD; LIGHTS ON; GALLEYS OFF; RECIRCULATION FANS ON
- OAT ISA +23° C (+73.4° F); GC INLET -10° C (+14° F); EMPTY CABIN; IFE OFF; NO SOLAR LOAD; LIGHTS ON; GALLEYS OFF; RECIRCULATION FANS ON

F_AC_050600_1_0060101_01_00

Ground Pneumatic Power Requirements
Cooling
FIGURE-5-6-0-991-006-A01

5-7-0 Preconditioned Airflow Requirements****ON A/C A340-500 A340-600**Preconditioned Airflow Requirements

1. This section provides the preconditioned airflow rate and temperature needed to maintain the cabin temperature at 24 °C (75.2 °F) for the cooling or 21 °C (69.8 °F) for the heating cases.

These settings are not intended to be used for operation (they are not a substitute for the settings given in the AMM). They are based on theoretical simulations and give the picture of a real steady state.

The purpose of the air conditioning (cooling) operation (described in the AMM) is to maintain the cabin temperature below 27 °C (80.6 °F) during boarding (therefore it is not a steady state).

A340-500/-600

AIRCRAFT CHARACTERISTICS - AIRPORT AND MAINTENANCE PLANNING

****ON A/C A340-500 A340-600**

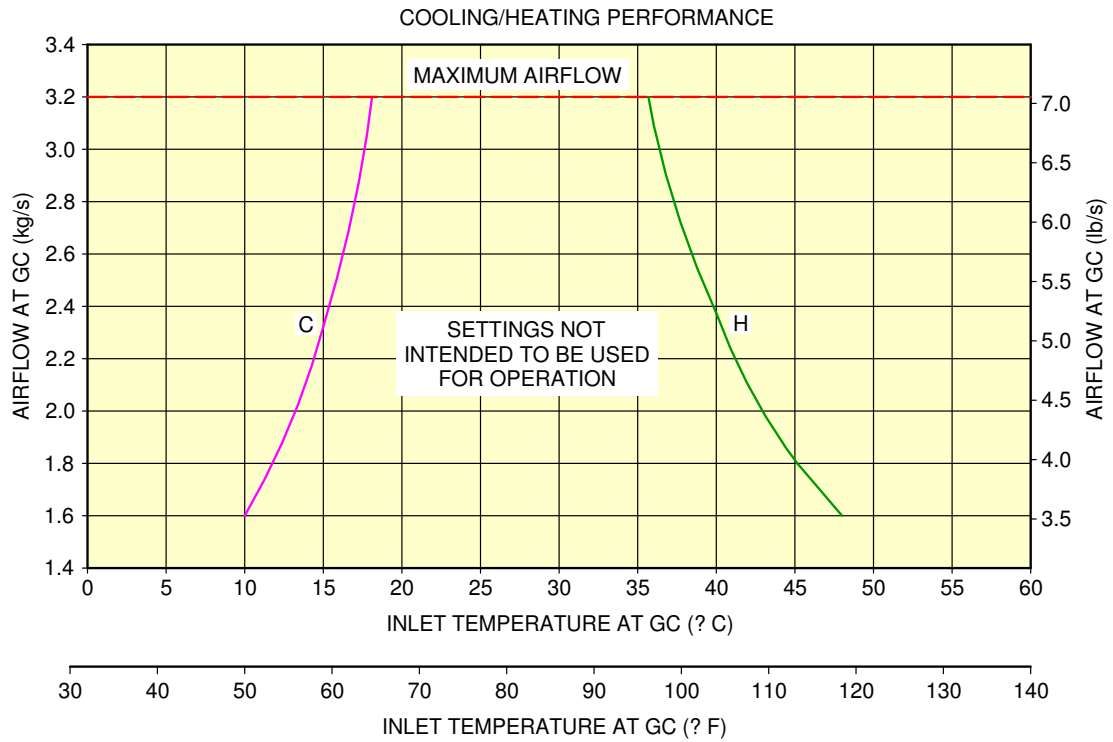

— OAT ISA; EMPTY CABIN; IFE ON; LIGHTS ON; NO SOLAR LOAD; RECIRCULATION FANS ON; GALLEYS ON
— OAT ISA -38° C (-36.4° F); EMPTY CABIN; IFE OFF; LIGHTS ON; NO SOLAR LOAD; RECIRCULATION FANS ON; GALLEYS OFF

EXAMPLE:

COOLING CAPACITY CALCULATION:
 FOR THE CONDITIONS "C", THE COOLING CAPACITY OF $1.6 \text{ kg/s} \times 1 \text{ kJ}/(\text{kg} \cdot \text{°C}) \times (24 - 10) = 22.4 \text{ kW}$
 (OR 6.7 TONS COOLING CAPACITY) IS NEEDED TO MAINTAIN THE CABIN TEMPERATURE AT 24° C (75.2° F)
 (1.6 kg/s AT 10° C (50° F) FOR AIR AT GC INLET).

F_AC_050700_1_0040101_01_01

Preconditioned Airflow Requirements
 FIGURE-5-7-0-991-004-A01

5-8-0 Ground Towing Requirements

****ON A/C A340-500 A340-600**

Ground Towing Requirements

1. This section provides information on aircraft towing.

The A340-500/-600 is designed with means for conventional or towbarless towing.

Information/procedures can be found for both in chapter 9 of the Aircraft Maintenance Manual.

Status on towbarless towing equipment qualification can be found in ISI 09.11.00001.

It is possible to tow or push the aircraft, at maximum ramp weight with engines at zero or up to idle thrust, using a towbar attached to the NLG. One towbar fitting is installed at the front of the leg (optional towing fitting for towing from the rear of the NLG available).

The main landing gears have attachment points for towing or debogging (for details, refer ARM 07).

This section shows the chart to determine the drawbar pull and tow tractor mass requirements as a function of the following physical characteristics:

- Aircraft weight,
- Number of engines at idle,
- Slope.

The following chart is applicable to both A340-500 and -600 aircraft.

2. Towbar design guidelines

The aircraft towbar shall comply with the following standards:

- ISO 8267-1, "Aircraft - Towbar Attachment Fitting - Interface Requirements - Part 1: Main Line Aircraft",
- ISO 9667, "Aircraft Ground Support Equipment - Towbars",
- IATA Airport Handling Manual AHM 958, "Functional Specification for an Aircraft Towbar".

A conventional type towbar is required which should be equipped with a damping system (to protect the NLG against jerks) and with towing shear pins:

- A traction shear pin calibrated at 40 400 daN (90 823 lbf),
- A torsion pin calibrated at 4 800 m.daN (424 836 lbf.in).

The towing head is designed according to ISO 8267-1, cat. IV.

A340-500/-600

AIRCRAFT CHARACTERISTICS - AIRPORT AND MAINTENANCE PLANNING

**ON A/C A340-500 A340-600

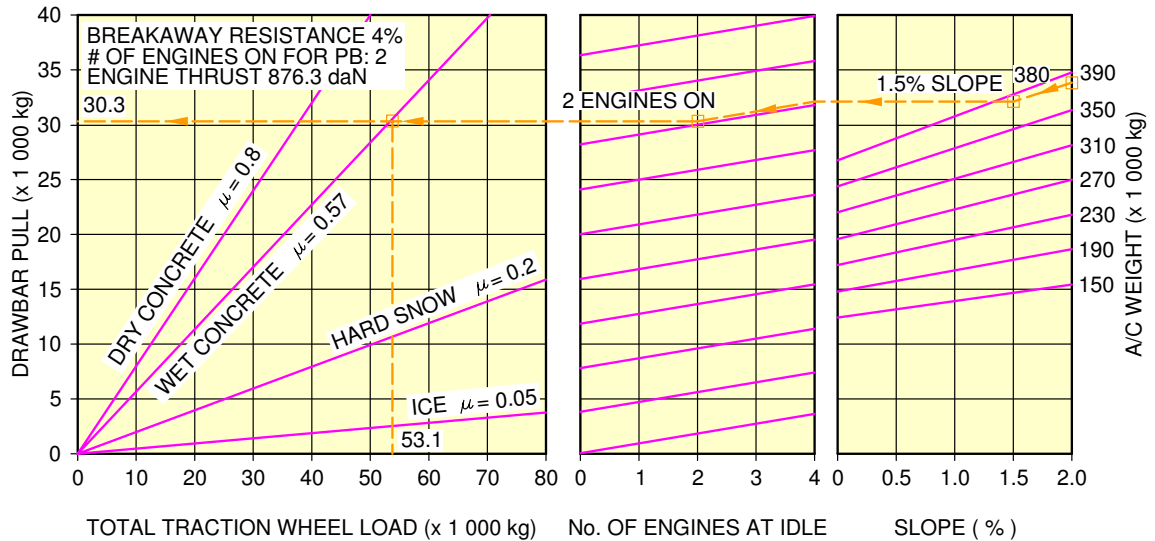

EXAMPLE HOW TO DETERMINE THE MASS REQUIREMENT TO TOW A A340-500 OR -600 AT 380 000 kg, AT 1.5% SLOPE, 2 ENGINES AT IDLE AND FOR WET TARMAC CONDITIONS:

- ON THE RIGHT HAND SIDE OF THE GRAPH, CHOOSE THE RELEVANT AIRCRAFT WEIGHT (380 000 kg),
- FROM THIS POINT DRAW A PARALLEL LINE TO THE REQUIRED SLOPE PERCENTAGE (1.5%),
- FROM THE POINT OBTAINED DRAW A STRAIGHT HORIZONTAL LINE UNTIL No. OF ENGINES AT IDLE = 4,
- FROM THIS POINT DRAW A PARALLEL LINE TO THE REQUESTED No. OF ENGINES (2),
- FROM THIS POINT DRAW A STRAIGHT HORIZONTAL LINE TO THE DRAWBAR PULL AXIS,
- THE Y-COORDINATE OBTAINED IS THE NECESSARY DRAWBAR PULL FOR THE TRACTOR (30 300 kg),
- SEARCH THE INTERSECTION WITH THE "WET CONCRETE" LINE.
- THE OBTAINED X-COORDINATE IS THE RECOMMENDED MINIMUM TRACTOR WEIGHT (53 100 kg).

F_AC_050800_1_0100101_01_01

Ground Towing Requirements
FIGURE-5-8-0-991-010-A01

5-9-0 De-Icing and External Cleaning

****ON A/C A340-500 A340-600**

De-Icing and External Cleaning

1. De-Icing and External Cleaning on Ground

The mobile equipment for aircraft de-icing and external cleaning must be capable of reaching heights up to approximately 17 m (56 ft).

2. De-Icing

AIRCRAFT TYPE	Wing Top Surface (Both Sides)	Wingtip Devices (Both Inside and Outside Surfaces) (Both Sides)	HTP Top Surface (Both Sides)	VTP (Both Sides)
A340-500	373 m ² (4 015 ft ²)	11 m ² (118 ft ²)	90 m ² (969 ft ²)	103 m ² (1 109 ft ²)
A340-600	373 m ² (4 015 ft ²)	11 m ² (118 ft ²)	90 m ² (969 ft ²)	103 m ² (1 109 ft ²)

AIRCRAFT TYPE	Fuselage Top Surface (Top Third - 120° Arc)	Nacelle and Pylon (Top Third - 120° Arc) (All Engines)	Total De-Iced Area
A340-500	338 m ² (3 638 ft ²)	83 m ² (893 ft ²)	998 m ² (10 742 ft ²)
A340-600	382 m ² (4 112 ft ²)	83 m ² (893 ft ²)	1 042 m ² (11 216 ft ²)

NOTE : Dimensions are approximate.

3. External Cleaning

AIRCRAFT TYPE	Wing Top Surface (Both Sides)	Wing Lower Surface (Including Flap Track Fairing) (Both Sides)	Wingtip Devices (Both Inside and Outside Surfaces) (Both Sides)	HTP Top Surface (Both Sides)	HTP Lower Surface (Both Sides)
A340-500	373 m ² (4 015 ft ²)	412 m ² (4 435 ft ²)	11 m ² (118 ft ²)	90 m ² (969 ft ²)	90 m ² (969 ft ²)
A340-600	373 m ² (4 015 ft ²)	412 m ² (4 435 ft ²)	11 m ² (118 ft ²)	90 m ² (969 ft ²)	90 m ² (969 ft ²)

A340-500/-600

AIRCRAFT CHARACTERISTICS - AIRPORT AND MAINTENANCE PLANNING

AIRCRAFT TYPE	VTP (Both Sides)	Fuselage and Belly Fairing	Nacelle and Pylon (All Engines)	Total Cleaned Area
A340-500	103 m ² (1 109 ft ²)	1 024 m ² (11 022 ft ²)	244 m ² (2 626 ft ²)	2 363 m ² (25 435 ft ²)
A340-600	103 m ² (1 109 ft ²)	1 156 m ² (12 443 ft ²)	244 m ² (2 626 ft ²)	2 494 m ² (26 845 ft ²)

NOTE : Dimensions are approximate.

OPERATING CONDITIONS**6-1-0 Engine Exhaust Velocities and Temperatures******ON A/C A340-500 A340-600**Engine Exhaust Velocities and Temperatures

1. General

This section shows the estimated engine exhaust efflux velocities and temperatures contours for Ground Idle, Breakaway and Maximum Takeoff conditions.

6-1-1 Engine Exhaust Velocities Contours - Ground Idle Power

****ON A/C A340-500 A340-600**

Engine Exhaust Velocities Contours - Ground Idle Power

1. This section gives engine exhaust velocities contours at ground idle power.

A340-500/-600

AIRCRAFT CHARACTERISTICS - AIRPORT AND MAINTENANCE PLANNING

**ON A/C A340-500 A340-600

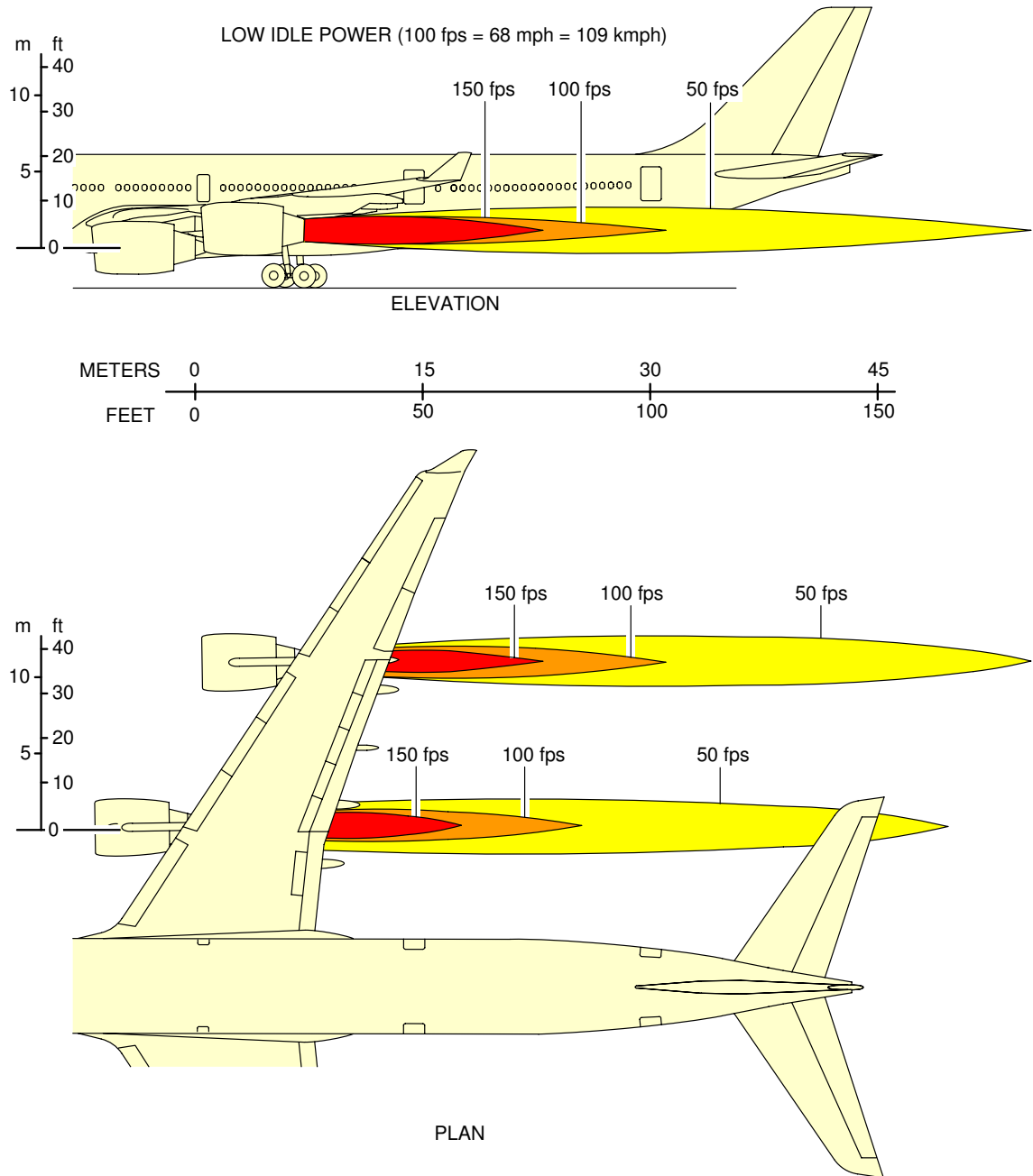

F_AC_060101_1_0050101_01_00

Engine Exhaust Velocities
Ground Idle Power - RR TRENT 500 series engine
FIGURE-6-1-1-991-005-A01

6-1-2 Engine Exhaust Temperatures Contours - Ground Idle Power

****ON A/C A340-500 A340-600**

Engine Exhaust Temperatures Contours - Ground Idle Power

1. This section gives engine exhaust temperatures contours at ground idle power.

A340-500/-600

AIRCRAFT CHARACTERISTICS - AIRPORT AND MAINTENANCE PLANNING

**ON A/C A340-500 A340-600

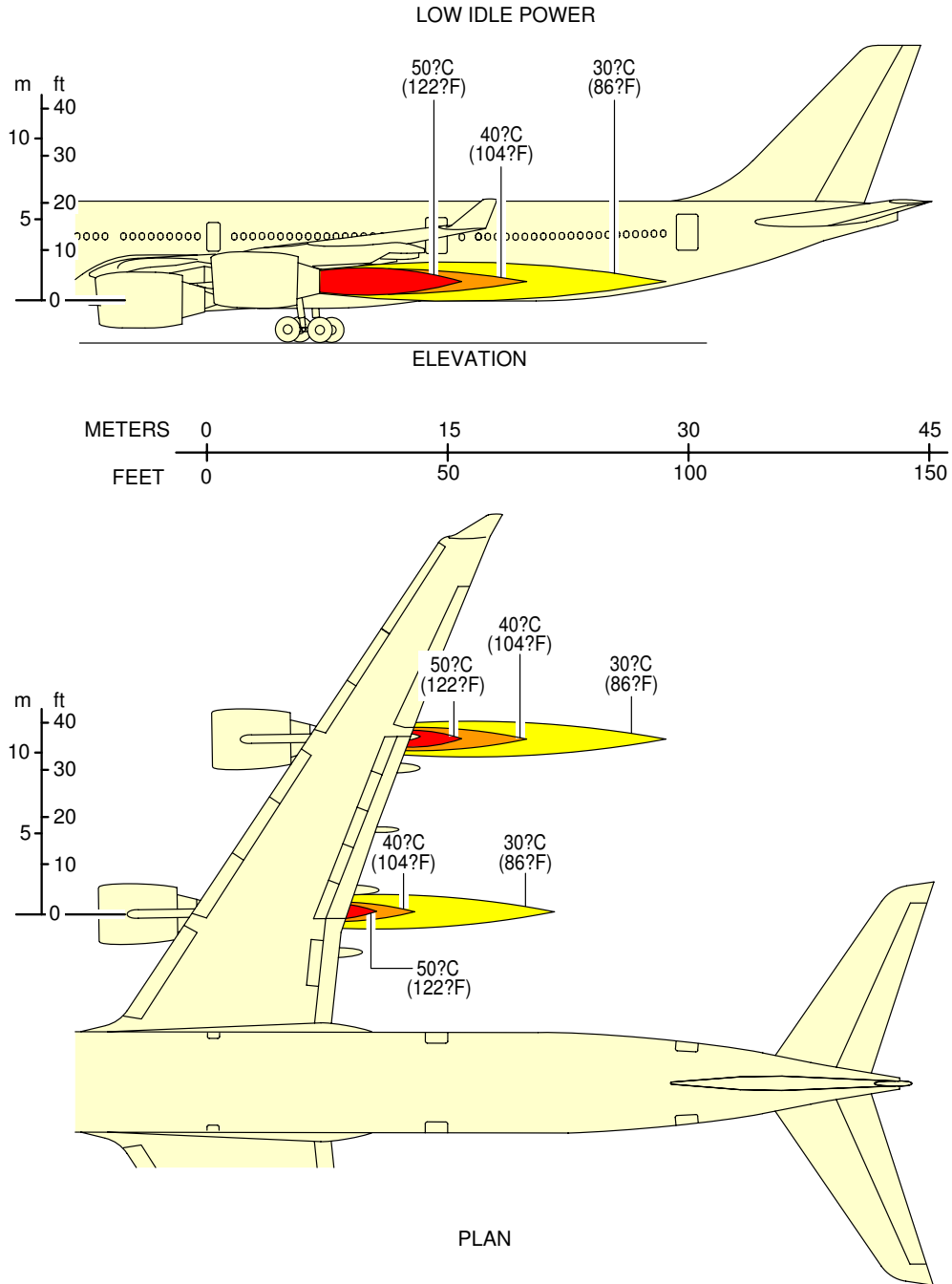

F_AC_060102_1_0050101_01_00

Engine Exhaust Temperatures
Ground Idle Power - RR TRENT 500 series engine
FIGURE-6-1-2-991-005-A01

6-1-3 Engine Exhaust Velocities Contours - Breakaway Power****ON A/C A340-500 A340-600**Engine Exhaust Velocities Contours - Breakaway Power

1. This section gives engine exhaust velocities contours at breakaway power.

A340-500/-600

AIRCRAFT CHARACTERISTICS - AIRPORT AND MAINTENANCE PLANNING

**ON A/C A340-500 A340-600

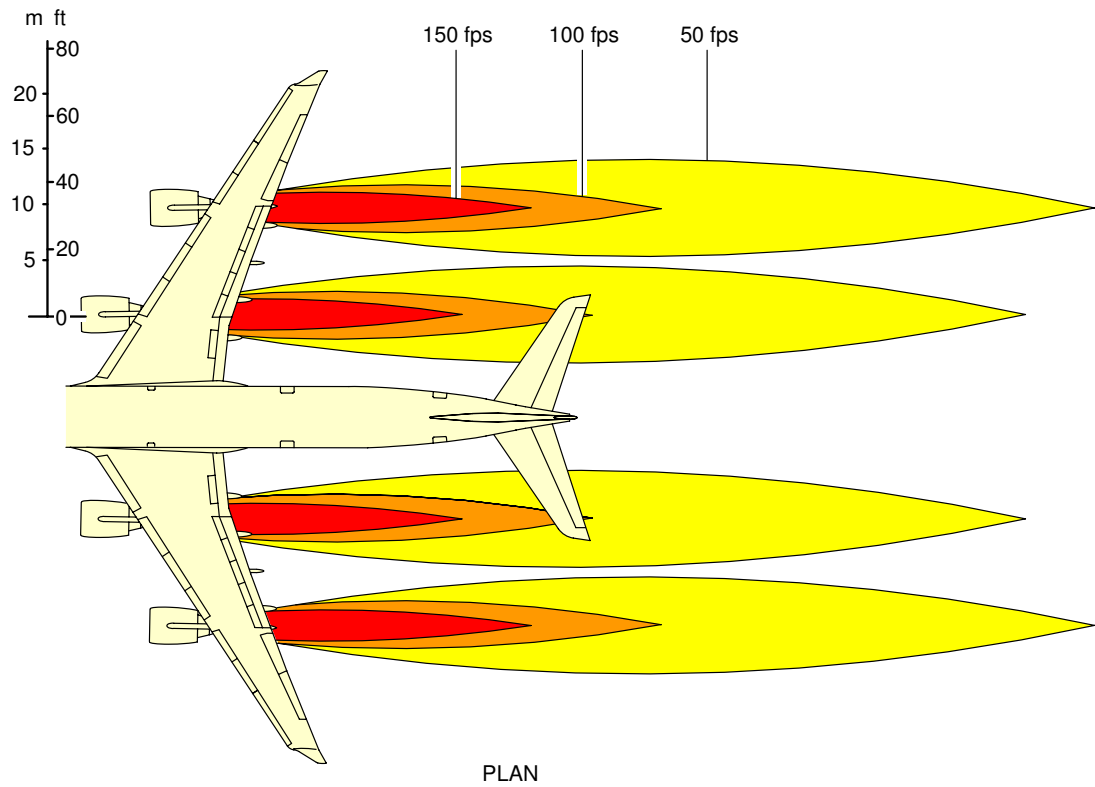
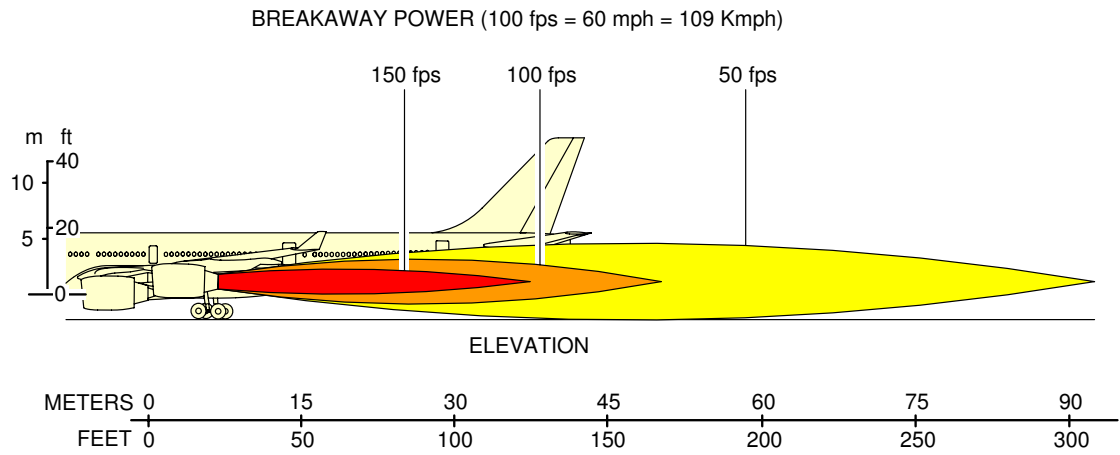

F_AC_060103_1_0050101_01_00

Engine Exhaust Velocities
Breakaway Power - RR TRENT 500 series engine
FIGURE-6-1-3-991-005-A01

6-1-4 Engine Exhaust Temperatures Contours - Breakaway Power****ON A/C A340-500 A340-600**Engine Exhaust Temperatures Contours - Breakaway Power

1. This section gives engine exhaust temperatures contours at breakaway power.

A340-500/-600

AIRCRAFT CHARACTERISTICS - AIRPORT AND MAINTENANCE PLANNING

**ON A/C A340-500 A340-600

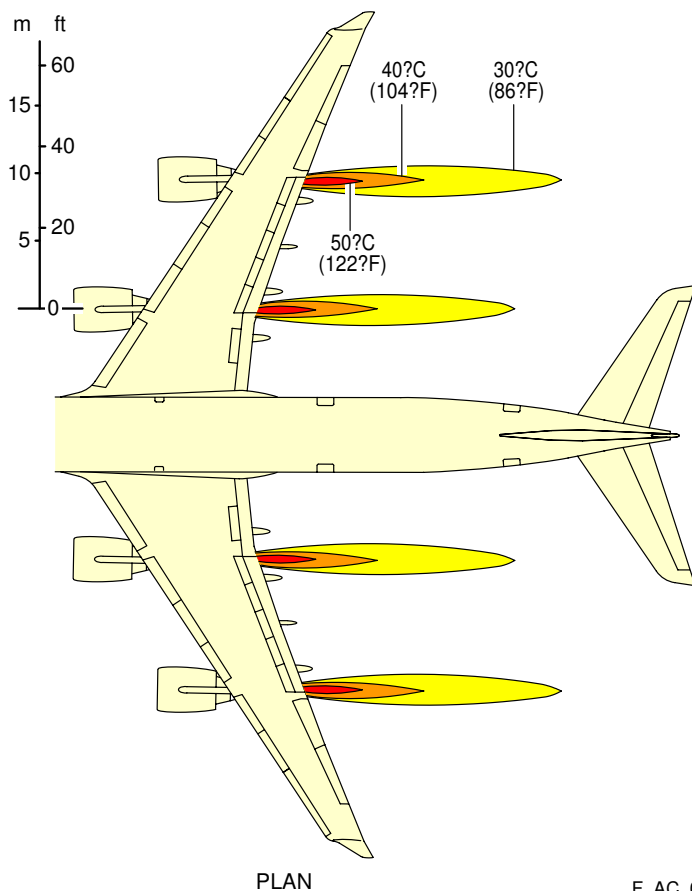
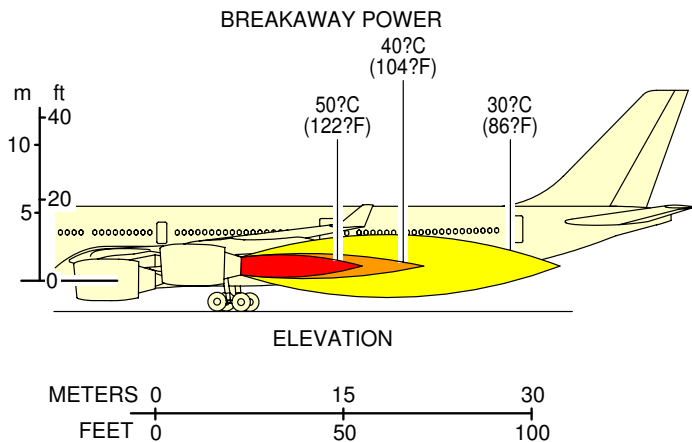

F_AC_060104_1_0050101_01_00

Engine Exhaust Temperatures
Breakaway Power - RR TRENT 500 series engine
FIGURE-6-1-4-991-005-A01

6-1-5 Engine Exhaust Velocities Contours - Takeoff Power****ON A/C A340-500 A340-600**Engine Exhaust Velocities Contours - Takeoff Power

1. This section gives engine exhaust velocities contours at takeoff power.

A340-500/-600

AIRCRAFT CHARACTERISTICS - AIRPORT AND MAINTENANCE PLANNING

**ON A/C A340-500 A340-600

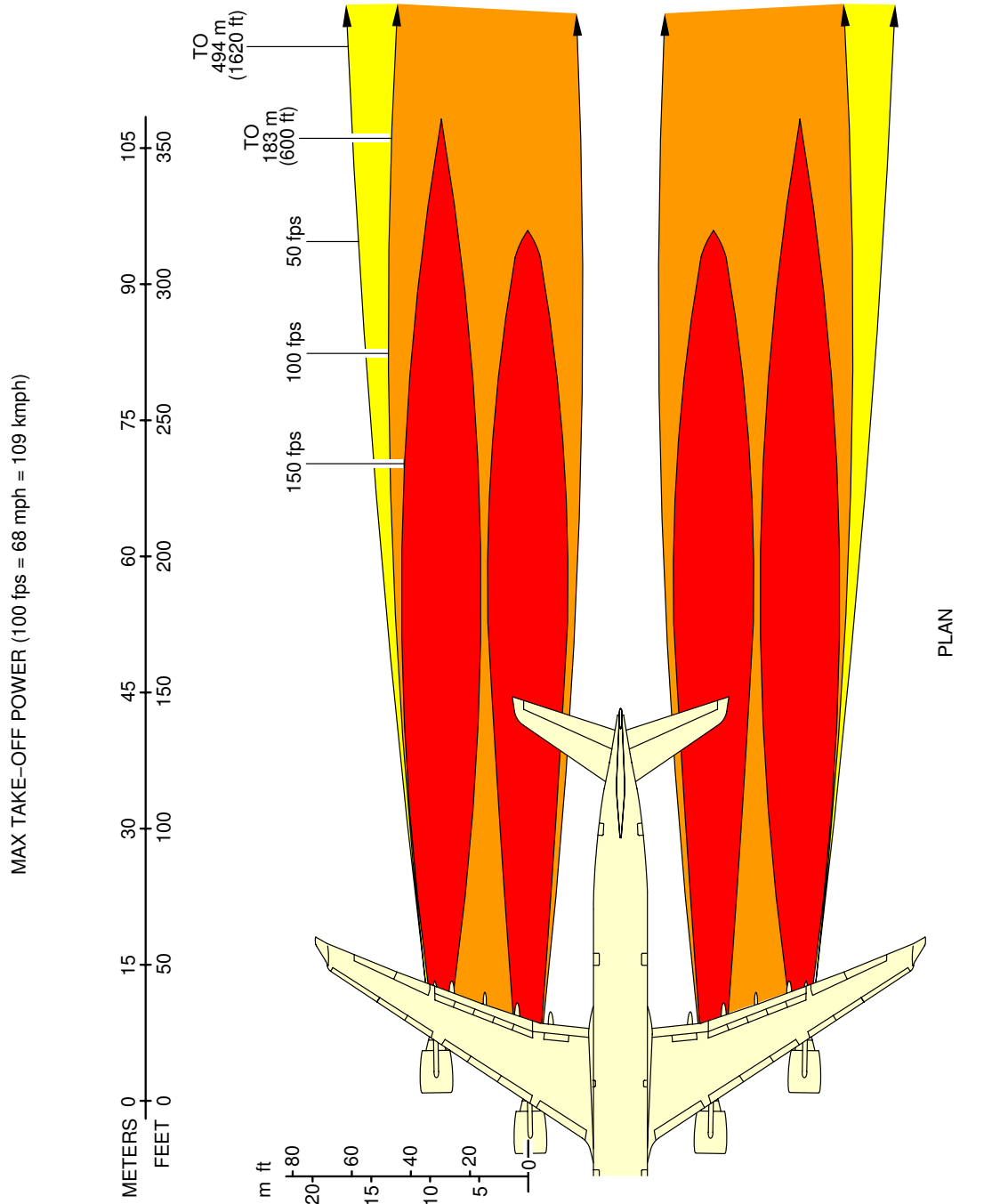

F_AC_060105_1_0050101_01_00

Engine Exhaust Velocities
 Takeoff Power - RR TRENT 500 series engine
 FIGURE-6-1-5-991-005-A01

6-1-6 Engine Exhaust Temperatures Contours - Takeoff Power****ON A/C A340-500 A340-600**Engine Exhaust Temperatures Contours - Takeoff Power

1. This section gives engine exhaust temperatures contours at takeoff power.

A340-500/-600

AIRCRAFT CHARACTERISTICS - AIRPORT AND MAINTENANCE PLANNING

**ON A/C A340-500 A340-600

MAX TAKE-OFF POWER

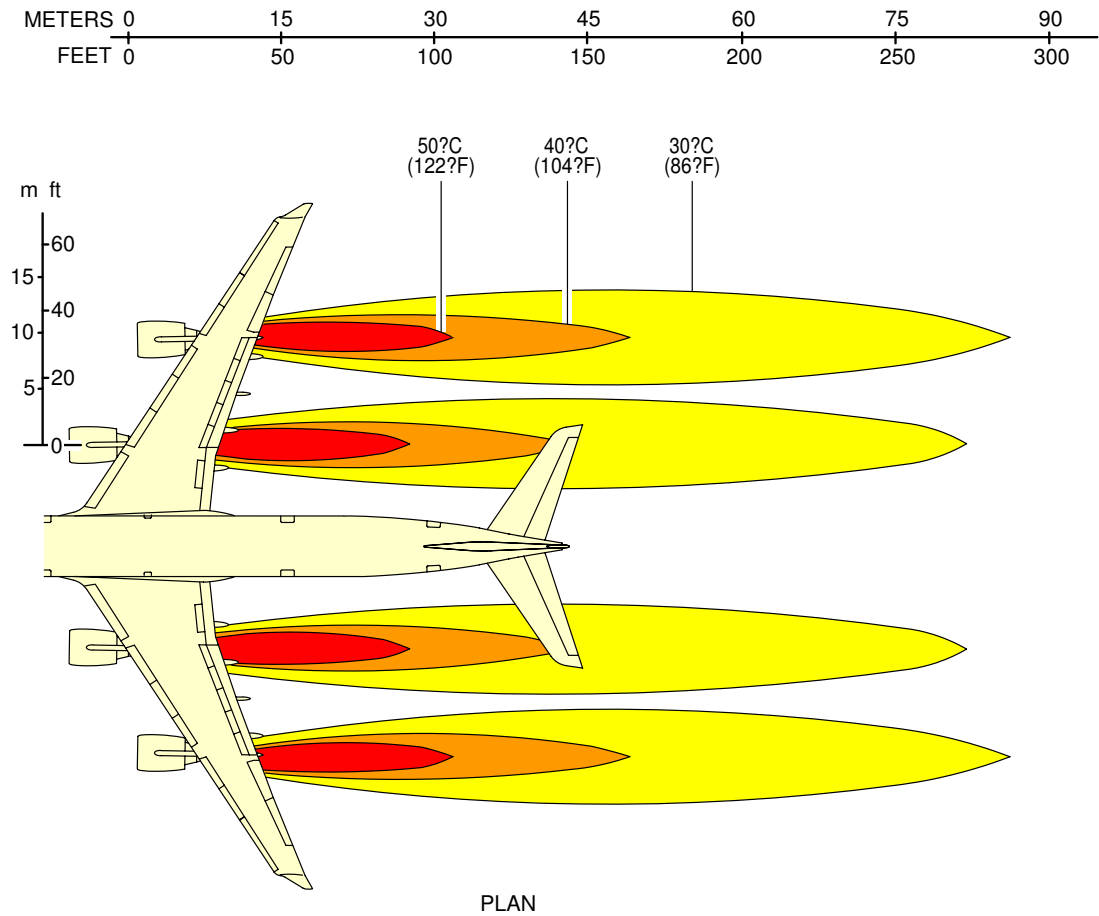

F_AC_060106_1_0050101_01_00

Engine Exhaust Temperatures
Takeoff Power - RR TRENT 500 series engine
FIGURE-6-1-6-991-005-A01

6-3-0 **Danger Areas of Engines******ON A/C A340-500 A340-600**Danger Areas of Engines

1. Danger Areas of the Engines.

NOTE : Areas with exhaust velocities of more than 56 km/h (35 mph, 50 ft/s or 15 m/s) are defined as areas where injury to persons and/or damage to machinery can occur.

6-3-1 Ground Idle Power****ON A/C A340-500 A340-600**Ground Idle Power



1. This section provides danger areas of the engines at ground idle power conditions

A340-500/-600

AIRCRAFT CHARACTERISTICS - AIRPORT AND MAINTENANCE PLANNING

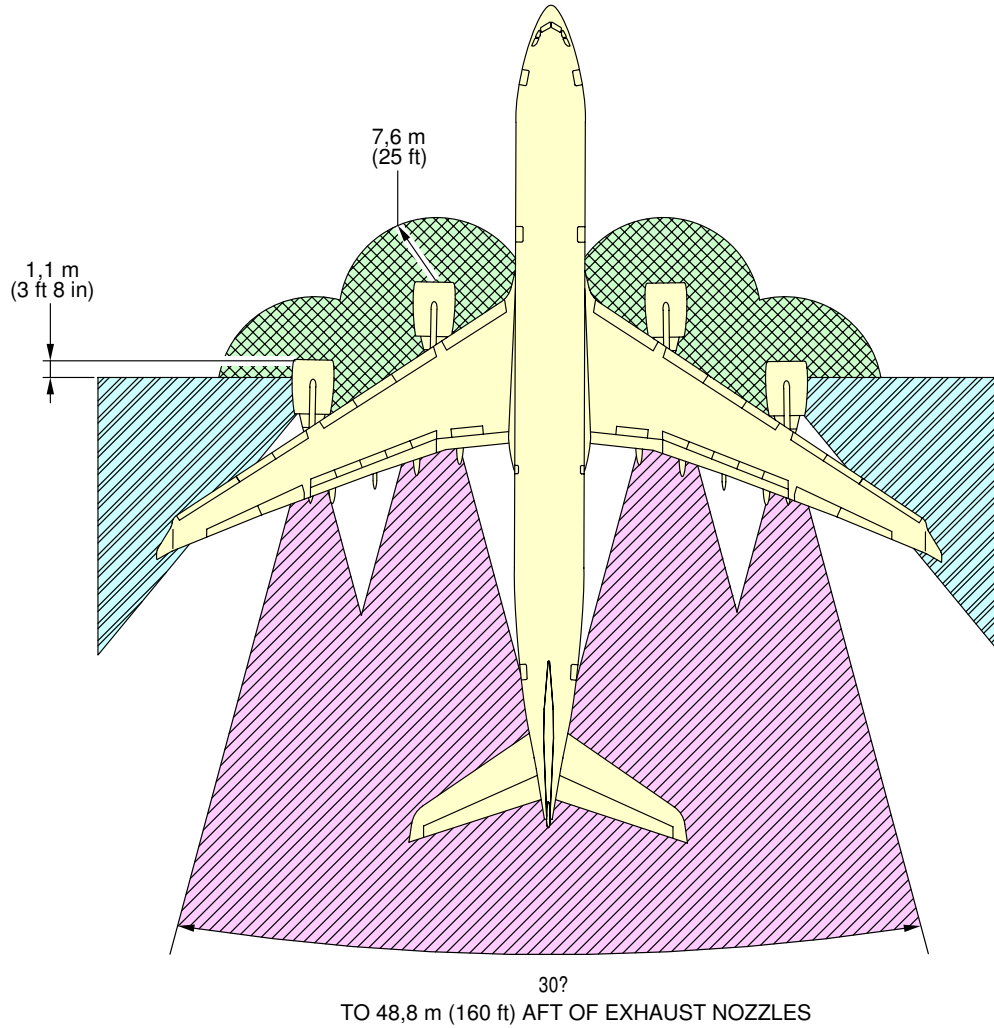
**ON A/C A340-500 A340-600



-  INTAKE SUCTION DANGER AREA MINIMUM IDLE POWER
-  EXHAUST DANGER AREA
-  ENTRY CORRIDOR

DEF0004201A

F_AC_060301_1_0050101_01_00

Danger Areas of Engines
RR TRENT 500 series engine
FIGURE-6-3-1-991-005-A01

6-3-2 Breakaway Power****ON A/C A340-500 A340-600**Breakaway Power



1. This section provides danger areas of the engines at breakaway conditions.

A340-500/-600

AIRCRAFT CHARACTERISTICS - AIRPORT AND MAINTENANCE PLANNING

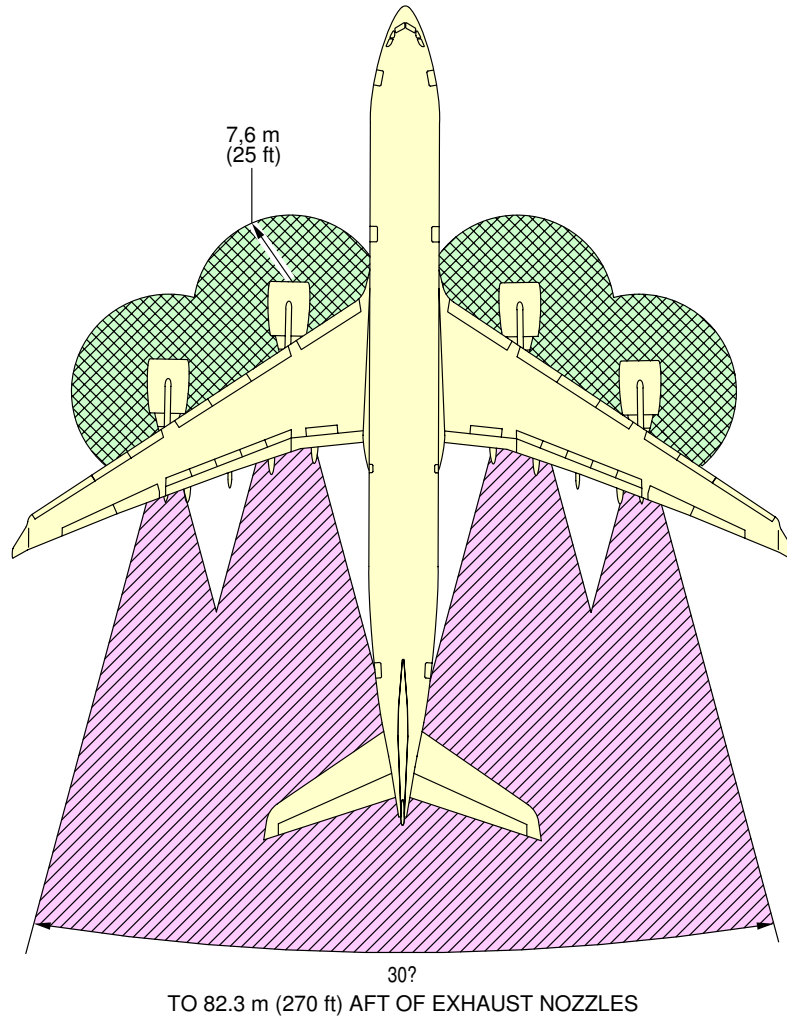
****ON A/C A340-500 A340-600**



-  INTAKE SUCTION DANGER AREA BREAKWAY POWER
-  EXHAUST DANGER AREA

F_AC_060302_1_0050101_01_00

Danger Areas of Engines
RR TRENT 500 series engine
FIGURE-6-3-2-991-005-A01

6-3-3 Takeoff Power****ON A/C A340-500 A340-600**Takeoff Power

1. This section provides danger areas of the engines at max takeoff conditions.



A340-500/-600

AIRCRAFT CHARACTERISTICS - AIRPORT AND MAINTENANCE PLANNING

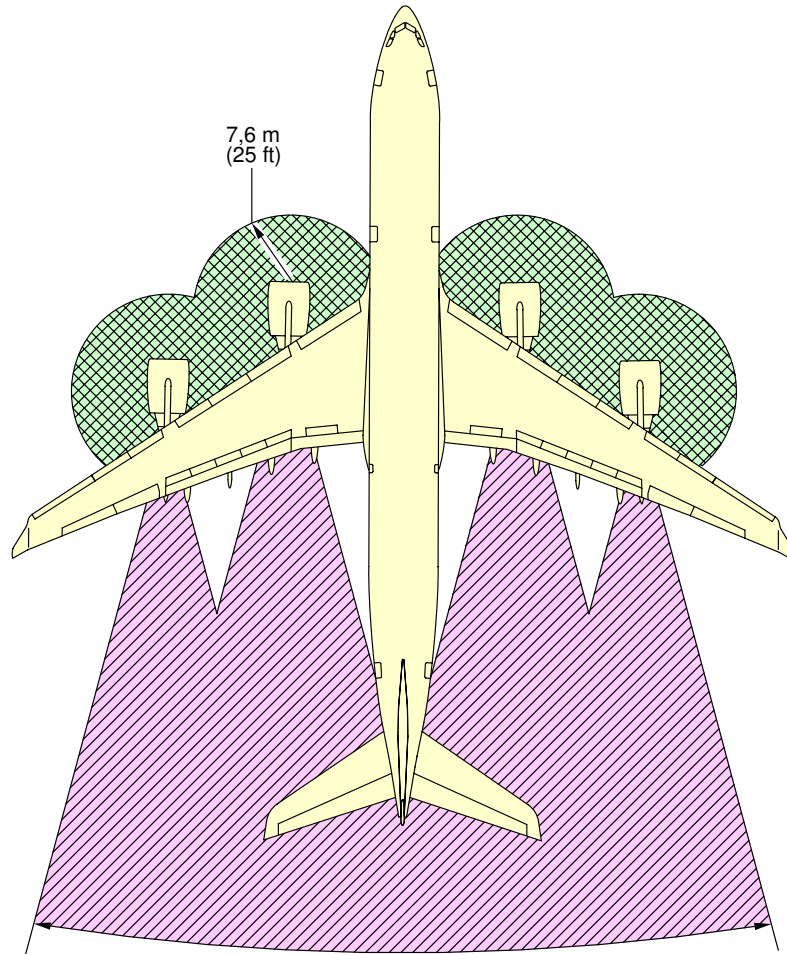
****ON A/C A340-500 A340-600**



30°
TO 490,7 m (1610 ft) AFT OF EXHAUST NOZZLES

-  INTAKE SUCTION DANGER AREA MAX TAKE-OFF
-  EXHAUST DANGER AREA

F_AC_060303_1_0050101_01_00

Danger Areas of Engines
RR TRENT 500 series engine
FIGURE-6-3-3-991-005-A01

6-4-0 APU Exhaust Velocities and Temperatures****ON A/C A340-500 A340-600**APU Exhaust Velocities and Temperatures

1. APU Exhaust Velocities and Temperatures.

A340-500/-600

AIRCRAFT CHARACTERISTICS - AIRPORT AND MAINTENANCE PLANNING

6-4-1 APU

****ON A/C A340-500 A340-600**

APU - GARRETT

1. This section gives APU exhaust velocities and temperatures.

A340-500/-600

AIRCRAFT CHARACTERISTICS - AIRPORT AND MAINTENANCE PLANNING

**ON A/C A340-500 A340-600

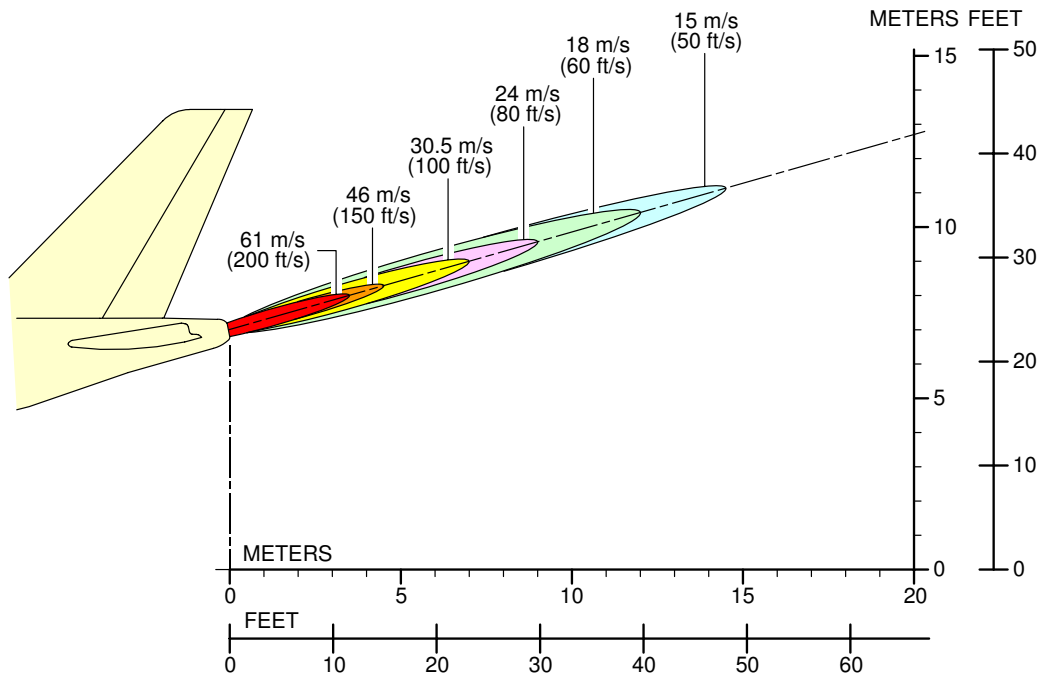
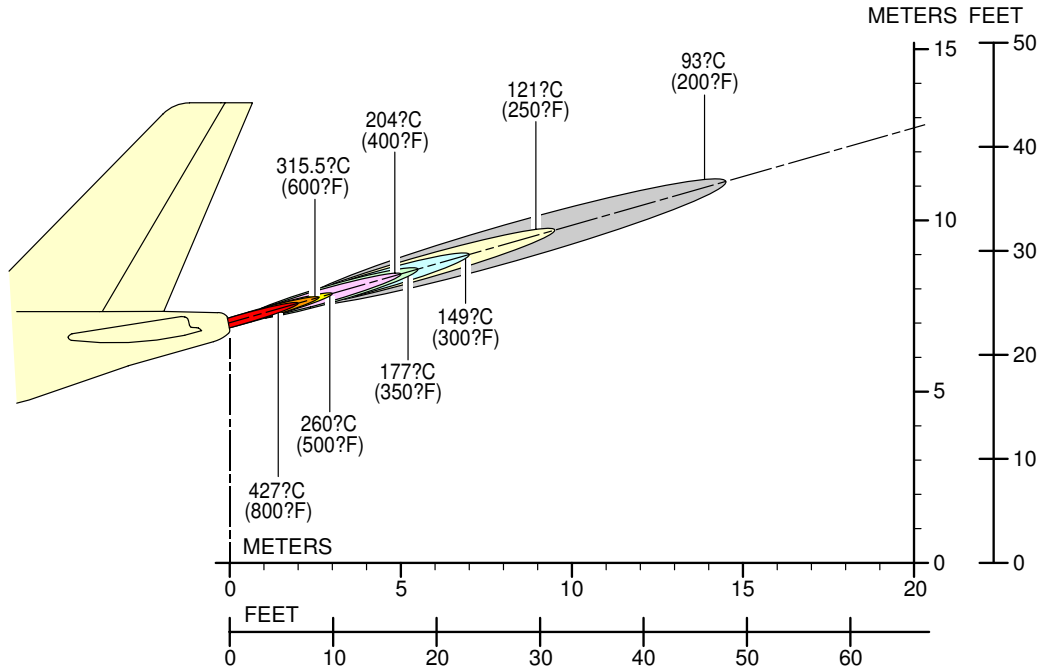

F_AC_060401_1_0030101_01_00

Exhaust Velocities and Temperatures
 GARRETT GTCP 331-600 (A)
 FIGURE-6-4-1-991-003-A01

PAVEMENT DATA

7-1-0 General Information

****ON A/C A340-500 A340-600**

General Information

1. A brief description of the pavement charts that follow will help in airport planning.

To aid in the interpolation between the discrete values shown, each aircraft configuration is shown with a minimum range of five loads on the Main Landing Gear (MLG).

All curves on the charts represent data at a constant specified tire pressure with:

- The aircraft loaded to the Maximum Ramp Weight (MRW),
- The CG at its maximum permissible aft position.

Pavement requirements for commercial aircraft are derived from the static analysis of loads imposed on the MLG struts.

Landing Gear Footprint:

Section 07-02-00 presents basic data on the landing gear footprint configuration, MRW and tire sizes and pressures.

Maximum Pavement Loads:

Section 07-03-00 shows maximum vertical and horizontal pavement loads for certain critical conditions at the tire-ground interfaces.

Landing Gear Loading on Pavement:

Section 07-04-00 contains charts to find these loads throughout the stability limits of the aircraft at rest on the pavement.

These MLG loads are used as the point of entry to the pavement design charts which follow, interpolating load values where necessary.

Flexible Pavement Requirements - US Army Corps of Engineers Design Method:

Section 07-05-00 uses procedures in Instruction Report No. S-77-1 "Procedures for Development of CBR Design Curves", dated June 1977 and as modified according to the methods described in ICAO Aerodrome Design Manual, Part 3. Pavements, 2nd Edition, 1983, Section 1.1 (The ACN-PCN Method), and utilizing the alpha factors approved by ICAO in October 2007.

The report was prepared by the "U.S. Army Corps Engineers Waterways Experiment Station, Soils and Pavement Laboratory, Vicksburg, Mississippi".

The line showing 10 000 coverages is used to calculate the Aircraft Classification Number (ACN).

Flexible Pavement Requirements - LCN Conversion Method:

The Load Classification Number (LCN) curves are no longer provided in section 07-06-00 since the LCN system for reporting pavement strength is obsolete, having been replaced by the ICAO recommended ACN/PCN system in 1983. For questions regarding the LCN system, contact Airbus.

Rigid Pavement Requirements - PCA (Portland Cement Association) Design Method:
Section 07-07-00 gives the rigid pavement design curves that have been prepared with the use of the Westergaard Equation.

This is in general accordance with the procedures outlined in the Portland Cement Association publications, "Design of Concrete Airport Pavement", 1973 and "Computer Program for Airport Pavement Design" (Program PDILB), 1967 both by Robert G. Packard.

Rigid Pavement Requirements - LCN Conversion:

The Load Classification Number (LCN) curves are no longer provided in section 07-08-00 since the LCN system for reporting pavement strength is obsolete, having been replaced by the ICAO recommended ACN/PCN system in 1983. For questions regarding the LCN system, contact Airbus.

ACN/PCN Reporting System:

Section 07-09-00 provides ACN data prepared according to the ACN/PCN system as referenced in ICAO Annex 14, "Aerodromes", Volume 1 "Aerodrome Design and Operations" Fourth Edition, July 2004, incorporating Amendments 1 to 6.

The ACN/PCN system provides a standardized international aircraft/pavement rating system replacing the various S, T, TT, LCN, AUW, ISWL, etc., rating systems used throughout the world. ACN is the Aircraft Classification Number and PCN is the corresponding Pavement Classification Number.

An aircraft having an ACN less than or equal to the PCN can operate without restriction on the pavement.

Numerically the ACN is two times the derived single wheel load expressed in thousands of kilograms. The derived single wheel load is defined as the load on a single tire inflated to 1.25 MPa (181 psi) that would have the same pavement requirements as the aircraft.

Computationally the ACN/PCN system uses PCA program PDILB for rigid pavements and S-77-1 for flexible pavements to calculate ACN values.

The Airport Authority must decide on the method of pavement analysis and the results of their evaluation shown as follows:

PCN			
PAVEMENT TYPE	SUBGRADE CATEGORY	TIRE PRESSURE CATEGORY	EVALUATION METHOD
R - Rigid	A - High	W - No pressure limit	T - Technical
F - Flexible	B - Medium	X - High pressure limited to 1.75 MPa (254 psi)	U - Using Aircraft
	C - Low	Y - Medium pressure limited to 1.25 MPa (181 psi)	

PCN			
PAVEMENT TYPE	SUBGRADE CATEGORY	TIRE PRESSURE CATEGORY	EVALUATION METHOD
	D - Ultra Low	Z - Low pressure limited to 0.5 MPa (73 psi)	

For flexible pavements, the four subgrade categories (CBR) are:

- A. High Strength CBR 15
- B. Medium Strength CBR 10
- C. Low Strength CBR 6
- D. Ultra Low Strength CBR 3

For rigid pavements, the four subgrade categories (k) are:

- A. High Strength k = 150 MN/m³ (550 pci)
- B. Medium Strength k = 80 MN/m³ (300 pci)
- C. Low Strength k = 40 MN/m³ (150 pci)
- D. Ultra Low Strength k = 20 MN/m³ (75 pci)

7-2-0 Landing Gear Footprint****ON A/C A340-500 A340-600**Landing Gear Footprint

1. This section provides data about the landing gear footprint in relation to the aircraft MRW and tire sizes and pressures.
The landing-gear footprint information is given for all the operational weight variants of the aircraft.

A340-500/-600

AIRCRAFT CHARACTERISTICS - AIRPORT AND MAINTENANCE PLANNING

**ON A/C A340-600

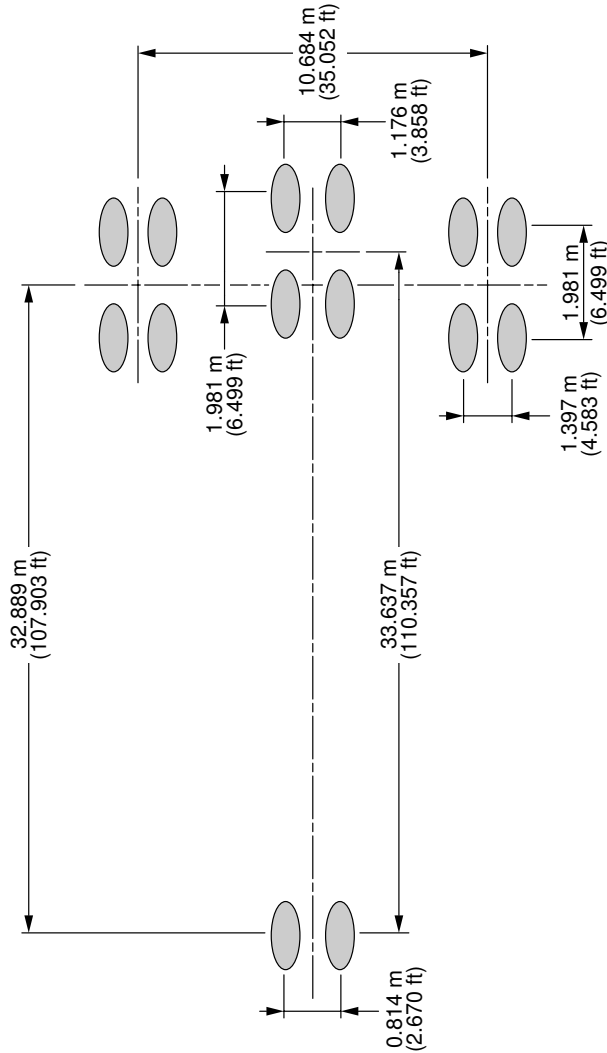

WEIGHT VARIANT	MAXIMUM RAMP WEIGHT	PERCENTAGE OF WEIGHT ON MAIN GEAR GROUP	NOSE GEAR TIRE SIZE	NOSE GEAR TIRE PRESSURE	MAIN GEAR TIRE SIZE	MAIN GEAR TIRE PRESSURE	CENTRAL GEAR TIRE SIZE	CENTRAL GEAR TIRE PRESSURE
A340-600 WV000	366 200 kg (807 325 lb)	93.5%	45x180R17 36PR	13.7 bar (199 psi)	1400x530R23	16.1 bar (234 psi)	1400x530R23	15 bar (218 psi)
A340-600 WV001	369 200 kg (813 950 lb)	93.4%	45x180R17 36PR	13.7 bar (199 psi)	1400x530R23	16.1 bar (234 psi)	1400x530R23	15 bar (218 psi)
A340-600 WV101	381 200 kg (840 400 lb)	92.3%	45x180R17 36PR	13.9 bar (202 psi)	1400x530R23	16.1 bar (234 psi)	1400x530R23	16.1 bar (234 psi)
A340-600 WV102	369 200 kg (813 950 lb)	93.4%	45x180R17 36PR	13.9 bar (202 psi)	1400x530R23	16.1 bar (234 psi)	1400x530R23	16.1 bar (234 psi)
A340-600 WV103	366 200 kg (807 325 lb)	93.5%	45x180R17 36PR	13.9 bar (202 psi)	1400x530R23	16.1 bar (234 psi)	1400x530R23	16.1 bar (234 psi)

F_AC_070200_1_0320101_01_02

Landing Gear Footprint
FIGURE-7-2-0-991-032-A01

A340-500/-600

AIRCRAFT CHARACTERISTICS - AIRPORT AND MAINTENANCE PLANNING

**ON A/C A340-500

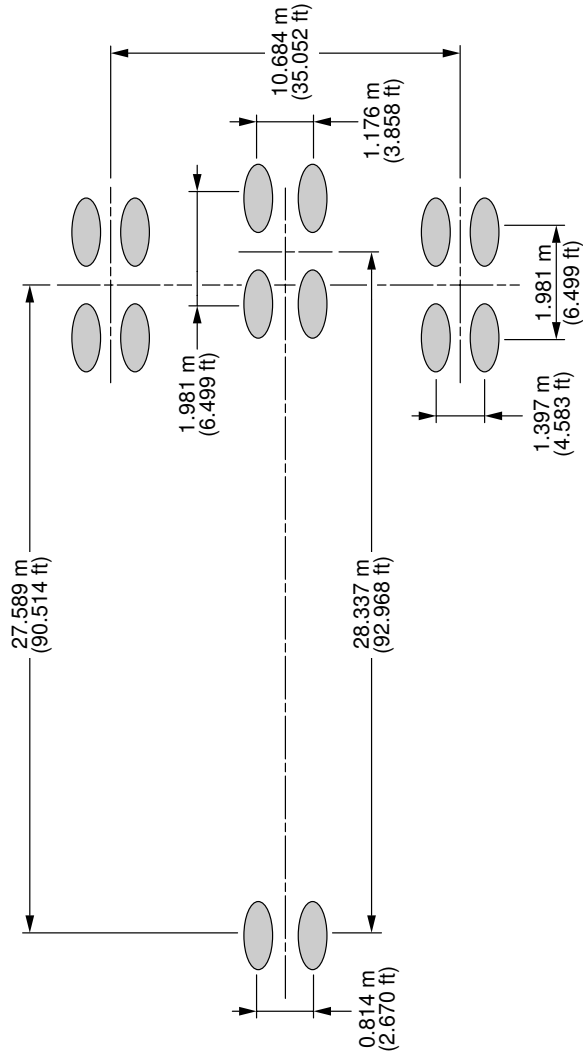

WEIGHT VARIANT	MAXIMUM RAMP WEIGHT	PERCENTAGE OF WEIGHT ON MAIN GEAR GROUP	NOSE GEAR TIRE SIZE	NOSE GEAR TIRE PRESSURE	MAIN GEAR TIRE SIZE	MAIN GEAR TIRE PRESSURE	CENTRAL GEAR TIRE SIZE	CENTRAL GEAR TIRE PRESSURE
A340-500 WV000	369 200 kg (813 950 lb)	92.7%	45x180R17 36PR	14.1 bar (205 psi)	1400x530R23	16.1 bar (234 psi)	1400x530R23	15 bar (218 psi)
A340-500 WV001	373 200 kg (822 775 lb)	92.7%	45x180R17 36PR	14.1 bar (205 psi)	1400x530R23	16.1 bar (234 psi)	1400x530R23	15 bar (218 psi)
A340-500 WV002	373 200 kg (822 775 lb)	92.7%	45x180R17 36PR	14.1 bar (205 psi)	1400x530R23	16.1 bar (234 psi)	1400x530R23	15 bar (218 psi)
A340-500 WV003	375 200 kg (827 175 lb)	92.2%	45x180R17 36PR	14.1 bar (205 psi)	1400x530R23	16.1 bar (234 psi)	1400x530R23	15 bar (218 psi)
A340-500 WV004	375 200 kg (827 175 lb)	92.2%	45x180R17 36PR	14.1 bar (205 psi)	1400x530R23	16.1 bar (234 psi)	1400x530R23	15 bar (218 psi)
A340-500 WV101	381 200 kg (840 400 lb)	92.1%	45x180R17 36PR	14.1 bar (205 psi)	1400x530R23	16.1 bar (234 psi)	1400x530R23	16.1 bar (234 psi)
A340-500 WV102	373 200 kg (822 775 lb)	92.6%	45x180R17 36PR	14.1 bar (205 psi)	1400x530R23	16.1 bar (234 psi)	1400x530R23	16.1 bar (234 psi)
A340-500 WV103	373 200 kg (822 775 lb)	92.6%	45x180R17 36PR	14.1 bar (205 psi)	1400x530R23	16.1 bar (234 psi)	1400x530R23	16.1 bar (234 psi)

F_AC_070200_1_0440101_01_01

Landing Gear Footprint
FIGURE-7-2-0-991-044-A01

7-3-0 Maximum Pavement Loads****ON A/C A340-500 A340-600**Maximum Pavement Loads

1. This section provides maximum vertical and horizontal pavement loads for some critical conditions at the tire-ground interfaces.
The maximum pavement loads are given for all the operational weight variants of the aircraft.

A340-500/-600

AIRCRAFT CHARACTERISTICS - AIRPORT AND MAINTENANCE PLANNING

**ON A/C A340-600

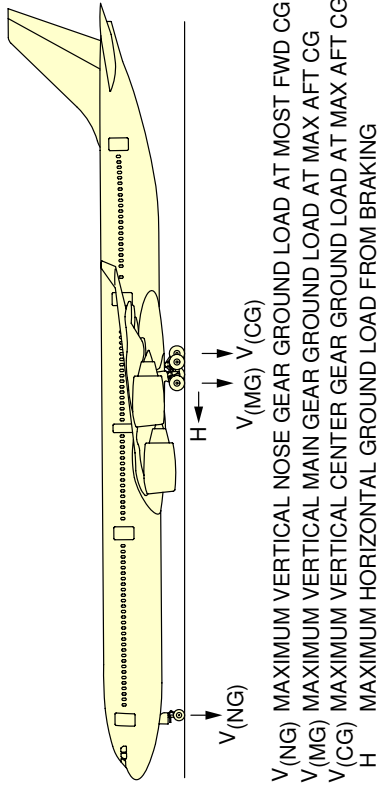

1	2	3	4	5	6	7	
MODEL	MAXIMUM RAMP WEIGHT	$V(NG)$		$V(MG)$ (PER STRUT)	$V(CG)$ (PER STRUT)	H (PER STRUT)	
		STATIC LOAD AT MOST FWD CG	STATIC BRAKING AT 10 ft/s ² DECELERATION	STATIC LOAD AT MAX AFT CG	STATIC LOAD AT MAX AFT CG	STEADY BRAKING AT 10 ft/s ² DECELERATION	
		16% MAC (b)	55 250 kg (121 800 lb)	35% MAC (a)	35% MAC (a)	AT INSTANTANEOUS BRAKING COEFFICIENT = 0.8	
A340-600 WV000	366 200 kg (807 325 lb)	40 320 kg (88 900 lb)	55 250 kg (121 800 lb)	117 950 kg (260 025 lb)	106 570 kg (234 950 lb)	39 200 kg (86 425 lb) (c) 35 420 kg (78 100 lb) (d)	94 360 kg (208 025 lb) (c) 85 260 kg (187 975 lb) (d)

NOTE:

- (a) LOADS CALCULATED USING AIRCRAFT AT MRW.
- (b) LOADS CALCULATED USING AIRCRAFT AT 354 600 kg (781 750 lb).
- (c) BRAKED MAIN GEAR.
- (d) BRAKED CENTER GEAR.

F_AC_070300_1_0110101_01_03

Maximum Pavement Loads
(Sheet 1 of 2)

FIGURE-7-3-0-991-011-A01

A340-500/-600

AIRCRAFT CHARACTERISTICS - AIRPORT AND MAINTENANCE PLANNING

****ON A/C A340-600**

1	2	3		4		5		6		7	
MODEL	MAXIMUM RAMP WEIGHT	V (NG)		STATIC BRAKING AT 10 ft/s ² DECELERATION		V (MG) (PER STRUT)		V (CG) (PER STRUT)		STEADY BRAKING AT 10 ft/s ² DECELERATION	AT INSTANTANEOUS BRAKING COEFFICIENT = 0.8
		STATIC LOAD AT MOST FWD CG	16% MAC (b)	55 250 kg (121 800 lb)	34.43% MAC (a)	118 930 kg (262 200 lb)	34.43% MAC (a)	106 880 kg (235 625 lb)	34.43% MAC (a)	39 590 kg (87 275 lb)	95 140 kg (209 750 lb)
A340-600 WV001	369 200 kg (813 950 lb)	40 320 kg (88 900 lb)	16% MAC (b)	55 250 kg (121 800 lb)	34.43% MAC (a)	118 930 kg (262 200 lb)	34.43% MAC (a)	106 880 kg (235 625 lb)	34.43% MAC (a)	39 590 kg (87 275 lb)	95 140 kg (209 750 lb)
A340-600 WV101	381 200 kg (840 400 lb)	40 330 kg (88 900 lb)	16% MAC (b)	55 070 kg (121 400 lb)	30.2% MAC (a)	121 020 kg (266 800 lb)	30.2% MAC (a)	109 720 kg (241 900 lb)	30.2% MAC (a)	40 760 kg (89 850 lb)	96 810 kg (213 425 lb)
A340-600 WV102	369 200 kg (813 950 lb)	40 330 kg (88 900 lb)	16% MAC (b)	55 070 kg (121 400 lb)	34.43% MAC (a)	118 160 kg (260 500 lb)	34.43% MAC (a)	108 340 kg (238 850 lb)	34.43% MAC (a)	36 070 kg (79 525 lb)	94 530 kg (208 400 lb)
A340-600 WV103	366 200 kg (807 325 lb)	40 330 kg (88 900 lb)	16% MAC (b)	55 110 kg (121 500 lb)	35% MAC (a)	117 270 kg (258 525 lb)	35% MAC (a)	107 850 kg (237 775 lb)	35% MAC (a)	38 980 kg (85 925 lb)	93 820 kg (206 850 lb)

NOTE:

- (a) LOADS CALCULATED USING AIRCRAFT AT MRW.
- (b) LOADS CALCULATED USING AIRCRAFT AT 354 600 kg (781 750 lb).
- (c) BRAKED MAIN GEAR.
- (d) BRAKED CENTER GEAR.

F_AC_070300_1_0110102_01_01

Maximum Pavement Loads
(Sheet 2 of 2)

FIGURE-7-3-0-991-011-A01

A340-500/-600

AIRCRAFT CHARACTERISTICS - AIRPORT AND MAINTENANCE PLANNING

**ON A/C A340-500

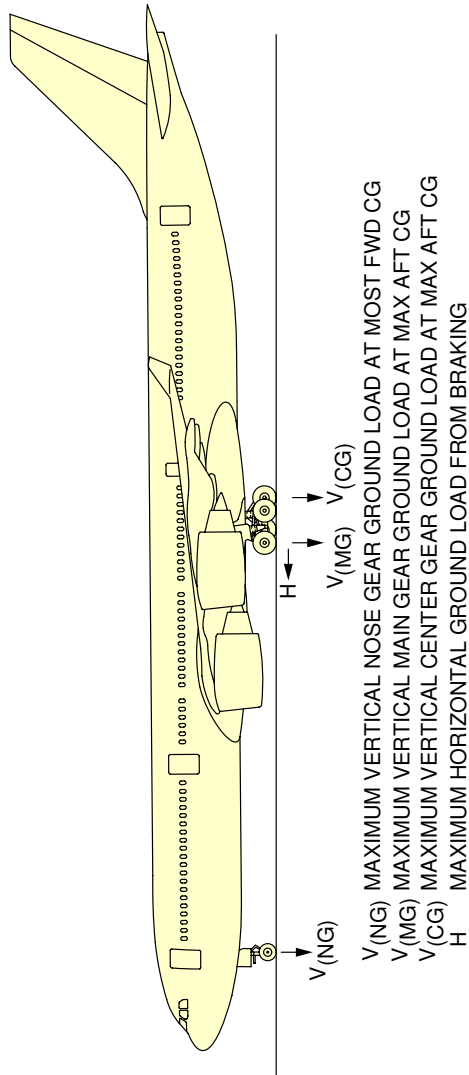

1	2	3	4	5	6	7	
MODEL	MAXIMUM RAMP WEIGHT	V (NG)		V (MG) (PER STRUT)	V (CG) (PER STRUT)	H (PER STRUT)	
		STATIC LOAD AT MOST FWD CG	STATIC BRAKING AT 10 #/s ² DECELERATION	STATIC LOAD AT MAX AFT CG	STATIC LOAD AT MAX AFT CG	STEADY BRAKING AT 10 #/s ² DECELERATION	
						AT INSTANTANEOUS BRAKING COEFFICIENT = 0.8	
A340-500 WV000	369 200 kg (813 950 lb)	41 160 kg (90 750 lb) 22% MAC (b)	58 500 kg (128 975 lb)	117 990 kg (260 125 lb) 36.5% MAC (a)	106 240 kg (234 225 lb) 36.5% MAC (a)	39 560 kg (87 225 lb) (c) 35 620 kg (78 525 lb) (d)	94 390 kg (208 100 lb) (c) 84 990 kg (187 375 lb) (d)
A340-500 WV001	373 200 kg (822 775 lb)	41 160 kg (90 750 lb) 22% MAC (b)	58 500 kg (128 975 lb)	119 540 kg (263 550 lb) 36.4% MAC (a)	106 760 kg (235 375 lb) 36.4% MAC (a)	40 090 kg (88 375 lb) (c) 35 810 kg (78 950 lb) (d)	95 630 kg (210 825 lb) (c) 85 410 kg (188 300 lb) (d)

NOTE:

- (a) LOADS CALCULATED USING AIRCRAFT AT MRW
- (b) LOADS CALCULATED USING AIRCRAFT AT 349 200 kg (769 850 lb)
- (c) BRAKED MAIN GEAR
- (d) BRAKED CENTER GEAR

F_AC_070300_1_0130101_01_04

Maximum Pavement Loads
(Sheet 1 of 2)

FIGURE-7-3-0-991-013-A01

A340-500/-600

AIRCRAFT CHARACTERISTICS - AIRPORT AND MAINTENANCE PLANNING

****ON A/C A340-500**

1	2	3		4	5		6		7		
		V (NG)			V (MG)		V (CG)		H (PER STRUT)		
MODEL	MAXIMUM RAMP WEIGHT	STATIC LOAD AT MOST FWD CG	STATIC BRAKING AT 10 #/s ² DECELERATION	STATIC LOAD AT MAX AFT CG	STATIC LOAD AT MAX AFT CG	STATIC LOAD AT MAX AFT CG	STATIC LOAD AT MAX AFT CG	STEADY BRAKING AT 10 #/s ² DECELERATION	AT INSTANTANEOUS BRAKING COEFFICIENT = 0.8		
A340-500 WV002	373 200 kg (822 775 lb)	41 160 kg (90 750 lb) 22% MAC (b)	58 500 kg (128 975 lb)	119 540 kg (263 550 lb) 36.4% MAC (a)	106 760 kg (235 375 lb) 36.4% MAC (a)	40 090 kg (88 375 lb) 36.4% MAC (c)	95 630 kg (210 825 lb) 36.4% MAC (c)	40 090 kg (88 375 lb) 36.4% MAC (c)	95 630 kg (210 825 lb) 36.4% MAC (c)		
A340-500 WV003	375 200 kg (827 175 lb)	41 160 kg (90 750 lb) 22% MAC (b)	58 500 kg (128 975 lb)	119 680 kg (263 850 lb) 35.01% MAC (a)	106 730 kg (235 300 lb) 35.01% MAC (a)	40 330 kg (88 900 lb) 35.01% MAC (c)	95 740 kg (211 075 lb) 35.01% MAC (c)	40 330 kg (88 900 lb) 35.01% MAC (c)	95 740 kg (211 075 lb) 35.01% MAC (c)		
A340-500 WV004	375 200 kg (827 175 lb)	41 160 kg (90 750 lb) 22% MAC (b)	58 500 kg (128 975 lb)	119 680 kg (263 850 lb) 35.01% MAC (a)	106 730 kg (235 300 lb) 35.01% MAC (a)	40 330 kg (88 900 lb) 35.01% MAC (c)	95 740 kg (211 075 lb) 35.01% MAC (c)	40 330 kg (88 900 lb) 35.01% MAC (c)	95 740 kg (211 075 lb) 35.01% MAC (c)		
A340-500 WV101	381 200 kg (840 400 lb)	41 150 kg (90 725 lb) 22% MAC (b)	58 440 kg (128 850 lb)	120 590 kg (265 850 lb) 34.7% MAC (a)	109 980 kg (242 475 lb) 34.7% MAC (a)	40 690 kg (89 700 lb) 34.7% MAC (c)	96 470 kg (212 675 lb) 34.7% MAC (c)	40 690 kg (89 700 lb) 34.7% MAC (c)	96 470 kg (212 675 lb) 34.7% MAC (c)		
A340-500 WV102	373 200 kg (822 775 lb)	41 150 kg (90 725 lb) 22% MAC (b)	58 440 kg (128 850 lb)	118 440 kg (261 125 lb) 36.4% MAC (a)	108 840 kg (239 950 lb) 36.4% MAC (a)	39 740 kg (87 600 lb) 36.4% MAC (c)	94 750 kg (208 900 lb) 36.4% MAC (c)	39 740 kg (87 600 lb) 36.4% MAC (c)	94 750 kg (208 900 lb) 36.4% MAC (c)		
A340-500 WV103	373 200 kg (822 775 lb)	41 150 kg (90 725 lb) 22% MAC (b)	58 440 kg (128 850 lb)	118 440 kg (261 125 lb) 36.4% MAC (a)	108 840 kg (239 950 lb) 36.4% MAC (a)	39 740 kg (87 600 lb) 36.4% MAC (c)	94 750 kg (208 900 lb) 36.4% MAC (c)	39 740 kg (87 600 lb) 36.4% MAC (c)	94 750 kg (208 900 lb) 36.4% MAC (c)		

NOTE:

- (a) LOADS CALCULATED USING AIRCRAFT AT MRW
- (b) LOADS CALCULATED USING AIRCRAFT AT 349 200 kg (769 850 lb)
- (c) BRAKED MAIN GEAR
- (d) BRAKED CENTER GEAR

F_AC_070300_1_0130102_01_01

Maximum Pavement Loads
(Sheet 2 of 2)

FIGURE-7-3-0-991-013-A01

7-4-0 Landing Gear Loading on Pavement

****ON A/C A340-500 A340-600**

Landing Gear Loading on Pavement

1. This section provides data about the landing gear loading on pavement.
The MLG loading on pavement graphs are given for the weight variants that produce (at the MRW and maximum aft CG and standard tire pressure) the lowest ACN (and LCN) and the highest ACN (and LCN) for each type of aircraft.
2. MLG Loading on Pavement
Example, see FIGURE 7-4-0-991-009-A (Sheet 1), calculation of the total weight on the MLG for:
 - An aircraft with a MRW of 369 200 kg (813 950 lb),
 - The aircraft gross weight is 280 000 kg (617 300 lb),
 - A percentage of weight on the MLG of 92.69% (percentage of weight on the MLG at MRW and maximum aft CG at MRW).The total weight on the MLG group is 259 530 kg (572 175 lb).
3. Main Gear and Center Gear Loading on Pavement
The MLG group consists of two main gears (4-wheel bogies) plus one center gear (4-wheel bogies).

Example, see FIGURE 7-4-0-991-009-A (Sheet 2), calculation of the total weight on the MLG for:
 - An aircraft with a MRW of 369 200 kg (813 950 lb),
 - The aircraft gross weight is 280 000 kg (617 300 lb),
 - A percentage of weight on the MLG of 92.66% (percentage of weight on the MLG at 280 000 kg (617 290 lb) and maximum aft CG at MRW).The load on the two main gears is 178 450 kg (393 425 lb) and the load on the center gear is 81 000 kg (178 575 lb).
The total weight on the MLG group is 259 450 kg (572 000 lb).

NOTE : The CG in the figure title is the CG used for ACN/LCN calculation.

A340-500/-600

AIRCRAFT CHARACTERISTICS - AIRPORT AND MAINTENANCE PLANNING

**ON A/C A340-500

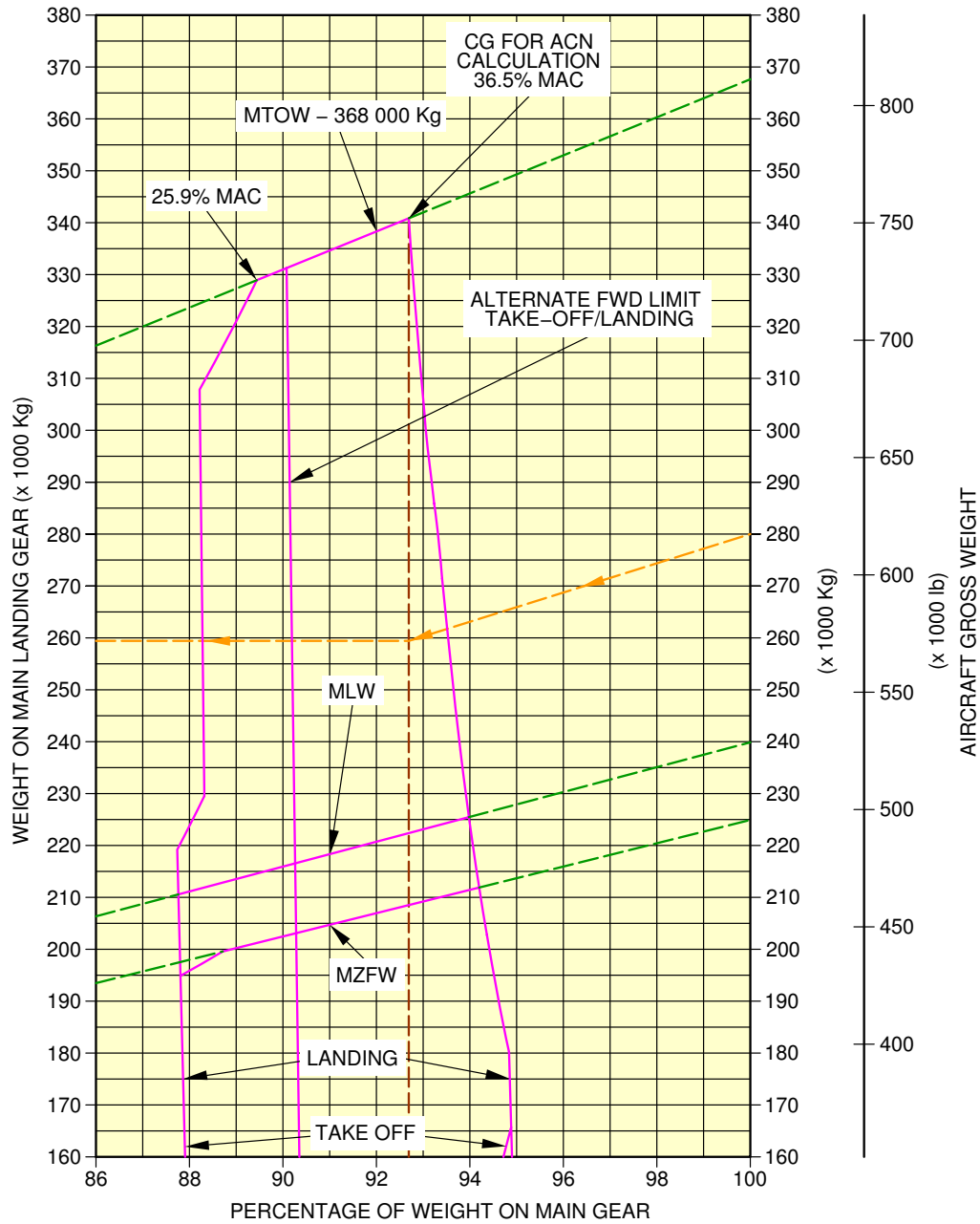

F_AC_070400_1_0090101_01_00

Landing Gear Loading on Pavement
 WV000, MRW 369 200 kg, CG 36.5% (Sheet 1 of 2)
 FIGURE-7-4-0-991-009-A01

A340-500/-600

AIRCRAFT CHARACTERISTICS - AIRPORT AND MAINTENANCE PLANNING

**ON A/C A340-500

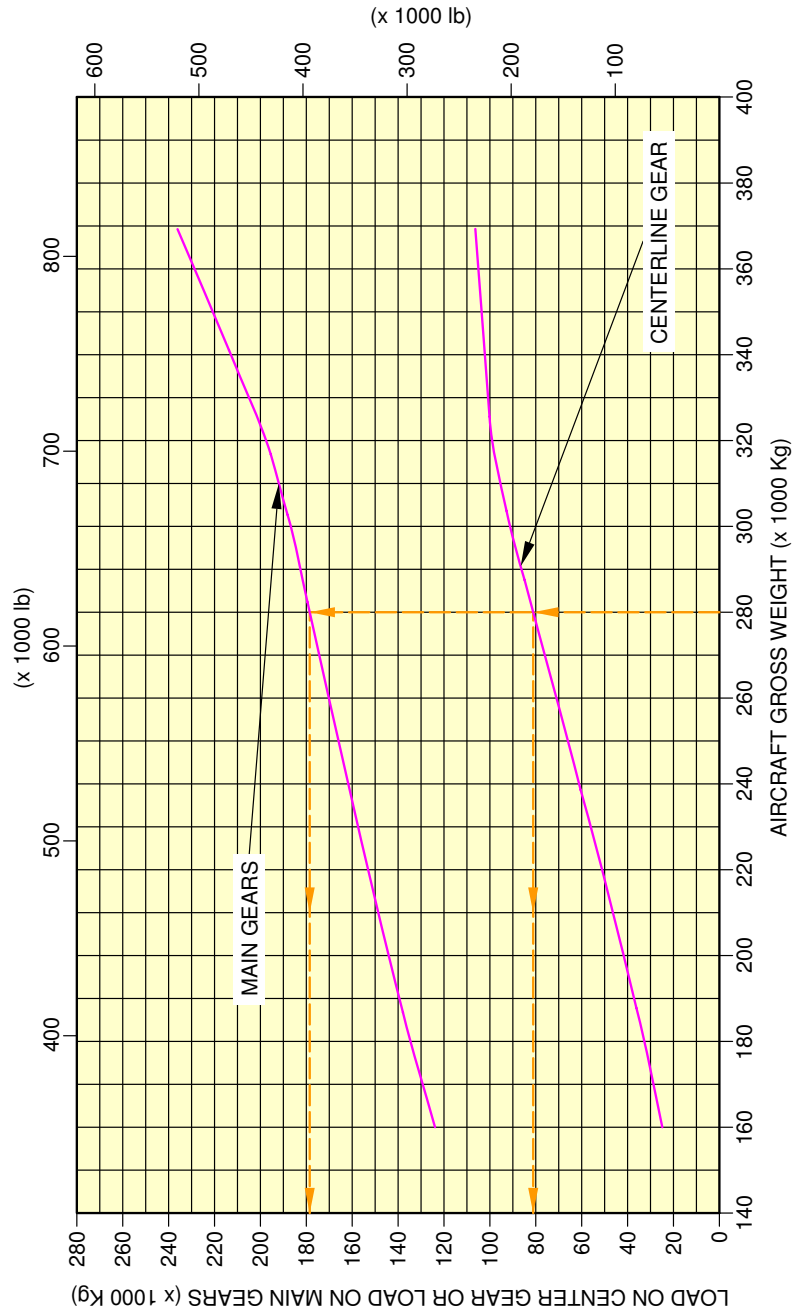

F_AC_070400_1_0090102_01_00

Landing Gear Loading on Pavement
 WV000, MRW 369 200 kg, CG 36.5% (Sheet 2 of 2)
 FIGURE-7-4-0-991-009-A01

A340-500/-600

AIRCRAFT CHARACTERISTICS - AIRPORT AND MAINTENANCE PLANNING

**ON A/C A340-500

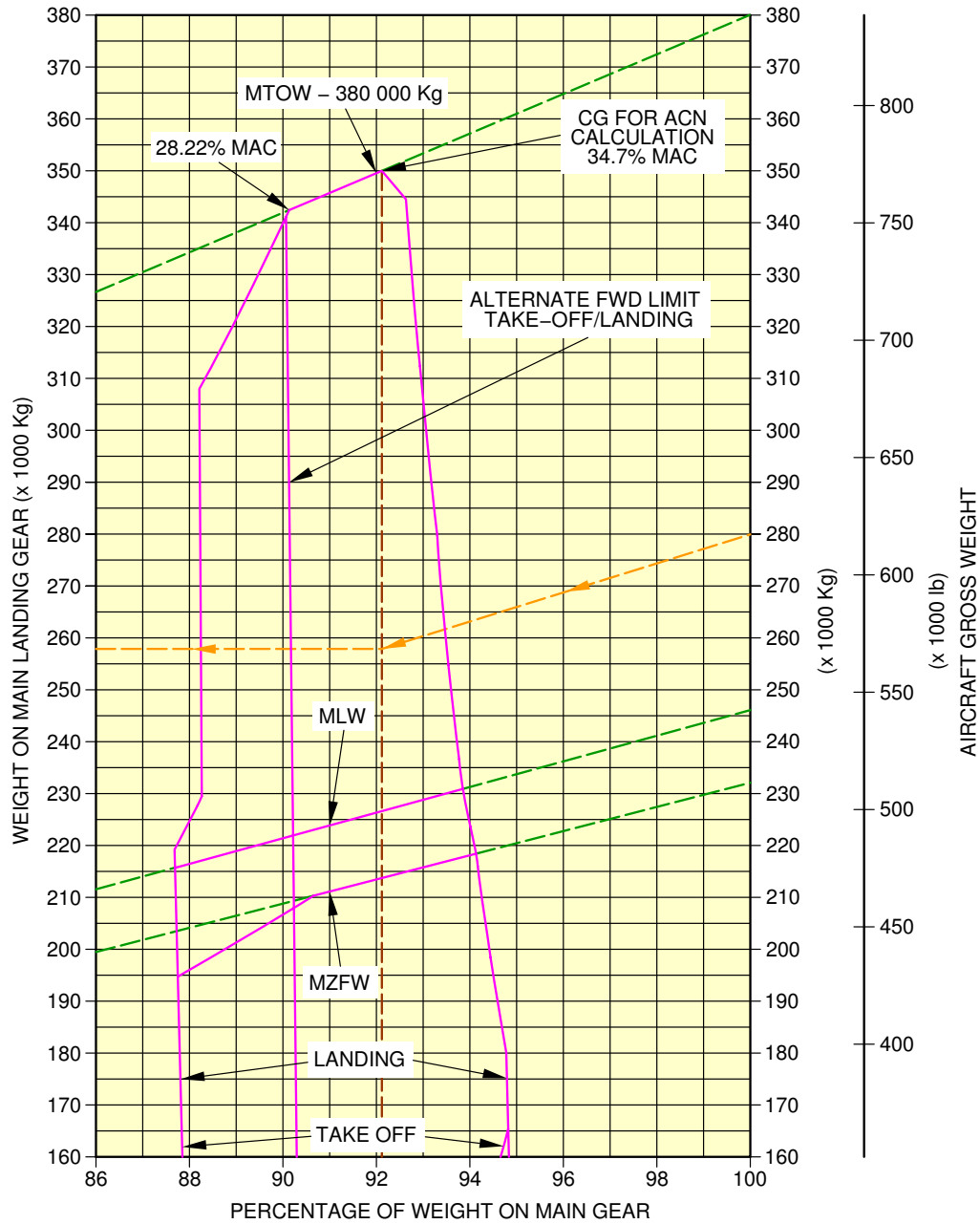

F_AC_070400_1_0100101_01_00

Landing Gear Loading on Pavement
 WV101, MRW 381 200 kg, CG 34.7% (Sheet 1 of 2)
 FIGURE-7-4-0-991-010-A01

A340-500/-600

AIRCRAFT CHARACTERISTICS - AIRPORT AND MAINTENANCE PLANNING

**ON A/C A340-500

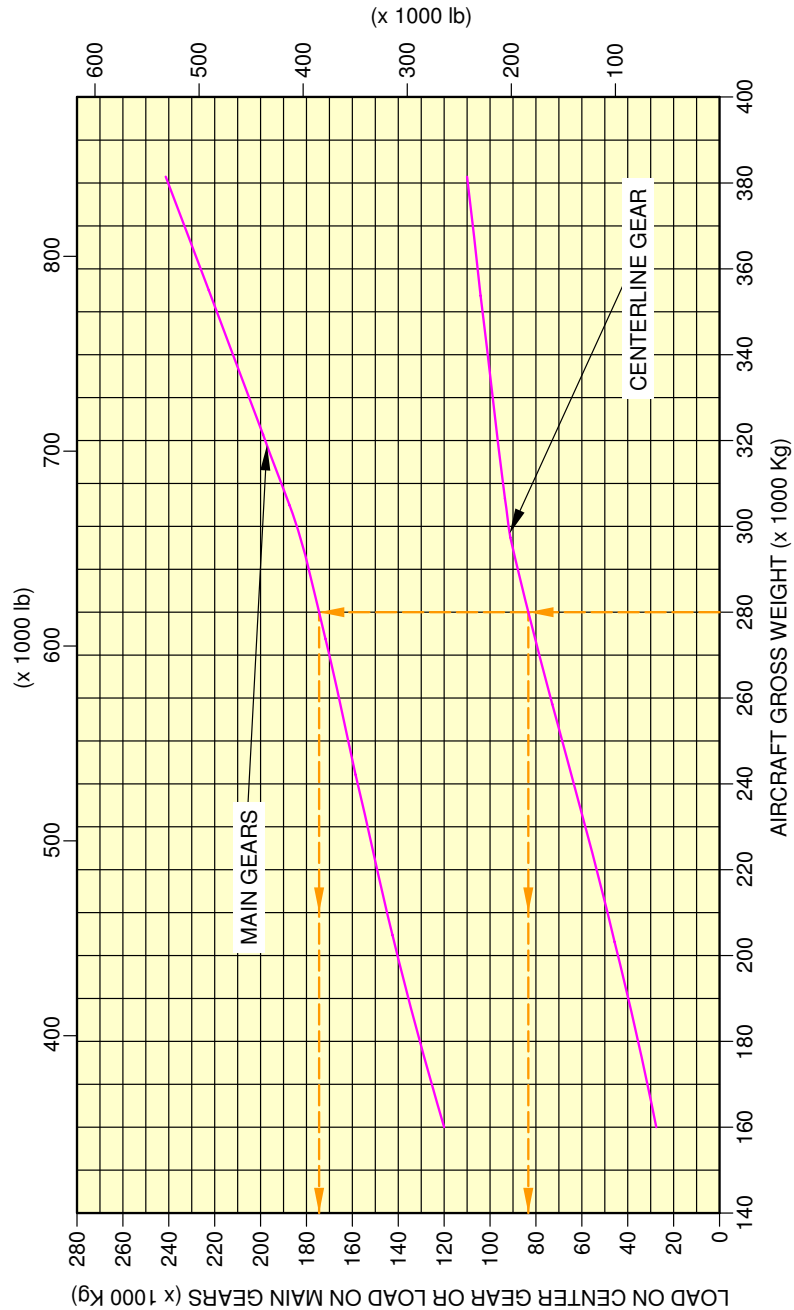

F_AC_070400_1_0100102_01_00

Landing Gear Loading on Pavement
 WV101, MRW 381 200 kg, CG 34.7% (Sheet 2 of 2)
 FIGURE-7-4-0-991-010-A01

A340-500/-600

AIRCRAFT CHARACTERISTICS - AIRPORT AND MAINTENANCE PLANNING

**ON A/C A340-600

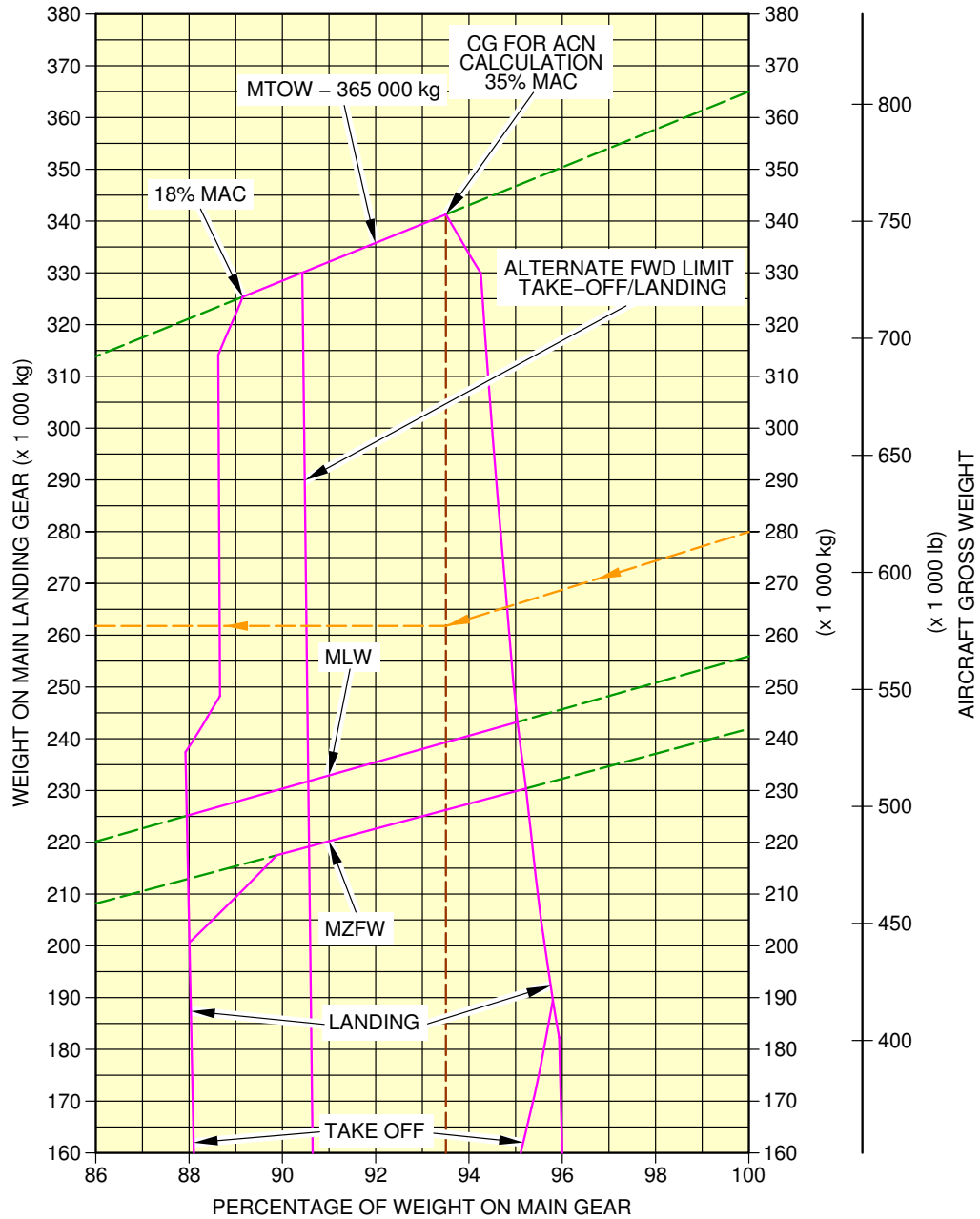

F_AC_070400_1_0110101_01_01

Landing Gear Loading on Pavement
 WV000, MRW 366 200 kg, CG 35% (Sheet 1 of 2)
 FIGURE-7-4-0-991-011-A01

A340-500/-600

AIRCRAFT CHARACTERISTICS - AIRPORT AND MAINTENANCE PLANNING

**ON A/C A340-600

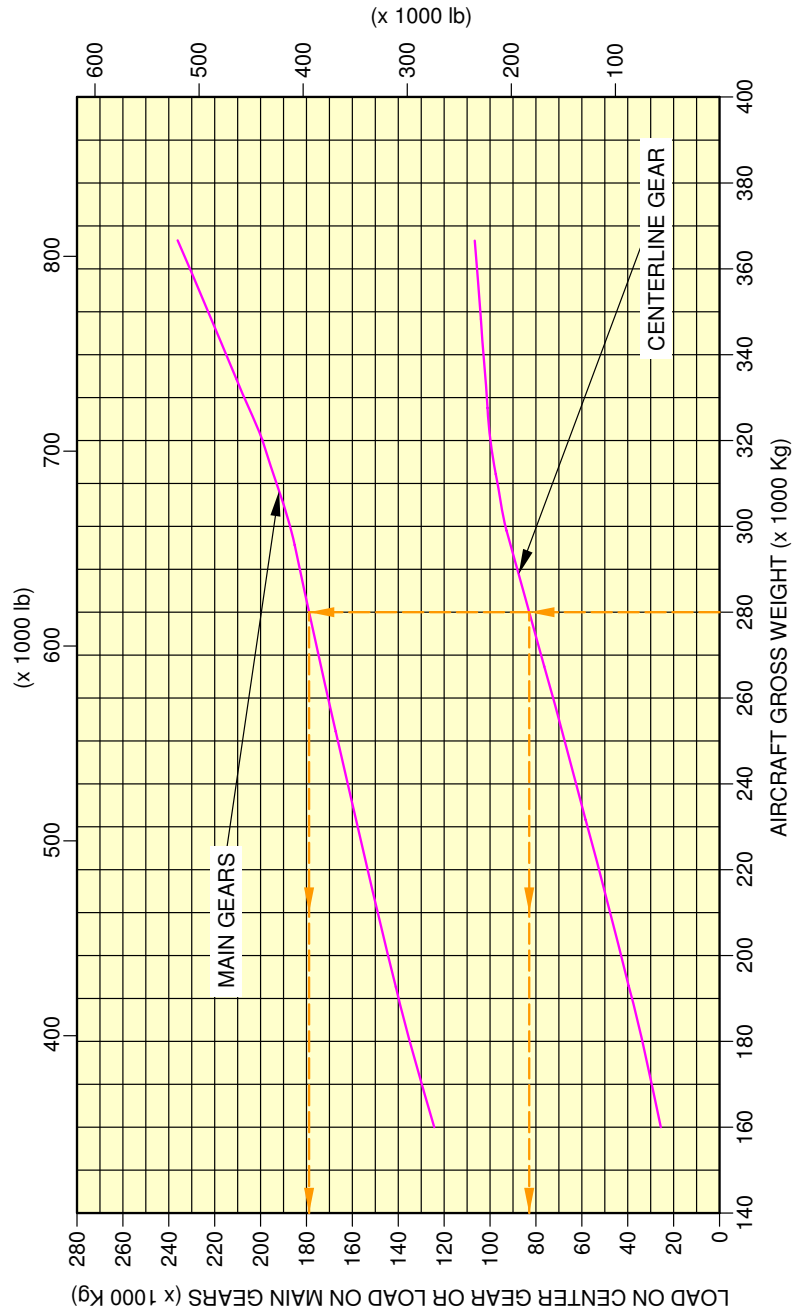

F_AC_070400_1_0110102_01_00

Landing Gear Loading on Pavement
 WV000, MRW 366 200 kg, CG 35% (Sheet 2 of 2)
 FIGURE-7-4-0-991-011-A01

A340-500/-600

AIRCRAFT CHARACTERISTICS - AIRPORT AND MAINTENANCE PLANNING

**ON A/C A340-600

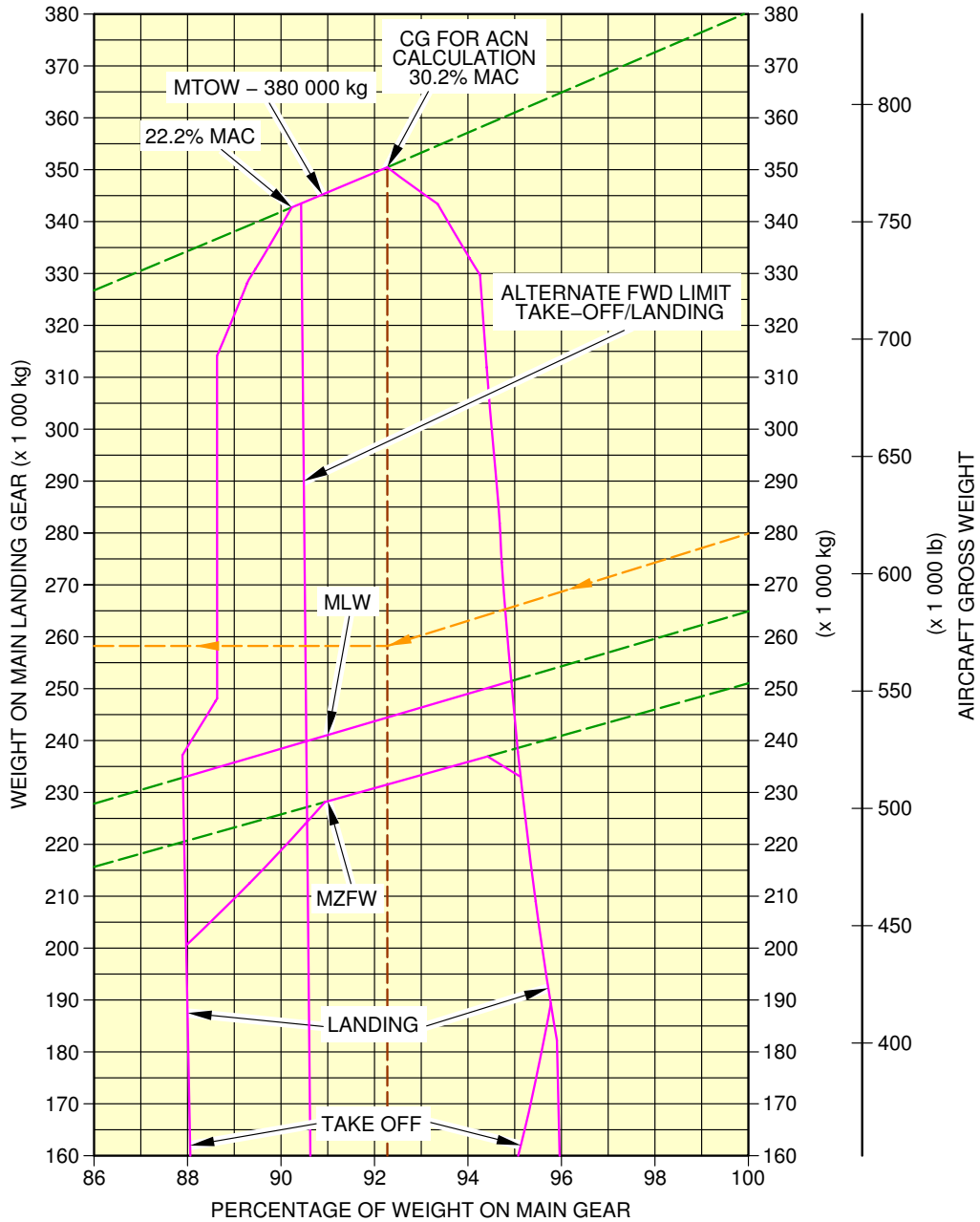

F_AC_070400_1_0120101_01_01

Landing Gear Loading on Pavement
 WV101, MRW 381 200 kg, CG 30.2% (Sheet 1 of 2)
 FIGURE-7-4-0-991-012-A01

A340-500/-600

AIRCRAFT CHARACTERISTICS - AIRPORT AND MAINTENANCE PLANNING

**ON A/C A340-600

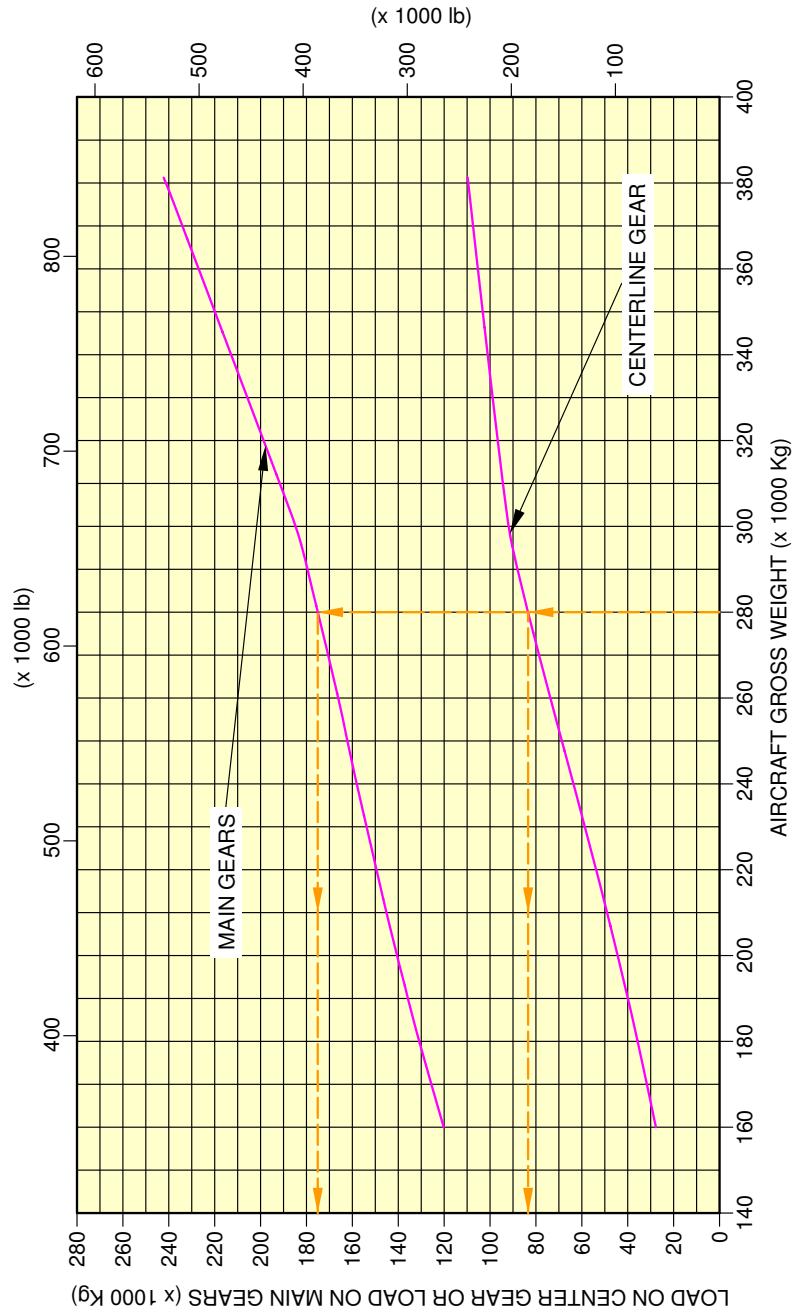

F_AC_070400_1_0120102_01_00

Landing Gear Loading on Pavement
 WV101, MRW 381 200 kg, CG 30.2% (Sheet 2 of 2)
 FIGURE-7-4-0-991-012-A01

7-5-0 Flexible Pavement Requirements - U.S. Army Corps of Engineers Design Method

****ON A/C A340-500 A340-600**

Flexible Pavement Requirements - US Army Corps of Engineers Design Method

1. This section provides data about the flexible pavement requirements.
The MLG loading on pavement graphs are given for the weight variants that produce (at the MRW and maximum aft CG and standard tire pressure) the lowest ACN and the highest ACN for each type of aircraft.
They are calculated with the US Army Corps of Engineers Design Method.
To find a flexible pavement thickness, you must know the Subgrade Strength (CBR), the annual departure level and the weight on one MLG.
The line that shows 10 000 coverages is used to calculate the Aircraft Classification Number (ACN).
The procedure that follows is used to develop flexible pavement design curves:
 - With the scale for pavement thickness at the bottom and the scale for CBR at the top, a random line is made to show 10 000 coverages,
 - A plot is then made of the incremental values of the weight on the MLG,
 - Annual departure lines are made based on the load lines of the weight on the MLG that is shown on the graph.

Example, see FIGURE 7-5-0-991-007-A, calculation of the thickness of the flexible pavement for MLG:

- An aircraft with a MRW of 369 200 kg (813 950 lb),
 - A "CBR" value of 10,
 - An annual departure level of 3 000,
 - The load on one MLG of 110 000 kg (242 500 lb).
- The required flexible pavement thickness is 73.4 cm (29 in).

NOTE : The CG in the figure title is the CG used for ACN calculation.

A340-500/-600

AIRCRAFT CHARACTERISTICS - AIRPORT AND MAINTENANCE PLANNING

**ON A/C A340-500

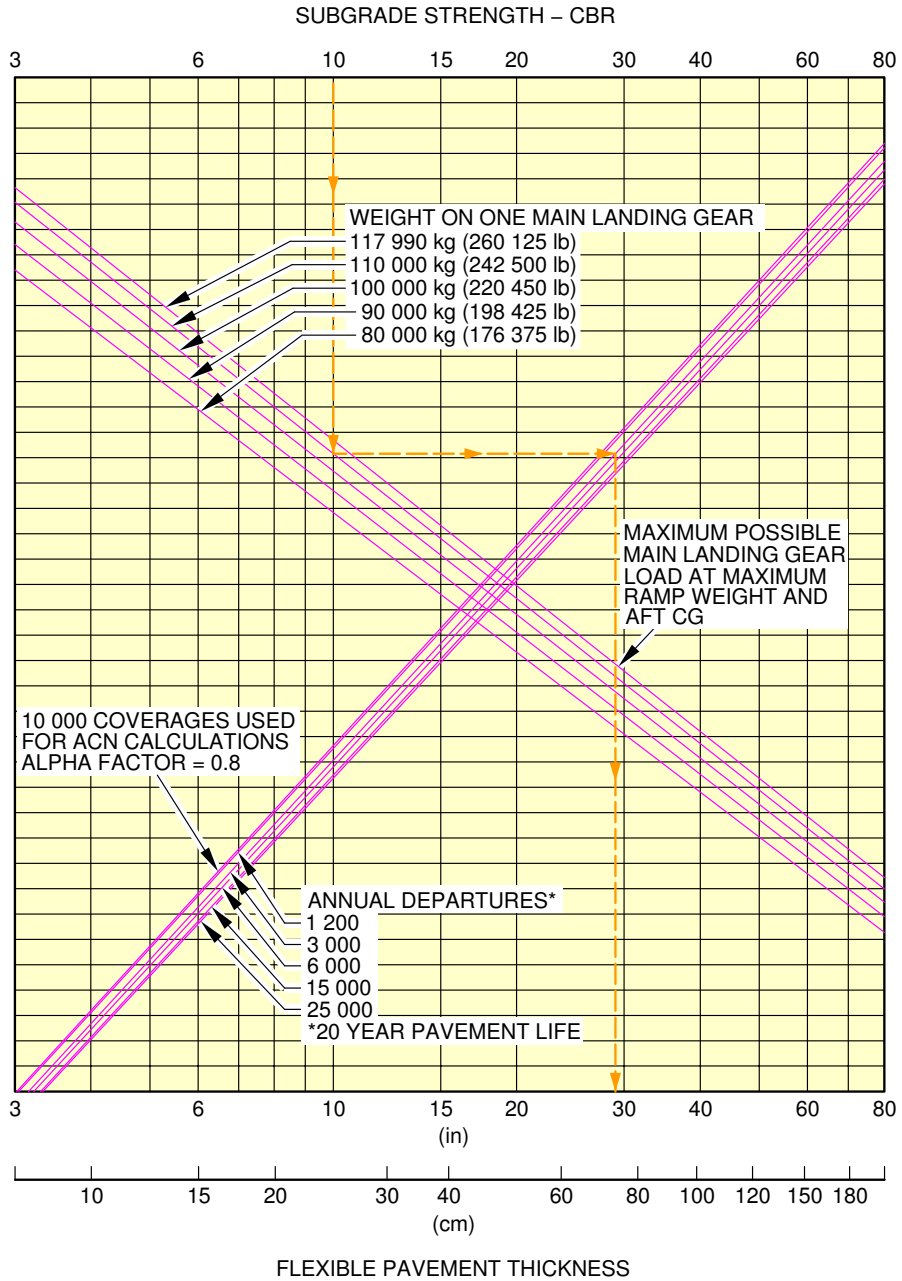

1400 x 530R23 TIRES

TIRE PRESSURE CONSTANT AT 16.1 bar (234 psi)

F_AC_070500_1_0070101_01_01

Flexible Pavement Requirements
 WV000, MRW 369 200 kg, CG 36.5% (Sheet 1 of 2)
 FIGURE-7-5-0-991-007-A01

A340-500/-600

AIRCRAFT CHARACTERISTICS - AIRPORT AND MAINTENANCE PLANNING

**ON A/C A340-500

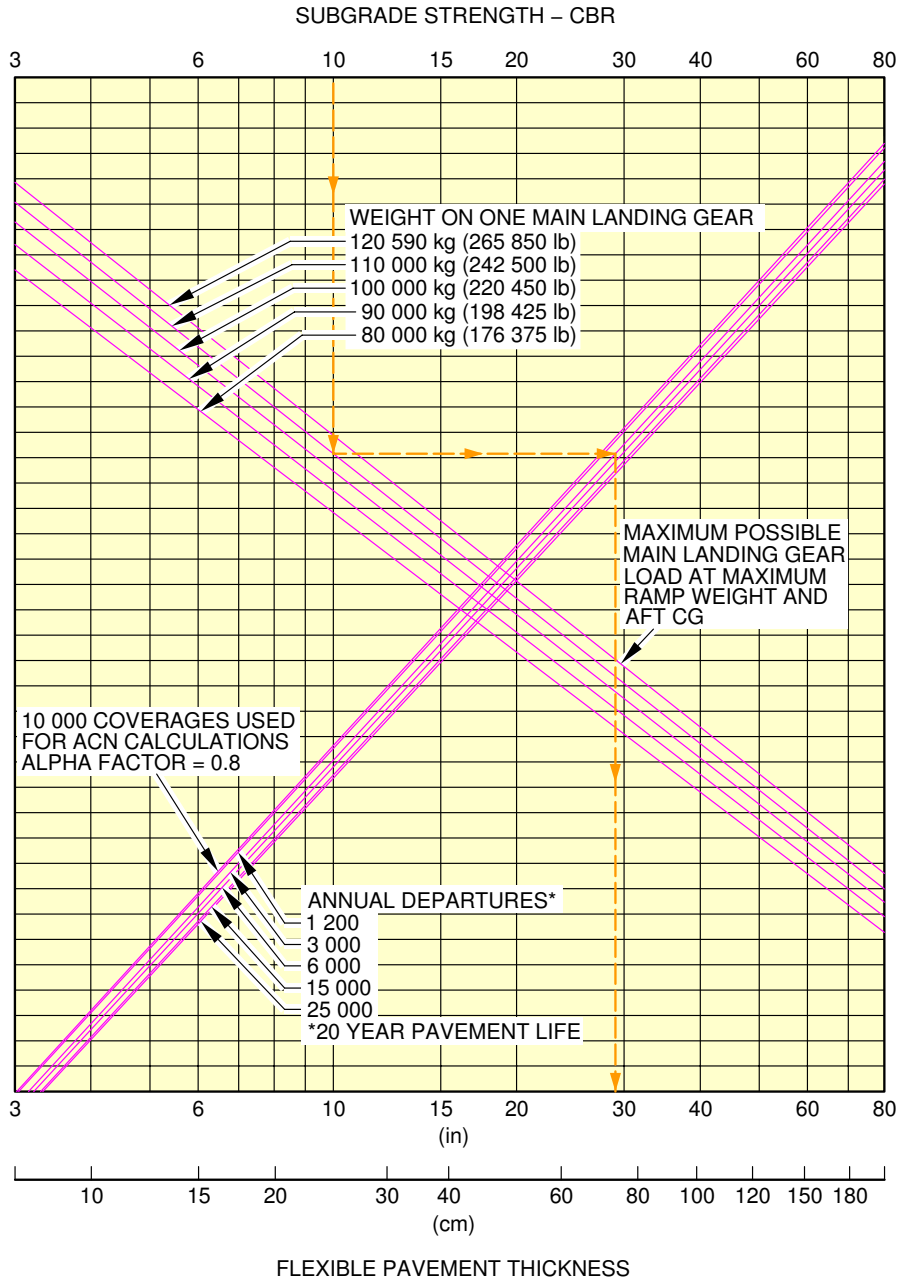

FLEXIBLE PAVEMENT THICKNESS

1400 x 530R23 TIRES

TIRE PRESSURE CONSTANT AT 16.1 bar (234 psi)

F_AC_070500_1_0080101_01_01

Flexible Pavement Requirements
 WV101, MRW 381 200 kg, CG 34.7% (Sheet 2 of 2)
 FIGURE-7-5-0-991-008-A01

A340-500/-600

AIRCRAFT CHARACTERISTICS - AIRPORT AND MAINTENANCE PLANNING

**ON A/C A340-600

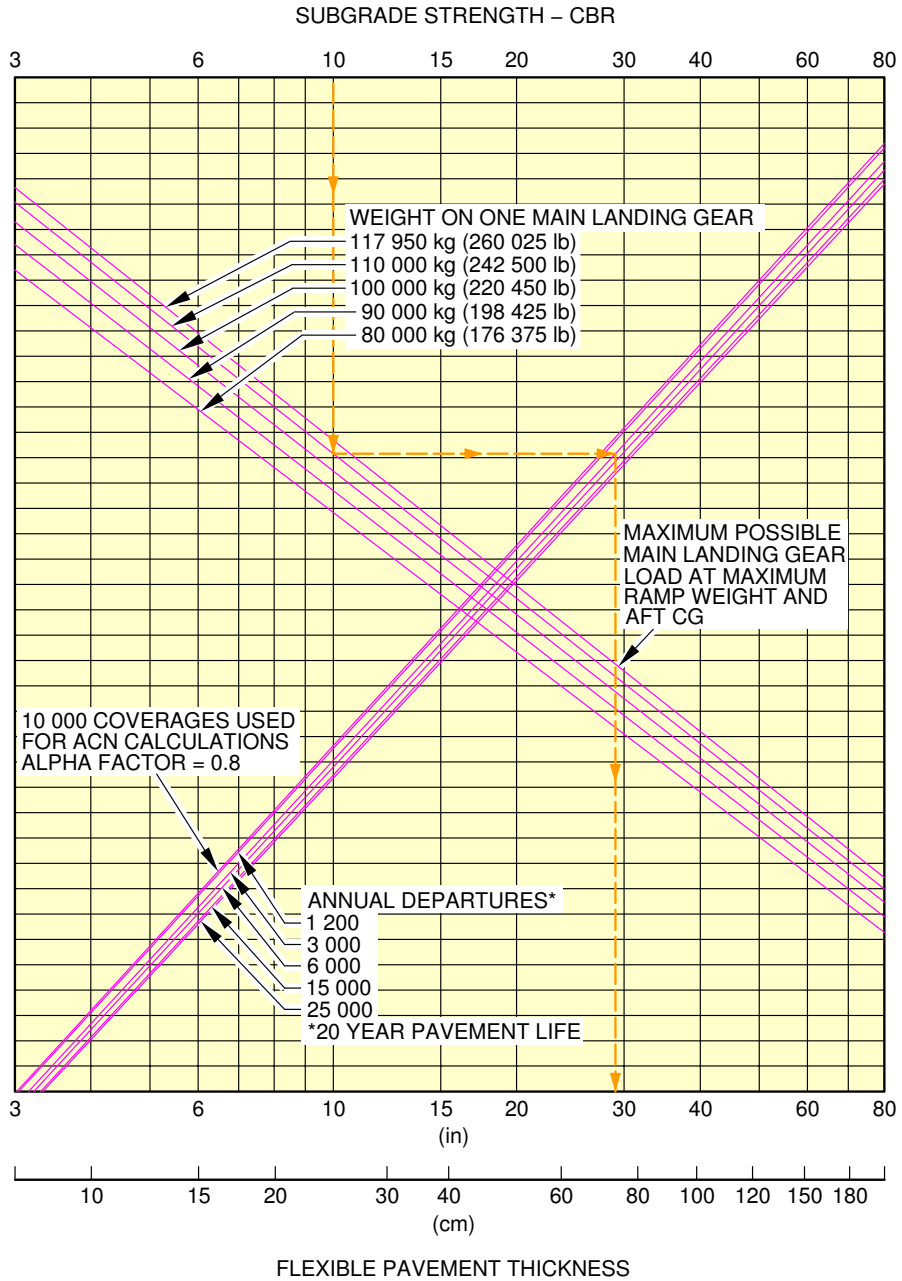

1400 x 530R23 TIRES

TIRE PRESSURE CONSTANT AT 16.1 bar (234 psi)

F_AC_070500_1_0090101_01_01

Flexible Pavement Requirements
 WV000, MRW 366 200 kg, CG 35% (Sheet 1 of 2)
 FIGURE-7-5-0-991-009-A01

A340-500/-600

AIRCRAFT CHARACTERISTICS - AIRPORT AND MAINTENANCE PLANNING

**ON A/C A340-600

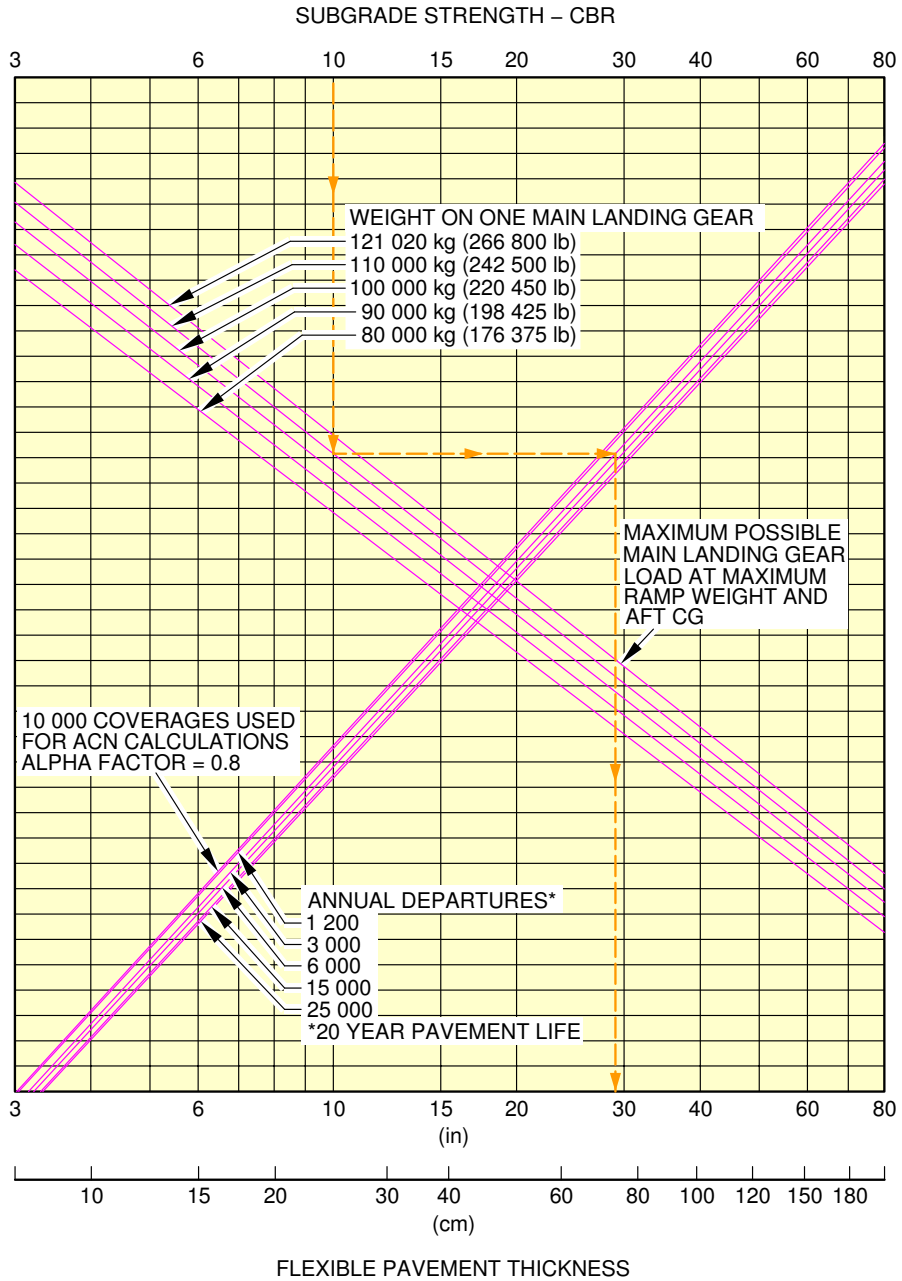

1400 x 530R23 TIRES

TIRE PRESSURE CONSTANT AT 16.1 bar (234 psi)

F_AC_070500_1_0100101_01_01

Flexible Pavement Requirements
 WV101, MRW 381 200 kg, CG 30.2% (Sheet 2 of 2)
 FIGURE-7-5-0-991-010-A01

7-6-0 Flexible Pavement Requirements - LCN Conversion****ON A/C A340-500 A340-600**Flexible Pavement Requirements - LCN Conversion

1. The Load Classification Number (LCN) curves are no longer provided in section 07-06-00 since the LCN system for reporting pavement strength is obsolete, having been replaced by the ICAO recommended ACN/PCN system in 1983.
For questions regarding the LCN system, contact Airbus.

7-7-0 Rigid Pavement Requirements - Portland Cement Association Design Method

****ON A/C A340-500 A340-600**

Rigid Pavement Requirements - Portland Cement Association Design Method

1. This section provides data about the rigid pavement requirements for the PCA (Portland Cement Association) design method.
The MLG loading on pavement graphs are given for the weight variants that produce (at the MRW and maximum aft CG and standard tire pressure) the lowest ACN and the highest ACN for each type of aircraft.
To find a rigid pavement thickness, you must know the Subgrade Modulus (k), the permitted working stress and the weight on one MLG.
The procedure that follows is used to develop rigid pavement design curves:
 - With the scale for pavement thickness on the left and the scale for permitted working stress on the right, a random load line is made. This represents the MLG maximum weight to be shown,
 - A plot is then made of all values of the subgrade modulus (k values),
 - More load lines for the incremental values of the weight on the MLG are made based on the curve for $k = 80 \text{ MN/m}^3$, which is already shown on the graph.

Example, see FIGURE 7-7-0-991-006-A , calculation of the thickness of the rigid pavement for the MLG:

- An aircraft with a MRW of 369 200 kg (813 950 lb),
- A k value of 80 MN/m^3 (300 lbf/in^3),
- A permitted working stress of 38.67 kg/cm^2 (550 lb/in^2),
- The load on one MLG is 110 000 kg (242 500 lb).

The required rigid pavement thickness is 277 mm (11 in).

NOTE : The CG in the figure title is the CG used for ACN calculation.

A340-500/-600

AIRCRAFT CHARACTERISTICS - AIRPORT AND MAINTENANCE PLANNING

**ON A/C A340-500

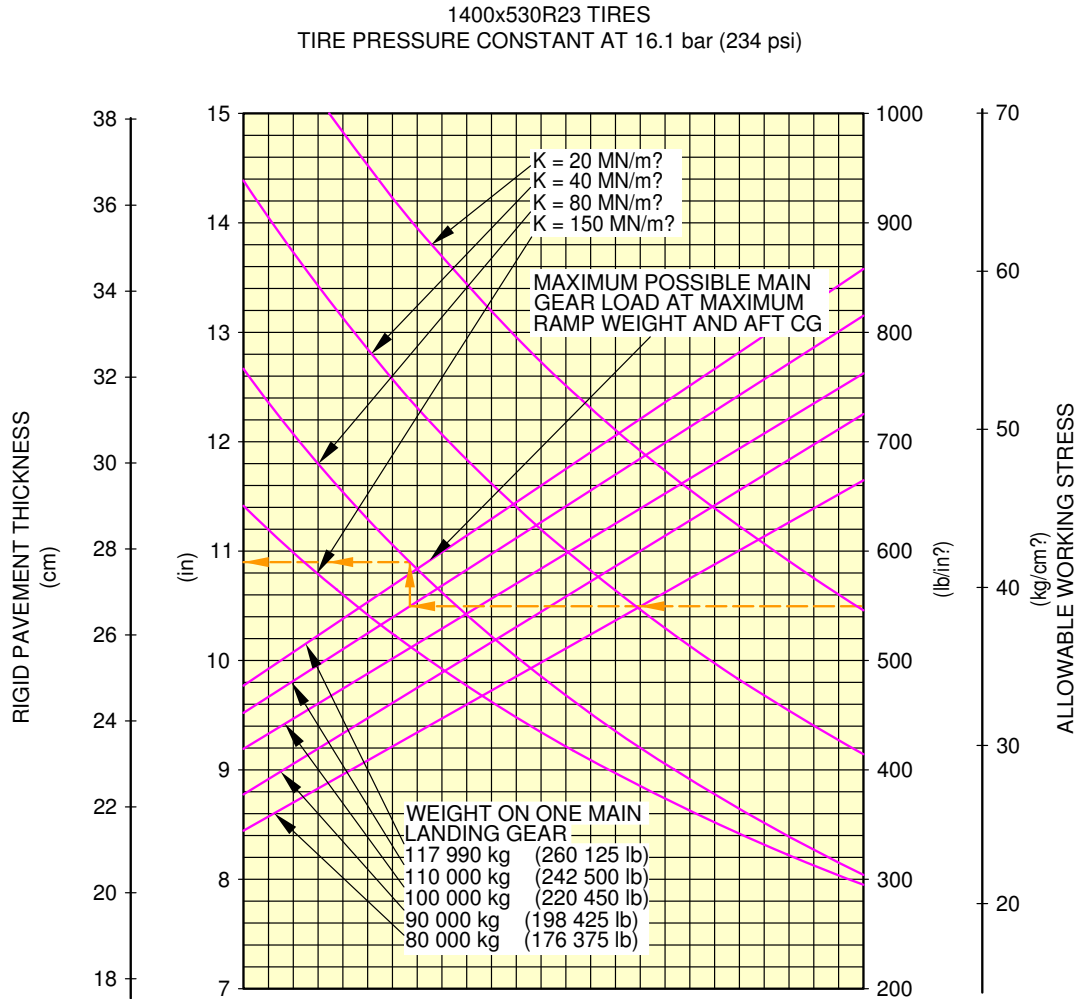

NOTES:
THE VALUES OBTAINED BY USING THE MAXIMUM LOAD REFERENCE LINE AND ANY VALUES FOR K ARE EXACT.
FOR LOADS LESS THAN MAXIMUM, THE CURVES ARE EXACT FOR K = 80 MN/m² BUT DEVIATE SLIGHTLY FOR ANY OTHER VALUES OF K.

REFERENCE:
"DESIGN OF CONCRETE AIRPORT PAVEMENTS" AND "COMPUTER PROGRAM FOR AIRPORT PAVEMENT DESIGN - PROGRAM PDILB" PORTLAND CEMENT ASSOCIATION.

F_AC_070700_1_0060101_01_00

Rigid Pavement Requirements
WV000, MRW 369 200 kg, CG 36.5%
FIGURE-7-7-0-991-006-A01

A340-500/-600

AIRCRAFT CHARACTERISTICS - AIRPORT AND MAINTENANCE PLANNING

**ON A/C A340-500

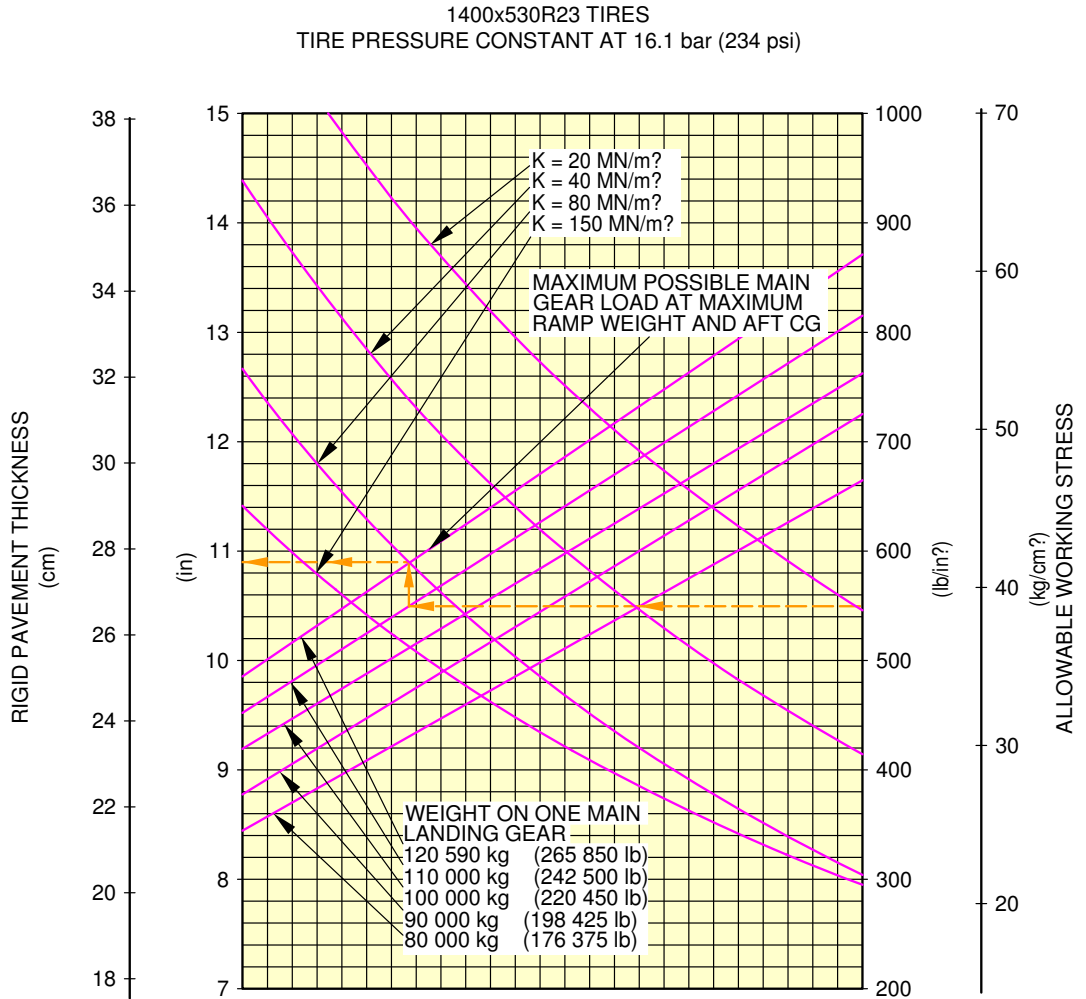

NOTES:
THE VALUES OBTAINED BY USING THE MAXIMUM LOAD REFERENCE LINE AND ANY VALUES FOR K ARE EXACT.
FOR LOADS LESS THAN MAXIMUM, THE CURVES ARE EXACT FOR K = 80 MN/m² BUT DEVIATE SLIGHTLY FOR ANY OTHER VALUES OF K.

REFERENCE:
"DESIGN OF CONCRETE AIRPORT PAVEMENTS" AND "COMPUTER PROGRAM FOR AIRPORT PAVEMENT DESIGN - PROGRAM PDILB" PORTLAND CEMENT ASSOCIATION.

F_AC_070700_1_0070101_01_00

Rigid Pavement Requirements
WV101, MRW 381 200 kg, CG 34.7%
FIGURE-7-7-0-991-007-A01

A340-500/-600

AIRCRAFT CHARACTERISTICS - AIRPORT AND MAINTENANCE PLANNING

**ON A/C A340-600

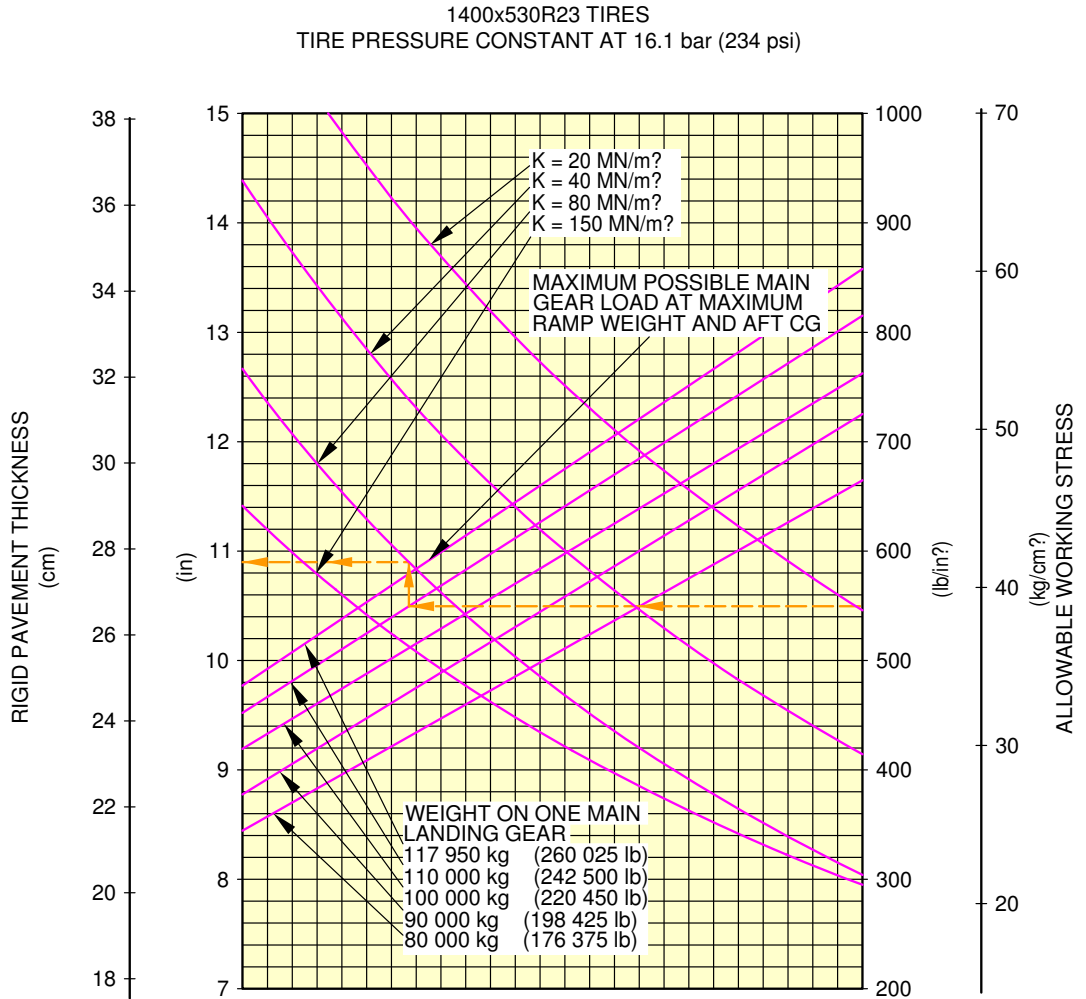

NOTES:
THE VALUES OBTAINED BY USING THE MAXIMUM LOAD REFERENCE LINE AND ANY VALUES FOR K ARE EXACT.
FOR LOADS LESS THAN MAXIMUM, THE CURVES ARE EXACT FOR K = 80 MN/m² BUT DEVIATE SLIGHTLY FOR ANY OTHER VALUES OF K.

REFERENCE:
"DESIGN OF CONCRETE AIRPORT PAVEMENTS" AND "COMPUTER PROGRAM FOR AIRPORT PAVEMENT DESIGN - PROGRAM PDILB" PORTLAND CEMENT ASSOCIATION.

F_AC_070700_1_0080101_01_00

Rigid Pavement Requirements
WV000, MRW 366 200 kg, CG 35%
FIGURE-7-7-0-991-008-A01

A340-500/-600

AIRCRAFT CHARACTERISTICS - AIRPORT AND MAINTENANCE PLANNING

**ON A/C A340-600

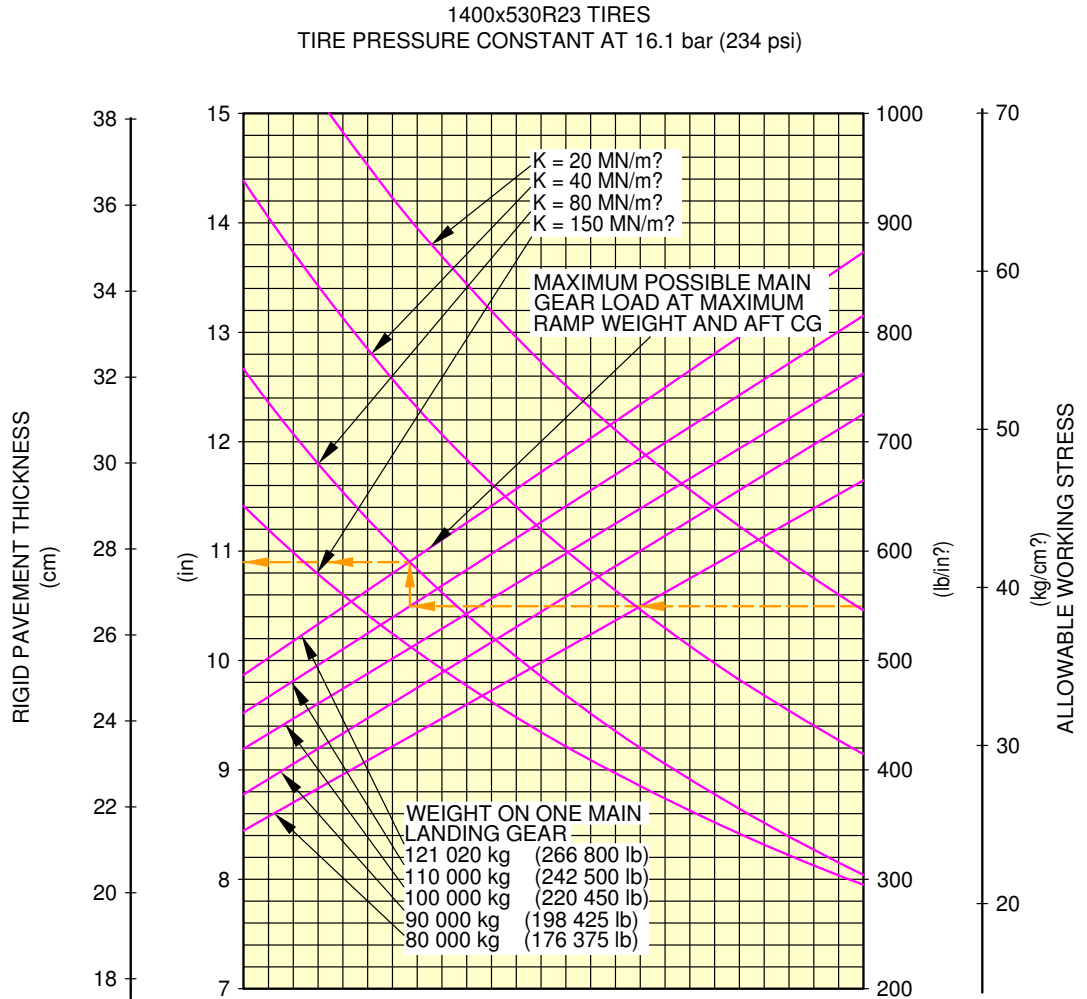

NOTES:
THE VALUES OBTAINED BY USING THE MAXIMUM LOAD REFERENCE LINE AND ANY VALUES FOR K ARE EXACT.
FOR LOADS LESS THAN MAXIMUM, THE CURVES ARE EXACT FOR K = 80 MN/m² BUT DEVIATE SLIGHTLY FOR ANY OTHER VALUES OF K.

REFERENCE:
"DESIGN OF CONCRETE AIRPORT PAVEMENTS" AND "COMPUTER PROGRAM FOR AIRPORT PAVEMENT DESIGN - PROGRAM PDILB" PORTLAND CEMENT ASSOCIATION.

F_AC_070700_1_0090101_01_00

Rigid Pavement Requirements
WV101, MRW 381 200 kg, CG 30.2%
FIGURE-7-7-0-991-009-A01

7-8-0 Rigid Pavement Requirements - LCN Conversion****ON A/C A340-500 A340-600**Rigid Pavement Requirements - LCN Conversion

1. The Load Classification Number (LCN) curves are no longer provided in section 07-08-00 since the LCN system for reporting pavement strength is obsolete, having been replaced by the ICAO recommended ACN/PCN system in 1983.
For questions regarding the LCN system, contact Airbus.

7-9-0 ACN/PCN Reporting System - Flexible and Rigid Pavements

****ON A/C A340-500 A340-600**

Aircraft Classification Number - Flexible and Rigid Pavements

1. This section provides data about the Aircraft Classification Number (ACN) for an aircraft gross weight in relation to a subgrade strength value for flexible and rigid pavement.
The MLG loading on pavement graphs are given for the weight variants that produce (at the MRW and maximum aft CG and standard tire pressure) the lowest ACN and the highest ACN for each type of aircraft.
To find the ACN of an aircraft on flexible and rigid pavement, you must know the aircraft gross weight and the subgrade strength.

NOTE : An aircraft with an ACN equal to or less than the reported PCN can operate on that pavement, subject to any limitation on the tire pressure.
(Ref: ICAO Aerodrome Design Manual, Part 3, Chapter 1, Second Edition 1983).

Example, see FIGURE 7-9-0-991-018-A (sheet 1), calculation of the ACN for flexible pavement for:

- An aircraft with a MRW of 369 200 kg (813 950 lb),
- An aircraft gross weight of 280 000 kg (617 300 lb),
- A medium subgrade strength (code B).

The ACN for flexible pavement is 48.

Example, see FIGURE 7-9-0-991-018-A (sheet 2), calculation of the ACN for rigid pavement for:

- An aircraft with a MRW of 369 200 kg (813 950 lb),
- An aircraft gross weight of 280 000 kg (617 300 lb),
- A medium subgrade strength (code B).

The ACN for rigid pavement is 49.

2. Aircraft Classification Number - ACN table

The tables in FIGURE 7-9-0-991-006-A and FIGURE 7-9-0-991-007-A provide ACN data in tabular format similar to the one used by ICAO in the "Aerodrome Design Manual Part 3, Pavements - Edition 1983" for all the operational weight variants of the aircraft.

As an approximation, use a linear interpolation in order to get the ACN at the required operating weight using the following equation:

- $ACN = ACN \text{ min} + (ACN \text{ max} - ACN \text{ min}) \times (\text{Operating weight} - 180\,000 \text{ kg}) / (\text{MRW} - 180\,000 \text{ kg})$

As an approximation, also use a linear interpolation in order to get the aircraft weight at the pavement PCN using the following equation:

- $\text{Operating weight} = 180\,000 \text{ kg} + (\text{MRW} - 180\,000 \text{ kg}) \times (\text{PCN} - ACN \text{ min}) / (ACN \text{ max} - ACN \text{ min})$

With ACN max = ACN calculated at the MRW in the table and with ACN min = ACN calculated at 180 000 kg.

A340-500/-600

AIRCRAFT CHARACTERISTICS - AIRPORT AND MAINTENANCE PLANNING

NOTE : The CG in the figure title is the CG used for ACN calculation.

A340-500/-600

AIRCRAFT CHARACTERISTICS - AIRPORT AND MAINTENANCE PLANNING

****ON A/C A340-500**

AIRCRAFT TYPE	ALL UP MASS (kg)	LOAD ON ONE MAIN GEAR LEG (%)	TIRE PRESSURE (Mpa)	ACN FOR RIGID PAVEMENT SUBGRADES - MN/m ²				ACN FOR FLEXIBLE PAVEMENT SUBGRADES - CBR			
				High 150	Medium 80	Low 40	Ultra-low 20	High 15	Medium 10	Low 6	Ultra-low 3
A340-500 WV000	369 200	32.0	1.61	62	71	83	96	64	69	80	108
	180 000	37.4		33	35	39	45	32	34	37	47
A340-500 WV001	373 200	32.0	1.61	63	72	85	98	65	70	82	110
	180 000	37.4		33	35	39	45	32	34	37	47
A340-500 WV002	373 200	32.0	1.61	63	72	85	98	65	70	82	110
	180 000	37.4		33	35	39	45	32	34	37	47
A340-500 WV003	375 200	31.9	1.61	63	72	85	98	65	70	82	110
	180 000	37.3		33	35	39	45	32	34	37	47
A340-500 WV004	375 200	31.9	1.61	63	72	85	98	65	70	82	110
	180 000	37.3		33	35	39	45	32	34	37	47
A340-500 WV101	381 200	31.6	1.61	63	73	86	99	66	71	83	111
	180 000	36.3		32	34	38	44	31	33	36	45
A340-500 WV102	373 200	31.7	1.61	62	71	84	97	64	69	80	108
	180 000	36.4		33	34	38	44	31	33	36	45
A340-500 WV103	373 200	31.7	1.61	62	71	84	97	64	69	80	108
	180 000	36.4		33	34	38	44	31	33	36	45

F_AC_070900_1_0060101_01_00

Aircraft Classification Number
ACN Table
FIGURE-7-9-0-991-006-A01

A340-500/-600

AIRCRAFT CHARACTERISTICS - AIRPORT AND MAINTENANCE PLANNING

**ON A/C A340-500

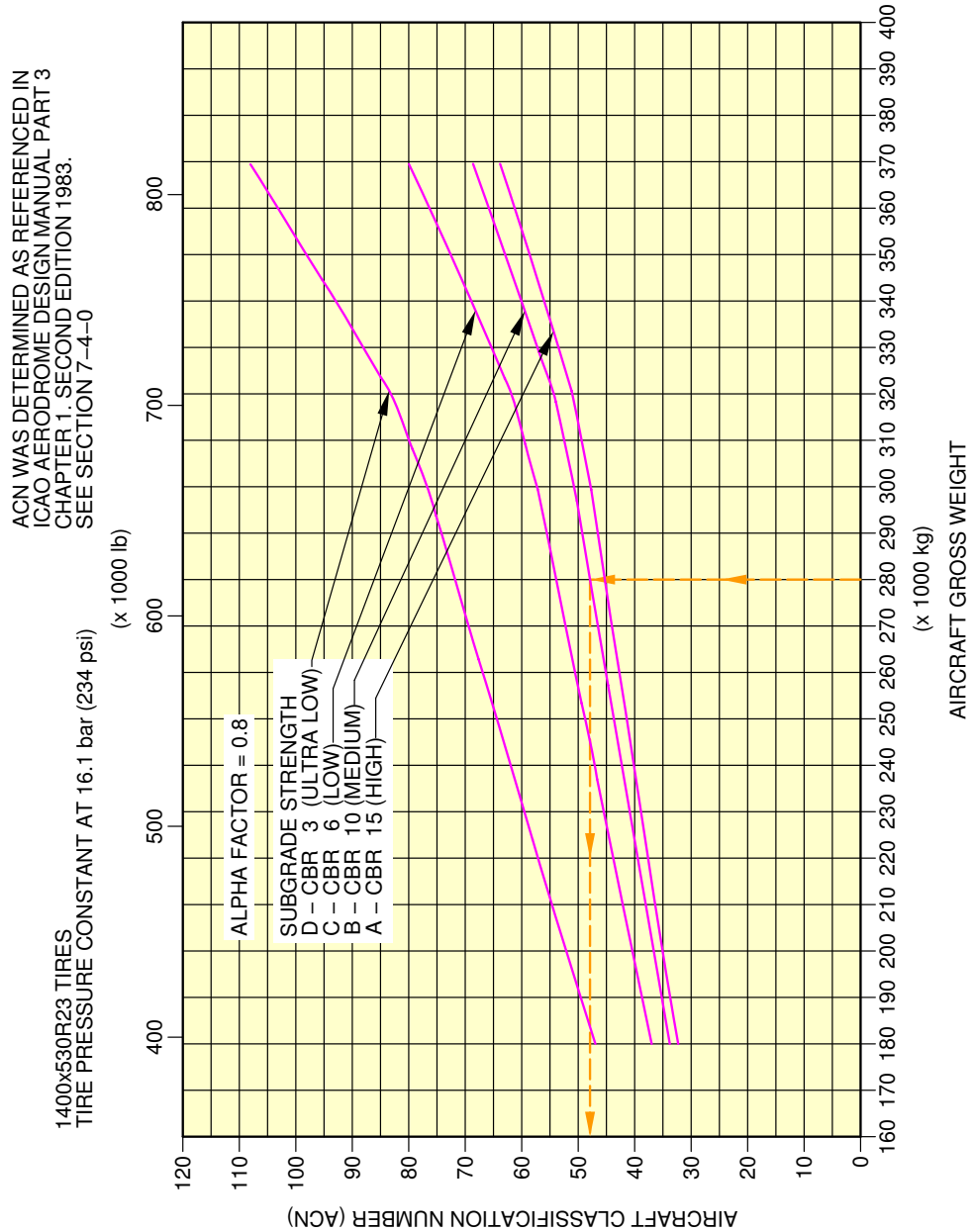

F_AC_070900_1_0180101_01_00

Aircraft Classification Number
Flexible Pavement - WV000, MRW 369 200 kg, CG 36.5% (Sheet 1 of 2)
FIGURE-7-9-0-991-018-A01

A340-500/-600

AIRCRAFT CHARACTERISTICS - AIRPORT AND MAINTENANCE PLANNING

**ON A/C A340-500

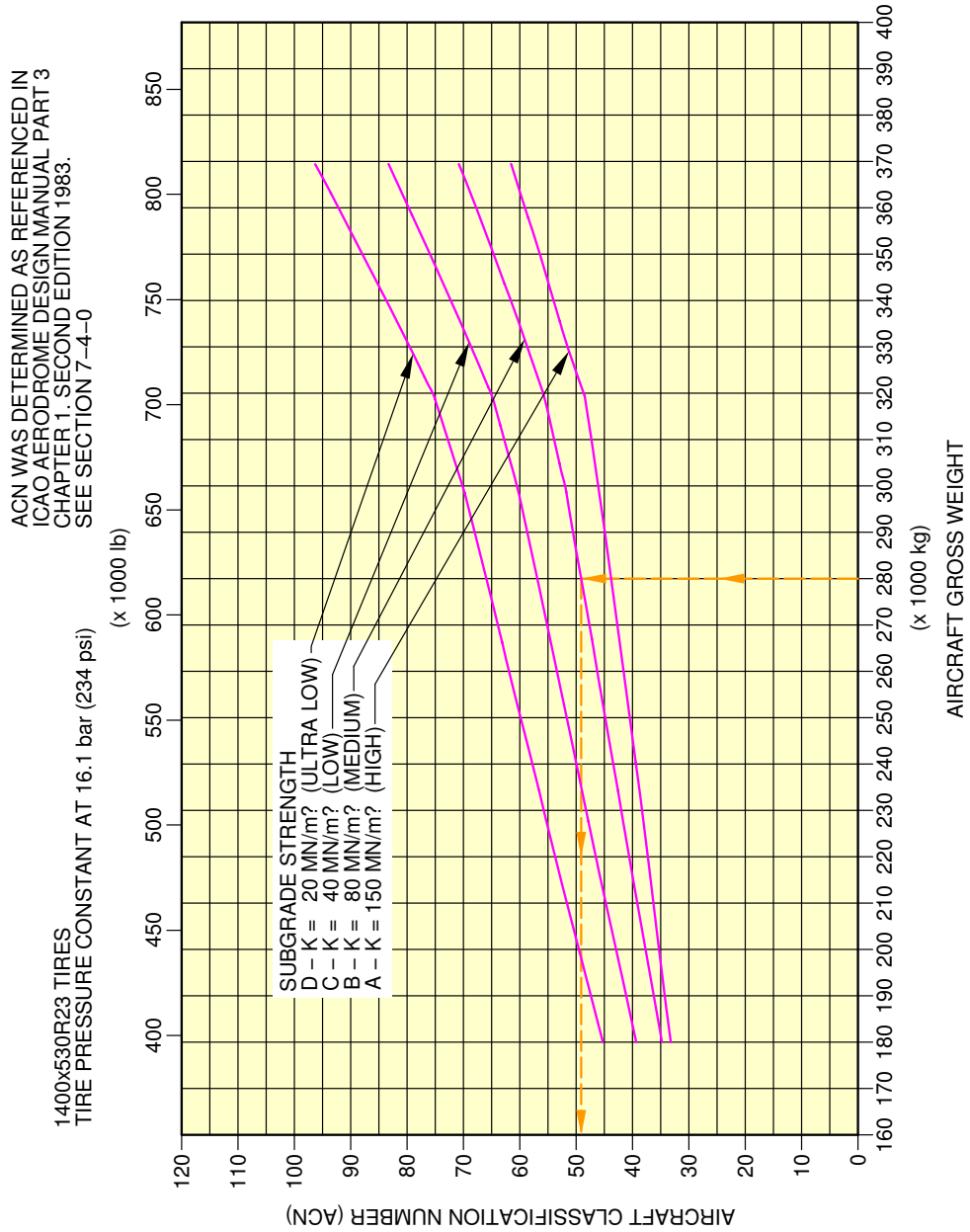

F_AC_070900_1_0180102_01_00

Aircraft Classification Number
Rigid Pavement - WV000, MRW 369 200 kg, CG 36.5% (Sheet 2 of 2)
FIGURE-7-9-0-991-018-A01

A340-500/-600

AIRCRAFT CHARACTERISTICS - AIRPORT AND MAINTENANCE PLANNING

**ON A/C A340-500

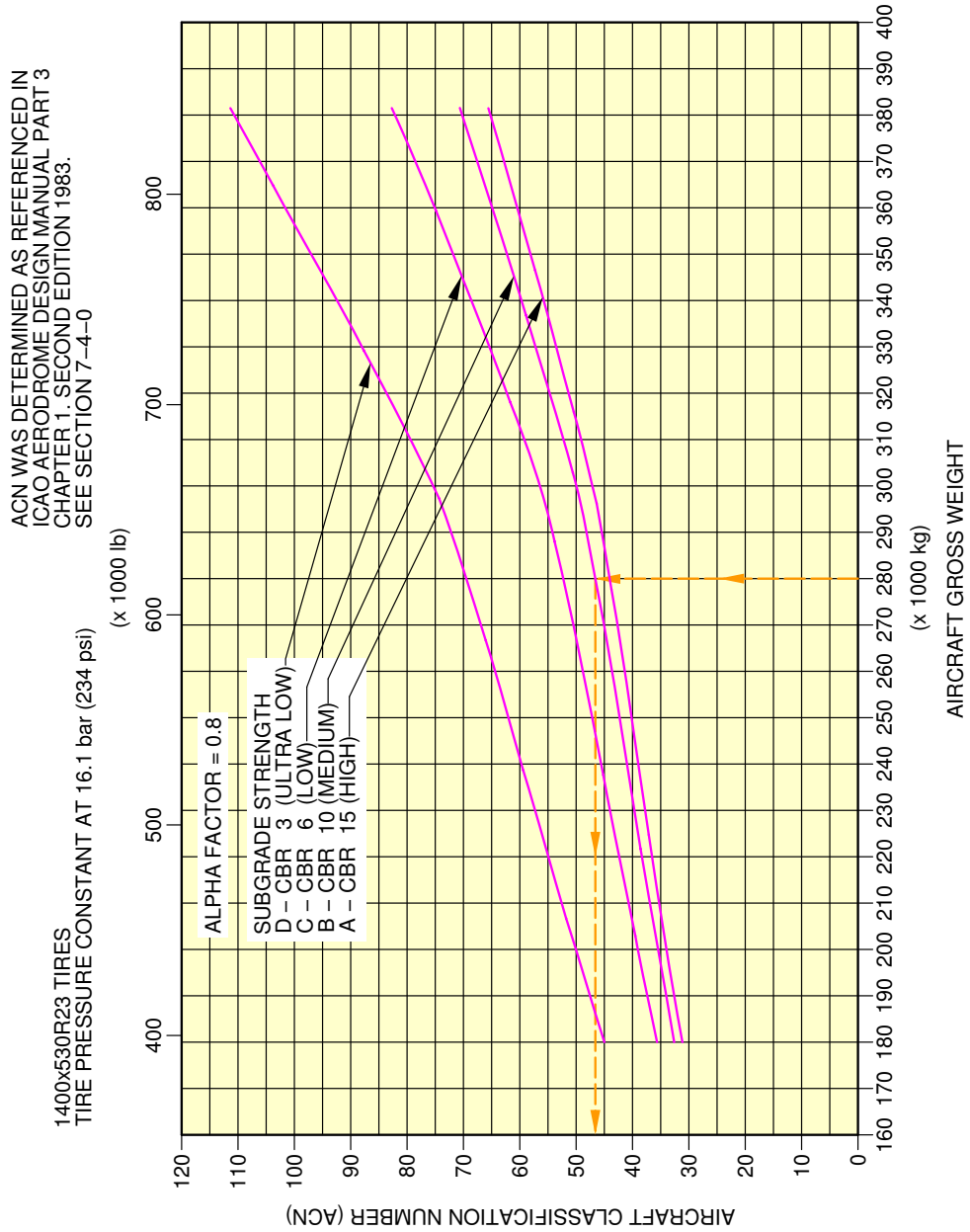

F_AC_070900_1_0190101_01_01

Aircraft Classification Number
Flexible Pavement - WV101, MRW 381 200 kg, CG 34.7% (Sheet 1 of 2)
FIGURE-7-9-0-991-019-A01

A340-500/-600

AIRCRAFT CHARACTERISTICS - AIRPORT AND MAINTENANCE PLANNING

**ON A/C A340-500

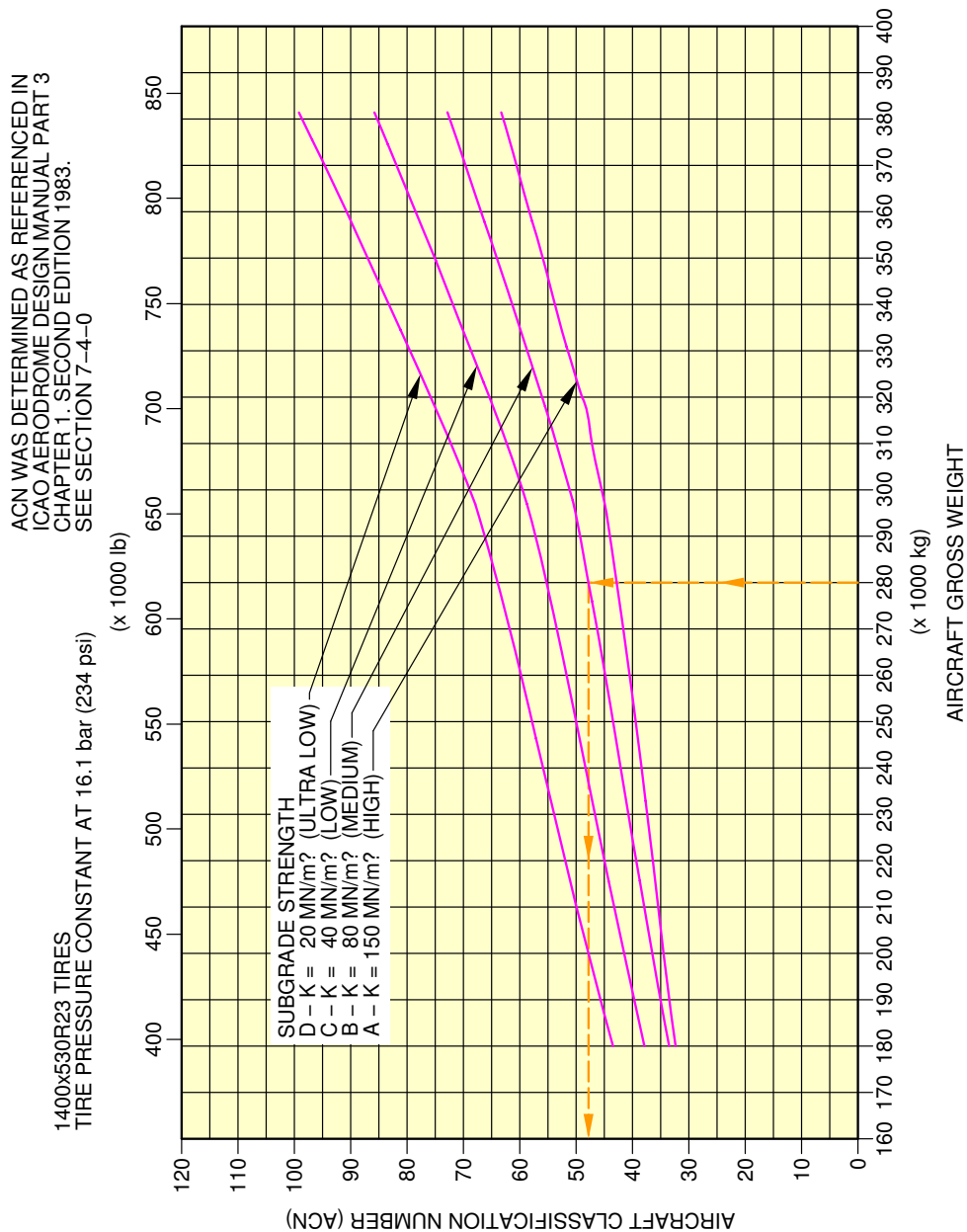

F_AC_070900_1_0190102_01_00

Aircraft Classification Number
Rigid Pavement - WV101, MRW 381 200 kg, CG 34.7% (Sheet 2 of 2)
FIGURE-7-9-0-991-019-A01

A340-500/-600

AIRCRAFT CHARACTERISTICS - AIRPORT AND MAINTENANCE PLANNING

****ON A/C A340-600**

AIRCRAFT TYPE	ALL UP MASS (kg)	LOAD ON ONE MAIN GEAR LEG (%)	TIRE PRESSURE (Mpa)	ACN FOR RIGID PAVEMENT SUBGRADES – MN/m?				ACN FOR FLEXIBLE PAVEMENT SUBGRADES – CBR			
				High 150	Medium 80	Low 40	Ultra-low 20	High 15	Medium 10	Low 6	Ultra-low 3
A340-600 WV000	366 200	32.2	1.61	61	71	83	96	64	69	80	108
	180 000	37.5		33	35	40	46	33	34	37	47
A340-600 WV001	369 200	32.2	1.61	62	71	84	97	64	69	81	109
	180 000	37.5		33	35	40	45	32	34	37	47
A340-600 WV101	381 200	31.7	1.61	64	73	86	100	66	71	83	112
	180 000	36.3		32	34	38	44	31	33	36	45
A340-600 WV102	369 200	32.0	1.61	62	71	83	96	64	69	80	108
	180 000	36.6		33	34	38	44	32	33	36	46
A340-600 WV103	366 200	32.0	1.61	61	70	83	95	63	68	79	107
	180 000	36.6		33	34	38	44	32	33	36	46

F_AC_070900_1_0070101_01_00

Aircraft Classification Number
ACN Table
FIGURE-7-9-0-991-007-A01

A340-500/-600

AIRCRAFT CHARACTERISTICS - AIRPORT AND MAINTENANCE PLANNING

**ON A/C A340-600

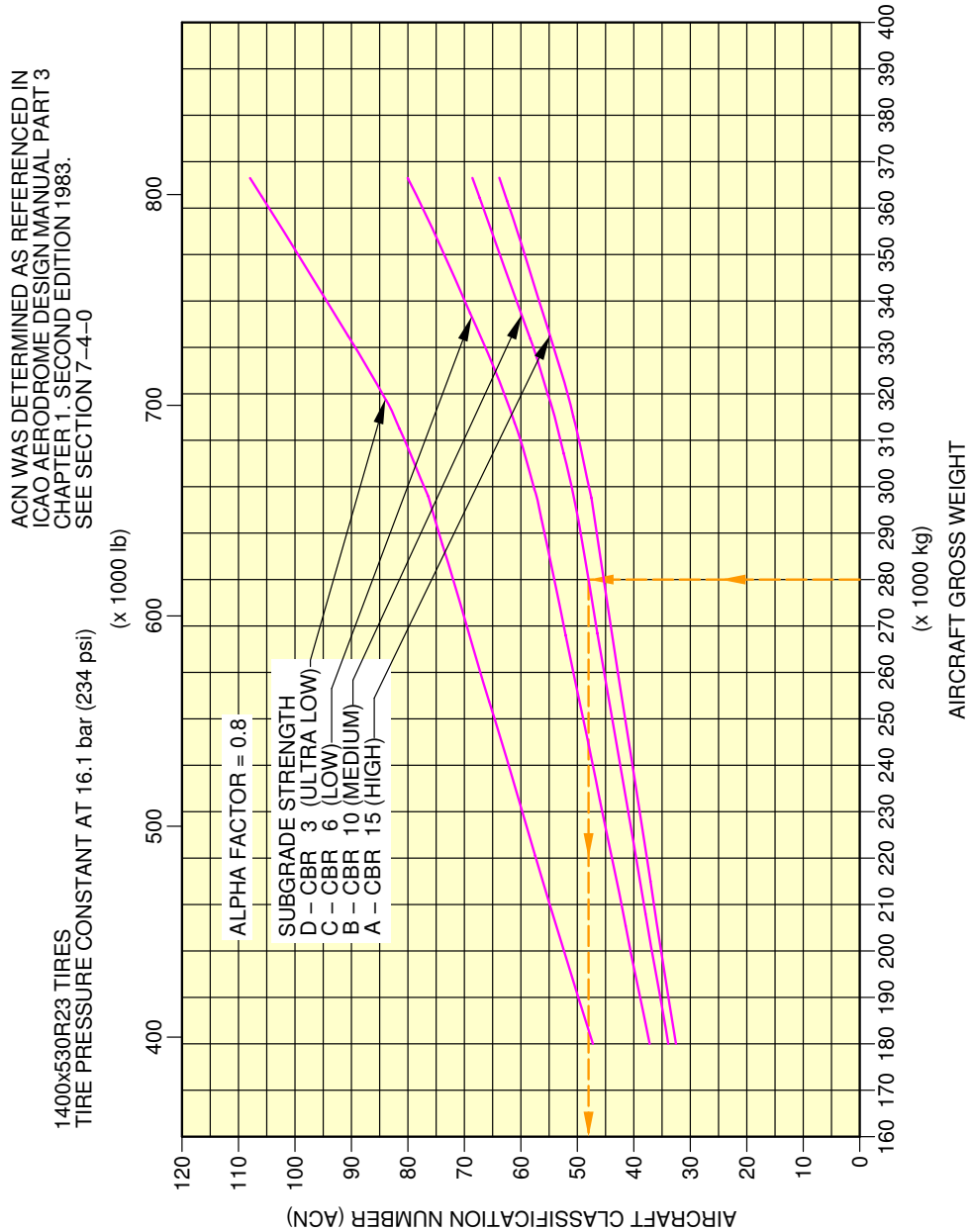

F_AC_070900_1_0200101_01_00

Aircraft Classification Number
Flexible Pavement - WV000, MRW 366 200 kg, CG 35% (Sheet 1 of 2)
FIGURE-7-9-0-991-020-A01

A340-500/-600

AIRCRAFT CHARACTERISTICS - AIRPORT AND MAINTENANCE PLANNING

**ON A/C A340-600

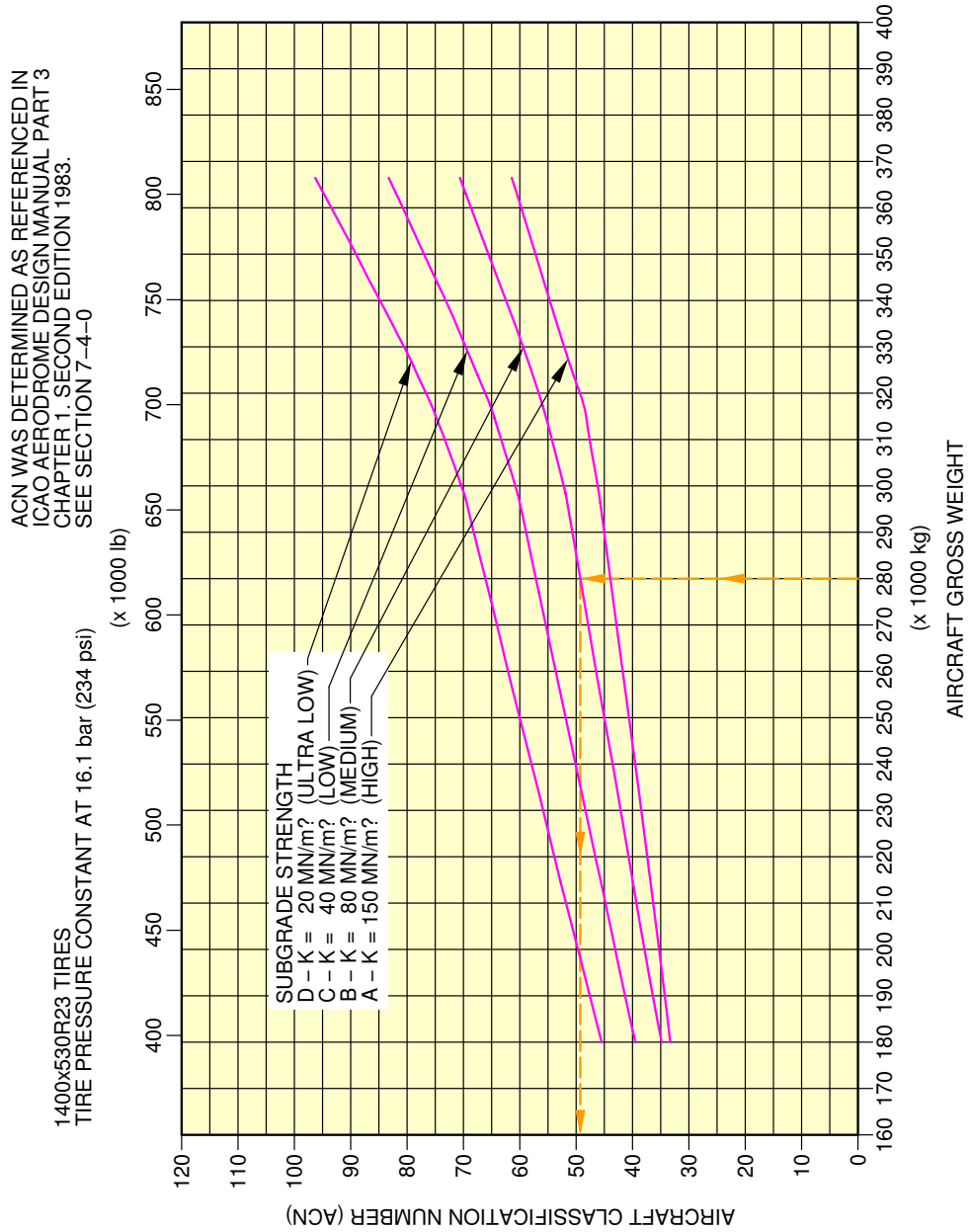

F_AC_070900_1_0200102_01_00

Aircraft Classification Number
Rigid Pavement - WV000, MRW 366 200 kg, CG 35% (Sheet 2 of 2)
FIGURE-7-9-0-991-020-A01

A340-500/-600

AIRCRAFT CHARACTERISTICS - AIRPORT AND MAINTENANCE PLANNING

**ON A/C A340-600

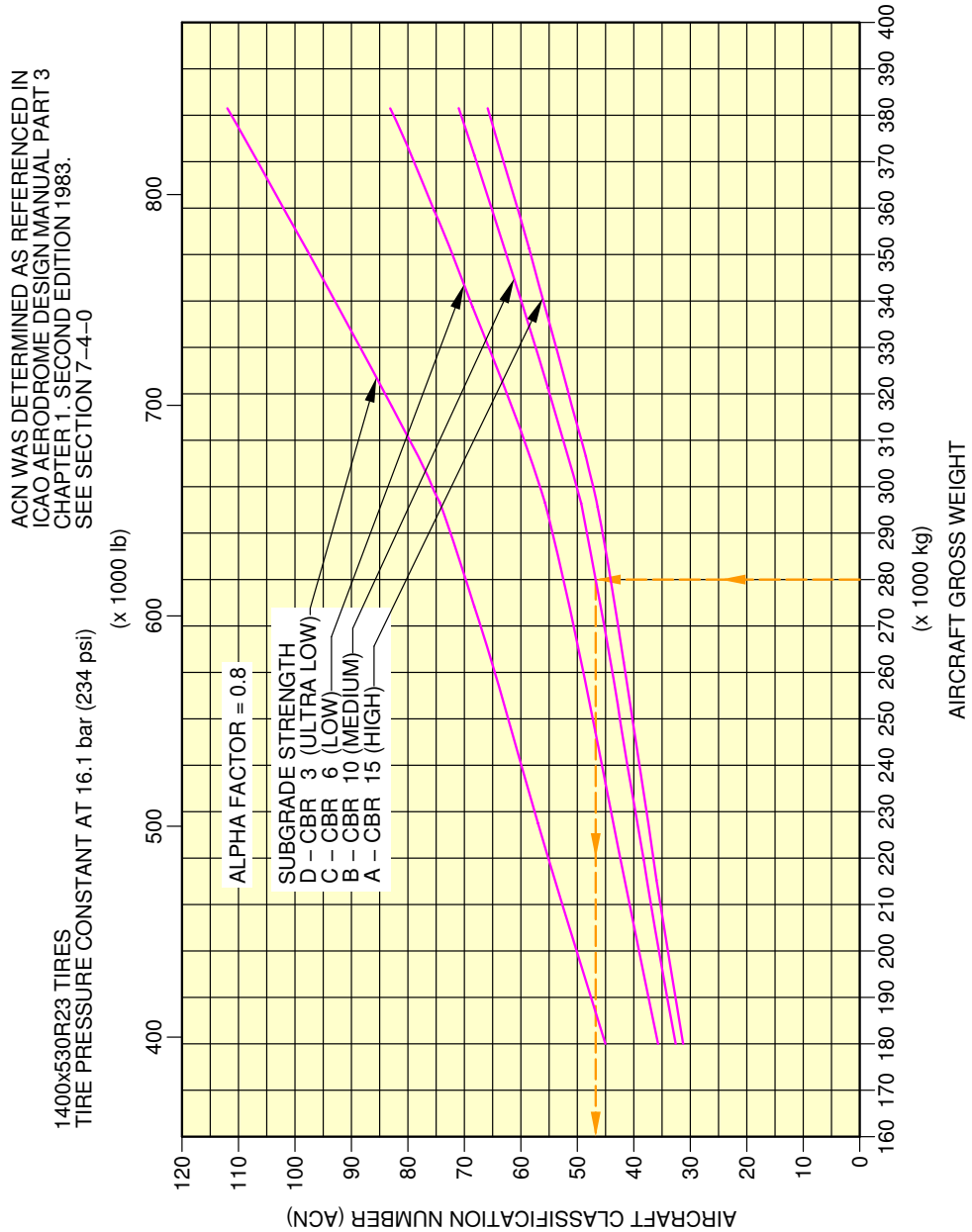

F_AC_070900_1_0210101_01_00

Aircraft Classification Number
Flexible Pavement - WV101, MRW 381 200 kg, CG 30.2% (Sheet 1 of 2)
FIGURE-7-9-0-991-021-A01

A340-500/-600

AIRCRAFT CHARACTERISTICS - AIRPORT AND MAINTENANCE PLANNING

**ON A/C A340-600

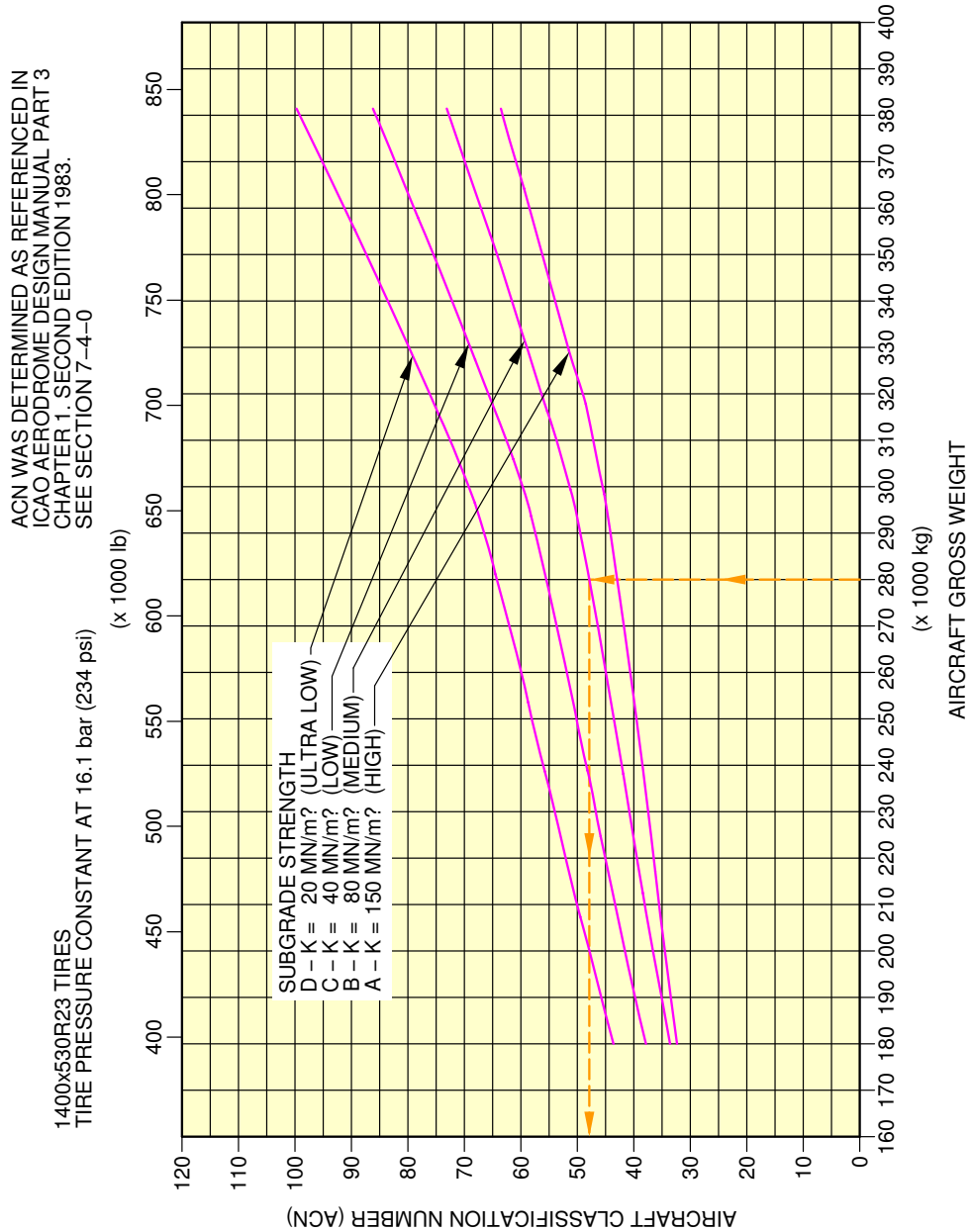

F_AC_070900_1_0210102_01_00

Aircraft Classification Number
Rigid Pavement - WV101, MRW 381 200 kg, CG 30.2% (Sheet 2 of 2)
FIGURE-7-9-0-991-021-A01

SCALED DRAWINGS

8-0-0 SCALED DRAWINGS

****ON A/C A340-500 A340-600**

Scaled Drawings

1. This section provides the scaled drawings.

NOTE : When printing this drawing, make sure to adjust for proper scaling.

A340-500/-600

AIRCRAFT CHARACTERISTICS - AIRPORT AND MAINTENANCE PLANNING

****ON A/C A340-500**

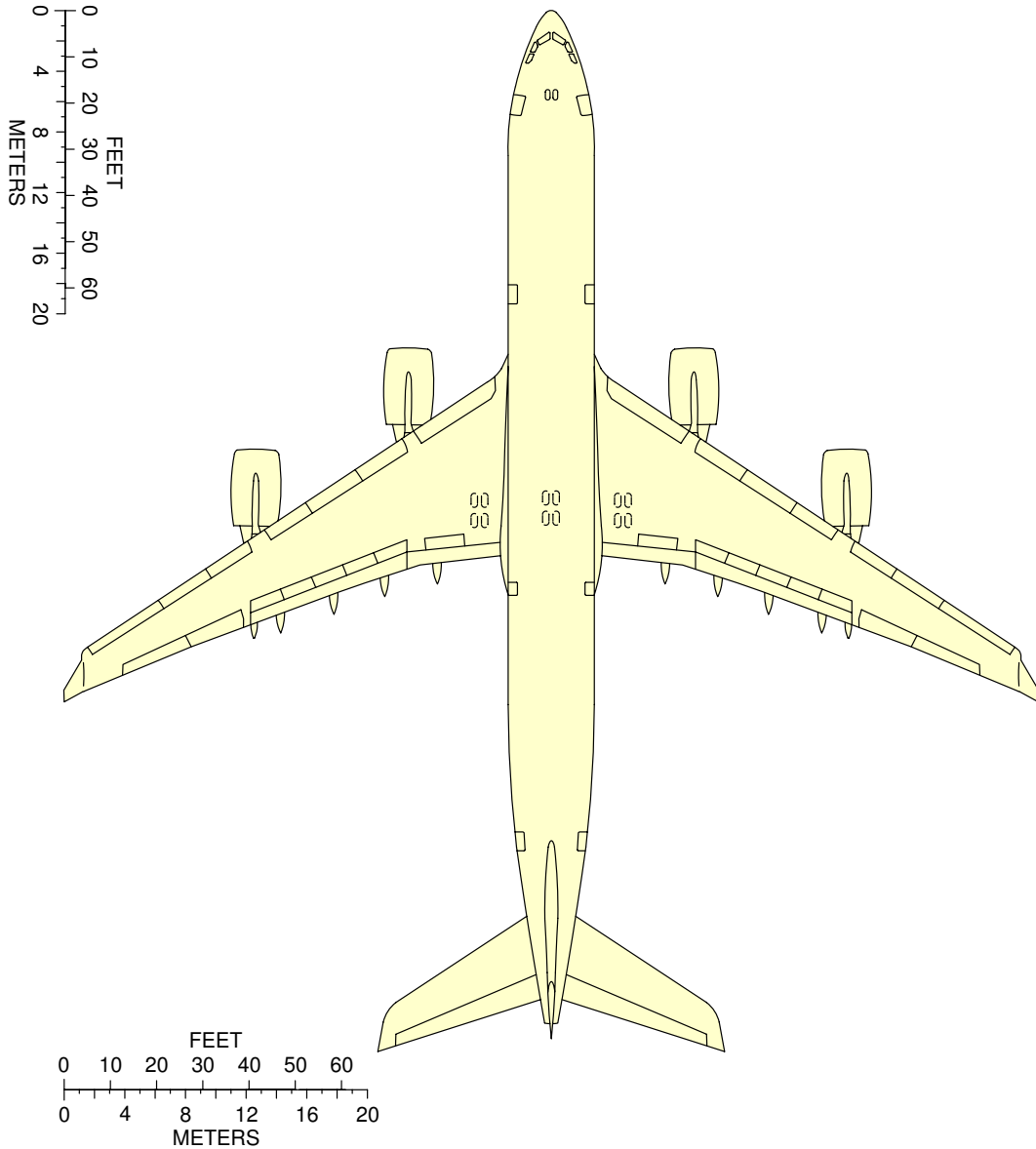

NOTE:

WHEN PRINTING THIS DRAWING, MAKE SURE TO ADJUST FOR PROPER SCALING.

F_AC_080000_1_0040101_01_01

Scaled Drawing
FIGURE-8-0-0-991-004-A01

A340-500/-600

AIRCRAFT CHARACTERISTICS - AIRPORT AND MAINTENANCE PLANNING

****ON A/C A340-600**

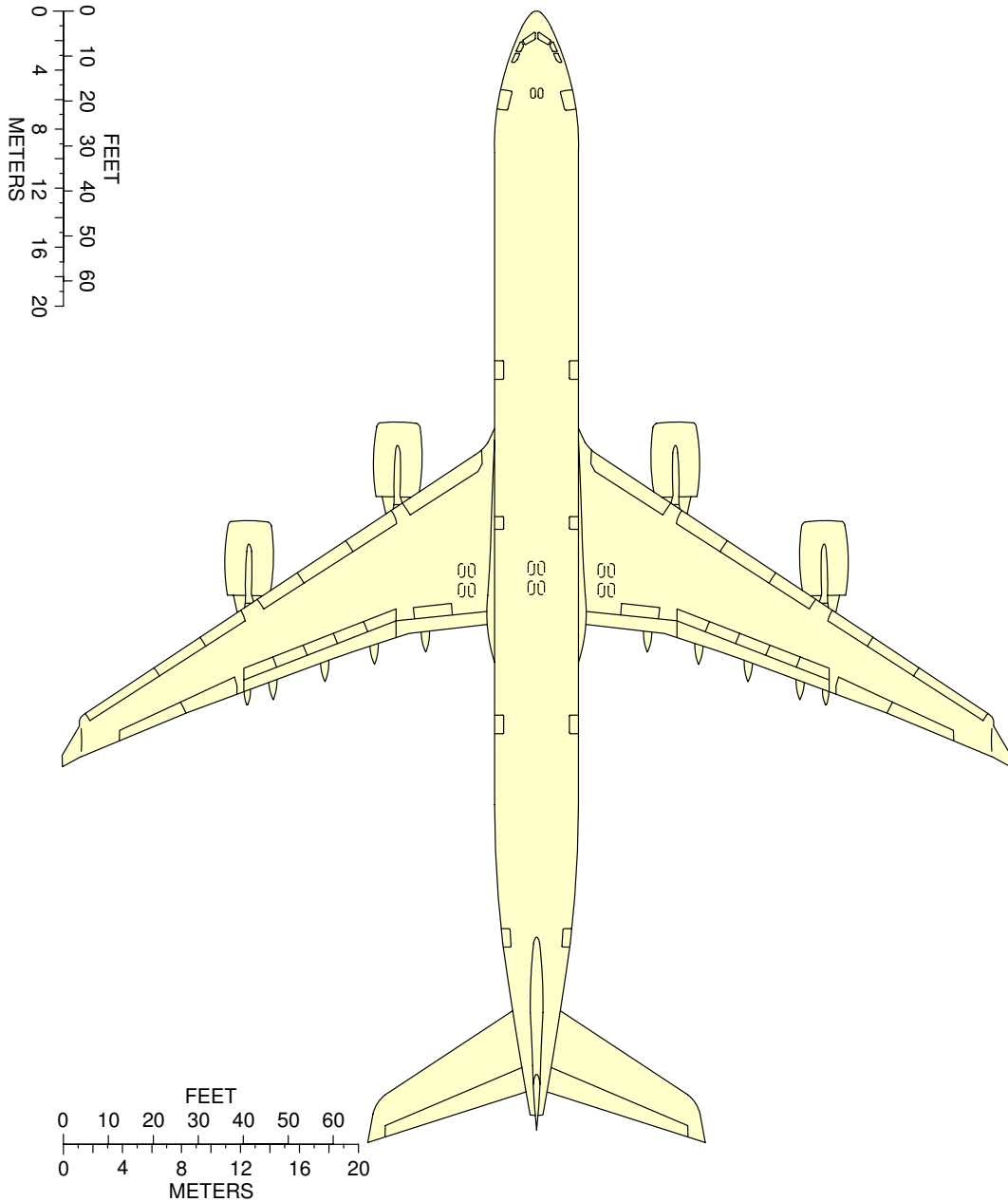

NOTE:

WHEN PRINTING THIS DRAWING, MAKE SURE TO ADJUST FOR PROPER SCALING.

F_AC_080000_1_0040201_01_01

Scaled Drawing
FIGURE-8-0-0-991-004-B01

AIRCRAFT RESCUE AND FIRE FIGHTING**10-0-0 AIRCRAFT RESCUE AND FIRE FIGHTING******ON A/C A340-500****Aircraft Rescue and Fire Fighting****1. Aircraft Rescue and Fire Fighting Charts**

This sections provides data related to aircraft rescue and fire fighting.

The figures contained in this section are the figures that are in the Aircraft Rescue and Fire Fighting Charts poster available for download on AIRBUSWorld and the Airbus website.

**ON A/C A340-500

AIRBUS

A340-500

Aircraft Rescue and Fire Fighting Chart ARFC

NOTE:

THIS CHART GIVES THE GENERAL LAYOUT OF THE A340-500 STANDARD VERSION.
THE NUMBER AND ARRANGEMENT OF THE INDIVIDUAL ITEMS VARY WITH THE CUSTOMERS.
FIGURES CONTAINED IN THIS POSTER ARE AVAILABLE SEPARATLY IN THE CHAPTER 10 OF THE
"AIRCRAFT CHARACTERISTICS - AIRPORT AND MAINTENANCE PLANNING" DOCUMENT.

ISSUED BY:
AIRBUS S.A.S
CUSTOMER SERVICES
TECHNICAL DATA SUPPORT AND SERVICES
31707 BLAGNAC CEDEX
FRANCE

REVISION DATE: JANUARY 2017
REFERENCE : F_RF_000000_1_A340500
SHEET 1/2

© AIRBUS S.A.S. 2013 . All rights reserved.

F_AC_100000_1_0400101_01_03

Front Page
FIGURE-10-0-0-991-040-A01

**ON A/C A340-500

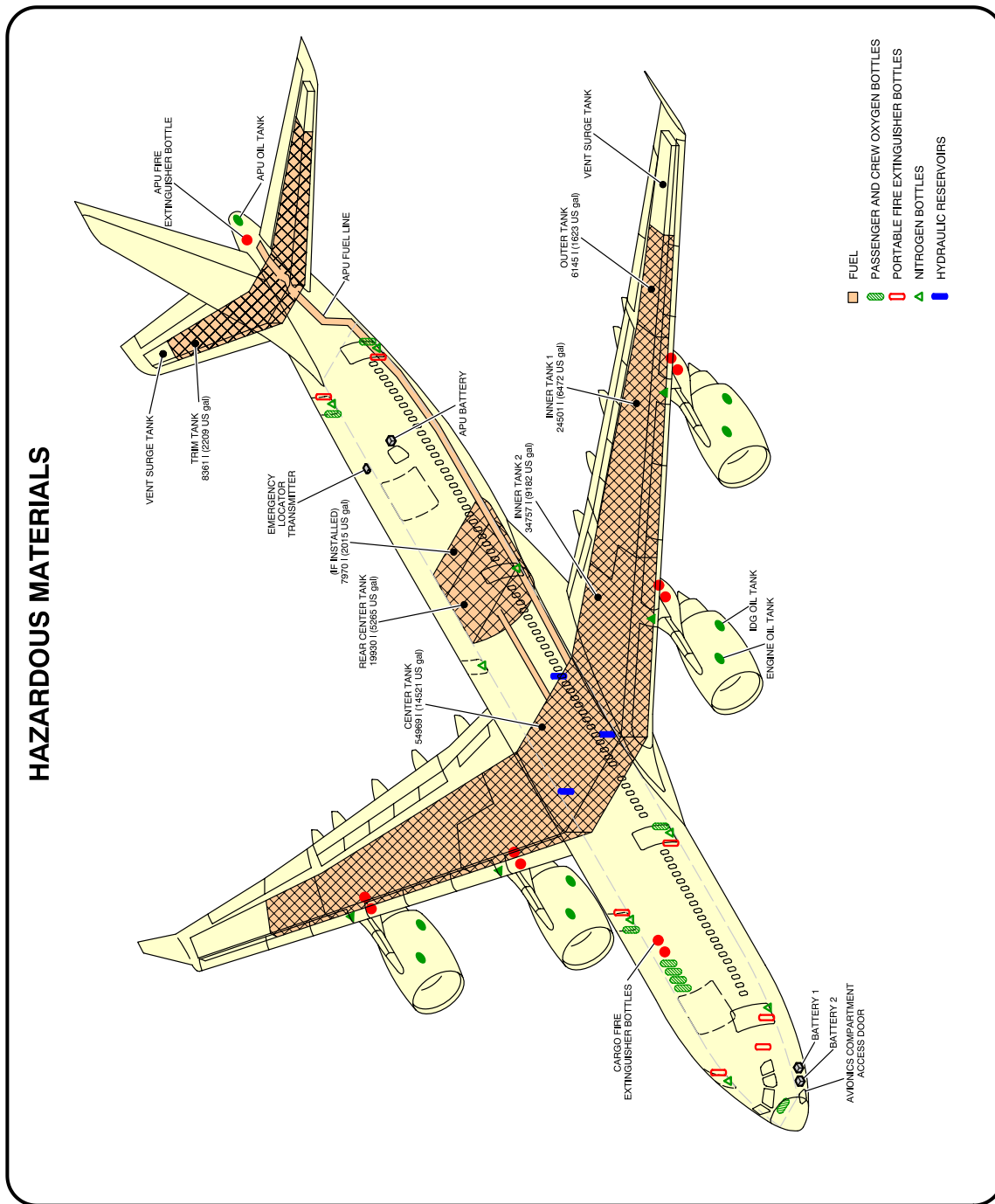

F_AC_100000_1_0410101_01_01

Highly Flammable and Hazardous Materials and Components
FIGURE-10-0-0-991-041-A01

A340-500/-600

AIRCRAFT CHARACTERISTICS - AIRPORT AND MAINTENANCE PLANNING

**ON A/C A340-500

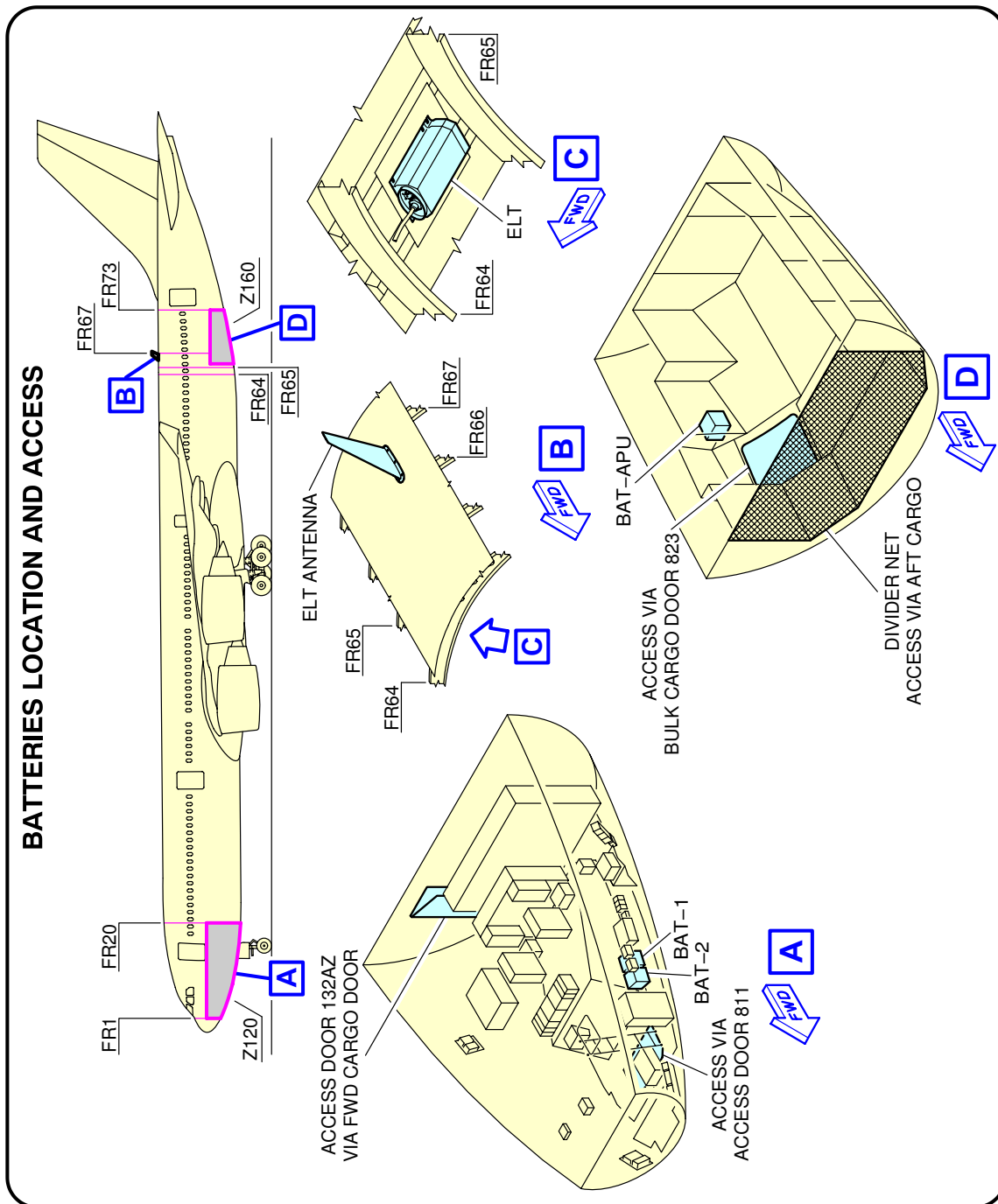

F_AC_100000_1_0700101_01_01

Batteries Location and Access
FIGURE-10-0-0-991-070-A01

A340-500/-600

AIRCRAFT CHARACTERISTICS - AIRPORT AND MAINTENANCE PLANNING

**ON A/C A340-500

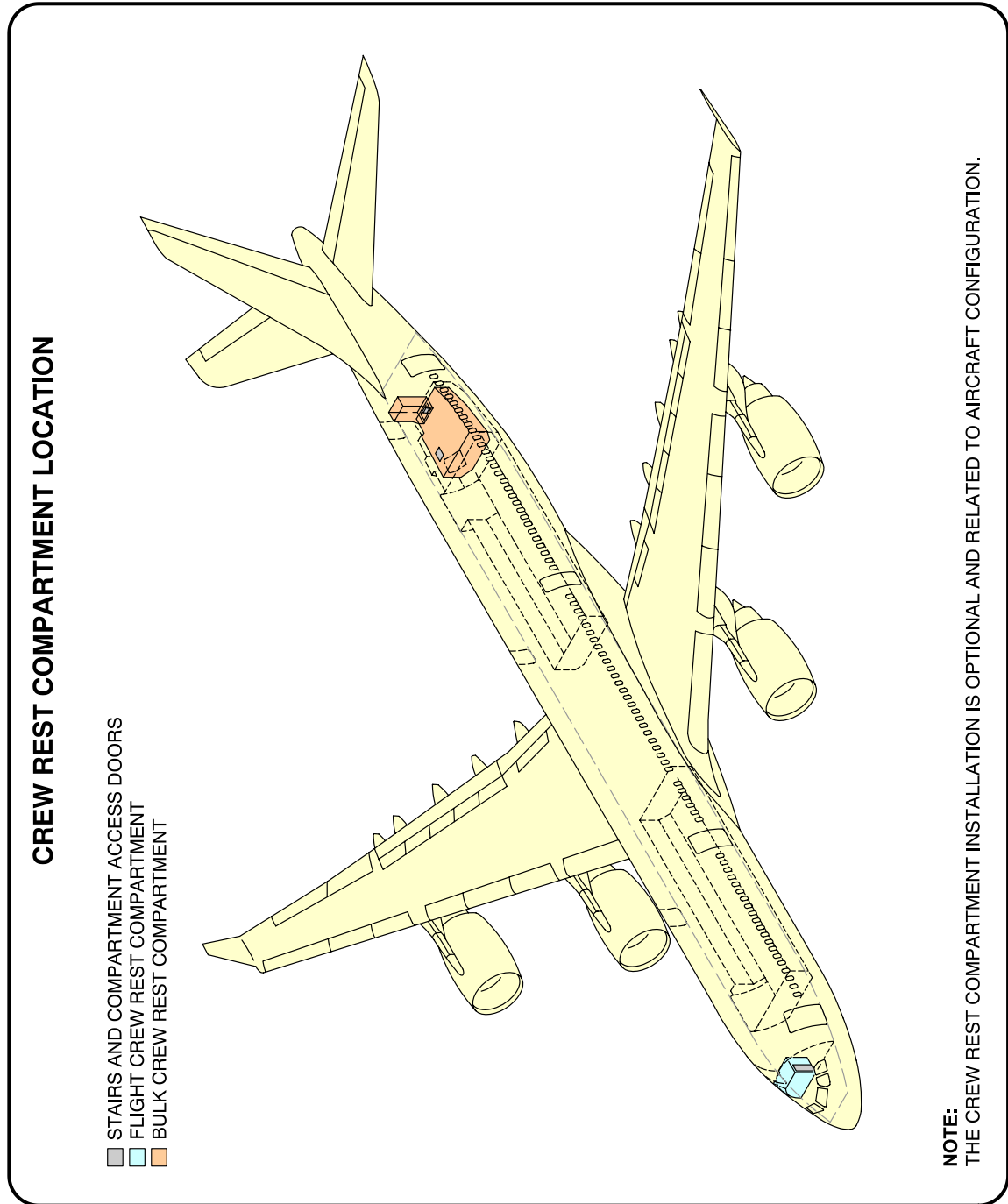

F_AC_100000_1_0420101_01_00

Crew Rest Compartments Location
FIGURE-10-0-0-991-042-A01

**ON A/C A340-500

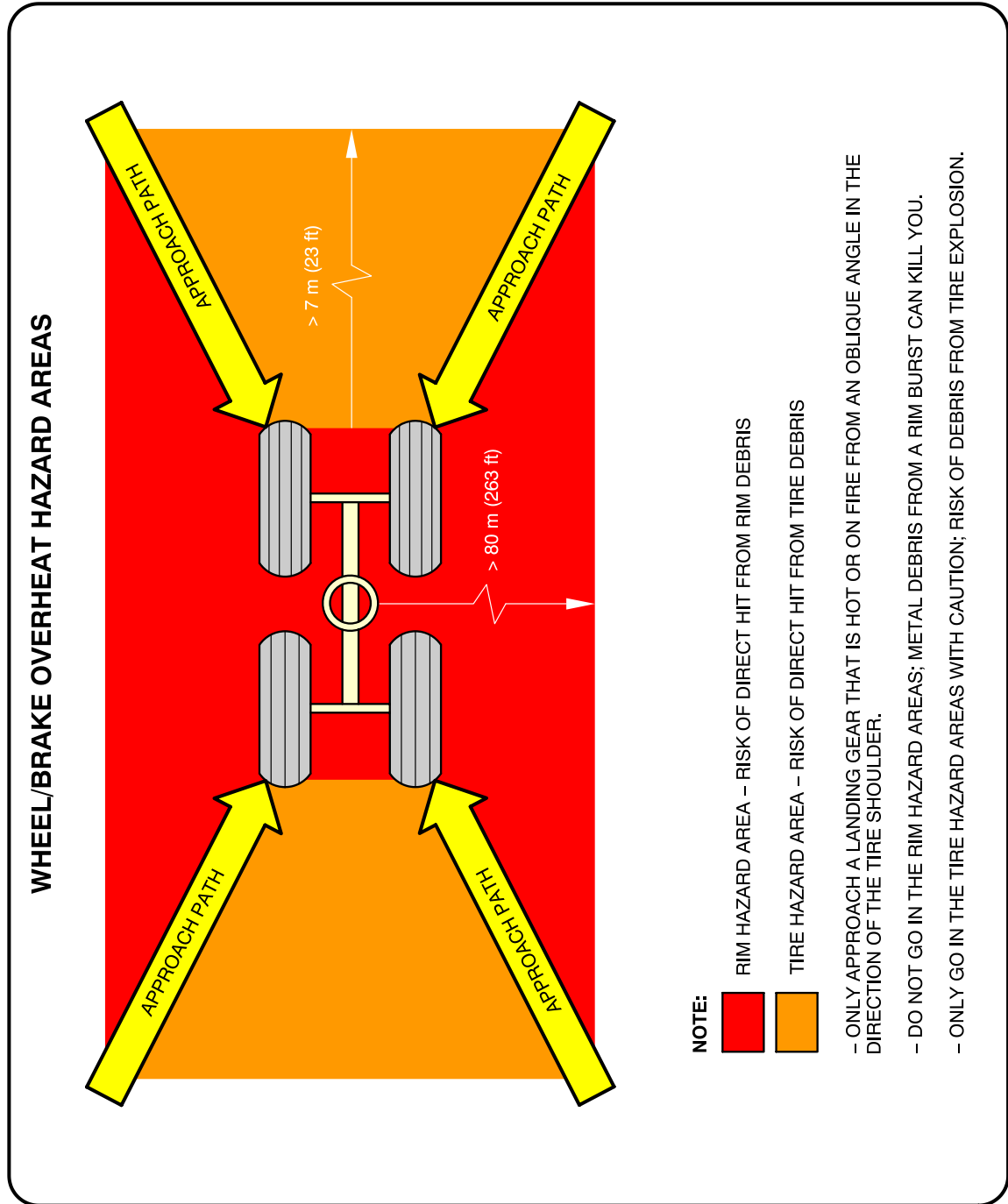

F_AC_100000_1_0430101_01_00

Wheel/Brake Overheat
Wheel Safety Area (Sheet 1 of 2)
FIGURE-10-0-0-991-043-A01

**ON A/C A340-500

BRAKE OVERHEAT AND LANDING GEAR FIRE

WARNING: BE VERY CAREFUL WHEN THERE IS A BRAKE OVERHEAT AND/OR LANDING GEAR FIRE. THERE IS A RISK OF TIRE EXPLOSION AND/OR WHEEL RIM BURST THAT CAN CAUSE DEATH OR INJURY. MAKE SURE THAT YOU OBEY THE SAFETY PRECAUTIONS THAT FOLLOW.

THE PROCEDURES THAT FOLLOW GIVE RECOMMENDATIONS AND SAFETY PRECAUTIONS FOR THE COOLING OF VERY HOT BRAKES AFTER ABNORMAL OPERATIONS SUCH AS A REJECTED TAKE-OFF OR OVERWEIGHT LANDING. FOR THE COOLING OF BRAKES AFTER NORMAL TAXI-IN, REFER TO YOUR COMPANY PROCEDURES.

BRAKE OVERHEAT:

1 – GET THE BRAKE TEMPERATURE FROM THE COCKPIT OR USE A REMOTE MEASUREMENT TECHNIQUE. THE REAL TEMPERATURE OF THE BRAKES CAN BE MUCH HIGHER THAN THE TEMPERATURE SHOWN ON THE ECAM.
NOTE: AT HIGH TEMPERATURES (>800°C), THERE IS A RISK OF WARPING OF THE LANDING GEAR STRUTS AND AXLES.

2 – APPROACH THE LANDING GEAR WITH EXTREME CAUTION AND FROM AN OBLIQUE ANGLE IN THE DIRECTION OF THE TIRE SHOULDER. DO NOT GO INTO THE RIM HAZARD AREA AND ONLY GO IN THE TIRE HAZARD AREA WITH CAUTION. (REF FIG. WHEEL/BRAKE OVERHEAT HAZARD AREAS). IF POSSIBLE, STAY IN A VEHICLE.

3 – LOOK AT THE CONDITION OF THE TIRES:
IF THE TIRES ARE STILL INFLATED (FUSE PLUGS NOT MELTED), THERE IS A RISK OF TIRE EXPLOSION AND RIM BURST. DO NOT USE COOLING FANS BECAUSE THEY CAN PREVENT OPERATION OF THE FUSE PLUGS.

4 – USE WATER MIST TO DECREASE THE TEMPERATURE OF THE COMPLETE WHEEL AND BRAKE ASSEMBLY. USE A TECHNIQUE THAT PREVENTS SUDDEN COOLING. SUDDEN COOLING CAN CAUSE WHEEL CRACKS OR RIM BURST. DO NOT APPLY WATER, FOAM OR CO₂. THESE COOLING AGENTS (AND ESPECIALLY CO₂, WHICH HAS A VERY STRONG COOLING EFFECT) CAN CAUSE THERMAL SHOCKS AND BURST OF HOT PARTS.

LANDING GEAR FIRE:

CAUTION: AIRBUS RECOMMENDS THAT YOU DO NOT USE DRY POWDERS OR DRY CHEMICALS ON HOT BRAKES OR TO EXTINGUISH LANDING GEAR FIRES. THESE AGENTS CAN CHANGE INTO SOLID OR ENAMELED DEPOSITS. THEY CAN DECREASE THE SPEED OF HEAT DISSIPATION WITH A POSSIBLE RISK OF PERMANENT STRUCTURAL DAMAGE TO THE BRAKES, WHEELS OR WHEEL AXLES.

1 – IMMEDIATELY STOP THE FIRE:

A) APPROACH THE LANDING GEAR WITH EXTREME CAUTION FROM AN OBLIQUE ANGLE IN THE DIRECTION OF THE TIRE SHOULDER. DO NOT GO INTO THE RIM HAZARD AREA AND ONLY GO IN THE TIRE HAZARD AREA WITH CAUTION. IF POSSIBLE, STAY IN A VEHICLE.

B) USE LARGE AMOUNTS OF WATER, WATER MIST; IF THE FUEL TANKS ARE AT RISK, USE FOAM. USE A TECHNIQUE THAT PREVENTS SUDDEN COOLING. SUDDEN COOLING CAN CAUSE WHEEL CRACKS OR RIM BURST.

C) DO NOT USE FANS OR BLOWERS.

F_AC_100000_1_0430102_01_00

Wheel/Brake Overheat
Recommendations (Sheet 2 of 2)
FIGURE-10-0-0-991-043-A01

A340-500/-600

AIRCRAFT CHARACTERISTICS - AIRPORT AND MAINTENANCE PLANNING

**ON A/C A340-500

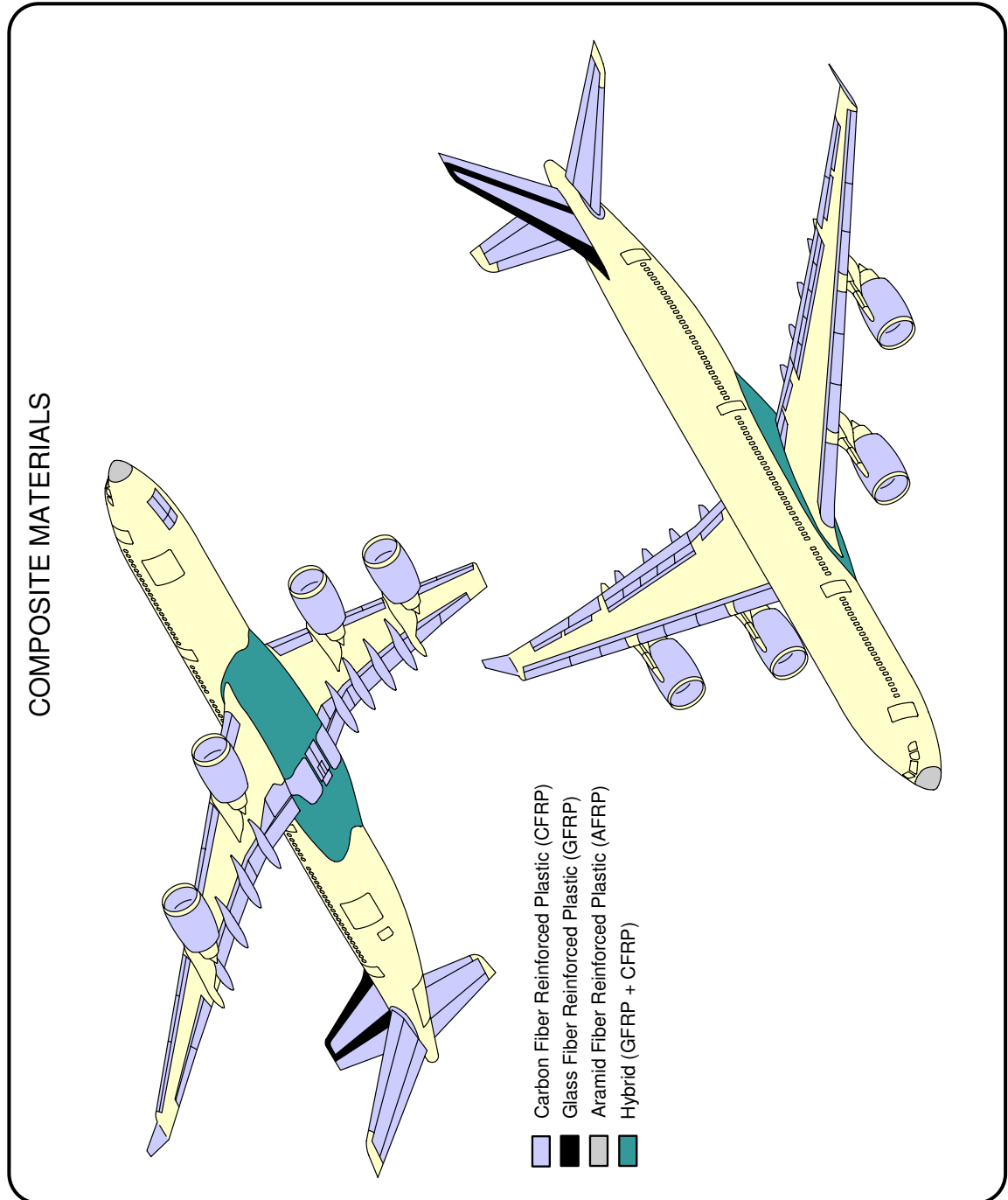

F_AC_100000_1_0440101_01_01

Composite Materials Location
FIGURE-10-0-0-991-044-A01

**ON A/C A340-500

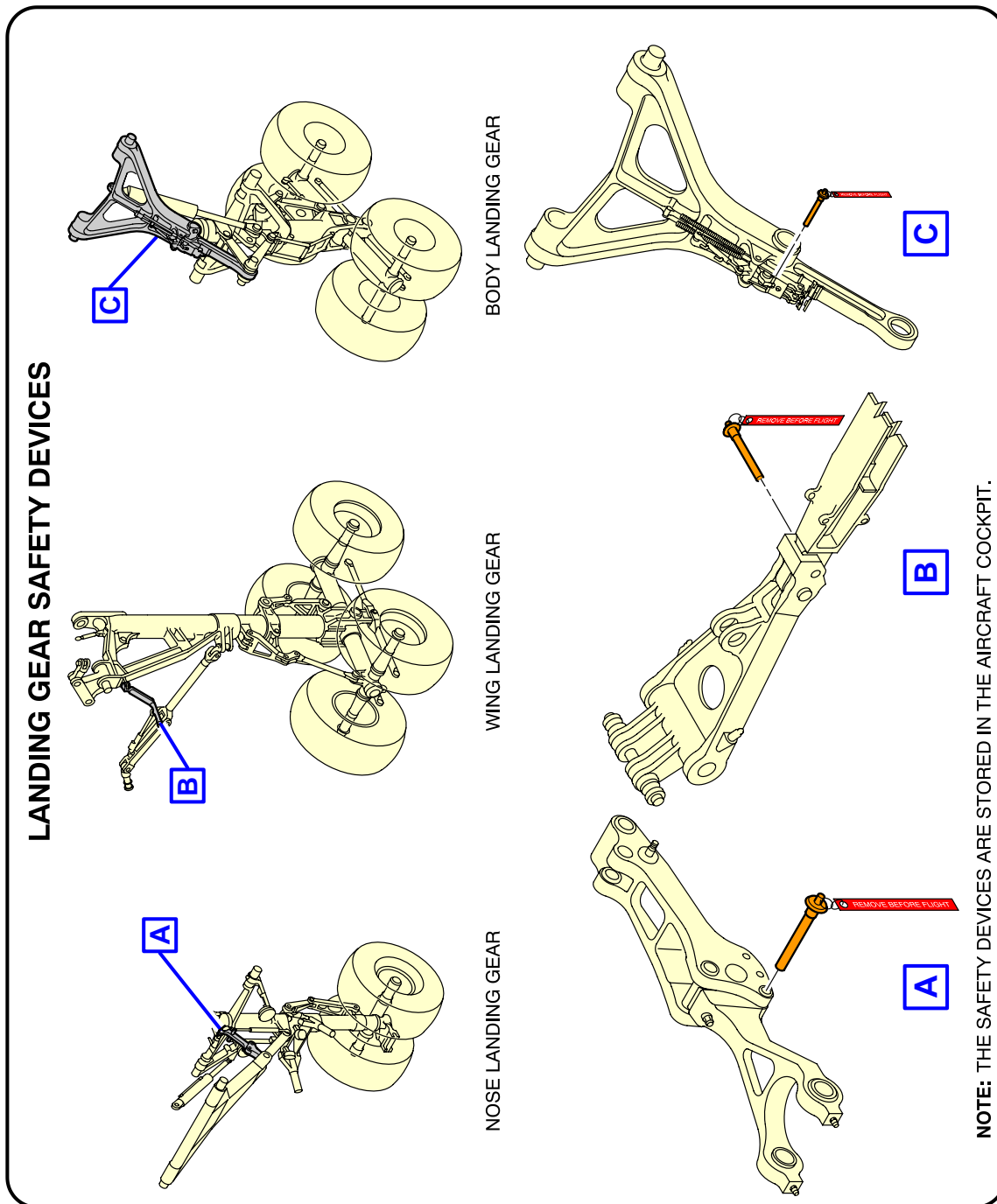

F_AC_100000_1_0450101_01_00

Ground Lock Safety Devices
FIGURE-10-0-0-991-045-A01

A340-500/-600

AIRCRAFT CHARACTERISTICS - AIRPORT AND MAINTENANCE PLANNING

**ON A/C A340-500

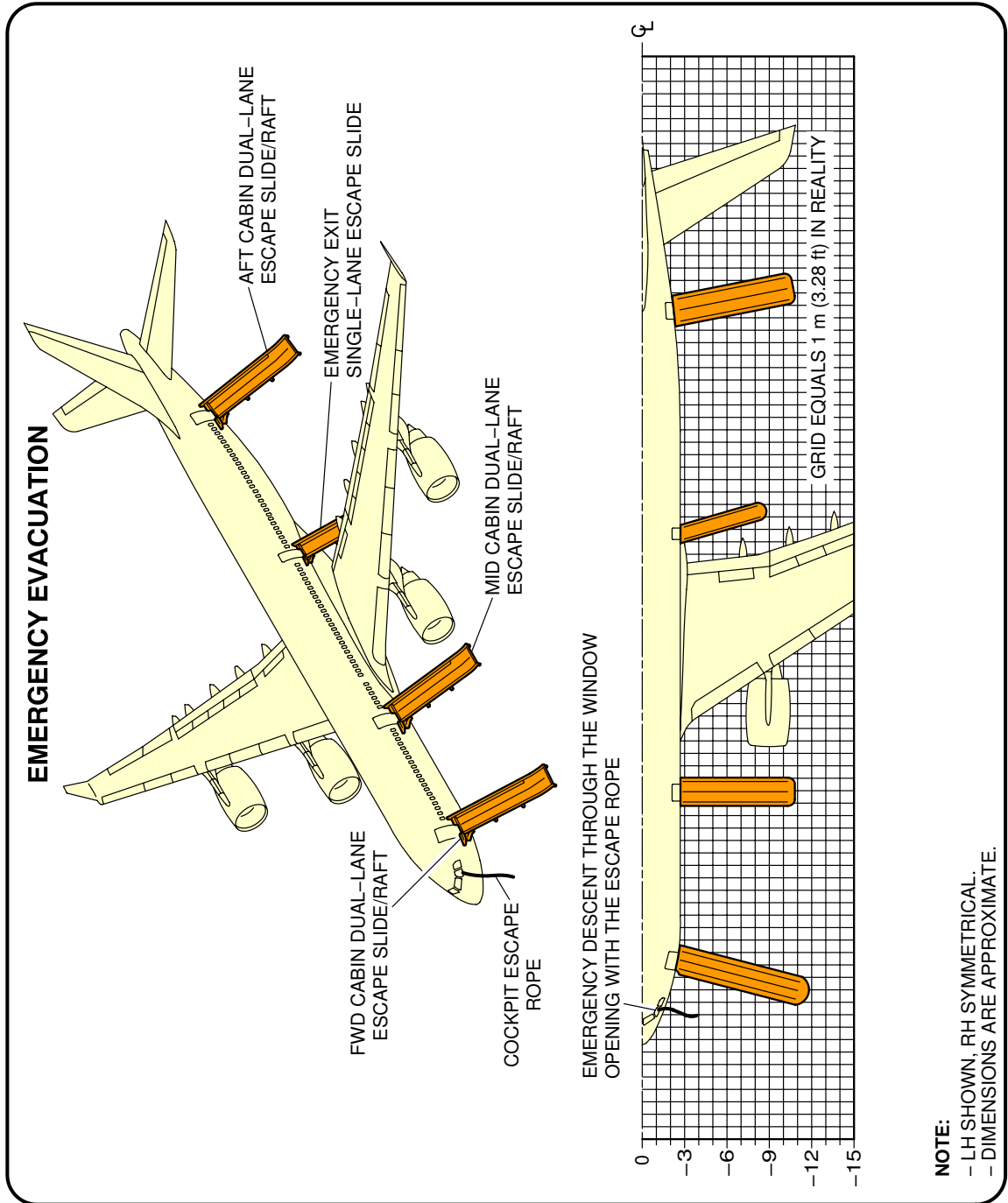

F_AC_100000_1_0460101_01_02

Emergency Evacuation Devices
 FIGURE-10-0-0-991-046-A01

**ON A/C A340-500

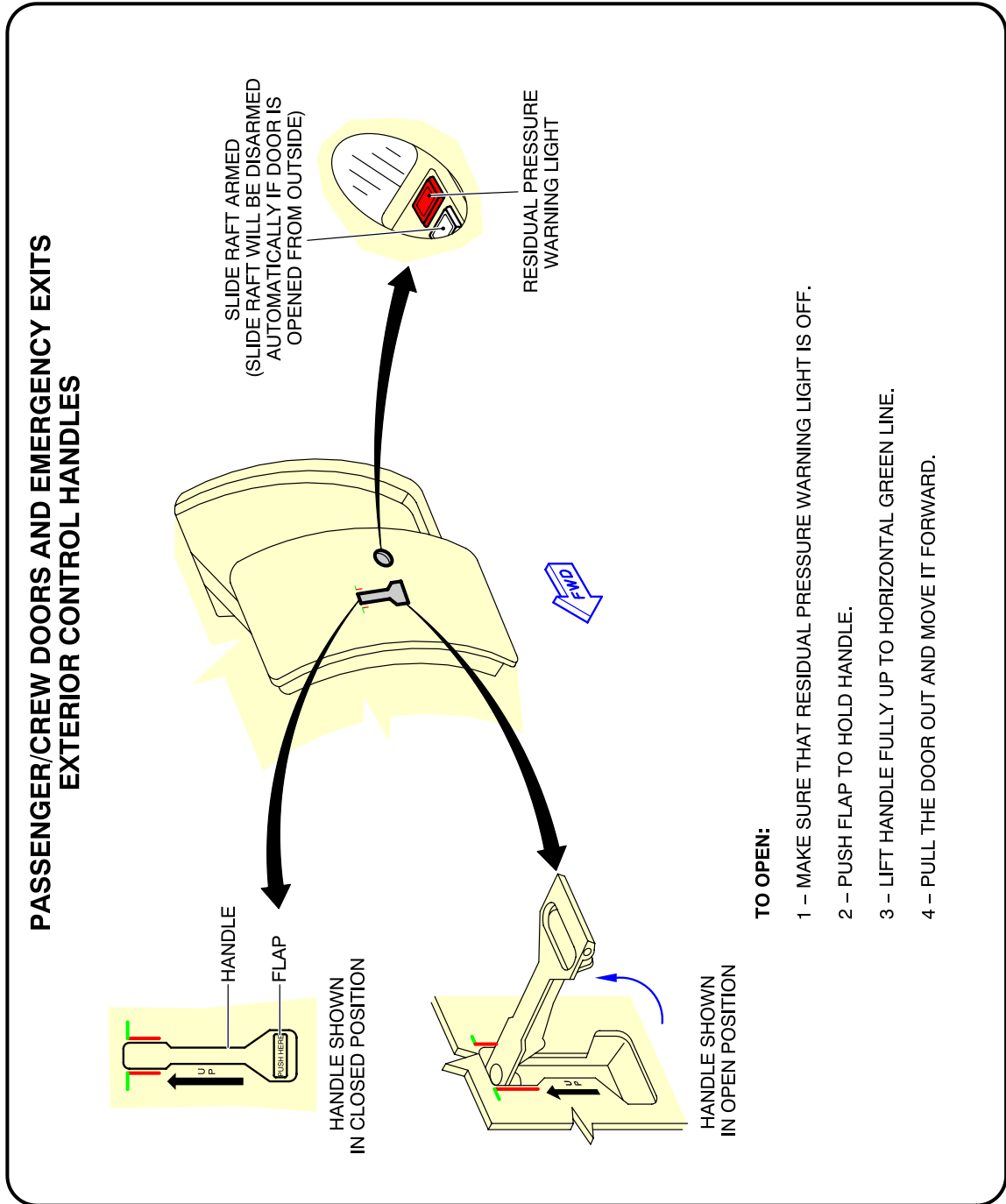

F_AC_100000_1_0470101_01_00

Pax/Crew Doors and Emergency Exits
FIGURE-10-0-0-991-047-A01

**ON A/C A340-500

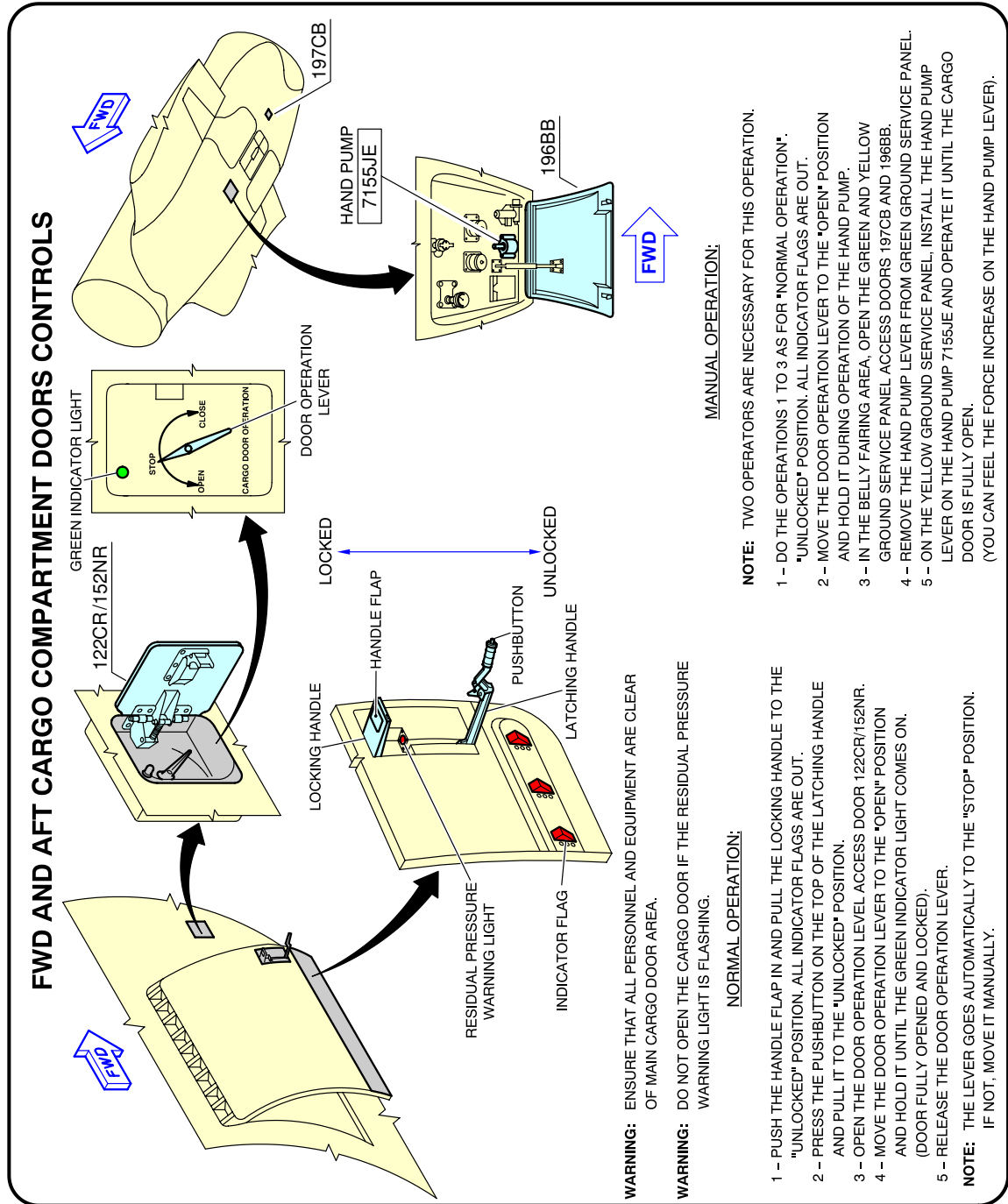

F_AC_100000_1_0480101_01_00

FWD and AFT Lower Deck Cargo Doors
FIGURE-10-0-0-991-048-A01

A340-500/-600

AIRCRAFT CHARACTERISTICS - AIRPORT AND MAINTENANCE PLANNING

**ON A/C A340-500

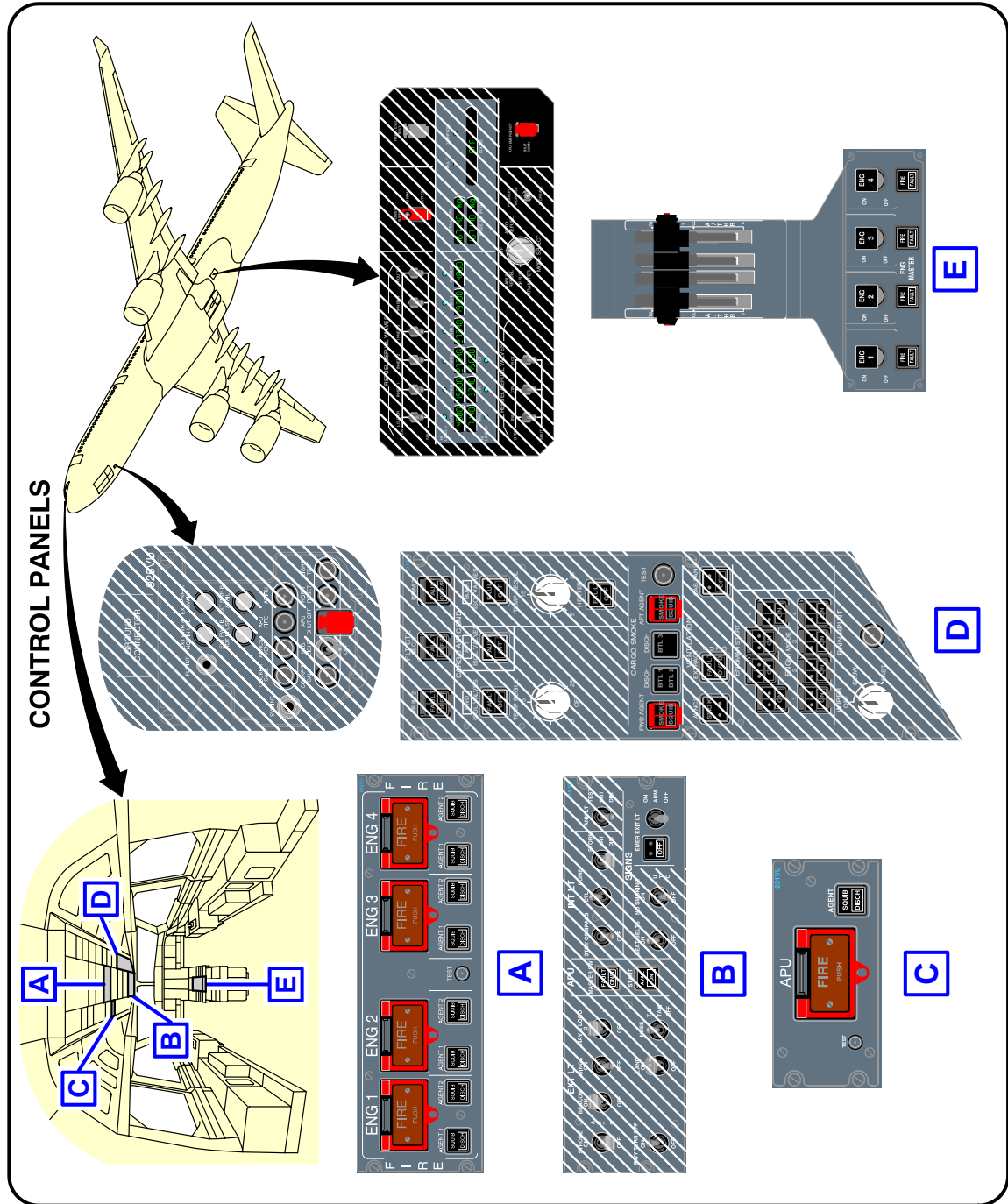

F_AC_100000_1_0490101_01_00

Control Panels
FIGURE-10-0-0-991-049-A01

**ON A/C A340-500

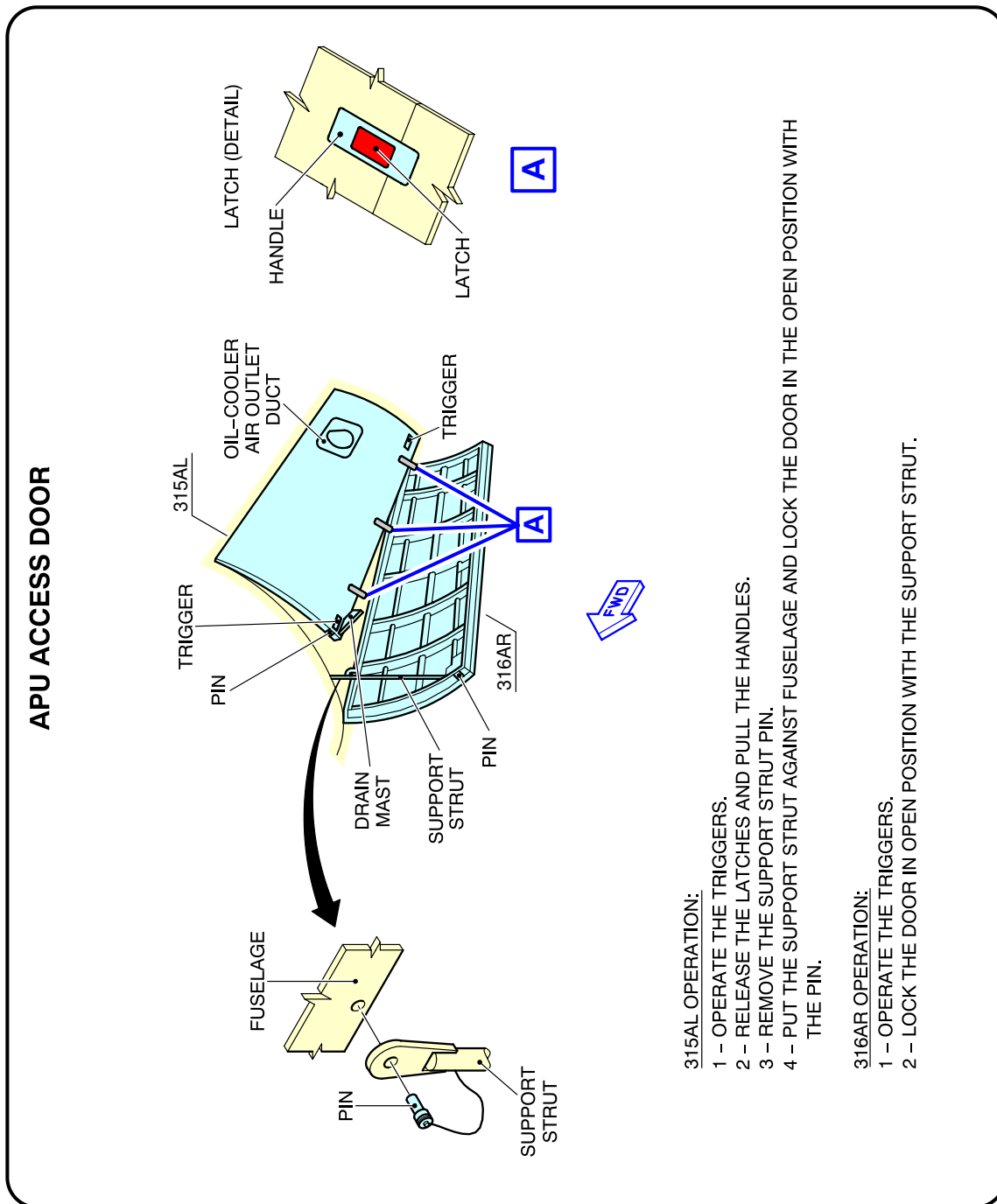

F_AC_100000_1_0500101_01_00

APU Compartment Access
FIGURE-10-0-0-991-050-A01

A340-500/-600

AIRCRAFT CHARACTERISTICS - AIRPORT AND MAINTENANCE PLANNING

**ON A/C A340-500

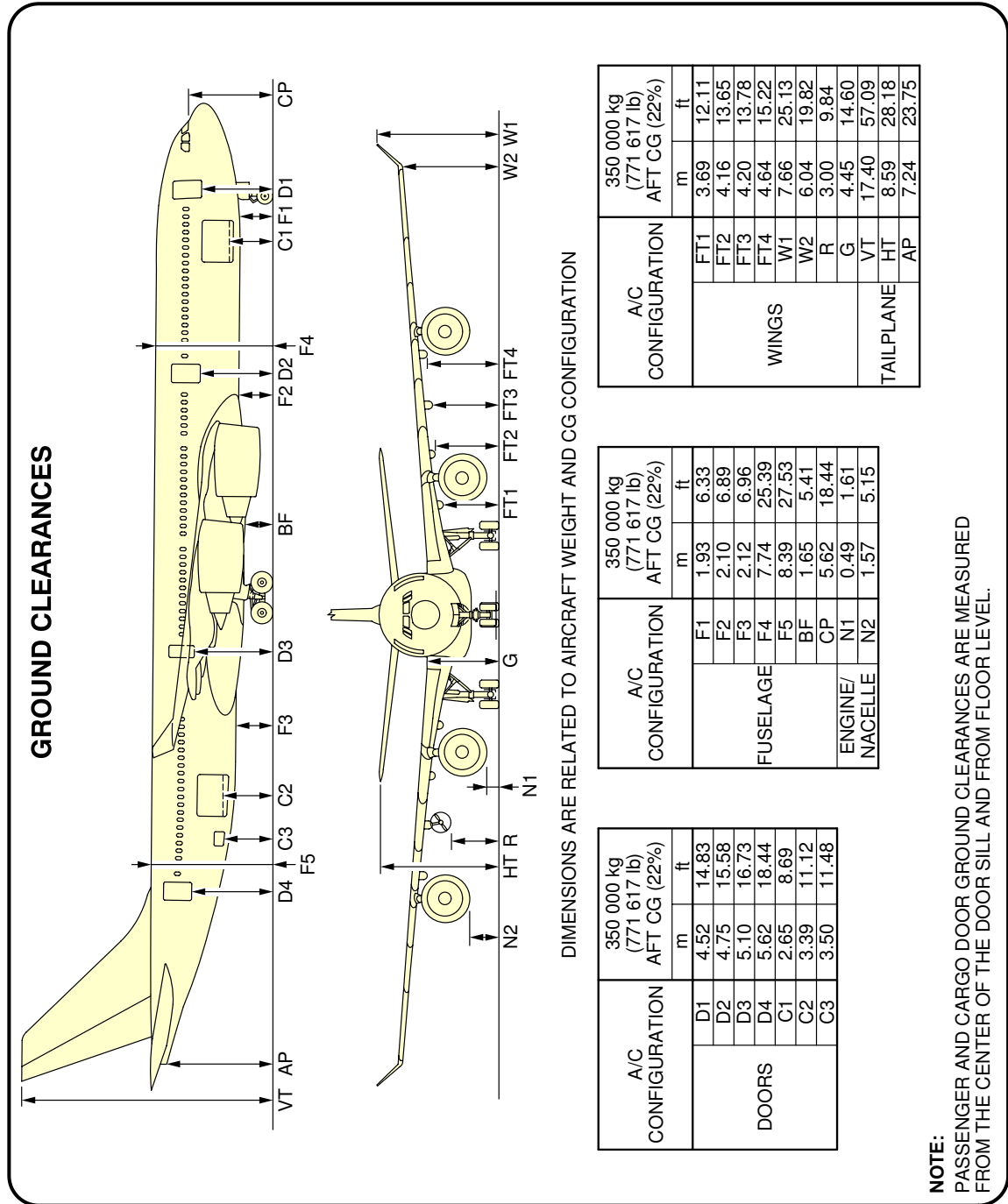

NOTE:
PASSENGER AND CARGO DOOR GROUND CLEARANCES ARE MEASURED FROM THE CENTER OF THE DOOR SILL AND FROM FLOOR LEVEL.

F_AC_100000_1_0510101_01_01

Ground Clearances
FIGURE-10-0-0-991-051-A01

**ON A/C A340-500

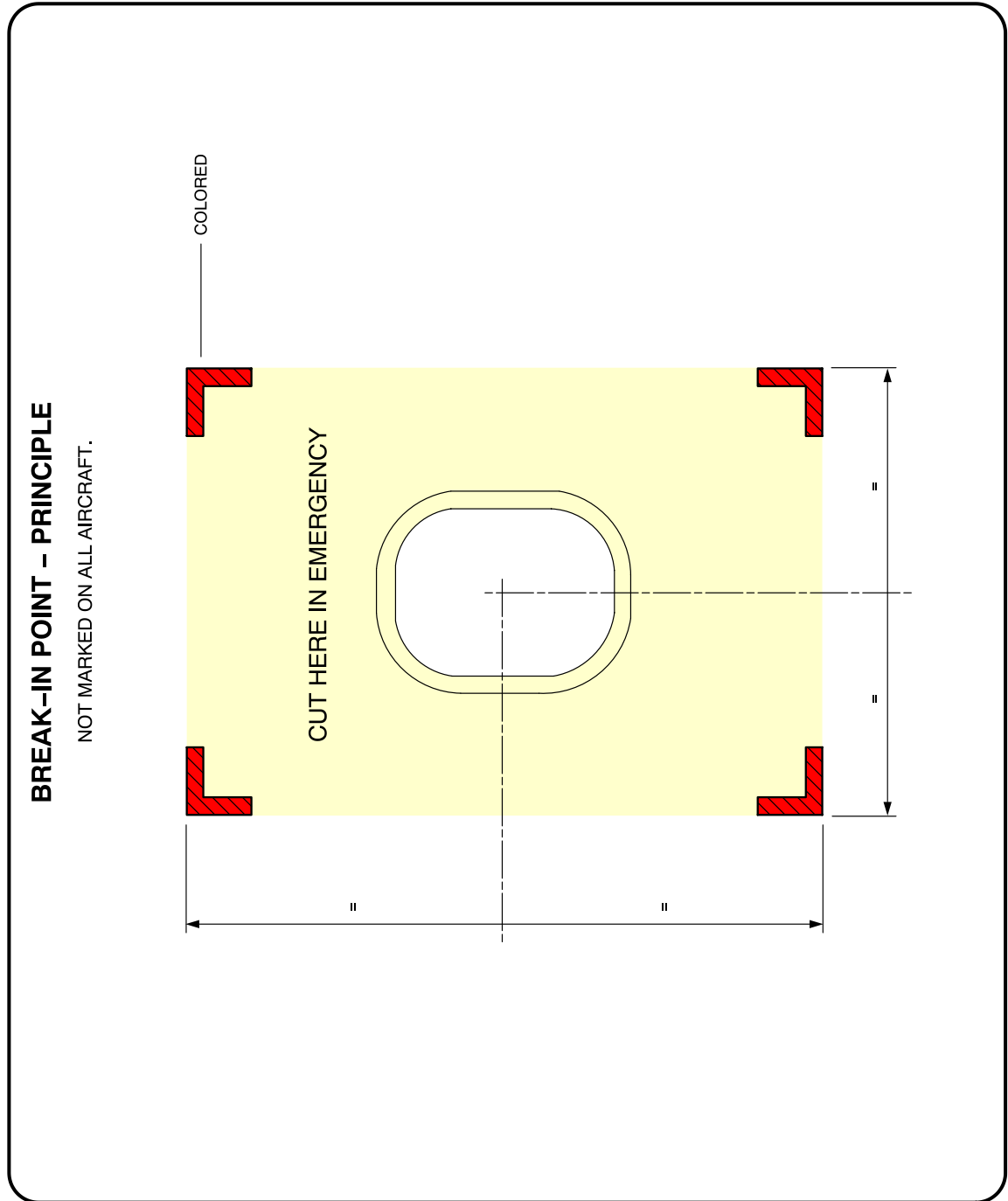

F_AC_100000_1_0520101_01_00

Structural Break-in Points
FIGURE-10-0-0-991-052-A01

****ON A/C A340-600**

Aircraft Rescue and Fire Fighting

1. Aircraft Rescue and Fire Fighting Charts

This sections provides data related to aircraft rescue and fire fighting.

The figures contained in this section are the figures that are in the Aircraft Rescue and Fire Fighting Charts poster available for download on AIRBUSWorld and the Airbus website.

**ON A/C A340-600

AIRBUS

A340-600

Aircraft Rescue and Fire Fighting Chart ARFC

NOTE:

THIS CHART GIVES THE GENERAL LAYOUT OF THE A340-600 STANDARD VERSION.
THE NUMBER AND ARRANGEMENT OF THE INDIVIDUAL ITEMS VARY WITH THE CUSTOMERS.
FIGURES CONTAINED IN THIS POSTER ARE AVAILABLE SEPARATLY IN THE CHAPTER 10 OF THE
"AIRCRAFT CHARACTERISTICS - AIRPORT AND MAINTENANCE PLANNING" DOCUMENT.

ISSUED BY:
AIRBUS S.A.S
CUSTOMER SERVICES
TECHNICAL DATA SUPPORT AND SERVICES
31707 BLAGNAC CEDEX
FRANCE

REVISION DATE: JANUARY 2017
REFERENCE : F_RF_000000_1_A340600
SHEET 1/2

© AIRBUS S.A.S. 2013 . All rights reserved.

F_AC_100000_1_0530101_01_03

Front Page
FIGURE-10-0-0-991-053-A01

**ON A/C A340-600

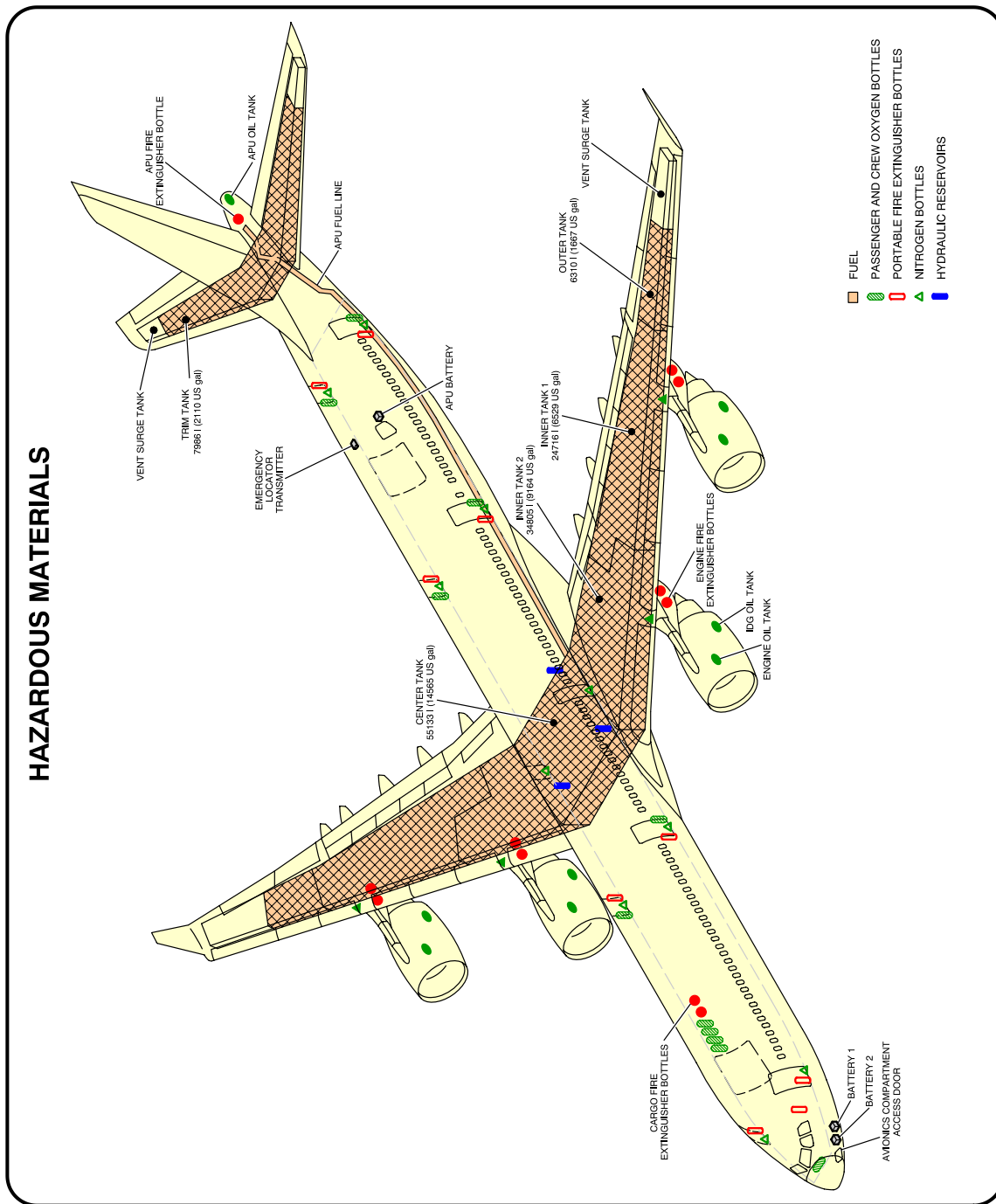

F_AC_100000_1_0540101_01_01

Highly Flammable and Hazardous Materials and Components
FIGURE-10-0-0-991-054-A01

A340-500/-600

AIRCRAFT CHARACTERISTICS - AIRPORT AND MAINTENANCE PLANNING

**ON A/C A340-600

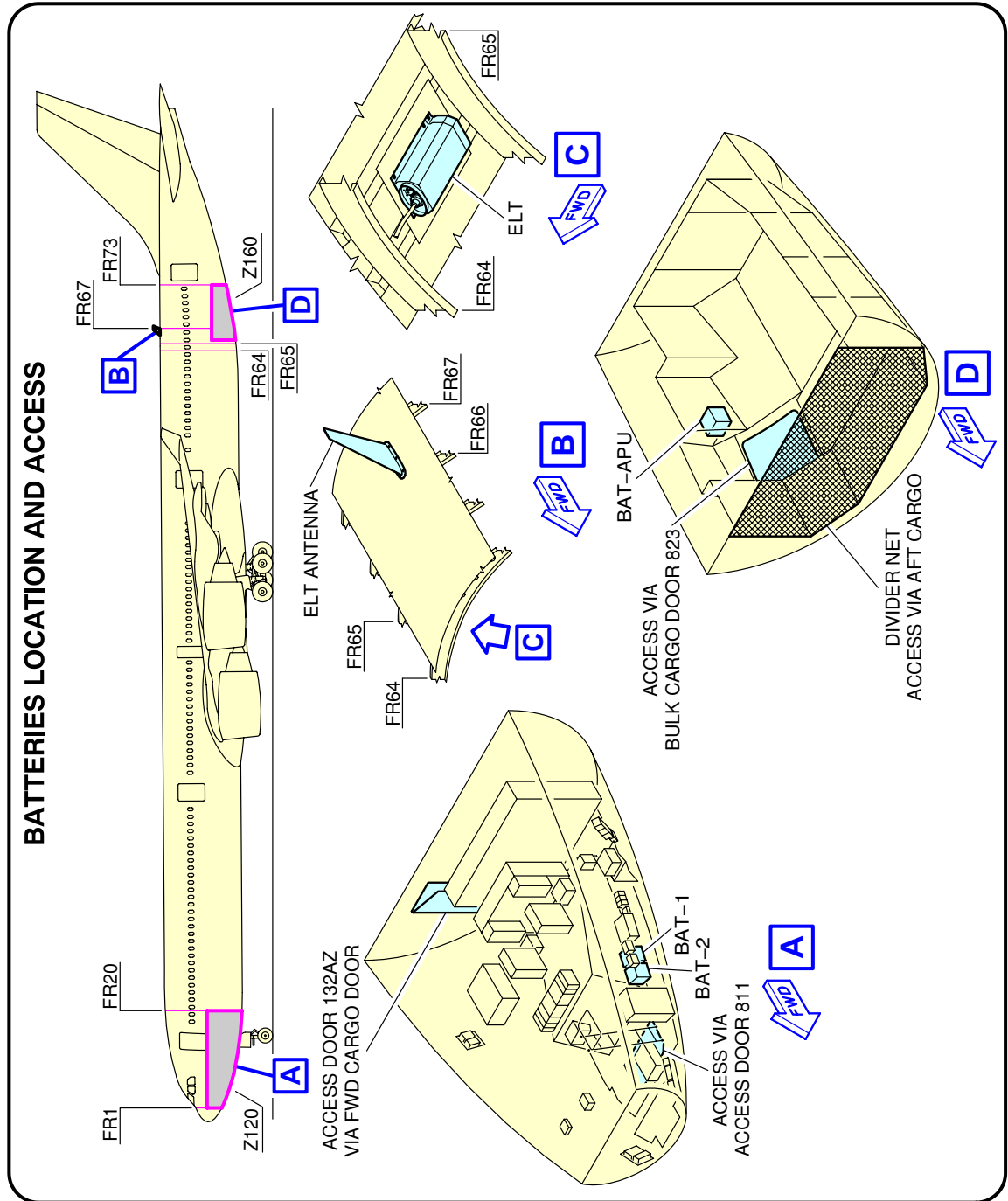

F_AC_100000_1_0710101_01_01

Batteries Location and Access
FIGURE-10-0-0-991-071-A01

A340-500/-600

AIRCRAFT CHARACTERISTICS - AIRPORT AND MAINTENANCE PLANNING

**ON A/C A340-600

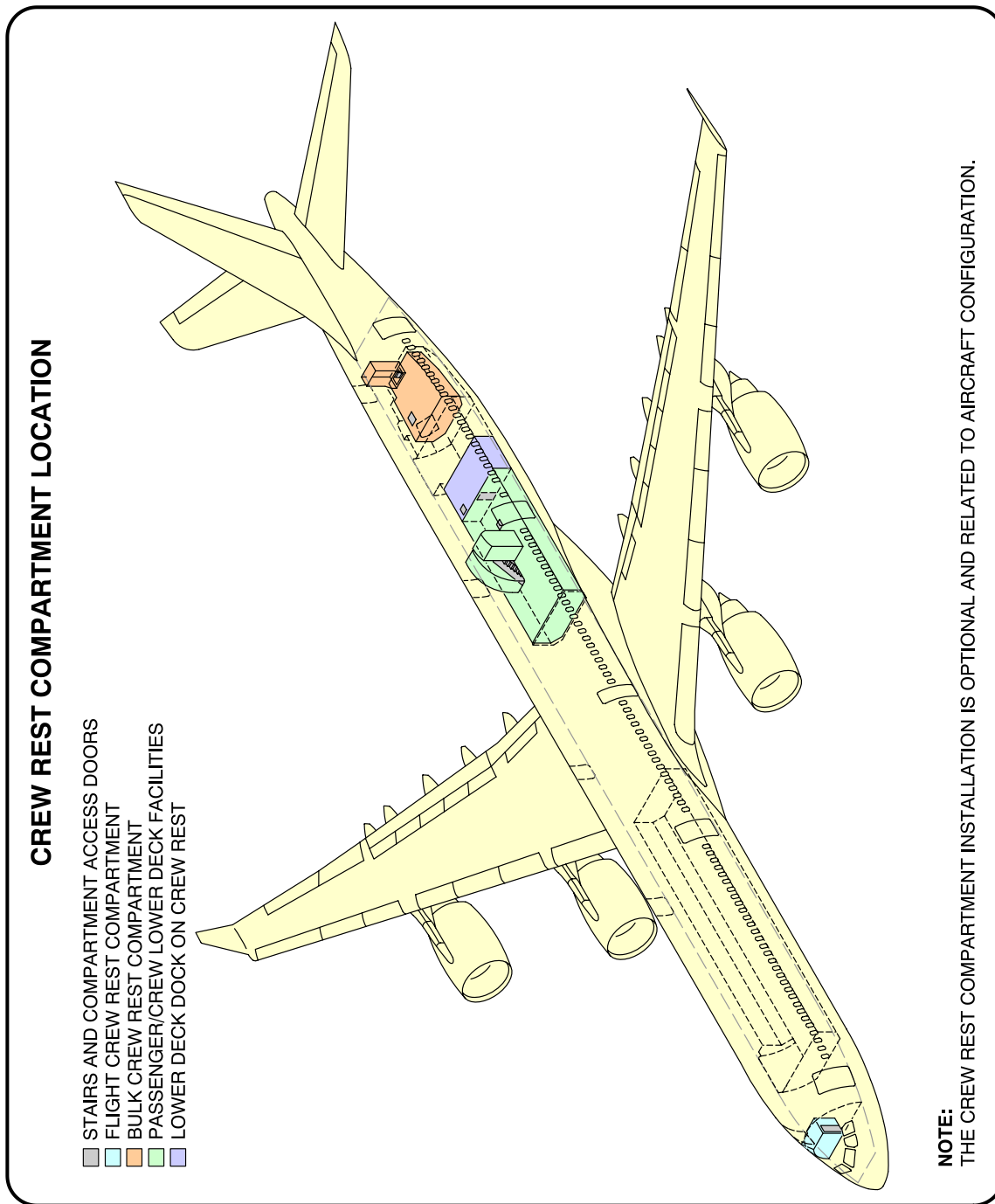

F_AC_100000_1_0550101_01_00

Crew Rest Compartments Location
FIGURE-10-0-0-991-055-A01

**ON A/C A340-600

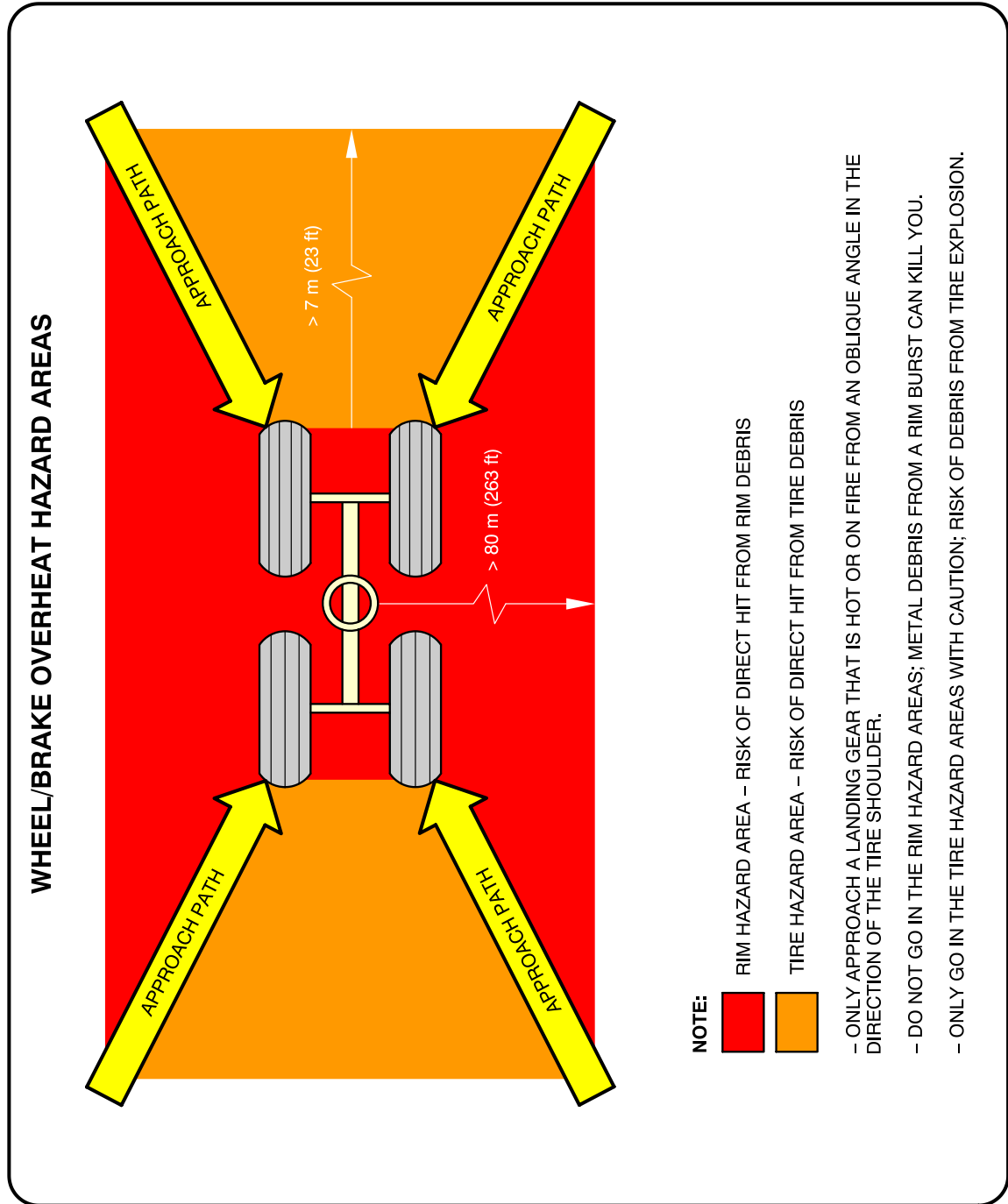

F_AC_100000_1_0560101_01_00

Wheel/Brake Overheat
Wheel Safety Area (Sheet 1 of 2)
FIGURE-10-0-0-991-056-A01

**ON A/C A340-600

BRAKE OVERHEAT AND LANDING GEAR FIRE

WARNING: BE VERY CAREFUL WHEN THERE IS A BRAKE OVERHEAT AND/OR LANDING GEAR FIRE. THERE IS A RISK OF TIRE EXPLOSION AND/OR WHEEL RIM BURST THAT CAN CAUSE DEATH OR INJURY. MAKE SURE THAT YOU OBEY THE SAFETY PRECAUTIONS THAT FOLLOW.

THE PROCEDURES THAT FOLLOW GIVE RECOMMENDATIONS AND SAFETY PRECAUTIONS FOR THE COOLING OF VERY HOT BRAKES AFTER ABNORMAL OPERATIONS SUCH AS A REJECTED TAKE-OFF OR OVERWEIGHT LANDING. FOR THE COOLING OF BRAKES AFTER NORMAL TAXI-IN, REFER TO YOUR COMPANY PROCEDURES.

BRAKE OVERHEAT:

1 – GET THE BRAKE TEMPERATURE FROM THE COCKPIT OR USE A REMOTE MEASUREMENT TECHNIQUE. THE REAL TEMPERATURE OF THE BRAKES CAN BE MUCH HIGHER THAN THE TEMPERATURE SHOWN ON THE ECAM.
NOTE: AT HIGH TEMPERATURES (>800°C), THERE IS A RISK OF WARPING OF THE LANDING GEAR STRUTS AND AXLES.

2 – APPROACH THE LANDING GEAR WITH EXTREME CAUTION AND FROM AN OBLIQUE ANGLE IN THE DIRECTION OF THE TIRE SHOULDER. DO NOT GO INTO THE RIM HAZARD AREA AND ONLY GO IN THE TIRE HAZARD AREA WITH CAUTION. (REF FIG. WHEEL/BRAKE OVERHEAT HAZARD AREAS). IF POSSIBLE, STAY IN A VEHICLE.

3 – LOOK AT THE CONDITION OF THE TIRES:
IF THE TIRES ARE STILL INFLATED (FUSE PLUGS NOT MELTED), THERE IS A RISK OF TIRE EXPLOSION AND RIM BURST. DO NOT USE COOLING FANS BECAUSE THEY CAN PREVENT OPERATION OF THE FUSE PLUGS.

4 – USE WATER MIST TO DECREASE THE TEMPERATURE OF THE COMPLETE WHEEL AND BRAKE ASSEMBLY. USE A TECHNIQUE THAT PREVENTS SUDDEN COOLING. SUDDEN COOLING CAN CAUSE WHEEL CRACKS OR RIM BURST. DO NOT APPLY WATER, FOAM OR CO₂. THESE COOLING AGENTS (AND ESPECIALLY CO₂, WHICH HAS A VERY STRONG COOLING EFFECT) CAN CAUSE THERMAL SHOCKS AND BURST OF HOT PARTS.

LANDING GEAR FIRE:

CAUTION: AIRBUS RECOMMENDS THAT YOU DO NOT USE DRY POWDERS OR DRY CHEMICALS ON HOT BRAKES OR TO EXTINGUISH LANDING GEAR FIRES. THESE AGENTS CAN CHANGE INTO SOLID OR ENAMELED DEPOSITS. THEY CAN DECREASE THE SPEED OF HEAT DISSIPATION WITH A POSSIBLE RISK OF PERMANENT STRUCTURAL DAMAGE TO THE BRAKES, WHEELS OR WHEEL AXLES.

1 – IMMEDIATELY STOP THE FIRE:

A) APPROACH THE LANDING GEAR WITH EXTREME CAUTION FROM AN OBLIQUE ANGLE IN THE DIRECTION OF THE TIRE SHOULDER. DO NOT GO INTO THE RIM HAZARD AREA AND ONLY GO IN THE TIRE HAZARD AREA WITH CAUTION. IF POSSIBLE, STAY IN A VEHICLE.

B) USE LARGE AMOUNTS OF WATER, WATER MIST; IF THE FUEL TANKS ARE AT RISK, USE FOAM. USE A TECHNIQUE THAT PREVENTS SUDDEN COOLING. SUDDEN COOLING CAN CAUSE WHEEL CRACKS OR RIM BURST.

C) DO NOT USE FANS OR BLOWERS.

F_AC_100000_1_0560102_01_00

Wheel/Brake Overheat
Recommendations (Sheet 2 of 2)
FIGURE-10-0-0-991-056-A01

A340-500/-600

AIRCRAFT CHARACTERISTICS - AIRPORT AND MAINTENANCE PLANNING

**ON A/C A340-600

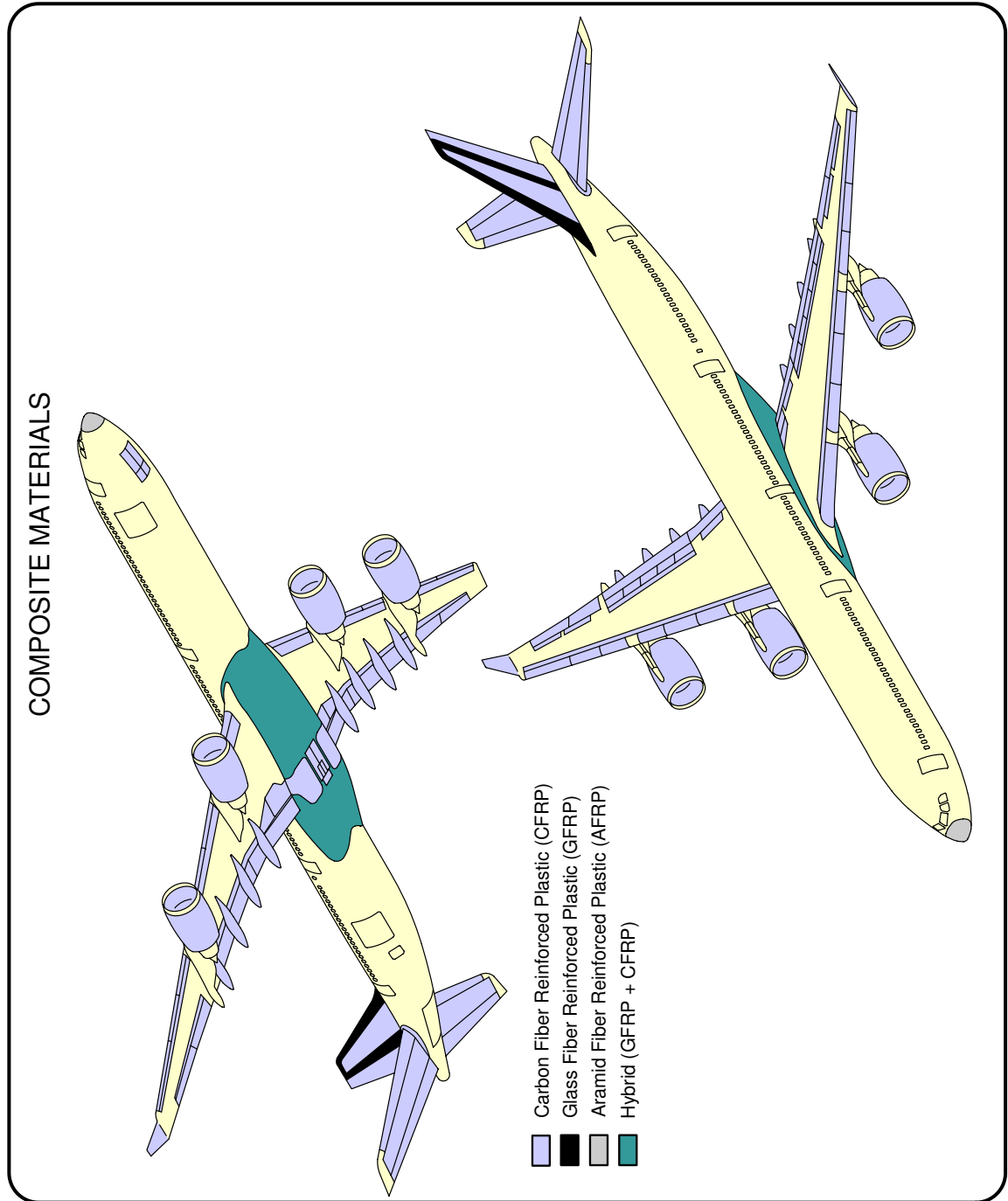

F_AC_100000_1_0570101_01_01

Composite Materials Location
FIGURE-10-0-0-991-057-A01

**ON A/C A340-600

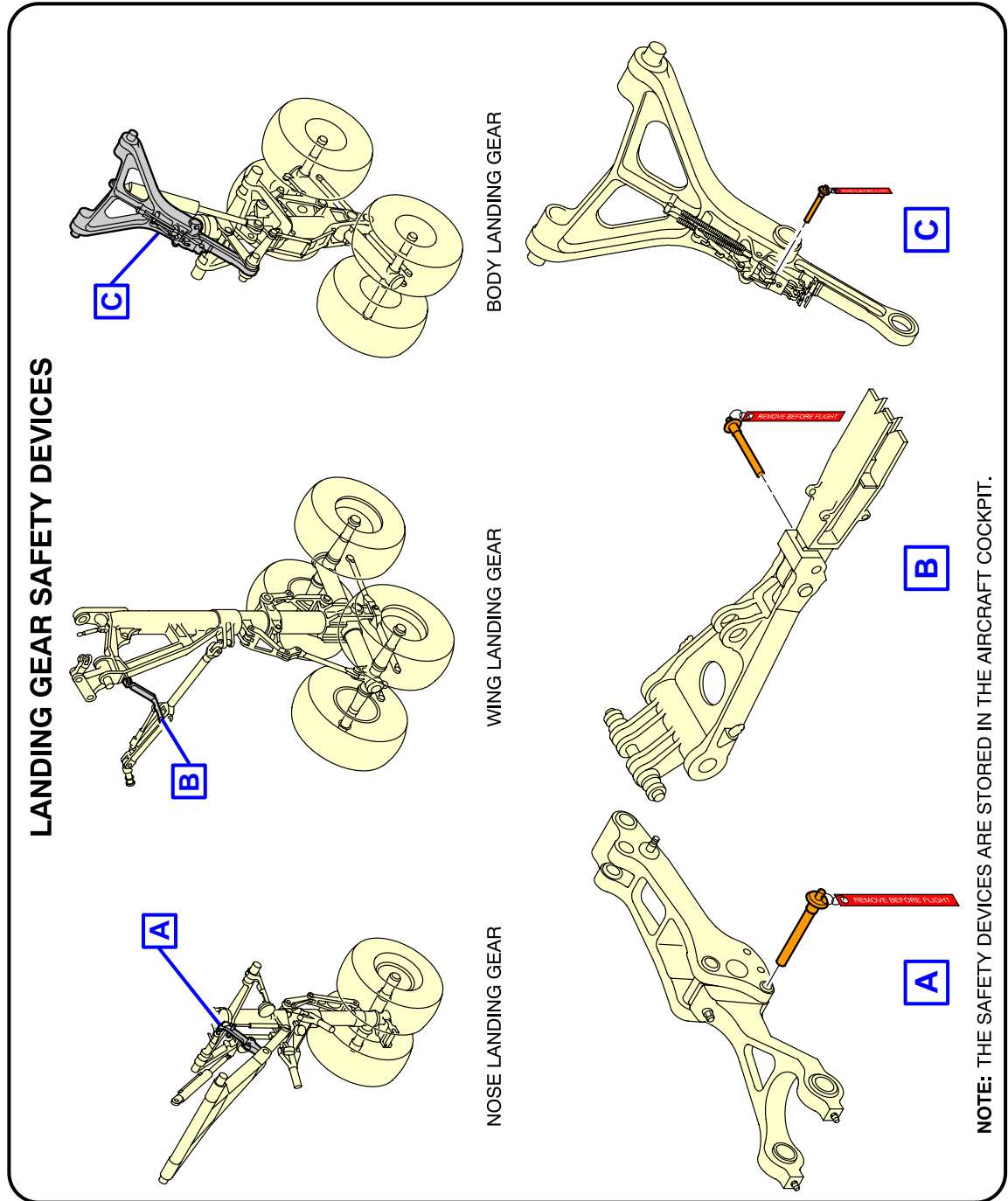

F_AC_100000_1_0580101_01_00

Ground Lock Safety Devices
FIGURE-10-0-0-991-058-A01

A340-500/-600

AIRCRAFT CHARACTERISTICS - AIRPORT AND MAINTENANCE PLANNING

**ON A/C A340-600

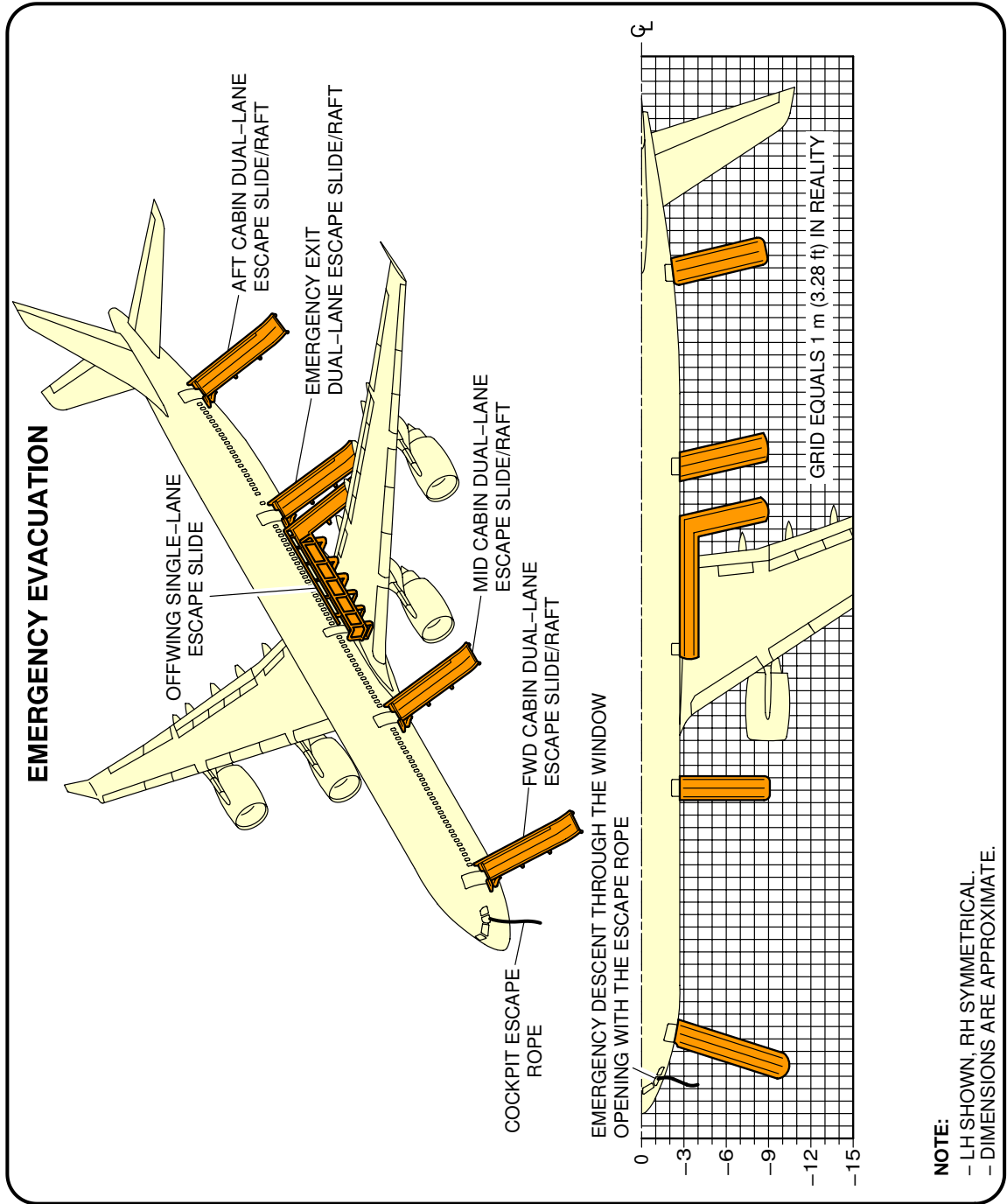

F_AC_100000_1_0590101_01_02

Emergency Evacuation Devices
FIGURE-10-0-0-991-059-A01

**ON A/C A340-600

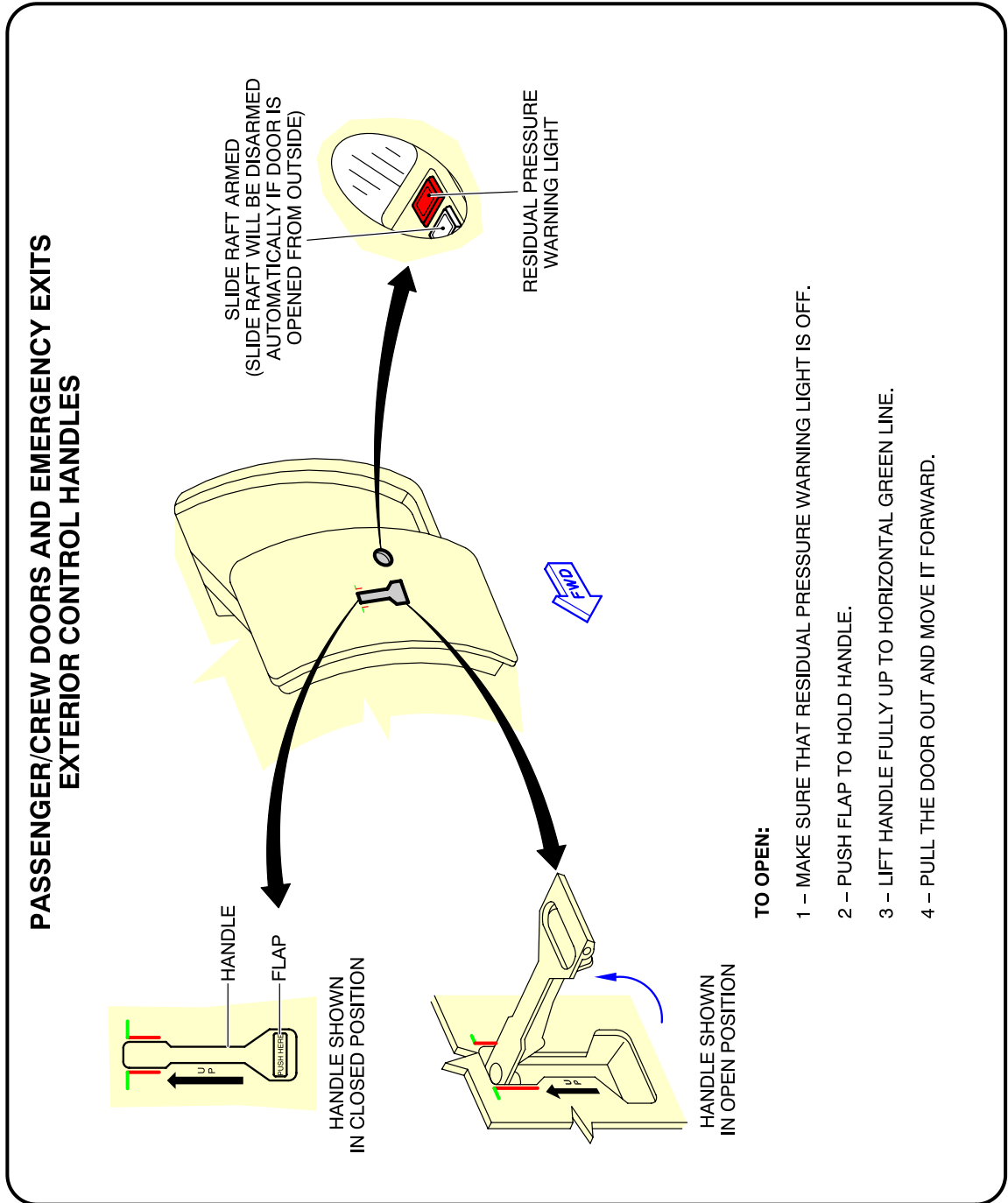

F_AC_100000_1_0600101_01_00

Pax/Crew Doors and Emergency Exits
FIGURE-10-0-0-991-060-A01

**ON A/C A340-600

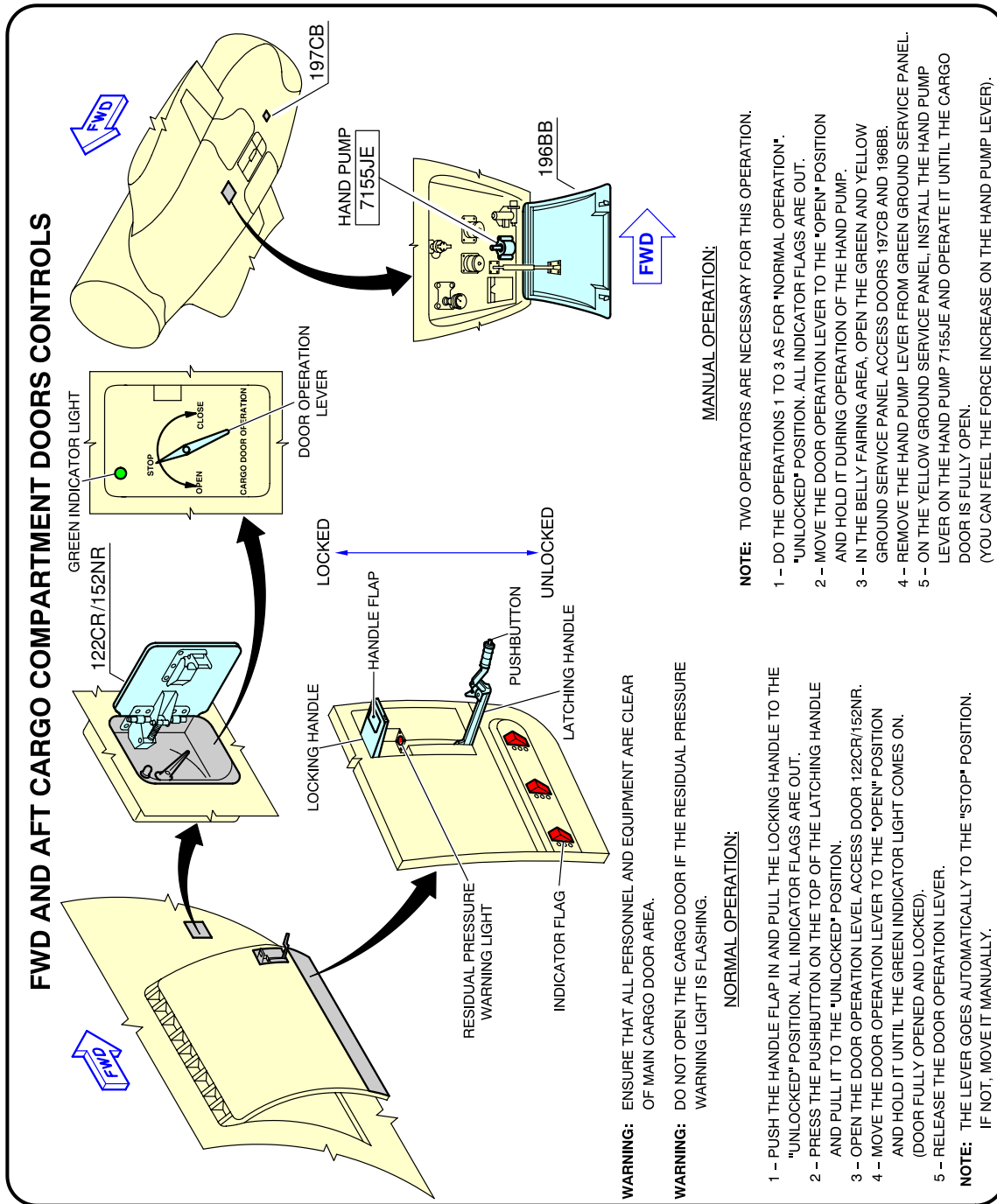

F_AC_100000_1_0610101_01_00

FWD and AFT Lower Deck Cargo Doors
FIGURE-10-0-0-991-061-A01

A340-500/-600

AIRCRAFT CHARACTERISTICS - AIRPORT AND MAINTENANCE PLANNING

**ON A/C A340-600

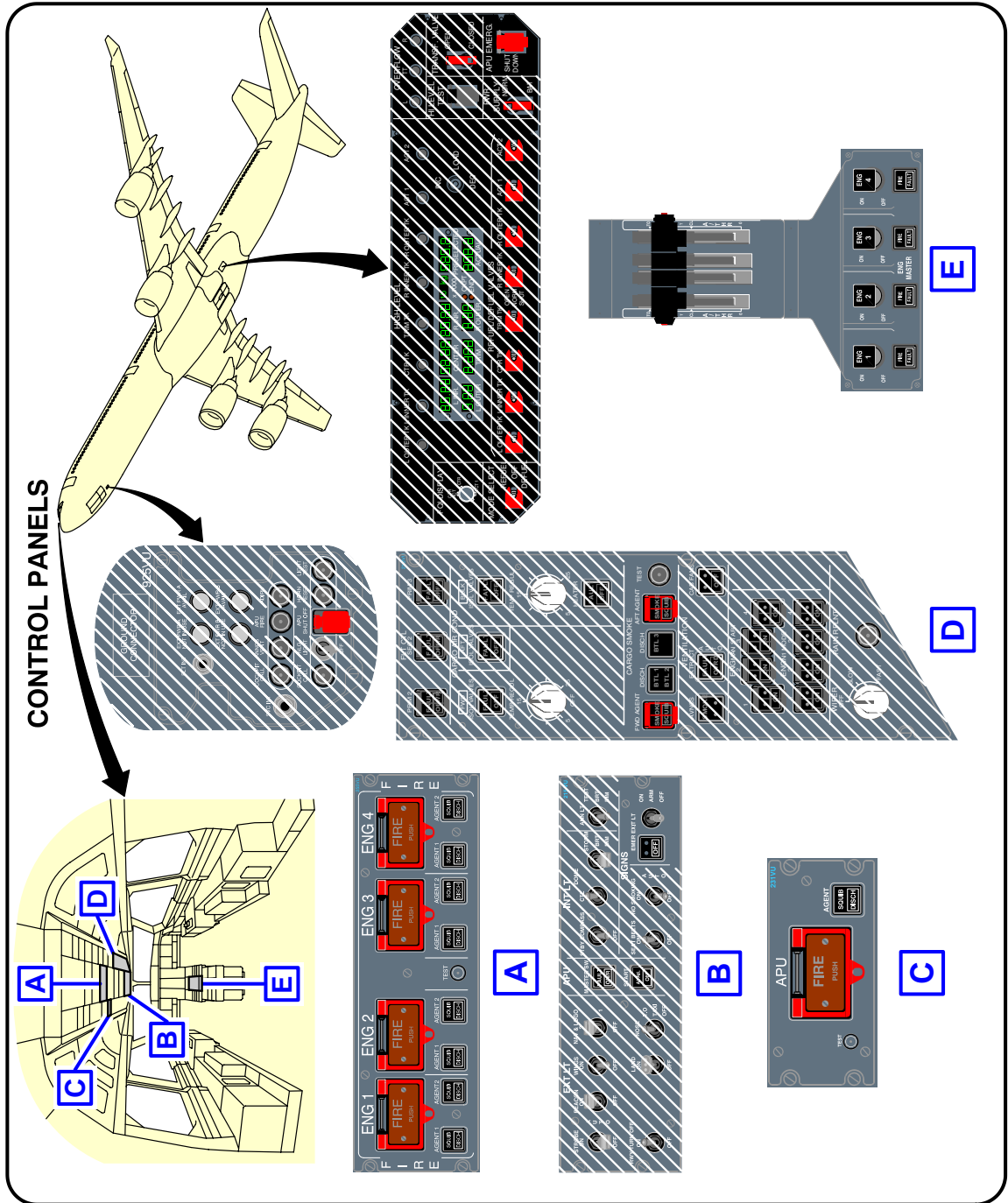

F_AC_100000_1_0620101_01_00

Control Panels
FIGURE-10-0-0-991-062-A01

**ON A/C A340-600

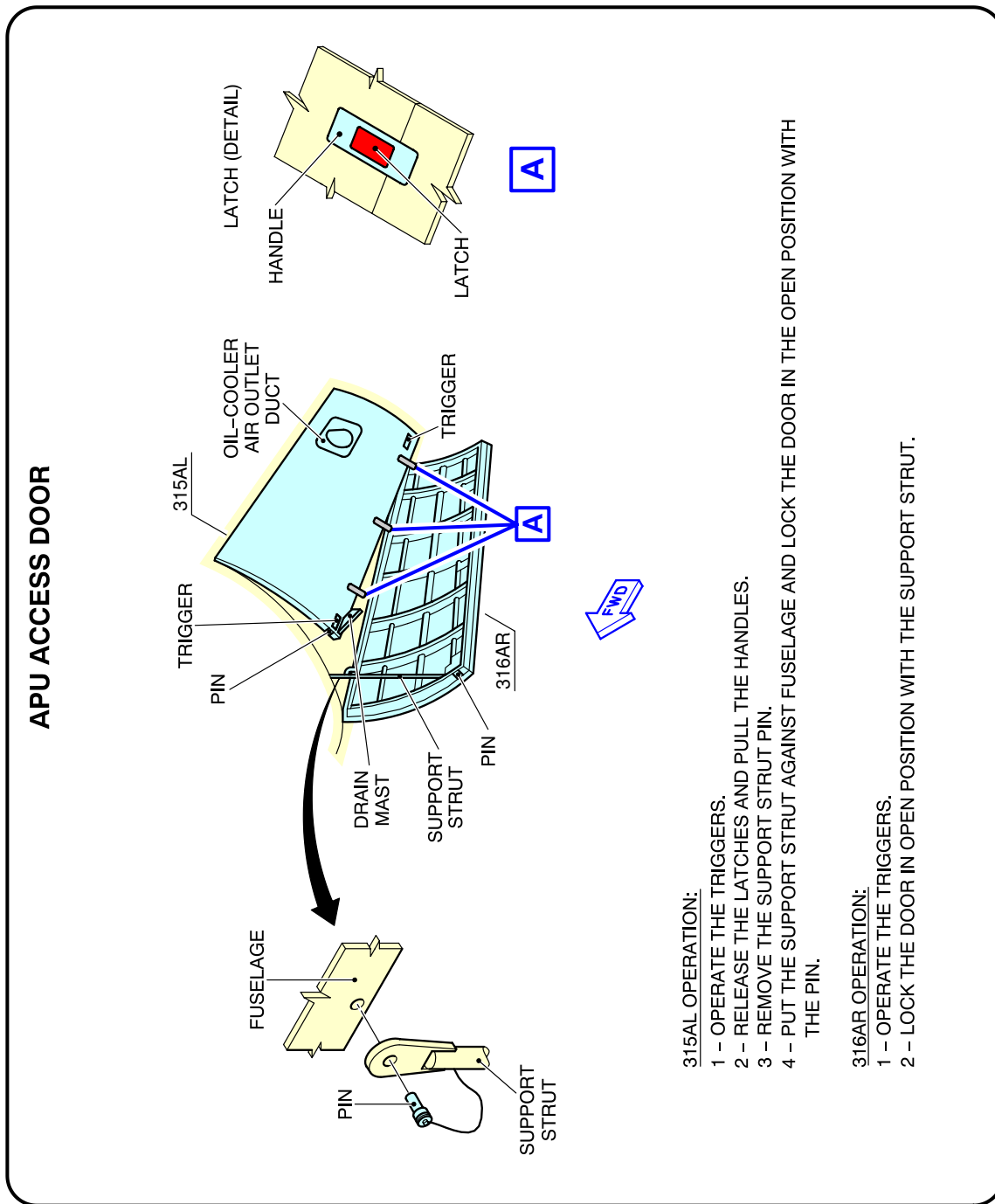

F_AC_100000_1_0630101_01_00

APU Compartment Access
FIGURE-10-0-0-991-063-A01

A340-500/-600

AIRCRAFT CHARACTERISTICS - AIRPORT AND MAINTENANCE PLANNING

**ON A/C A340-600

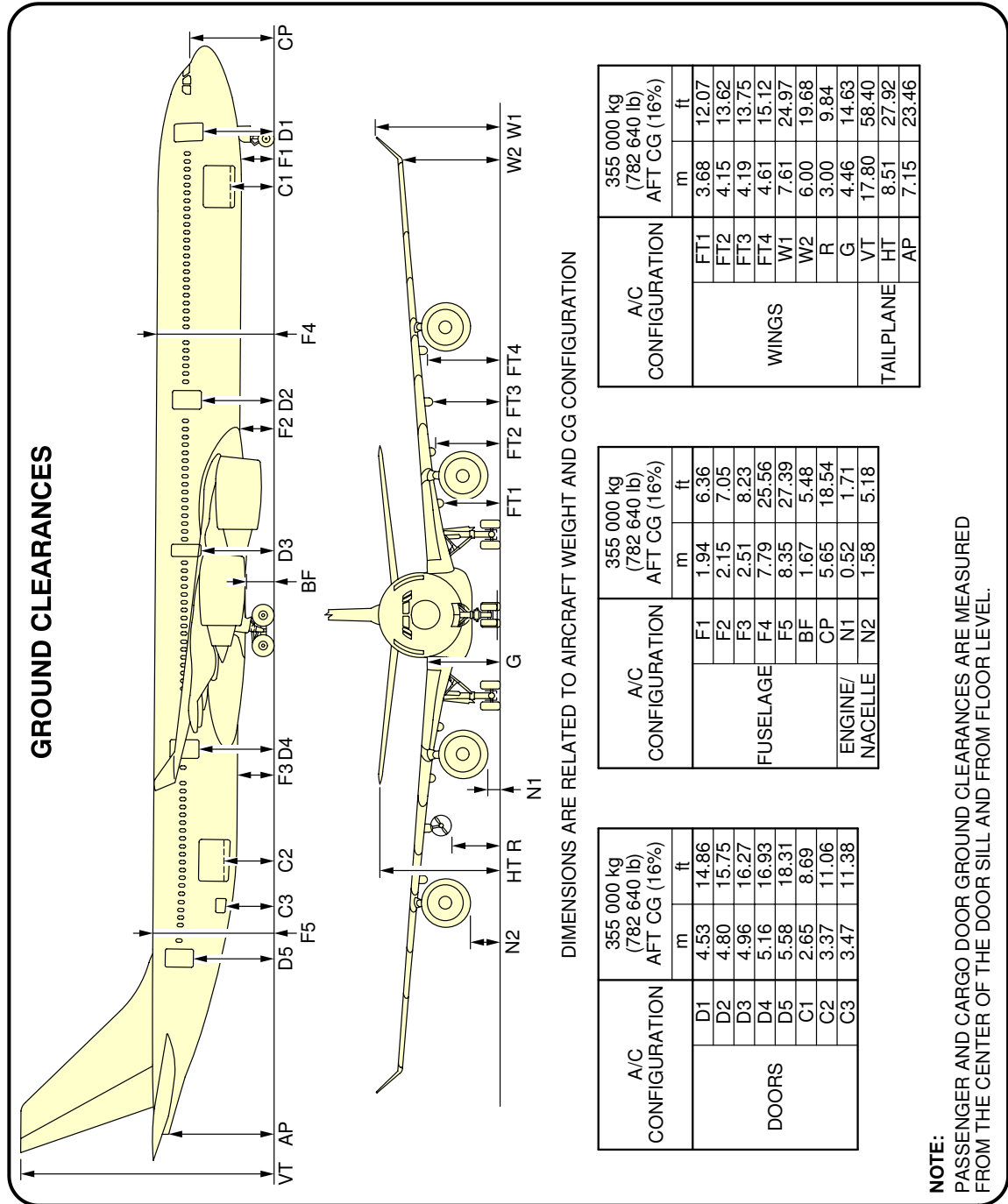

F_AC_100000_1_0640101_01_01

Ground Clearances
FIGURE-10-0-0-991-064-A01

**ON A/C A340-600

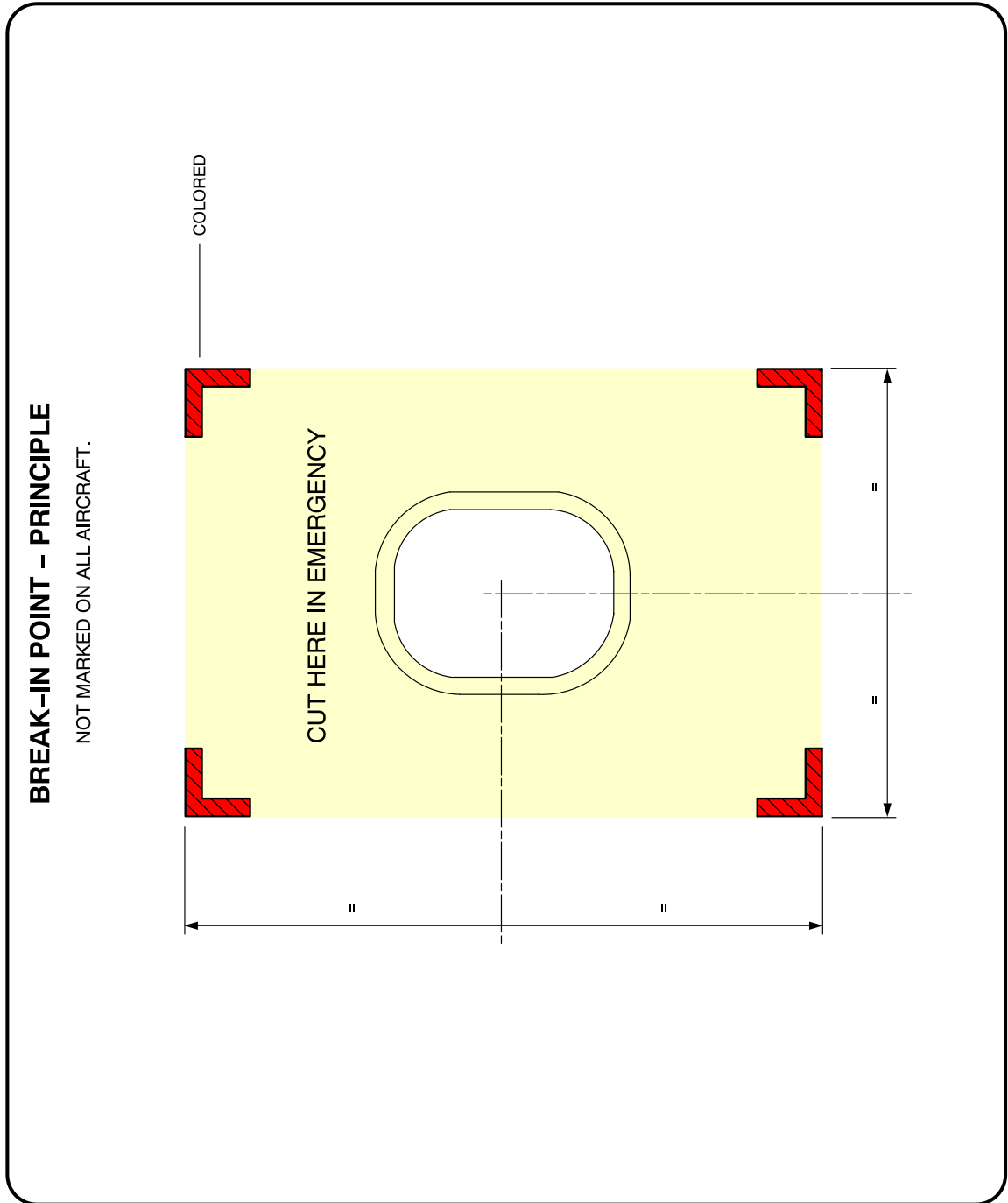

F_AC_100000_1_0650101_01_00

Structural Break-in Points
FIGURE-10-0-0-991-065-A01