

# FAST

AIRBUS  
TECHNICAL  
DIGEST

NUMBER 7  
JANUARY 1987

GS 210  
TAS 220

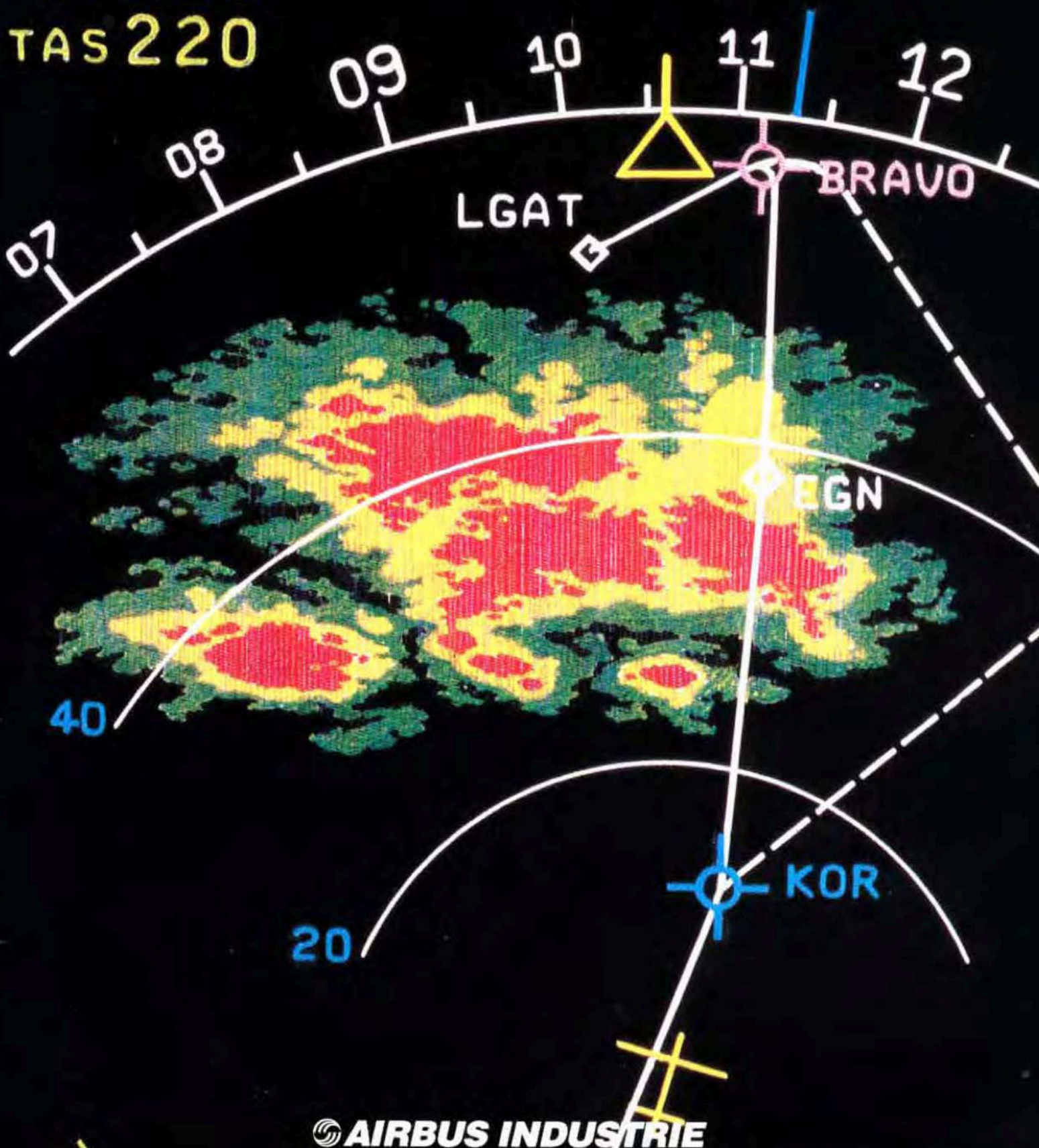

# FAST

**AIRBUS  
TECHNICAL  
DIGEST**

**NUMBER 7  
JANUARY 1987**

**2**

## **CATHODE RAY TUBES THEIR EFFECTS ON MAINTENANCE PRACTICES**

Michel Solier

**6**

## **INTERFERENCES**

CAA Airworthiness Information Leaflet

**8**

## **BATTERIES - CONTROL AND MAINTENANCE**

René Garcia

**15**

## **A310-300 FUEL SYSTEM AND CENTRE OF GRAVITY CONTROL**

Colin Orme

**21**

## **CARBON BRAKES**

Georges Bardou

**26**

## **SIMPLIFIED ENGLISH**

Michael Stiles

**28**

## **DISPATCH RELIABILITY - PART 2**

Achim Krapp

**31**

## **FIELD SERVICE REPRESENTATIVES**

**32**

## **BATTERY MAINTENANCE ?**

Cover : Detail of Navigation Display on A310

The articles herein may be reprinted without permission except where copyright source is indicated, but with acknowledgement to Airbus Industrie. Articles which may be subject to ongoing review must have their accuracy verified prior to reprint. The statements made herein do not constitute an offer. They are based on the assumptions shown and are expressed in good faith. Where the supporting grounds for these statements are not shown the Company will be pleased to explain the basis thereof.

Publisher : Airbus Industrie, Product Support Directorate  
1, rond-point Maurice Bellonte, 31707 Blagnac Cedex France.  
Telephone +33 (61) 93 33 33. Telex AIRBU 530526F  
General Editor : Denis Dempster, Technical Director : Gérard Misraï  
Graphic Design and Artwork : Agnès Lacombe  
Photography : Hervé Béranger / Bernard van Kempen / Alain Lepers  
Photocomposition : Al / CM-M  
Printing : Escourbiac 81306 Graulhet France  
© 1987 Airbus Industrie

# CRTs

## THEIR EFFECT ON MAINTENANCE PRACTICES

The aviation world has been revolutionized by the arrival on the flight-deck of cathode ray tubes (CRT), the new generation of visual display units (DU). The new-style instrument panel configuration, as on the A310, is now familiar. What naturally springs to mind is the question of how maintenance practices are affected. This article looks into the matter with regard to the electronic flight instrument system (EFIS) and the electronic centralized aircraft monitor (ECAM) since there is no equivalent on conventional flight decks.

SPD

ALT  
G/S

HDG  
LOC

CAT 2

FD 1  
CMD 1

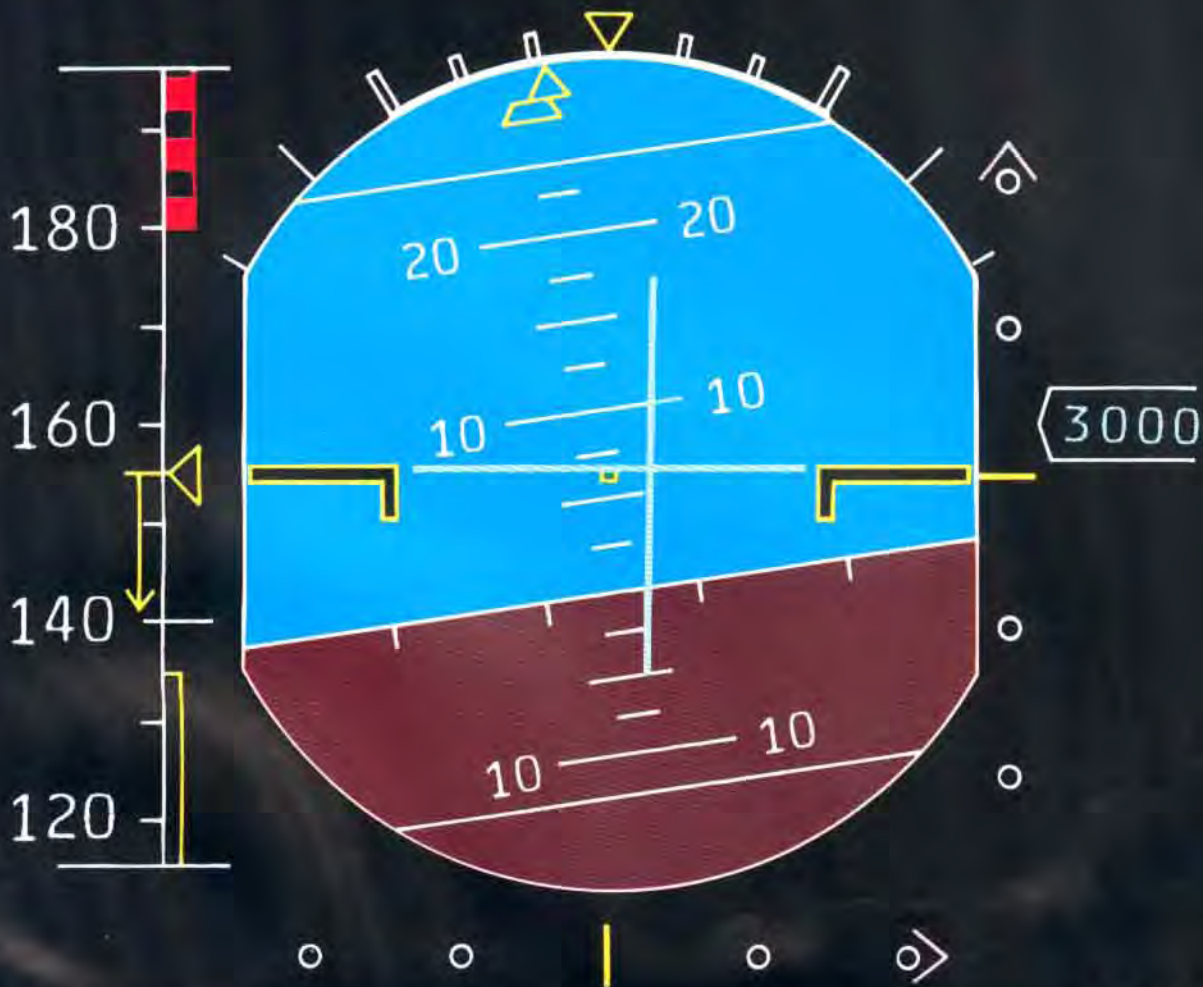

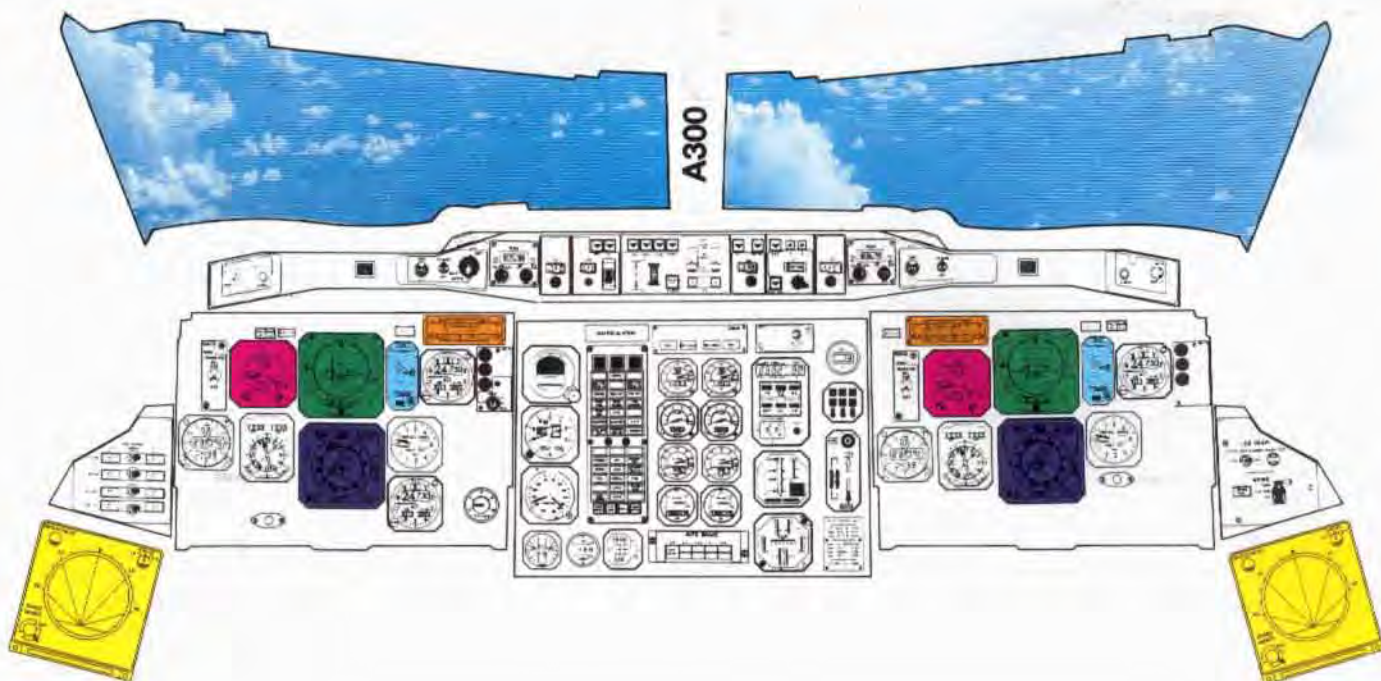

The developments in digital techniques together with inherent flexibility of CRT displays provide the means of centralizing a considerable amount of data on a single screen. This results primarily in a reduction in the number of instruments installed whilst at the same time expanding display possibilities (such as for example flight-plan information).

A further advantage of the EFIS system is that it is to Arinc specification 700 so making it compatible with Arinc 700 type digital computers and enabling data to be received directly from Arinc 429 buses.

#### In A300 cockpit

● Horizontal situation indicators	2
● Radio altimeters	2
● Mach air speed indicators	2
● Radar indicators	2
● Attitude director indicators	2
● Flight mode annunciators	2

**Total no. of instruments 12**

#### In A310 cockpit

● Display units	4
● Signal generator units (not visible in cockpit)	3

**Total no. of instruments 7**



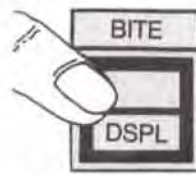

## LINE MAINTENANCE

The important innovation resides in the fact that information is centralized and digital computers connected via Arinc data buses are utilized. In its simplest form, this represents a single CRT displaying a variety of data using a common bus. Such a configuration enables rapid detection of whether a fault originates at the data source or within the display unit by use of built-in test equipment (BITE) in the various peripheral systems. A further feature is that the values displayed follow the same chain of calculation and the same circuits inside the display unit. For this reason, failure of an isolated value is not possible, which in itself is worthwhile.

Electro-magnetic systems can give readings which are not "true" due to mechanical weaknesses and detecting such faults may involve the use of maintenance test equipment that take a relatively long time to set up. A digital system linked to a CRT works on an "all or nothing" principle. EFIS technology (i.e. hardware and software) incorporates a triple function BITE capability, as follows :

- a display test (figure 1) to control screen image quality,
- an input test (figure 2) clearly indicating the list of non valid input buses,
- a BITE display (figure 3) on the primary flight display (PFD) showing peripheral system failures memorized for the previous flight leg and on the navigation display (figure 4) showing failures over the last 63 flight legs.

One simple means of checking the maintainability of on-board equipment is to calculate the system's MTBUR / MTBF ratio. An MTBUR / MTBF ratio of 0.93 for a three month operational period indicates a 93% success rate in detecting the failure. This compares with 75% in conventional instruments as is shown in table 1. This ratio is of some significance though a figure would only be conclusive at high MTBF and high MTBUR values. Levels higher than those obtained with conventional display units can be obtained solely after some years of operational activity.

This therefore means that not only are six instruments replaced by two, but also stock requirements can be reduced. MTBUR and MTBF follow-up is further improved by incorporation of the following Service Bulletins :

**Table 1**  
Removal/failure comparison

	MTBUR	MTBF	Ratio
EFIS	503	539	0.93
Σconventional electro mechanical indicators	155	206	0.75

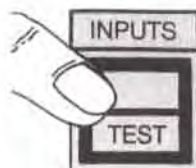
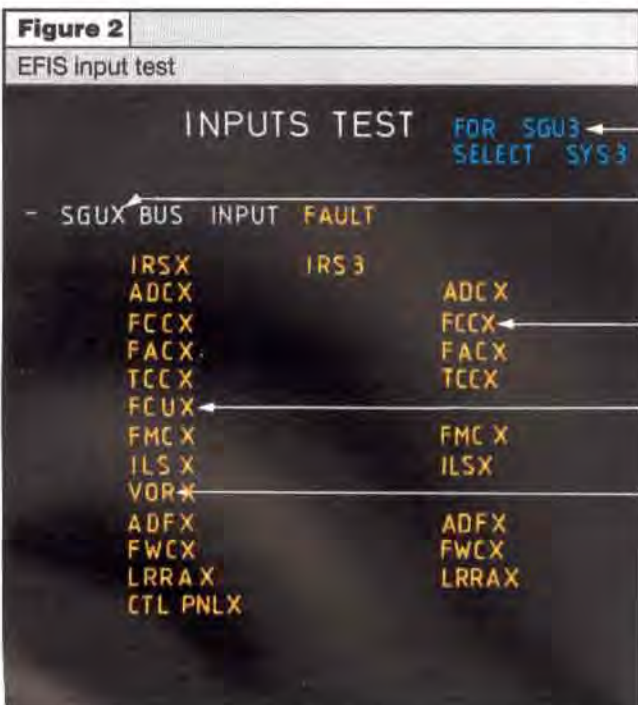

- EFIS control panel (THOMSON-CSF) no. 961260-34-1,
- EFIS SGU (THOMSON-CSF) no. 961266-34-6,-8,-10,-13,-14,-15, Revision 02A,
- Service Information Letters : FCD 55 DU 206621 001 / 002 / 003, are also of interest.

This is a good moment to look at maintenance shop practices. Conventional instruments are basically micro-mechanical and electro-mechanical devices each requiring purpose-built test equipment for fault finding, repair and recalibration work. The situation with cathode ray tubes differs according to the unit involved. Testing involves the use of a manual test-bench for reception testing, component repair and calibration. The unit can however be connected to automatic test equipment (ATE) to automate maintenance in part. Signal generator units can be tested on an ATE like any other computer and also on a purpose-built test-bench for component repair tasks.

It is evident that cathode ray tubes and digital computers allow for increased automation in maintenance. The prime benefit however is the time-saving element. For example the average repair time of a conventional ADI or HSI varies from 15 to 20 hours, whereas a display unit (EFIS or ECAM) needs 8 to 9 hours and an SGU only 2 to 5 hours. A further advantage is a trend towards standardized test applications, which can be defined on two levels, i.e. :

- maintenance to board level (level 2),
- maintenance of the board itself (level 3).

In either case, maintenance of all types of computer can be carried out on the same ATE. All that is required is to have the different test programs. Moreover the training requirements for maintenance personnel are simpler.

### CONCLUSION

After only a few years of operation the new generation of indicator - the CRT - has proved its efficiency. Its principle benefits are rapid and efficient trouble shooting at the line maintenance level, the standardization of test equipment and therefore the standardization of training for the maintenance personnel. □

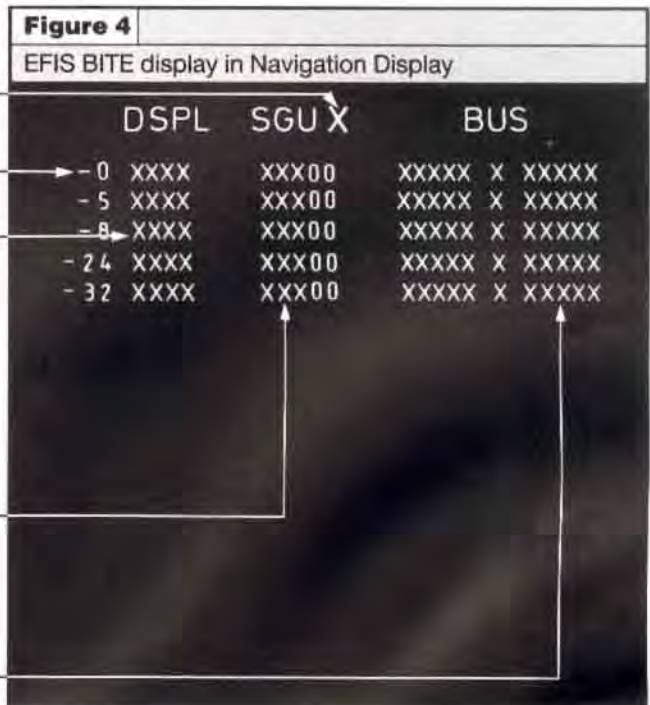
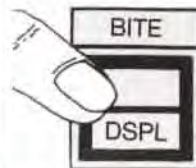
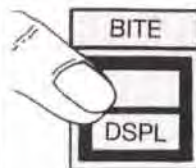

# Civil Aviation Authority

Airworthiness Division

AIRWORTHINESS INFORMATION LEAFLET

Ref AD/IL/0113/1-4

Date 4th October 1985

Author's Initials NAF

This Leaflet will not necessarily be kept up to date by reissues.

**SUBJECT TITLE :** IS ELECTROMAGNETIC INTERFERENCE FROM AIRCRAFT PASSENGER ELECTRONICS A PROBLEM?

**PURPOSE :** This leaflet provides information and background on the above subject and suggests procedures for resolving aircraft problems. The contents of this leaflet have also been circulated by CAA Flight Operations Division to AOC Holders and by CAA SDAU in the Occurrence Digest and the General Aviation Safety Information Leaflet (GASIL)

**REFERENCES :** CAA AIC 44/1982  
FAA 97.19 & 40-84  
RTCA SC 156

## Introduction

Since the early 1960's the above question has been with us. In those days it was the cardiac pacemaker and the electronic hearing aid which were suspected although no actual reports of interference were received.

It was not until pocket calculators came into common use that interest in this subject revived and the first report of interference was received. This report however appeared to involve a calculator held close to a radio antenna - not a situation which is likely to arise in-flight.

More recently, many different types of portable electronic gadgets have come onto the market and have found their way onto aircraft for use during a flight or stowed in luggage. The following list, long as it is, is probably not complete and could be added to now and in the future:-

Cardiac Pacemakers  
Hearing Aids  
Colostomy Rings  
Electronic Watches  
Tape Players

Electronic Calculators  
Electronic Computers  
Electronic Games  
Tape Recorders  
Electronic Clocks

Radio Receivers  
Radio Transmitters  
TV Receivers  
Photographic Equipment  
Video Equipment

Actual reports of interference to aircraft equipment or anomalous operation of aircraft equipment have, over the years, not been numerous but the number of cases where this has been blamed on, or where passenger electronics has been mentioned, has been increasing. For instance during 1984 an Omega equipment problem encountered by two operators was reported on approximately 1% of their flights. These incidents represented more of a nuisance than a hazard. Attempts, however, to reproduce the problem under controlled conditions using the item of passenger electronics concerned have been unsuccessful whilst measurements of the interference produced by the passenger devices have indicated that they were unlikely to have been the culprit.

Interference with aircraft systems is of course not a new subject; over the years some systems have acquired reputations for being susceptible to interference while other systems and circumstances have been found to produce interference.

The aircraft H.F. transmitter has frequently caused problems, while the Automatic Director Finder still suffers when the atmospheric and static electrical conditions are adverse.

To combat these problems the equipment immunity characteristics and the interference testing requirements have been continuously upgraded in the attempt to cope with new problems and circumstances as they arise.

An industry committee with international representation, set up to investigate this subject, is due to produce its final report in the near future.

## WHAT PORTABLE ELECTRONICS ARE ACTUALLY BEING USED IN AIRCRAFT?

All the items listed above have been seen and used in aircraft although those in columns 2 and 3 are rarely seen or only used for short periods of time due to either the difficulty of using them or the limited use they have inside an aircraft. The items in column 1 are used continuously or in the case of tape players, for extended periods. This latter item, when in use, is clearly visible to cabin staff and is particularly popular with younger passengers on charter flights.

## WHAT INTERFERENCE DO PORTABLE ELECTRONICS PRODUCE?

The manufacturers of these devices strive to reduce the cost of operating their devices by keeping their power consumption to a minimum giving the benefit generally of minimum radiated interference. This gives the



Subsequent to the issue of the article 'Interferences' in FAST no. 5, Airbus Industrie received an Airworthiness Information Leaflet on the subject from the Civil Aviation Authority of the United Kingdom which it is pleased to reproduce.

# INTERFERENCES



- 4) Note state of reception on all radio systems.
- 5) Check correct operation of electrical generation system.
- 6) Check for correct operation of other aircraft electrical systems eg galleys, entertainment equipment.
- 7) If all other attempts fail to restore correct operation, check for passenger devices in use. Having switched these off repeat steps 2 and 3 noting any changes in the aircraft conditions or configuration.

It would be most helpful to the Authority if the above procedure could be followed, as far as circumstances permit, and the results reported, preferably by MOR, to the CAA Airworthiness Division.

hope. However, the number of different devices in existence worldwide is increasing rapidly. Ideas of carrying out measurements on all devices or of implementing some approval system for their use in aircraft have been found to be impractical. So a policy of sampling the products and monitoring their effects in aircraft remains the only reasonable alternative to an actual ban, bearing in mind the negligible hazards involved.

The measurements on portable devices showed interference levels varying from practically zero for tape players and liquid crystal display games, calculators etc. to levels similar to those found on normal aircraft equipment with tape recorders, radio and TV receivers and games, calculators etc. employing light emitting diodes.

The nature of the measured interference has been such that it is unlikely to cause aircraft equipment to operate incorrectly bearing in mind that aircraft equipment is designed to be immune to wide ranges of interference and that it is located well away from and generally screened from areas where portable electronics are likely to be used.

The Federal Aviation Agency (FAA) in the USA has stated that Portable Computers, Calculators and Electronic Games used aboard aircraft do not cause interference and also allow the unrestricted use of Portable Voice Recorders, Hearing Aids, Heart Pacemakers and Electric Shavers. The CAA however has issued guidance to operators on the subject but without banning or allowing specific items and is continuing to monitor the subject.

## RECENT REPORTS FROM UK AIRLINES

The reports from two airlines of problems with the Omega equipment on their aircraft have in many cases blamed or at least made mention of the use of tape players by passengers. However a new "Software Program" for this Omega equipment has been flown by these and other airlines and will be fitted in all systems in due course. Although not designed specifically to reduce interference problems, it is hoped that the program improvements will result in the Omega becoming less susceptible to problems at present attributed to interference. In the event that further problems do occur, a well documented report showing all data both during an incident and after taking corrective action, could prove invaluable.

A suggested procedure follows which is intended to achieve this aim.

- 1) Note effect on system or systems and attempt to re-establish correct operation.
- 2) Note effect on all modes of systems operation including listening for noise change on audio system. In the case of Omega note all outputs from the rotary switch including TAS/Hdg.
- 3) Note aircraft situation, ie Altitude, Geographic Position, Airspeed, Heading, climb/cruise/descent etc, outside conditions eg rain, icing, cloud, etc and whether manoeuvring, using flap etc.



# BATTERIES

## control and maintenance



**René Garcia**  
Electrical System Technology Group  
Aérospatiale

Battery operation and maintenance may at first sight seem quite a simple matter. This is indeed the case as long as certain basic principles are followed both on-aircraft and in the workshop. This article shows which controls and indicators are available to the mechanic in the Airbus A310 and highlights the maintenance actions required to retain good dispatch reliability of the aircraft and to avoid unnecessary removal of batteries leading to long and expensive checks. Some simple points to be remembered during workshop maintenance are also indicated.

## BATTERY INSTALLATION

The batteries are installed in fire-proof boxes in a well-ventilated location within the avionics compartment (figure 1). The natural ventilation is supplemented by forced ventilation ducted directly into the casing of each battery.

## BATTERY TYPE

Airbus aircraft are equipped with three 25 Ah Nickel Cadmium batteries (figure 2) manufactured by SAFT. These batteries, part number 2520, have the following characteristics :

**Figure 1**

Batteries installation

- Batteries
- Contactor

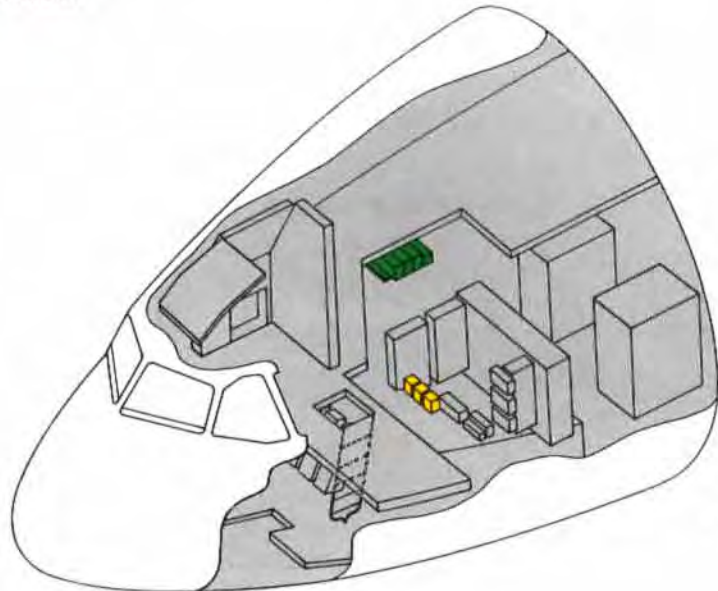

Application	Technical characteristics
<b>Operation :</b> Forced ventilation	<b>Nominal voltage :</b> 24 volts
<b>Operating Temperature :</b> +50°C to -30°C (+122°F to -22°F)	<b>Rated capacity :</b> 25 Ah at 1 hour rate
<b>Internal resistance :</b> 0.011 Ohm	<b>Connector :</b> complying with MS3509 (ELCON BR 8.1, BAC 110 or equivalent)
<b>Max. instantaneous power :</b> (at +25°C) 15 kW (1150 A-13V)	<b>Electrolyte :</b> Solution of KOH specific gravity 1.24
	<b>Consumable volume of electrolyte :</b> 60 ml
	<b>Dimensions :</b> mm 629 x 150 x 221.5 (inches 24.76 x 5.90 x 8.72)
	<b>Weight :</b> 30 kg ±2% (66.1 lbs ±2%)

## BATTERY DESCRIPTION

The battery of twenty VO 25 KA cells contained in a stainless steel box, is separated into two blocks of ten cells by a transverse divider integral with the box (figure 2). Each block of ten cells is placed in a leakproof insulating liner of silicone elastomer. In each of these blocks, inside the liner, the two rows of five cells are separated by one or more plastic spacers which provide sideways packing. Vertical retention is ensured by means of a piece moulded in silicone elastomer, cemented to the cover and carrying a number of bosses which press against the tops of the cells. Cell interconnection is obtained by rigid nickel-plated copper links and end cells are connected by rigid links to an electrical connector manufactured to MS3509. This connects to the aircraft bus. The casing is fitted with a removable cover retained by six latches, two lifting handles and one ventilation tube on each of the front and rear faces.

**Figure 2**

SAFT Battery P/N 2520



### A310 cockpit - Locations of battery controls and indicators

- Electrical power control
- R/L ECAM display
- Warn light display panel (pre mod)
- Master caution (post mod)

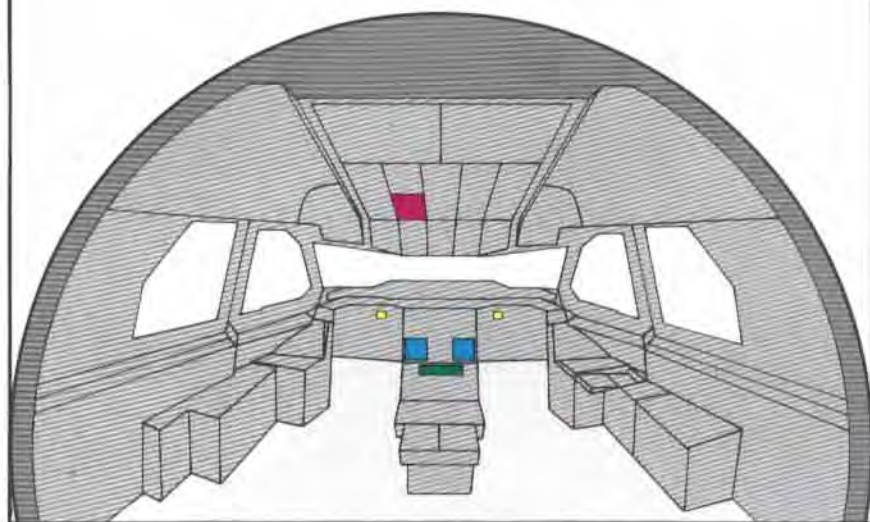

### CONTROL AND INDICATION

The batteries are connected to the aircraft's electrical system (network) shown in figure 3 for :

- starting of the auxiliary power unit (APU),
- supply of on-board DC services, on the ground before the on-board system is on normal supply, and when airborne, in case of fault or failure in the normal supply.

Each battery is protected by a battery charge controller unit which controls the opening and closure of the associated battery line contactor. The main functions of each battery charge controller unit are :

- to automatically connect the batteries to the essential DC network when normal supply has failed,
- to control battery charging,
- to detect an overheat (thermal runaway).

**Figure 3**

Aircraft electrical system

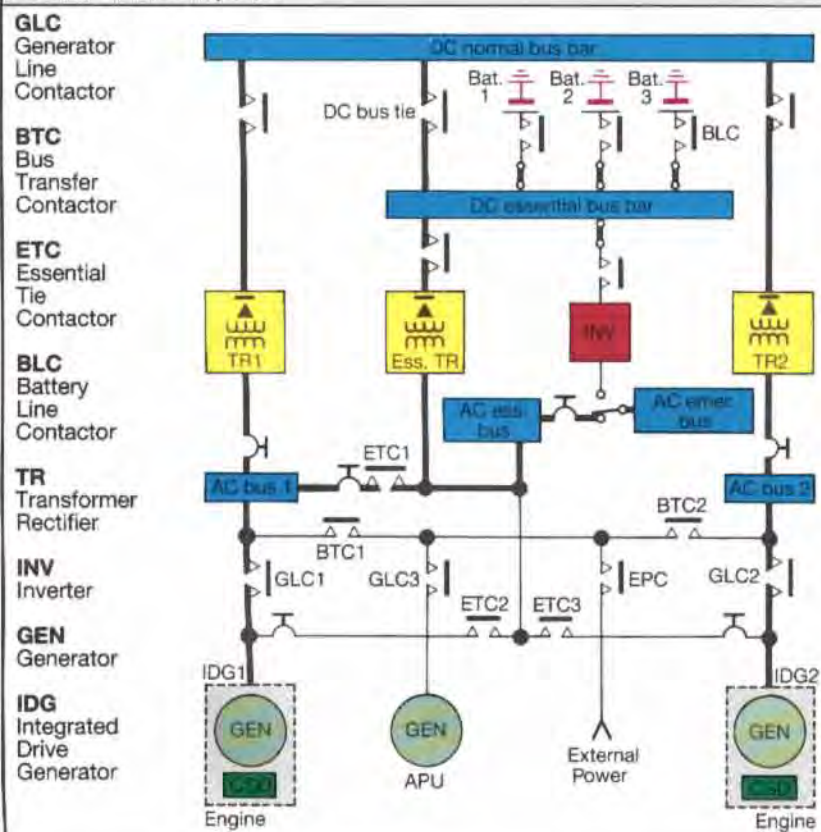

### ELECTRICAL POWER CONTROL PANEL

#### Generation and distribution

#### 1 BAT 1 (2 or 3) p/b switches

Each pushbutton (p/b) switch controls the operation of the corresponding battery charge controller unit.

**AUTO** p/b switch pressed in.

The battery charge controller unit is operating. It automatically controls the connection / disconnection of the corresponding battery to the DC ESS BUS by opening / closure of the battery line contactor. The integrated flowbar is in line to indicate that the battery line contactor is closed or not visible if it is open. The batteries will be connected to the electrical network :

- for the APU starting,
- as a back-up power in the event of a DC ESS BUS voltage drop below 25 V,
- to be charged by the aircraft electrical network in the event of a battery voltage drop,
- when both autopilots are engaged and LAND mode is selected. In normal configuration the batteries are disconnected from the electrical network.

**OFF / R** p/b switch released out.

The OFF / R light comes on white. The battery charge controller unit is not operating and the battery line contactor is open. The flowbar is not visible to indicate the battery is disconnected from the electrical network.

#### ECAM SYSTEM DISPLAY

#### 1 BAT indication

The indication is white but becomes amber when the BAT pushbutton switch is selected OFF / R.

#### 2 Battery voltage indication

The indication is green but becomes amber when the voltage is  $\leq 25$  V, or  $\geq 31$  V.

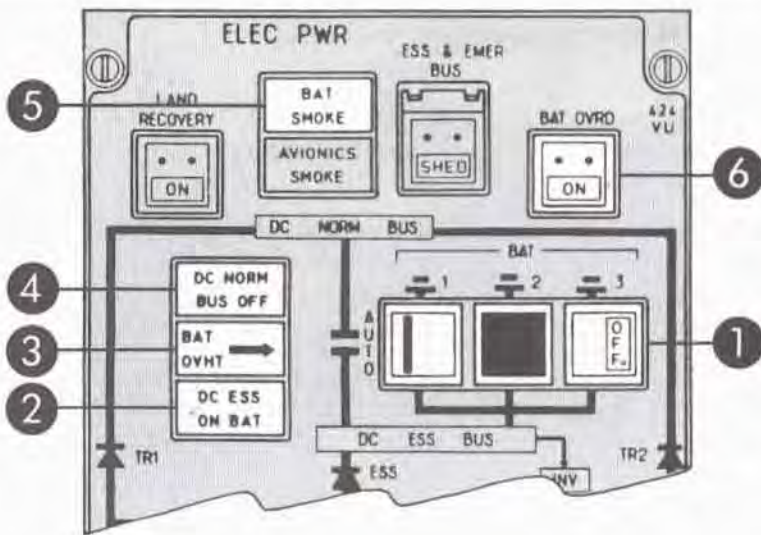

## 2 DC ESS ON BAT light

The DC ESS ON BAT light comes on amber when the DC ESS BUS is electrically supplied by the batteries only, which informs the crew that the bus will be supplied for a limited time. Illumination of DC ESS ON BAT light is accompanied by ECAM activation.

## 3 BAT OVHT light

The BAT OVHT light comes on amber when the charging current for one of the batteries increases at a rate greater than 0.4 A / min. This increase is detected by the respective battery charge controller unit, which causes the opening of the corresponding battery line contactor. Illumination of the BAT OVHT light is accompanied by ECAM activation. The BAT OVHT light goes off when the BAT pushbutton switch associated with the faulty battery is selected OFF / R. This rearms the battery charge controller unit.

**Note:** an overheated battery retains its capacity so it is still usable in an emergency.

## 4 DC NORM BUS OFF light

The DC NORM BUS OFF light illuminates amber when the DC normal busbar is not electrically supplied. Illumination of the DC NORM BUS OFF light is accompanied by ECAM activation.

## 5 BAT SMOKE light

The BAT SMOKE light illuminates red when smoke is detected in the batteries ventilation duct. Illumination of the BAT SMOKE light is accompanied by ECAM activation.

## 6 BAT OVRD p/b switch

The pushbutton switch allows override of the batteries charge controller units by forcing the closure of the batteries' line contactors.

**ON** p / b switch pressed in. The ON light illuminates white. The batteries charge controller units are overridden and all the batteries line contactors are closed. The batteries overheat detection is inhibited.

**OFF** p / b switch released out. The batteries charge controller units control the opening / closure of the batteries line contactors.



## 3 Battery current digital and analog indications

The indications are green but become amber when the current is  $\leq -5A$ .

A white OFF indication is displayed in place of current indications when the BAT pushbutton switch is selected OFF / R and the battery line contactor is open.

## 4 ESS BUS figuration

The figuration is green when the DC ESS BUS is electrically supplied. The figuration is amber when the DC ESS BUS is not electrically supplied.

Ensure that the necessary preparations as stated in the Maintenance Manual are completed.

Release out BAT 1, 2, 3 and BAT OVRD :

The OFF legends will illuminate.

Press the test button on top of the battery charge limiter for approximately fifteen seconds :

Within ten seconds the test light adjacent to the test button will illuminate.

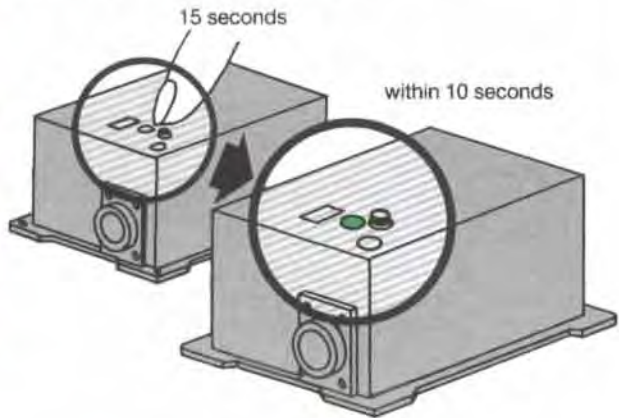
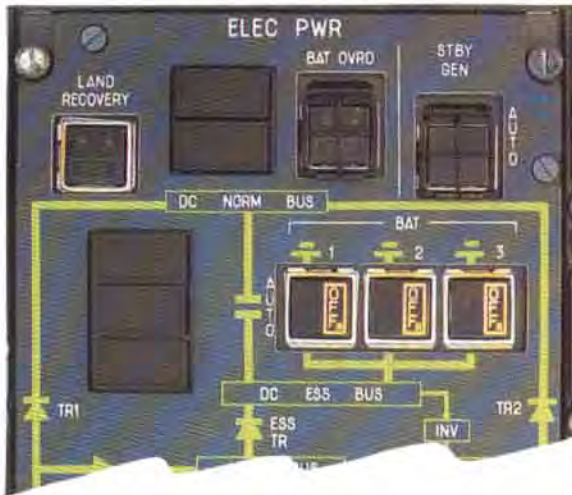

MASTER CAUTION lights illuminate on the captain's and first officer's instrument panels 3 VU and 5 VU accompanied by a single chime.



Within ten seconds the BAT OVHT warning light will illuminate.

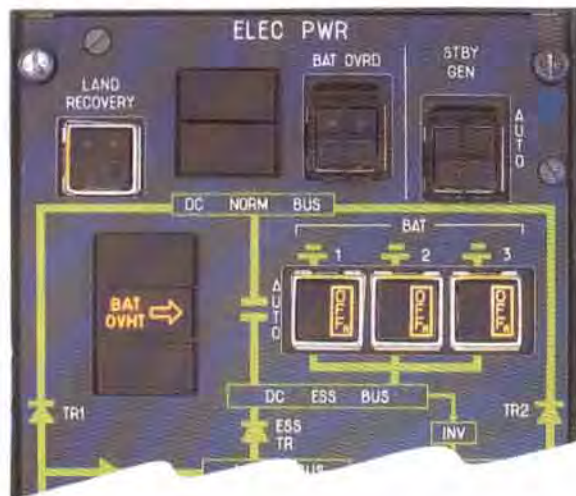

On aircraft with a warning light display panel the ELEC light also illuminates.

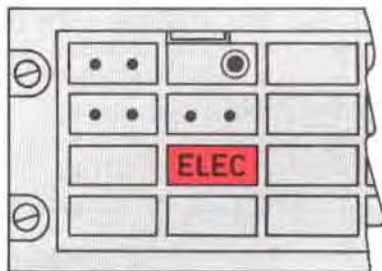

The ELEC system display will come up automatically on the right ECAM provided that no higher priority warning is already displayed on the left ECAM.

The left ECAM display unit shows :



Ensure that the necessary preparations as stated in the maintenance manual are completed.

Press in the BAT OVRD pushbutton switch :

The ON legend in the switch illuminates white. The flowbar in each of the three BAT switches appears in vertical position although the OFF legend remains illuminated.

The ELEC DC system display on the right ECAM shows that the batteries are correctly coupled to the ESS BUS.

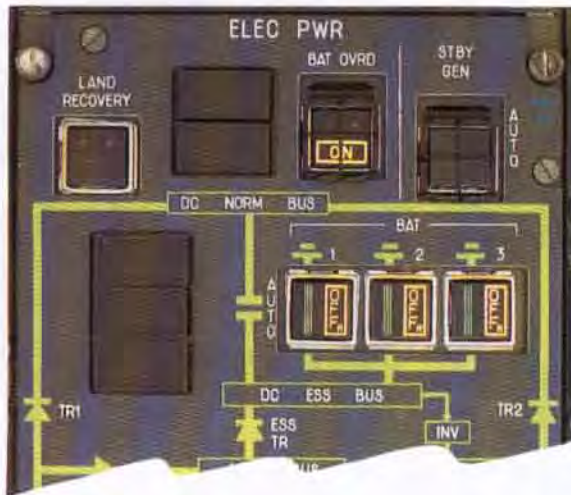

Release out the BAT OVRD pushbutton switch :

The ON legend is no longer illuminated. The flow bar on each of the three BAT switches disappears and the OFF legend remains illuminated.

The ELEC DC system display on the right ECAM shows that the batteries are uncoupled from the DC ESS BUS.

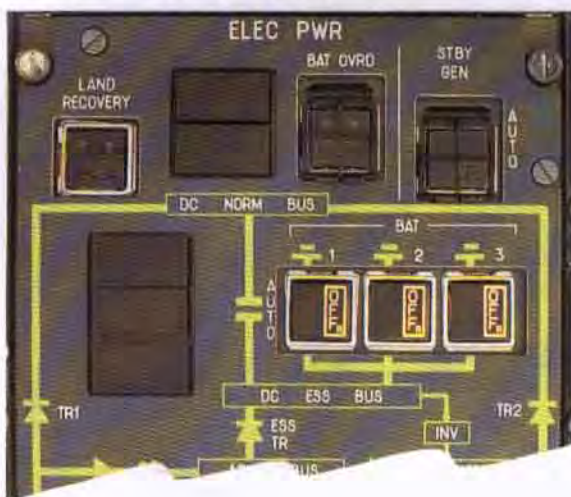

## BATTERY MAINTENANCE

In addition to the checks performed on the battery system mentioned above, the SAFT Component Maintenance Manual (CMM) chapter 24.31.11. requires that batteries are removed from the aircraft at periods **not exceeding six months** for checks in the workshop.

The following required tasks are extracted from the SAFT CMM :

- clean the battery,
- discharge residual capacity at 20 A down to 20 V at the battery terminals,
- note the discharge time, i.e. the time between start of discharge and reaching 20 V,
- continue discharge by connecting across each cell a resistance of approximately  $1\Omega$ ,
- leave the resistors in place overnight.

After removing all the resistors, recharge the battery using the procedure for a battery completely discharged.

During the last hour of the above charge and whilst the battery is still on charge, adjust the electrolyte level in the cells, and measure the voltage of the individual cells. Note also the quantity of distilled water added to each cell.

The electrolyte level varies with the state of charge of the battery, and does not attain a maximum until the battery is fully charged. The effect is as if the plates absorb a part of the electrolyte during the discharge and release it during charge. Measuring of the level can thus only give a useful indication if it is carried out at the end of charge and whilst the battery is still being charged. The level is correct when, having added some water to the cell, and with the shoulder of the syringe nozzle held against the valve seat, a small amount of liquid is drawn up by the plunger. Any addition of liquid made without respecting the conditions would risk causing leakage in normal service. Levelling is correct when the distance, measured under these conditions between the valve seat and the electrolyte is 20 millimeters. If necessary, bring up the level to this value by adding distilled water. **Warning : never use acid or acidulated water** when adjusting electrolyte levels in nickel-cadmium cells. Any trace of acid, however small, causes permanent damage.

The simplest and most conve-

nient tool for adjusting the level is a plastic syringe similar to those used for medical injections, with a plastic nozzle, push fitted on the conical end of the syringe. The length of the nozzle which enters the cell must be 20 mm (figure 4).

**Figure 4**

Method of topping-up with syringe and calibrated nozzle

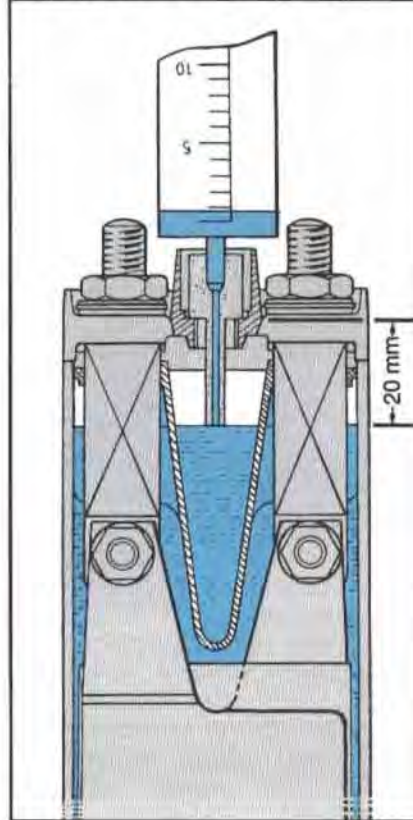

By keeping the shoulder of the syringe nozzle in contact with the valve seat and pulling the plunger upwards, one can judge whether the filling is correct.

- Insufficient topping-up will be shown by the plunger drawing up "empty".
- Any excess of liquid will be drawn into the syringe until the level coincides with the end of the nozzle.

If this check shows that some cells are insufficiently filled, take up some distilled water and inject it into the cells.

All is in order if :

- the first discharge has a duration of more than 30 minutes,
- the second discharge has a duration of one hour or more,
- the individual cell voltages during the last hour of charge at 2.5 A are 1.50 V or more,
- the quantities of distilled water added to the cells are substantially equal and less than 60 ml.

If the duration of the first discharge is less than 30 minutes, whilst the second is correct (1 hour minimum), it may be con-

cluded that the battery is in good condition, but was not fully charged when taken off the aircraft. This condition may be due to insufficient recharge on board, and also to discharge resulting from unexpected demands on the system after landing.

The battery must be given a complete overhaul if :

- the duration of the second discharge is less than 1 hour or if any cells have a voltage less than 1 volt or a reversed polarity before 1 hour of discharge,
- individual cell voltages taken during the last hour of charge at 2.5 A are less than 1.50 V,
- the quantity of distilled water added to one or more cells is very different from the average quantity added to the other cells.

**Note :** the consumption of water by a SAFT nickel - cadmium cell is proportional to the overcharge which it has received. Consumption is therefore substantially the same for all 20 cells in one battery. The fact that one or more cells of the same battery show consumptions noticeably higher or lower than others is an indication of a defect.

- High consumption is generally caused by a leak.
- Low consumption is caused by the partial failure of a separator.
- Consumption is considered to be abnormal when it is more than 20 ml above average, 25% of average or less.

## BATTERY LIFE AND FUTURE DEVELOPMENTS

The A300, A300-600 and A310 fleet is equipped with SAFT batteries, part number 2520, whose average life is 5 years, extending to beyond 7 years in some airlines. These figures however are the result of differing airline operations, ambient temperature conditions, APU start-up cycles, servicing practice, etc.. For the future, the A320 will have batteries with significantly improved performance at extreme temperatures, giving more power, extended life and increased reliability.

## CONCLUSION

Regular and correct maintenance of aircraft batteries is essential for :

- reliability of battery and aircraft operation,
- efficiency of aircraft operation,
- long life of the batteries,
- high dispatch reliability of the aircraft. □

# THE A310-300 FUEL SYSTEM AND CENTRE OF GRAVITY CONTROL

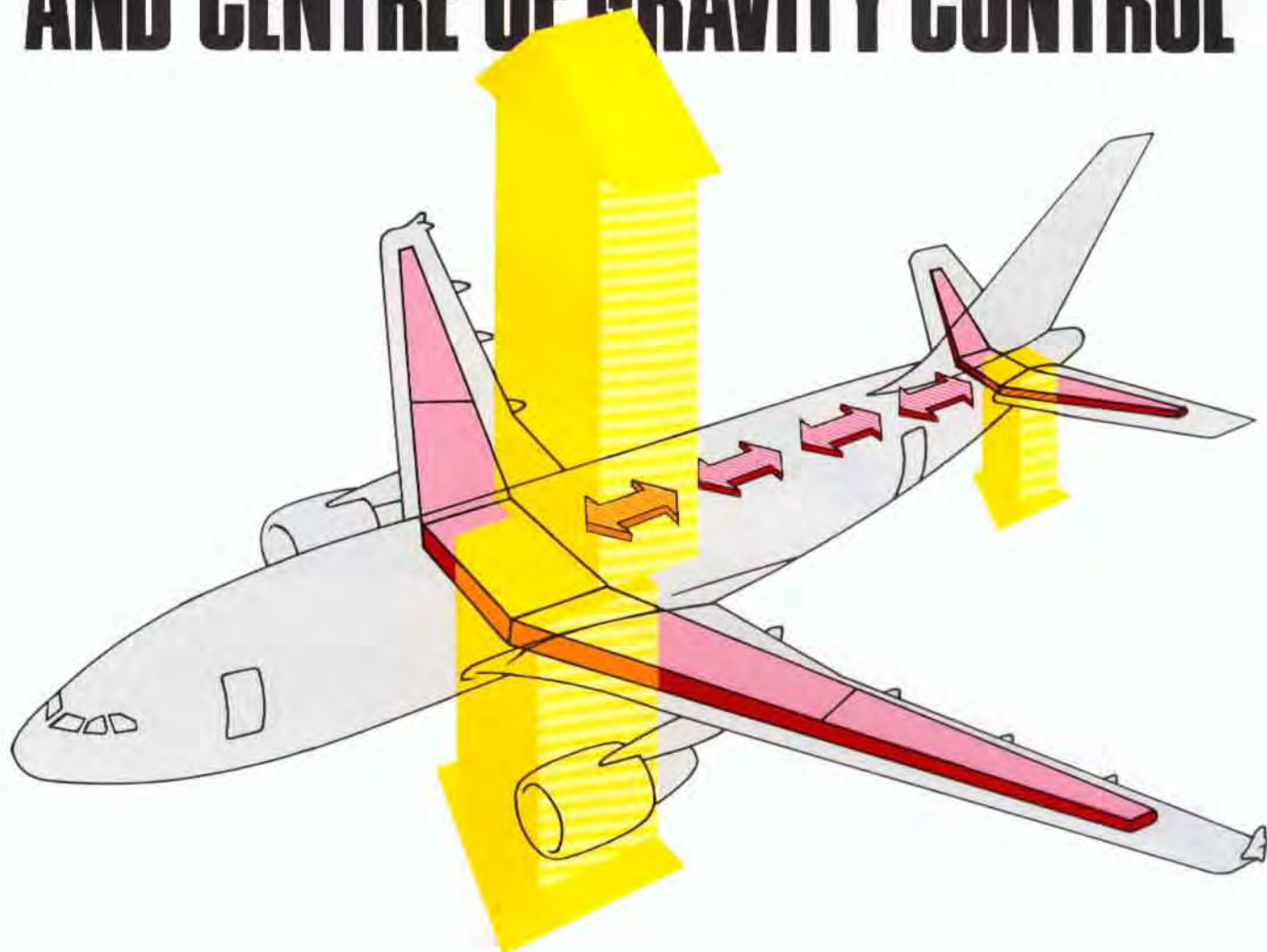

The first Airbus A310-300 has recently entered commercial service. It is based on the A310-200 but has in addition, amongst other things, a fuel trim tank in the horizontal stabilizer. This innovation made viable the introduction of an automatic centre of gravity (C of G) control system. The result of combining the two systems is increased fuel capacity and a significant performance improvement in all cruise



Colin Orme  
Fuel System Engineering







conditions whatever the fuel uplift. The purpose of the following article is to provide a simple description of the overall fuel system with particular emphasis on the

new features. This will form the basis for a better understanding of how the system functions and thus enhance the effectiveness/efficiency of maintenance activities. Also highlighted are the operational benefits inherent in the new system.



## GENERAL LAYOUT

The basic layout of the fuel system (figure 1) remains identical to the A310-200 series but with new and adapted equipment, pipes, etc... directly associated with trim tank operation, control and indication.

- Refuel / Defuel system
- Fuel distribution pipe
- Transfer pipe
- Vent pipe (LH wing only)
-  Refuel / Defuel valve
-  Isolation valve
-  Fuel pump
-  Diffuser
-  Refuel / Defuel coupling
-  NACA inlet

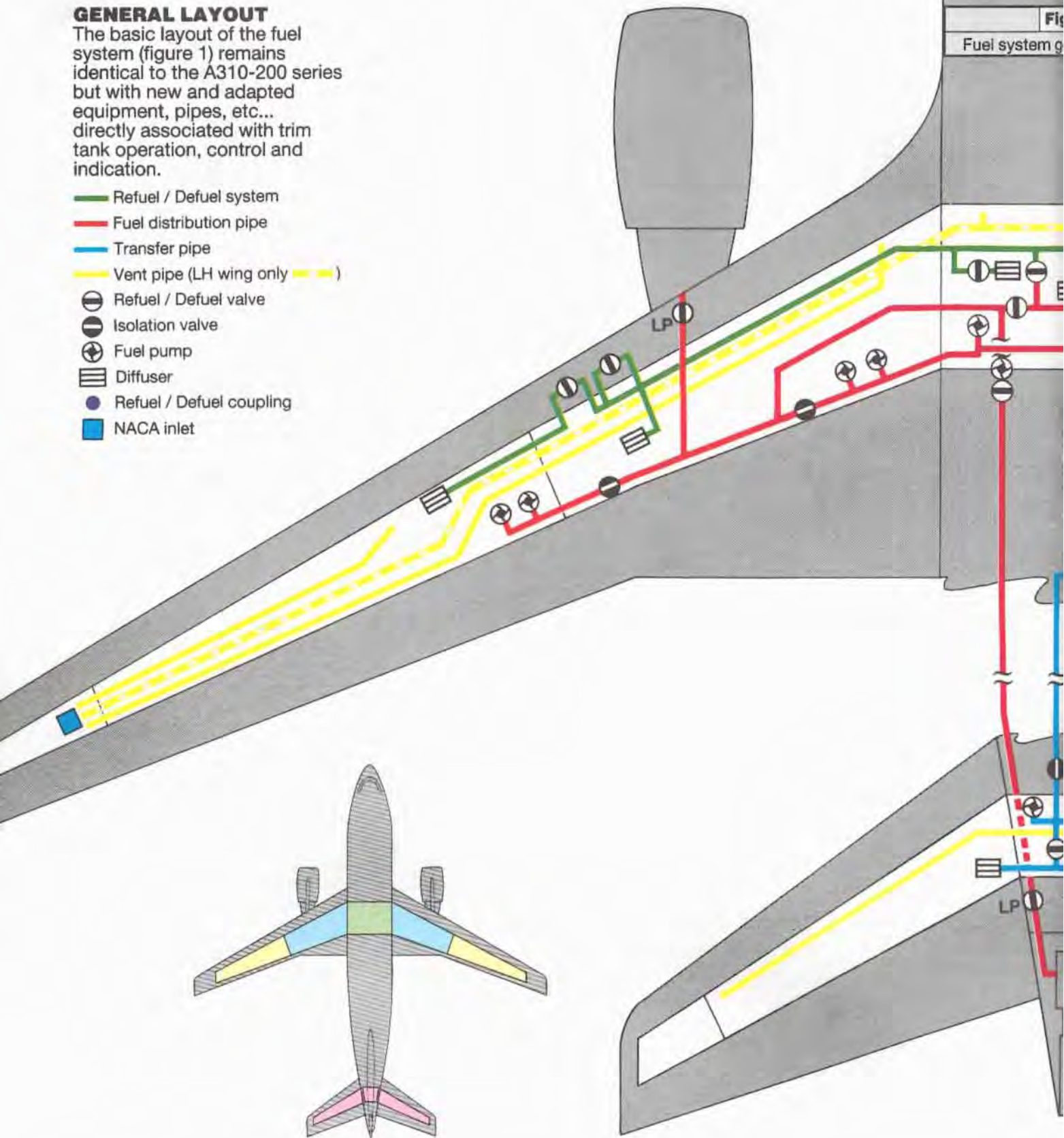

## TANK CAPACITIES AND LOCATIONS

	Usable fuel					
	Outer	Inner	Centre	Trim	Total	
Volume {	Litre	3,700	13,950	19,640	6,150	61,090
	USg	978	3,685	5,189	1,625	16,140
Weight kg density 0.8	2,960	11,160	15,712	4,920	48,872	
Weight kg density 6.68 lbs / US Gal	6,525	24,605	34,642	10,848	107,750	

## REFUEL

Tank refuelling is sequenced automatically, filling the tanks simultaneously if a full fuel load is required and in the following order when lesser loads are required - outer tanks, inner tanks, centre tank, then the trim tank. Refuelling time is approximately thirty minutes at 50 p.s.i.

Figure 1  
General schematics

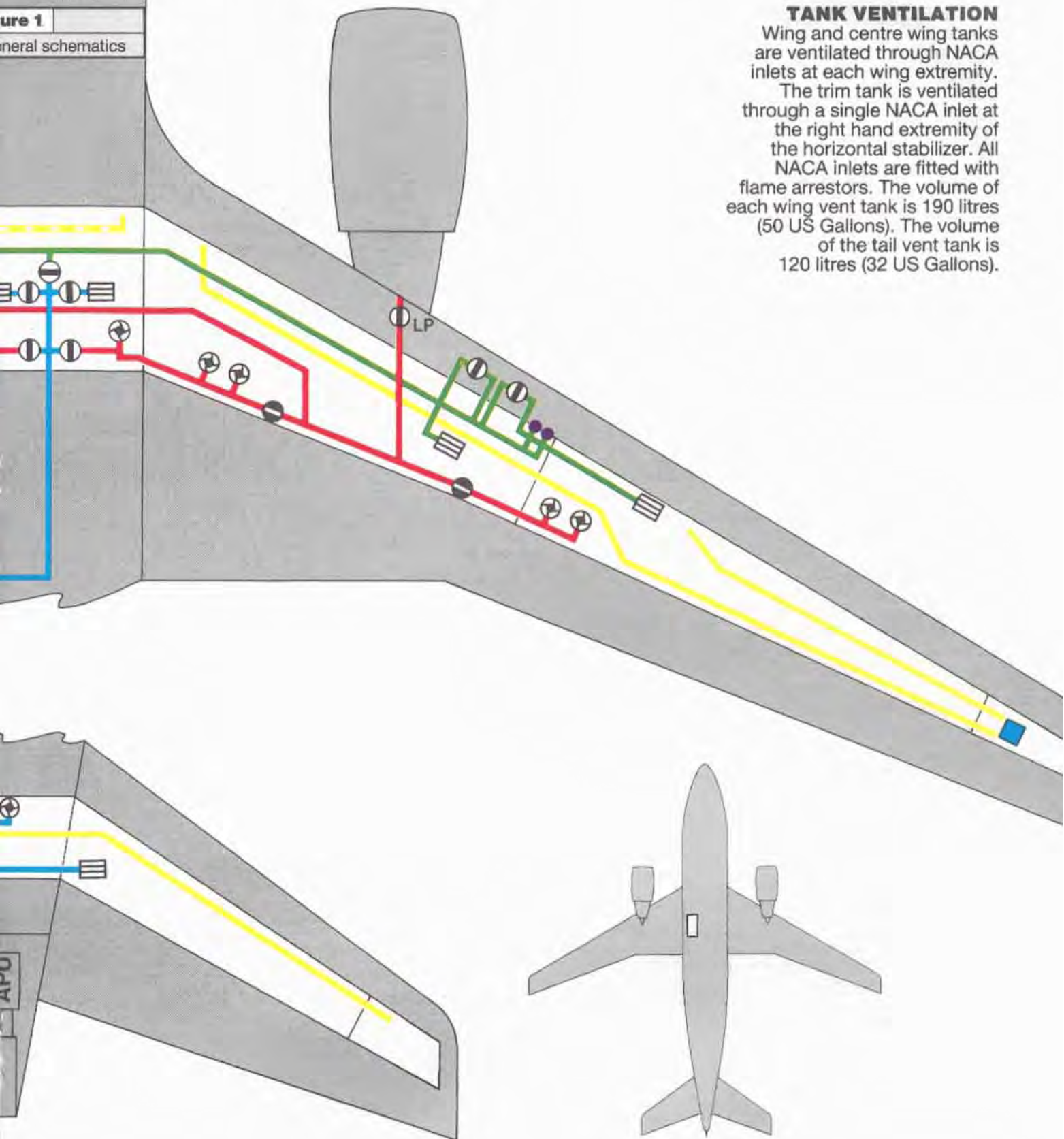

### TANK VENTILATION

Wing and centre wing tanks are ventilated through NACA inlets at each wing extremity.

The trim tank is ventilated through a single NACA inlet at the right hand extremity of the horizontal stabilizer. All NACA inlets are fitted with flame arrestors.

The volume of each wing vent tank is 190 litres (50 US Gallons). The volume of the tail vent tank is 120 litres (32 US Gallons).

### REFUEL / DEFUEL

The refuel / defuel control panel is located in the air-conditioning fairing on the lower fuselage close to the leading edge of the right hand wing, within reach of the ground. As an option an additional panel may be located in the maintenance panel on the flight deck.

### REFUEL / DEFUEL PANEL

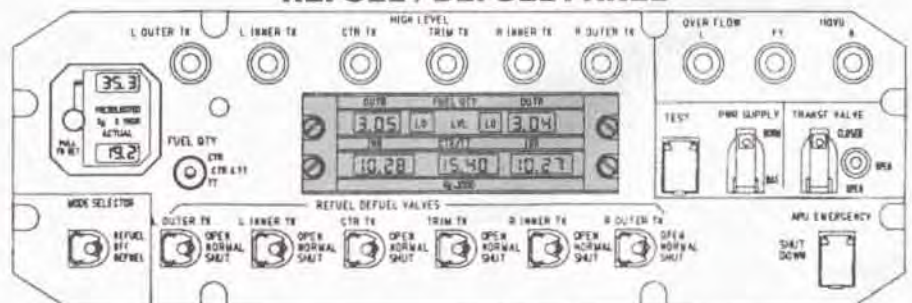

## ENGINE FEED

Fuel is fed to the engines by means of identical fuel pumps, two with separate power supplies being fitted in each tank. In normal operation, the left engine and the APU are fed from the tanks in the left wing. The right tanks feed the right engine.

There is no direct engine feed from the trim tank, it being considered an extension of the centre tank. Fuel in the trim tank is automatically transferred to the centre tank as a function of centre of gravity control. In the event of total pump failure fuel transfer from the trim tank to the centre tank can be made by gravity. The trim tank is isolated during take-off and landing. Fuel feed from the tanks to the engines is in the following sequence :

- From the centre tank when the aircraft is on the ground at engine start and in flight when the slats are retracted.
- From the inner tanks, at take-off, with slats extended, and when the centre tank is empty.
- From the outer tanks when the centre and inner tanks are empty. The fuel pumps in the outer tank operate permanently at a lower pressure than the fuel pumps in the other tanks and thus provide a constant back-up to the feed from the inner and centre tanks.

## CONTROL AND INDICATION

Figure 2 shows the locations and types of controls and indications available to the flight crew.

## FUEL TRANSFER CENTRE OF GRAVITY CONTROL

### System layout and operation

One shrouded 2 in. transfer pipe connects the trim tank with the centre tank as is shown in figure 1. This pipe serves for refuel / defuel purposes and forward or rear transfers associated with centre of gravity control. A dedicated valve installed at the trim tank permits tank isolation.

### Refuel

In the centre tank the transfer pipe communicates with the aircraft refuel manifold by means of a solenoid operated refuel valve. A further refuel valve is located at the trim tank. Both valves are open when the trim tank is refueled (figure 3a).

### Transfer - Rear

The transfer pipe is also connected to both left and right

**Figure 2**

Location of control and indications

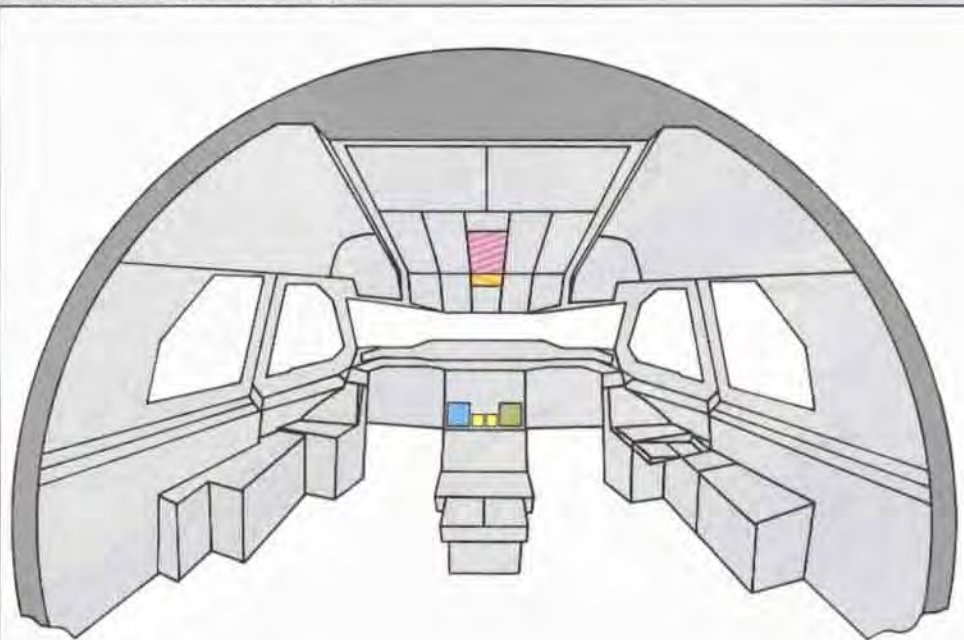

- Flight crew actions are confined to initiation and termination using the push button controls on the FUEL overhead panel.
- The total quantity of fuel remaining and the quantities remaining in each tank (centre and trim tanks are treated as one) are displayed permanently on the FUEL QTY overhead panel.
- Fuel flow and total fuel used are also shown on two instruments on the centre panel. Warning of low fuel level is totally independent of the fuel quantity indicating system and is displayed on the FUEL QTY overhead panel.
- Total quantity is also shown on the No.1 display unit (DU1).
- The fuel system synoptic diagram is shown on the DU2 fuel system page (a) and fuel flow is shown on the DU2 cruise (CRZ) page (b).

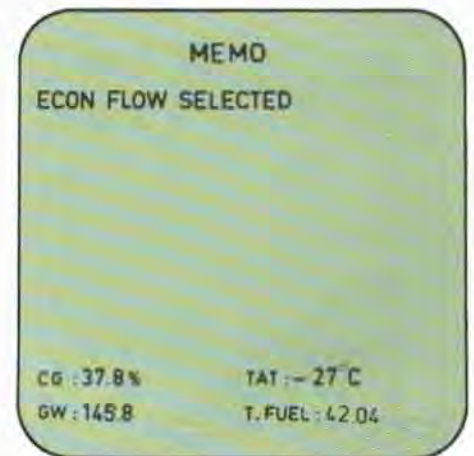

**Figure 3**

System layout and operation

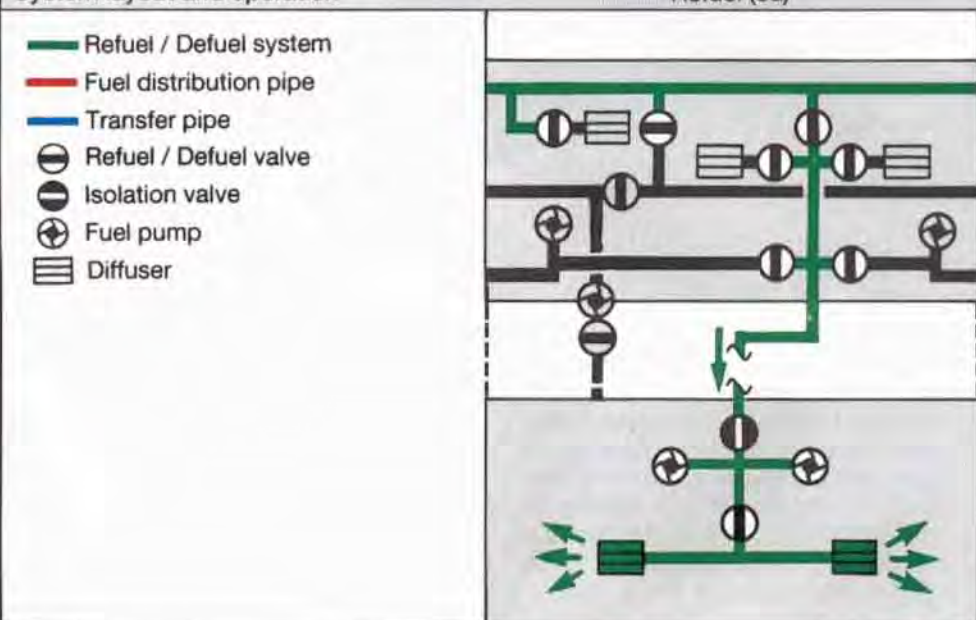

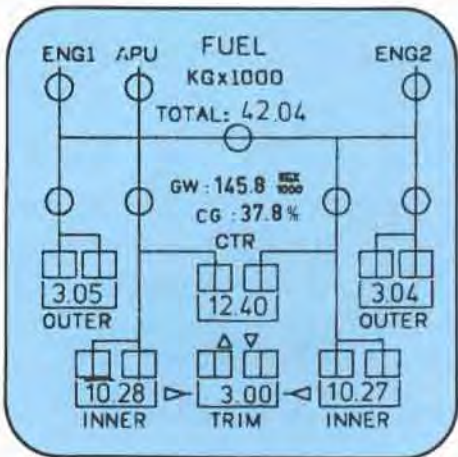

page (a)

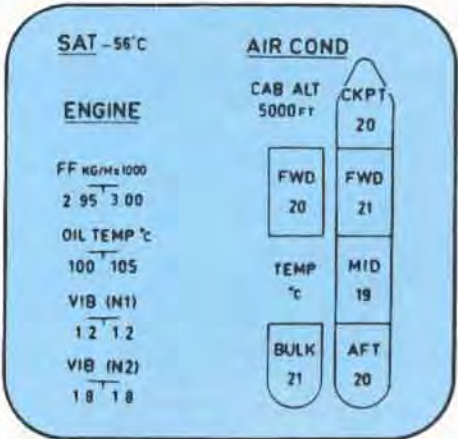

page (b)

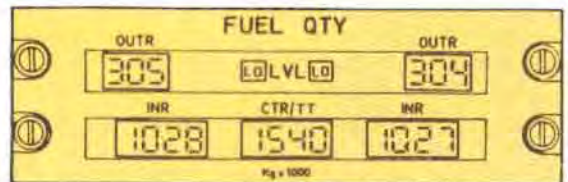
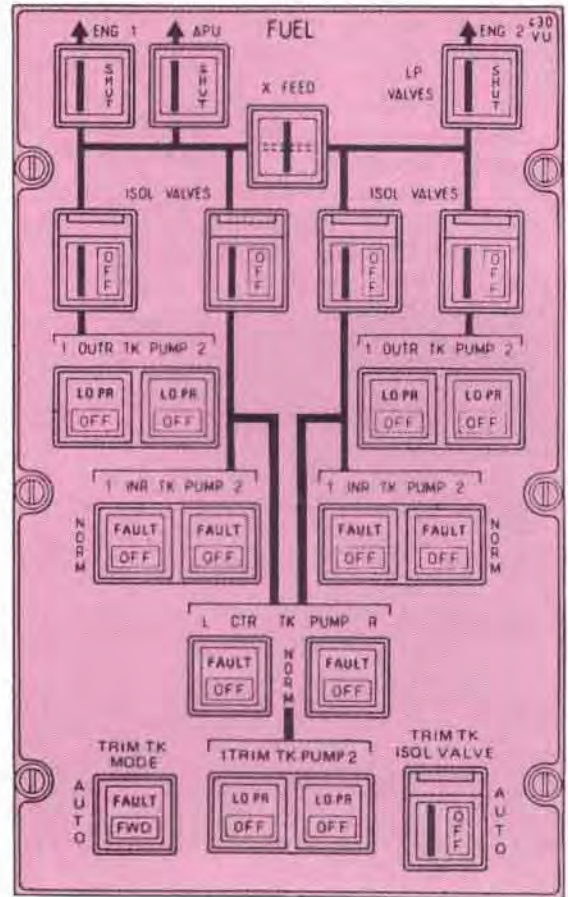
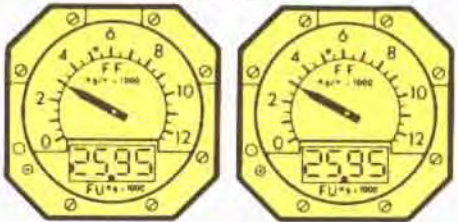

Transfer-Rear (3b)

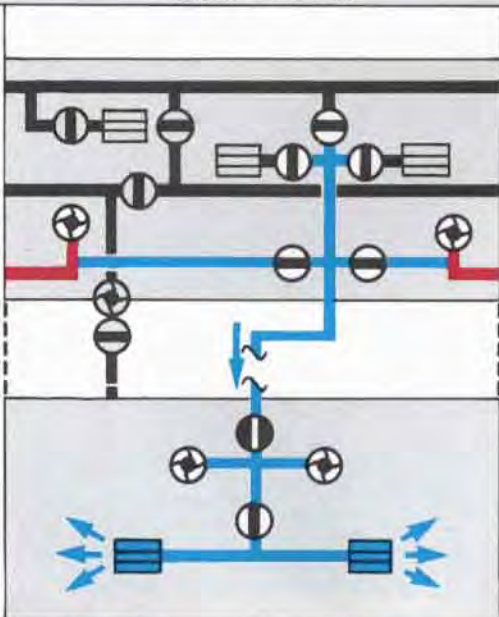

Transfer-Forward (3c)

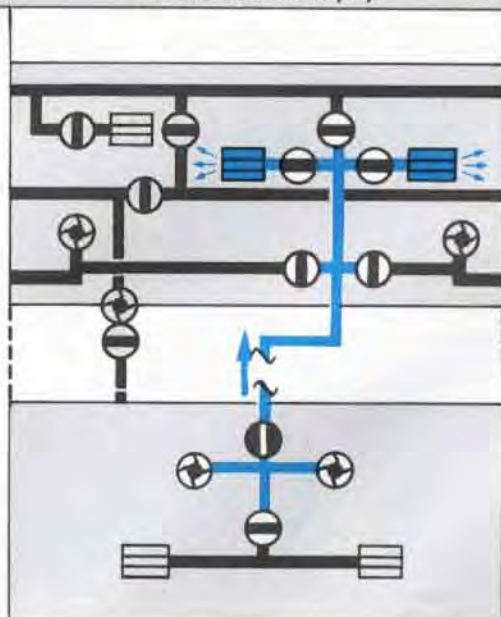

engine feed systems. When the control valves installed in the centre tank are opened, the fuel pumps provide motive power for rear transfers as well as engine feed, irrespective of which tank is feeding the engines. At this time the trim tank refuel valve is automatically opened (figure 3b).

#### Transfer - Forward

The outlets from the two pumps installed in the trim tank are connected to the transfer pipe downstream of the refuel valve. There are two diffusers connected to the same pipe but within the centre tank. Flow forward through the transfer pipe is controlled by two shut-off valves, one for each diffuser. When the system is in auto mode with both pumps in the trim tank operating transfer is through one diffuser only. However both diffusers are used for the final forward automatic transfer and when the system is in manual mode with or without trim pumps operating (figure 3c).

#### Control

A dedicated centre of gravity control computer (CGCC) is installed in the electronics bay. It receives load and trim sheet information, manually inserted into the flight management system (FMS), together with various signals associated with fuel system and other relevant parameters (e.g. fuel quantity, fuel valve status, pump status, fuel flow, tail plane angle..etc). Based on this information it continuously calculates aircraft centre of gravity and compares this with the target. From this it establishes the quantity and direction of transfer and gives the appropriate command signal.

The computer continuously

**Figure 4**

A310 Payload range capability

- A310-300 - Full pax + 31550 lb cargo
- A310-200 - Full pax + 30000 lb cargo

(Typical international rules, ISA conditions)

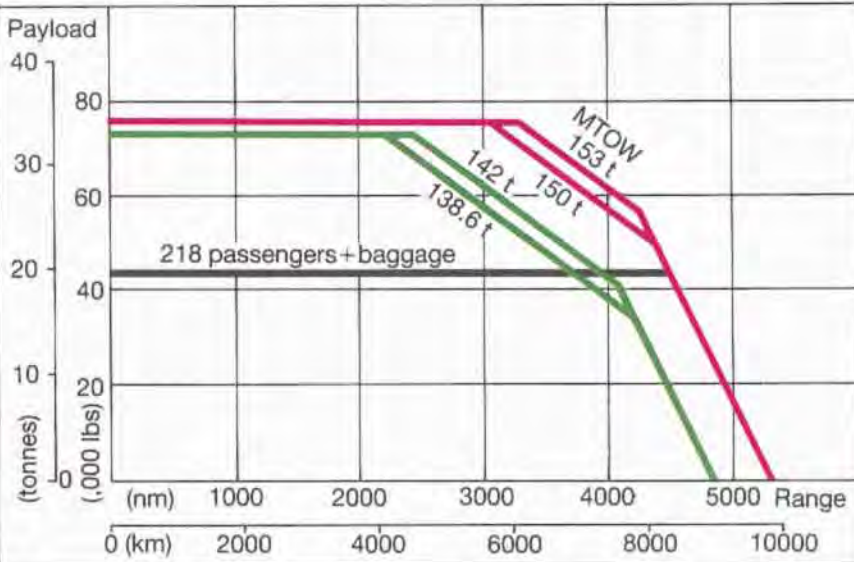

monitors incoming information before and after a transfer. Any signals which are outside the permitted range - or which cannot be validated - result in an appropriate mode change and a corresponding new command signal. For example "transfer all fuel forward".

As a back up and in the event of computer failure there is a separate centre of gravity monitor which takes information from independent sources. Appropriate manual action is taken by the crew if this monitor trips. The computer is active throughout ground and flight phases, but automatic transfer command signals will only occur after slats are retracted in flight. An initial centre of gravity target,

compatible with take-off and landing requirements is used up to 20,000 feet. Above this level the normal flight centre of gravity target is assumed. During descent at 20,000 feet, if fuel remains in the trim tank, it is automatically pumped forward.

#### CONCLUSION

Apart from the increase in range, shown in figure 4, derived from the installation of a trim tank, its use for controlling the movement of the centre of gravity of the A310-300 gives positive performance benefits particularly in the cruise configuration while maintaining the full passenger and cargo carrying capability of the A310-200. □

More efficient production of net lift = lower drag + lower fuel burn

- Load without centre of gravity control
- Load with centre of gravity control

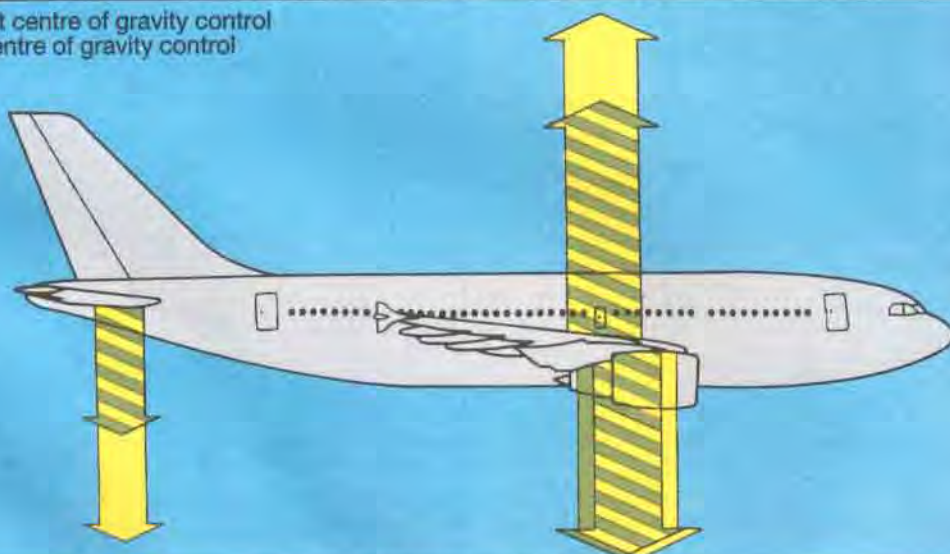

Cruise drag reduction of up to 1.5%



**C  
A  
R  
B  
O  
N**

**B  
R  
A  
K  
E  
S**



Georges Bardou  
Group Manager  
Mechanical Systems

Saving weight has always been a major concern of aircraft manufacturers and it was the case particularly in the 1970s during the development of the supersonic airliner Concorde. That was when carbon brakes for civil airliners were first developed in spite of their high cost. At that time the carbon discs were made of carbonized nylon cloth reinforced by a carbon vapor deposit (CVD). A full decade passed before the carbon brakes became cost effective on subsonic airliners.



### TESTS

In 1982 Airbus Industrie, with the collaboration of the equipment suppliers, launched a development study to prove that new types of carbon were acceptable technically and economically. This study was based on material characteristics and laboratory tests followed by partial disc tests, to evaluate amongst other things, torque behaviour, mechanical resistance and the effects of environmental conditions, such as humidity.

Following fly-wheel and aircraft tests with a full size brake it lead Airbus Industrie to undertake two actions :

- an in-service evaluation in 1983 in collaboration with Air France in which an A300 was equipped with one carbon brake

and seven steel brakes. Test instrumentation allowed good follow-up of the carbon brake in operation,

- a long term study and demonstration on an A310 owned by Airbus Industrie.

These two consecutive and complementary developments were undertaken to get a better understanding of the behaviour of different carbon materials in normal and abnormal service (wear rate, disc damage, etc...). The results were quite encouraging, in that there was no abnormal wear and in fact the wear rate steadily improved with different materials and no disc ruptures occurred.

### TEST RESULTS

Consequently the principles for braking systems for steel brakes

**Figure 1**

Heat pack general design

- Rotor
- Rotor drive block
- Stator
- Stator drive block

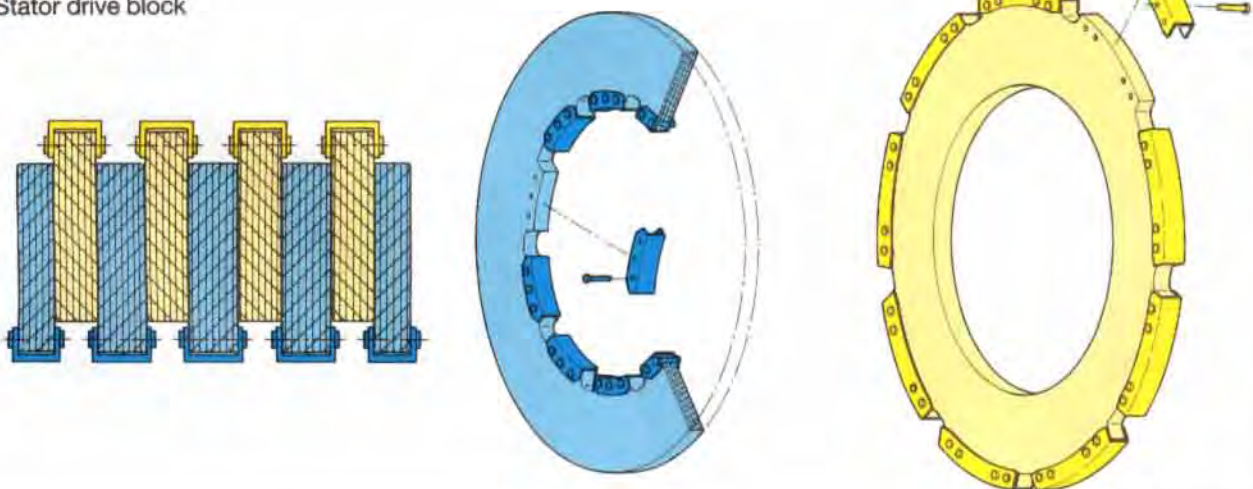

required no change to accommodate carbon brakes. Only the anti-skid servo-system and temperature warning settings had to be adapted, as is the case when any new brake is developed. It was proved that the carbon brake technology was advanced enough to be offered for fitment to subsonic airliners without fear of unreasonable trouble or cost.

### IN-SERVICE

Airbus Industrie certified carbon brakes for service on the A300-600 and the A310 in 1985. Following additional flight tests the A300B4 aircraft have been certified to operate with the same brakes as are fitted to the A300-600 and only minor adaptations are necessary to install them.

### THE MATERIAL

The carbon material used today has been improved dramatically since 1970. It now consists of PAN (Polyacrylonitrile) fibres which can be used in a random manner or in cloth form. A disc, on a basic Airbus carbon brake, comprises several layers of carbonized fibres arranged in such a way that resistance to forces is assured in different directions. These are then impregnated and densified by a carbon vapour deposit (CVD). The final heat treatment is made to stabilize friction properties, thermal conductivity, humidity, resistance, etc. A different process may include impregnation of a resin before the CVD process.

The discs are machined to their final shapes and the non-rubbing surfaces are protected against oxidization, usually by a compound applied like a paint. (Some manufacturers introduce

a specific anti-oxidization compound into the disc before the CVD process). These compounds have the benefit of self renovating as temperature increases and they prevent weakening of the discs, particularly in the driving slots. Metal driving blocks are rivetted on to the teeth on the inner circumference of the stators, and on the outer circumference of the rotors. These metal driving blocks provide protection to the carbon discs during their installation on to the axles and when the wheels are being installed over the brake units.

### ADVANTAGES

#### Weight

This is the main advantage. A reduction of 560 kg (536 kg for the brakes, 24 kg for the wheels) is the benefit on the A300-600, the carbon heat packs weighing about one third of the comparable steel heat pack. The brake support structure is basically the same for either brake.

#### Energy overload

This parameter is one not to be neglected. Tests have been performed on aircraft at higher energy than specified and the character of carbon is such that even in these conditions a braking torque is maintained (figure 2). Carbon can accept very much higher temperature than steel (2500°C instead of 1200°C) before encountering severe limitations in performance (figure 3). This characteristic allows the refurbishing of discs submitted to high energy rejected take-offs. However this ability to absorb energy results also in very high temperatures in the heat pack. Heatshields are therefore installed inside the wheel, not only to

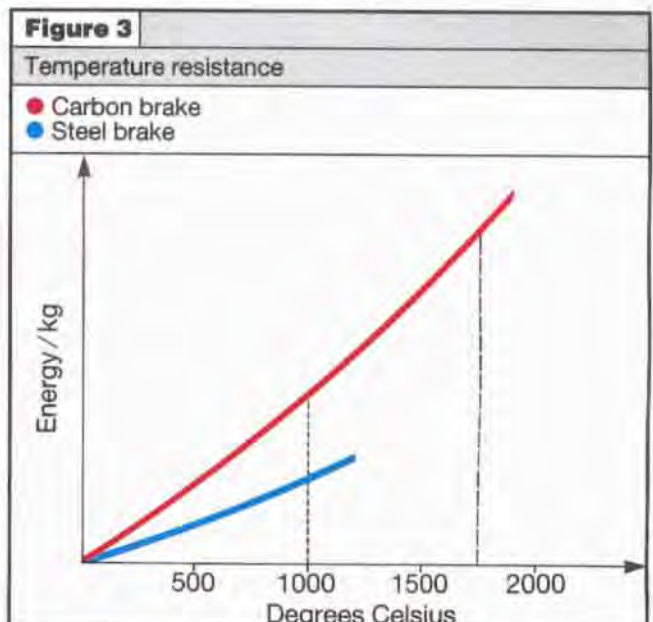
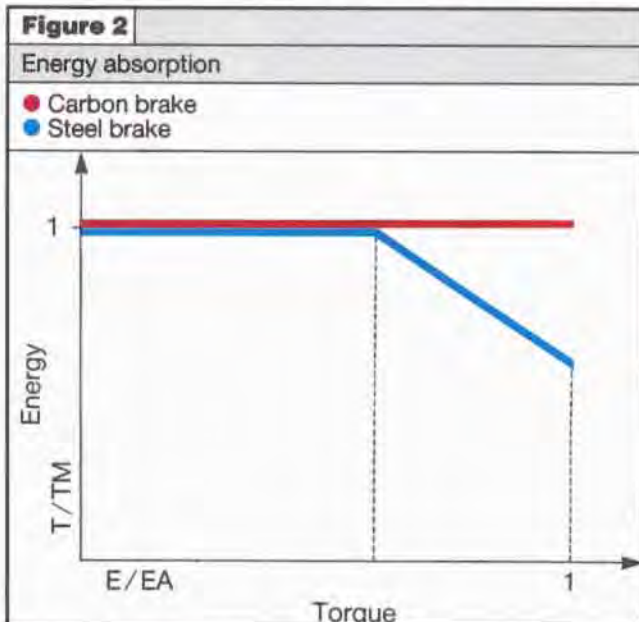
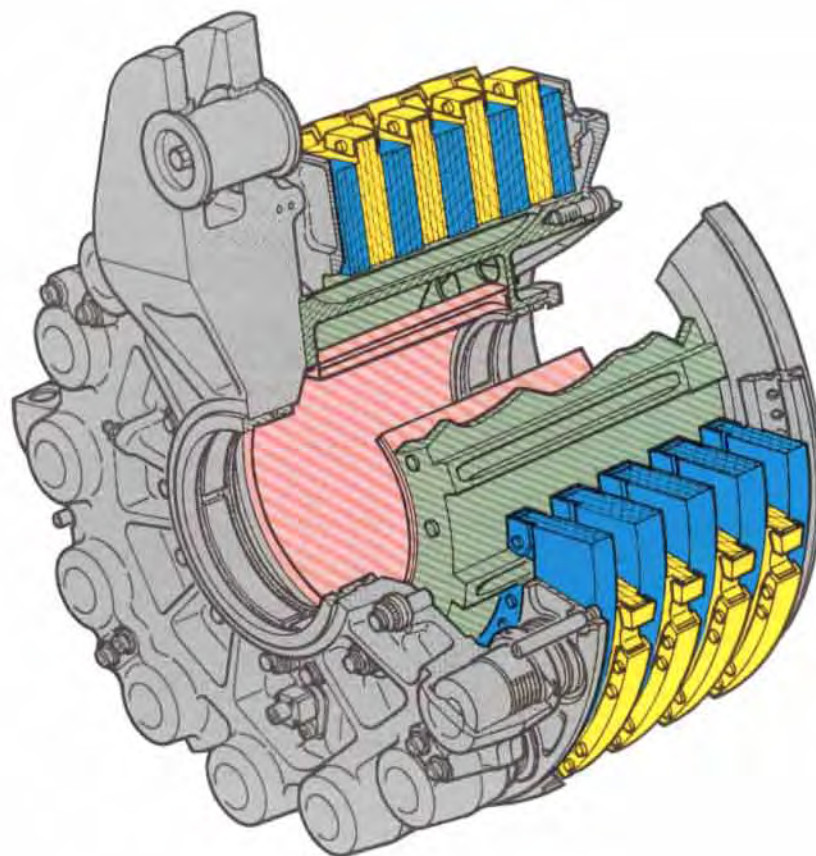



**Figure 4**

A300/A310 carbon brake

- Rotor
- Stator
- Torque tube
- Heatshield



protect the hub and tyre (as is conventional practice with some of the manufacturers of steel brakes), but also to protect the axle and axle equipment (figure 4).

#### **Humidity**

It was suspected that carbon brakes might be sensitive to the effects of humidity however it has been proven in the laboratory, on a "humidity campaign" in Dakar, Senegal. In October 1985 using an A310-300 with certified brakes and in-service with Thai Airways and Swissair that their operation is fully satisfactory.

#### **Refurbishing**

The method of refurbishing which has been certified is the well known "two for one" method. Two worn discs are machined and then assembled to make one new disc with a coating of anti-oxidization paint on the faying surfaces and held together by the metal drive

blocks. Another method being studied is to bond two new "wear" discs to the machined worn disc.

#### **RETROFIT**

Carbon brakes are now certified to be retrofitted on the A300 and A310-200. What are the benefits which would make replacement of steel brakes by carbon brakes worthwhile? The answers are as follows:

- Weight savings of 560 kg per aircraft.
- Fuel savings due to the reduced weight worth about \$15,000 per year at 2,500 fh per year, or additional payload of 560 kg.
- Worn carbon discs are reusable.

These benefits will ensure a return of investment within 24 to 36 months when approximately 5% of annual flights carry the full additional payload. □



**The introduction of carbon brakes into service on Airbus aircraft has been trouble free.**

**Carbon brake systems are governed by the same principles as for steel brakes but will withstand much higher temperatures while still providing high braking efficiency. Airlines have the choice of reducing the weight of each aircraft by half a tonne or carrying half a tonne more payload.**

*We thank MHB for the photographs and technical information supplied for this article*

# SIMPLIFIED ENGLISH



Michael Stiles  
Technical Publications  
Manager  
Production Coordination

Anyone who has experience in the preparation of technical documentation, will appreciate the problems that arise when trying to select the right words. Do you **start, begin, commence, or initiate** an action? Perhaps this is no great problem to a reader whose mother tongue is English, but to the rest of the world it can be confusing to use more than one word for the same meaning. Similarly, does **fall** mean **decrease** or **move down under the influence of gravity**? Here we have one word with two meanings.

Between writers, the grammatical constructions can also be different, adding still more to the difficulties of the reader.

To standardize the vocabulary and style of writing, a simplified version of the English language has been developed. The name chosen for this is Simplified English (SE).

## HISTORY

In 1979 the Association of European Airlines (AEA), asked the European aviation industry association - Association Européenne des Constructeurs de Matériel Aérospatial (AECMA) to apply a form of basic English to future documentation. A joint AEA / AECMA investigation of this subject took place in 1980. In 1981 the AECMA documentation working group decided to develop a form of controlled English specifically for aircraft maintenance, with FOKKER taking the leadership of the project. During 1982 the first text analysis was done and approximately 1000 verbs were extracted from existing Maintenance Manual texts. At a series of meetings, this list of verbs was discussed and rationalized. A list of recommended verbs, containing 150 of the original 1000, was published in 1983. In the same year, the draft writing rules for Simplified English were published. These rules give guidelines for the construction of sentences, paragraphs and the use of punctuation. In 1984 similar exercises took place to select nouns, adjectives, adverbs and prepositions.

## WHAT IS SIMPLIFIED ENGLISH ?

Simplified English is a set of rules for writing English.

These rules will :

- make the text easier to read as only approximately 500 different words will be used (excluding nomenclature) ; each word has one clearly defined meaning,
- standardize the grammatical construction through the writing rules,
- standardize texts between all manufacturers who wish to use Simplified English,
- make the texts more understandable, especially to non-English speaking people.

### NOUN CLUSTERS

*Example : The engine exhaust gas cooling is ...*

*In this example the relationship between the words is not clear. After the article **the** the reader has to go past three modifying words before he gets to the main noun **cooling**.*

*The writer has built up the group of words like this :*

**Cooling - Gas cooling - Exhaust gas cooling - Engine exhaust gas cooling.**

*Such noun clusters are almost impossible to read for some non-English readers. This is probably because these readers begin with the first noun **engine** (in the example above) as they do in their own language. But the noun the reader needs, **cooling**, is at the end of the noun cluster.*

**Engine exhaust gas cooling = The cooling of exhaust gas from the engine.**

*Rule : Break up noun clusters with more than three nouns together.*

It is estimated that non-English speakers can learn the limited Simplified English vocabulary in forty hours. This should make translation largely unnecessary. However in the event that translation is required Simplified English will make the task easier and the one word - one meaning philosophy will also make machine translation possible.

Example :

Write : **where grease comes out to show that there are leaks**  
not : **that provides grease extrusion leakage detection**

#### **PART OF SPEECH**

Other than technical names, you can only use words from the "List of Approved Words". You must use these words as the part of speech given in the list. Thus, for example, if a word is shown as a noun, you cannot use it as a verb.

Example : **test** is a noun (and not a verb).

Write : **do the leak test for the system**

not : **test the system for leaks**

#### **ARTICLES BEFORE NOUNS**

If it is possible, you must put an article **the, a, an** or a demonstrative adjective **this, that, these, those** before a noun. This helps your reader to identify a word as a noun (particularly technical names). Example :

Write : **stop the start procedure if N2 is more than**

not : **stop start procedure if N2 is more than**

## **WHAT SIMPLIFIED ENGLISH IS NOT**

Simplified English is not "baby" English and does not mean mountains of paper. Experience has shown that writers using Simplified English look more critically at their text and are forced to be clear and precise.

A good example of before and after Simplified English follows :

Before : **It is equally important that there should be no seasonal changes in the procedures, as, although aircraft fuel system icing due to water contamination is more often met with in winter, it can be equally dangerous during the summer months.**

After : **Use the same procedure all the time, because water in the fuel system can freeze during winter or summer.**

## **HOW THE WORDS WERE SELECTED**

A set of rules were established to govern the selection of a word approved for use in Simplified English. Using these rules small groups have discussed and rationalized the lists of words that had been compiled from existing documentation. The list of "approved" words is the outcome of the work of these groups.

Each word has one meaning : **observe** means **look carefully** not **follow rules**.

**One word for each meaning** : **help** not **aid, assist, facilitate**.

The shortest word : **stop** not **discontinue**,

**make** not **fabricate, manufacture**.

The most international word : **occur** not **happen** (French association), **ground** not **earth** (American).

Minimum of irregular verbs : **start** (starts, started, started), not **begin** (begins, began, begun).

Limit the number of auxiliary verbs : **can, do, must, will** and not **may, ought, shall**, which are insufficiently definite.

Use high frequency verbs : **show**, not **denote, move** not **displace**.

## **THE FUTURE OF SIMPLIFIED ENGLISH**

The list of approved words and writing rules cannot be considered as "frozen". Not every word in the English language has been considered and writers will undoubtedly require clarification on some words. A system of requests for change has been established and the Simplified English group will meet as and when required to provide updates to the Simplified English lists.

The possibility of providing a training package in Simplified English to the airlines is under consideration by Airbus Industrie, in cooperation with outside publishing houses. This will be of assistance to those airlines who have to train their technicians in English, to allow them to understand manufacturers courses or documentation.

## **SIMPLIFIED ENGLISH IN AIRBUS DOCUMENTATION**

For existing documentation, some Description and Operation topics from the Aircraft Maintenance Manual have been used to gain experience in the writing of Simplified English by application of the writing rules and use of the list of approved verbs. This has proved a useful exercise and in one topic for example, it was found that fuel was : **pumped, supplied, fed** and **distributed**. The text has now been standardized with **supplied**.

This year will see the publication of the complete Airbus Simplified English word list, the list of Standard phrases and the writing rules, which will be used in the preparation of the A320 documentation. The clear and simple style of writing imposed by the use of Simplified English in the documentation will be of great assistance to the airlines and the aircraft industry in general, i.e. will help everybody ! □

# DISPATCH RELIABILITY

## Part 2 Improvement Programme

*Continuing with the series of articles on means to improve dispatch reliability, this issue provides information on modifications designed to avoid potential hydraulic leaks.*

Study of records disclosed that existing improvements, designed to avoid loss of hydraulic fluid and pressure, are not yet fully recognized by airline engineering. This probably is attributable to imprecise feedback of in-service information due to the fact that seeping or leaking components are not always easy to locate when unpressurized. Also fluid traces are usually widely dispersed due to aerodynamic turbulence.

The effectivity of the improvement modifications listed below is for aircraft types A300B2 / B4, A300-600 and A310, unless otherwise indicated.

### **PARKING BRAKE SELECTOR**

The selector valve is operated by the parking brake handle and fitted in the nose gear wheel well. Hydraulic fluid traces in that area are most probably attributable to this component (figure 1). The selector contains two swing arm operated pushrods which operate two ball-type valves in order to open or close hydraulic connections of the parking brake system. The leaks were experienced on the body / cover joint line and are resulting from the packings of the two push rods. It was discovered that the packing groove minimum volume is smaller than the packing maximum volume. The consequence is that the packing extrudes from the groove and thus creates a leak, visible under the cover. As an improvement, the vendor, Messier issued SB 470-32-451, dated February 1984, which recommends the enlargement of

the grooves for the packings around the push rods at the next shop visit.

### **BRAKE RETURN LINE ACCUMULATORS**

Two cylindrical accumulators are mounted either on the rear side of each main gear shock absorber (A300B2 / B4) or near the main gear trunnions (A310, A300-600). One is connected to the alternate (yellow) brake return line and the other to the normal (green) brake return line. Each contains a spring loaded fluid /air separator piston (figure 2), the present packing of which is prone to leaks, in particular under freezing conditions on the ground. The fluid then is expelled through a vent hole, located in the plug at the top of the accumulator. As an improvement, Messier published SB 470-32-504, which is dated January 1985. It calls for replacement of the packing by another one having an increased interference fit. Retrofit should be accomplished during overhaul or repair.

### **MAIN LANDING GEAR ACTUATOR**

**Effectivity : A300B2 / B4, -600.**

The cylinder of the actuator is hinged to the MLG hinge arm while the sliding rod is attached to the wing structure. Hydraulic leaks have been observed on the sliding rod seals integrated in the outer end of the cylinder near the hinge pins (figure 3). The origin is grease coming from frequent lubrication of the cylinder articulating joint. The grease is accumulated in a cavity located

Achim Krapp  
Manager  
Reliability Analysis



*FAST no. 6 dealt with servo-control and indicating systems of the spoilers and airbrakes on the A300B2 and B4.*

**Figure 1**

## Parking brake selector

- Swing arm
- Push rod
- Ball valves
- Selector body
- Cover
- Packing

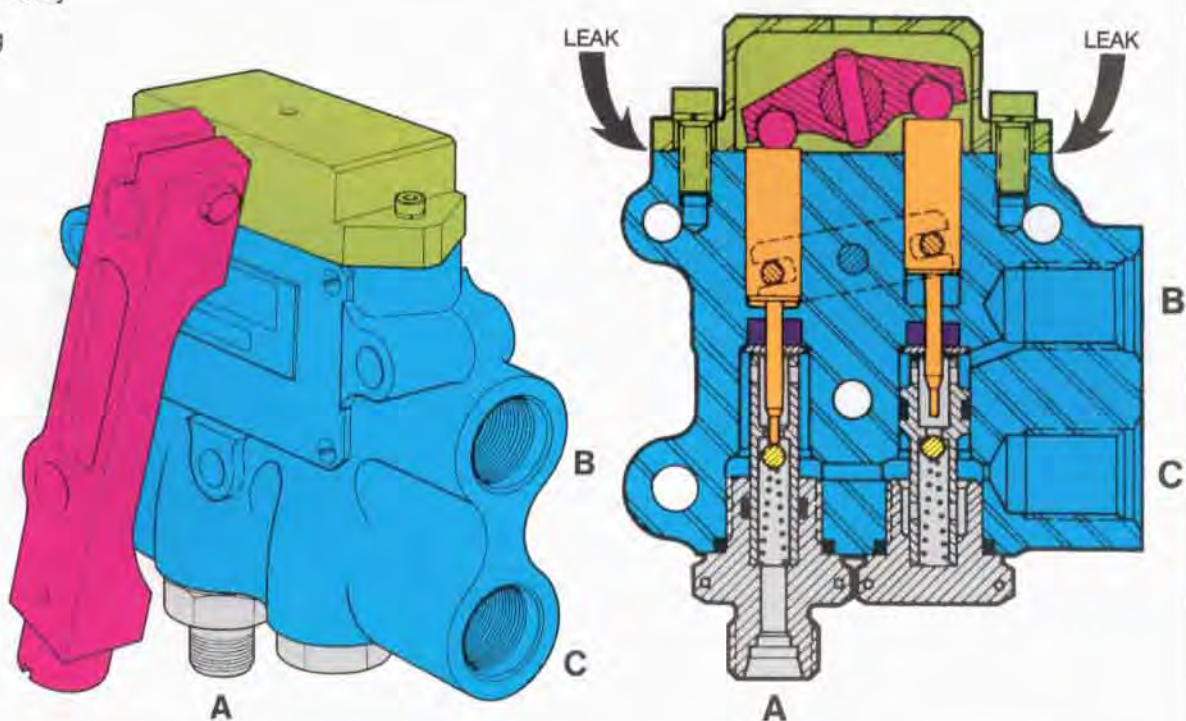

near the sliding rod seals. It cannot escape from there and its permanent contact with the seals is attacking and damaging them. As an improvement Messier issued SB 470-32-565, dated November 1985 describing a

modification designed to avoid accumulation of grease in the cavity. It contains recommendations to delete two covers (not visible on the drawing) on the A300B2, which can be accomplished in-situ, and to

remove the scraper ring of the sliding rod and drill a drain hole in the cylinder of the A300B4 and of the A300-600, which can be done during overhaul or repair.

**Figure 2**

## Brake return line accumulator

- Accumulator body
- Plug with venthole
- Fluid / air separator
- Packing
- Pressure inlet / outlet port

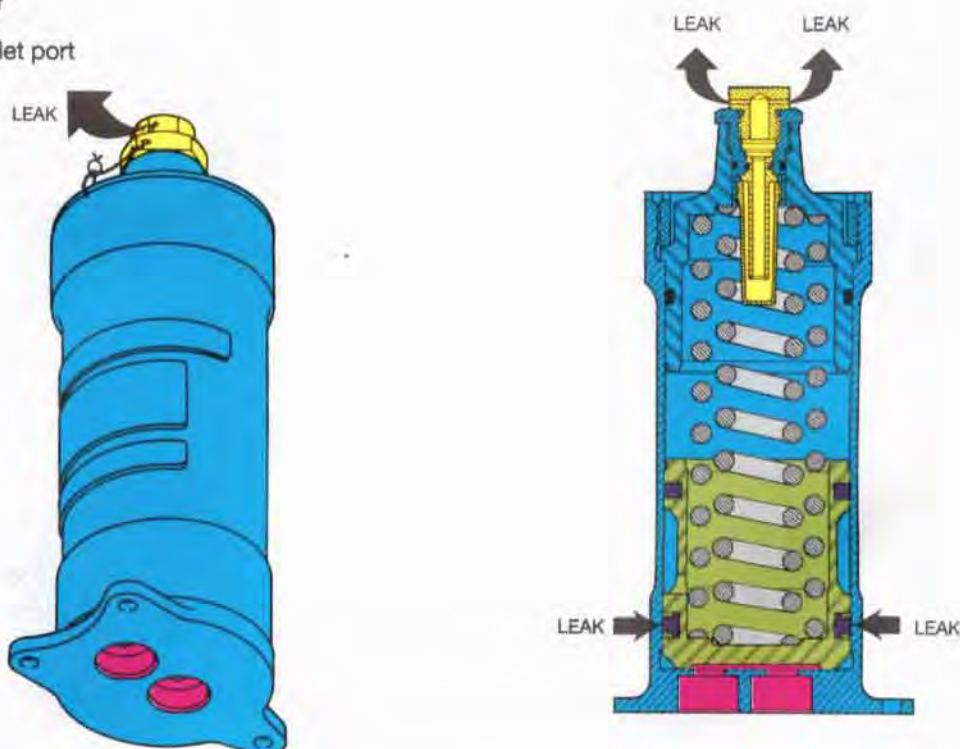

**Figure 3****Main landing gear actuator**

- Sliding rod
- Cylinder
- Hinge pin with grease nipples
- Grease cavity
- Scraper ring (removed)
- Seal of sliding rod
- Hydraulic fluid

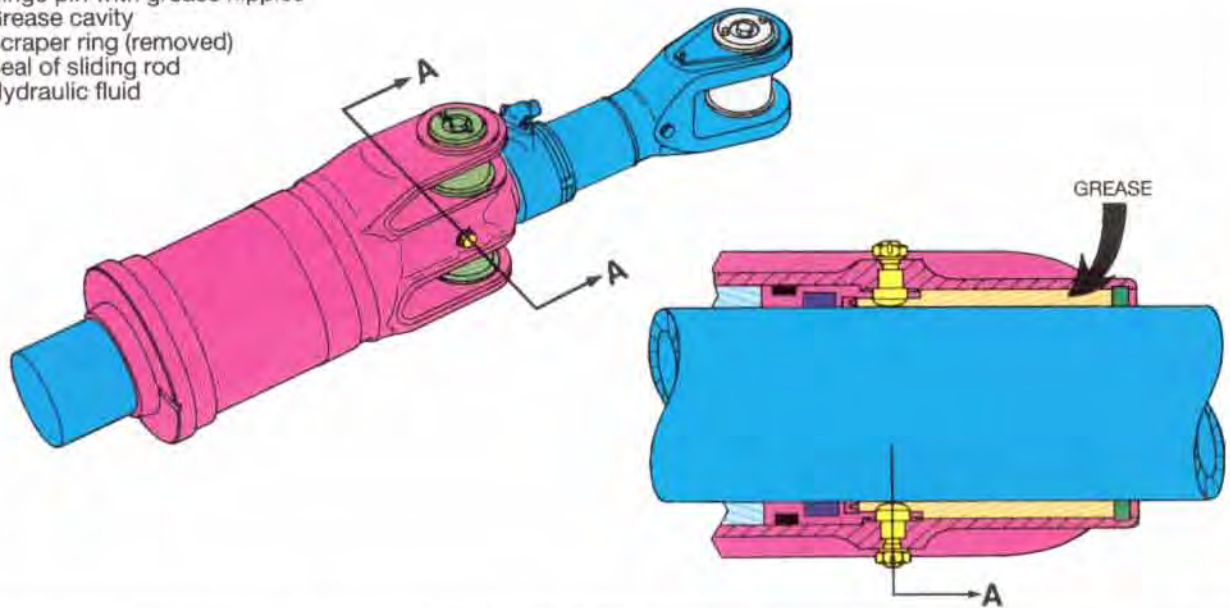
**STEERING COUPLER**

**Effectivity : A300B2 / B4 with deletion of yellow hydraulic system, and A300-600, A310.**

The coupler (figure 4) is attached to the underside of the flight deck floor in the pressurized electronic-avionic compartment. It connects the rudder pedals to the nose wheel steering system as soon as the landing gear shock absorbers are compressed. The connection is achieved by a hydraulically operated piston the cylinder of which is sealed by a plug fitted to the top of

the coupler unit. Leaks have been encountered at the cylinder / plug joint line. Messier SB 470-32-507, which is dated September 1984, recommends to replace the preformed packing located under the plug head by a packing fitted in a groove machined in the plug. The modification can be accomplished at overhaul / repair, but a modified plug can be fitted in-situ.

**CONCLUSION**

These modifications clearly identify potential causes of flight delays / cancellations. If ever a

wet area is localized in the surroundings of those components, they should be pressurized and inspected first. Even if operators have not yet experienced those leaks, the risk is present due to the fact that they contributed to thirty per cent of the total landing gear system leaks. Therefore, it is recommended to place your orders for kits and to plan their timely incorporation. □

**Figure 4****Steering coupler**

- Steering coupler
- Piston
- Modified plug
- Packing
- Rudder input
- Steering control linkage

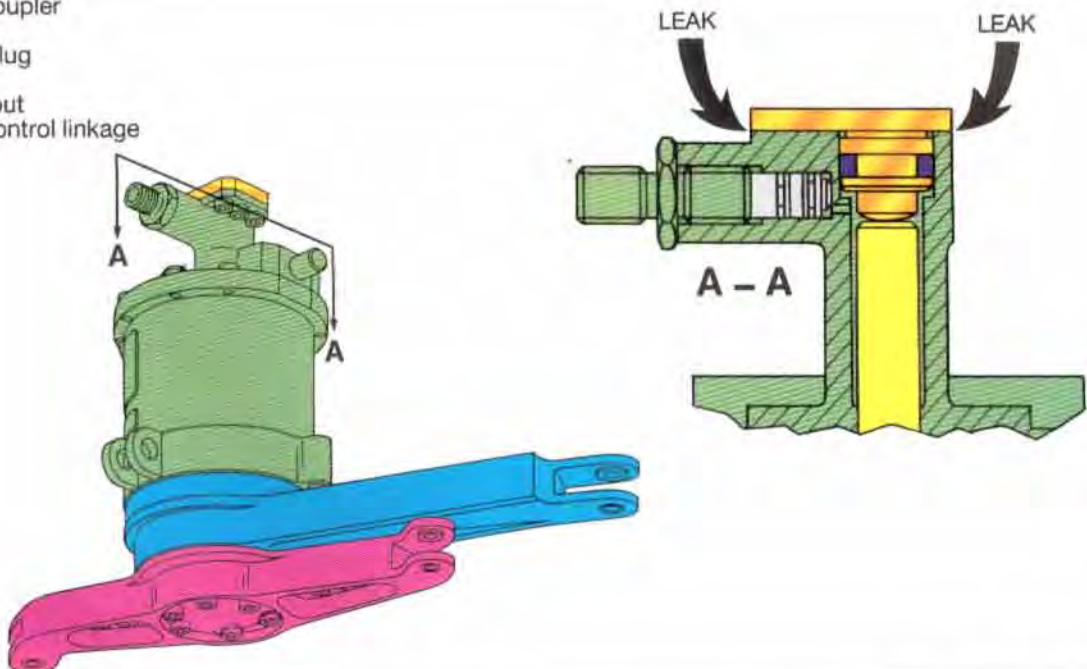

# FIELD SERVICE REPRESENTATIVES

Airbus Industrie - 1, Rond-Point Maurice-Bellonte - 31707 Blagnac Cedex, France - Telephone : 33 (61) 93 33 33  
Bob THOMAS, Manager Field Service - Telephone : 33 (61) 93 38 79

LOCATION	NAME	TELEPHONE	SITA/TELEX
ABU DHABI	J-P. GAYRAL	971 (2) 376859	23545
ALGIERS	J-Y. LE PAYEN	213/761525	ALGTZAH
AMSTERDAM	A. SANTKIN	31 (20) 418951	SPLTSKL
ATHENS	J-C. HUG	30 (1) 9818581	ATHEYOA
BANGKOK	M. EICHNER	66 (2) 5311940	BKKZUTG
BERLIN	M. NIESSNER	49 (30) 4104273	BERZXP
BOMBAY	A. VICENTE	91 (22) 6128203	BOMEAAI
BRUSSELS	R. CISTAC	32 (2) 7214315	BRUMOSN
CAIRO	U. KLANN	202 (2) 437781	CAIESMS
DAKAR	M. LEFEBVRE	221/200303Ext283	DKRIERK
DENVER	J-M. GAVARD	1 (303) 3983100	DENMXCO
FRANKFURT	B. JUERGENS	49 (69) 6963947	FRAIFLH
HAMBURG	M. THOMSEN	49 (40) 5092312	HAMXTLH
HANNOVER	D. KINDERMANN	49 (511) 7303293	HAJEAHF
HELSINKI	A. FRANCIS-JOSEPH	358 (0) 8252372	HELGUAY
HOUSTON	M. WEBB	1 (713) 2301815	HDQMCCO
ISTANBUL	M. BLASE	90 (1) 5740907	28887ZZTK
JAKARTA	C. MASSOL	62 (21) 5501993	JKTMZGA
JEDDAH	J. CORDIER	966 (2) 6842863	JEDETSV
JOHANNESBURG	G. STOLL	27 (11) 9702163	429059
KARACHI	V. GELLER	92 (21) 4845290	KHIVEPK
KINGSTON	J-L. PUYDENUS	1 (809) 9248460	KINZMJM
KUALA LUMPUR	R. LIPSCOMBE	60 (3) 7464555Ext2470	KULBAMH
KUWAIT	H. MUELLER	965/4742193	KWIBAKU
LAGOS	M. MARIASCHK	234 (1) 900470Ext117	LOSMCWT
LARNACA	A. JONES	357 (41) 23306Ext2529	2407CALENG
LONDON (LGW)	S. MARSDEN	44 (293) 582146	LGWEHBR
LOS ANGELES	A. GENSBICHLER	1 (213) 6465848	LAXQCCO
MADRID	J. PUGINIER	34 (1) 2054323	48154ABUSE
MANILA	M. RENKEN	63 (2) 8315444	MNLEUPR
MELBOURNE	J-M. VIVIES	61 (3) 3382771	31320
MIAMI	J. SPRINGER	1 (305) 8878717	6812007
NAIROBI	C. SENAT	254 (2) 822171Ext2022	NBOECKQ
NEW YORK (JFK)	M. TAVERNA	1 (718) 6322225	6716013
NEW YORK (LGA)	C. STEAD	1 (718) 8037290	6716013
PARIS (CDG)	C. MAILLARD	33 (1) 48642235	CDGASAF
PARIS (ORY)	G. GRENON	33 (1) 46869823	ORYASAF
PUSAN	M. NEUMANN	82 (51) 3254130	PUSXSKE
RIO DE JANEIRO	G. LASSERRE	55 (21) 3934333	GIGMFRG
RIYADH	J-P. SEGAS	966 (1) 2221137	RUHMYSV
ROME	Y. MARY	39 (6) 6011564	FCOYSAZ
SAO PAULO	M. BOYER	55 (11) 616663	SAOMZVP
SEOUL	E. KUNBERGER	82 (2) 6630111Ext3644	SELXSKE
SHANGHAI	A. LAMOUR	86 (21) 328767	33523
SINGAPORE	M. VAN STRIEN	65/5455027	35416
STOCKHOLM	P. RHEFELD	46 (8) 7803838	STOZTSK
TAIPEI	P. FERIAL	886 (33) 834410	32222
TOKYO (HND)	C. DORMANN	81 (3) 7476004	TYOAIJD
TORONTO	K. SPANOGHE	1 (416) 6711256	YYZMAWD
TUNIS	P. MAS	216 (1) 238000Ext2054	TUNTITU
ZURICH	R. THIEBAUT	41 (1) 8127727	ZRHZESR



# Battery maintenance



Should battery maintenance present a recurring problem in your organisation, a simple answer may be this piece of standard ground equipment mounted on a motor vehicle, known as a Huck's Starter. This equipment is readily adaptable to turn most aircraft engines !

*Bristol Fighter F2B (1918)*





# AIRBUS FLY BY WIRE

Airbus Industrie  
has made a significant  
advance in flight  
control technology.  
The system maintains  
a safe flight  
path automatically.  
It eliminates  
over-speed, over-stress  
and stall.

**AIRBUS INDUSTRIE TAKES FLIGHT SAFETY  
A MAJOR STEP FORWARD**

