



A300

**Airplane Characteristics
For Airport Planning
AC**

The content of this document is the property of Airbus S.A.S.
It is supplied in confidence and commercial security on its
contents must be maintained.
It must not be used for any purpose other than that for which it is
supplied, nor may information contained in it be disclosed to un-
authorized persons. It must not be reproduced in whole or in part
without permission in writing from the owners of the copyright.
Requests for reproduction of any data in this document and the
media authorized for it must be addressed to Airbus.

© Airbus S.A.S. 2002. All rights reserved.

AIRBUS S.A.S.
31707 BLAGNAC CEDEX, FRANCE
CUSTOMER SERVICES
TECHNICAL DATA SUPPORT AND SERVICES
PRINTED IN FRANCE
©AIRBUS S.A.S. 2002
ALL RIGHTS RESERVED

AN EADS COMPANY



AIRPLANE CHARACTERISTICS FOR AIRPORT PLANNING

HIGHLIGHTS

REVISION 22 - DEC 01/09

This revision concerns introduction of new pages and corrections of pages.

Description of change.

<u>SECTION</u>	<u>PAGE(s)</u>	<u>REASON FOR CHANGE</u>
1.1	p 1	Update Mail address.
1.2	p 1 and p 2	Update Presentation.
2.1	p 2	Update Presentation.
2.1.1	p 3 to p 4C	Update Presentation and added Weight Variants.
2.3	p 7	Added "Note".
	p 7A to p 9	Update Illustrations.
8.1	p 1	Change Text.
9.1.1	p 1 to p 4	Update Illustration.
9.2.1	p 1 to p 4	Update Illustration.
9.3.1		Deleted Section.
9.4.1		Deleted Section.
9.5.1		Deleted Section.
9.6.1		Deleted Section.

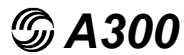

AIRPLANE CHARACTERISTICS FOR AIRPORT PLANNING

REVISION TRANSMITTAL SHEET

TO : ALL HOLDERS OF A300 AIRPLANE CHARACTERISTICS

R The revision, dated DEC 01/09 is attached and covers all the Airplane Characteristics, and the pavement data, which are identified in the highlights.

FILING INSTRUCTIONS

NOTE : Before introducing this revision make certain that previous revisions are incorporated.

- affected pages are listed on the "List of Effective Pages" and designated as follows :

R = revised (to be replaced)
D = deleted (to be removed)
N = new (to be introduced)

- make certain that the content of the manual is in compliance with the List of Effective Pages.

- update the Record of Temporary Revisions page as required.

- update the Record of Revisions page accordingly.

- file the Revision Transmittal Sheet separately.

- remove and destroy the pages which are affected by this revision.

REASON FOR ISSUE

The attached Highlights detail the reasons for issue.



AIRPLANE CHARACTERISTICS FOR AIRPORT PLANNING

RECORD OF REVISIONS

REV No.	ISSUE DATE	DATE INSERTED	BY	REV No.	ISSUE DATE	DATE INSERTED	BY
	JUN. 1986						
1	APR. 1970						
2	APR. 1972						
3	APR. 1973						
4	MAR. 1974						
5	JUN. 1974						
6	DEC. 1974						
7	SEP. 1975						
8	DEC. 1976						
9	MAR. 1977						
10	MAR. 1978						
11	MAR. 1979						
12	FEB. 1980						
13	OCT. 1980						
14	JUL. 1982						
15	MAR. 1986						
16	OCT. 1987						
17	FEB. 1988						
18	OCT. 1989						
19	JUN. 1992						
20	APR. 1995						
21	MAY. 1998						
22	DEC. 2009						

R

R



AIRPLANE CHARACTERISTICS FOR AIRPORT PLANNING

LIST OF EFFECTIVE PAGES

CHAPTER/ SECTION		PAGE	DATE	CHAPTER/ SECTION	PAGE	DATE
L.E.P.	R	1	DEC 09	2.6	18	FEB 80
L.E.P.	R	2	DEC 09	2.6	19	JUL 82
L.E.P.	R	3	DEC 09	2.7	20	FEB 80
L.E.P.	R	4	DEC 09	2.8	21	MAR 86
L.E.P.	R	5	DEC 09	2.8	22	FEB 80
				2.8	23	FEB 80
R.O.R.	R	1	DEC 09	2.8	24	MAR 86
				2.8	25	JUL 82
T.O.C.	R	1	DEC 09	2.8	26	FEB 80
T.O.C.	R	2	DEC 09	2.8	27	FEB 80
T.O.C.	R	3	DEC 09	2.8	28	OCT 80
T.O.C.	R	4	DEC 09	2.8	29	FEB 80
T.O.C.	R	5	DEC 09	2.8	30	APR 95
T.O.C.	R	6	DEC 09	2.8	31	APR 95
T.O.C.	R	7	DEC 09	2.8	32	BLANK
T.O.C.	R	8	DEC 09			
				3.0	1	FEB 80
1.0	R	1	DEC 09	3.1	2	FEB 80
1.1	R	1	DEC 09	3.2	3	FEB 80
1.2	R	1	DEC 09	3.2	4	FEB 80
1.2	R	2	DEC 09	3.2	5	FEB 80
				3.2	6	FEB 80
2.0	R	1	DEC 09	3.2	7	FEB 80
2.1	R	2	DEC 09	3.2	8	FEB 80
2.1.1	R	3	DEC 09	3.2	9	FEB 80
2.1.1	R	4	DEC 09	3.2	10	FEB 80
2.1.1	N	4A	DEC 09	3.2	11	FEB 80
2.1.1	N	4B	DEC 09	3.2	12	FEB 80
2.1.1	N	4C	DEC 09	3.2	13	FEB 80
2.2		5	FEB 80	3.2	14	FEB 80
2.2		6	FEB 80	3.2	15	FEB 80
2.3	R	7	DEC 09	3.2	16	FEB 80
2.3	N	7A	DEC 09	3.2	17	FEB 80
2.3	R	8	DEC 09	3.2	18	FEB 80
2.3	R	9	DEC 09	3.3	19	FEB 80
2.4		10	FEB 80	3.3	20	FEB 80
2.4		11	FEB 80	3.3	21	FEB 80
2.4		12	FEB 80	3.3	22	FEB 80
2.4		13	FEB 80	3.3	23	FEB 80
2.5		14	FEB 80	3.3	24	FEB 80
2.5		15	FEB 80	3.3	25	FEB 80
2.5		16	FEB 80	3.3	26	FEB 80
2.6		17	FEB 80	3.3	27	FEB 80

R

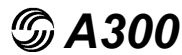

AIRPLANE CHARACTERISTICS FOR AIRPORT PLANNING

LIST OF EFFECTIVE PAGES

CHAPTER/ SECTION	PAGE	DATE	CHAPTER/ SECTION	PAGE	DATE
3.3	28	FEB 80	5.2	17	FEB 80
3.3	29	FEB 80	5.2	18	FEB 80
3.3	30	FEB 80	5.2	19	FEB 80
3.3	31	FEB 80	5.2	20	FEB 80
3.3	32	FEB 80	5.2	21	FEB 80
3.3	33	FEB 80	5.3	22	FEB 80
3.3	34	FEB 80	5.3	23	FEB 80
3.4	35	FEB 80	5.4	24	FEB 80
3.4	36	FEB 80	5.4	25	FEB 80
3.4	37	FEB 80	5.4	26	FEB 80
3.5	38	FEB 80	5.4	27	FEB 80
3.5	39	FEB 80	5.4	28	FEB 80
3.5	40	FEB 80	5.4	29	FEB 80
3.5	41	FEB 80	5.4	30	FEB 80
			5.4	31	MAY 98
4.0	1	FEB 80	5.4	32	FEB 80
4.1	2	FEB 80	5.4	33	JUL 82
4.2	3	FEB 80	5.4	34	FEB 80
4.3	4	FEB 80	5.4	35	FEB 80
4.4	5	FEB 80	5.4	36	OCT 89
4.4	6	FEB 80	5.4	37	OCT 89
4.4	7	FEB 80	5.4	38	FEB 80
4.5	8	FEB 80	5.4	39	FEB 80
4.5	9	FEB 80	5.4	40	OCT 80
4.6	10	FEB 80	5.4	41	OCT 80
4.6	11	FEB 80	5.4	42	OCT 80
			5.4	43	OCT 80
5.0	1	JUN 92	5.4	44	OCT 89
5.1	2	JUN 92	5.4	45	OCT 89
5.1	3	JUN 92	5.4	46	FEB 80
5.1	4	JUN 92	5.4	47	FEB 80
5.1	5	JUN 92	5.5	48	OCT 80
5.1	6	JUN 92	5.5	49	OCT 80
5.1	7	JUN 92	5.5	50	OCT 80
5.1	8	JUN 92	5.5	51	OCT 80
5.1	9	JUN 92	5.5	52	OCT 80
5.1	10	JUN 92	5.5	53	OCT 80
5.1	11	JUN 92	5.6	54	FEB 80
5.1	12	JUN 92	5.6	55	FEB 80
5.1	13	JUN 92	5.6	56	FEB 80
5.1	14	BLANK	5.6	57	FEB 80
5.2	15	FEB 80	5.7	58	JUL 82
5.2	16	FEB 80	5.7	59	JUL 82

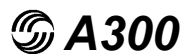

AIRPLANE CHARACTERISTICS FOR AIRPORT PLANNING

LIST OF EFFECTIVE PAGES

CHAPTER/ SECTION	PAGE	DATE	CHAPTER/ SECTION	PAGE	DATE
5.8	60	FEB 80	6.3	40	BLANK
5.8	61	FEB 80			
5.8	62	FEB 80	7.0	1	MAR 86
			7.1	2	BLANK
6.0	1	MAY 98	7.1	3	FEB 80
6.1	2	OCT 80	7.1	4	OCT 80
6.1	3	OCT 80	7.1	4A	MAR 86
6.1	4	OCT 80	7.1	4B	BLANK
6.1	5	OCT 80	7.2	5	MAR 86
6.1	6	OCT 80	7.2	6	BLANK
6.1	7	OCT 80	7.3	7	FEB 80
6.1	8	OCT 80	7.3	8	FEB 80
6.1	9	OCT 80	7.4	9	FEB 80
6.1	10	OCT 80	7.4	10	FEB 80
6.1	11	OCT 80	7.5	11	FEB 80
6.1	12	OCT 80	7.5	12	FEB 80
6.1	13	OCT 80	7.5	13	FEB 80
6.1	14	OCT 80	7.5	14	FEB 80
6.1	15	OCT 80	7.5	15	BLANK
6.1	16	OCT 80	7.5	16	FEB 80
6.1	17	OCT 80	7.5	17	FEB 80
6.1	18	OCT 80	7.5	18	BLANK
6.1	19	OCT 80	7.5	19	FEB 80
6.1	20	OCT 80	7.5	20	FEB 80
6.1	21	OCT 80	7.5	21	FEB 80
6.1	22	OCT 80	7.5	22	FEB 80
6.1	23	OCT 80	7.5	23	FEB 80
6.1	24	OCT 80	7.5	24	FEB 80
6.1	25	OCT 80	7.5	25	OCT 80
6.2	26	FEB 80	7.5	26	OCT 80
6.2	27	FEB 80	7.5	27	OCT 80
6.2	28	FEB 80	7.5	28	OCT 80
6.2	29	FEB 80	7.6	29	FEB 80
6.2	30	FEB 80	7.6	30	FEB 80
6.2	31	FEB 80	7.6	31	MAR 86
6.3	32	MAR 86	7.6	32	MAR 86
6.3	33	MAR 86	7.6	33	MAR 86
6.3	34	MAR 86	7.6	34	MAR 86
6.3	35	MAR 86	7.6	35	BLANK
6.3	36	FEB 80	7.6	36	MAR 86
6.3	37	FEB 80	7.6	37	MAR 86
6.3	38	APR 95	7.6	38	BLANK
6.3	39	APR 95	7.6	39	MAR 86

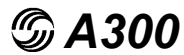

AIRPLANE CHARACTERISTICS FOR AIRPORT PLANNING

LIST OF EFFECTIVE PAGES

CHAPTER/ SECTION	PAGE	DATE	CHAPTER/ SECTION	PAGE	DATE
7.6	40	MAR 86	7.8	83	MAR 86
7.6	41	MAR 86	7.8	84	MAR 86
7.6	42	MAR 86	7.8	85	MAR 86
7.6	43	MAR 86	7.8	86	MAR 86
7.6	44	MAR 86	7.8	87	MAR 86
7.6	45	MAR 86	7.8	88	MAR 86
7.6	46	MAR 86	7.8	89	MAR 86
7.6	47	MAR 86	7.8	90	MAR 86
7.6	48	BLANK	7.8	91	MAR 86
7.7	49	FEB 80	7.8	92	BLANK
7.7	50	BLANK	7.9	93	OCT 87
7.7	51	FEB 80	7.9	94	OCT 87
7.7	52	FEB 80	7.9	95	MAR 86
7.7	53	FEB 80	7.9	96	BLANK
7.7	54	FEB 80	7.9	97	MAR 86
7.7	55	BLANK	7.9	98	MAR 86
7.7	56	FEB 80	7.9	99	MAR 86
7.7	57	FEB 80	7.9	100	MAR 86
7.7	58	BLANK	7.9	101	MAR 86
7.7	59	FEB 80	7.9	102	MAR 86
7.7	60	FEB 80	7.9	103	MAR 86
7.7	61	FEB 80	7.9	104	MAR 86
7.7	62	FEB 80	7.9	105	MAR 86
7.7	63	FEB 80	7.9	106	MAR 86
7.7	64	FEB 80	7.9	107	MAR 86
7.7	65	OCT 80	7.9	108	BLANK
7.7	66	OCT 80	7.9	109	MAR 86
7.7	67	OCT 80	7.9	110	MAR 86
7.7	68	OCT 80	7.9	111	MAR 86
7.7	69	FEB 80	7.9	112	BLANK
7.7	70	FEB 80	7.9	113	MAR 86
7.7	71	FEB 80	7.9	114	MAR 86
7.7	72	BLANK	7.9	115	MAR 86
7.8	73	FEB 80	7.9	116	MAR 86
7.8	74	BLANK	7.9	117	MAR 86
7.8	75	MAR 86	7.9	118	MAR 86
7.8	76	MAR 86	7.9	119	MAR 86
7.8	77	MAR 86	7.9	120	MAR 86
7.8	78	MAR 86	7.9	121	MAR 86
7.8	79	BLANK	7.9	122	MAR 86
7.8	80	MAR 86	7.9	123	MAR 86
7.8	81	MAR 86	7.9	124	MAR 86
7.8	82	BLANK	7.9	125	MAR 86

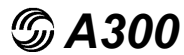

AIRPLANE CHARACTERISTICS FOR AIRPORT PLANNING

LIST OF EFFECTIVE PAGES

CHAPTER/ SECTION		PAGE	DATE	CHAPTER/ SECTION	PAGE	DATE
7.9		126	MAR 86			
7.9		127	MAR 86			
7.9		128	MAR 86			
8.0	R	1	DEC 09			
8.1	R	1	DEC 09			
9.0	R	1	DEC 09			
9.1.1	R	1	DEC 09			
9.1.1	R	2	DEC 09			
9.1.1	R	3	DEC 09			
9.1.1	R	4	DEC 09			
9.2.1	R	1	DEC 09			
9.2.1	R	2	DEC 09			
9.2.1	R	3	DEC 09			
9.2.1	R	4	DEC 09			
9.3.1	D	1	DEC 09			
9.3.1	D	2	DEC 09			
9.3.1	D	3	DEC 09			
9.3.1	D	4	DEC 09			
9.4.1	D	1	DEC 09			
9.4.1	D	2	DEC 09			
9.4.1	D	3	DEC 09			
9.4.1	D	4	DEC 09			
9.5.1	D	1	DEC 09			
9.5.1	D	2	DEC 09			
9.5.1	D	3	DEC 09			
9.5.1	D	4	DEC 09			
9.6.1	D	1	DEC 09			
9.6.1	D	2	DEC 09			
9.6.1	D	3	DEC 09			
9.6.1	D	4	DEC 09			
10.0	D	1	DEC 09			
10.1.0	D	1	DEC 09			
10.2.0	D	1	DEC 09			
10.2.0	D	2	DEC 09			
10.2.0	D	3	DEC 09			
10.3.0	D	1	DEC 09			
10.4.0	D	1	DEC 09			

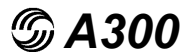

AIRPLANE CHARACTERISTICS FOR AIRPORT PLANNING

TABLE OF CONTENTS

R	1.0	SCOPE
R	1.1	Purpose
R	1.2	Introduction
R	2.0	AIRPLANE DESCRIPTION
R	2.1	General Airplane Characteristics
R	2.1.1	General Airplane Characteristics Data
	2.2	General Dimensions
R	2.3	Ground Clearances
	2.4	Interior Arrangement
	2.4.1	Basic Version
	2.4.2	Basic High Density Version
	2.4.3	Basic Upper Deck Configuration
	2.4.4	Optional Upper Deck Configuration
	2.5	Passenger Cabin Cross Section
	2.5.1	Seating Configuration - 6 Abreast - First Class
	2.5.2	Seating Configuration - 8 Abreast - Tourist Class
	2.5.3	Seating Configuration - 9 Abreast - Charter Operation
	2.6	Lower Compartment
	2.6.1	Weight and Volume Data
	2.6.2	Containers
	2.6.3	Pallets
	2.7	Upper Deck Cargo
	2.8	Door Clearances
	2.8.1	Forward Passenger Door
	2.8.2	Middle Passenger Door
	2.8.3	AFT Passenger Door
	2.8.4	Forward Cargo Compartment Door
	2.8.5	Upper Deck Cargo Door
	2.8.6	AFT Cargo Compartment Door
	2.8.7	Bulk Cargo Compartment Door
	2.8.8	Radome Travel
	2.8.9	Main Landing Gear Door

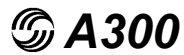

AIRPLANE CHARACTERISTICS FOR AIRPORT PLANNING

TABLE OF CONTENTS

3.0	AIRPLANE PERFORMANCE
3.1	General Information
3.2	Payload Range
3.2.1	Long Range and Recommended Cruise (U.S Units)
3.2.2	Long Range and Recommended Cruise (Metric Units)
3.3	FAR Takeoff Runway Length Requirements
3.3.1	ISA Conditions - Alternate (U.S Units)
3.3.2	ISA Conditions - Alternate (Metric Units)
3.3.3	ISA Conditions + 59°F (+ 15°C) - Alternate (U.S Units)
3.3.4	ISA Conditions + 59°F (+ 15°C) - Alternate (Metric Units)
3.4	FAR Landing Runway Requirements
3.4.1	Full Flaps (U.S Units)
3.4.2	Full Flaps (Metric Units)
3.4.3	Full Flaps
3.5	Landing Approach Speed
3.5.1	Landing Approach Speed (Metric Units)
3.5.2	Landing Approach Speed (U.S Units)
4.0	GROUND MANEUVERING
4.1	Turning Radii - No Slip Angle
4.2	Minimum Turning Radii
4.3	Visibility From Cockpit in Static Position
4.4	Runway and Taxiway Turnpaths
4.4.1	More than 90° Turn Runway to Taxiway
4.4.2	90° Turn Runway to Taxiway
4.4.3	90° Turn Taxiway to Taxiway
4.5	Runway Holding Apron
4.6	Minimum Parking Space Requirements
4.6.1	Minimum Parking Space Requirements (U.S Units)
4.6.2	Minimum Parking Space Requirements (Metric Units)

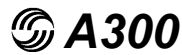

AIRPLANE CHARACTERISTICS FOR AIRPORT PLANNING

TABLE OF CONTENTS

5.0	TERMINAL SERVICING
5.1	Airplane Servicing Arrangement
5.1.1	Symbols Used On Servicing Diagrams
5.1.2	Open Apron Free Standing - APU Running
5.1.3	Open Apron Free Standing - APU Not Running
5.1.4	Two Passenger Gangways - Parallel - APU Running
5.1.5	Three passenger Gangways - Nose In - APU Not Running
5.1.6	Three passenger Gangways - Double Parallel - APU Running
5.1.7	Open Apron Free Standing - APU Running
5.1.8	Three Passenger Gangways - Nose In - APU Running
5.2	Terminal Operation
5.2.1	Turnround Station (30 Minutes - 1 Door Open)
5.2.2	Turnround Station (30 Minutes - 2 Doors Open)
5.2.3	Turnround Station (30 Minutes - 3 Doors Open)
5.2.4	Turnround Station (30 Minutes - Freight Mode)
5.3	Terminal Operation
5.3.1	Enroute Station (20 Minutes - 3 Doors Open)
5.4	Ground Service Connections
5.4.1	Ground Service Connections Data
5.4.2	Ground Service Connections Layout
5.4.3	Hydraulic System
5.4.4	Electrical System
5.4.5	Oxygen System
5.4.6	Fuel System
5.4.7	Pneumatic System
5.4.8	Oil System
5.4.9	Potable Water System
5.4.10	Toilet System
5.5	Engine Starting Pneumatic Requirements
5.5.1	Ambient Temperature -40°F (-40°C)
5.5.2	Ambient Temperature +60°F (+15°C)
5.5.3	Ambient Temperature +100°F (+38°C)
5.6	Ground Pneumatic Power Requirements
5.6.1	Heating (U.S Units)
5.6.2	Heating (Metric Units)
5.6.3	Cooling (U.S Units)
5.6.4	Cooling (Metric Units)
5.7	Preconditioned Airflow Requirements
5.7.1	(U.S Units)
5.7.2	(Metric Units)
5.8	Ground Towing Requirements
5.8.1	(U.S Units)
5.8.2	(Metric Units)

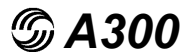

AIRPLANE CHARACTERISTICS FOR AIRPORT PLANNING

TABLE OF CONTENTS

6.0	OPERATING CONDITIONS
6.1	Jet Engine Exhaust Velocities and Temperatures
6.1.1	Exhaust Velocity Contours - Breakaway Power (U.S Units)
6.1.2	Exhaust Velocity Contours - Breakaway Power (Metric Units)
6.1.3	Exhaust Temperature Contours - Breakaway Power (U.S Units)
6.1.4	Exhaust Temperature Contours - Breakaway Power (Metric Units)
6.1.5	Exhaust Velocity Contours - Takeoff Power (U.S Units)
6.1.6	Exhaust Velocity Contours - Takeoff Power (Metric Units)
6.1.7	Exhaust Temperature Contours - Takeoff Power (U.S Units)
6.1.8	Exhaust Temperature Contours - Takeoff Power (Metric Units)
6.1.9	Exhaust Velocity Contours - Idle Power (U.S Units)
6.1.10	Exhaust Velocity Contours - Idle Power (Metric Units)
6.1.11	Exhaust Temperature Contours - Idle Power (U.S Units)
6.1.12	Exhaust Temperature Contours - Idle Power (Metric Units)
6.2	Airport and Community Noise
6.2.1	External Noise
6.2.2	Noise Data
6.2.3	APU Noise Levels
6.3	Danger Areas of the Engines
6.3.1	Danger Areas Forward of the Engines (Ground Idle)
6.3.2	Danger Areas Forward of the Engine (Takeoff)
6.3.3	Acoustic Protection Areas
6.3.4	APU - Exhaust GAS Temperature and Velocity

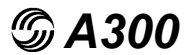

AIRPLANE CHARACTERISTICS FOR AIRPORT PLANNING

TABLE OF CONTENTS

7.0	PAVEMENT DATA (CONTENTS)
7.1	General Information
7.2	Landing Gear Footprint
7.3	Maximum Pavement Loads
7.4	Landing Gear Loading on Pavement
7.4.1	Model B2/B2K
7.4.2	Model B4/C4
7.5	Flexible Pavement Requirements U.S Corps of Engineers Design Method
7.5.1	Model B2
7.5.1.1	137T Standard Tires (46x46-20")
7.5.1.2	137T Optional Tires (49x17-20")
7.5.1.3	142T Standard Tires (46x16-20")
7.5.1.4	142T Optional Tires (49x17-20")
7.5.2	Model B2K
7.5.2.1	142T Standard Tires (46x16-20")
7.5.2.2	142T Optional Tires (49x17-20")
7.5.3	Model B4
7.5.3.1	150T Standard Tires (46x16-20")
7.5.3.2	150T Optional Tires (49x17-20")
7.5.3.3	153T Standard Tires (46x16-20")
7.5.3.4	153T Optional Tires (49x17-20")
7.5.3.5	157.5T Standard Tires (46x16-20")
7.5.3.6	157.5T Optional Tires (49x17-20")
7.5.3.7	157.5T Optional Tires (49x19-20")
7.5.3	Model B4/C4
7.5.3.8	165T Standard Tires (49x17-20")
7.5.3.9	165T Optional Tires (49x17-20") Landing Gear Geometry
7.5.3.10	165T Optional Tires (49x19-20")

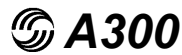

AIRPLANE CHARACTERISTICS FOR AIRPORT PLANNING

TABLE OF CONTENTS

7.6	Flexible Pavement Requirements L.C.N Conversion
7.6.1	Model B2
7.6.1.1	137T Standard Tires (46x16-20")
7.6.1.2	137T Optional Tires (49x17-20")
7.6.1.3	142T Standard Tires (46x16-20")
7.6.1.4	142T Optional Tires (49x17-20")
7.6.2	Model B2K
7.6.2.1	142T Standard Tires (46x16-20")
7.6.2.2	142T Optional Tires (49x17-20")
7.6.3	Model B4
7.6.3.1	150T Standard Tires (46x16-20")
7.6.3.2	150T Optional Tires (49x17-20")
7.6.3.3	153T Standard Tires (46x16-20")
7.6.3.4	153T Optional Tires (49x17-20")
7.6.3.5	157.5T Standard Tires (46x16-20")
7.6.3.6	157.5T Optional Tires (49x17-20")
7.6.3.7	157.5T Optional Tires (49x19-20")
7.6.3	Model B4/C4
7.6.3.8	165T Standard Tires (49x17-20")
7.6.3.9	165T Optional Tires (49x19-20")
7.7	Rigid Pavement Requirements - Portland Cement Association
7.7.1	Model B2
7.7.1.1	137T Standard Tires (46x16-20")
7.7.1.2	137T Optional Tires (49x17-20")
7.7.1.3	142T Standard Tires (46x16-20")
7.7.1.4	142T Optional Tires (49x17-20")
7.7.2	Model B2K
7.7.2.1	142T Standard Tires (46x16-20")
7.7.2.2	142T Optional Tires (49x17-20")
7.7.3	Model B4
7.7.3.1	150T Standard Tires (46x16-20")
7.7.3.2	150T Optional Tires (49x17-20")
7.7.3.3	153T Standard Tires (46x16-20")
7.7.3.4	153T Optional Tires (49x17-20")
7.7.3.5	157.5T Standard Tires (46x16-20")
7.7.3.6	157.5T Optional Tires (49x17-20")
7.7.3.7	157.5T Optional Tires (49x19-20")
7.7.3	Model B4/C4
7.7.3.8	165T Standard Tires (49x17-20")
7.7.3.9	165T Optional Tires (49x17-20") Landing Gear Geometry
7.7.3.10	165T Optional Tires (49x19-20")

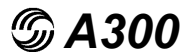

AIRPLANE CHARACTERISTICS FOR AIRPORT PLANNING

TABLE OF CONTENTS

7.7.4.1	Radius of Relative Stiffness
7.7.4.2	Values of E and μ
7.7.4.3	Effect of E and μ on 1 Values
7.8	Rigid Pavement Requirements L.C.N Conversion
7.8.1	Model B2
7.8.1.1	137T Standard Tires (46x16-20")
7.8.1.2	137T Optional Tires (49x17-20")
7.8.1.3	142T Standard Tires (46x16-20")
7.8.1.4	142T Optional Tires (49x17-20")
7.8.2	Model B2K
7.8.2.1	142T Standard Tires (46x16-20")
7.8.2.2	142T Optional Tires (49x17-20")
7.8.3	Model B4
7.8.3.1	150T Standard Tires (46x16-20")
7.8.3.2	150T Optional Tires (49x17-20")
7.8.3.3	153T Standard Tires (46x16-20")
7.8.3.4	153T Optional Tires (49x17-20")
7.8.3.5	157.5T Standard Tires (46x16-20")
7.8.3.6	157.5T Optional Tires (49x17-20")
7.8.3.7	157.5T Optional Tires (49x19-20")
7.8.3	Model B4/C4
7.8.3.8	165T Standard Tires (49x17-20")
7.8.3.9	165T Optional Tires (49x19-20")
7.9	Aircraft Classification Number - ACN Flexible and Rigid Pavement
7.9.1	Flexible Pavement Model B2
7.9.1.1	137T Standard Tires (46x16-20")
7.9.1.3	142T Standard Tires (46x16-20")
7.9.1.4	142T Optional Tires (49x17-20")
7.9.2	Flexible Pavement Model B2K
7.9.2.1	142T Standard Tires (46x16-20")
7.9.2.2	142T Optional Tires (49x17-20")
7.9.3	Flexible Pavement Model B4
7.9.3.1	150T Standard Tires (46x16-20")
7.9.3.2	150T Optional Tires (49x17-20")
7.9.3.3	153T Standard Tires (46x16-20")
7.9.3.4	153T Optional Tires (49x17-20")
7.9.3.5	157.5T Standard Tires (46x16-20")
7.9.3.6	157.5T Optional Tires (49x17-20")
7.9.3.7	157.5T Optional Tires (49x19-20")
7.9.3	Flexible Pavement Model B4/C4
7.9.3.9	165T Standard Tires (49x17-20")
7.9.3.10	165T Optional Tires (49x19-20")

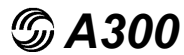

AIRPLANE CHARACTERISTICS FOR AIRPORT PLANNING

TABLE OF CONTENTS

7.9.4	Rigid Pavement - Model B2
7.9.4.1	137T Standard Tires (46x16-20")
7.9.4.3	142T Standard Tires (46x16-20")
7.9.4.4	142T Optional Tires (49x17-20")
7.9.5	Rigid Pavement - Model B2K
7.9.5.1	142T Standard Tires (46x16-20")
7.9.5.2	142T Optional Tires (49x17-20")
7.9.6	Rigid Pavement - Model B4
7.9.6.1	150T Standard Tires (46x16-20")
7.9.6.2	150T Optional Tires (49x17-20")
7.9.6.3	153T Standard Tires (46x16-20")
7.9.6.4	153T Optional Tires (49x17-20")
7.9.6.5	157.5T Standard Tires (46x16-20")
7.9.6.6	157.5T Optional Tires (49x17-20")
7.9.6.7	157.5T Optional Tires (49x19-20")
7.9.6	Flexible Pavement - Model B4/C4
7.9.6.9	165T Standard Tires (49x17-20")
7.9.6.10	165T Optional Tires (49x19-20")
7.9.7	Development of ACN Charts (for example)
R 8.0	DERIVATIVE AIRPLANE
R 8.1	Possible Future A300 Derivative Airplanes
R 9.0	SCALED DRAWINGS
R 9.1.1	A300 Scaled Drawing 1 in. = 500 ft.
R 9.2.1	A300 Scaled Drawing 1 cm. = 500 cm.



AIRPLANE CHARACTERISTICS FOR AIRPORT PLANNING

R 1.0 SCOPE

R 1.1 Purpose

R 1.2 Introduction

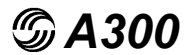

AIRPLANE CHARACTERISTICS FOR AIRPORT PLANNING

1.1 Purpose

The A300 AIRPLANE CHARACTERISTICS (AC) manual is issued for the A300 basic versions to provide the necessary data needed by airport operators and airlines for the planning of airport facilities.

This document conforms to NAS 3601.

CORRESPONDENCE

Correspondence concerning this publication should be directed to :

AIRBUS S.A.S.
Customer Services
Technical Data Support and Services
1, Rond Point Maurice BELLONTE
31707 BLAGNAC CEDEX
FRANCE

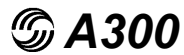

AIRPLANE CHARACTERISTICS FOR AIRPORT PLANNING

1.2 Introduction

This manual comprises 9 chapters with a List of Effective Pages (LEP) and a Table Of Content (TOC) at the beginning of the manual.

Chapter 1 : SCOPE

Chapter 2 : AIRPLANE DESCRIPTION

This chapter contains general dimensional and other basic aircraft data.

It covers :

- aircraft dimensions and ground clearances,
- passengers and cargo compartments arrangement.

Chapter 3 : AIRPLANE PERFORMANCE

This chapter indicates the aircraft performance.

It covers :

- payload range,
- takeoff and landing runway requirements,
- landing approach speed.

Chapter 4 : GROUND MANEUVERING

This chapter provides the aircraft turning capability and maneuvering characteristics on the ground.

It includes :

- turning radii and visibility from the cockpit,
- runway and taxiway turn path.

Chapter 5 : TERMINAL SERVICING

This chapter provides information for the arrangement of ground handling and servicing equipments.

It covers :

- location and connections of ground servicing equipment,
- engines starting pneumatic and preconditioned airflow requirements.

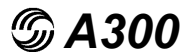

AIRPLANE CHARACTERISTICS FOR AIRPORT PLANNING

Chapter 6 : OPERATING CONDITIONS

This chapter contains data and safety/environmental precautions related to engine and APU operation on the ground.

It covers :

- contour size and shape of the jet engine exhaust velocities and temperature,
- noise data.

Chapter 7 : PAVEMENT DATA

This chapter contains the pavement data helpful for airport planning.

It gives :

- landing gear foot print and static load,
- charts for flexible pavements with Load Classification Number (LCN),
- charts for rigid pavements with LCN,
- Aircraft Classification Number (ACN), Pavement Classification Number (PCN), reporting system for flexible and rigid pavements.

Chapter 8 : DERIVATIVE AIRPLANES

This chapter gives relevant data of possible new version with the associated size change.

Chapter 9 : SCALED DRAWING

This chapter contains different A300 scaled drawings.



AIRPLANE CHARACTERISTICS FOR AIRPORT PLANNING

R 2.0 AIRPLANE DESCRIPTION

R 2.1 General Airplane Characteristics

R 2.1.1 General Airplane Characteristics Data

2.2 General Dimensions

R 2.3 Ground Clearances

2.4 Interior Arrangement

2.4.1 Basic Version

2.4.2 Basic High Density Version

2.4.3 Basic Upper Deck Configuration

2.4.4 Optional Upper Deck Configuration

2.5 Passenger Cabin Cross Section

2.5.1 Seating Configuration - 6 Abreast - First Class

2.5.2 Seating Configuration - 8 Abreast - Tourist Class

2.5.3 Seating Configuration - 9 Abreast - Charter Operation

2.6 Lower Compartment

2.6.1 Weight and Volume Data

2.6.2 Containers

2.6.3 Pallets

2.7 Upper Deck Cargo

2.8 Door Clearances

2.8.1 Forward Passenger Door

2.8.2 Middle Passenger Door

2.8.3 AFT Passenger Door

2.8.4 Forward Cargo Compartment Door

2.8.5 Upper Deck Cargo Door

2.8.6 AFT Cargo Compartment Door

2.8.7 Bulk Cargo Compartment Door

2.8.8 Radome Travel

2.8.9 Main Landing Gear Door

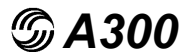

AIRPLANE CHARACTERISTICS FOR AIRPORT PLANNING

2.1 General Airplane Characteristics

The weight terms used throughout this manual are given below together with their respective definitions.

Maximum Taxi Weight (MTW) :

Maximum weight for ground maneuver as limited by aircraft strength and airworthiness requirements. (It includes weight of run-up and taxi fuel). It is also called Maximum Ramp Weight (MRW).

Maximum Landing Weight (MLW) :

Maximum weight for landing as limited by aircraft strength and airworthiness requirements.

Maximum Takeoff Weight (MTOW) :

Maximum weight for takeoff as limited by aircraft strength and airworthiness requirements. (This is the maximum weight at start of the takeoff run).

Maximum Zero Fuel Weight (MZFW) :

Maximum operational weight of the aircraft without usable fuel.

Operational Empty Weight (OEW) :

Weight of structure, powerplant, furnishings, systems, and other items of equipment that are an integral part of a particular aircraft configuration plus the operator's items.

The operator's items are the flight and cabin crew and their baggage, unusable fuel, engine oil, emergency equipment, toilet chemical and fluids, galley structure, catering equipment, passenger seats and life vests, documents, etc.

Maximum Payload :

Maximum Zero Fuel Weight (MZFW) minus Operational Empty Weight (OEW).

Maximum Seating Capacity :

Maximum number of passengers specifically certified or anticipated for certification.

Maximum Cargo Volume :

Maximum usable volume available for cargo.

Usable Fuel :

Fuel available for aircraft propulsion.

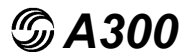

AIRPLANE CHARACTERISTICS FOR AIRPORT PLANNING

		Airplane version						
		A300B2-100				A300B2-200		
		WV000 (Basic)	WV001	WV002	WV003	WV002 (Basic)	WV001	WV003
Maximum Taxi Weight (MTW)	kg	137 900	137 900	142 900	134 900	142 900	137 900	134 900
	lb	304 017	304 017	315 040	297 403	315 040	304 017	297 403
Maximum Takeoff Weight (MTOW)	kg	137 000	137 000	142 000	134 000	142 000	137 000	134 000
	lb	302 032	302 032	313 056	295 419	313 056	302 032	295 419
Maximum Landing Weight (MLW)	kg	127 500	130 000	130 000	130 000	130 000	130 000	130 000
	lb	281 089	286 600	286 600	286 600	286 600	286 600	286 600
Maximum Zero Fuel Weight (MZFW)	kg	116 500	120 500	120 500	120 500	120 500	120 500	120 500
	lb	256 838	265 656	265 656	265 656	265 656	265 656	265 656
Estimated Operational Empty Weight (OEW)	GE CF6-50	85 910 kg (189 398 lb)				86 275 kg (190 203 lb)		
Estimated Maximum Payload GE CF6-50	kg	30 590	34 590	34 590	34 590	34 225	34 225	34 225
	lb	67 439	76 257	76 257	76 257	75 453	75 453	75 453
Standard Seating Capacity	Single-class	269				269		
Usable Fuel Capacity	l	44 000				44 000		
Fuel Capacity	US Gallons	11 623				11 623		
	kg (d=0.785)	35 540				35 540		
	lb	78 352				78 352		
Pressurized Fuselage Volume (A/C non equipped)	m ³	542				542		
	ft ³	19 140				19 140		
Passenger Compartment Volume	m ³	272				272		
	ft ³	9 606				9 606		
Cockpit Volume	m ³	17				17		
	ft ³	600				600		
Usable Cargo Compartment Volume (1)	m ³	144				144		
	ft ³	5 085				5 085		

(1) Volume of Cargo Compartments : Fwd Cargo Compartment : 76 m³ (2 683 ft³)
 Aft Cargo Hold Compartment : 49 m³ (1 730 ft³)
 Bulk Cargo Compartment : 19 m³ (670 ft³)

2.1 GENERAL AIRPLANE CHARACTERISTICS 2.1.1 GENERAL AIRPLANE CHARACTERISTICS DATA Model B2

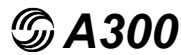

AIRPLANE CHARACTERISTICS FOR AIRPORT PLANNING

		Airplane Version					
		A300B4-100					
		WV000 (Basic)	WV001	WV002	WV003	WV004	WV005
Maximum Taxi Weight (MTW)	kg	150 900	153 900	158 400	158 400	150 900	153 900
	lb	332 677	339 291	349 211	349 211	332 677	339 291
Maximum Takeoff Weight (MTOW)	kg	150 000	153 000	157 500	157 500	150 000	153 000
	lb	330 693	337 306	347 227	347 227	330 693	337 306
Maximum Landing Weight (MLW)	kg	133 000	133 000	133 000	134 000	133 000	134 000
	lb	293 214	293 214	293 214	295 419	293 214	295 419
Maximum Zero Fuel Weight (MZFW)	kg	122 000	122 000	122 000	124 000	122 000	124 000
	lb	268 963	268 963	268 963	273 372	268 963	273 372
Estimated Operational Empty Weight (OEW)	GE CF6-50	88 180 kg (194 403 lb)		88 330 kg (194 734 lb)		88 180 kg (194 403 lb)	
Estimated Maximum Payload GE CF6-50	kg	33 820	33 820	33 670	35 670	33 820	35 820
	lb	74 560	74 560	74 229	78 638	74 560	78 969
Standard Seating Capacity	single-class	269					
Usable Fuel Capacity	l	58 100					
Fuel Capacity	US Gallons	15 348					
	kg (d=0.785)	45 608					
	lb	100 548					
Pressurized Fuselage Volume (A/C non equipped)	m ³	542					
	ft ³	19 140					
Passenger Compartment Volume	m ³	272					
	ft ³	9 606					
Cockpit Volume	m ³	17					
	ft ³	600					
Usable Cargo Compartment Volume (1)	m ³	144					
	ft ³	5 085					

(1) Volume of Cargo Compartments : Fwd Cargo Compartment : 76 m³ (2 683 ft³)
 Aft Cargo Hold Compartment : 49 m³ (1 730 ft³)
 Bulk Cargo Compartment : 19 m³ (670 ft³)

2.1 GENERAL AIRPLANE CHARACTERISTICS 2.1.1 GENERAL AIRPLANE CHARACTERISTICS DATA Model B4

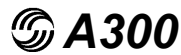

AIRPLANE CHARACTERISTICS FOR AIRPORT PLANNING

		Airplane Version						
		A300B4-100				A300B4-200		
		WV013	WV014	WV015	WV016	WV006 (Basic)	WV007	WV008
Maximum Taxi Weight (MTW)	kg	150 900	158 400	150 900	153 900	165 900	165 900	158 400
	lb	332 677	349 211	332 677	339 291	365 740	365 740	349 211
Maximum Takeoff Weight (MTOW)	kg	150 000	157 500	150 000	153 000	165 000	165 000	157 500
	lb	330 693	347 227	330 693	337 306	363 760	363 760	347 227
Maximum Landing Weight (MLW)	kg	134 000	134 000	134 000	134 000	134 000	136 000	134 000
	lb	295 419	295 419	295 419	295 419	295 419	299 828	295 419
Maximum Zero Fuel Weight (MZFW)	kg	126 000	126 000	126 000	126 000	124 000	126 000	124 000
	lb	277 782	277 782	277 782	277 782	273 372	277 782	273 372
Estimated Operational Empty Weight (OEW)	GE CF6-50	88 180 kg (194 403 lb)	88 330 kg (194 734 lb)	88 180 kg (194 403 lb)		88 505 kg (195 119 lb)		
Estimated Maximum Payload GE CF6-50	kg	37 820	37 670	37 820	37 820	35 495	37 495	35 495
	lb	83 378	83 048	83 378	83 378	78 252	82 662	78 252
Standard Seating Capacity	single-class	269				269		
Usable Fuel Capacity	L	58 100				62 000		
Capacity	US Gallons	15 348				16 380		
	kg (d=0.785)	45 608				48 470		
	lb	100 548				107 299		
Pressurized Fuselage Volume (A/C non equipped)	m ³	542				542		
	ft ³	19 140				19 140		
Passenger Compartment Volume	m ³	272				272		
	ft ³	9 606				9 606		
Cockpit Volume	m ³	17				17		
	ft ³	600				600		
Usable Cargo Compartment Volume (1)	m ³	144				144		
	ft ³	5 085				5 085		

(1) Volume of Cargo Compartments : Fwd Cargo Compartment : 76 m³ (2 683 ft³)
 Aft Cargo Hold Compartment : 49 m³ (1 730 ft³)
 Bulk Cargo Compartment : 19 m³ (670 ft³)

2.1 GENERAL AIRPLANE CHARACTERISTICS 2.1.1 GENERAL AIRPLANE CHARACTERISTICS DATA Model B4

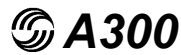

AIRPLANE CHARACTERISTICS FOR AIRPORT PLANNING

		Airplane Version					
		A300B4-200					
		WV010	WV014	WV016	WV017	WV018	WV020
Maximum Taxi Weight (MTW)	kg	158 400	158 400	153 900	148 400	165 900	158 400
	lb	349 211	349 211	339 291	327 165	365 740	349 211
Maximum Takeoff Weight (MTOW)	kg	157 500	157 500	153 000	147 500	165 000	157 500
	lb	347 227	347 227	337 304	325 181	363 760	347 227
Maximum Landing Weight (MLW)	kg	136 000	134 000	140 000	136 000	134 000	134 000
	lb	299 828	295 419	308 650	299 828	295 419	295 419
Maximum Zero Fuel Weight (MZFW)	kg	126 000	126 000	130 000	126 000	126 000	126 000
	lb	277 782	277 782	286 600	277 782	277 782	277 782
Estimated Operational Empty Weight (OEW)	GE CF6-50	88 505 kg (195 119 lb)					
Estimated Maximum Payload GE CF6-50	kg	37 495	37 495	35 495	37 495	37 495	37 495
	lb	82 662	82 662	78 252	82 662	82 662	82 662
Standard Seating Capacity	single-class	269					
Usable Fuel Capacity	l	62 000					
Fuel Capacity	US Gallons	16 380					
	kg (d=0.785)	48 470					
	lb	107 299					
Pressurized Fuselage Volume (A/C non equipped)	m ³	542					
	ft ³	19 140					
Passenger Compartment Volume	m ³	272					
	ft ³	9 606					
Cockpit Volume	m ³	17					
	ft ³	600					
Usuable Cargo Compartment Volume (1)	m ³	144					
	ft ³	5 085					

(1) Volume of Cargo Compartments : Fwd Cargo Compartment : 76 m³ (2 683 ft³)
 Aft Cargo Hold Compartment : 49 m³ (1 730 ft³)
 Bulk Cargo Compartment : 19 m³ (670 ft³)

2.1 GENERAL AIRPLANE CHARACTERISTICS 2.1.1 GENERAL AIRPLANE CHARACTERISTICS DATA Model B4

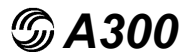

AIRPLANE CHARACTERISTICS FOR AIRPORT PLANNING

		Airplane Version		
		A300C4-200		A300F4-200
		WV006 (Basic)	WV007	WV007 (Basic)
Maximum Taxi Weight (MTW)	kg	165 900	165 900	165 900
	lb	365 740	365 740	365 740
Maximum Takeoff Weight (MTOW)	kg	165 000	165 000	165 000
	lb	363 760	363 760	363 760
Maximum Landing Weight (MLW)	kg	134 000	136 000	136 000
	lb	295 419	299 828	299 828
Maximum Zero Fuel Weight (MZFW)	kg	124 000	126 000	126 000
	lb	273 372	277 782	277 782
Estimated Operational Empty Weight (OEW)	GE CF6-50	88 505 kg (195 119 lb)		84 000 kg (185 188 lb)
Estimated Maximum Payload GE CF6-50	kg	35 495	37 495	42 000
	lb	78 252	82 662	92 594
Standard Seating Capacity	single-class	269		4
Usable Fuel Capacity	l	62 000		62 000
	US Gallons	16 380		16 380
	kg (d=0.785)	48 670		48 670
	lb	107 299		107 299
Pressurized Fuselage Volume (A/C non equipped)	m3	542		542
	ft3	19 140		19 140
Passenger Compartment Volume	m3	272		
	ft3	9 606		
Cockpit Volume	m3	17		17
	ft3	600		600
Main Deck Cargo Compartment Volume	m3			540
	ft3			10 069
Usable Cargo Compartment Volume (1)	m3	158		158
	ft3	5 579		5 579

(1) Volume of Cargo Compartments : Fwd Cargo Compartment : 76 m3 (2 683 ft3)
 Aft Cargo Hold Compartment : 61 m3 (2 154 ft3)
 Bulk Cargo Compartment : 21 m3 (741 ft3)

2.1 GENERAL AIRPLANE CHARACTERISTICS 2.1.1 GENERAL AIRPLANE CHARACTERISTICS DATA Model C4 - F4

A 300

AIRPLANE CHARACTERISTICS

Printed in France

AA 5 02 02 00 0 AA 0

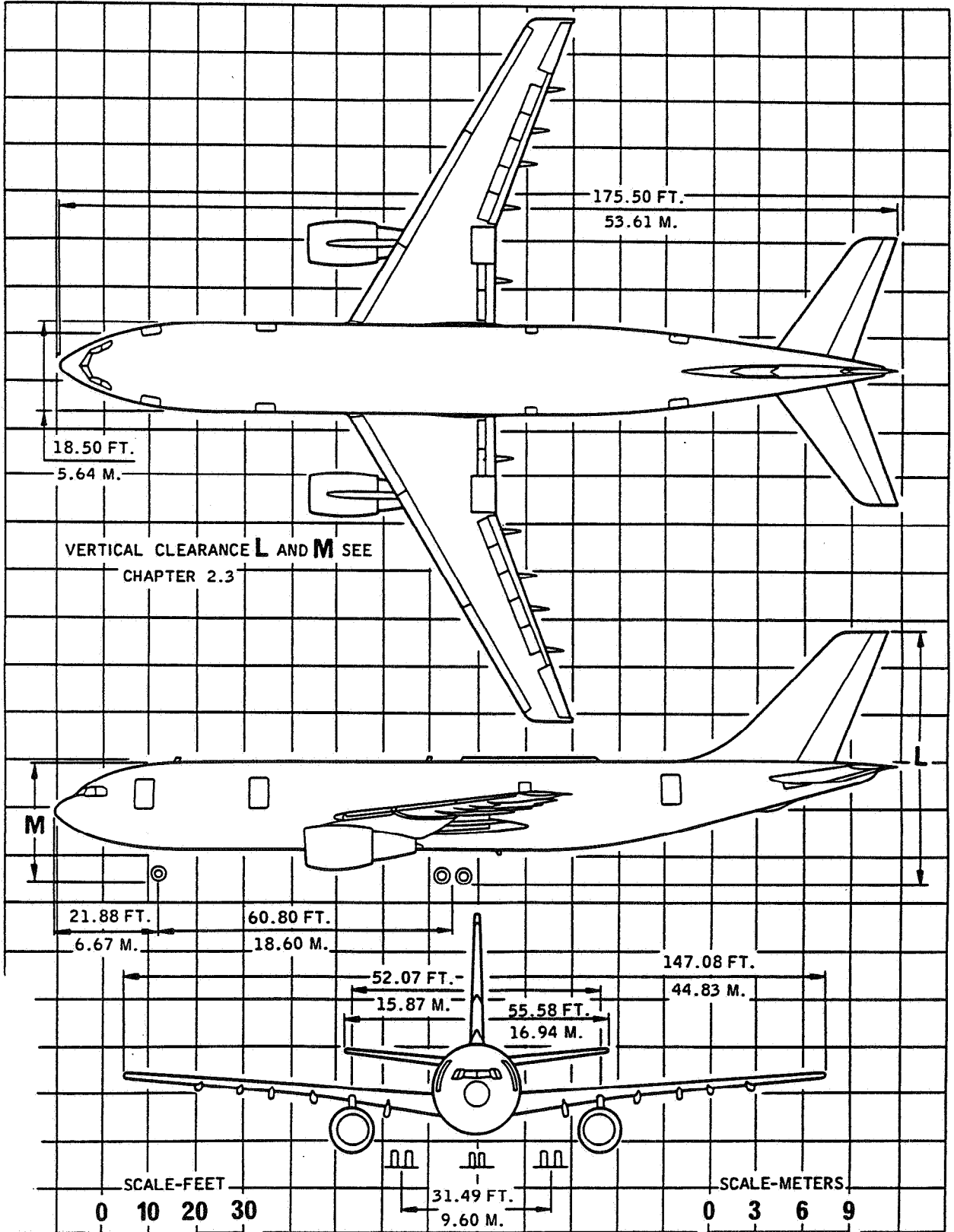

2.2 GENERAL DIMENSIONS
MODEL B2 - B4

A 300
AIRPLANE CHARACTERISTICS

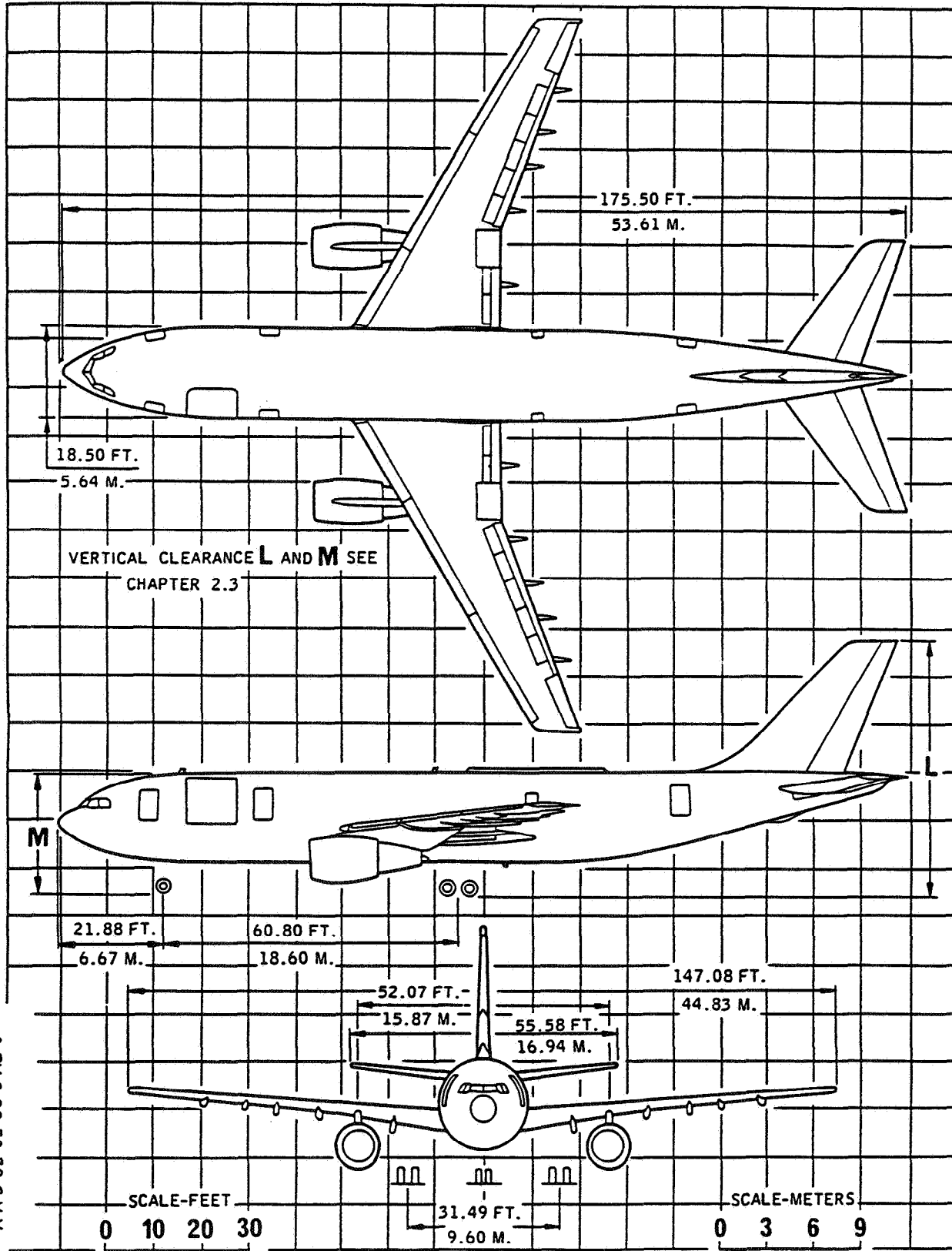

Printed in France

A A 5 02 02 00 0 AB 0

2.2 GENERAL DIMENSIONS
MODEL C4

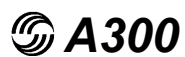

AIRPLANE CHARACTERISTICS FOR AIRPORT PLANNING

2.3 Ground Clearances

NOTE : The distances given in the Ground Clearances charts are reference distances calculated for A/C weight and CG conditions.
The conditions used in the calculations are maximum A/C weight (minimum ground clearances) and a typical A/C maintenance weight (typical ground clearances for maintenance).



AIRPLANE CHARACTERISTICS FOR AIRPORT PLANNING

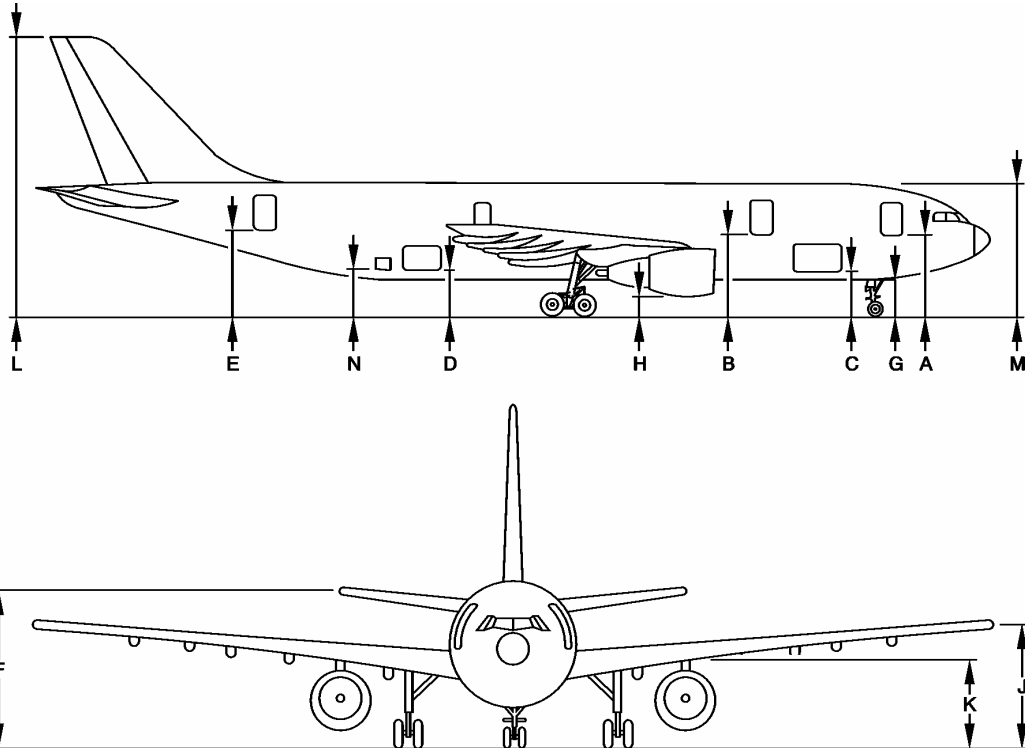

VERTICAL CLEARANCES								
	OPERATING WEIGHT EMPTY		MAXIMUM RAMP WEIGHT				A/C ON JACKS FDL at 6615 mm	
	CG 24 %		CG 15 %		CG 35 %		m	ft
	m	ft	m	ft	m	ft		
A	4.67	15.32	4.48	14.70	4.64	15.22	6.46	21.19
B	4.75	15.58	4.59	15.06	4.70	15.42	6.42	21.06
C	2.73	8.96	2.55	8.37	2.68	8.79	4.47	14.66
D	3.09	10.14	3.01	9.88	2.92	9.58	4.43	14.53
E	5.37	17.62	5.30	17.39	5.15	16.90	6.60	21.65
F	7.84	25.72	7.82	25.66	7.57	24.84	8.88	29.13
G	2.07	6.79	1.90	6.23	2.02	6.63	3.80	12.46
H	1.08	3.54	0.93	3.05	0.83	2.72	2.51	8.23
J	6.06	19.88	5.96	19.55	5.90	19.36	7.62	24.99
K	4.31	14.14	4.18	13.71	4.19	13.75	5.83	19.12
L	16.70	54.79	16.69	54.76	16.40	53.81	17.74	58.20
M	7.71	25.30	7.54	24.74	7.66	25.13	9.44	30.97
N	3.19	10.47	3.11	10.20	2.99	9.81	4.47	14.66

AA5 02 03 00 5 AAM0 01

2.3 Ground Clearances Model B2



AIRPLANE CHARACTERISTICS FOR AIRPORT PLANNING

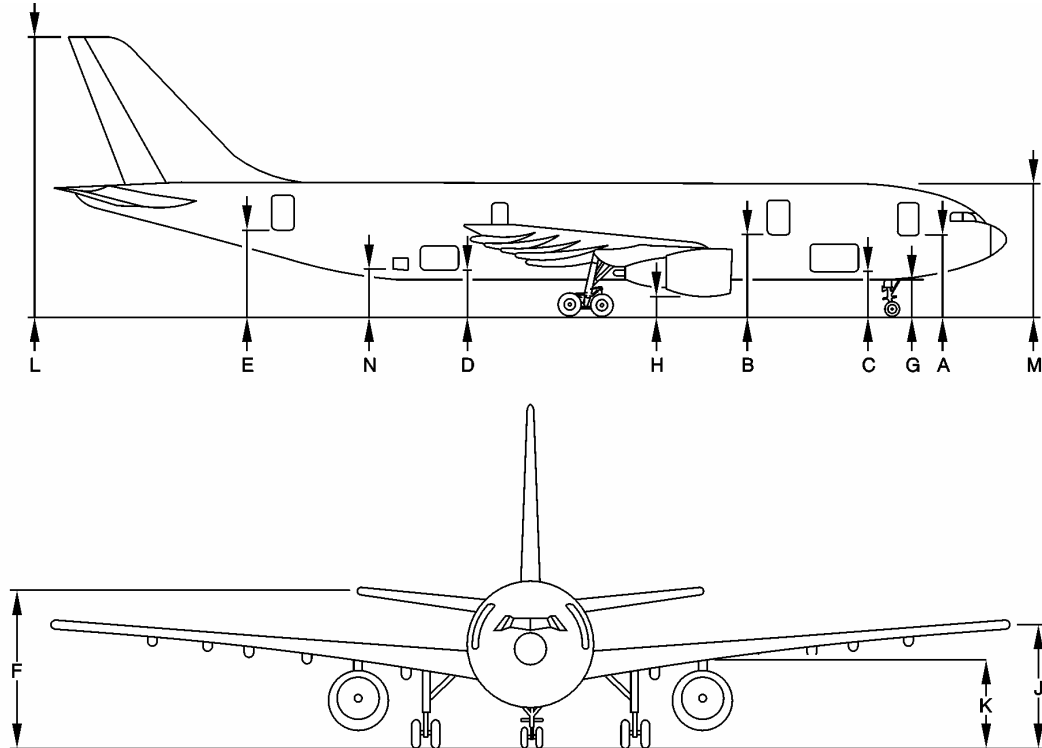

VERTICAL CLEARANCES								
	OPERATING WEIGHT EMPTY		MAXIMUM RAMP WEIGHT				A/C ON JACKS FDL at 6615 mm	
	CG 25 %		CG 15 %		CG 33 %		m	ft
	m	ft	m	ft	m	ft		
A	4.67	15.32	4.49	14.73	4.62	15.16	6.46	21.19
B	4.78	15.68	4.59	15.06	4.68	15.36	6.42	21.06
C	2.73	8.96	2.53	8.30	2.69	8.83	4.47	14.66
D	3.10	10.17	3.00	9.84	2.92	9.58	4.43	14.53
E	5.38	17.65	5.29	17.36	5.16	16.93	6.60	21.65
F	7.86	25.79	7.80	25.59	7.58	24.87	8.88	29.13
G	2.07	6.79	1.90	6.23	2.01	6.59	3.80	12.46
H	1.08	3.54	0.93	3.05	0.97	3.18	2.51	8.23
J	6.07	19.92	5.95	19.52	5.90	19.36	7.62	24.99
K	4.32	14.17	4.18	13.71	4.19	13.75	5.83	19.12
L	16.72	54.86	16.67	54.69	16.43	53.91	17.74	58.20
M	7.71	25.30	7.54	24.74	7.65	25.10	9.44	30.97
N	3.20	10.50	3.10	10.17	3.00	9.84	4.47	14.66

AA5 02 03 00 5 ABM0 01

2.3 Ground Clearances Model B2 - B4



AIRPLANE CHARACTERISTICS FOR AIRPORT PLANNING

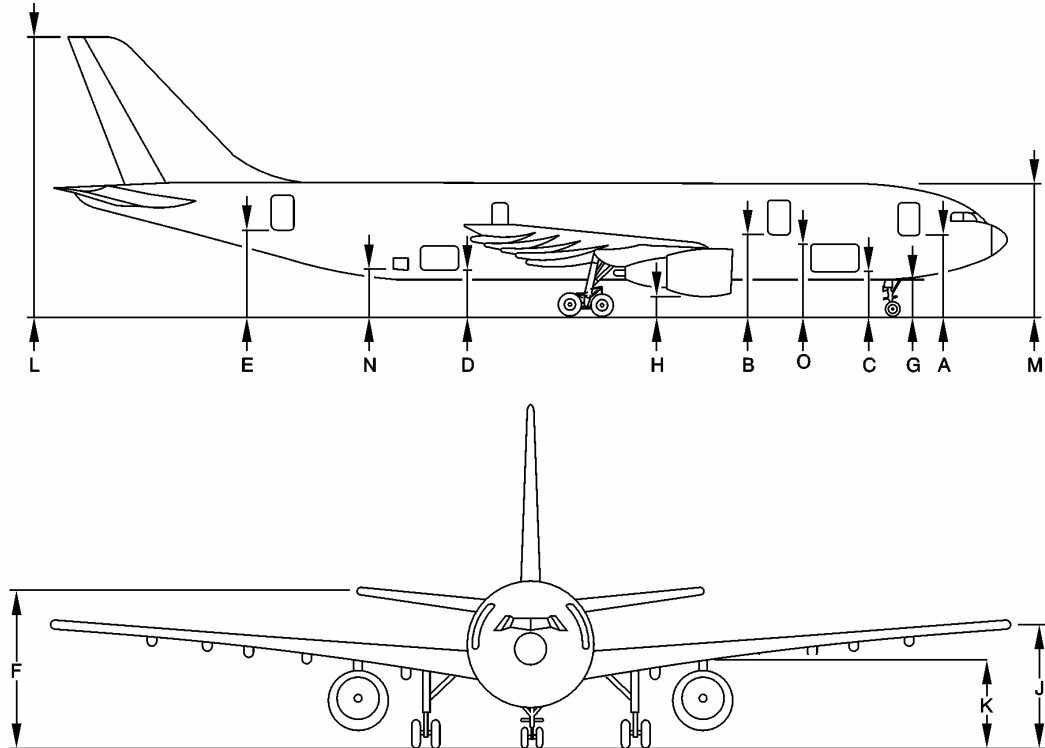

VERTICAL CLEARANCES								
	OPERATING WEIGHT EMPTY		MAXIMUM RAMP WEIGHT				A/C ON JACKS FDL at 6615 mm	
	CG 25 %		CG 15 %		CG 33 %		m	ft
	m	ft	m	ft	m	ft		
A	4.67	15.32	4.49	14.73	4.62	15.16	6.46	21.19
B	4.78	15.68	4.59	15.06	4.68	15.36	6.42	21.06
C	2.73	8.96	2.53	8.30	2.69	8.83	4.47	14.66
D	3.10	10.17	3.00	9.84	2.92	9.58	4.43	14.53
E	5.38	17.65	5.29	17.36	5.16	16.93	6.60	21.65
F	7.86	25.79	7.80	25.59	7.58	24.87	8.88	29.13
G	2.07	6.79	1.90	6.23	2.01	6.59	3.80	12.46
H	1.08	3.54	0.93	3.05	0.97	3.18	2.51	8.23
J	6.07	19.92	5.95	19.52	5.90	19.36	7.62	24.99
K	4.32	14.17	4.18	13.71	4.19	13.75	5.83	19.12
L	16.72	54.86	16.67	54.69	16.43	53.91	17.74	58.20
M	7.71	25.30	7.54	24.74	7.65	25.10	9.44	30.97
N	3.20	10.50	3.10	10.17	3.00	9.84	4.47	14.66
O	4.56	14.96	4.41	14.47	4.49	14.73	6.27	20.57

AA5 02 03 00 5 ACM0 01

2.3 Ground Clearances Model C4

A 300

AIRPLANE CHARACTERISTICS

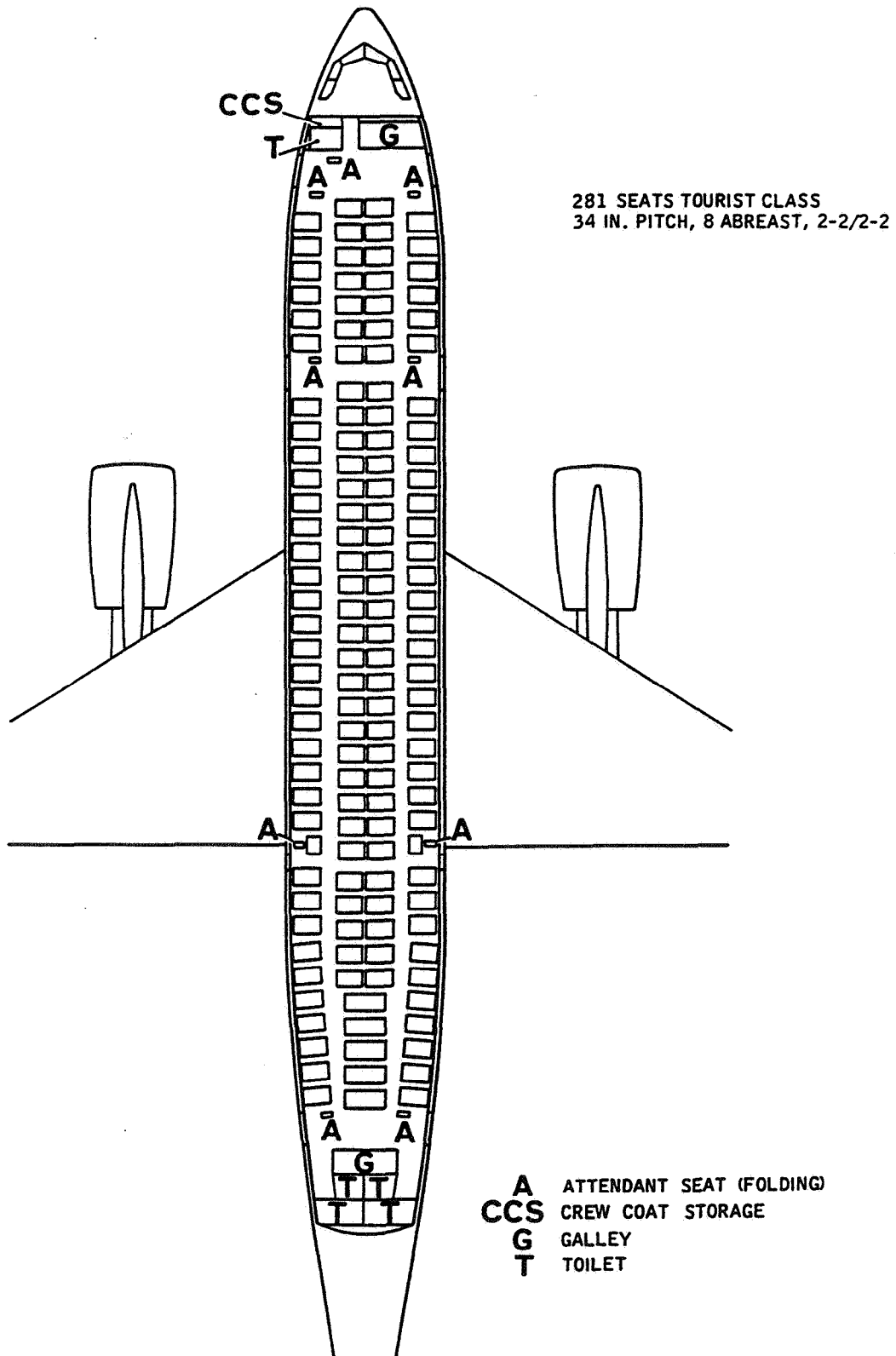

Printed in France

A A 5 02 04 00 0 AF 0

2.4 INTERIOR ARRANGEMENT
2.4.1 BASIC VERSION
MODEL B2 - B4 - C4

A 300

AIRPLANE CHARACTERISTICS

Printed in France

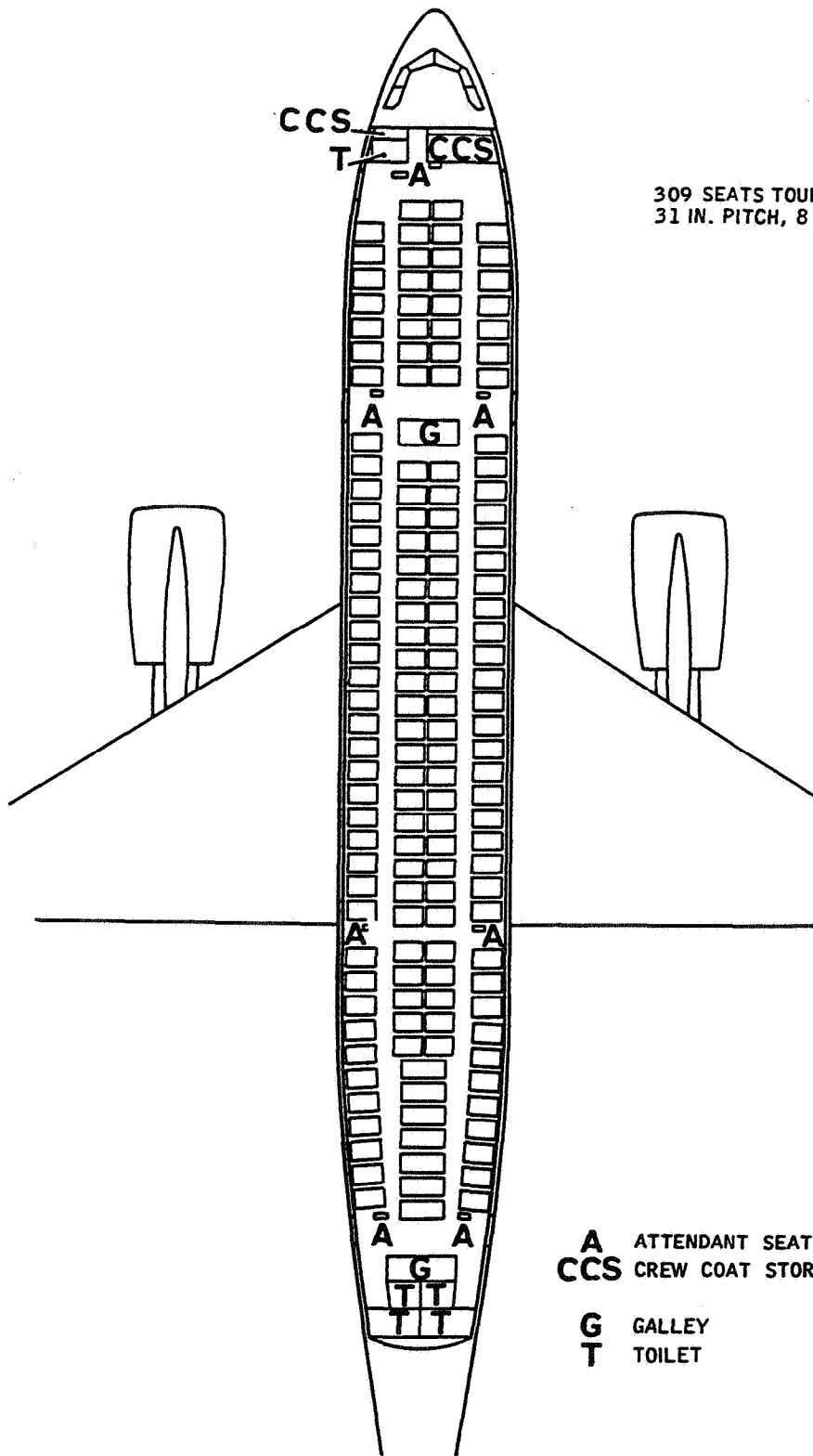

309 SEATS TOURIST CLASS
31 IN. PITCH, 8 ABREAST, 2-2/2-2

- A** ATTENDANT SEAT (FOLDING)
- CCS** CREW COAT STORAGE
- G** GALLEY
- T** TOILET

A A 5 02 04 00 0 BF 0

2.4 INTERIOR ARRANGEMENT
2.4.2 BASIC HIGH DENSITY VERSION
MODEL B2 - B4 - C4

A 300

AIRPLANE CHARACTERISTICS

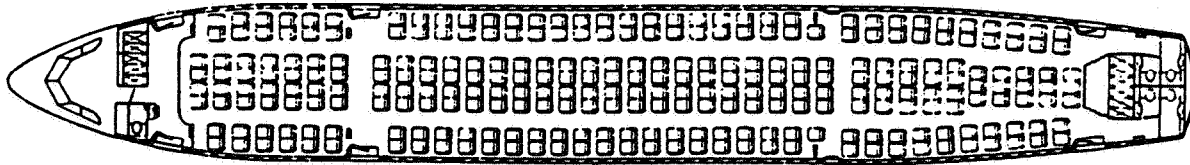

281 seats

A variety of seating configuration is possible without modifications to the seat rails or floor support structure.

The aircraft is certificated for the carriage of up to 345 passengers.

Printed in France

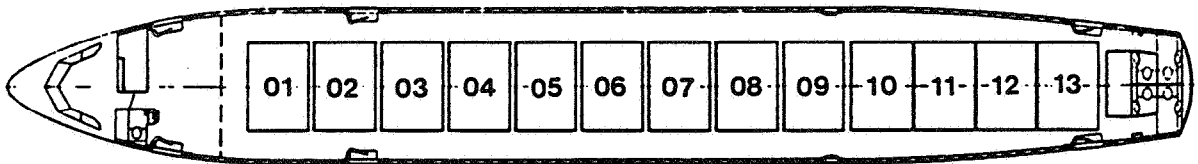

Mixed pallets
88" x 125"
96" x 125"

The above figure shows the numbering of the pallet positions in the cabin. Either 88" x 125" or 96" x 125" pallets can be loaded in any position from 01 to 09. Only 88" x 125" pallets can be loaded in position 10 to 13.

AA 5 02 04 03 0 AA 0

2.4 INTERIOR ARRANGEMENT

2.4.3 BASIC UPPER DECK CONFIGURATIONS

MODEL C4

A 300

AIRPLANE CHARACTERISTICS

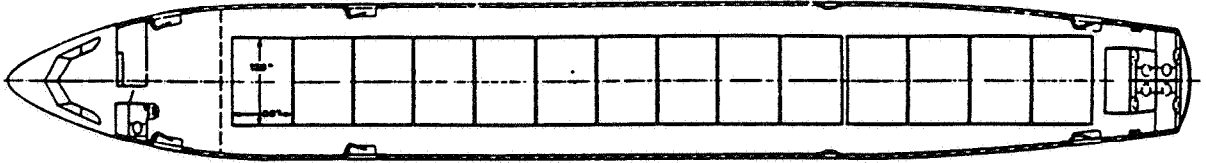

Configuration 1
14 pallets 88" x 125"

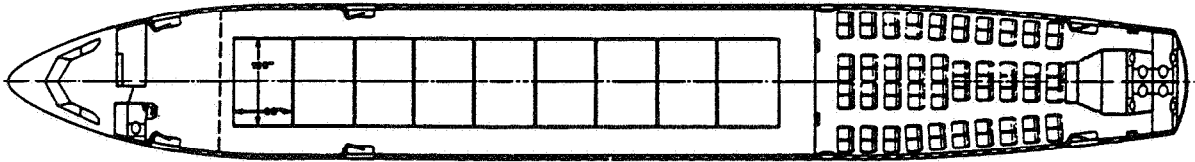

Configuration 2
75 seats
9 pallets 88" x 125"

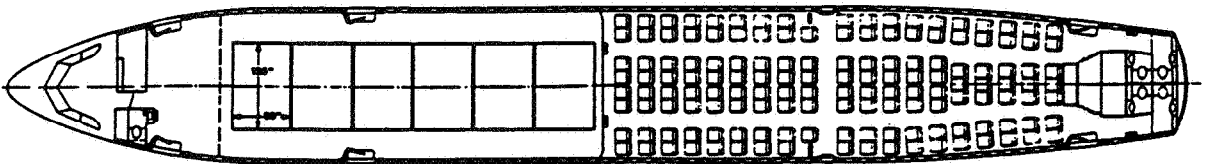

Configuration 3
145 seats
6 pallets 88" x 125"

AA 5 02 04 04 0 AA 0

2.4 INTERIOR ARRANGEMENT

2.4.4 OPTIONAL UPPER DECK CONFIGURATIONS

MODEL C4

AIRBUS  INDUSTRIE
A 300
 AIRPLANE CHARACTERISTICS

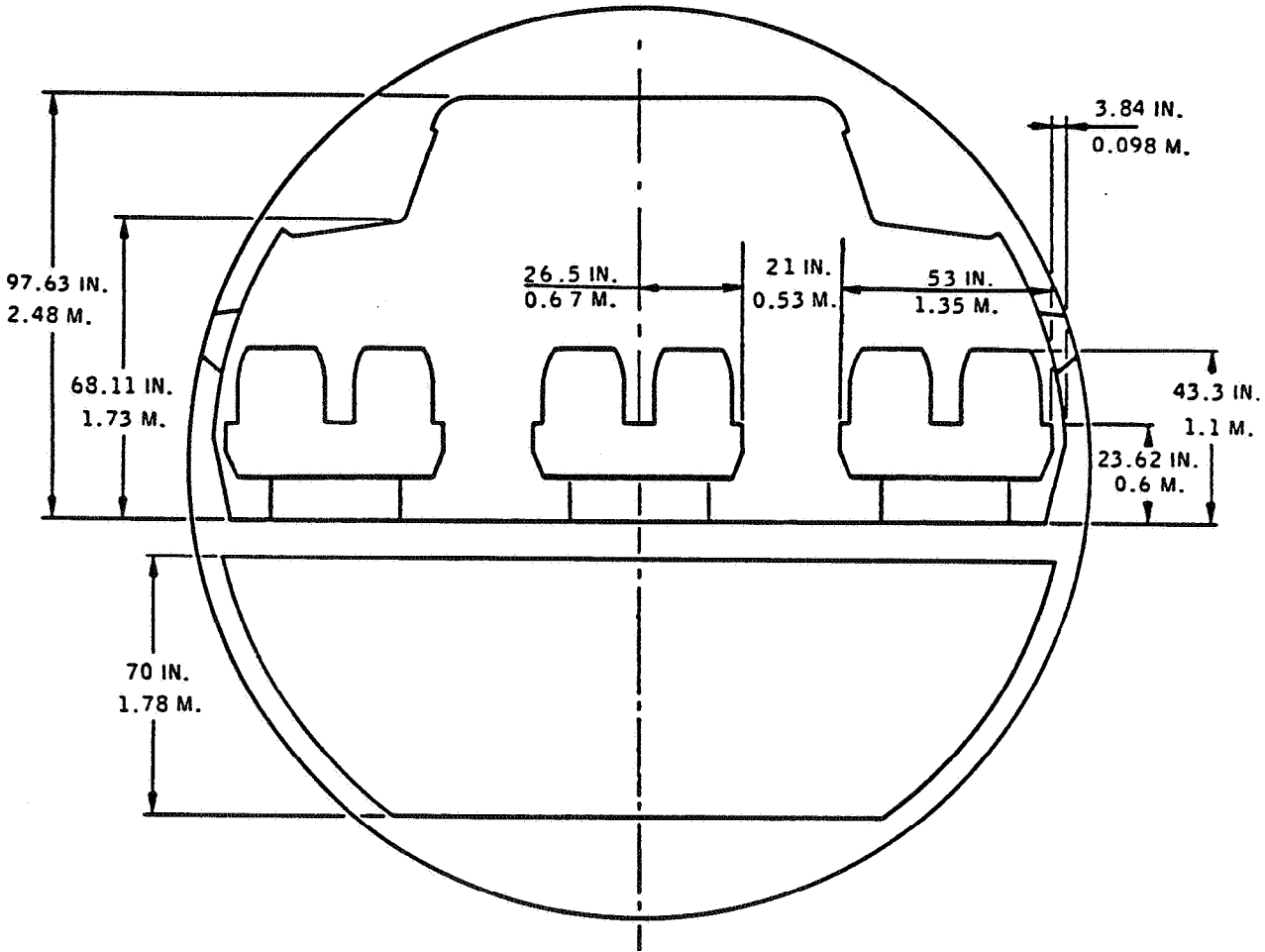

Printed in France

A A 5 02 05 01 0 AA 0

2.5 PASSENGER CABIN CROSS SECTION
 2.5.1 SEATING CONFIGURATION - 6 ABREAST - FIRST CLASS
 MODEL B2 - B4 - C4

A 300
AIRPLANE CHARACTERISTICS

Printed in France

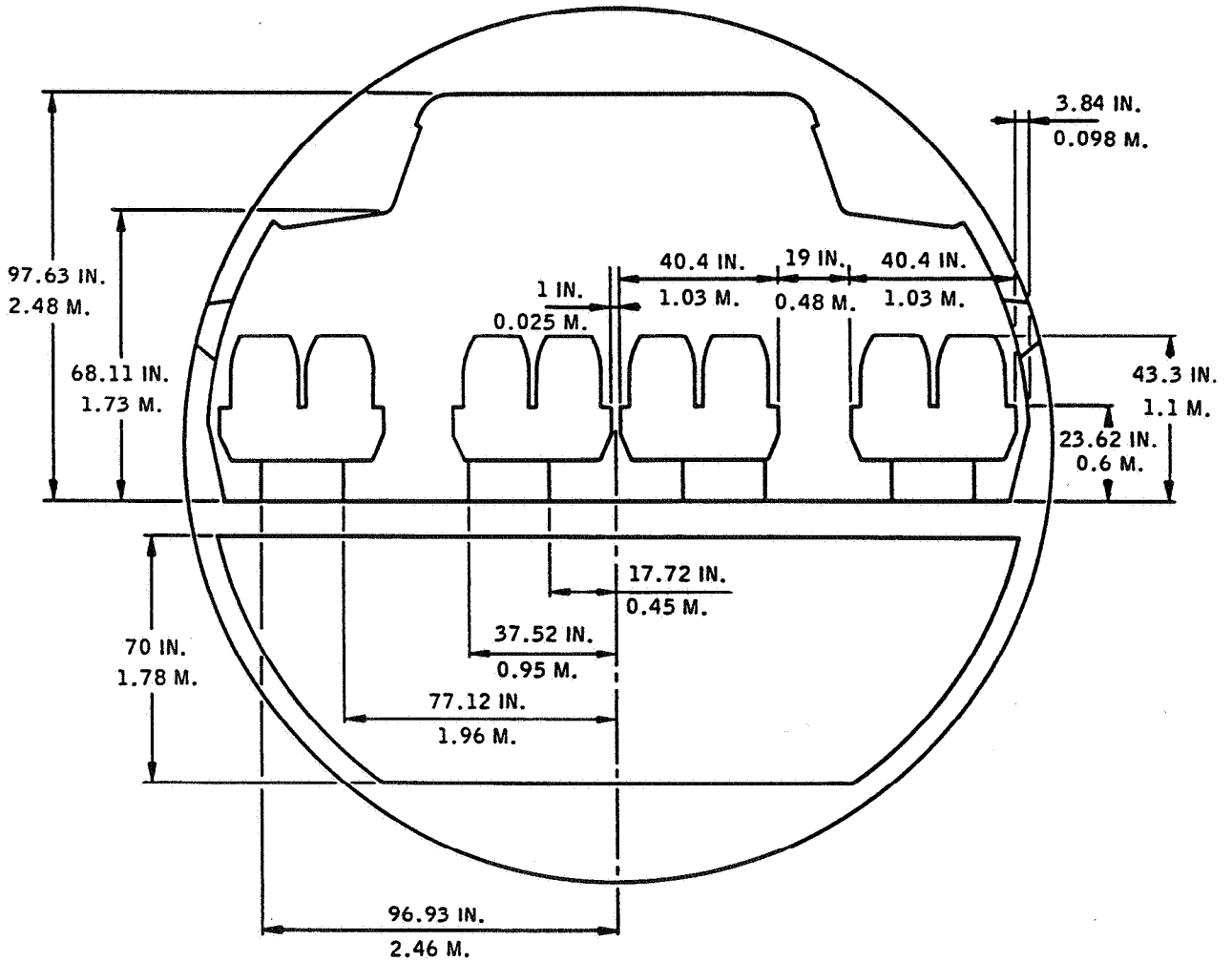

A A 5 02 05 02 0 AA 0

2.5 PASSENGER CABIN CROSS SECTION
2.5.2 SEATING CONFIGURATION - 8 ABREAST - TOURIST CLASS
MODEL B2 - B4 - C4

AIRBUS  INDUSTRIE
A 300
 AIRPLANE CHARACTERISTICS

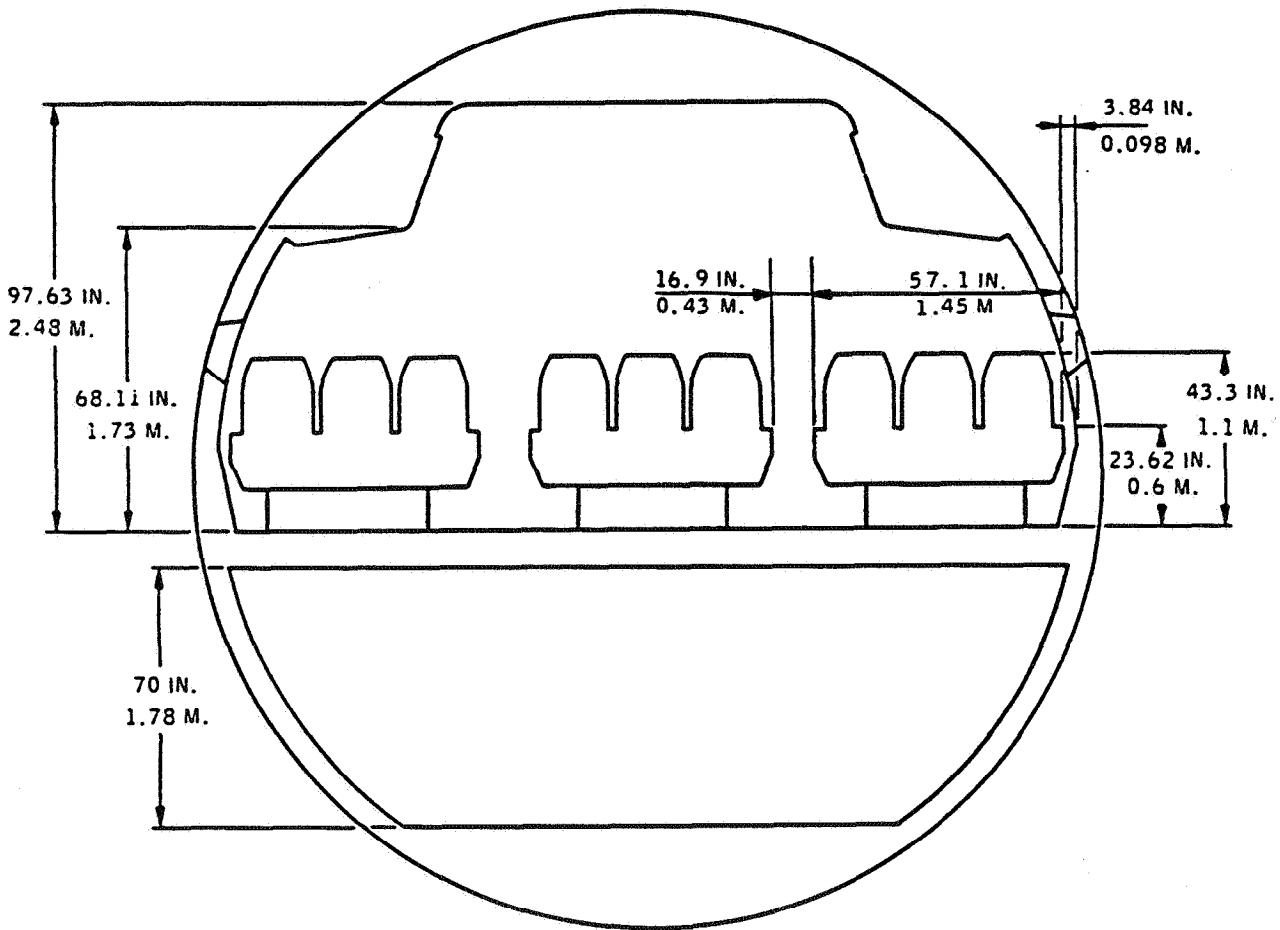

Printed in France

AA 5 02 05 03 0 AA 0

2.5 PASSENGER CABIN CROSS SECTION
 2.5.3 SEATING CONFIGURATION - 9 ABREAST - CHARTER OPERATION
 MODEL B2 - B4 - C4

A 300
AIRPLANE CHARACTERISTICS

FWD HOLD

AFT HOLD

BULK HOLD

TOTAL

Maximum Volume Capacity

m ³	ft ³
75	2649
Kg	1b

m ³	ft ³
47	1650
Kg	1b

m ³	ft ³
16	565
Kg	1b

m ³	ft ³
138	4864
Kg	1b

Containers in Forward and Aft Holds

12 LD3
Containers

8 LD3
Containers

EACH	4.47	158
	1285	2830
TOTAL	53.64	1896
	15420	33960

EACH	4.47	158
	1285	2830
TOTAL	35.76	1264
	10280	22640

16.00	565	
2500	5500	

105.40	3725
28200	62100

6 LD1
Containers

4 LD1
Containers

EACH	4.90	173
	1285	2830
TOTAL	29.40	1038
	7710	16980

EACH	4.90	173
	1285	2830
TOTAL	19.60	692
	5140	10520

16.00	565	
2500	5500	

55.00	2295
15350	33000

Pallets in Forward Hold and Container in Aft Hold

4
Pallets

8 LD3
Containers

EACH	10.73	379
	3770	8300
TOTAL	42.92	1518
	15070	33200

EACH	4.47	158
	1285	2830
TOTAL	35.76	1264
	10280	22640

16.00	565	
2500	5500	

94.68	3347
27850	61340

4
Pallets

4 LD1
Containers

EACH	10.73	379
	3770	8300
TOTAL	42.92	1518
	15070	33200

EACH	4.90	173
	1285	2830
TOTAL	19.60	692
	5140	10520

16.00	565	
2500	5500	

78.52	2775
22710	49220

2.6 LOWER COMPARTMENTS
2.6.1 WEIGHT AND VOLUME DATA
MODEL B2 - B4 - C4

Printed in France

A 300
AIRPLANE CHARACTERISTICS

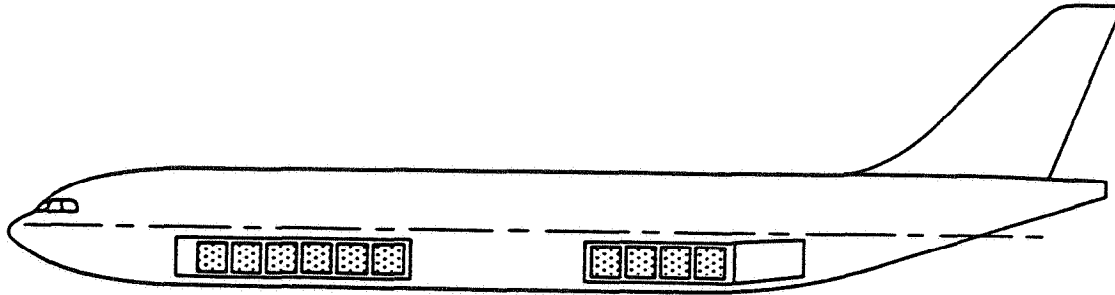

CARGO DOORS AND
BULK CARGO DOOR
R H SIDE

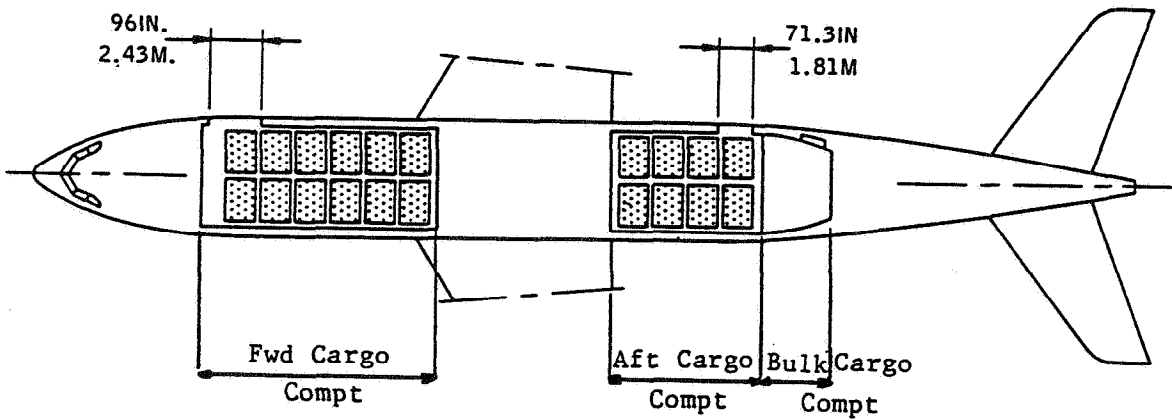

Printed in France

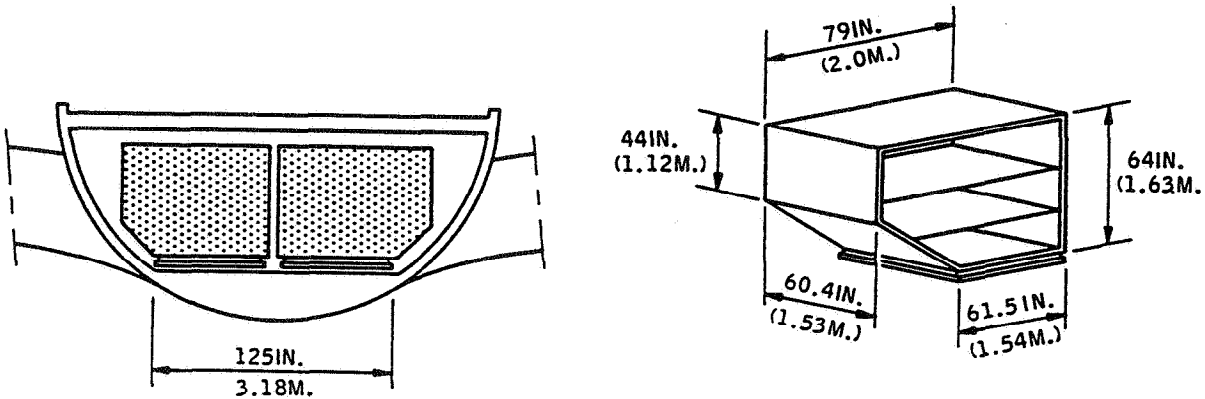

2.6 LOWER COMPARTMENTS
2.6.2 CONTAINERS
MODEL B2 - B4 - C4

A A 5 02 06 00 0 BF 0

A 300
AIRPLANE CHARACTERISTICS

Printed in France

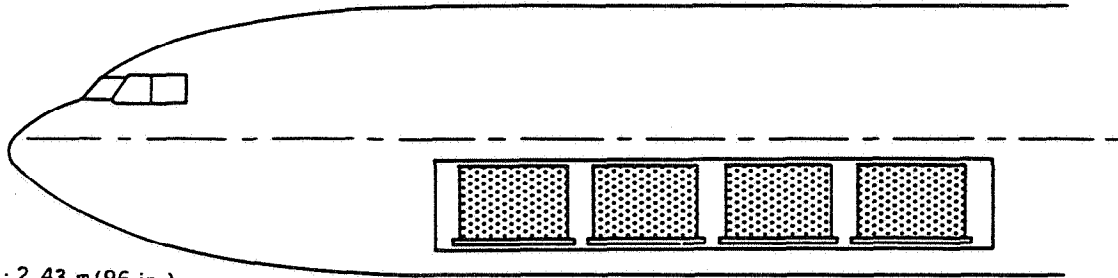

A : 2.43 m (96 in.)
AFTER MOD. 2295
A : 2.70 m (106 in.)

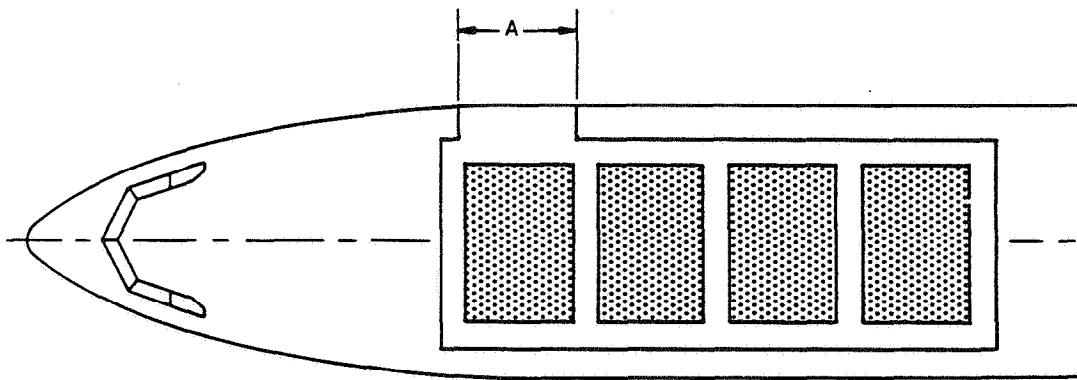

4 PALLETS FRONT HOLD ONLY.
ENTRY DOOR R H SIDE

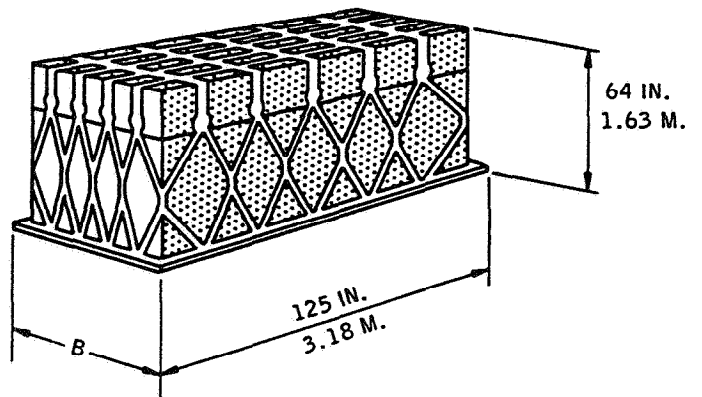
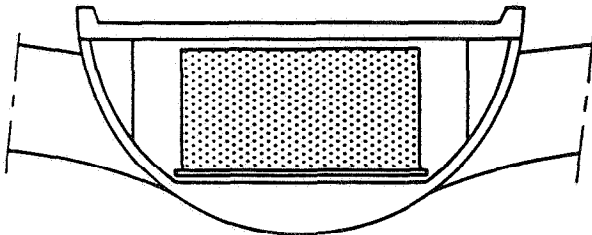

A A 5 0206 00 0 CM 0
A 25 5 B P008 01 00 A

		B	
in.	88	96	
m	2.23	2.44	

K

2.6 LOWER COMPARTMENTS
2.6.3 PALLETS
MODEL B2 - B4 - C4

A 300
AIRPLANE CHARACTERISTICS

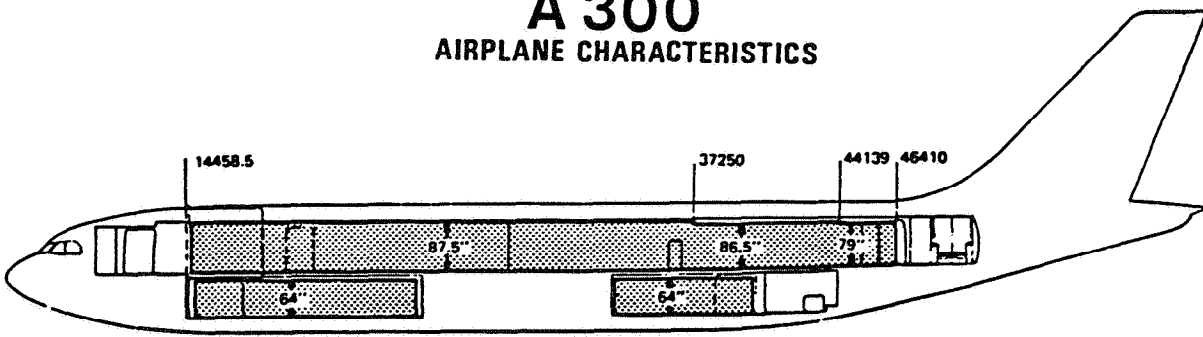

PERMISSIBLE CARGO HEIGHT

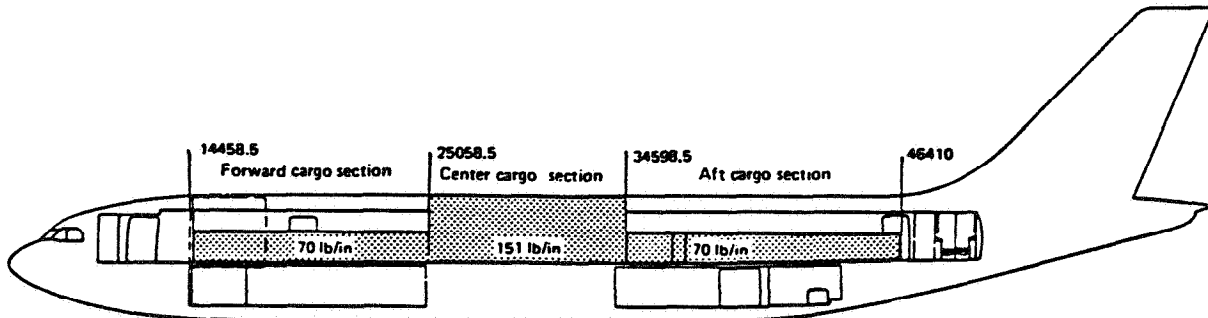

LOCAL FLOOR LOADS

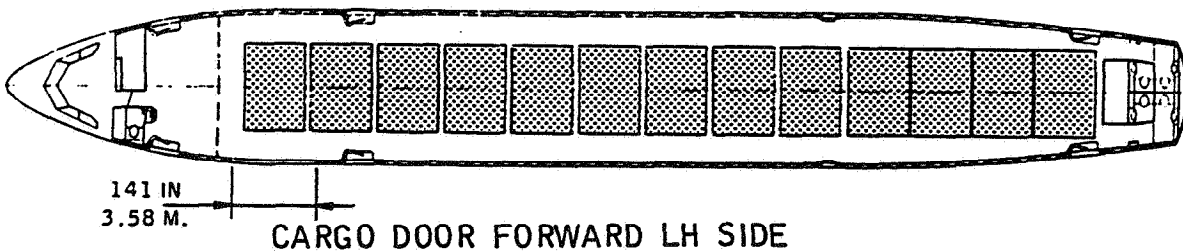

CARGO DOOR FORWARD LH SIDE

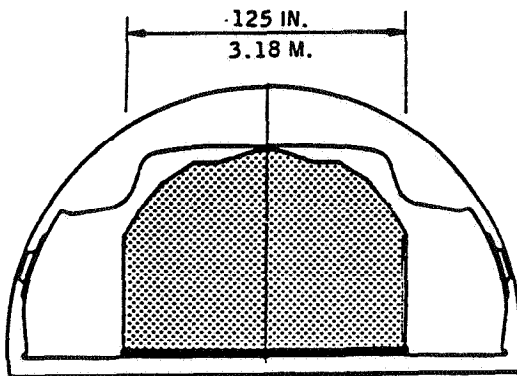

- 87.5in. = 2.222M.
- 86.5in. = 2.197M.
- 79.0in. = 2.006M.
- 64.0in. = 1.625M.

The permissible floor loading is, as shown, based on a pallet width of 125in. The reinforced floor structure over the wing box will permit pallets weighing 13,300lb/6,030Kg to be loaded.

2.7. UPPER DECK CARGO
MODEL C4

Printed in France

AA 5 02 07 00 0 AA 0

A 300

AIRPLANE CHARACTERISTICS

Printed in France

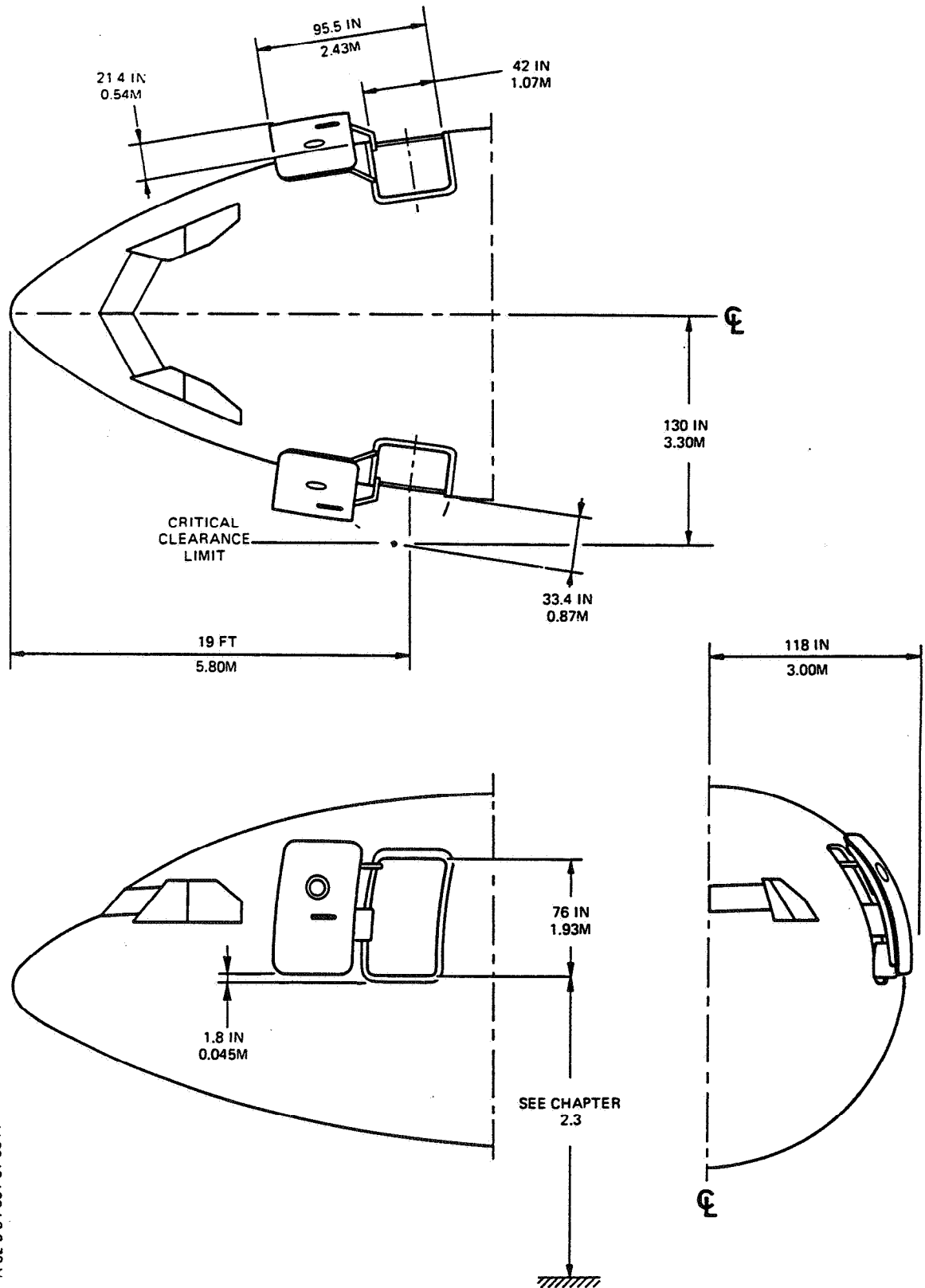

A Z 301 11 000 AM 0
A 52 58 P001 01 00 A

2.8 DOOR CLEARANCES

2.8.1 FORWARD PASSENGER DOOR

MODEL B2 - B4 - C4

A 300
AIRPLANE CHARACTERISTICS

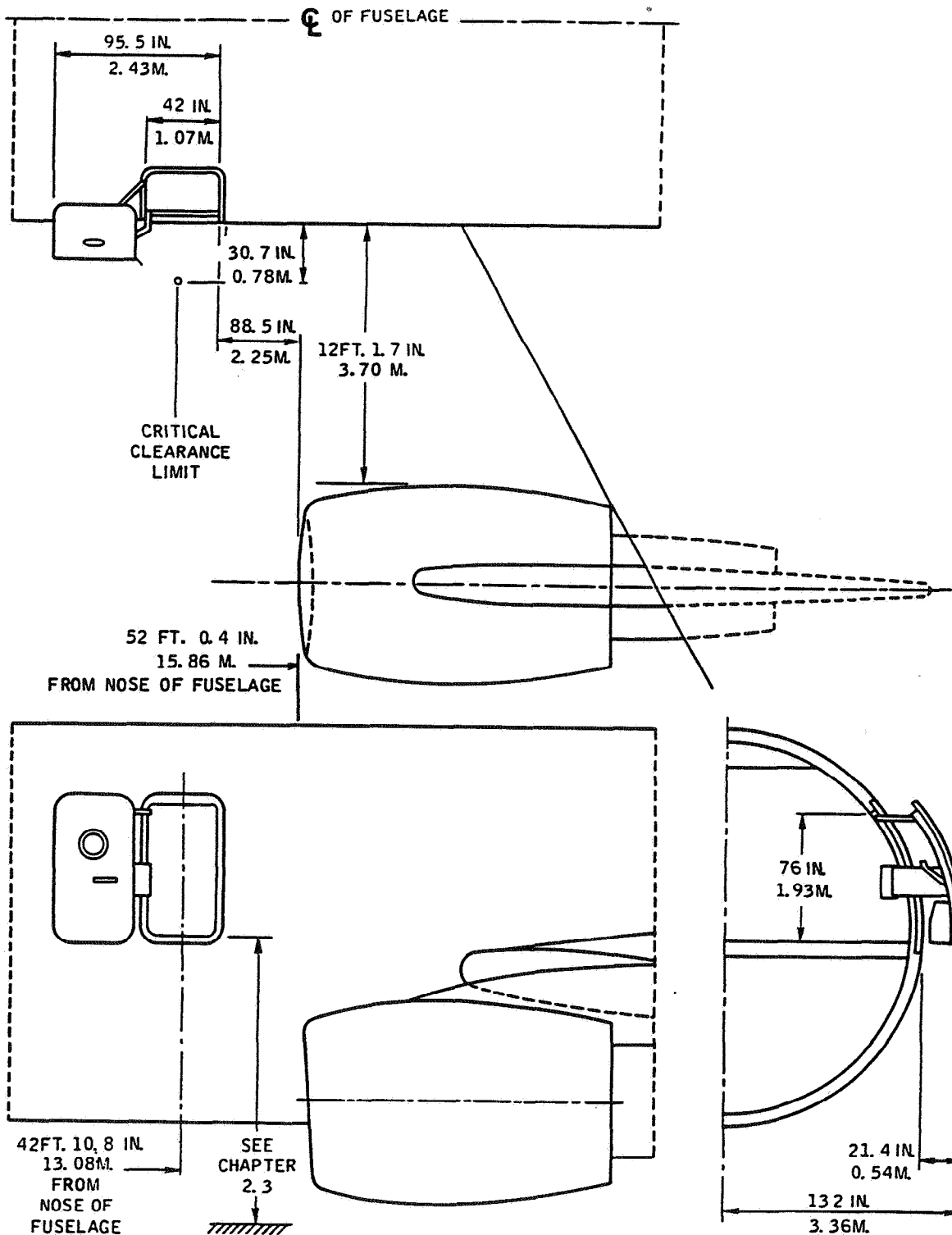

Printed in France

A 5 02 08 02 0 AA 0

2.8 DOOR CLEARANCES
2.8.2 MIDDLE PASSENGER DOOR
MODEL B2 - B4 - C4 G. E. ENGINES

A 300
AIRPLANE CHARACTERISTICS

Printed in France

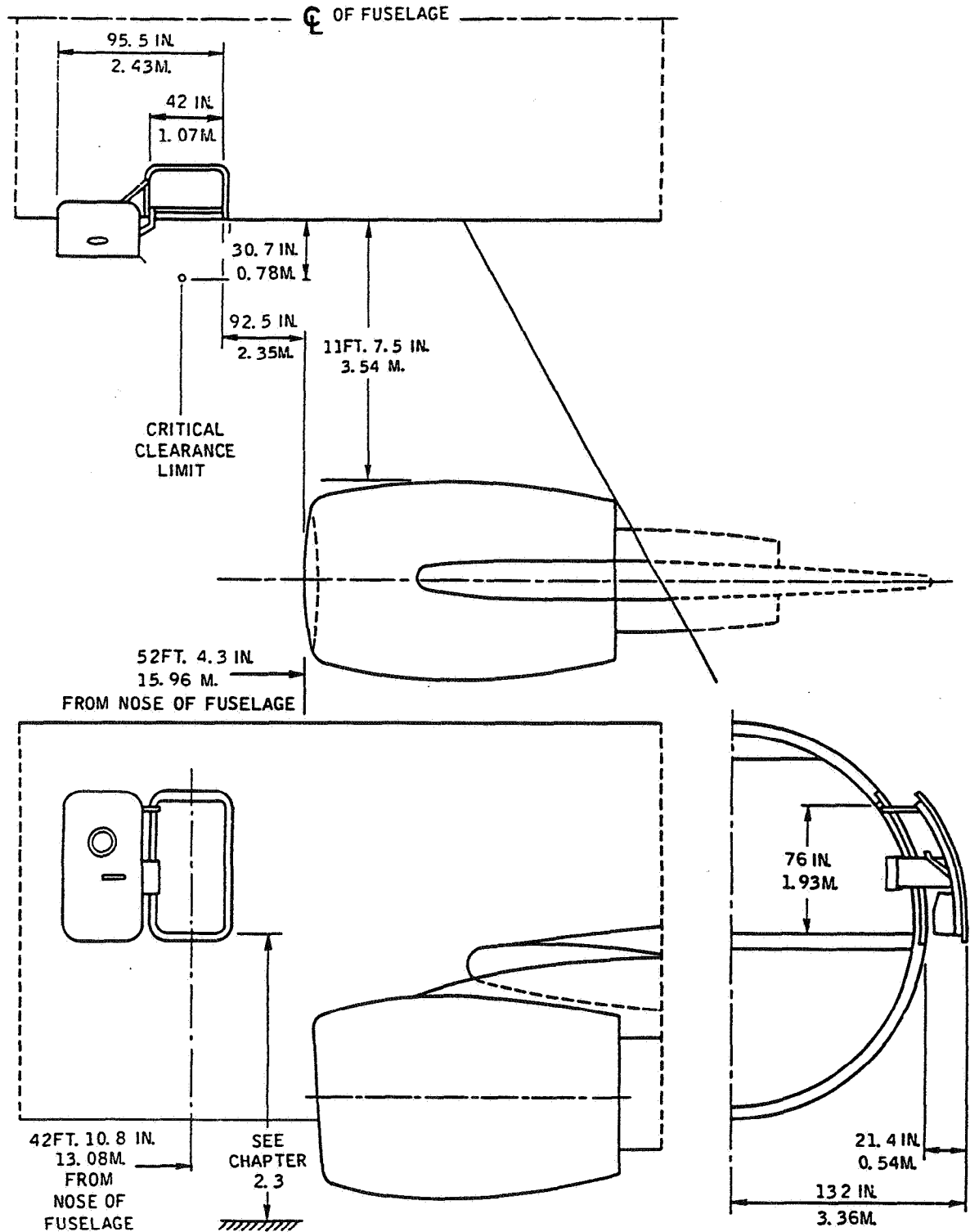

AA 5 02 08 02 0 AB 0

2.8 DOOR CLEARANCES
2.8.2 MIDDLE PASSENGER DOOR
MODEL B2 - B4 - C4 P. & W. ENGINES

A 300
AIRPLANE CHARACTERISTICS

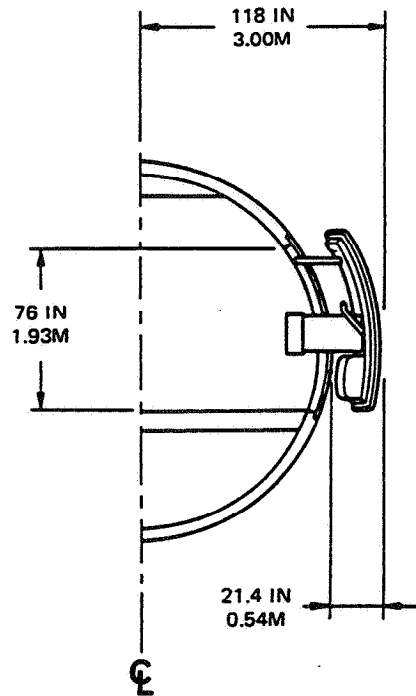
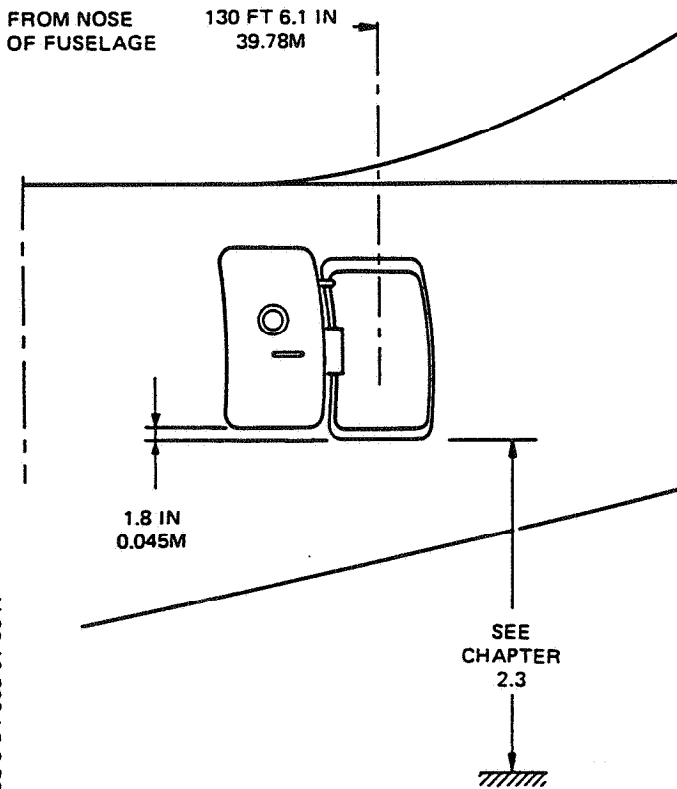
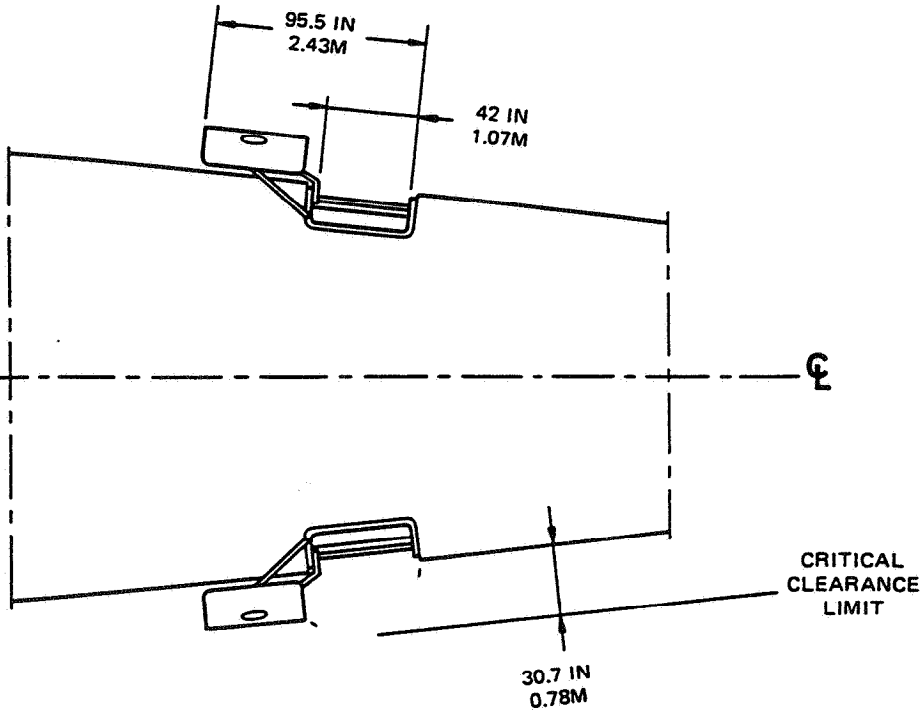

A 2301 11 000 CM 0
A 525 B P003 01 00 A

2.8 DOOR CLEARANCES
2.8.3 AFT PASSENGER DOOR
MODEL B2 - B4 - C4

A 300

AIRPLANE CHARACTERISTICS

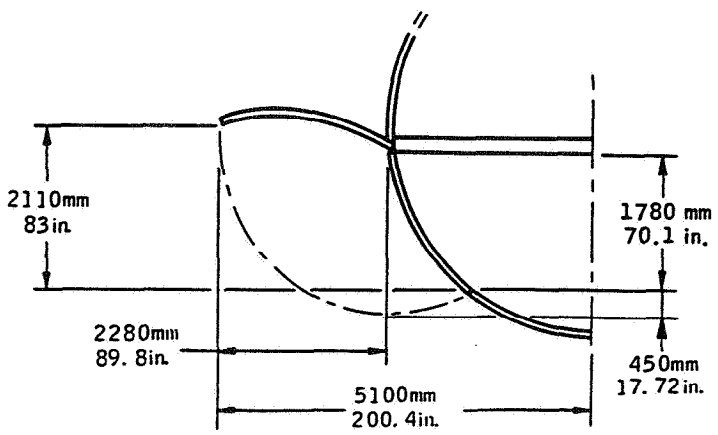
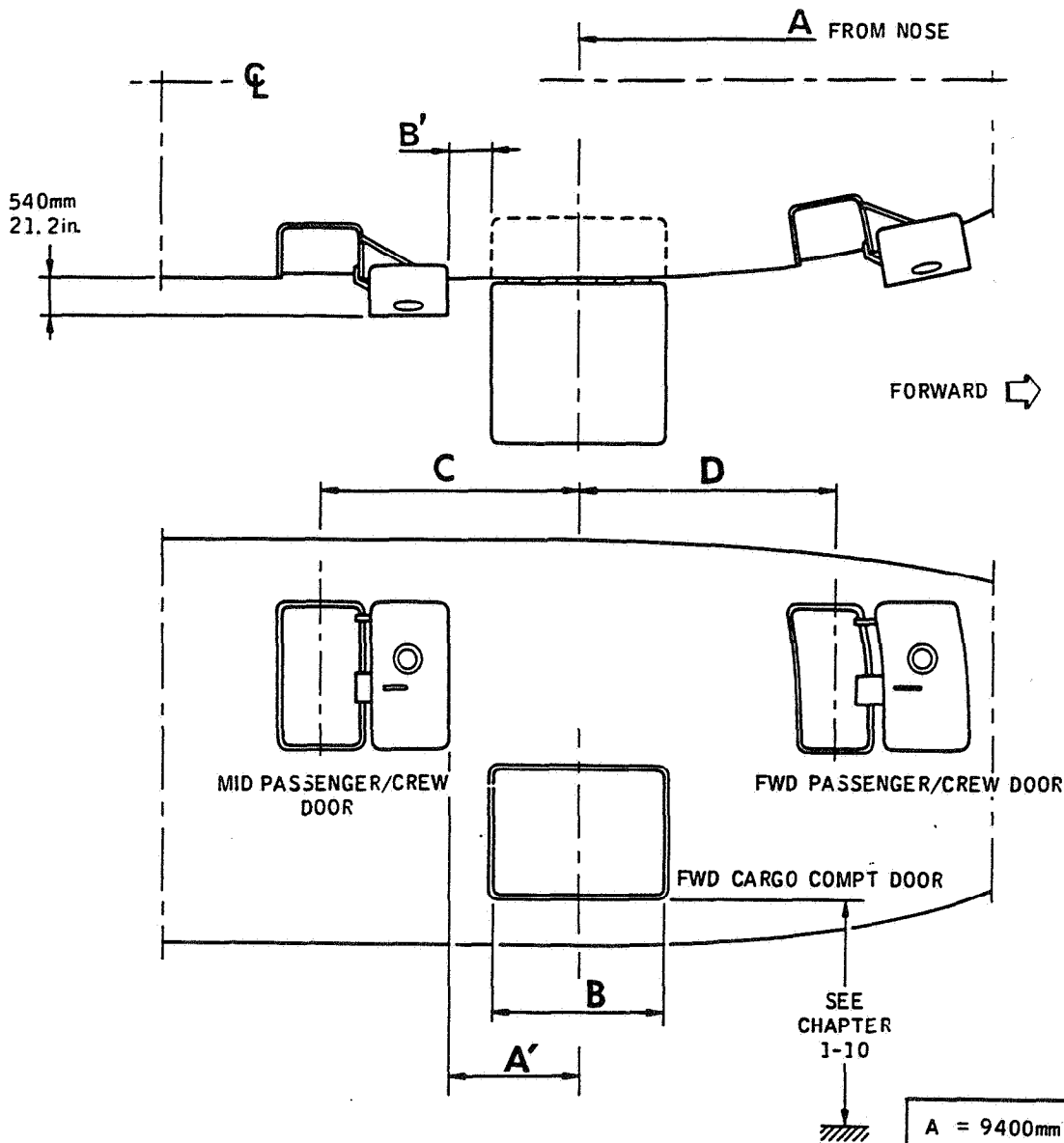

A = 9400mm (370in.)
A' = 1830mm (72in.)
B = 2430mm (96in.)
B' = 610mm (24in.)
C = 3680mm (145in.)
D = 3600mm (142in.)
AFTER MOD. 2295
A = 9533mm (375in.)
A' = 1697mm (67in.)
B = 2701mm (106in.)
B' = 345mm (13.6in.)
C = 3547mm (140in.)
D = 3467mm (135in.)

2.8 DOOR CLEARANCES
 2.8.4 FORWARD CARGO COMPARTMENT DOOR
 MODEL B2 - B4 - C4

Printed in France

AZ5 01 11 00 0 DMO

A 300
AIRPLANE CHARACTERISTICS

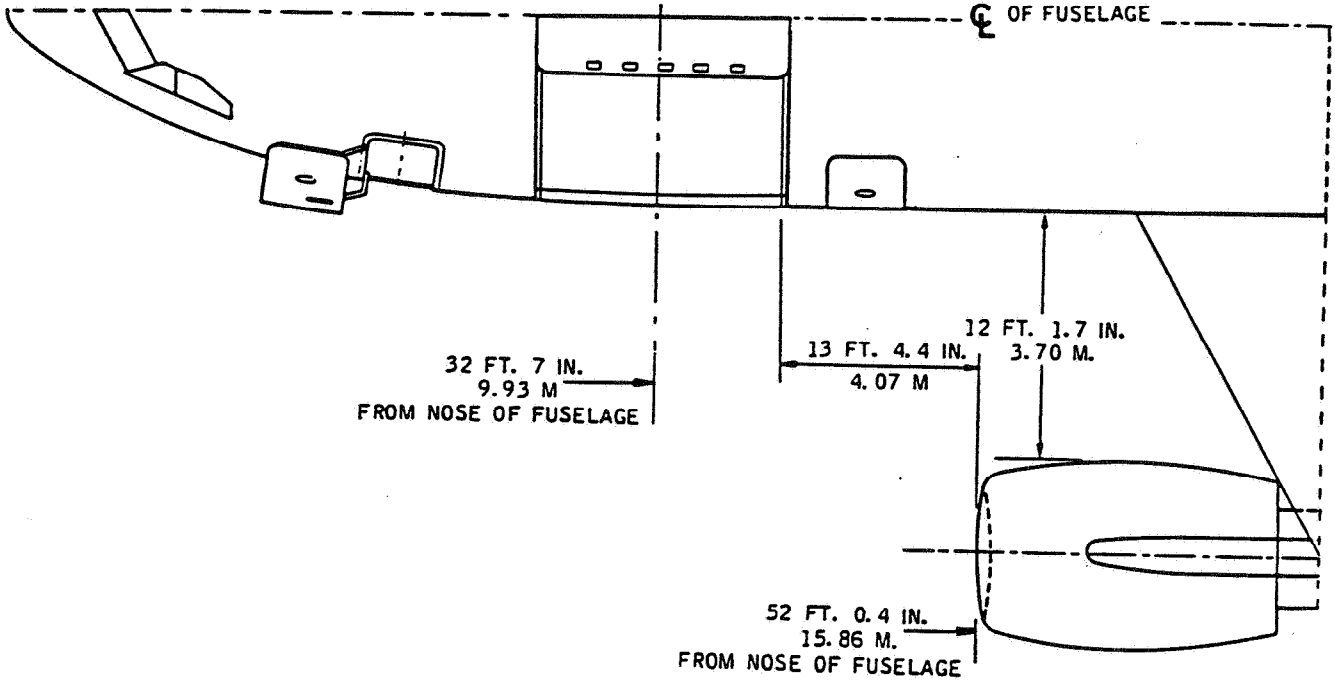

Printed in France

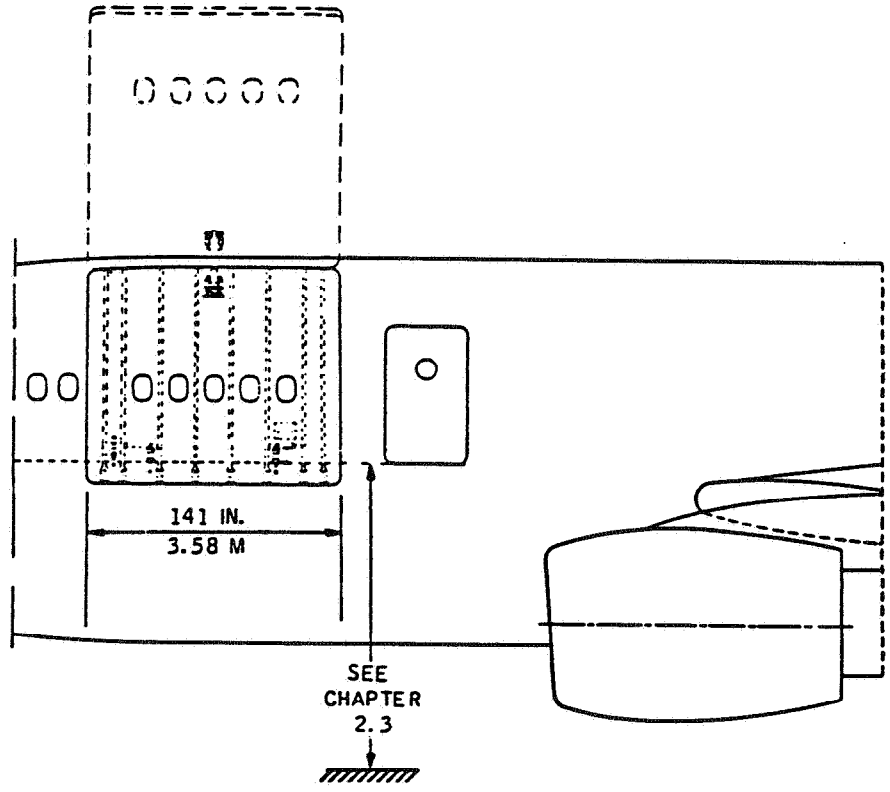
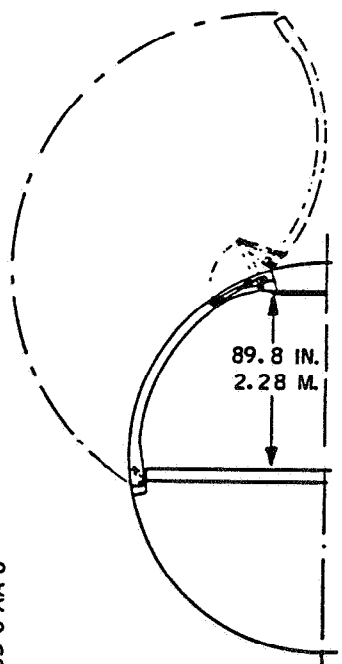

AA 5 02 08 05 0 AA 0

2.8. DOOR CLEARANCES
2.8.5 UPPER DECK CARGO DOOR
MODEL C4 G. E. ENGINES

A 300
AIRPLANE CHARACTERISTICS

Printed in France

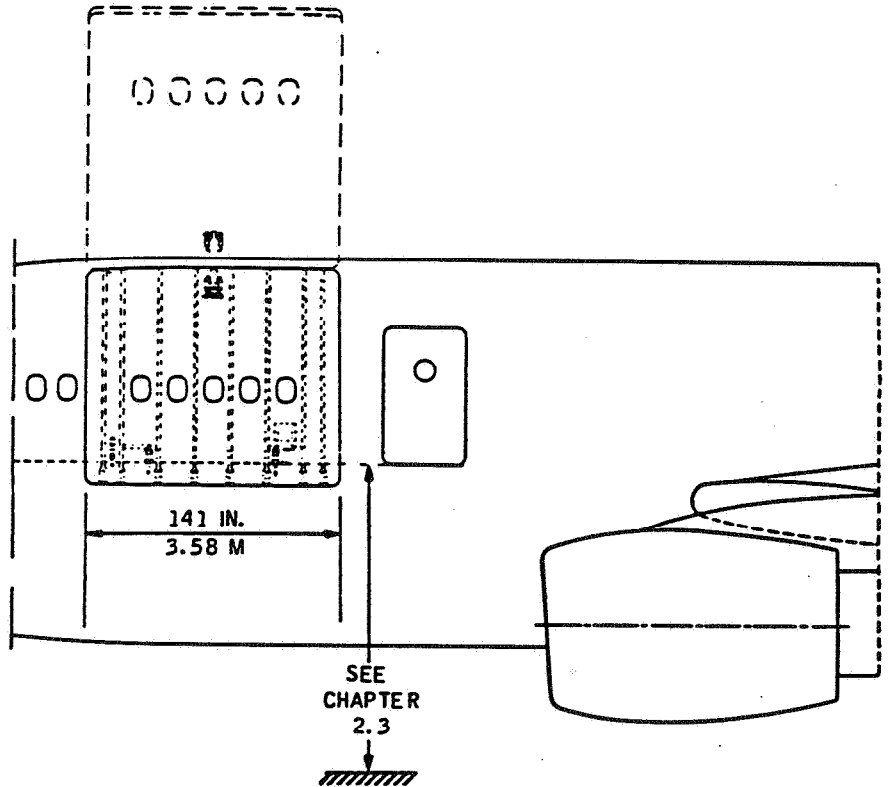
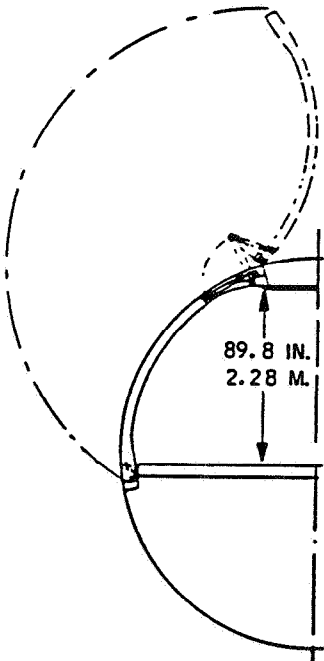
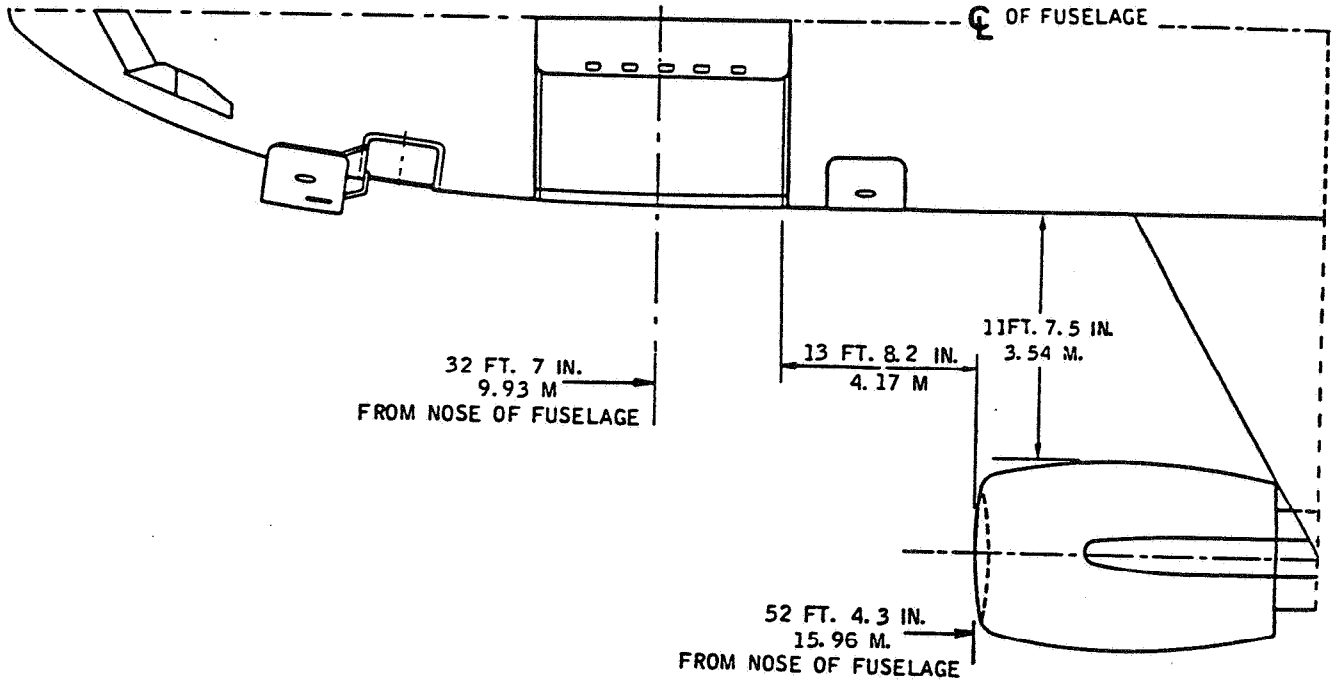

AA 5 02 08 05 0 AB 0

2.8. DOOR CLEARANCES
2.8.5 UPPER DECK CARGO DOOR
MODEL C4 P. & W. ENGINES

A 300
AIRPLANE CHARACTERISTICS

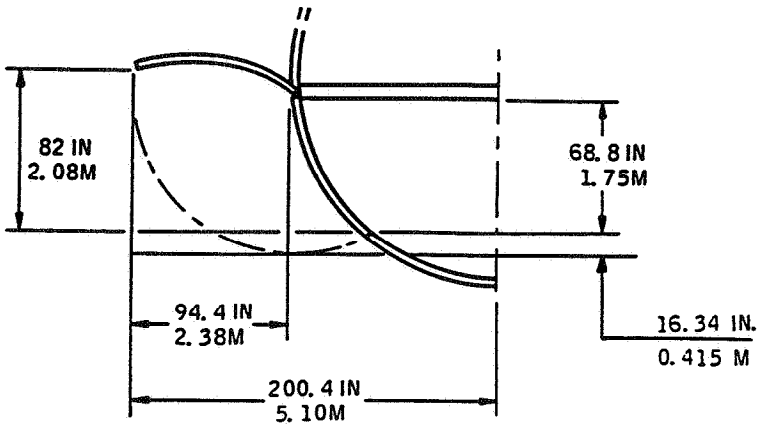
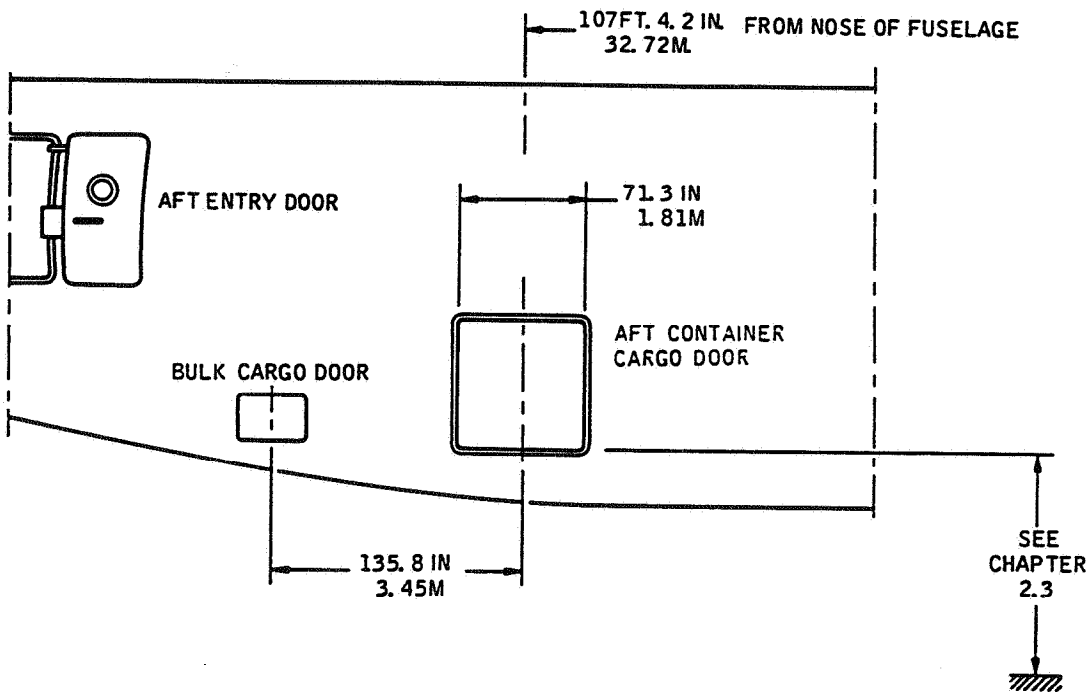
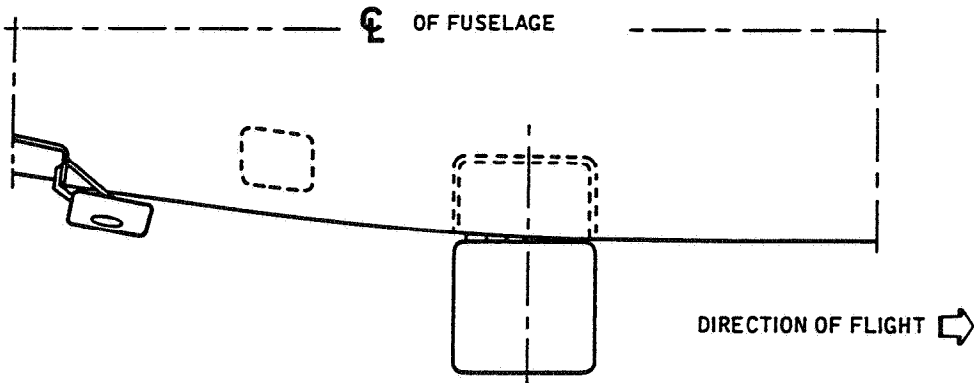

2.8 DOOR CLEARANCES
2.8.6 AFT CARGO COMPARTMENT DOOR
MODEL B2 - B4 - C4

AA 5 02 08 06 0 AA 0

Printed in France

A 300
AIRPLANE CHARACTERISTICS

Printed in France

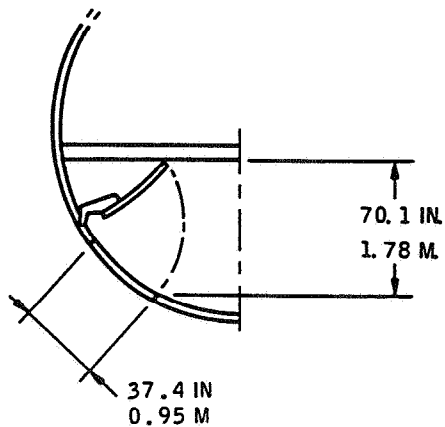
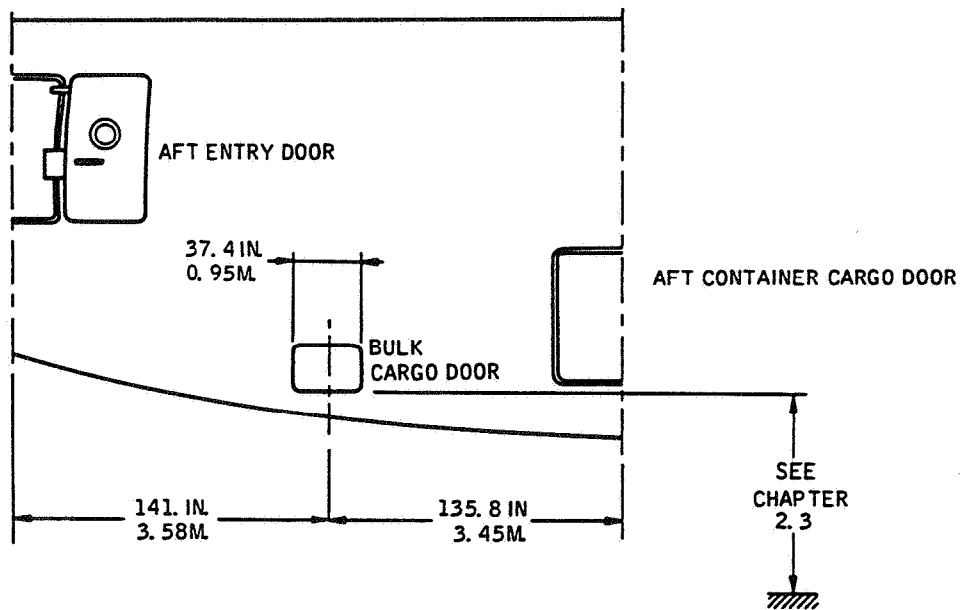
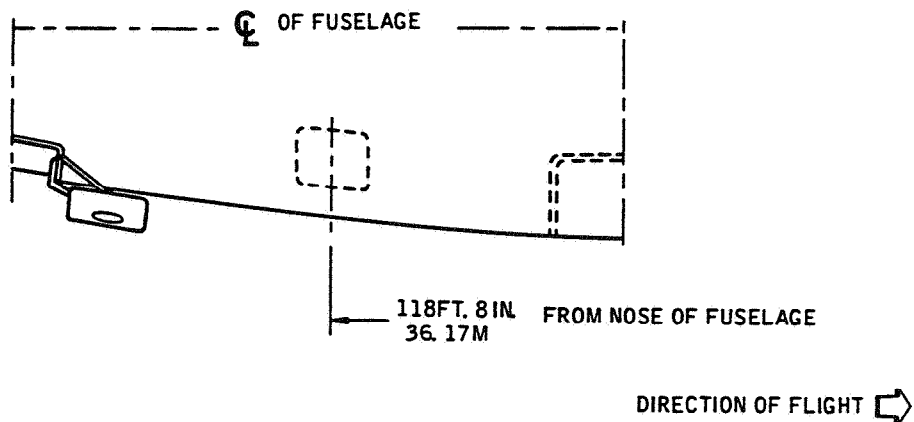

AA 5 02 08 07 0 AA 0

2.8 DOOR CLEARANCES
2.8.7 BULK CARGO COMPARTMENT DOOR
MODEL B2 - B4 - C4

A300
AIRPLANE CHARACTERISTICS

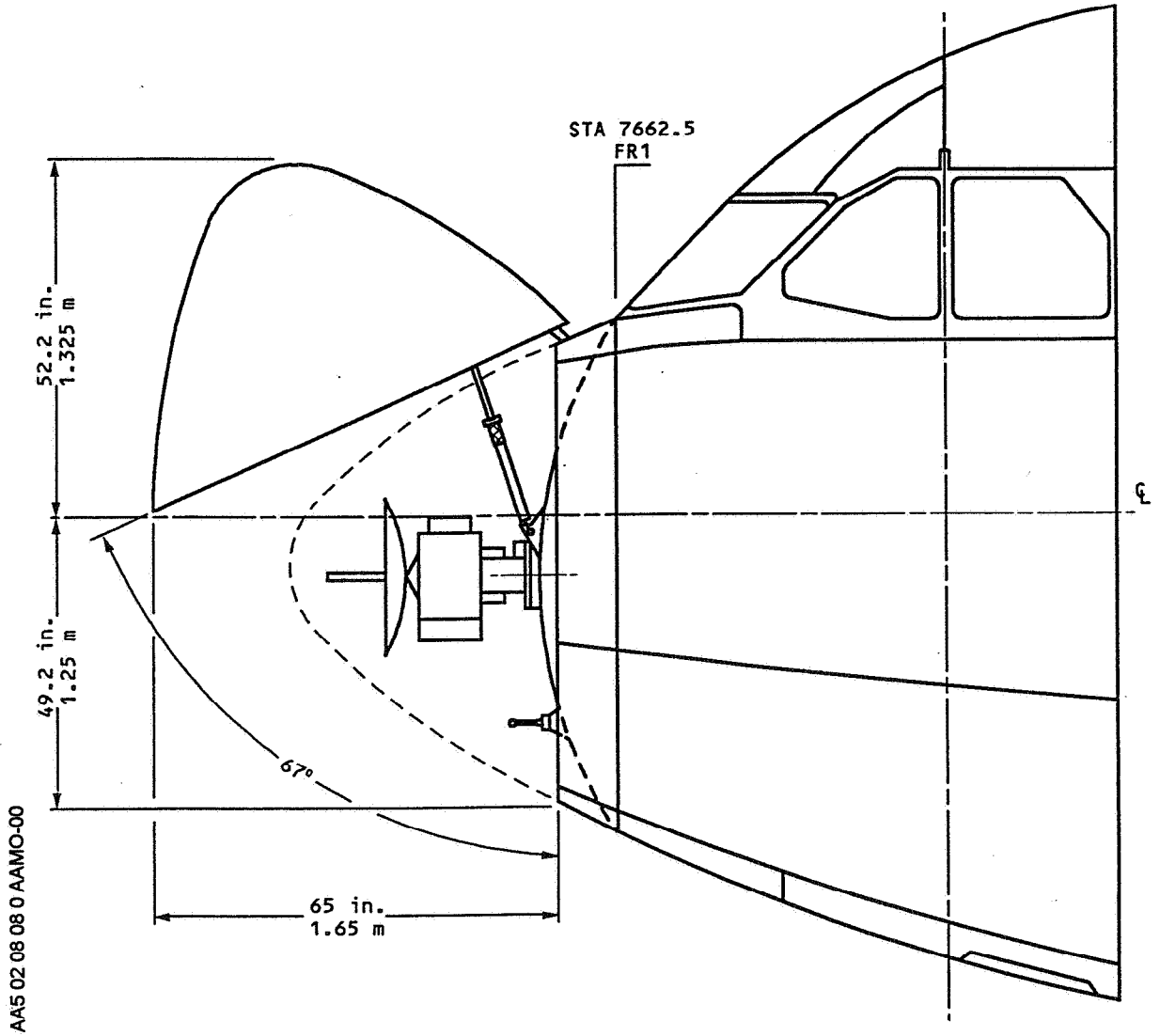

2.8 DOOR CLEARANCES
2.8.8 RADOME TRAVEL

A300

AIRPLANE CHARACTERISTICS

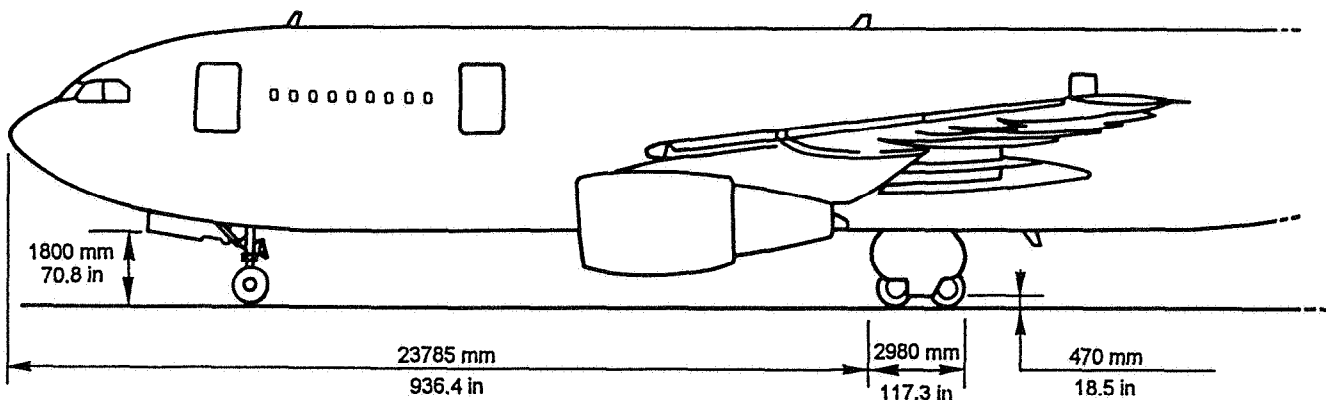

AIRCRAFT

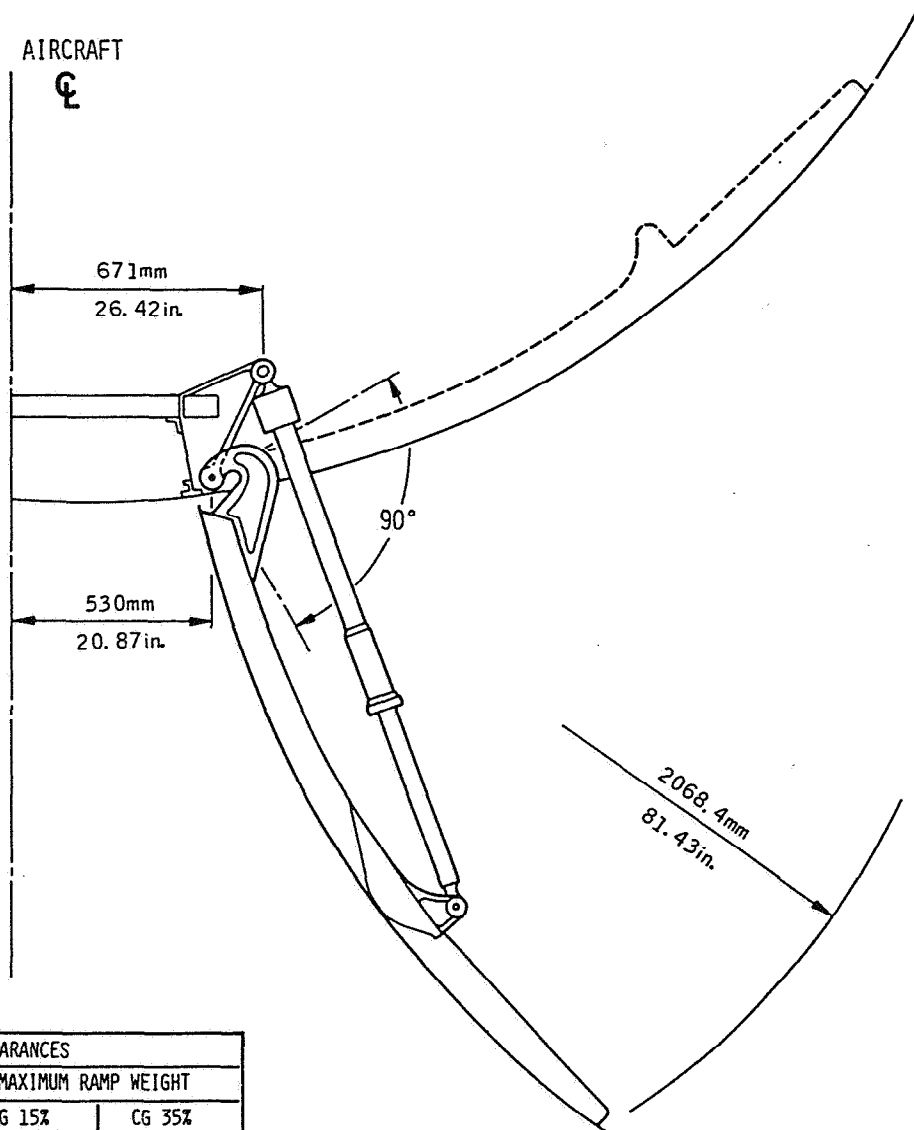

AA5 02 08 09 0 AAMO-00

VERTICAL CLEARANCES						
OPERATING WEIGHT EMPTY			MAXIMUM RAMP WEIGHT			
CG 24%			CG 15%		CG 35%	
	in.	mm	in.	mm	in.	mm
	24.53	623	21.85	555	21.06	535

2.8 DOOR CLEARANCES

2.8.9 MAIN LANDING GEAR DOOR

 **A300**
AIRPLANE CHARACTERISTICS

THIS PAGE LEFT BLANK INTENTIONALLY

A 300

AIRPLANE CHARACTERISTICS

- 3.0 AIRPLANE PERFORMANCE
 - 3.1 General information
 - 3.2 Payload range
 - 3.2.1 Long range and recommended cruise (U.S. units)
 - 3.2.2 Long range and recommended cruise (Metric units)
 - 3.3 FAR takeoff runway length requirements
 - 3.3.1 ISA conditions - Alternate (U.S. units)
 - 3.3.2 ISA conditions - Alternate (Metric units)
 - 3.3.3 ISA conditions +59°F (+15°C) - Alternate (U.S. units)
 - 3.3.4 ISA conditions +59°F (+15°C) - Alternate (Metric units)
 - 3.4 FAR landing runway requirements
 - 3.4.1 Full flaps (U.S. units)
 - 3.4.2 Full flaps (Metric units)
 - 3.4.3 Full flaps
 - 3.5 Landing approach speed
 - 3.5.1 Landing approach speed (Metric units)
 - 3.5.2 Landing approach speed (U.S. units)

A 300
AIRPLANE CHARACTERISTICS

3.0 AIRPLANE PERFORMANCE

3.1 General Information

Section 3.2 indicates payload range information at specific altitudes for recommended and long range cruise with a given fuel reserve condition.

Section 3.3 represents FAR Takeoff runway length requirements at ISA and ISA + 59°F (+ 15°C) conditions for FAA certification.

Section 3.4 represents FAR landing runway length requirements for FAA certification.

Section 3.5 indicates landing approach speeds.

Standard day temperatures for the altitudes shown are tabulated below :

Altitude		Standard Day Temperature	
FEET	METERS	°F	°C
0	0	59	15.
2000	610	51.9	11.6
4000	1220	44.7	7.1
6000	1830	37.6	3.1
8000	2440	30.5	-0.8

Printed in France

A 300

AIRPLANE CHARACTERISTICS

Printed in France

NOTE : THESE CURVES ARE GIVEN FOR INFORMATION ONLY.
THE APPROVED VALUES ARE STATED IN THE "OPERATING
MANUALS" SPECIFIC TO THE AIRLINE OPERATING THE AIRCRAFT.

AA 5 03 02 01 0 AA 0

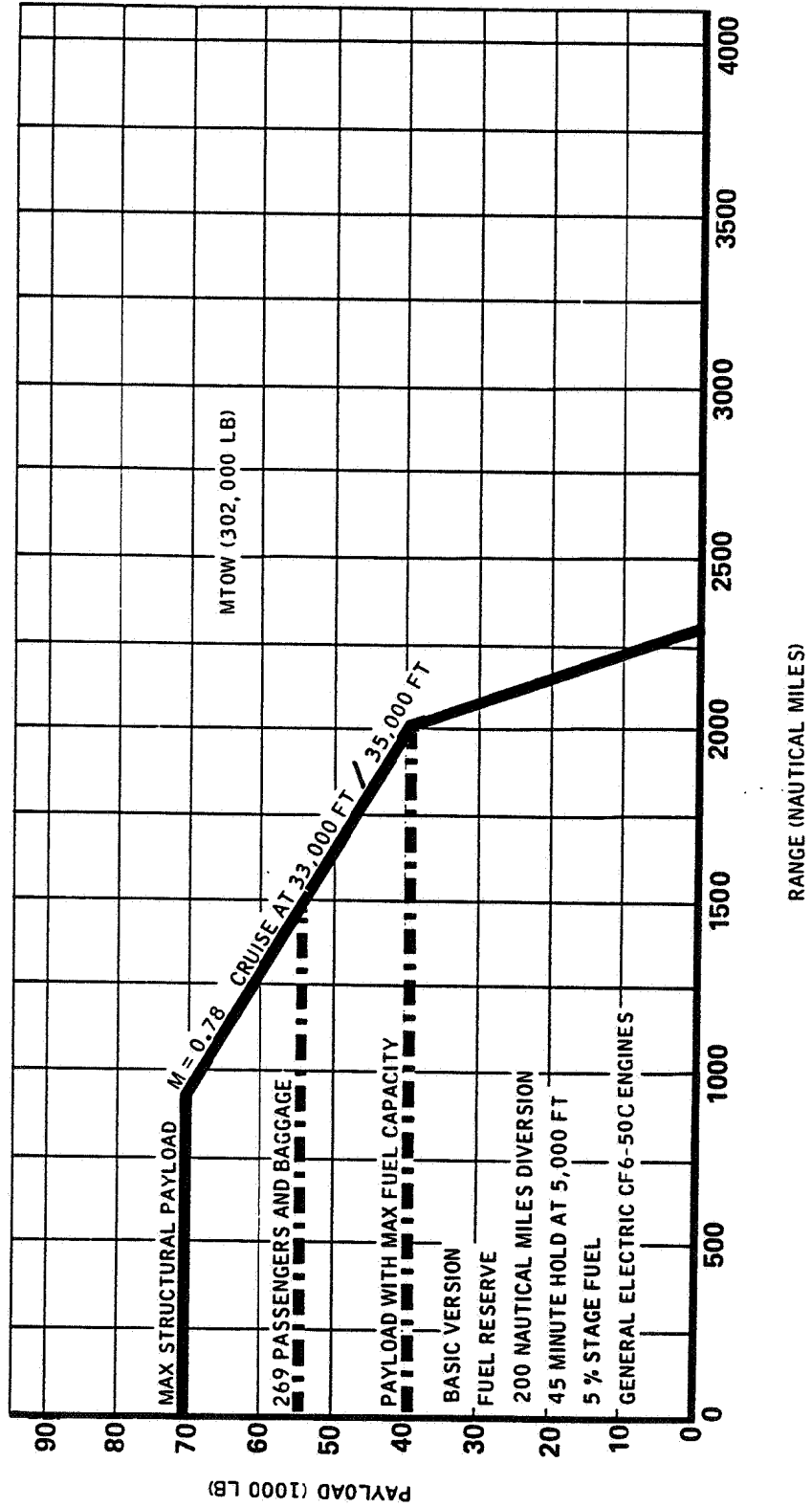

3.2 PAYLOAD RANGE
3.2.1 LONG RANGE AND RECOMMENDED CRUISE (U.S. UNITS)
MODEL B2-101

A 300
AIRPLANE CHARACTERISTICS

NOTE : THESE CURVES ARE GIVEN FOR INFORMATION ONLY.
THE APPROVED VALUES ARE STATED IN THE "OPERATING
MANUALS" SPECIFIC TO THE AIRLINE OPERATING THE AIRCRAFT.

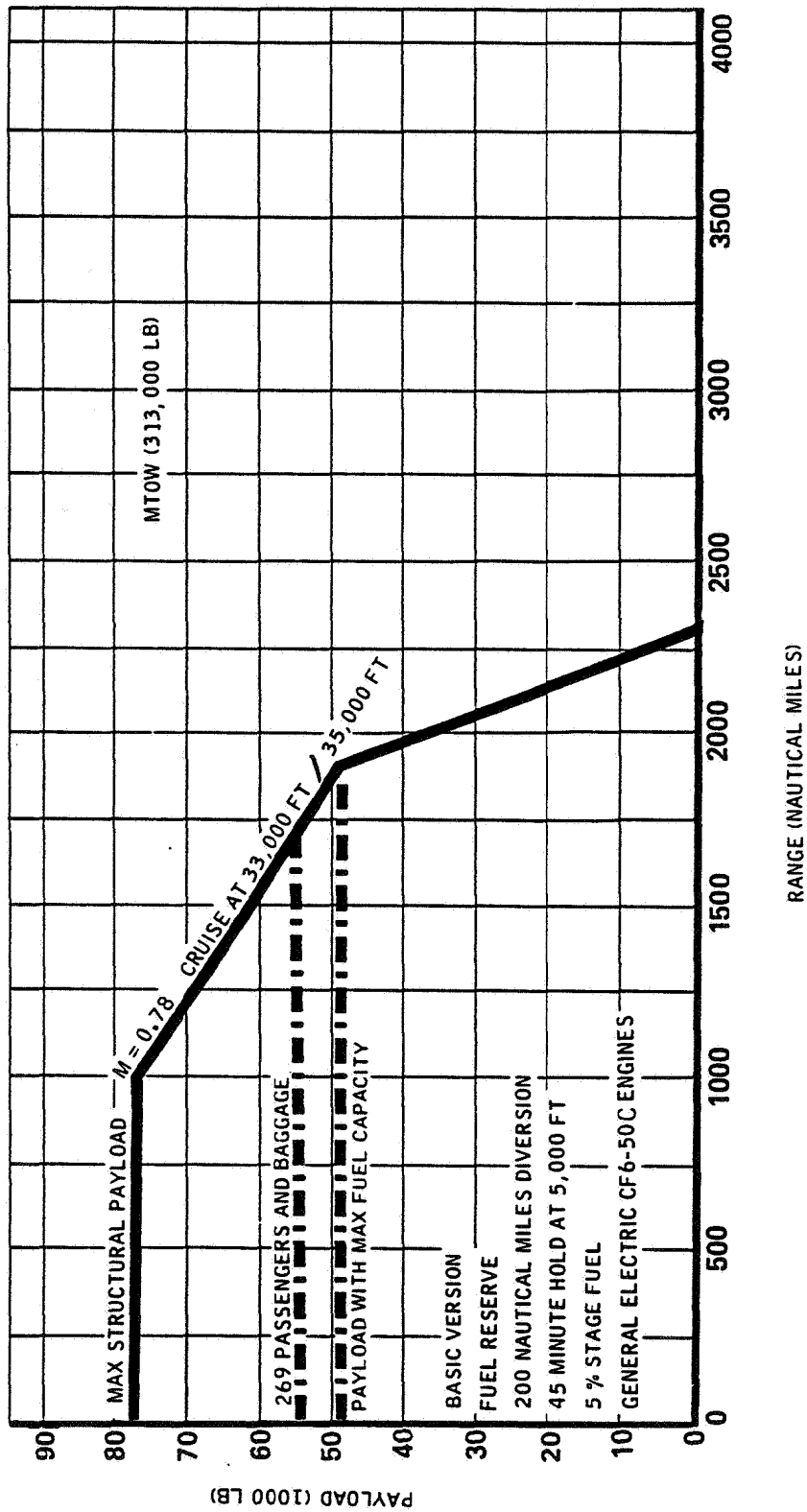

A A 5 03 02 01 0 AB 0

3.2 PAYLOAD RANGE
3.2.1 LONG RANGE AND RECOMMENDED CRUISE (U.S. UNITS)
MODEL B2-201/202

A 300

AIRPLANE CHARACTERISTICS

Printed in France

NOTE : THESE CURVES ARE GIVEN FOR INFORMATION ONLY.
THE APPROVED VALUES ARE STATED IN THE "OPERATING
MANUALS" SPECIFIC TO THE AIRLINE OPERATING THE AIRCRAFT.

A A 5 03 02 01 0 AC 0

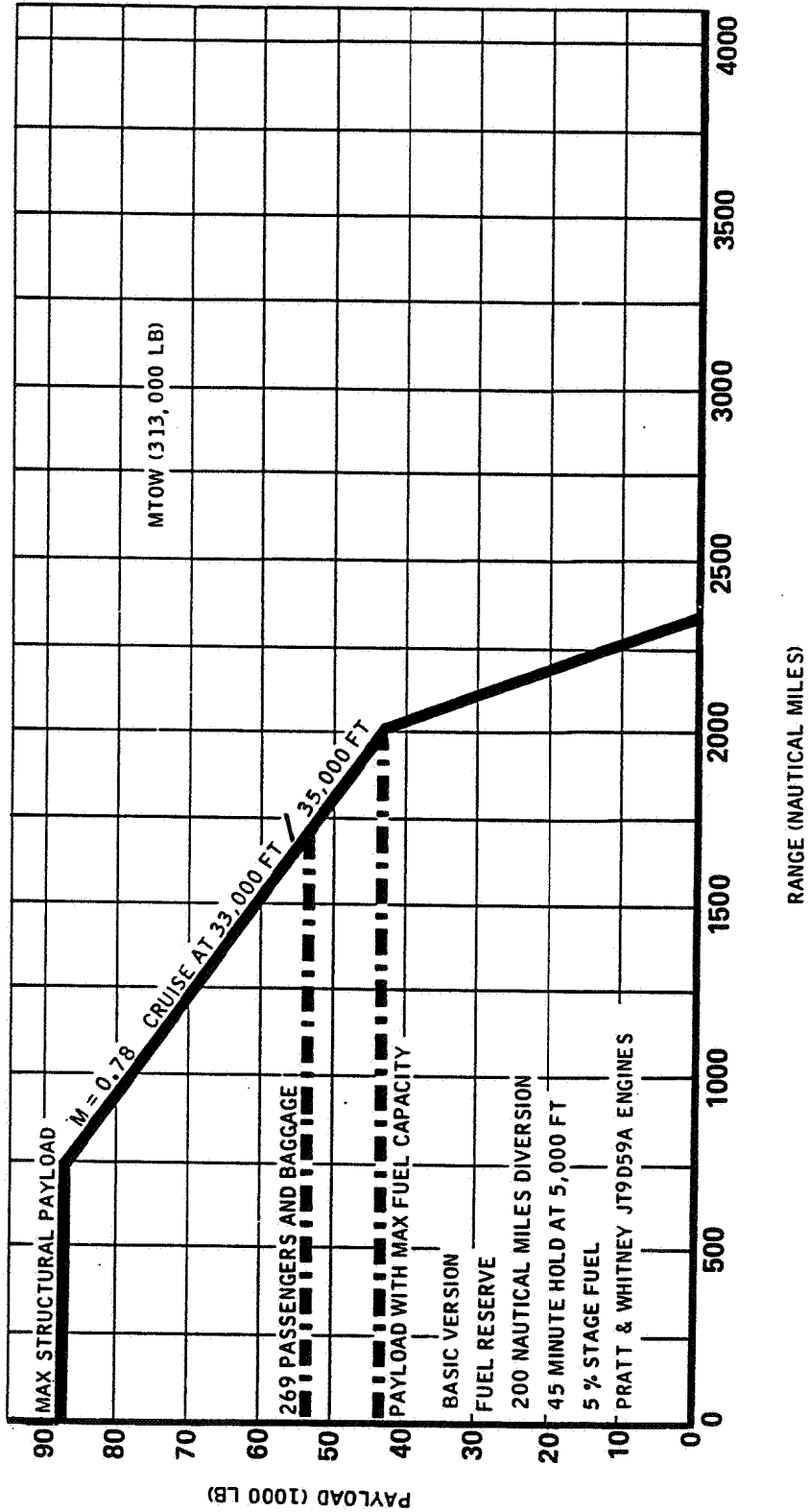

3.2 PAYLOAD RANGE

3.2.1 LONG RANGE AND RECOMMENDED CRUISE (U.S. UNITS)

MODEL B2-320

A 300

AIRPLANE CHARACTERISTICS

NOTE : THESE CURVES ARE GIVEN FOR INFORMATION ONLY.
THE APPROVED VALUES ARE STATED IN THE "OPERATING
MANUALS" SPECIFIC TO THE AIRLINE OPERATING THE AIRCRAFT.

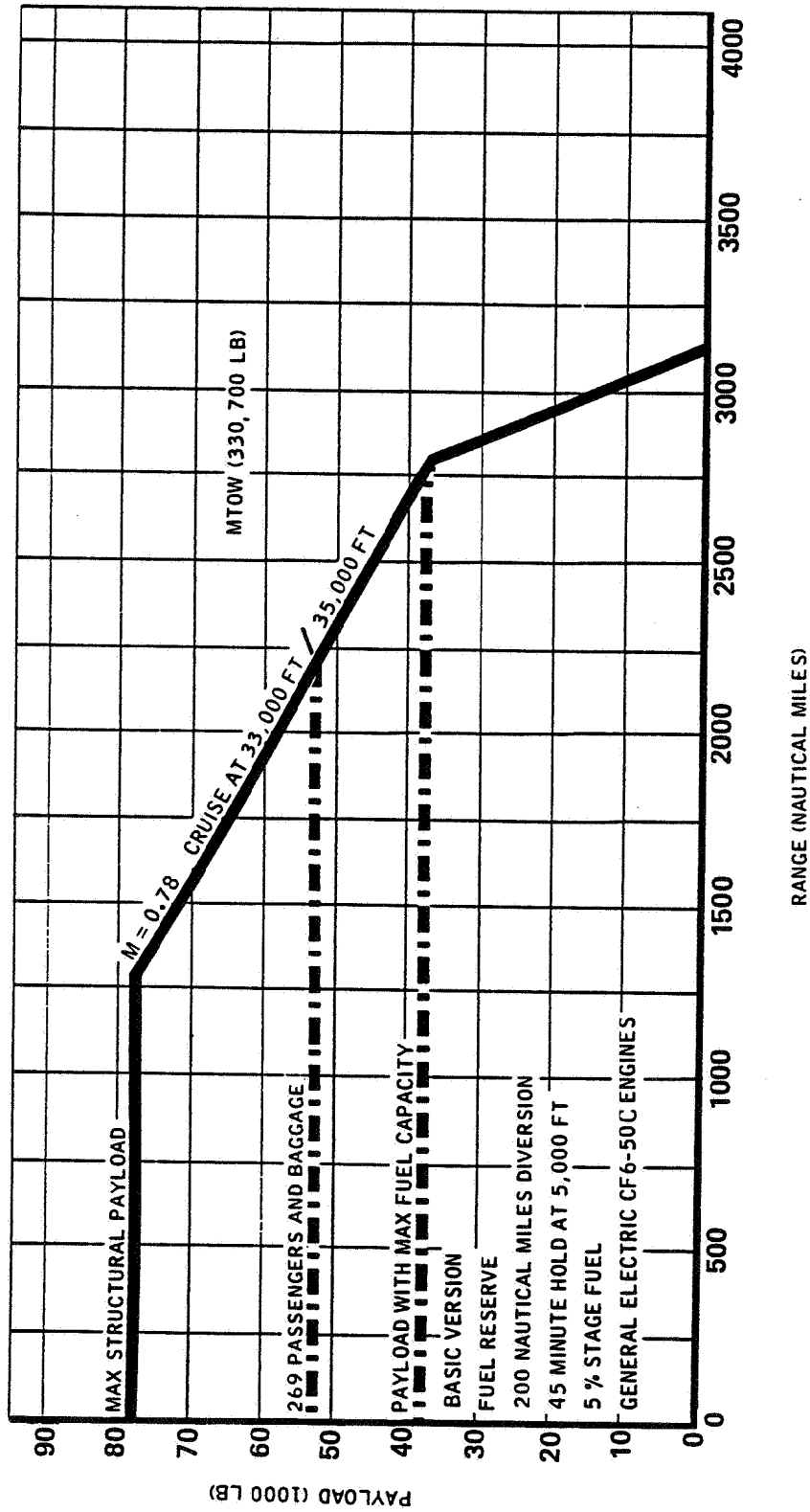

3.2 PAYLOAD RANGE

3.2.1 LONG RANGE AND RECOMMENDED CRUISE (U.S. UNITS)

MODEL B4-101

A 300

AIRPLANE CHARACTERISTICS

Printed in France

NOTE : THESE CURVES ARE GIVEN FOR INFORMATION ONLY.
THE APPROVED VALUES ARE STATED IN THE "OPERATING
MANUALS" SPECIFIC TO THE AIRLINE OPERATING THE AIRCRAFT.

AA 5 03 02 01 0 AE 0

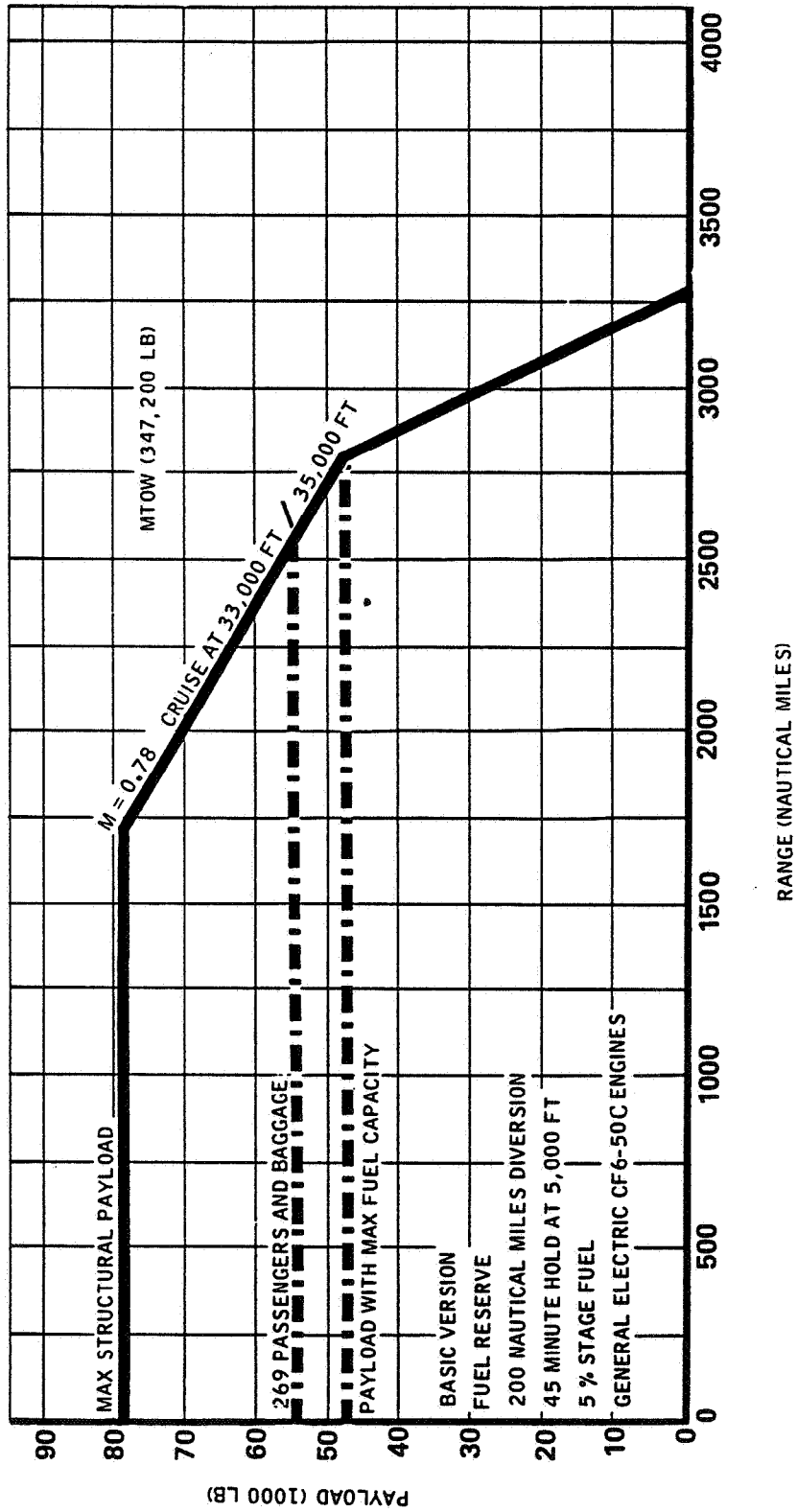

3.2 PAYLOAD RANGE
3.2.1 LONG RANGE AND RECOMMENDED CRUISE (U.S. UNITS)
MODEL B4-102

A 300

AIRPLANE CHARACTERISTICS

NOTE : THESE CURVES ARE GIVEN FOR INFORMATION ONLY.
THE APPROVED VALUES ARE STATED IN THE "OPERATING
MANUALS" SPECIFIC TO THE AIRLINE OPERATING THE AIRCRAFT.

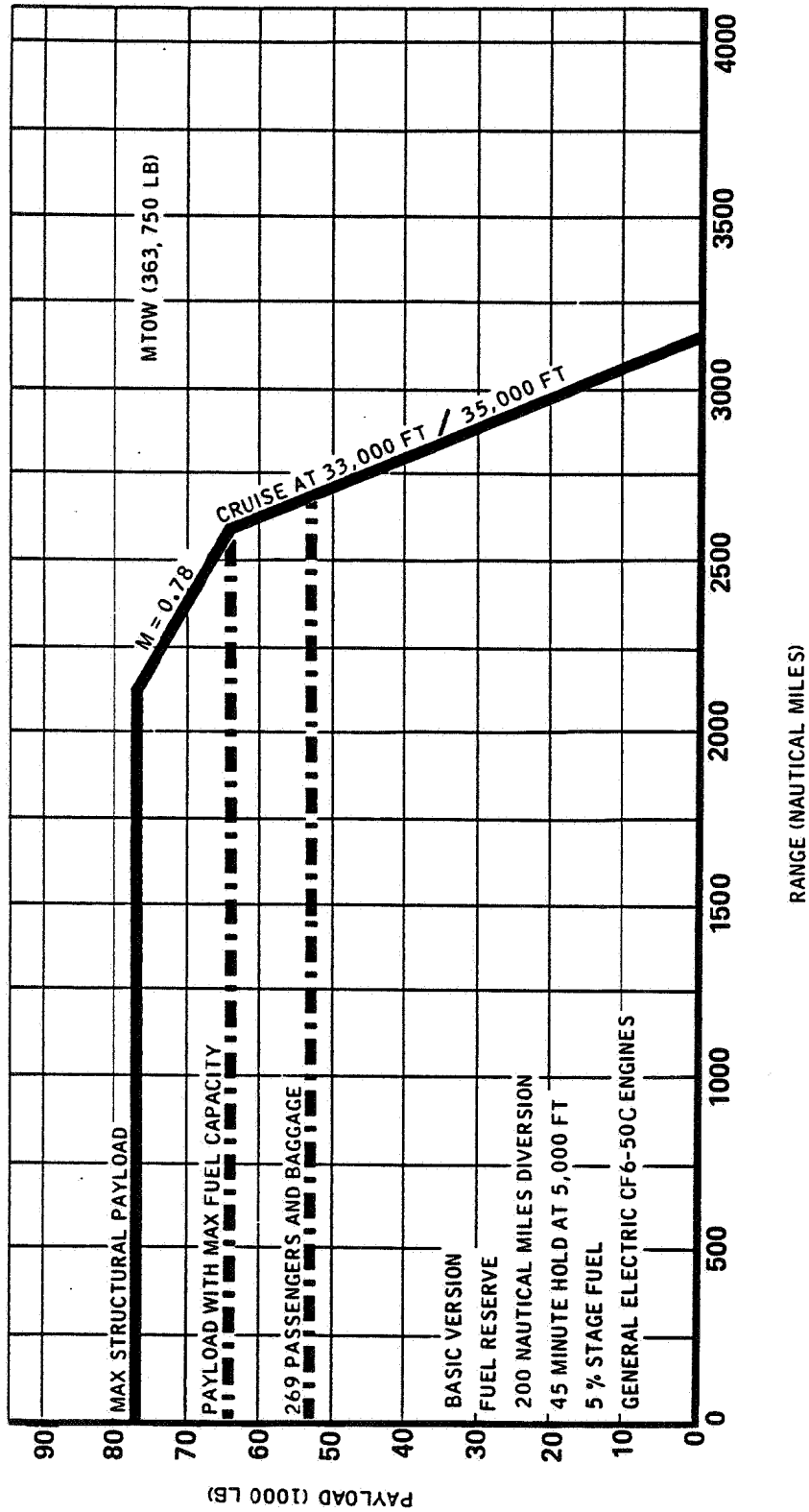

3.2 PAYLOAD RANGE

3.2.1 LONG RANGE AND RECOMMENDED CRUISE (U.S. UNITS)

MODEL B4-203

A 300
AIRPLANE CHARACTERISTICS

Printed in France

NOTE : THESE CURVES ARE GIVEN FOR INFORMATION ONLY.
THE APPROVED VALUES ARE STATED IN THE "OPERATING
MANUALS" SPECIFIC TO THE AIRLINE OPERATING THE AIRCRAFT.

A A 5 03 02 01 0 AG 0

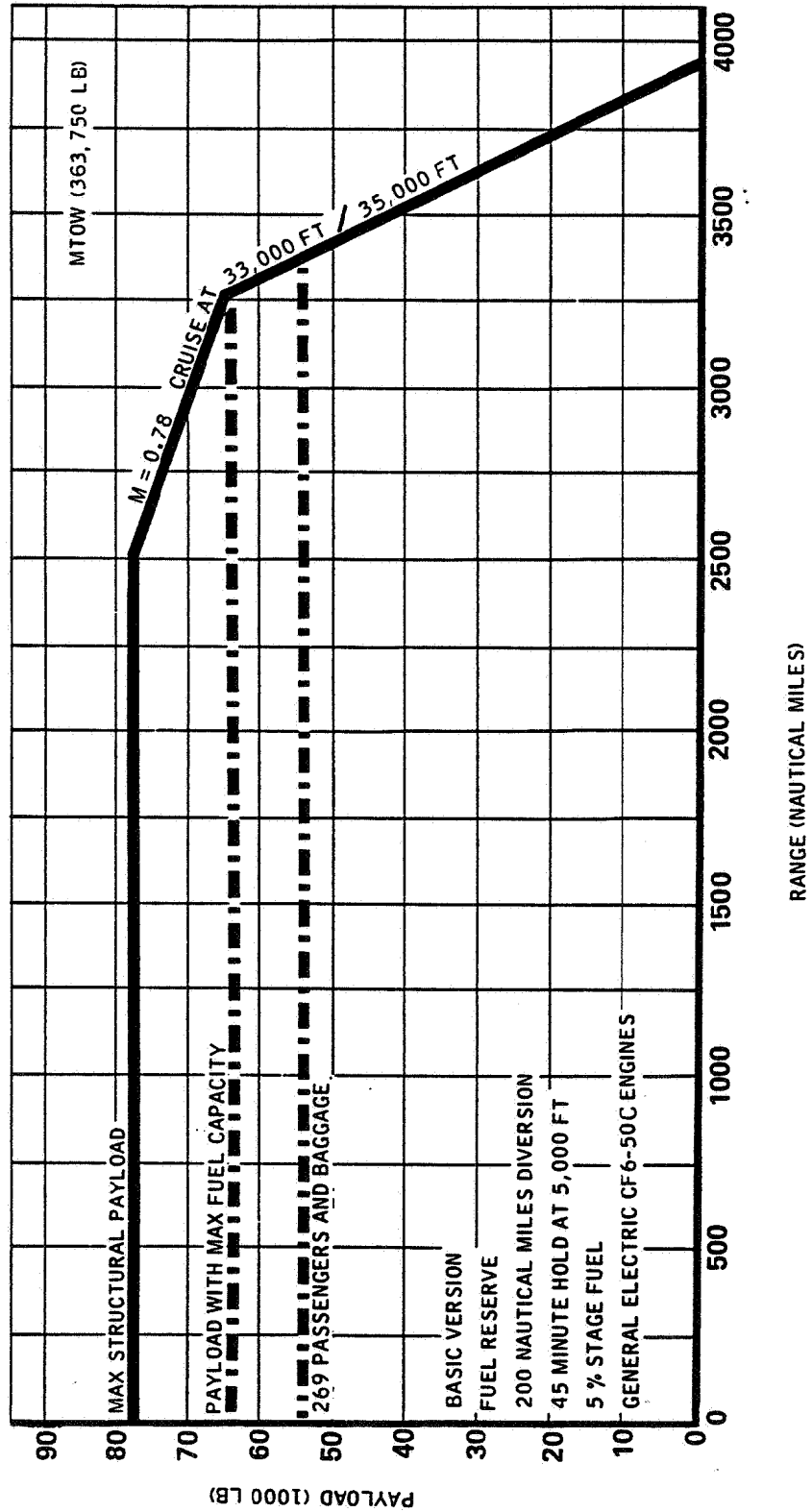

3.2 PAYLOAD RANGE
3.2.1 LONG RANGE AND RECOMMENDED CRUISE (U.S. UNITS)
MODEL C4-PASS

A 300
AIRPLANE CHARACTERISTICS

NOTE : THESE CURVES ARE GIVEN FOR INFORMATION ONLY.
THE APPROVED VALUES ARE STATED IN THE "OPERATING
MANUALS" SPECIFIC TO THE AIRLINE OPERATING THE AIRCRAFT.

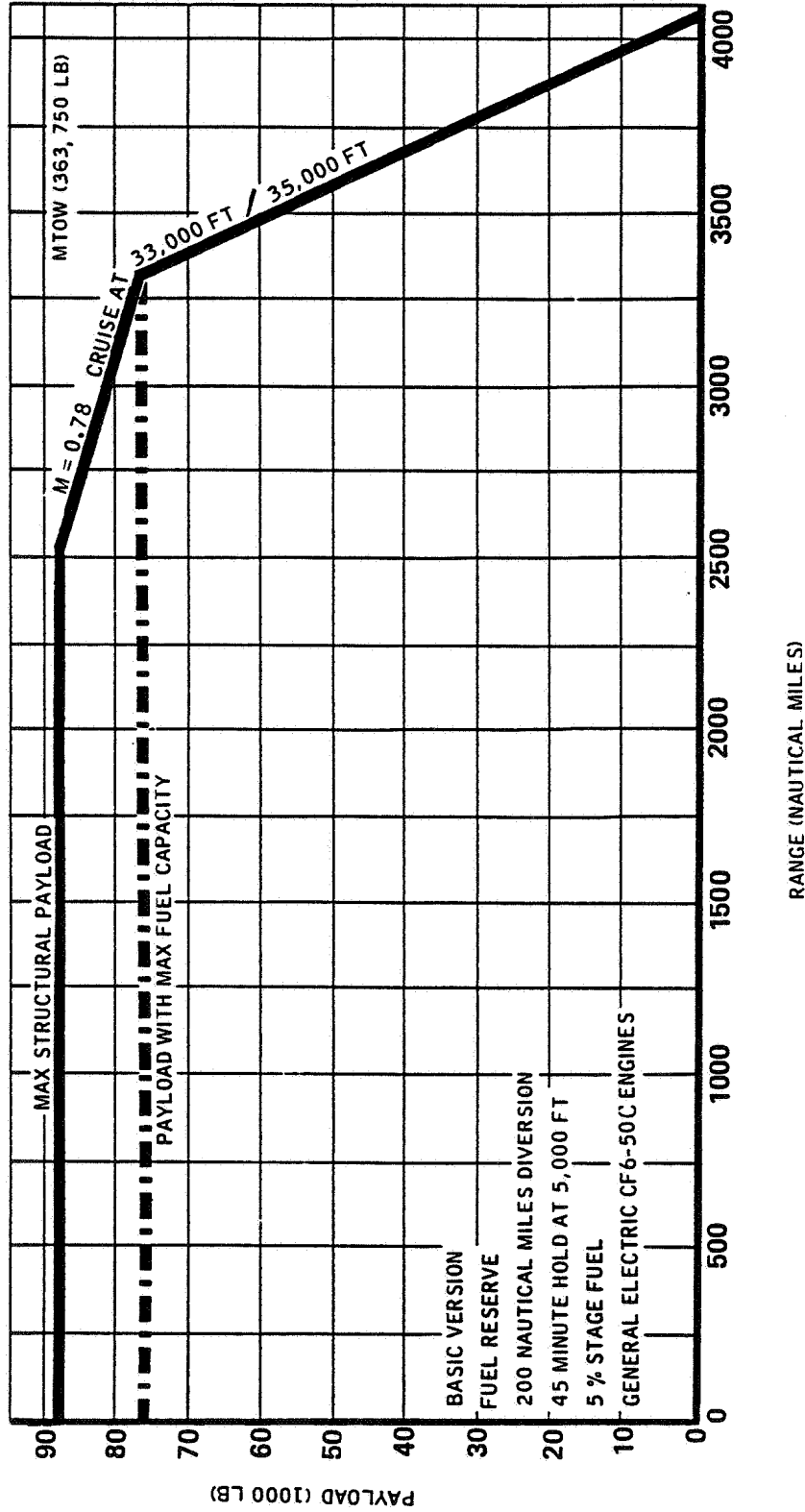

3.2 PAYLOAD RANGE
3.2.1 LONG RANGE AND RECOMMENDED CRUISE (U.S. UNITS)
MODEL C4-FREIGHT

AA 5 03 02 01 0 AH 0

A 300

AIRPLANE CHARACTERISTICS

Printed in France

AA 5 03 02 02 0 AA 0

NOTE : THESE CURVES ARE GIVEN FOR INFORMATION ONLY.
THE APPROVED VALUES ARE STATED IN THE "OPERATING
MANUALS" SPECIFIC TO THE AIRLINE OPERATING THE AIRCRAFT.

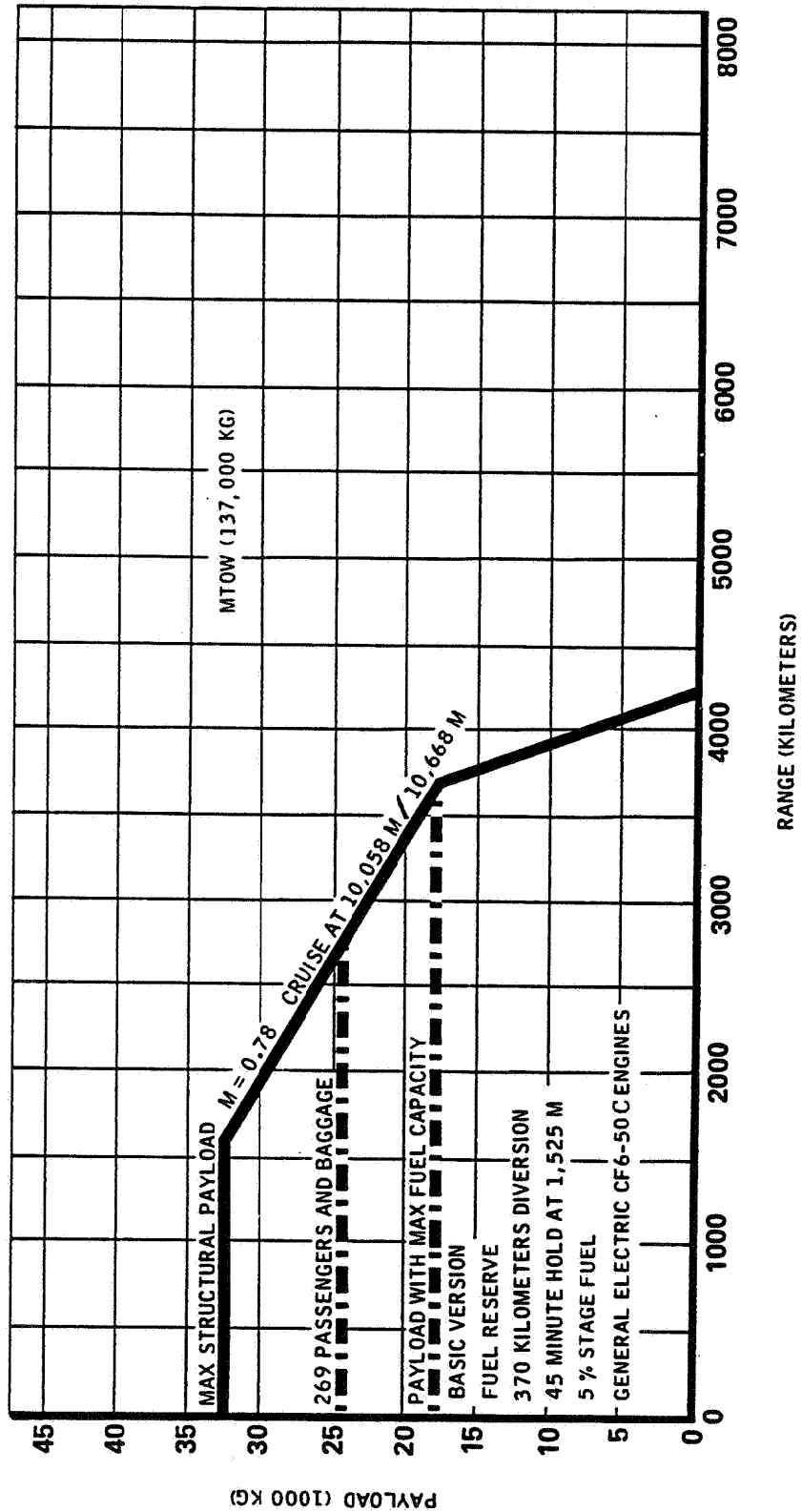

3.2 PAYLOAD RANGE
3.2.2 LONG RANGE AND RECOMMENDED CRUISE (METRIC UNITS)
MODEL B2-101

A 300

AIRPLANE CHARACTERISTICS

NOTE : THESE CURVES ARE GIVEN FOR INFORMATION ONLY.
THE APPROVED VALUES ARE STATED IN THE "OPERATING
MANUALS" SPECIFIC TO THE AIRLINE OPERATING THE AIRCRAFT.

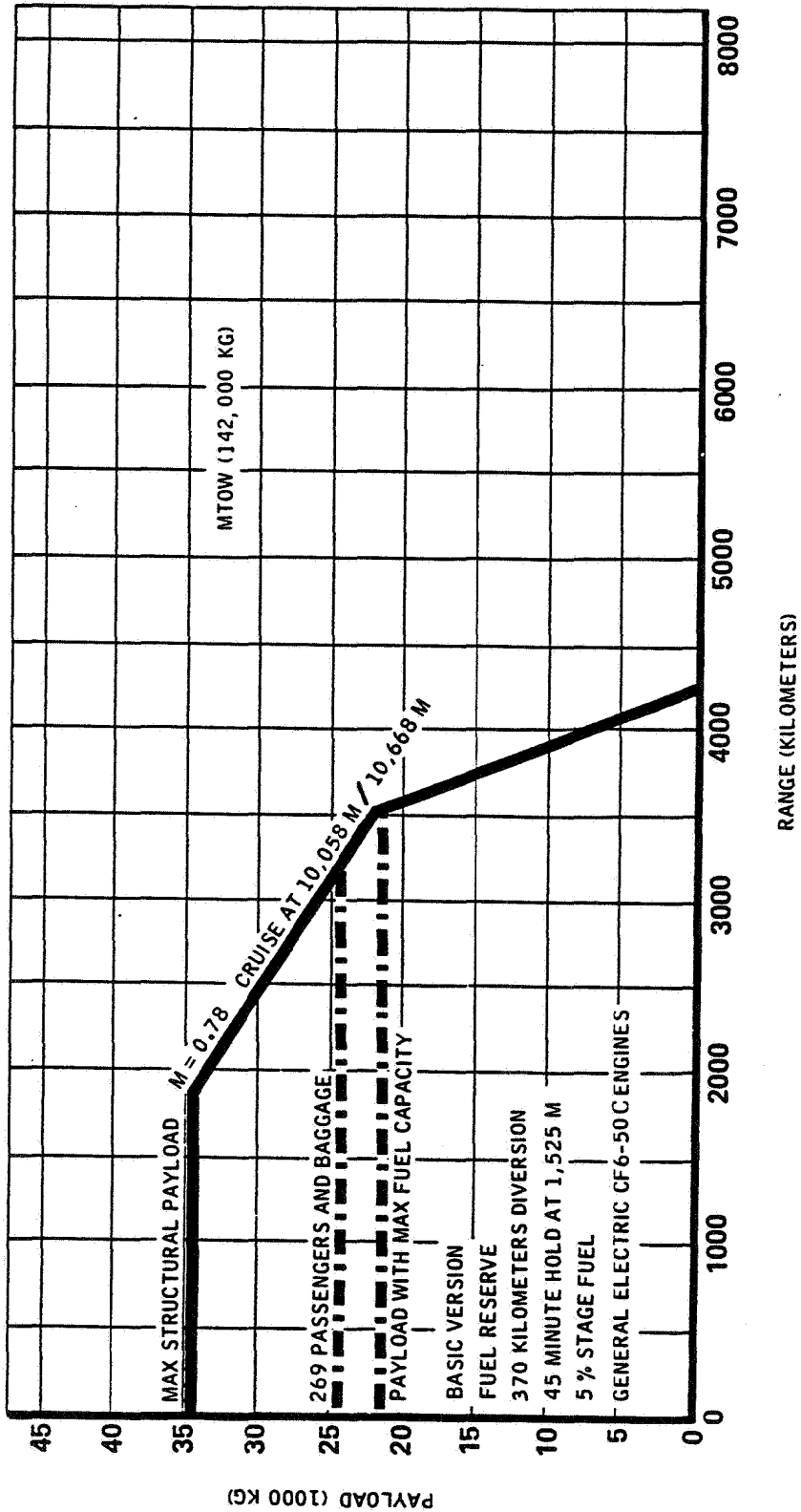

Printed in France

A A 5 03 02 02 0 AB 0

3.2 PAYLOAD RANGE

3.2.2 LONG RANGE AND RECOMMENDED CRUISE (METRIC UNITS)

MODEL B2-201/202

A 300

AIRPLANE CHARACTERISTICS

Printed in France

NOTE : THESE CURVES ARE GIVEN FOR INFORMATION ONLY.
THE APPROVED VALUES ARE STATED IN THE "OPERATING
MANUALS" SPECIFIC TO THE AIRLINE OPERATING THE AIRCRAFT.

A A 5 03 02 02 0 AC 0

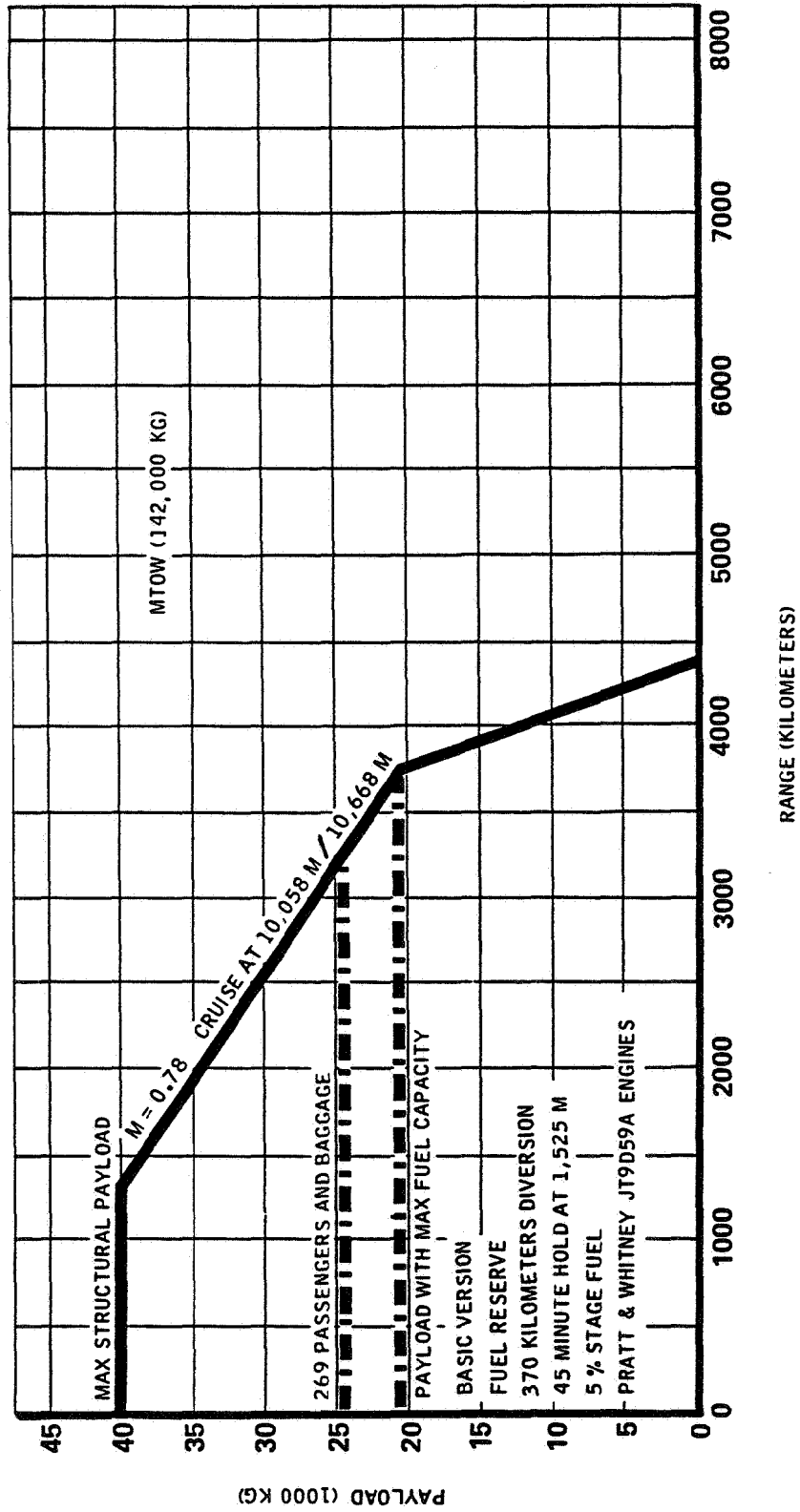

3.2 PAYLOAD RANGE

3.2.2 LONG RANGE AND RECOMMENDED CRUISE (METRIC UNITS)

MODEL B2-320

A 300

AIRPLANE CHARACTERISTICS

AA 5 03 02 02 0 AD 0

NOTE : THESE CURVES ARE GIVEN FOR INFORMATION ONLY.
THE APPROVED VALUES ARE STATED IN THE "OPERATING
MANUALS" SPECIFIC TO THE AIRLINE OPERATING THE AIRCRAFT.

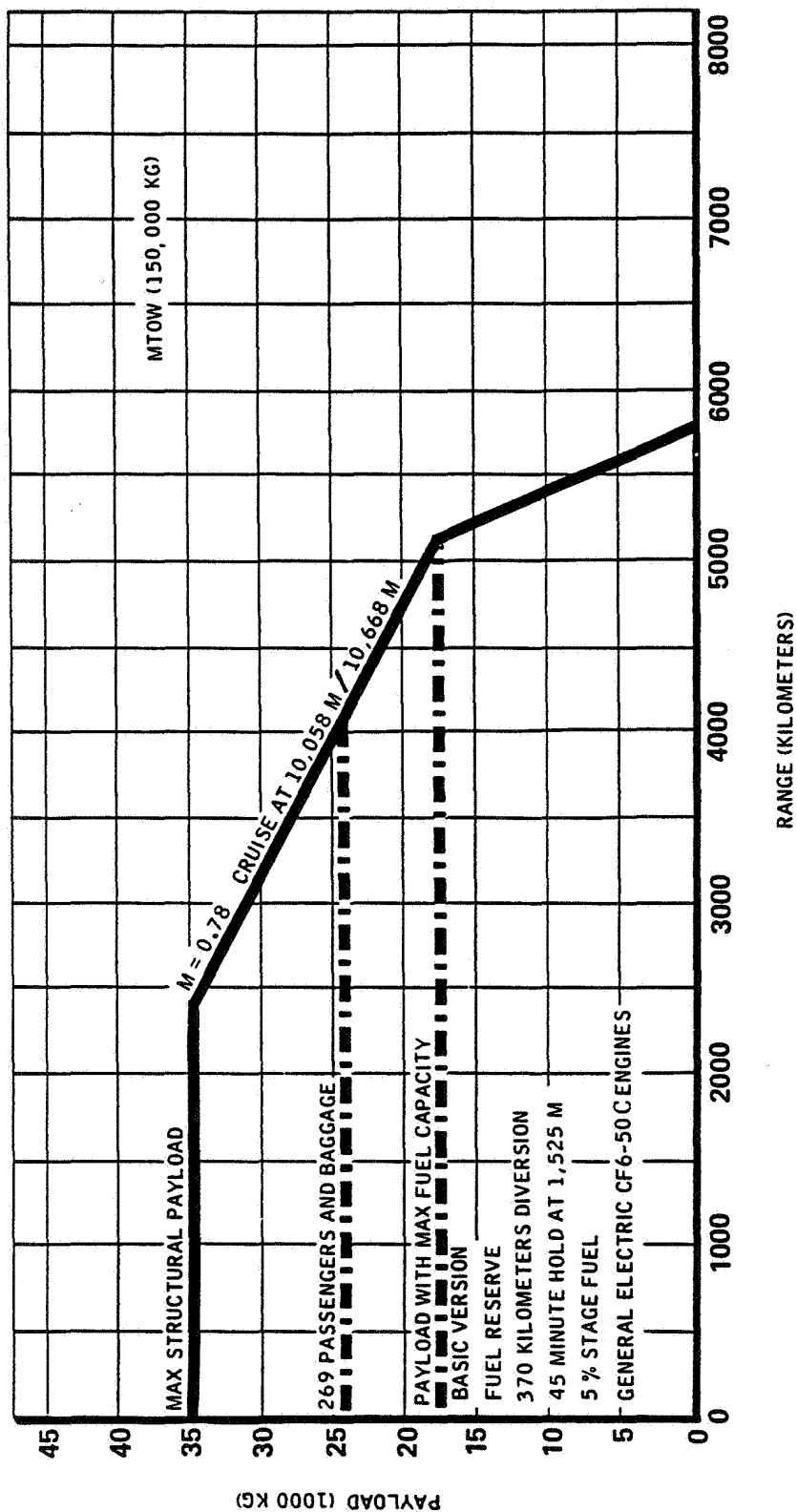

3.2 PAYLOAD RANGE
3.2.2 LONG RANGE AND RECOMMENDED CRUISE (METRIC UNITS)
MODEL B4-101

Printed in France

A 300

AIRPLANE CHARACTERISTICS

Printed in France

A A 5 03 02 02 0 AE 0

NOTE : THESE CURVES ARE GIVEN FOR INFORMATION ONLY.
THE APPROVED VALUES ARE STATED IN THE "OPERATING
MANUALS" SPECIFIC TO THE AIRLINE OPERATING THE AIRCRAFT.

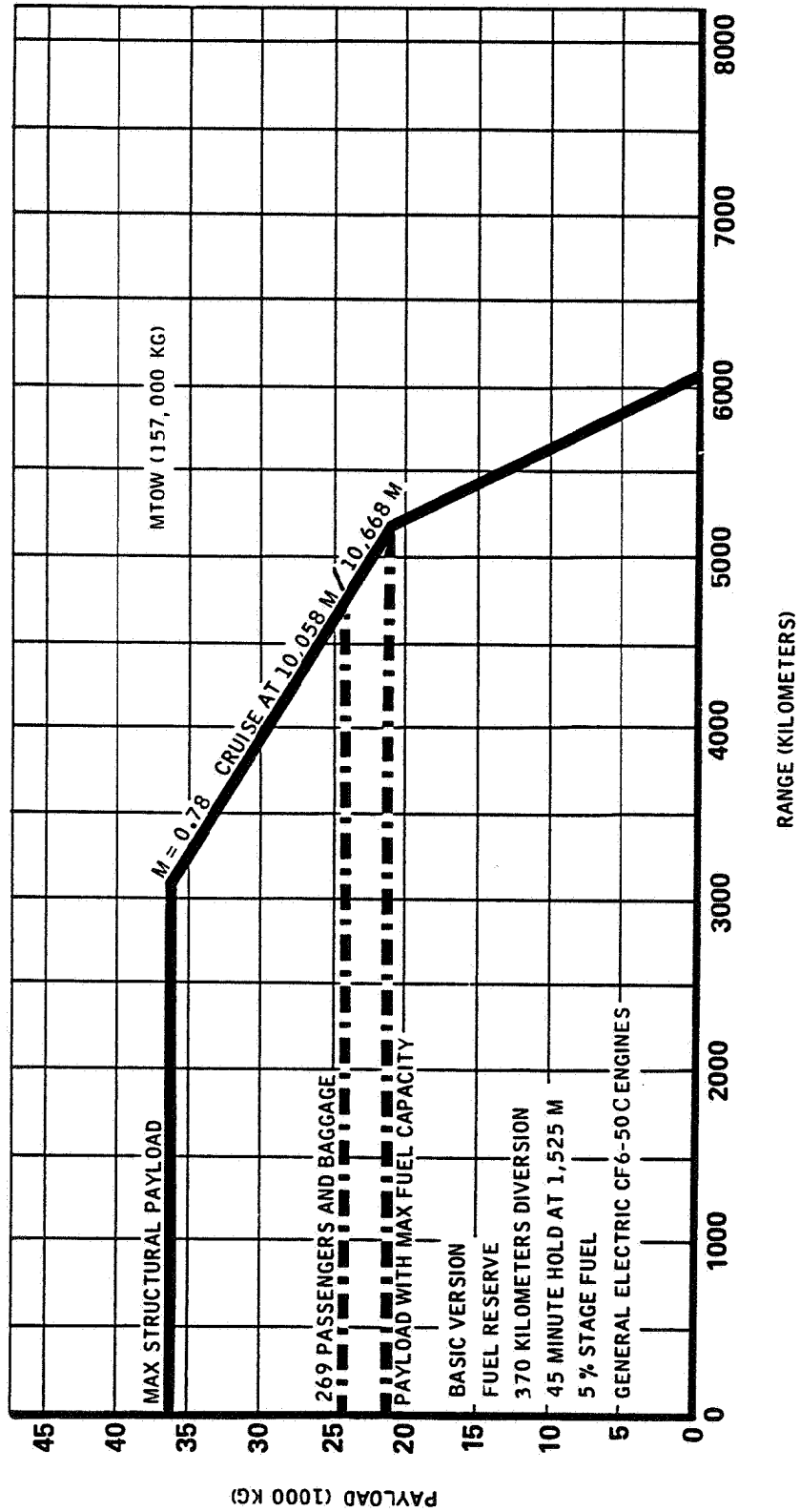

3.2 PAYLOAD RANGE
3.2.2 LONG RANGE AND RECOMMENDED CRUISE (METRIC UNITS)
MODEL B4-102

A 300

AIRPLANE CHARACTERISTICS

AA 5 03 02 02 0 AF 0

NOTE : THESE CURVES ARE GIVEN FOR INFORMATION ONLY.
THE APPROVED VALUES ARE STATED IN THE "OPERATING
MANUALS" SPECIFIC TO THE AIRLINE OPERATING THE AIRCRAFT.

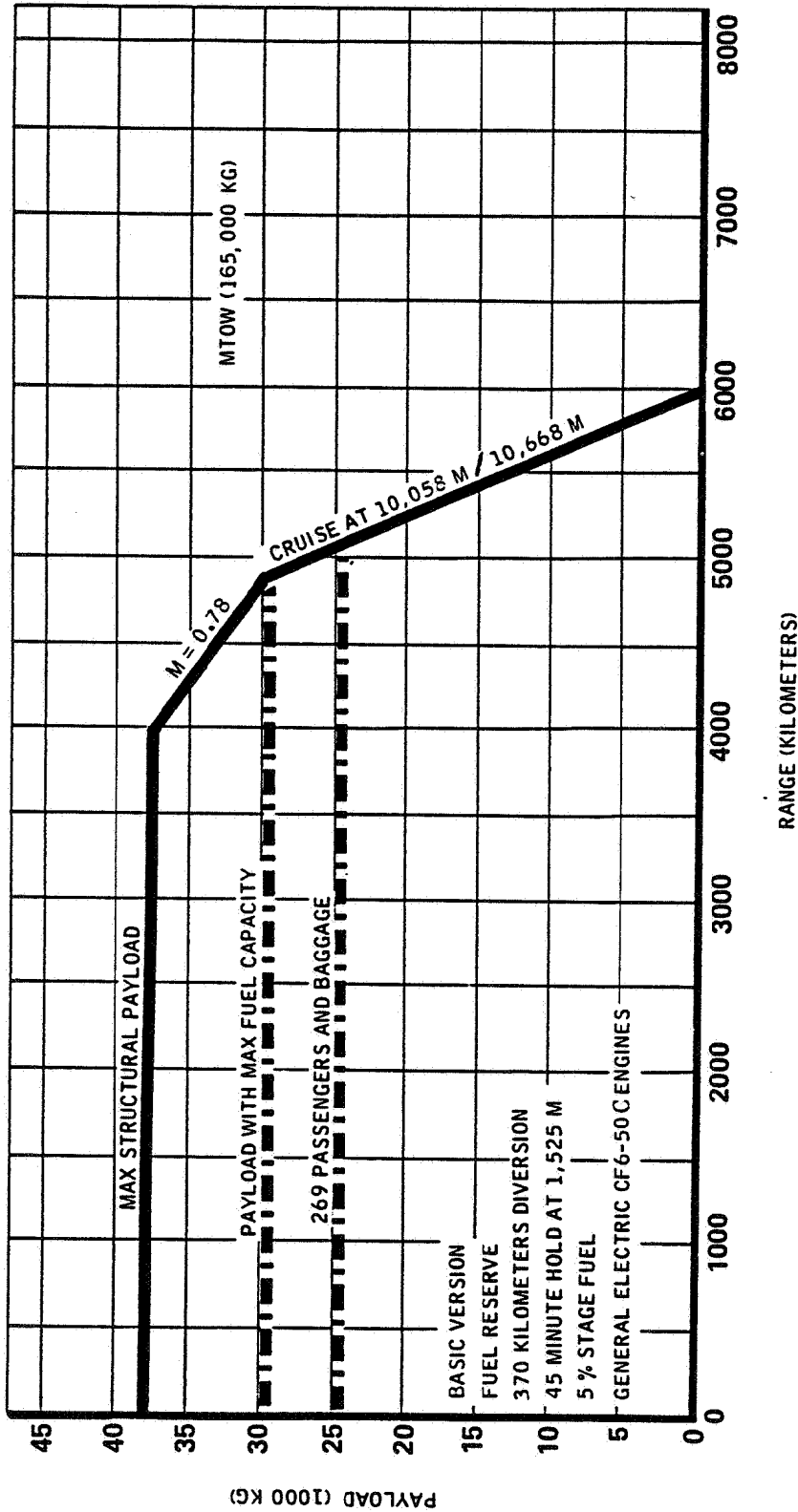

3.2 PAYLOAD RANGE
3.2.2 LONG RANGE AND RECOMMENDED CRUISE (METRIC UNITS)
MODEL B4-203

A 300

AIRPLANE CHARACTERISTICS

Printed in France

NOTE : THESE CURVES ARE GIVEN FOR INFORMATION ONLY.
THE APPROVED VALUES ARE STATED IN THE "OPERATING
MANUALS" SPECIFIC TO THE AIRLINE OPERATING THE AIRCRAFT.

AA 5 03 02 02 0 AG 0

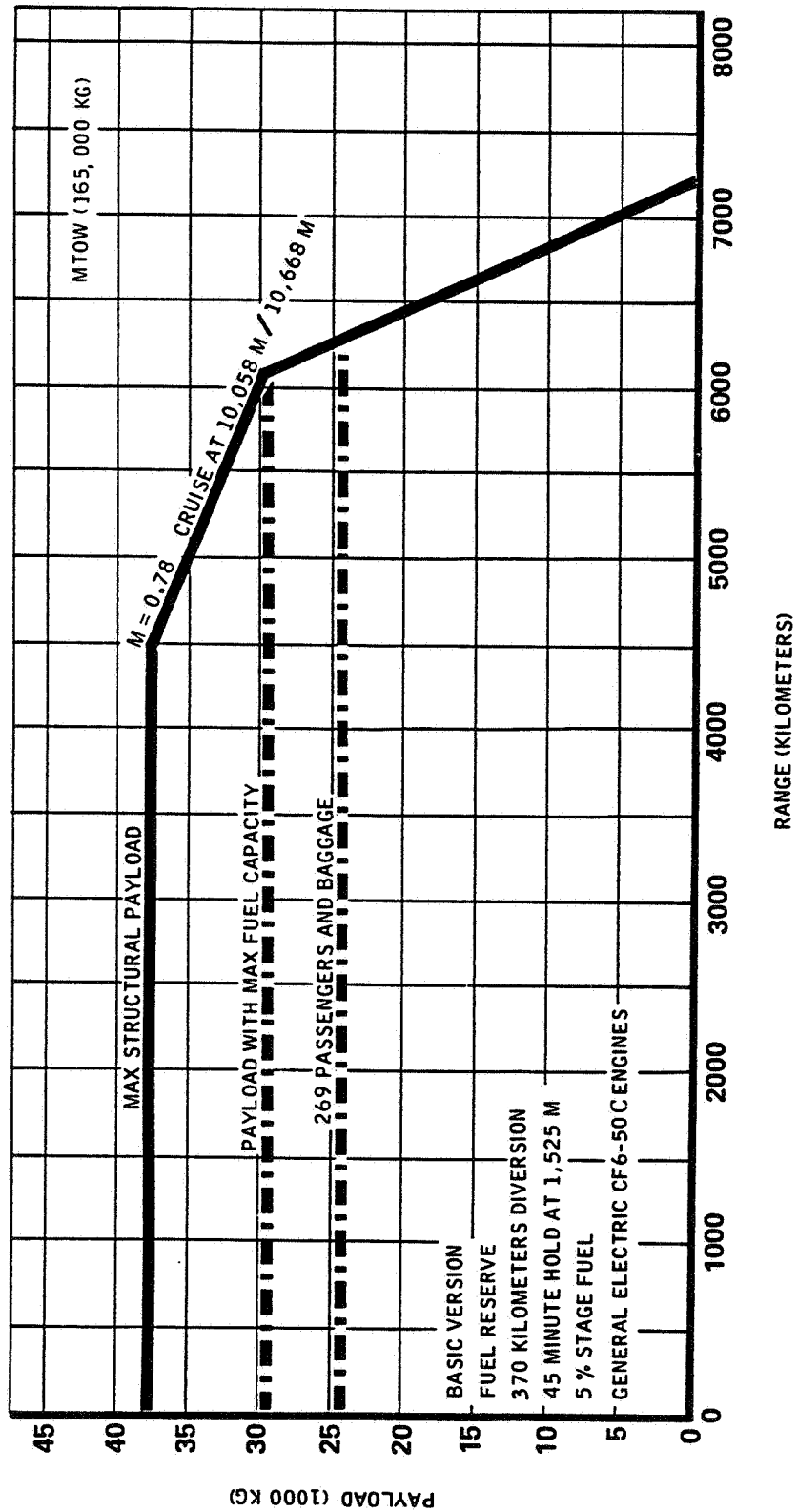

3.2 PAYLOAD RANGE 3.2.2 LONG RANGE AND RECOMMENDED CRUISE (METRIC UNITS) MODEL C4-PASS

A 300

AIRPLANE CHARACTERISTICS

NOTE : THESE CURVES ARE GIVEN FOR INFORMATION ONLY.
THE APPROVED VALUES ARE STATED IN THE "OPERATING
MANUALS" SPECIFIC TO THE AIRLINE OPERATING THE AIRCRAFT.

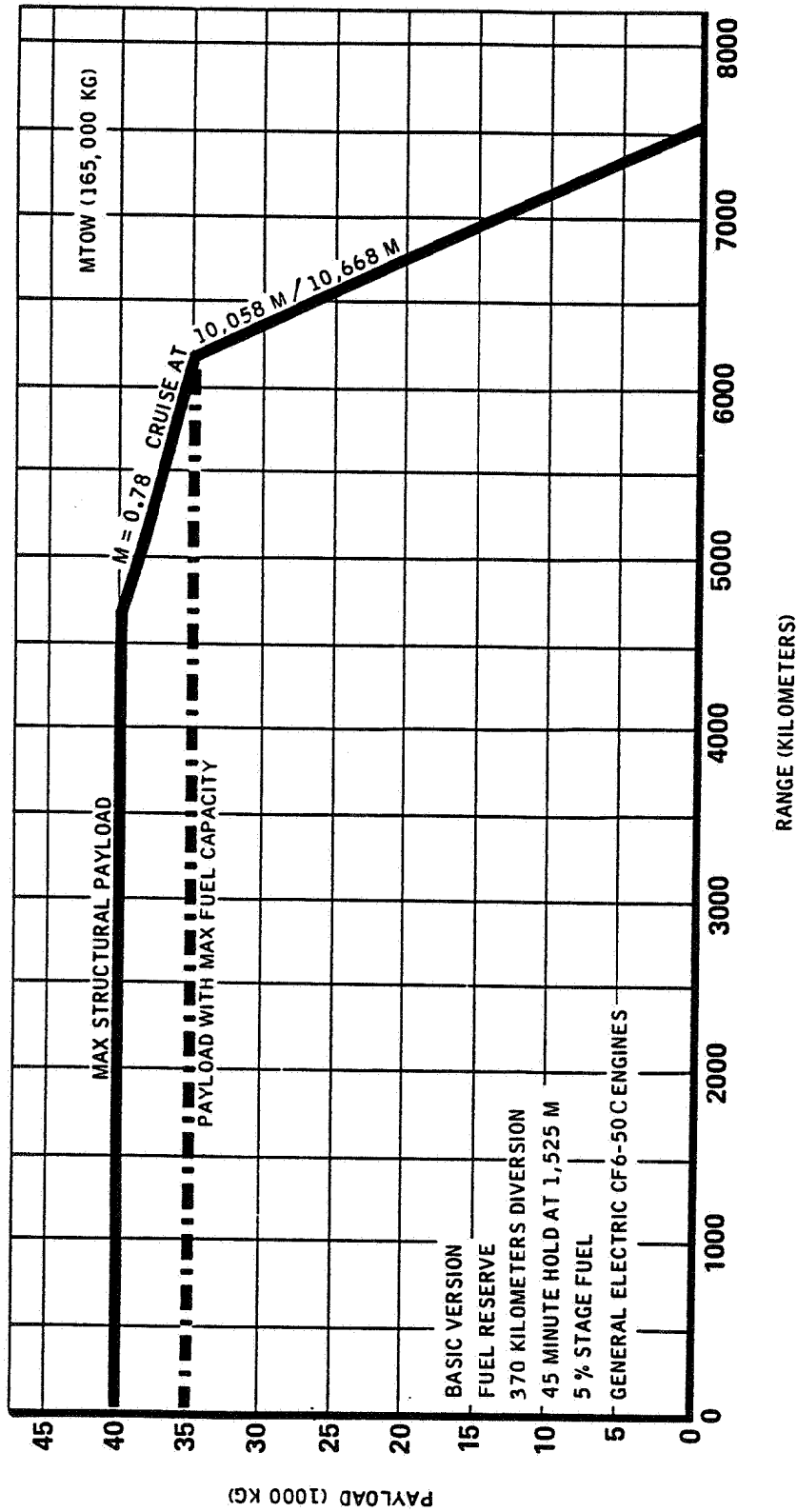

AA 5 03 02 02 0 AH 0

3.2 PAYLOAD RANGE

3.2.2 LONG RANGE AND RECOMMENDED CRUISE (METRIC UNITS)

MODEL C4-FREIGHT

A 300

AIRPLANE CHARACTERISTICS

NOTE : THESE CURVES ARE GIVEN FOR INFORMATION ONLY.
THE APPROVED VALUES ARE STATED IN THE "OPERATING
MANUALS" SPECIFIC TO THE AIRLINE OPERATING THE AIRCRAFT.

Printed in France

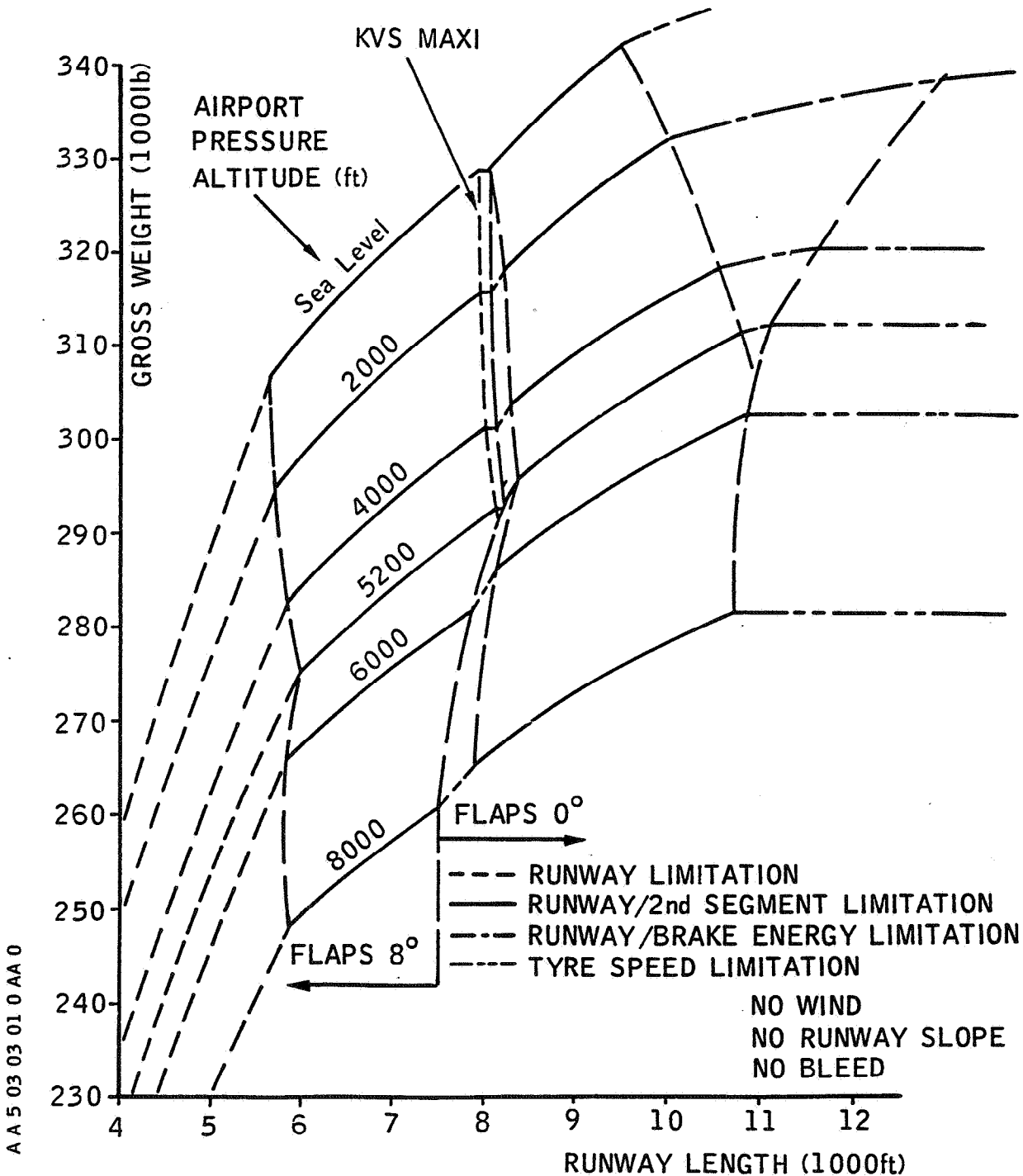

3.3 F.A.R. TAKEOFF RUNWAY LENGTH REQUIREMENTS
3.3.1 I.S.A. CONDITIONS - ALTERNATE (U.S. UNITS)
MODEL B2-101

A 300

AIRPLANE CHARACTERISTICS

NOTE : THESE CURVES ARE GIVEN FOR INFORMATION ONLY.
 THE APPROVED VALUES ARE STATED IN THE "OPERATING
 MANUALS" SPECIFIC TO THE AIRLINE OPERATING THE AIRCRAFT.

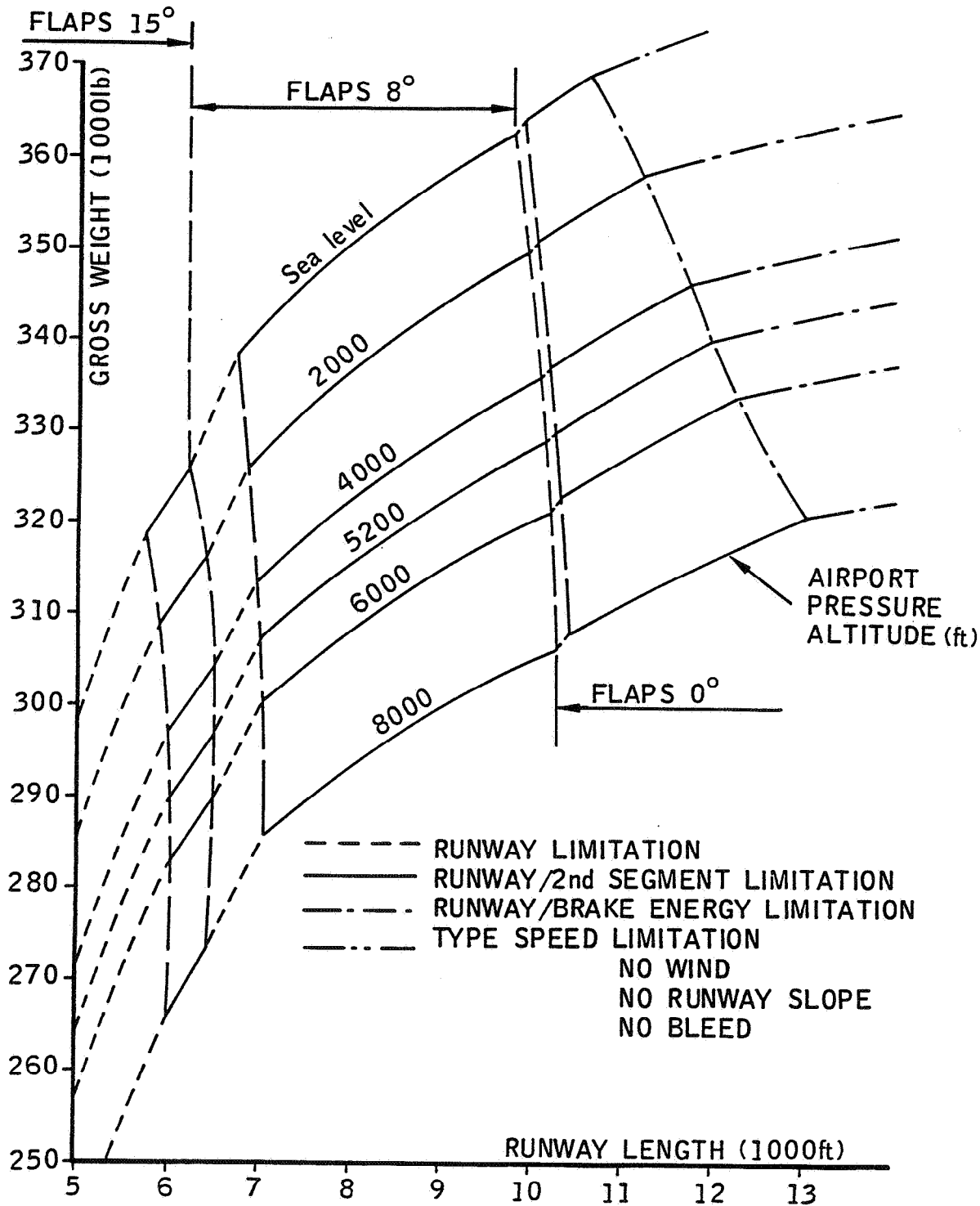

AA 503 03 01 0 AB 0

Printed in France

3.3 F.A.R. TAKEOFF RUNWAY LENGTH REQUIREMENTS
 3.3.1 I.S.A. CONDITIONS - ALTERNATE (U.S. UNITS)
 MODEL B2-320

A 300

AIRPLANE CHARACTERISTICS

NOTE : THESE CURVES ARE GIVEN FOR INFORMATION ONLY.
THE APPROVED VALUES ARE STATED IN THE "OPERATING
MANUALS" SPECIFIC TO THE AIRLINE OPERATING THE AIRCRAFT.

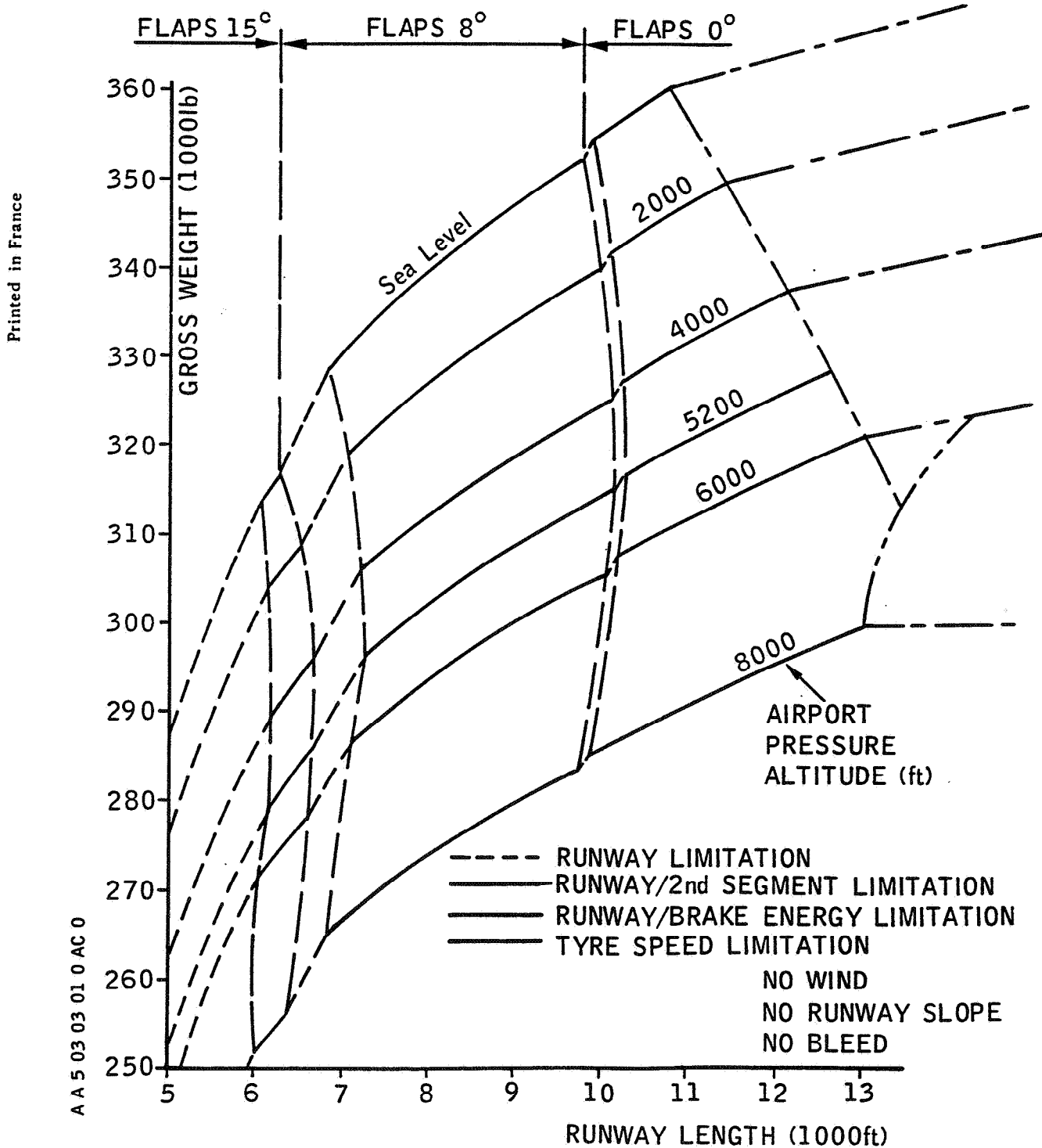

3.3 F.A.R. TAKEOFF RUNWAY LENGTH REQUIREMENTS
3.3.1 I.S.A. CONDITIONS - ALTERNATE (U.S. UNITS)
MODEL B4-101

A 300
AIRPLANE CHARACTERISTICS

NOTE : THESE CURVES ARE GIVEN FOR INFORMATION ONLY.
THE APPROVED VALUES ARE STATED IN THE "OPERATING
MANUALS" SPECIFIC TO THE AIRLINE OPERATING THE AIRCRAFT.

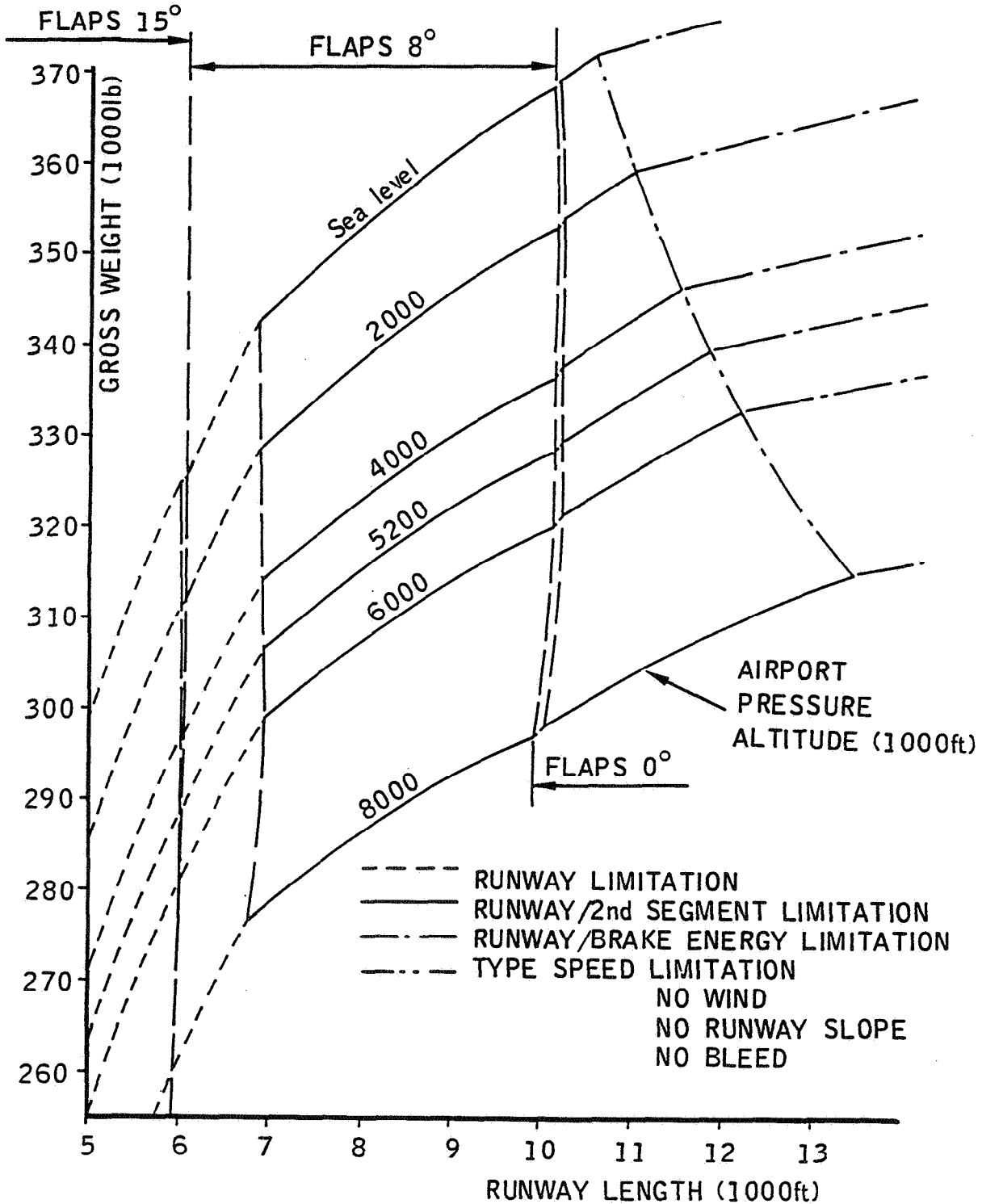

AA 5 03 03 01 0 AD 0

Printed in France

3.3 F.A.R. TAKEOFF RUNWAY LENGTH REQUIREMENTS
3.3.1 I.S.A. CONDITIONS - ALTERNATE (U.S. UNITS)
MODEL B4-203 - C4

A 300

AIRPLANE CHARACTERISTICS

NOTE : THESE CURVES ARE GIVEN FOR INFORMATION ONLY.
THE APPROVED VALUES ARE STATED IN THE "OPERATING
MANUALS" SPECIFIC TO THE AIRLINE OPERATING THE AIRCRAFT.

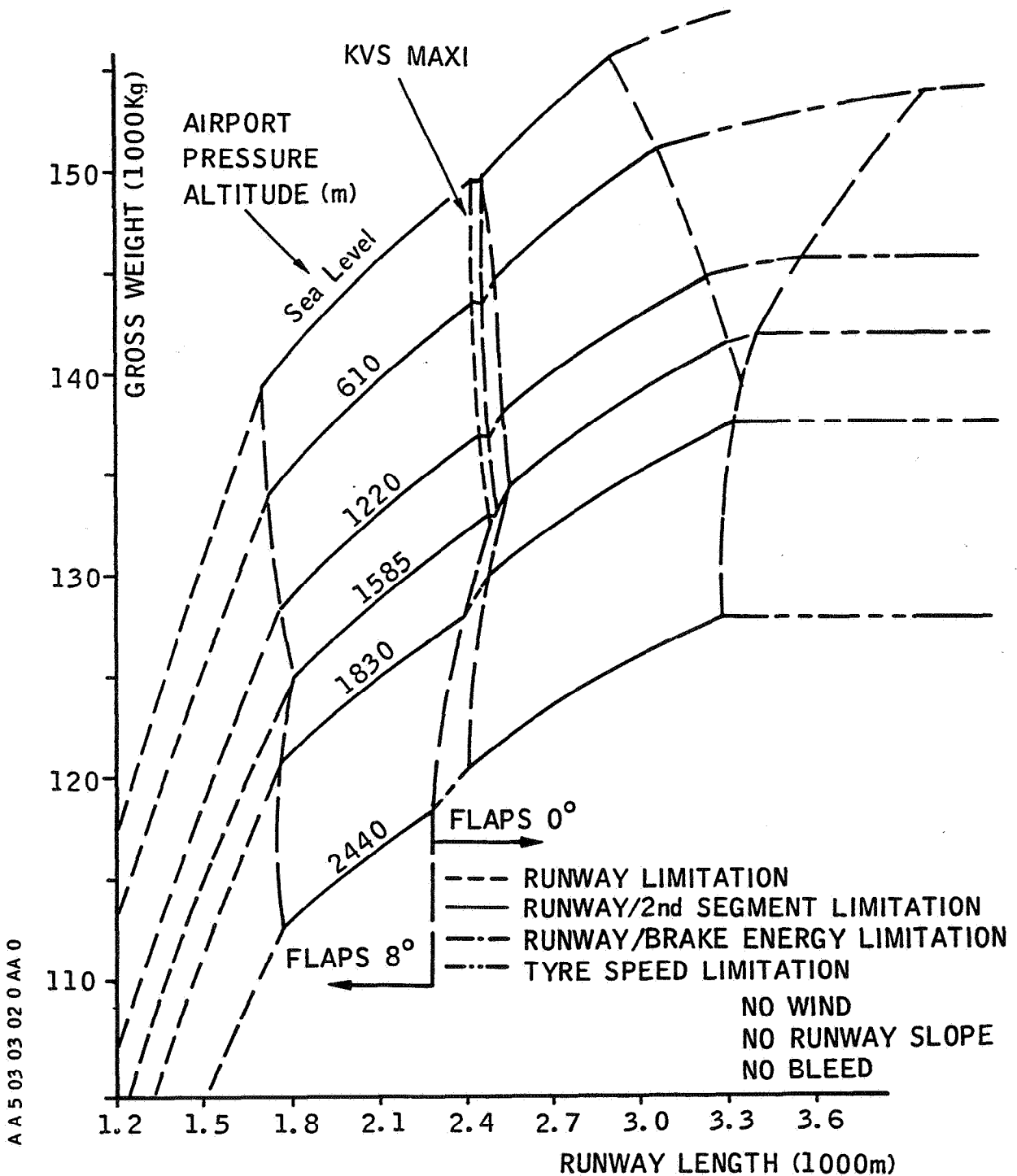

3.3 F.A.R. TAKEOFF RUNWAY LENGTH REQUIREMENTS
3.3.2 I.S.A. CONDITIONS - ALTERNATE (METRIC UNITS)
MODEL B2-101

A 300
AIRPLANE CHARACTERISTICS

NOTE : THESE CURVES ARE GIVEN FOR INFORMATION ONLY.
THE APPROVED VALUES ARE STATED IN THE "OPERATING
MANUALS" SPECIFIC TO THE AIRLINE OPERATING THE AIRCRAFT.

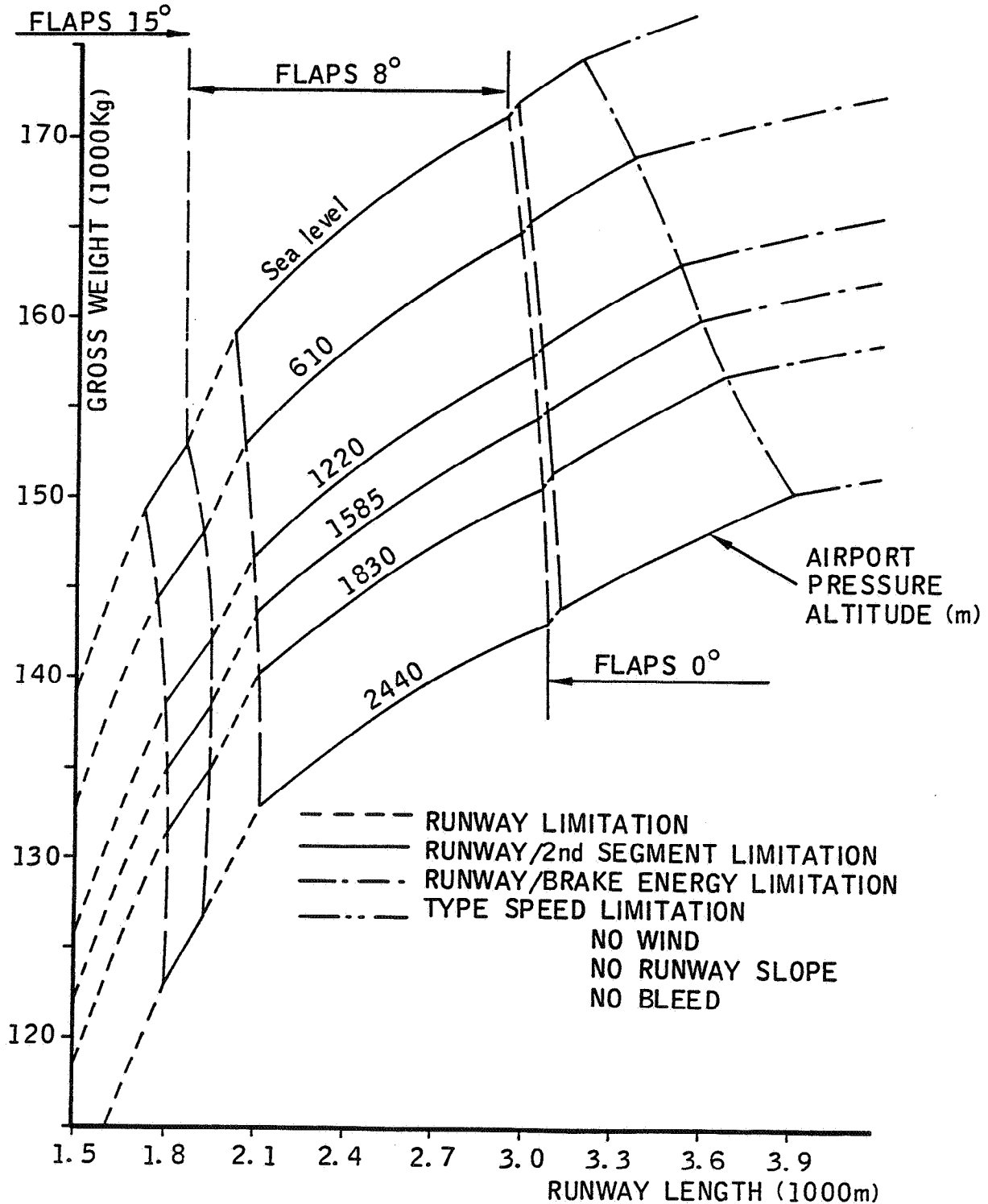

3.3 F.A.R. TAKEOFF RUNWAY LENGTH REQUIREMENTS
3.3.2 I.S.A. CONDITIONS - ALTERNATE (METRIC UNITS)
MODEL B2 -320

AA 5 03 03 02 0 AB 0

Printed in France

A 300
AIRPLANE CHARACTERISTICS

NOTE : THESE CURVES ARE GIVEN FOR INFORMATION ONLY.
THE APPROVED VALUES ARE STATED IN THE "OPERATING
MANUALS" SPECIFIC TO THE AIRLINE OPERATING THE AIRCRAFT.

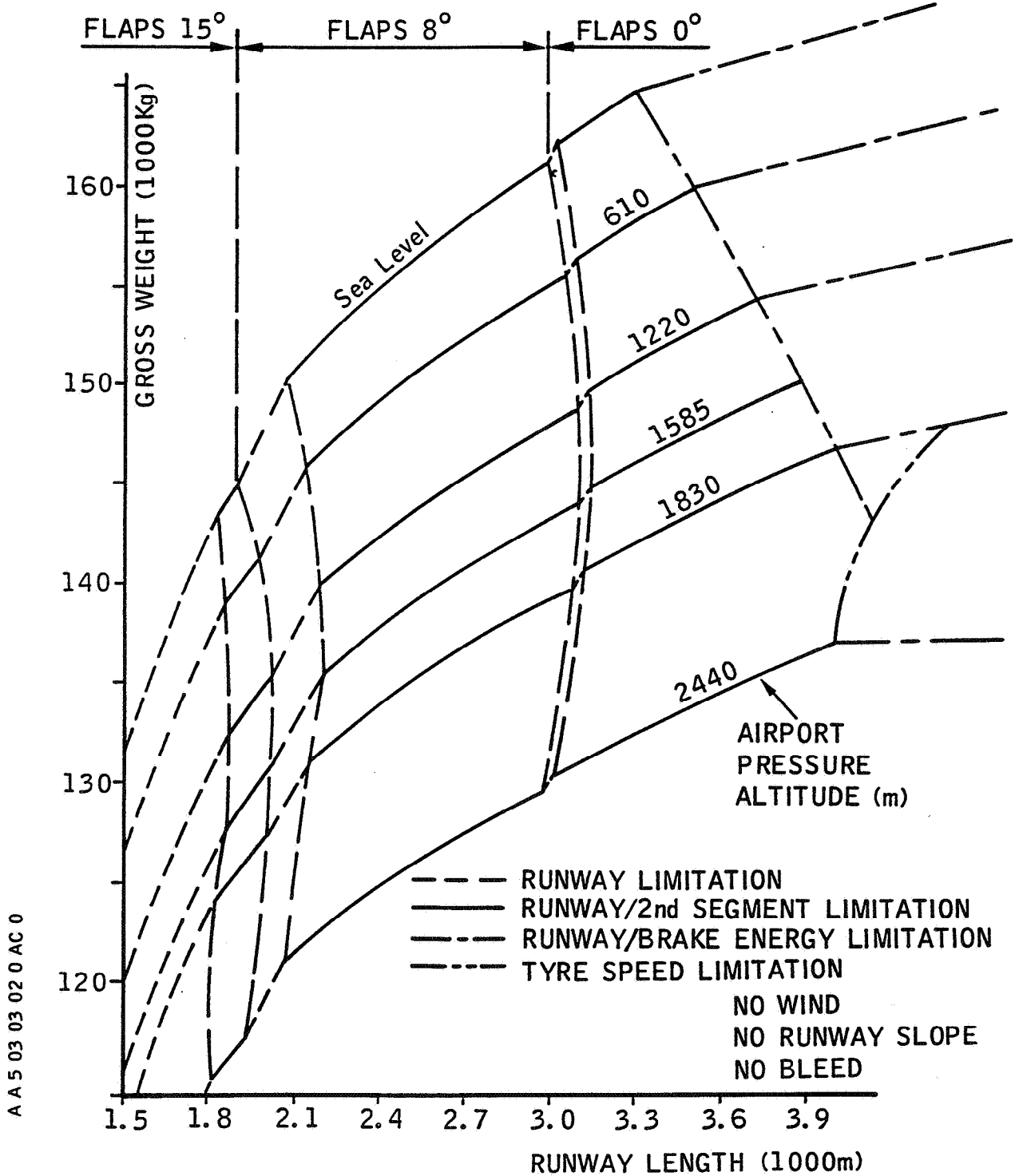

3.3 F.A.R. TAKEOFF RUNWAY LENGTH REQUIREMENTS
3.3.2 I.S.A. CONDITIONS - ALTERNATE (METRIC UNITS)
MODEL B4-101

A 300

AIRPLANE CHARACTERISTICS

NOTE : THESE CURVES ARE GIVEN FOR INFORMATION ONLY.
THE APPROVED VALUES ARE STATED IN THE "OPERATING MANUALS" SPECIFIC TO THE AIRLINE OPERATING THE AIRCRAFT.

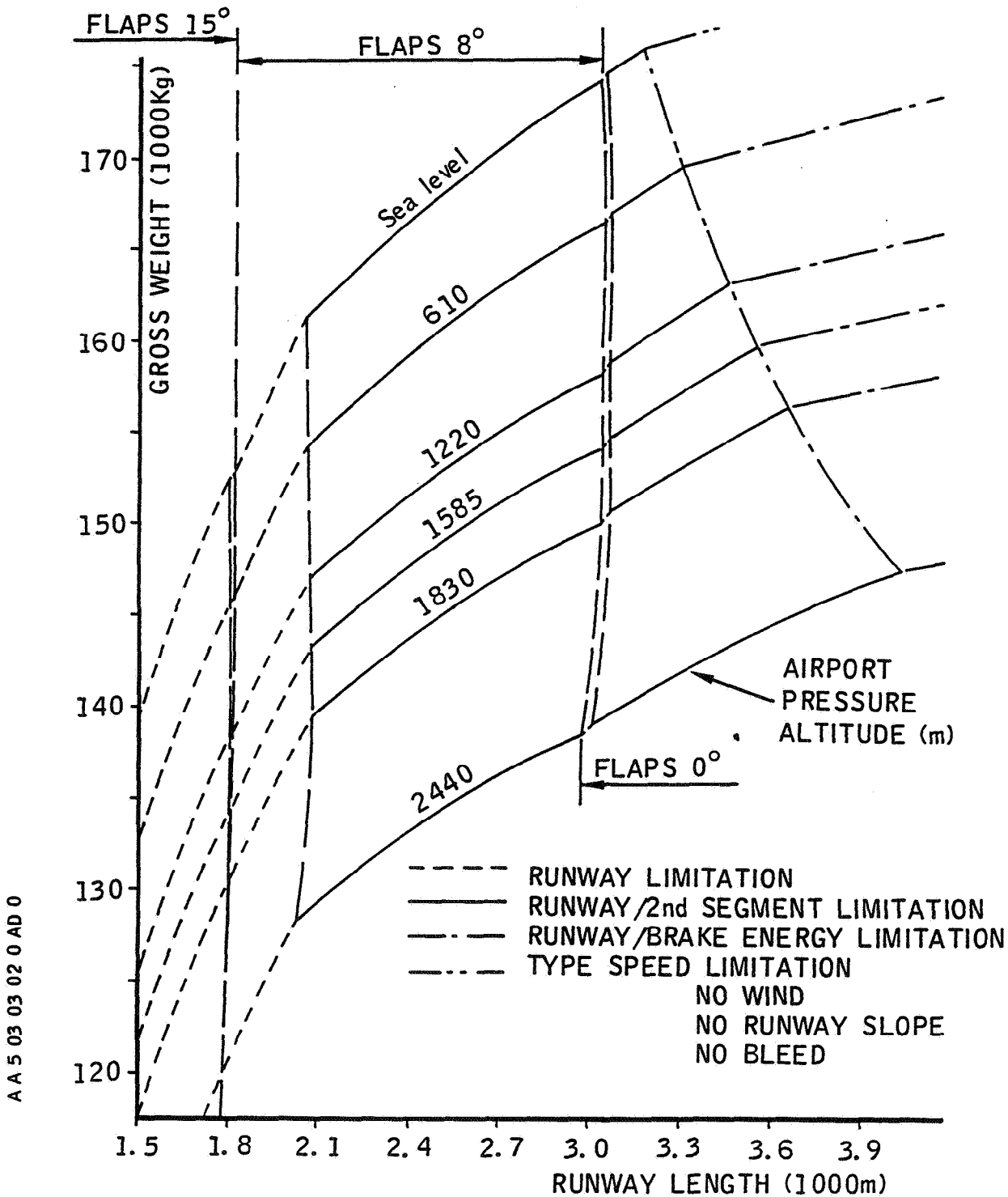

Printed in France

AA 5 03 03 02 0 AD 0

3.3 F.A.R. TAKEOFF RUNWAY LENGTH REQUIREMENTS
3.3.2. I.S.A. CONDITIONS - ALTERNATE (METRIC UNITS)
MODEL B4-203 - C4

A 300
AIRPLANE CHARACTERISTICS

NOTE : THESE CURVES ARE GIVEN FOR INFORMATION ONLY.
THE APPROVED VALUES ARE STATED IN THE "OPERATING
MANUALS" SPECIFIC TO THE AIRLINE OPERATING THE AIRCRAFT.

Printed in France

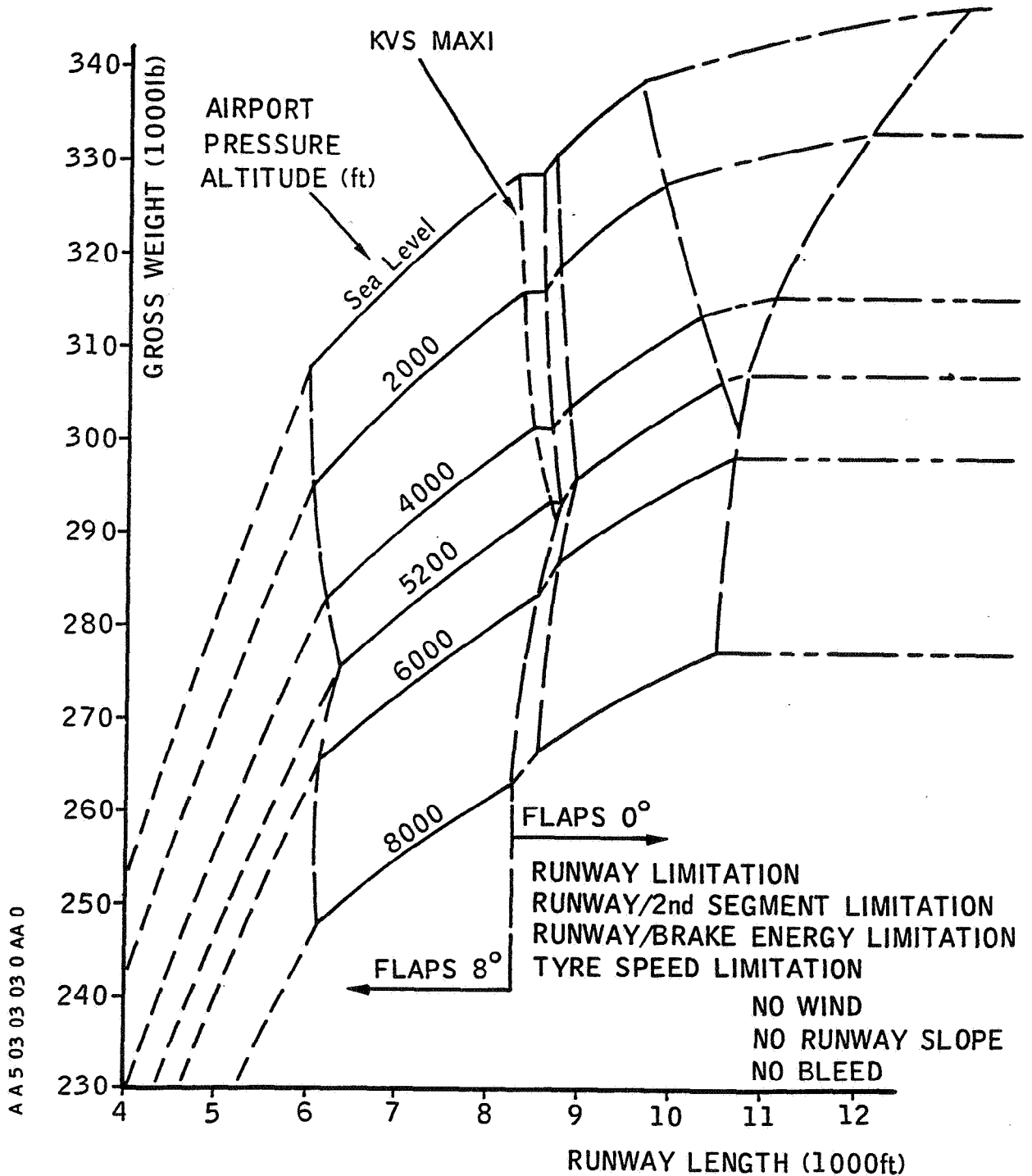

3.3 F.A.R. TAKEOFF RUNWAY LENGTH REQUIREMENTS
3.3.3 I.S.A. CONDITIONS +59°F (+15°C) - ALTERNATE (U.S. UNITS)
MODEL B2-101

A 300

AIRPLANE CHARACTERISTICS

NOTE : THESE CURVES ARE GIVEN FOR INFORMATION ONLY.
THE APPROVED VALUES ARE STATED IN THE "OPERATING MANUALS" SPECIFIC TO THE AIRLINE OPERATING THE AIRCRAFT.

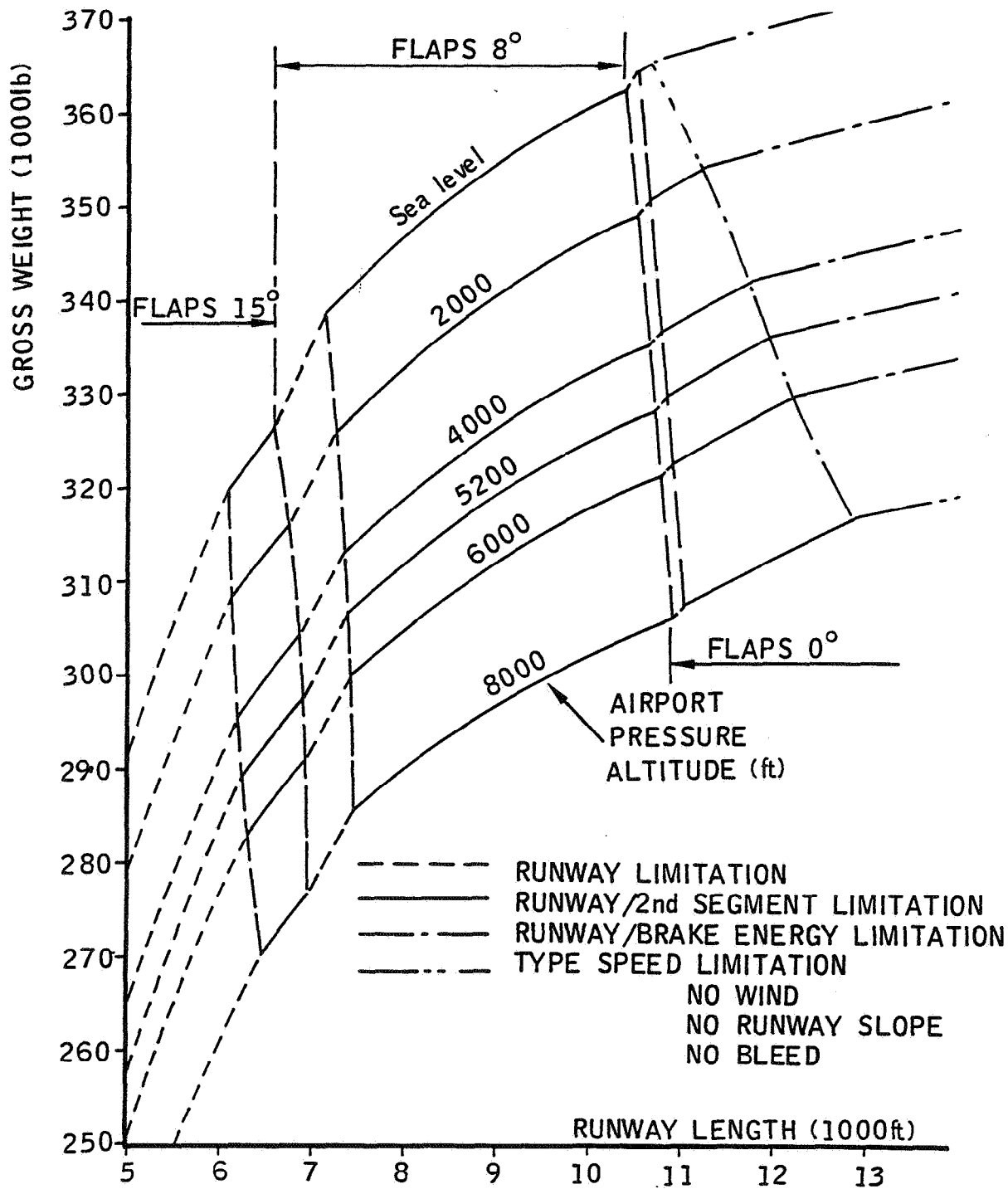

Printed in France

AA 5 03 03 0 AB 0

3.3 F.A.R. TAKEOFF RUNWAY LENGTH REQUIREMENTS
3.3.3 I.S.A. CONDITIONS +59°F(+15°C) - ALTERNATE (U.S. UNITS)
MODEL B2-320

A 300

AIRPLANE CHARACTERISTICS

NOTE : THESE CURVES ARE GIVEN FOR INFORMATION ONLY.
THE APPROVED VALUES ARE STATED IN THE "OPERATING
MANUALS" SPECIFIC TO THE AIRLINE OPERATING THE AIRCRAFT.

Printed in France

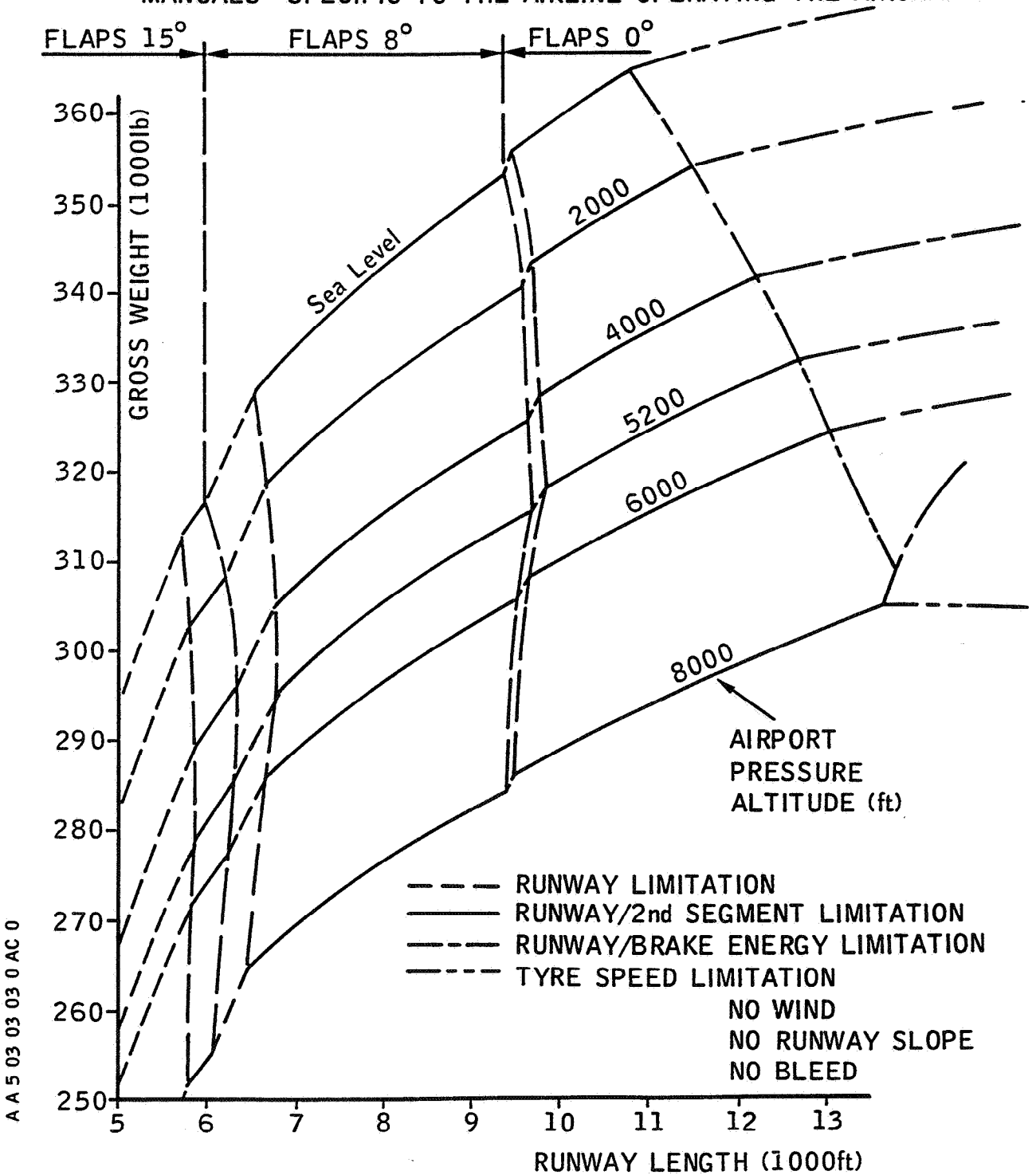

3.3 F.A.R. TAKEOFF RUNWAY LENGTH REQUIREMENTS
3.3.3 I.S.A. CONDITIONS +59°F (+15°C) - ALTERNATE (U.S. UNITS)
MODEL B4-101

A 300
AIRPLANE CHARACTERISTICS

NOTE : THESE CURVES ARE GIVEN FOR INFORMATION ONLY.
THE APPROVED VALUES ARE STATED IN THE "OPERATING
MANUALS" SPECIFIC TO THE AIRLINE OPERATING THE AIRCRAFT.

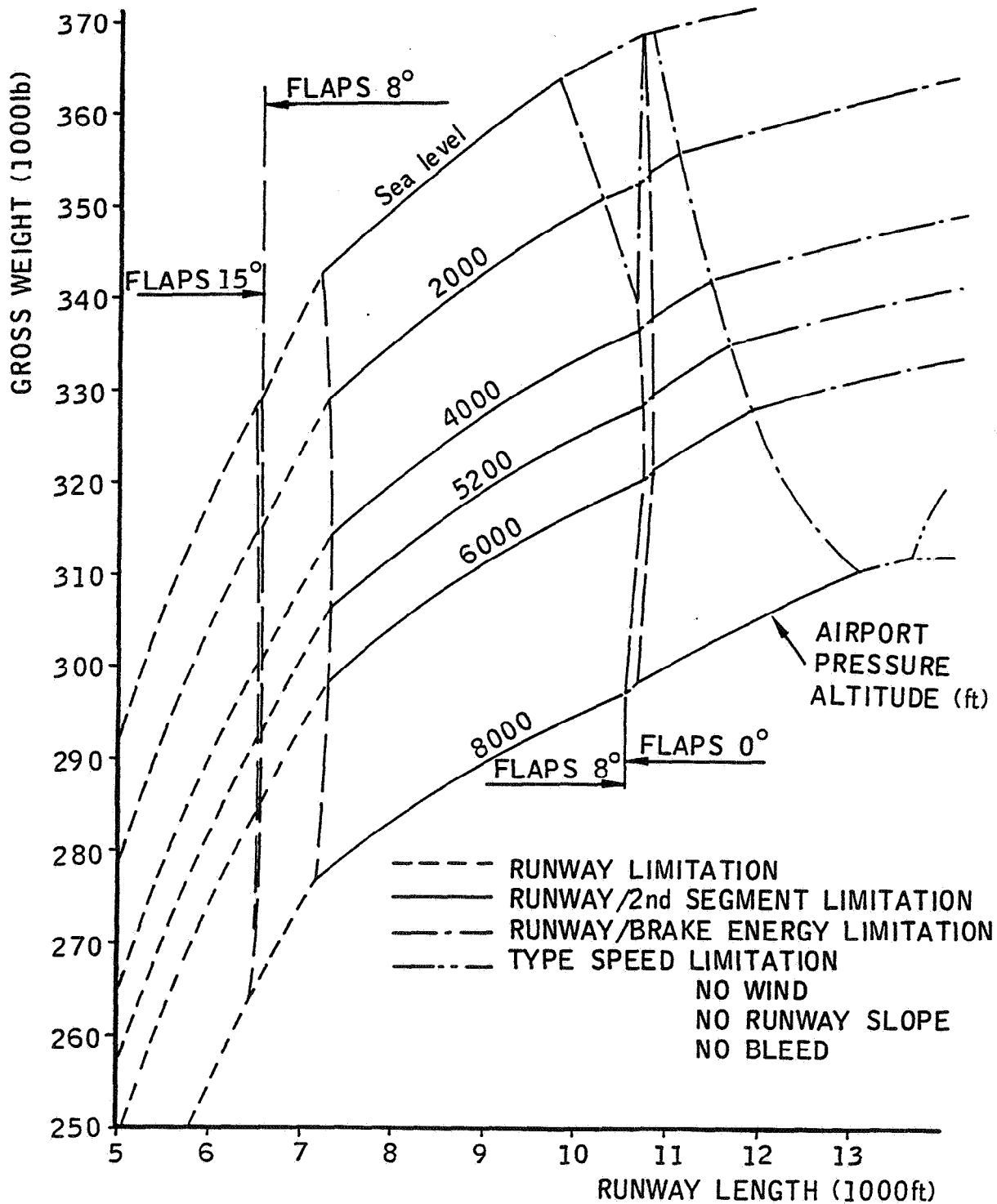

A 5 03 03 0 AD 0

Printed in France

3.3 F.A.R. TAKEOFF RUNWAY LENGTH REQUIREMENTS
3.3.3 I.S.A. CONDITIONS +59°F(+15°C) - ALTERNATE (U.S. UNITS)
MODEL B4-203 - C4

A 300

AIRPLANE CHARACTERISTICS

NOTE : THESE CURVES ARE GIVEN FOR INFORMATION ONLY.
THE APPROVED VALUES ARE STATED IN THE "OPERATING
MANUALS" SPECIFIC TO THE AIRLINE OPERATING THE AIRCRAFT.

Printed in France

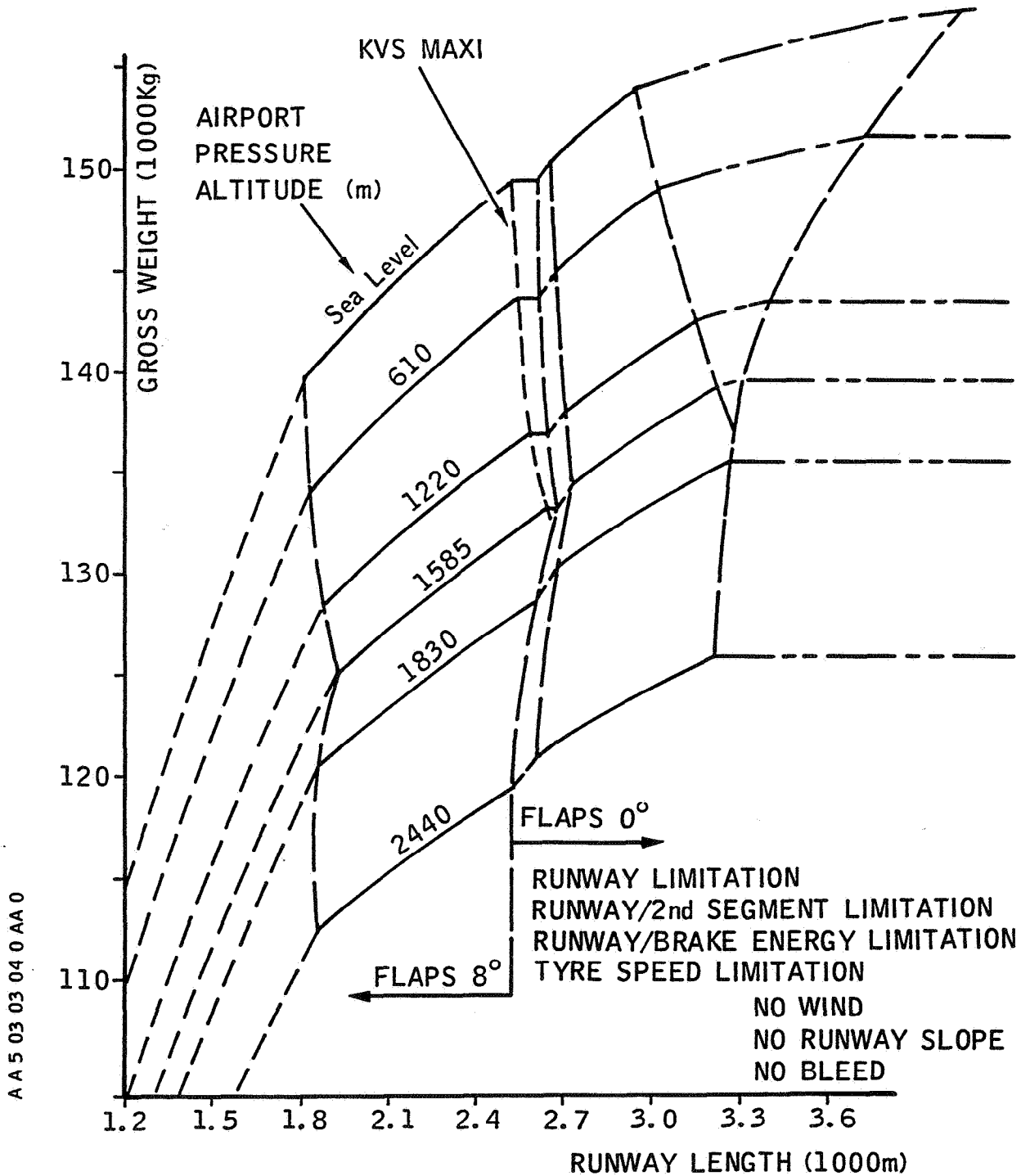

AA 5 03 03 04 0 AA 0

3.3 F.A.R. TAKEOFF RUNWAY LENGTH REQUIREMENTS

3.3.4 I.S.A. CONDITIONS +59°F(+15°C) - ALTERNATE (METRIC UNITS)
MODEL B2-101

A 300

AIRPLANE CHARACTERISTICS

NOTE : THESE CURVES ARE GIVEN FOR INFORMATION ONLY.
THE APPROVED VALUES ARE STATED IN THE "OPERATING
MANUALS" SPECIFIC TO THE AIRLINE OPERATING THE AIRCRAFT.

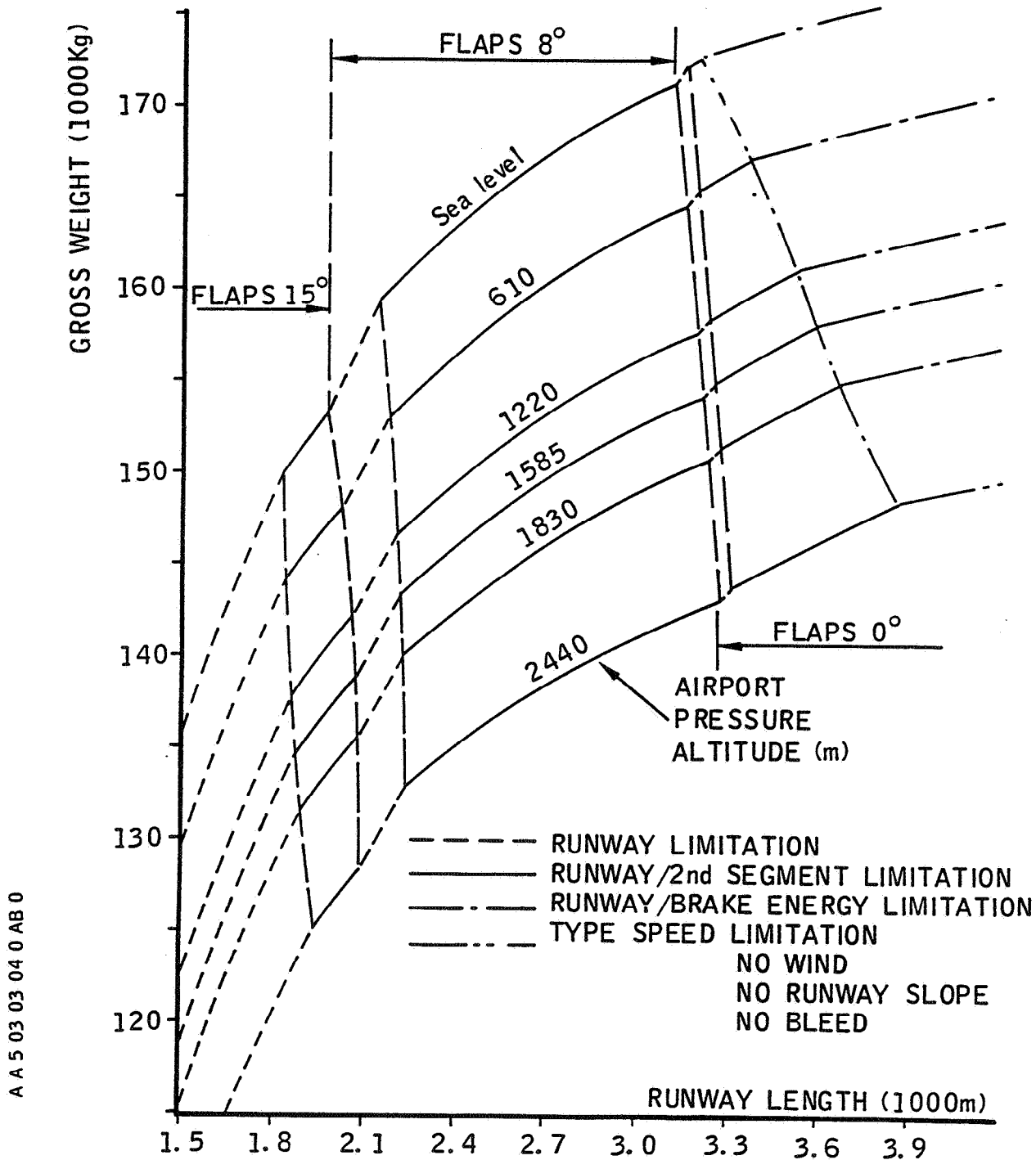

3.3 F.A.R. TAKEOFF RUNWAY LENGTH REQUIREMENTS

3.3.4 I.S.A. CONDITIONS +59°F(+15°C) - ALTERNATE (METRIC UNITS)
MODEL B2-320

A 300

AIRPLANE CHARACTERISTICS

NOTE : THESE CURVES ARE GIVEN FOR INFORMATION ONLY.
THE APPROVED VALUES ARE STATED IN THE "OPERATING MANUALS" SPECIFIC TO THE AIRLINE OPERATING THE AIRCRAFT.

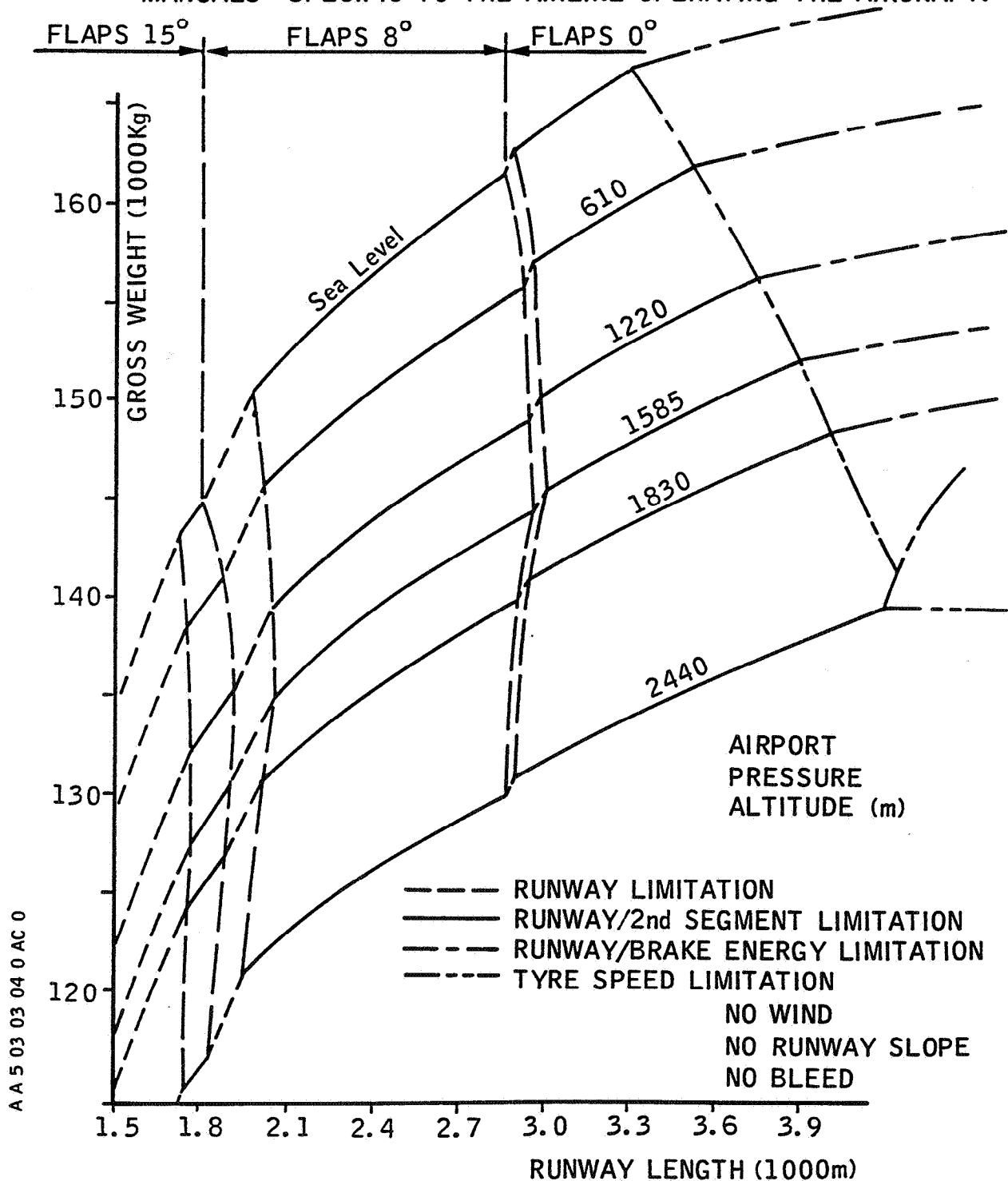

AA 5 03 03 04 0 AC 0

3.3 F.A.R. TAKEOFF RUNWAY LENGTH REQUIREMENTS
3.3.4 I.S.A. CONDITIONS +59°F(+15°C) - ALTERNATE (METRIC UNITS)
MODEL B4-101

A 300
AIRPLANE CHARACTERISTICS

NOTE : THESE CURVES ARE GIVEN FOR INFORMATION ONLY.
THE APPROVED VALUES ARE STATED IN THE "OPERATING
MANUALS" SPECIFIC TO THE AIRLINE OPERATING THE AIRCRAFT.

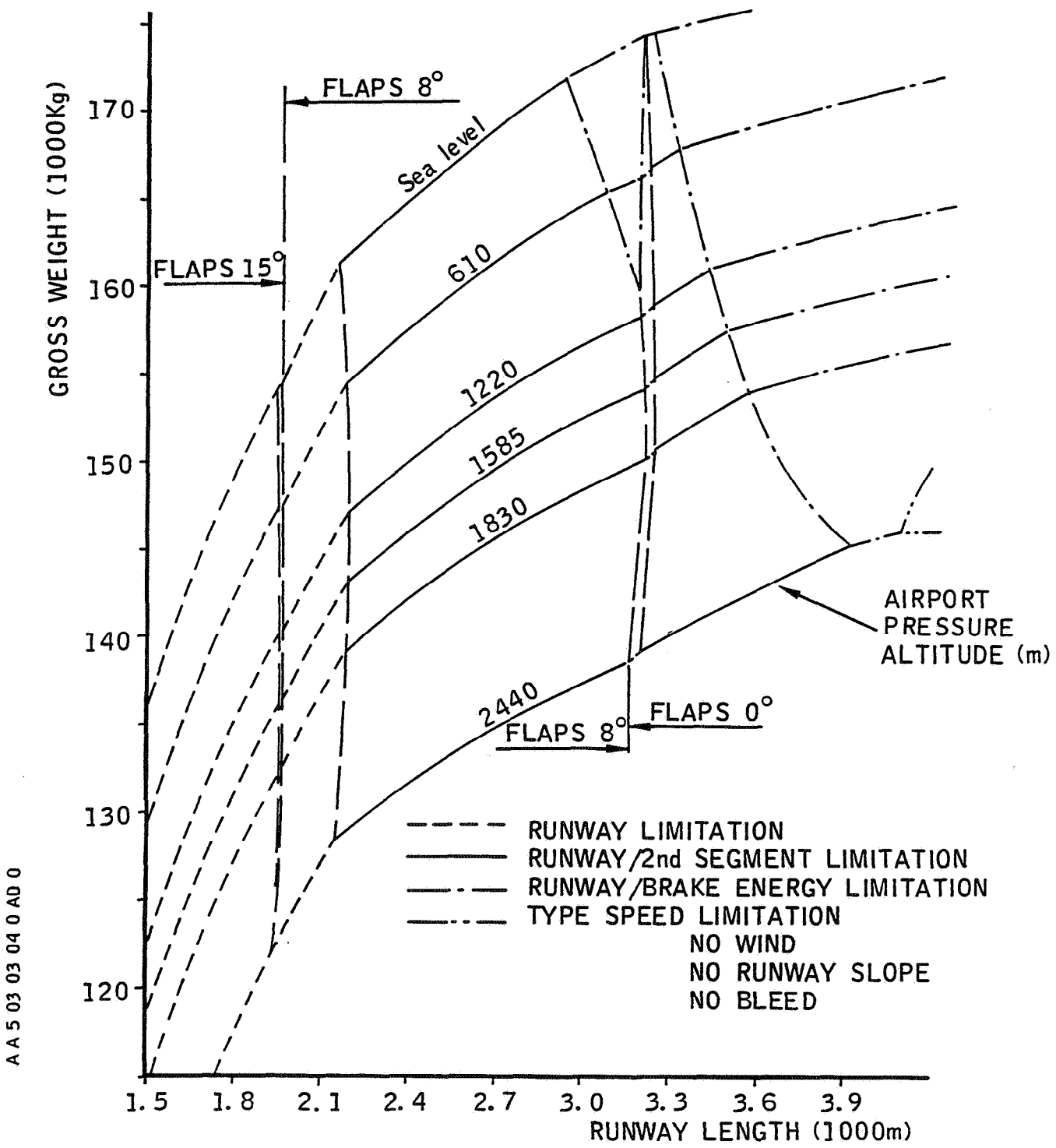

Printed in France

AA 5 03 03 04 0 AD 0

3.3 F.A.R. TAKEOFF RUNWAY LENGTH REQUIREMENTS
3.3.4 I.S.A. CONDITIONS +59°F(+15°C) - ALTERNATE (METRIC UNITS)
MODEL B4-203 - C4

A 300
AIRPLANE CHARACTERISTICS

NOTE : THESE CURVES ARE GIVEN FOR INFORMATION ONLY.
THE APPROVED VALUES ARE STATED IN THE "OPERATING
MANUALS" SPECIFIC TO THE AIRLINE OPERATING THE AIRCRAFT.

$$\text{F. A. R. LANDING FIELD LENGTH} = \frac{\text{ACTUAL DISTANCE}}{0.6}$$

Printed in France

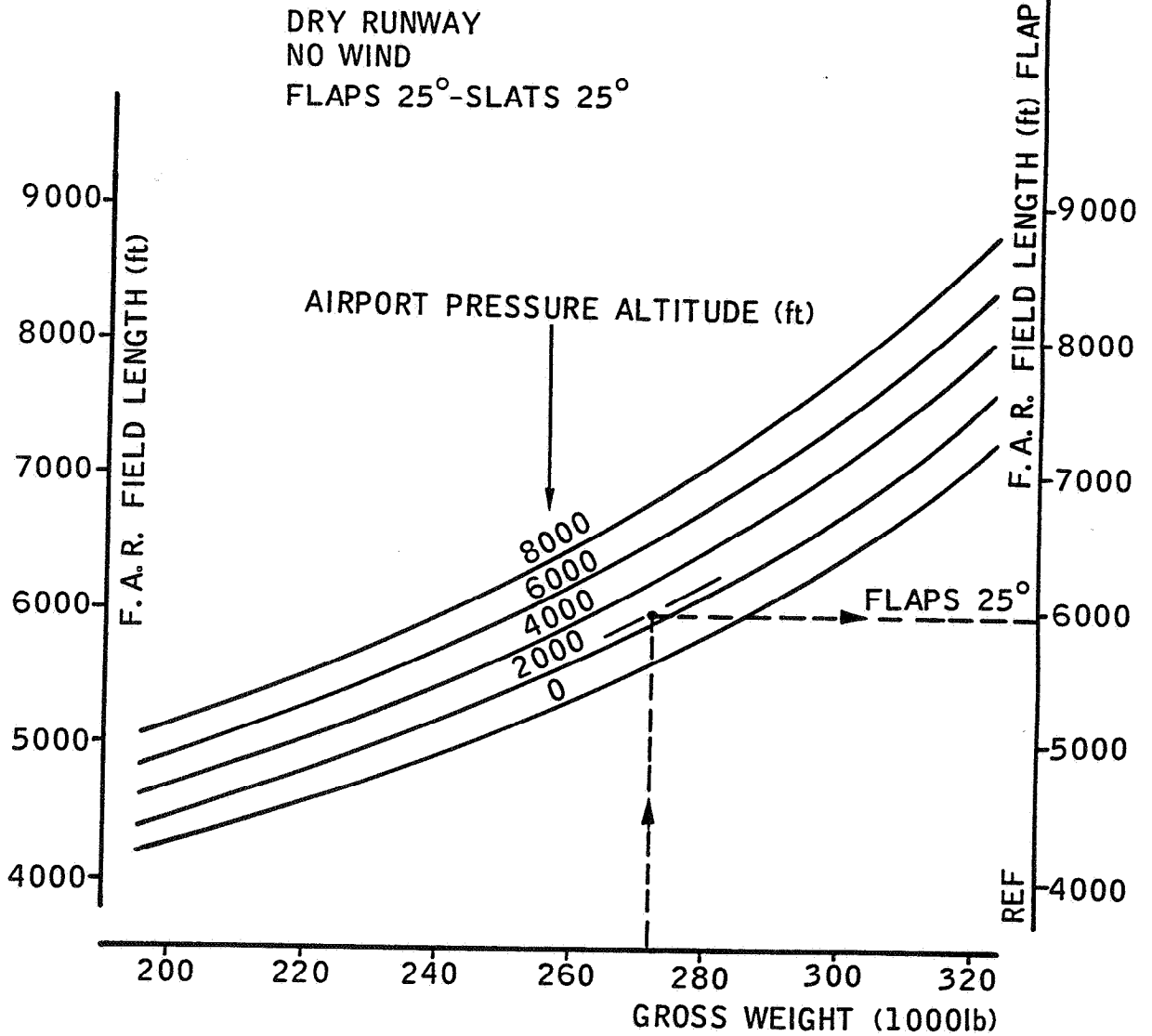

AA 5 03 04 01 0 AA 0

ALL AMBIENT TEMPERATURES

3.4 F.A.R. LANDING RUNWAY LENGTH REQUIREMENTS
3.4.1 FULL FLAPS (U.S. UNITS)
MODEL B4/C4

A 300

AIRPLANE CHARACTERISTICS

NOTE : THESE CURVES ARE GIVEN FOR INFORMATION ONLY.
THE APPROVED VALUES ARE STATED IN THE "OPERATING
MANUALS" SPECIFIC TO THE AIRLINE OPERATING THE AIRCRAFT.

F.A.R. LANDING FIELD LENGTH = $\frac{\text{ACTUAL DISTANCE}}{0.6}$

DRY RUNWAY
NO WIND
FLAPS 25° - SLATS 25°

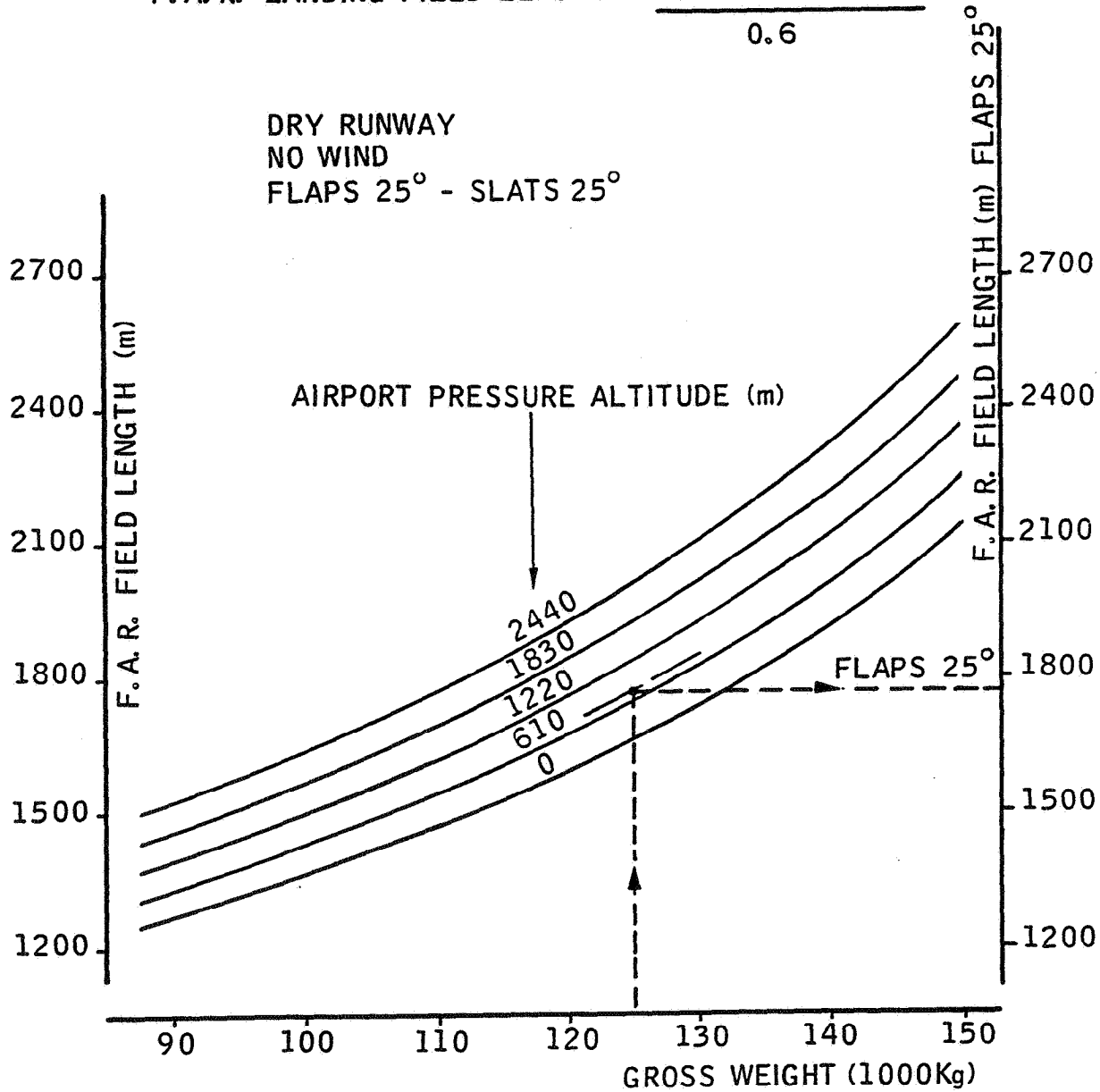

Printed in France

ALL AMBIENT TEMPERATURES

3.4 F.A.R. LANDING RUNWAY LENGTH REQUIREMENTS
3.4.2 FULL FLAPS (METRIC UNITS)
MODEL B4/C4

AA 5 03 04 02 0 AA 0

A 300

AIRPLANE CHARACTERISTICS

INCREASE
+ 15% ON FORESEEN
WET RUNWAY

NOTE : THESE CURVES ARE GIVEN FOR INFORMATION ONLY. THE APPROVED VALUES ARE STATED IN THE "OPERATING MANUALS" SPECIFIC TO THE AIRLINE OPERATING THE AIRCRAFT.

EXAMPLE	
DATA	RESULTS
Weight : 115t	Speed : 127kt
Altitude : 2000ft	Gross length : 1000m
Tail wind : 5kt	Reglementary length : 1650m

SLATS 25° FLAPS 25°

Printed in France

LANDING DISTANCES
(km)
gross
reglementary

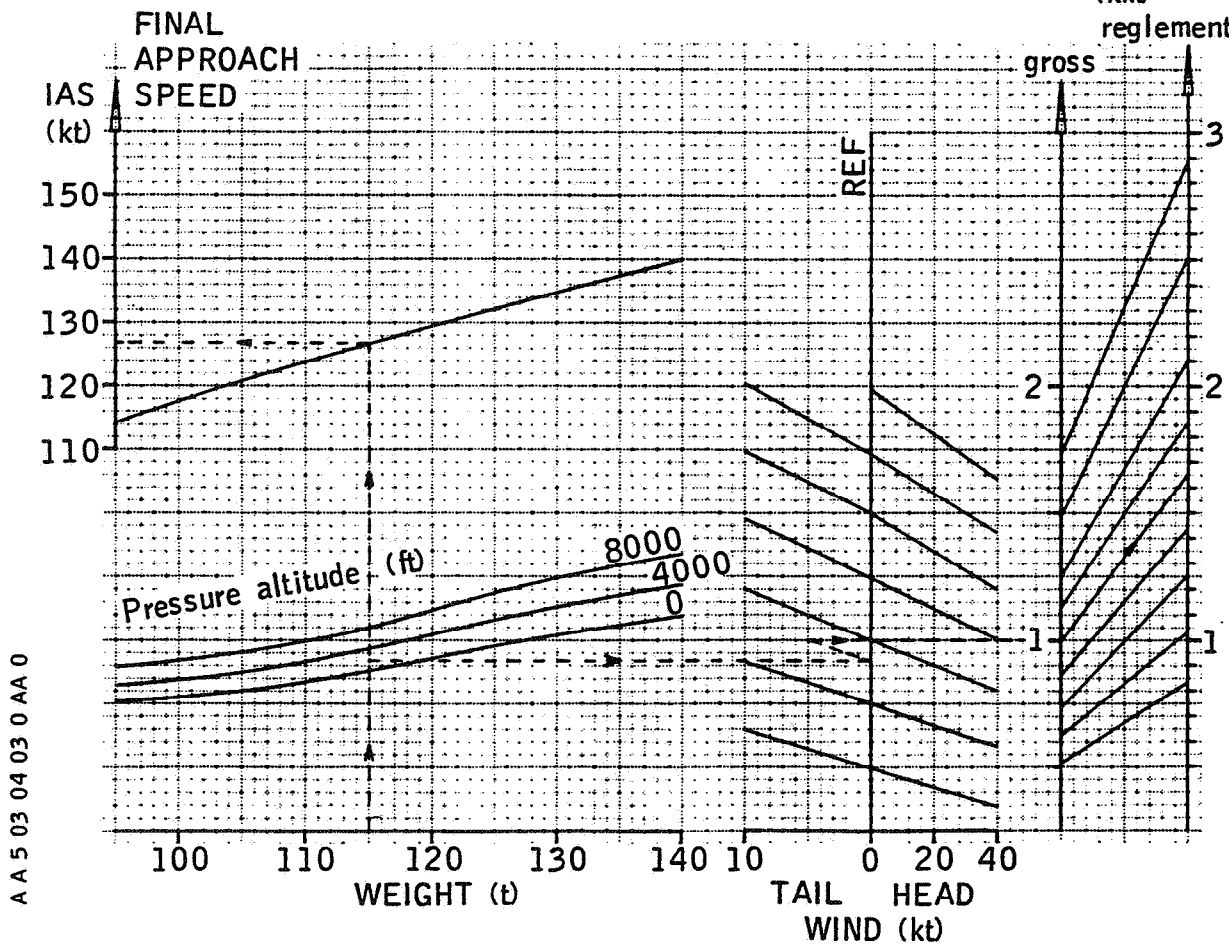

AA 5 03 04 03 0 AA 0

3.4 F.A.R. LANDING RUNWAY LENGTH REQUIREMENTS
3.4.3 FULL FLAPS
MODEL B 2

A 300
AIRPLANE CHARACTERISTICS

NOTE : THESE CURVES ARE GIVEN FOR INFORMATION ONLY.
THE APPROVED VALUES ARE STATED IN THE "OPERATING
MANUALS" SPECIFIC TO THE AIRLINE OPERATING THE AIRCRAFT.

SLATS 25° FLAPS 25°

VREF = 1.3 Vs

MAXIMUM
LANDING
WEIGHT

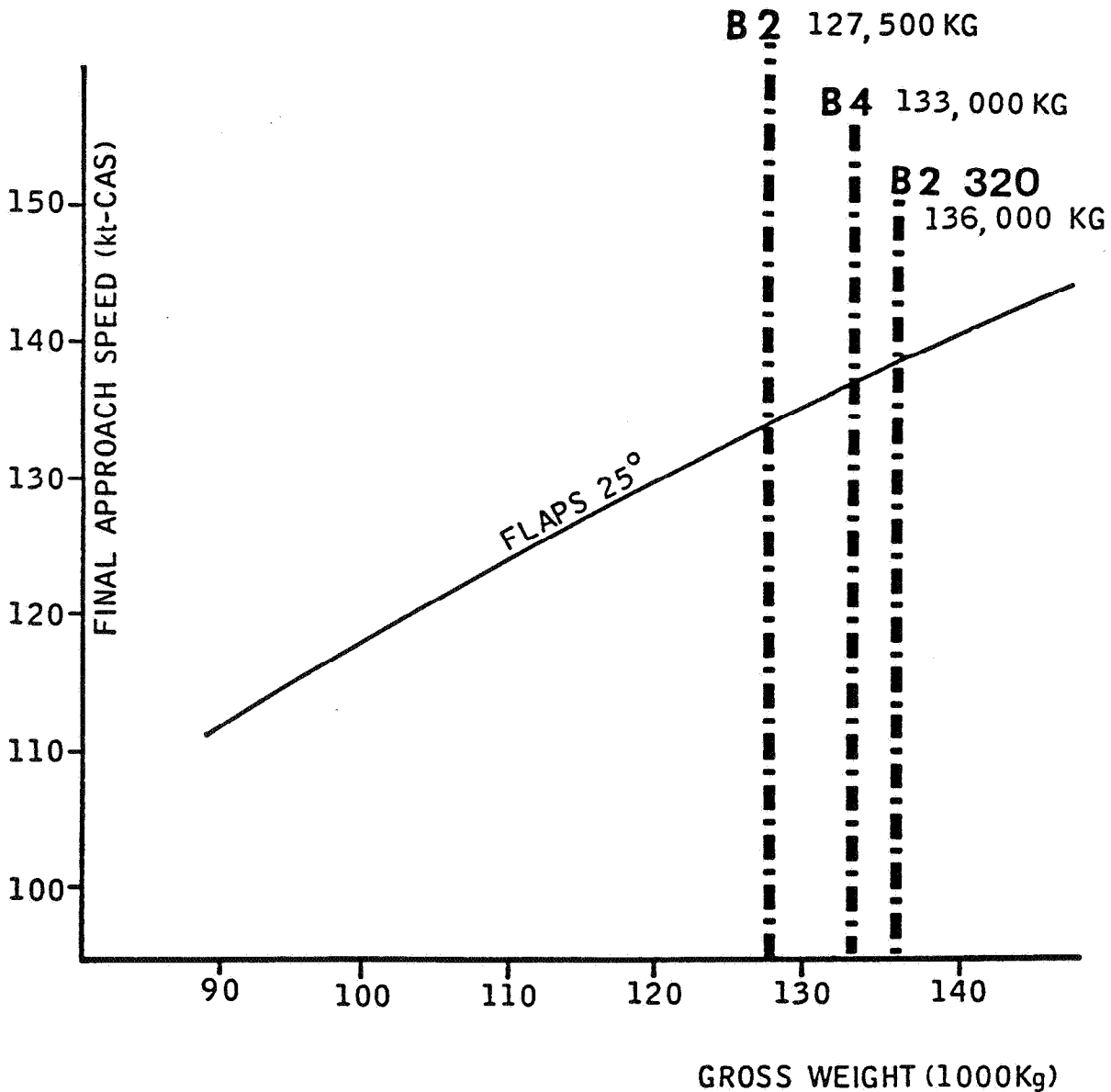

AA 5 03 05 01 0 AA 0

Printed in France

3.5 LANDING APPROACH SPEED
3.5.1 LANDING APPROACH SPEED (METRIC UNITS)
MODEL B2 - B4

A 300

AIRPLANE CHARACTERISTICS

NOTE : THESE CURVES ARE GIVEN FOR INFORMATION ONLY.
THE APPROVED VALUES ARE STATED IN THE "OPERATING
MANUALS" SPECIFIC TO THE AIRLINE OPERATING THE AIRCRAFT.

SLATS 25° FLAPS 25°

VREF = 1.3 Vs

MAXIMUM
LANDING
WEIGHT

C4 134,000 KG

Printed in France

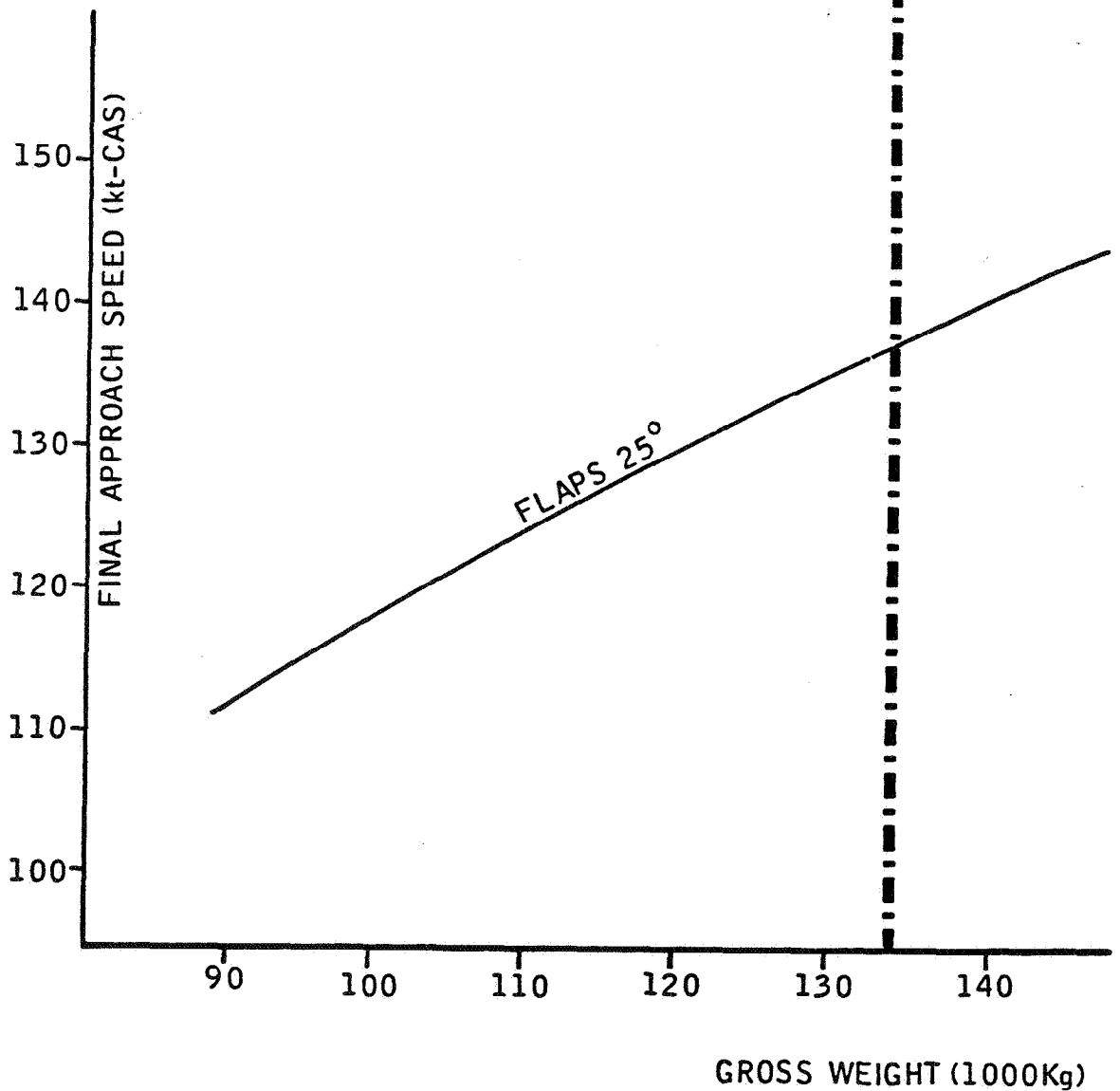

AA 5 03 05 01 0 AB 0

3.5 LANDING APPROACH SPEED
3.5.1 LANDING APPROACH SPEED (METRIC UNITS)
MODEL C4

A 300
AIRPLANE CHARACTERISTICS

NOTE : THESE CURVES ARE GIVEN FOR INFORMATION ONLY.
THE APPROVED VALUES ARE STATED IN THE "OPERATING
MANUALS" SPECIFIC TO THE AIRLINE OPERATING THE AIRCRAFT.

SLATS 25° FLAPS 25°
VREF = 1.3 Vs

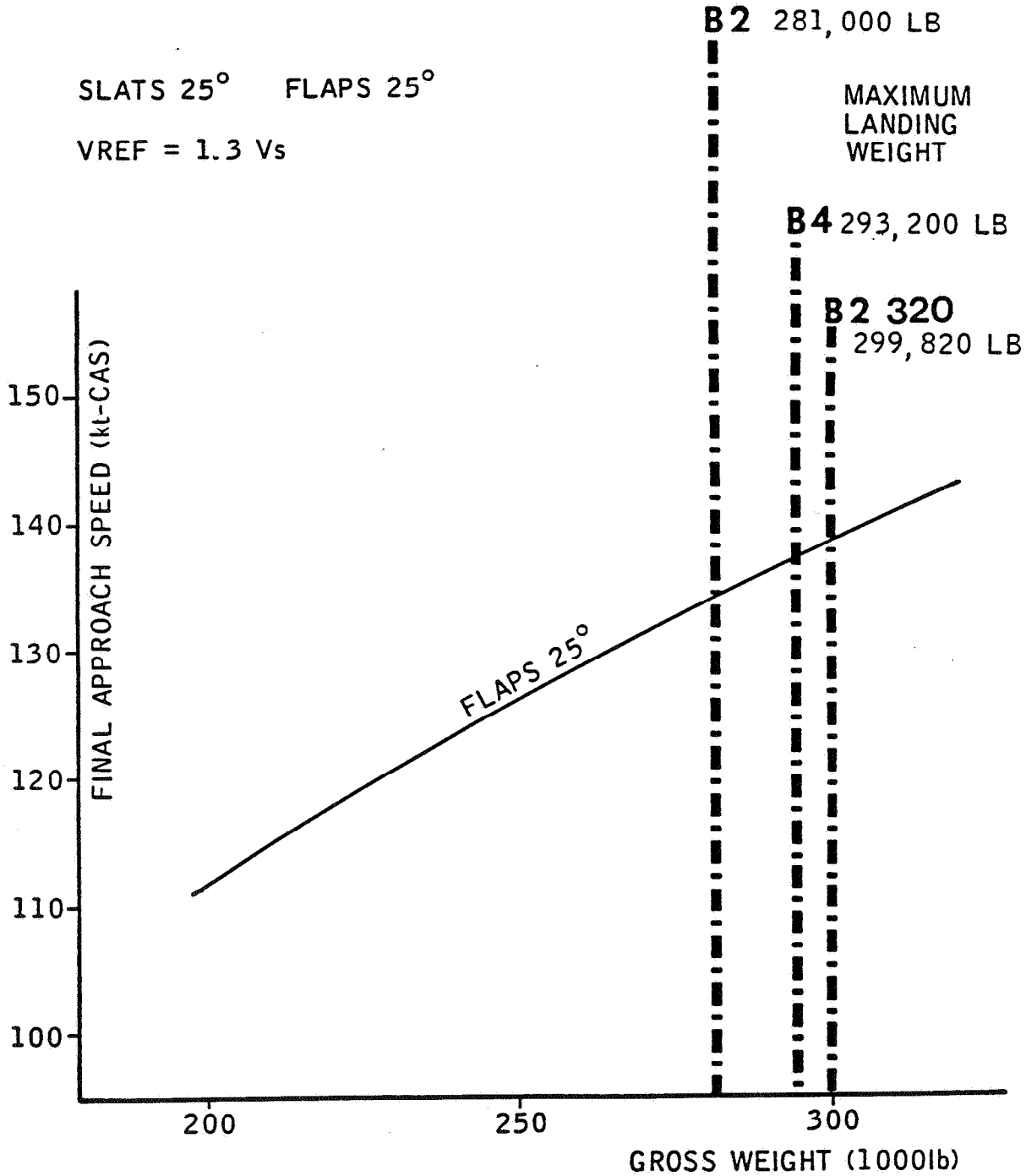

Printed in France

AA 5 03 05 02 0 AA 0

3.5 LANDING APPROACH SPEED
3.5.2 LANDING APPROACH SPEED (U.S. UNITS)
MODEL B2 - B4

A 300
AIRPLANE CHARACTERISTICS

NOTE : THESE CURVES ARE GIVEN FOR INFORMATION ONLY.
THE APPROVED VALUES ARE STATED IN THE "OPERATING
MANUALS" SPECIFIC TO THE AIRLINE OPERATING THE AIRCRAFT.

SLATS 25° FLAPS 25°

VREF = 1.3 Vs

MAXIMUM
LANDING
WEIGHT

C4 295,410 LB

Printed in France

AA 5 03 05 02 0 AB 0

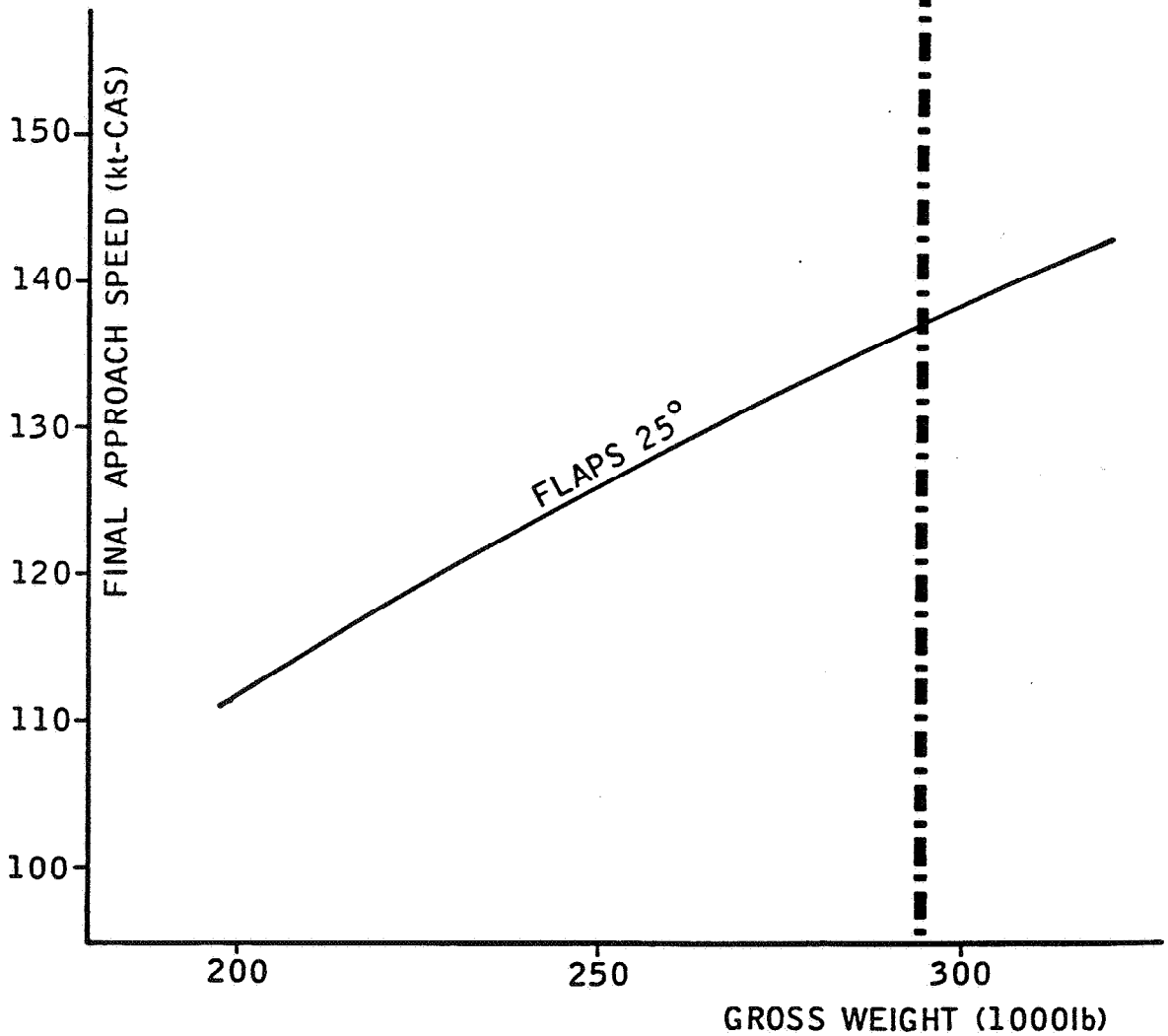

3.5 LANDING APPROACH SPEED
3.5.2 LANDING APPROACH SPEED (U.S. UNITS)
MODEL C4

A 300
AIRPLANE CHARACTERISTICS

- 4.0 GROUND MANEUVERING
- 4.1 Turning radii - No slip angle
- 4.2 Minimum turning radii
- 4.3 Visibility from cockpit in static position
- 4.4 Runway and taxiway turnpaths
 - 4.4.1 More than 90° turn runway to taxiway
 - 4.4.2 90° turn runway to taxiway
 - 4.4.3 90° turn taxiway to taxiway
- 4.5 Runway holding apron
- 4.6 Minimum parking space requirement
 - 4.6.1 Minimum parking space requirements (U.S. units)
 - 4.6.2 Minimum parking space requirements (Metric units)

Printed in France

A 300

AIRPLANE CHARACTERISTICS

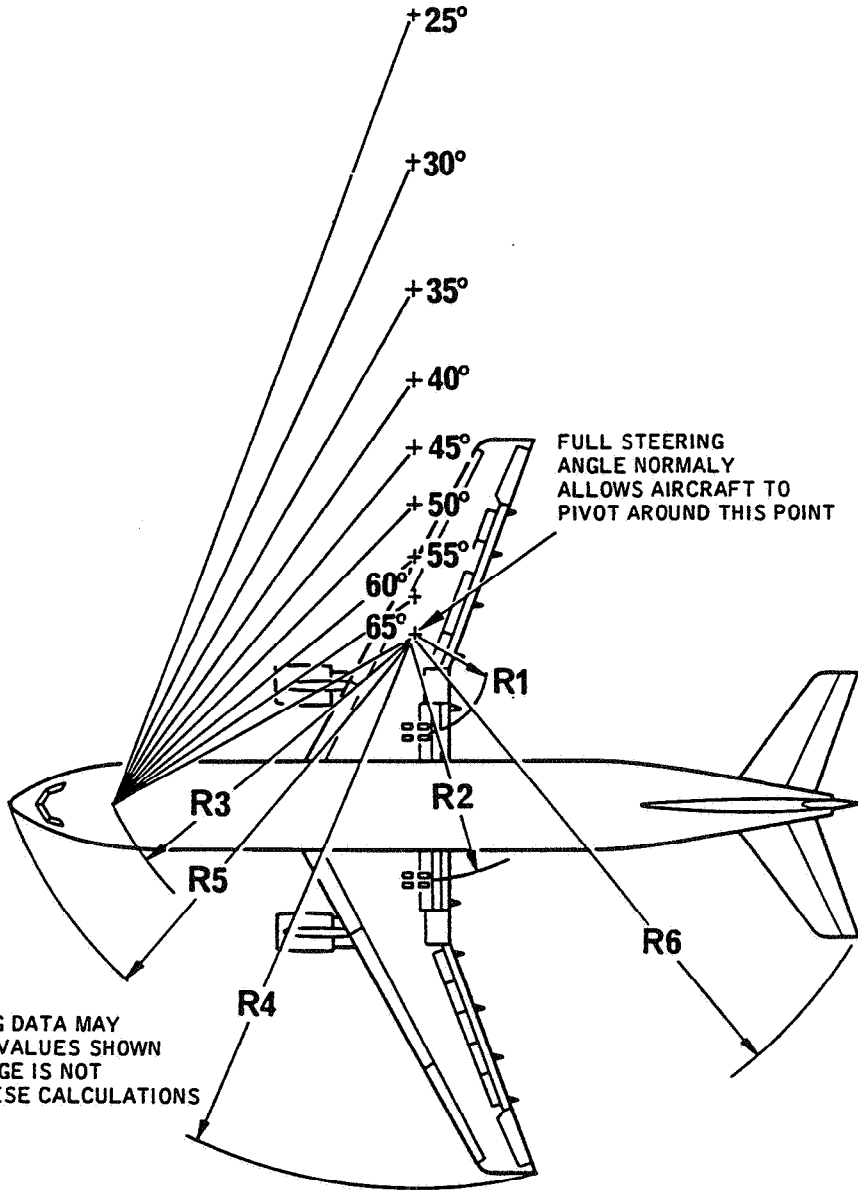

Printed in France

STEERING ANGLE (°)	R1		R2		R3		R4		R5		R6	
	FT	M	FT	M	FT	M	FT	M	FT	M	FT	M
30	90.51	27.59	122.01	37.19	122.70	37.40	181.37	55.28	134.78	41.08	163.14	49.73
35	71.87	21.90	103.36	31.50	106.95	32.60	162.91	49.65	120.63	36.77	148.21	45.17
40	57.36	17.48	88.86	27.08	95.44	29.09	148.58	45.29	110.55	33.70	137.21	41.82
45	45.60	13.90	77.10	23.50	86.76	26.44	136.98	41.75	103.15	31.44	128.81	39.26
50	35.73	10.89	67.22	20.49	80.09	24.41	127.27	38.79	97.60	29.75	122.19	37.24
55	27.21	8.29	58.70	17.89	74.89	22.83	118.91	36.24	93.39	28.46	116.84	35.61
60	19.67	6.00	51.17	15.60	70.84	21.59	113.53	34.00	90.17	27.48	112.44	34.27
65	12.86	3.92	44.35	13.52	67.69	20.63	104.89	31.97	87.72	26.74	108.75	33.15

4.1 TURNING RADII NO SLIP ANGLE
MODEL B2 - B4 - C4

A A 5 04 01 00 0 AF 0

A 300
AIRPLANE CHARACTERISTICS

Printed in France

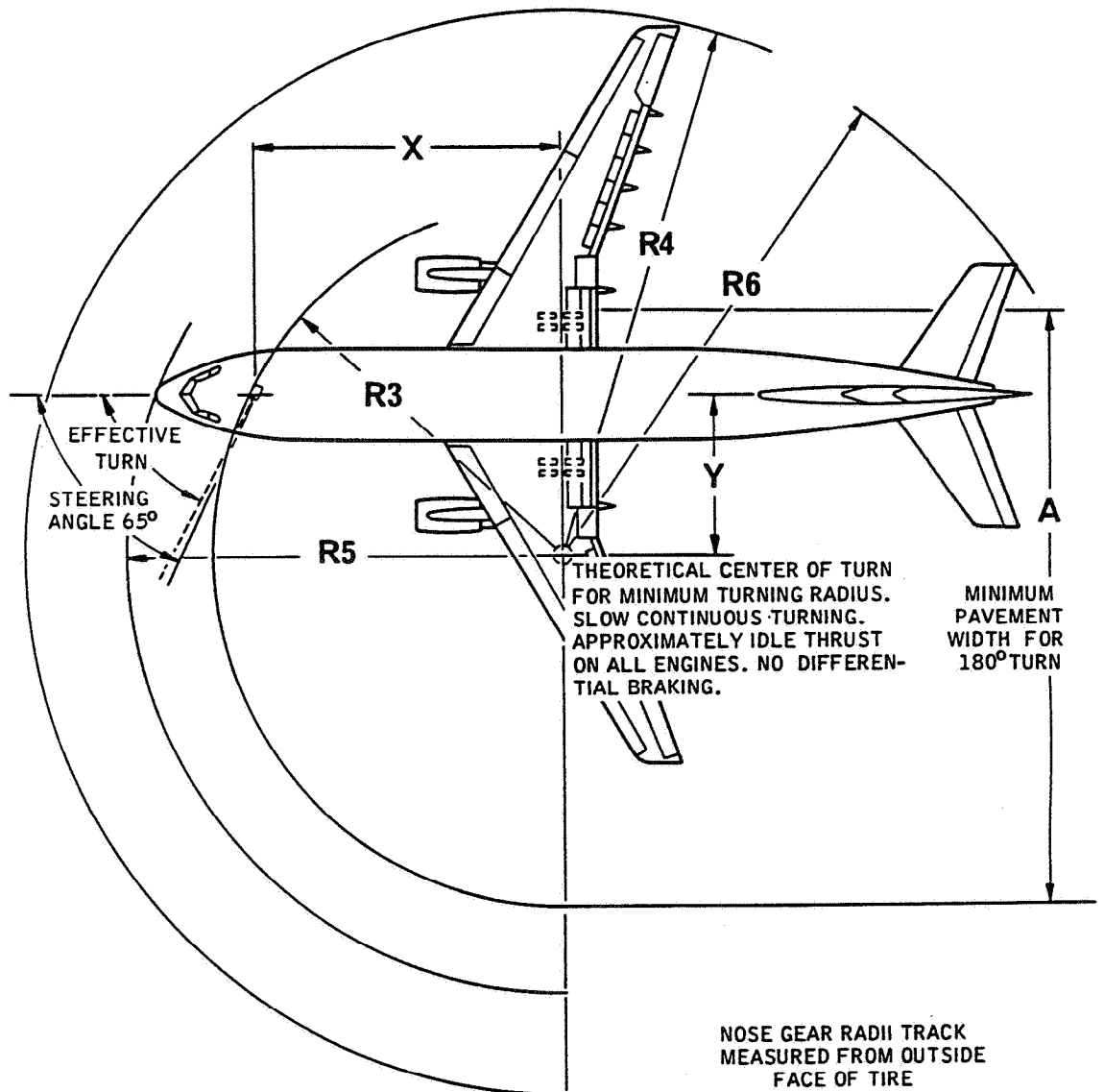

C.G. A C	EFFECTIVE TURN ANGLE	X	Y	A	R3	R4	R5	R6
FWD 15%	61° 64	61.35 18.70	33.11 10.09	122.26 37.26	69.71 21.25	109.27 33.31	89.29 27.21	111.15 33.88
AFT 33%	58° 74	61.35 18.70	37.23 11.35	128.44 39.15	71.77 21.88	113.31 34.54	90.90 27.71	113.47 34.58

A A 5 04 02 00 0 AF 0

4.2 MINIMUM TURNING RADII
MODEL B2 - B4 - C4

A 300

AIRPLANE CHARACTERISTICS

NOT TO BE USED FOR
LANDING APPROACH VISIBILITY

PILOT EYE ORIENTATION WITH GROUND

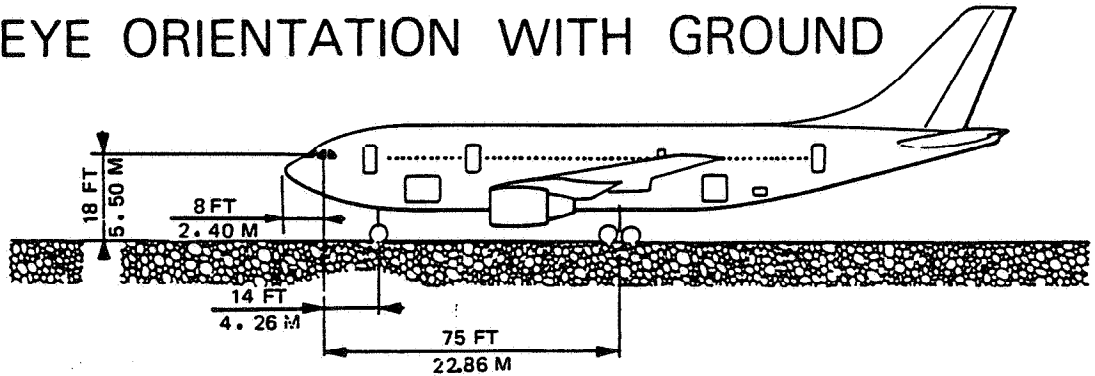

PILOT VISION

● EYE REF. POINT

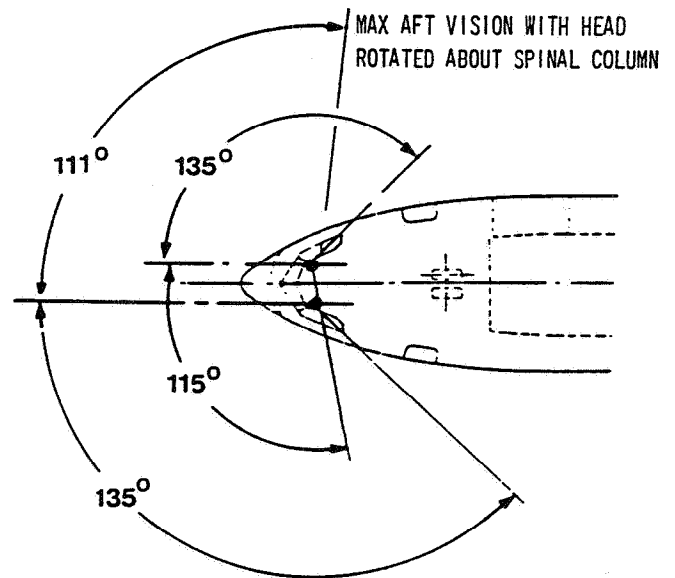
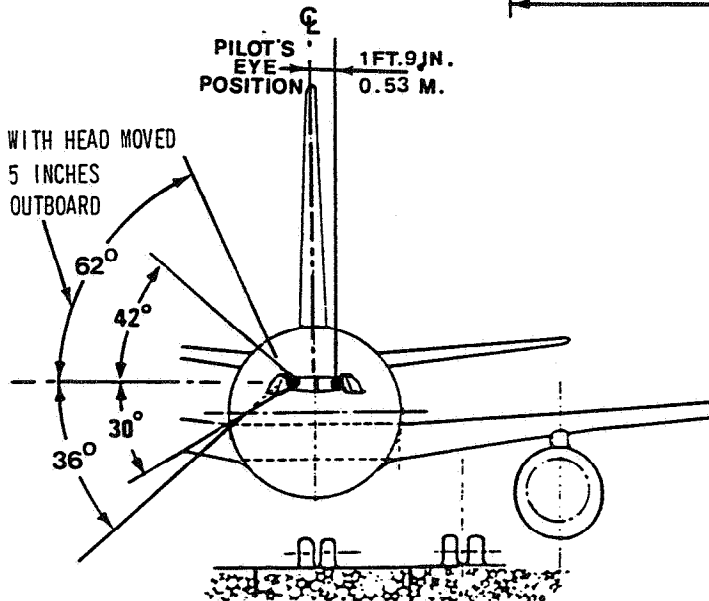
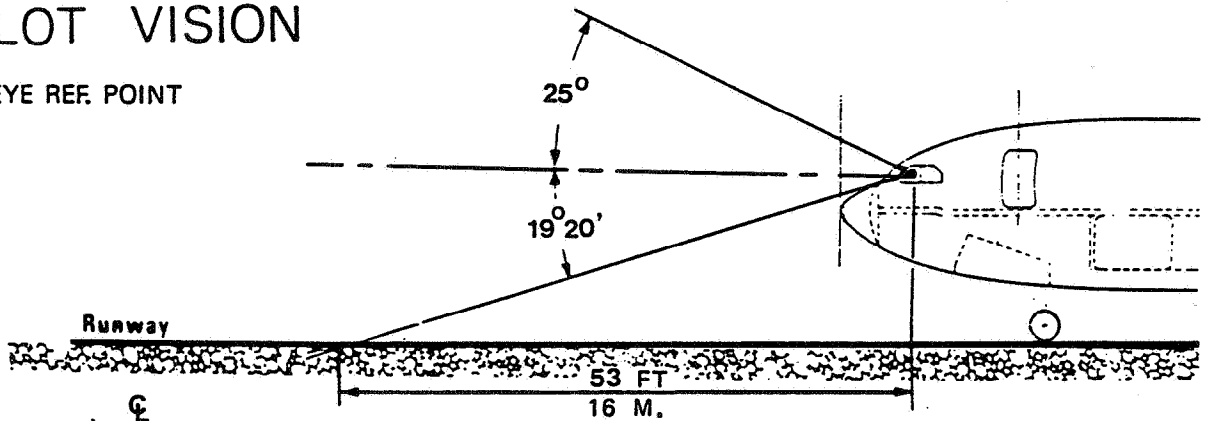

4.3 VISIBILITY FROM COCKPIT IN STATIC POSITION
MODEL B2 - B4 - C4

Printed in France

AA 5 04 03 00 0 AA 0

A 300

AIRPLANE CHARACTERISTICS

Printed in France

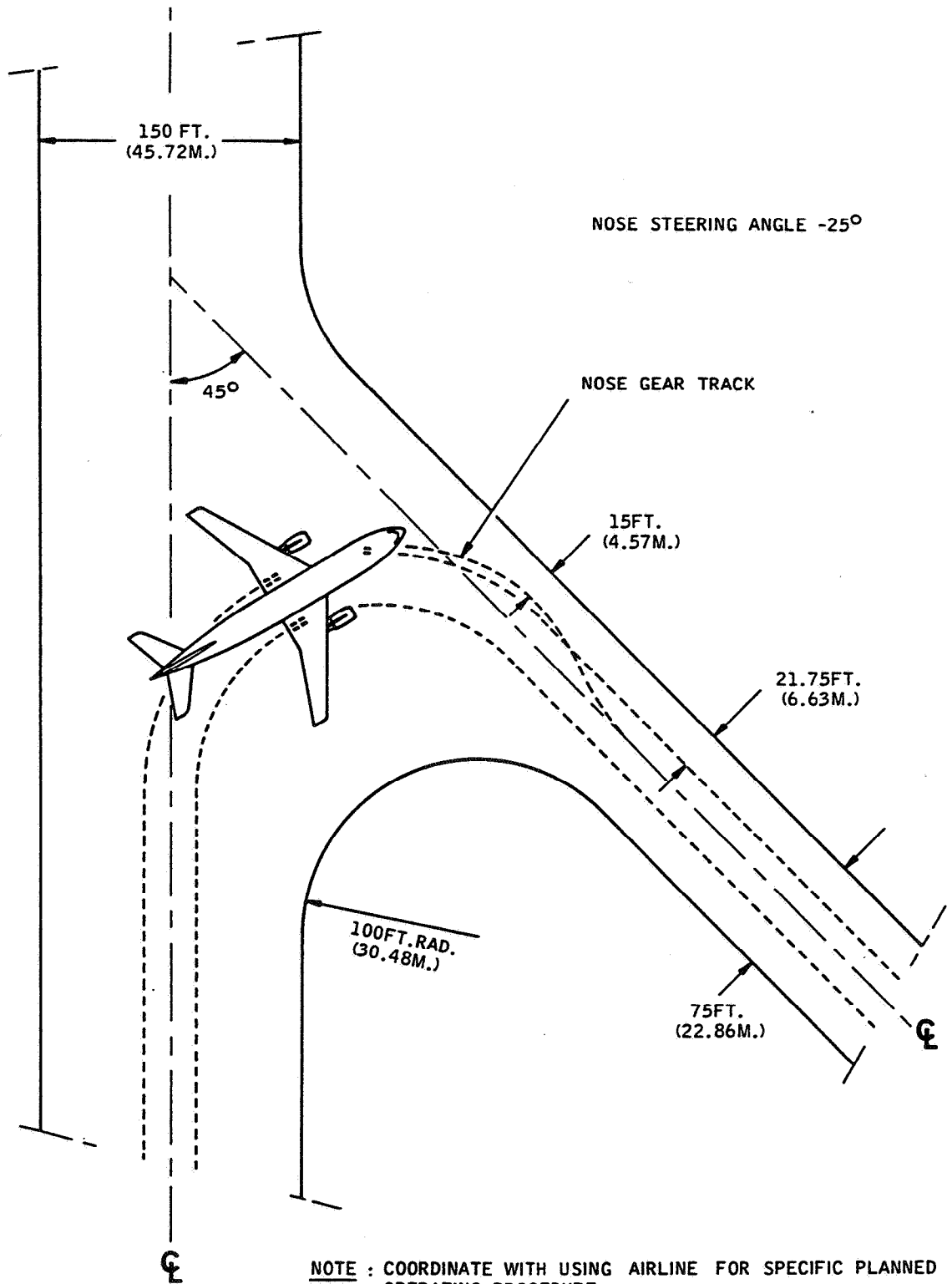

AA 5 04 04 01 0 AA 0

4.4 RUNWAY AND TAXIWAY TURN PATHS

4.4.1 MORE THAN 90° TURN RUNWAY TO TAXIWAY

MODEL B2 - B4 - C4

A 300

AIRPLANE CHARACTERISTICS

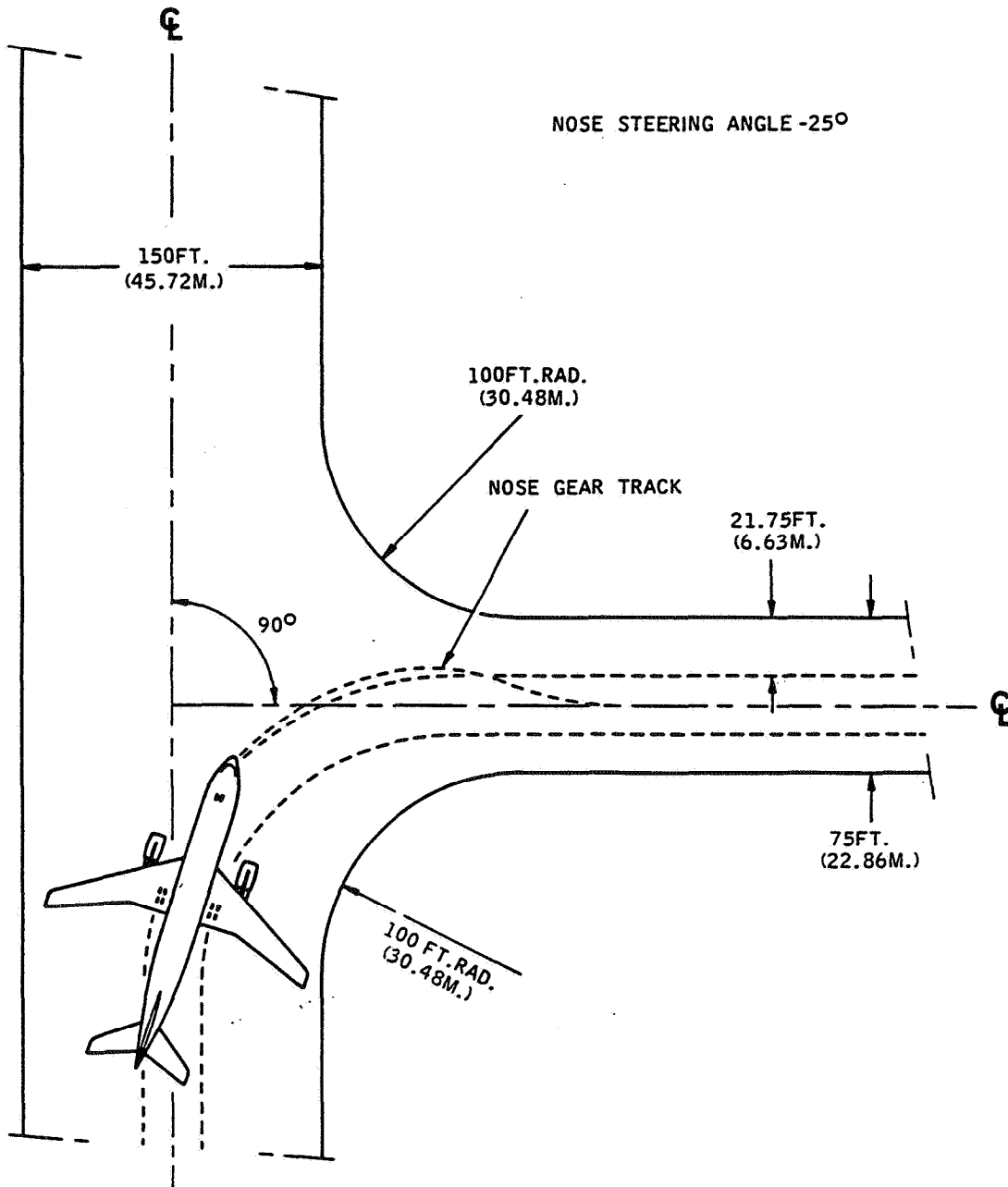

Printed in France

AA 5 04 04 02 0 AA C

NOTE : COORDINATE WITH USING AIRLINE FOR SPECIFIC PLANNED OPERATING PROCEDURE

4.4 RUNWAY AND TAXIWAY TURN PATHS
4.4.2 90° TURN RUNWAY TO TAXIWAY
MODEL B2 - B4 - C4

A 300

AIRPLANE CHARACTERISTICS

Printed in France

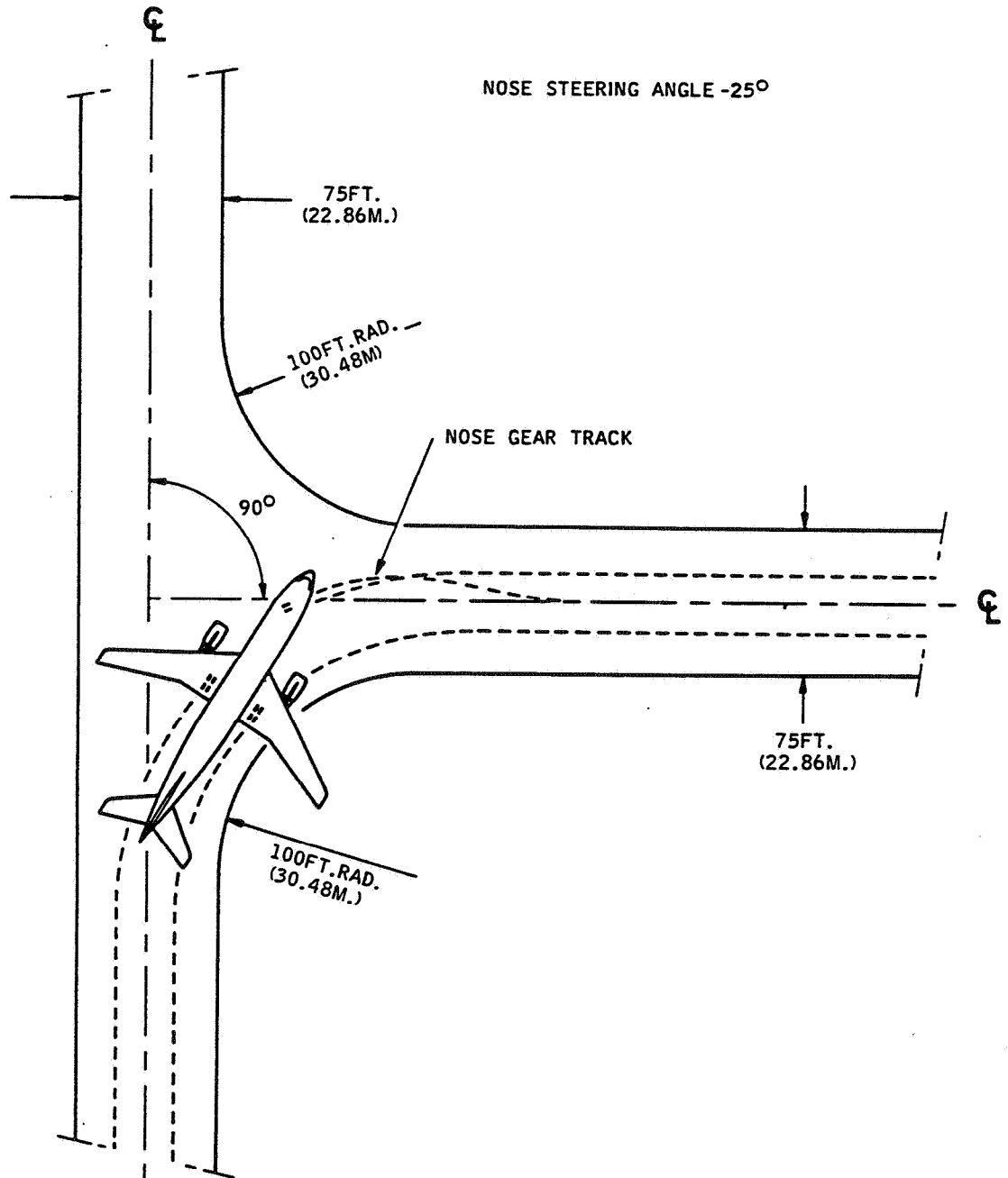

A A 5 04 04 03 0 AA 0

NOTE : COORDINATE WITH USING AIRLINE FOR SPECIFIC PLANNED OPERATING PROCEDURE

4.4 RUNWAY AND TAXIWAY TURN PATHS
4.4.3 90° TURN TAXIWAY TO TAXIWAY
MODEL B2 - B4 - C4

A 300

AIRPLANE CHARACTERISTICS

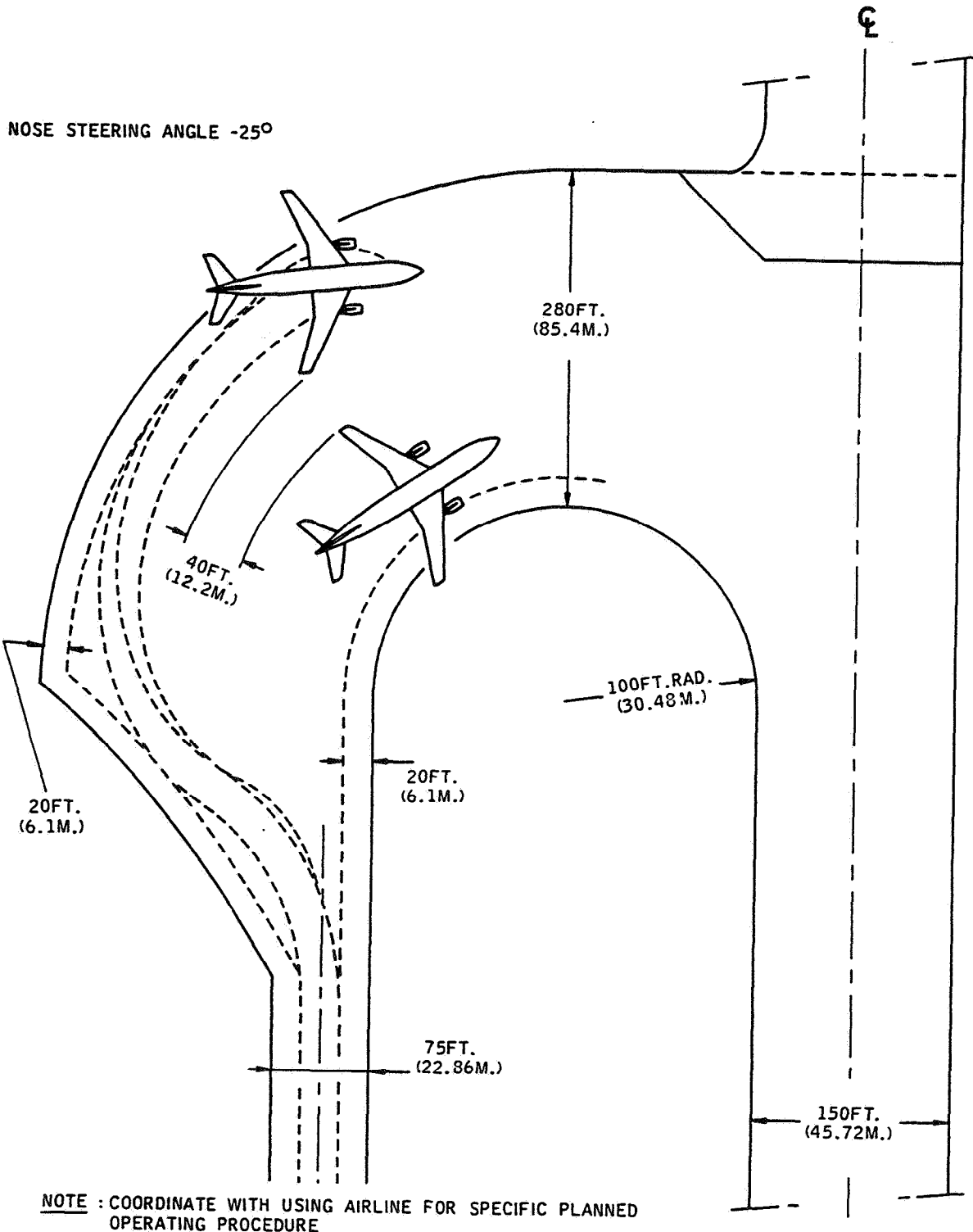

Printed in France

A A 5 04 04 00 0 AM 0
A 09 5 B P008 01 00 A

4.5 RUNWAY HOLDING APRON MODEL B2 - B4 - C4

A 300

AIRPLANE CHARACTERISTICS

4.5 Minimum Parking Space Requirements

The following charts show the rectangle space required for parking against the terminal building, chart 4.5.1 is in feet and chart 4.5.2 in meters.

The rectangle includes allowance for swinging the airplane on arrival and departure. Four parking and departure techniques are considered, as follows :

(a) Nose in (Tow Out)

The A300 taxis in at right angles to the terminal and halts with the radome 15 feet (4.57 meters) away from it. On departure it is towed out backwards at right angles to the terminal. An allowance of 25 feet (7.62 meters) span-wise is added for clearance from other airplane.

(b) Parallel (Power Out)

The A300 taxis in a right angles to the terminal then swings with maximum nose wheel steering (65°) to achieve minimum turning radius as shown in chart 4-2, halting when the fuselage centerline lies parallel to the terminal after a 10 feet (3.05 meters) taxiing straight forward. On departure it taxis 10 feet (3.05 meters) straight forward, then swings with maximum nose wheel steering (65°) until facing at right angles away from the terminal. Clearance of at least 25 feet (7.62 meters) is maintained between the A300 and the terminal, the critical part being the wing tip during the arrival swing.

An allowance of 25 feet (7.62 meters) parallel to the terminal is added for clearance from other airplane, the critical parts of the A300 being the tail cone during the arrival swing and the wing tip on departure.

(c) 45° Angle In (Power Out)

The same procedure is followed as in the last case, except that the A300 halts with its fuselage centerline at 45° to the terminal. Clearance and allowance are the same.

(d) 45° Angle In (Tow Out)

The same procedure is followed as in the last case, except that on departure the A300 is towed with maximum nose wheel steering with a 10 feet (3.05 meters) initial straight run. Clearance and allowance are the same.

A 300
AIRPLANE CHARACTERISTICS

NOTES: 65° NOSE WHEEL STEERING (POWER OUT)

7,6 METER BUILDING CLEARANCE FOR OTHER PARKING POSITIONS.

3 METER TRAVEL WITH NOSE WHEEL STRAIGHT AHEAD BEFORE AND AFTER PARKED POSITION.

7,6 METER AIRPLANE TO AIRPLANE CLEARANCE DURING PARKING MANEUVERS.

4,5 METER BUILDING CLEARANCE FOR NOSE-IN PARKING

COORDINATE WITH USING AIRLINE FOR SPECIFIC PLANNED OPERATING PROCEDURE.

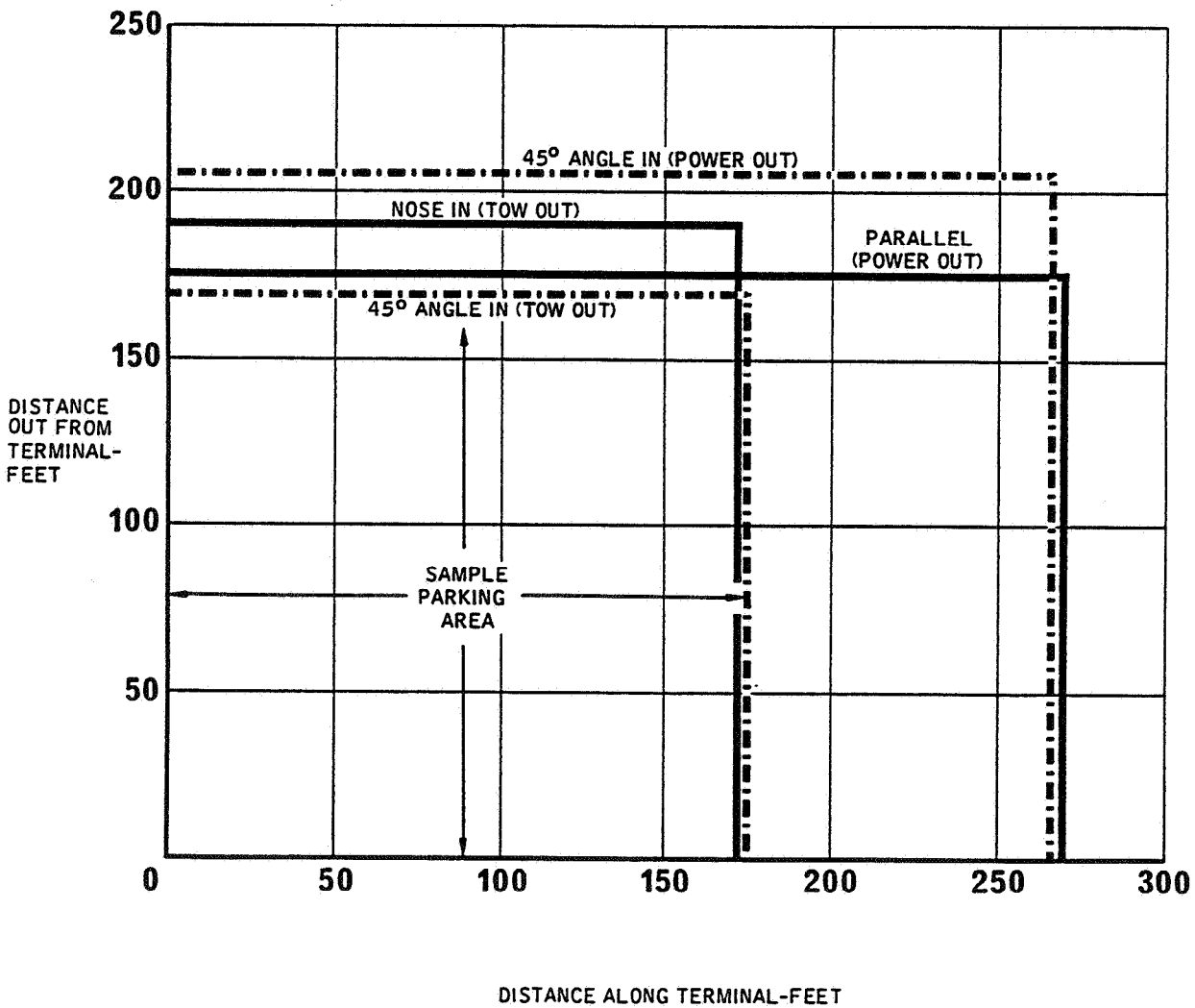

AA 5 04 06 01 0 AA 0

Printed in France

4.6 MINIMUM PARKING SPACE REQUIREMENTS
4.6.1 MINIMUM PARKING SPACE REQUIREMENTS (U.S. UNITS)
MODEL B2 - B4 - C4

A 300
AIRPLANE CHARACTERISTICS

NOTES : 65° NOSE WHEEL STEERING
(POWER OUT)

7,6 METER BUILDING
CLEARANCE FOR OTHER
PARKING POSITIONS

3 METER TRAVEL WITH
NOSE WHEEL STRAIGHT
AHEAD BEFORE AND
AFTER PARKED POSITION

7,6 METER AIRPLANE TO
AIRPLANE CLEARANCE DURING
PARKING MANEUVERS

4,5 METER BUILDING
CLEARANCE FOR NOSE-IN
PARKING

COORDINATE WITH USING
AIRLINE FOR SPECIFIC
PLANNED OPERATING
PROCEDURE

Printed in France

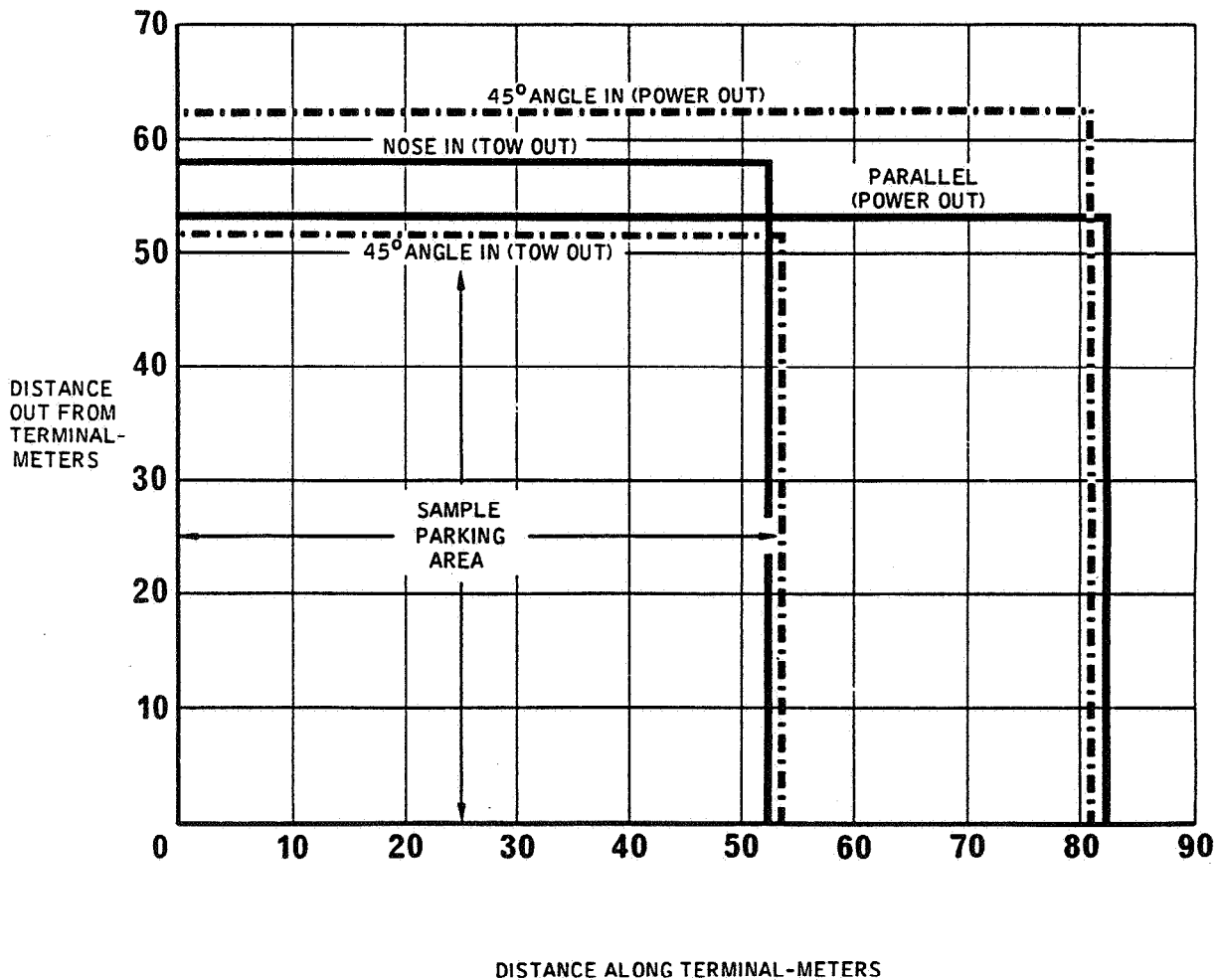

A A 5 04 06 02 0 AA 0

4.6 MINIMUM PARKING SPACE REQUIREMENTS
4.6.2 MINIMUM PARKING SPACE REQUIREMENTS (METRIC UNITS)
MODEL B2 - B4 - C4

- 5.0 TERMINAL SERVICING
- 5.1 Airplane servicing arrangement
 - 5.1.1 Symbols used on servicing diagrams
 - 5.1.2 Open apron free standing - APU running
 - 5.1.3 Open apron free standing - APU not running
 - 5.1.4 Two passenger gangways - Parallel - APU running
 - 5.1.5 Three passenger gangways - Nose In - APU not running
 - 5.1.6 Three passenger gangways - Double parallel - APU running
 - R 5.1.7 Open apron free standing - APU running
 - R 5.1.8 Three passengers gangways - Nose In - APU running
- 5.2 Terminal operation
 - 5.2.1 Turnround station (30 minutes - 1 door open)
 - 5.2.2 Turnround station (30 minutes - 2 doors open)
 - 5.2.3 Turnround station (30 minutes - 3 doors open)
 - 5.2.4 Turnround station (30 minutes - Freight mode)
- 5.3 Terminal operation
 - 5.3.1 Enroute station (20 minutes - 3 doors open)
- 5.4 Ground service connections
 - 5.4.1 Ground service connections data
 - 5.4.2 Ground service connections layout
 - 5.4.3 Hydraulic system
 - 5.4.4 Electrical system
 - 5.4.5 Oxygen system
 - 5.4.6 Fuel system
 - 5.4.7 Pneumatic system
 - 5.4.8 Oil system
 - 5.4.9 Potable water system
 - 5.4.10 Toilet system
- 5.5 Engine starting pneumatic requirements
 - 5.5.1 Ambient temperature -40°F (-40°C)
 - 5.5.2 Ambient temperature +60°F (+15°C)
 - 5.5.3 Ambient temperature +100°F (+38°C)
- 5.6 Ground pneumatic power requirements
 - 5.6.1 Heating (U.S. units)
 - 5.6.2 Heating (Metric units)
 - 5.6.3 Cooling (U.S. units)
 - 5.6.4 Cooling (Metric units)
- 5.7 Preconditioned airflow requirements
 - 5.7.1 U.S. units
 - 5.7.2 Metric units
- 5.8 Ground towing requirements
 - 5.8.1 U.S. units
 - 5.8.2 Metric units

APU	-	AUXILIARY POWER UNIT
AS	-	AIR STARTING VEHICLE
BC	-	BAGGAGE CONTAINER TRAIN
C	-	CABIN CLEANING TRUCK
CL	-	CONTAINER LOADER
CS	-	CABIN CLEANERS STEPS
F	-	REFUELING VEHICLE
FC	-	FREIGHT CONTAINER TRAIN
FL	-	BULK FREIGHT LOADER
FR	-	BULK FREIGHT VEHICLE
G	-	GALLEY LOADING VEHICLE
GC	-	PRECONDITIONED AIR GROUND TRUCK
GPU	-	GROUND POWER UNIT
PS	-	PASSENGER ACCESS STEPS
T	-	TOILET SERVICING VEHICLE
W	-	WATER REPLENISHMENT VEHICLE
CT	-	CONTAINER TRANSPORTER

* NOTE : WHEN USING A FUEL TANKER THE SAFETY ZONE CLEARANCES MUST BE IN ACCORDANCE WITH LOCAL/AIRPORT REGULATIONS.

5.1 AIRPLANE SERVICING ARRANGEMENT
5.1.1 SYMBOLS USED ON SERVICING DIAGRAMS
MODEL B2 - B4 - C4

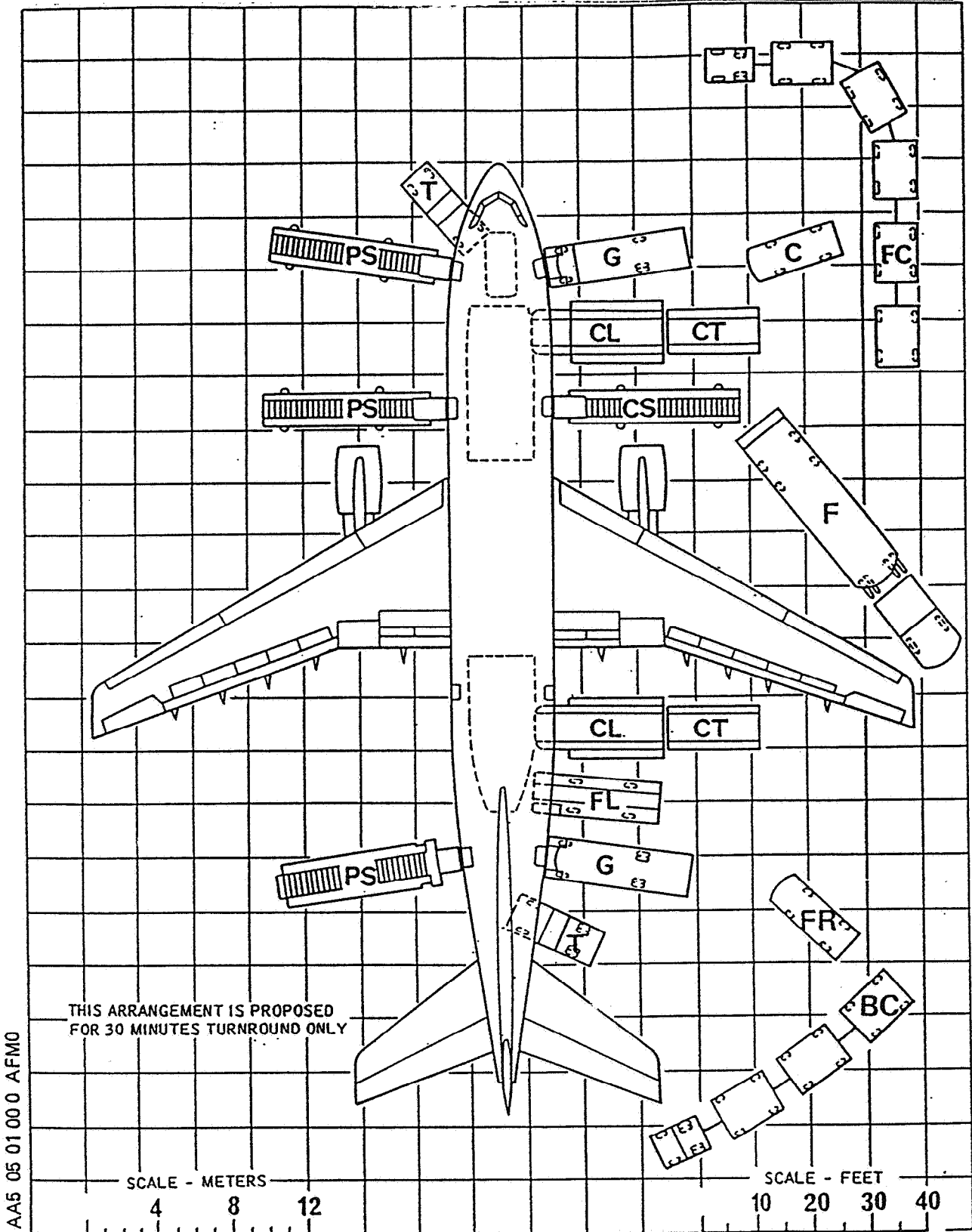

5.1 AIRPLANE SERVICING ARRANGEMENT
5.1.2 OPEN APRON FREE STANDING - APU RUNNING
MODEL B2 - B4 - C4 PASS

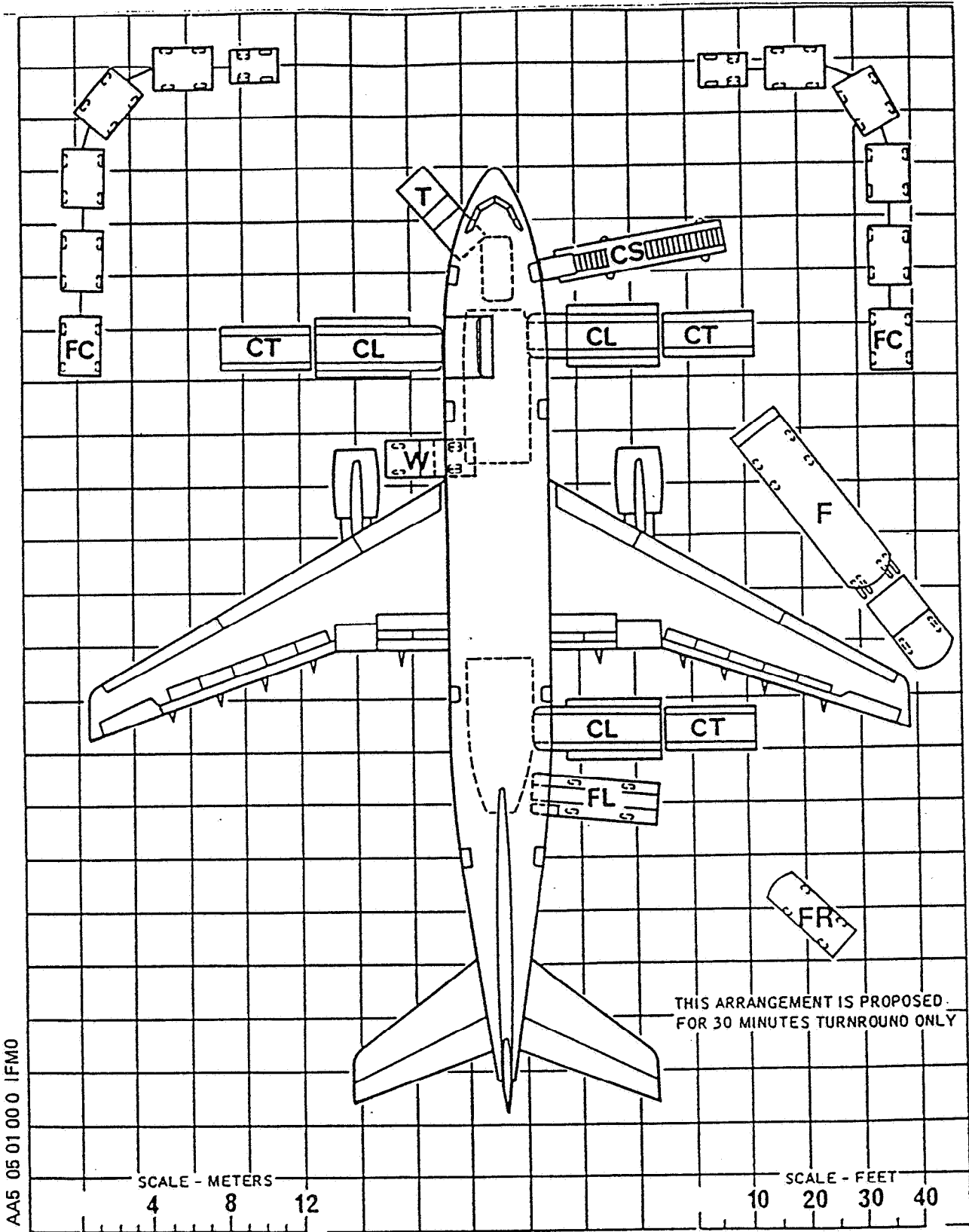

AA5 05 01 00 0 IFMO

5.1 AIRPLANE SERVICING ARRANGEMENT
5.1.1 OPEN APRON FREE STANDING - APU RUNNING
MODEL C4 FREIGHT

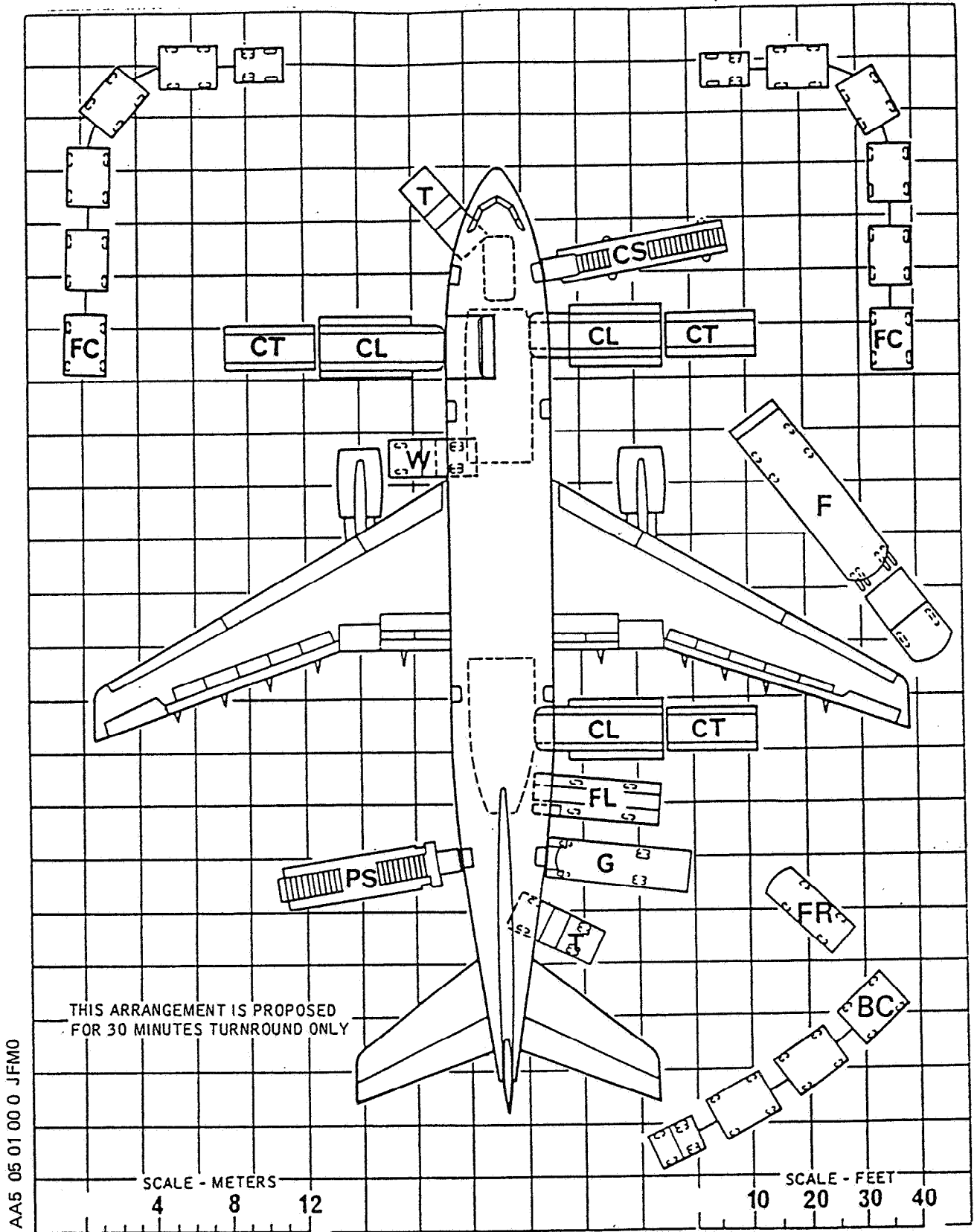

5.1 AIRPLANE SERVICING ARRANGEMENT
 5.1.2 OPEN APRON FREE STANDING - APU RUNNING
 MODEL C4 FREIGHT/PASSENGER

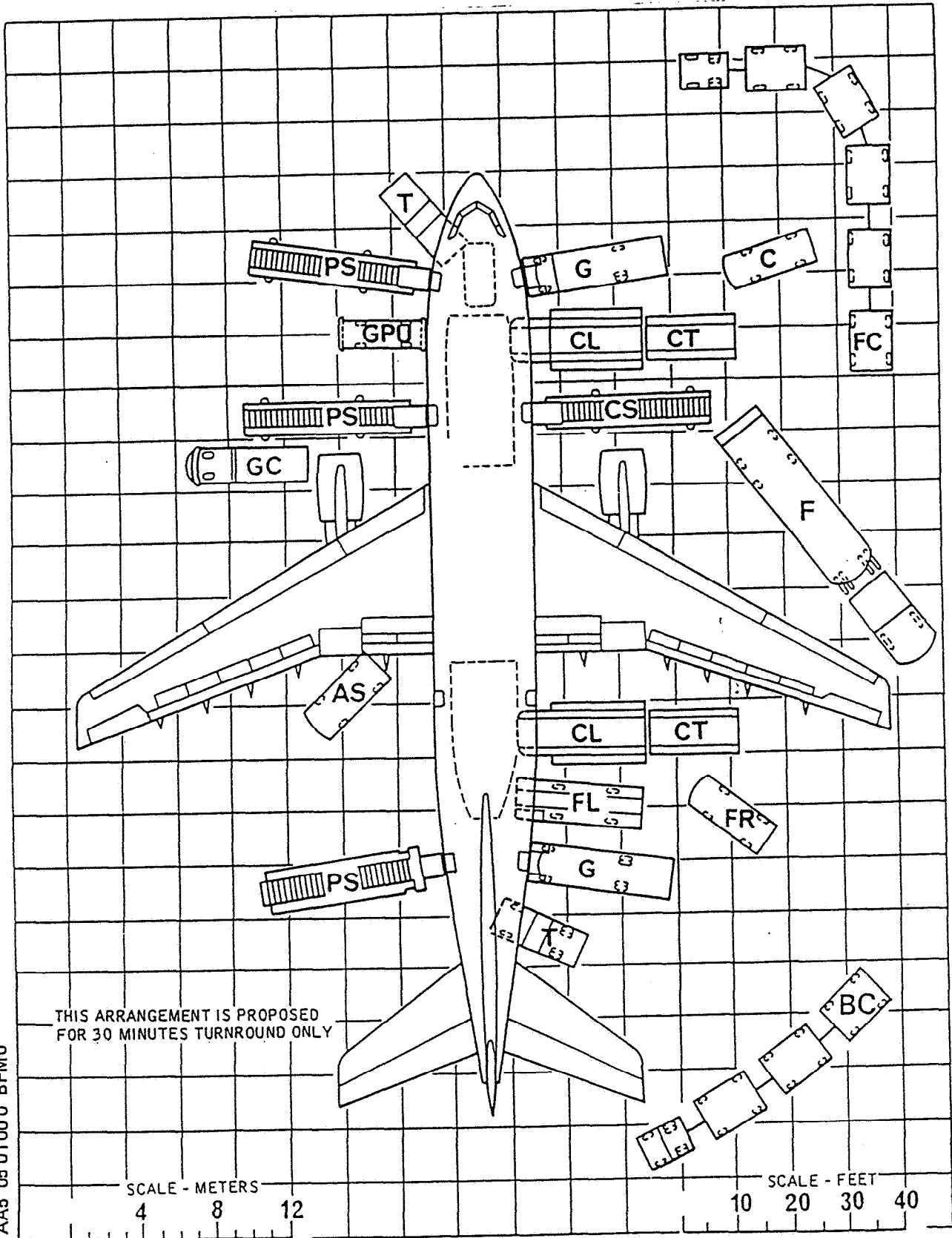

AA5 05 01000 BFM0

5.1 AIRPLANE SERVICING ARRANGEMENT
5.1.3 OPEN APRON FREE STANDING - APU NOT RUNNING
MODEL B2 - B4 - C4 PASS

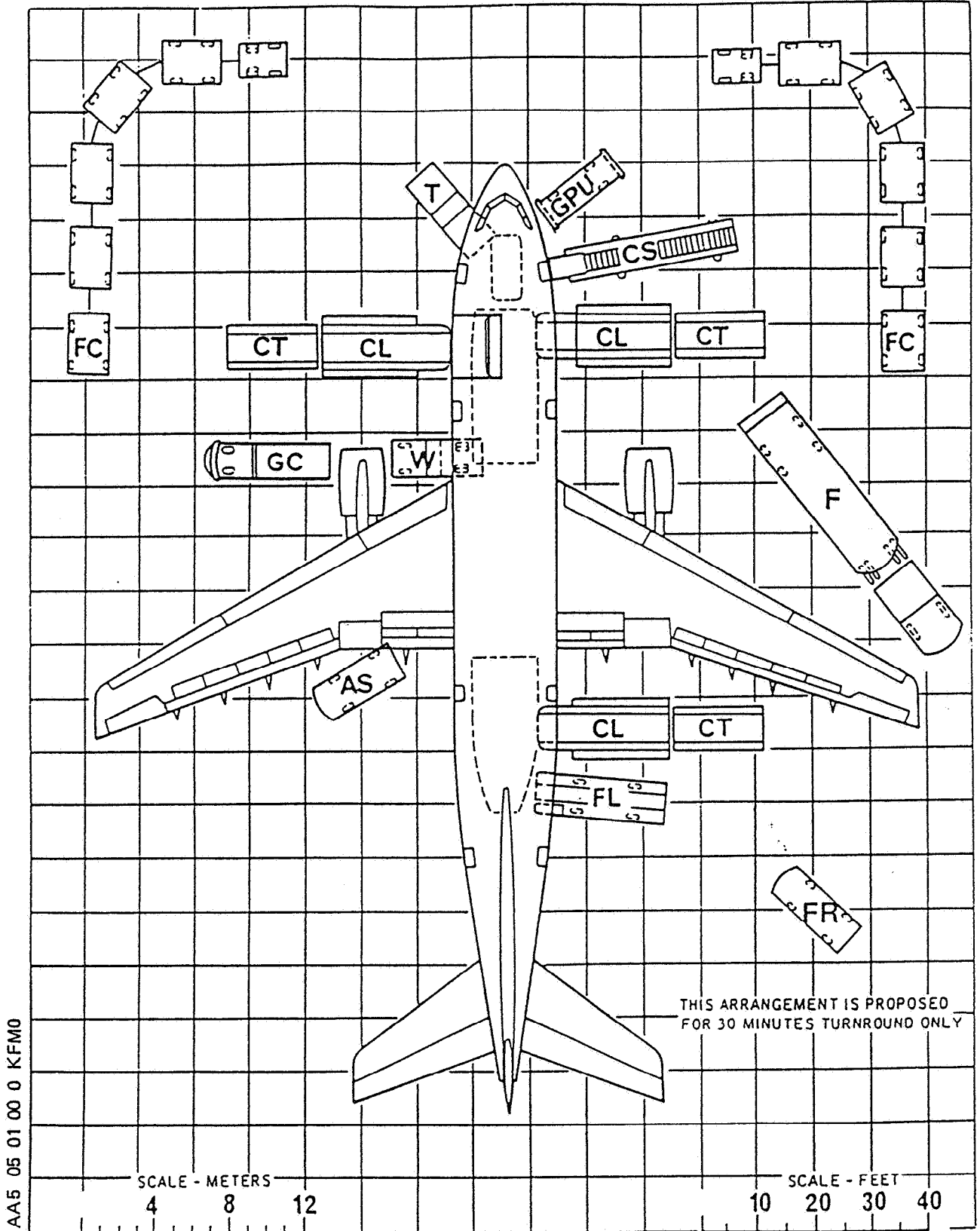

5.1 AIRPLANE SERVICING ARRANGEMENT
 5.1.3 OPEN APRON FREE STANDING - APU NOT RUNNING
 MODEL C4 FREIGHT

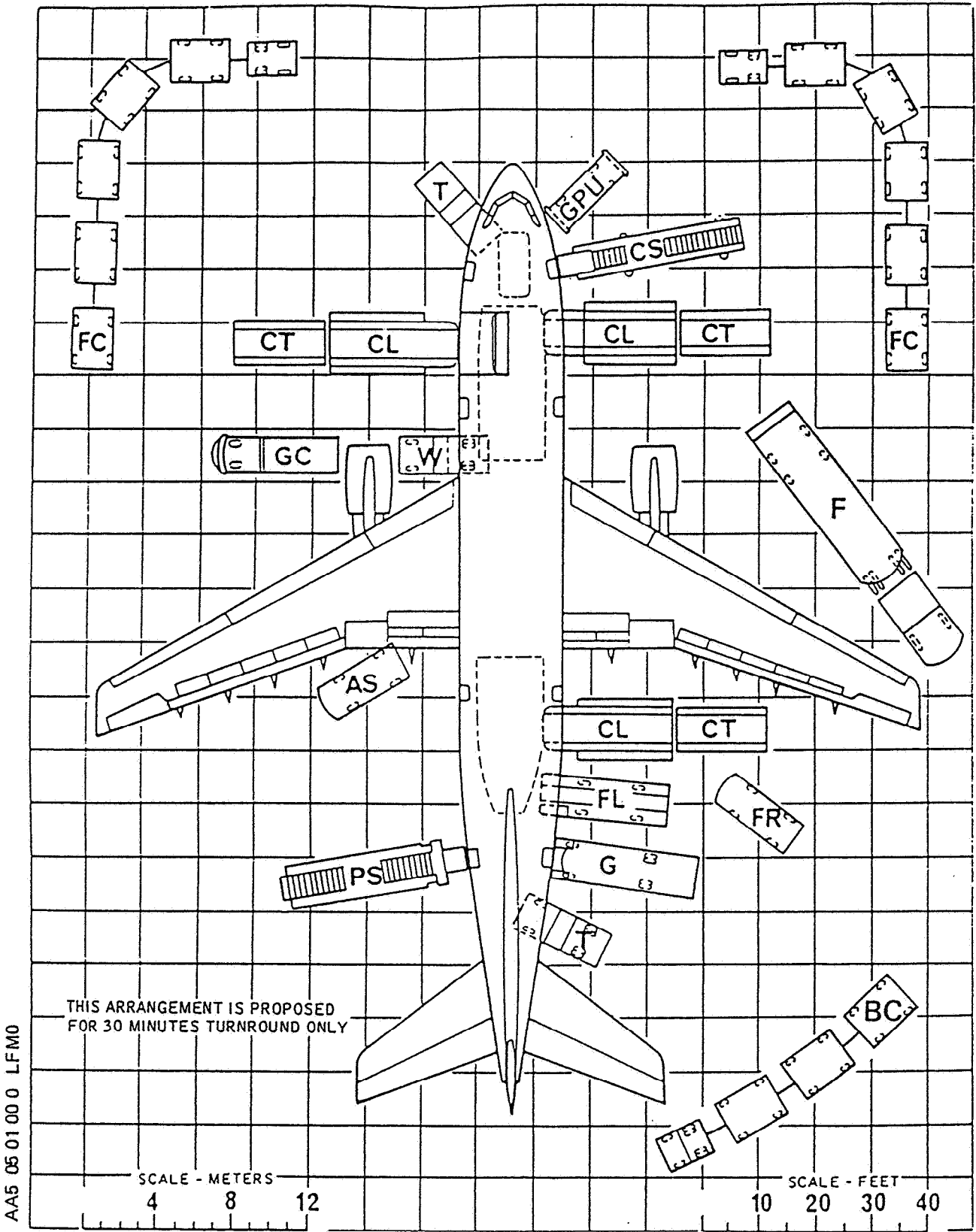

5.1 AIRPLANE SERVICING ARRANGEMENT

5.1.3 OPEN APRON FREE STANDING - APU NOT RUNNING

MODEL C4 FREIGHT/PASSENGER

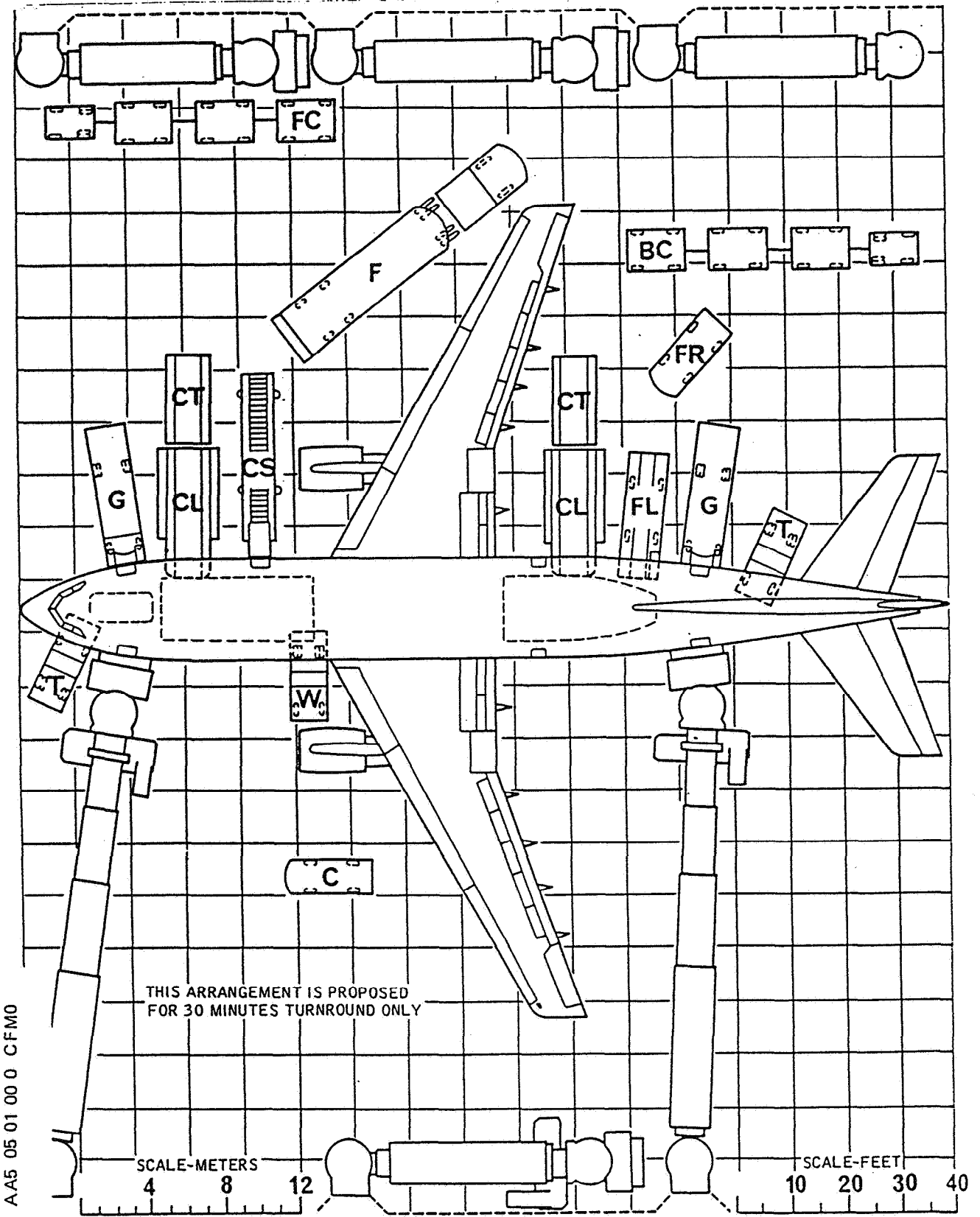

5.1 AIRPLANE SERVICING ARRANGEMENT
5.1.4 TWO PASSENGER GANGWAYS - PARALLEL - APU RUNNING
MODEL B2 - B4 - C4 PASS

A300
AIRPLANE CHARACTERISTICS FOR AIRPORT PLANNING

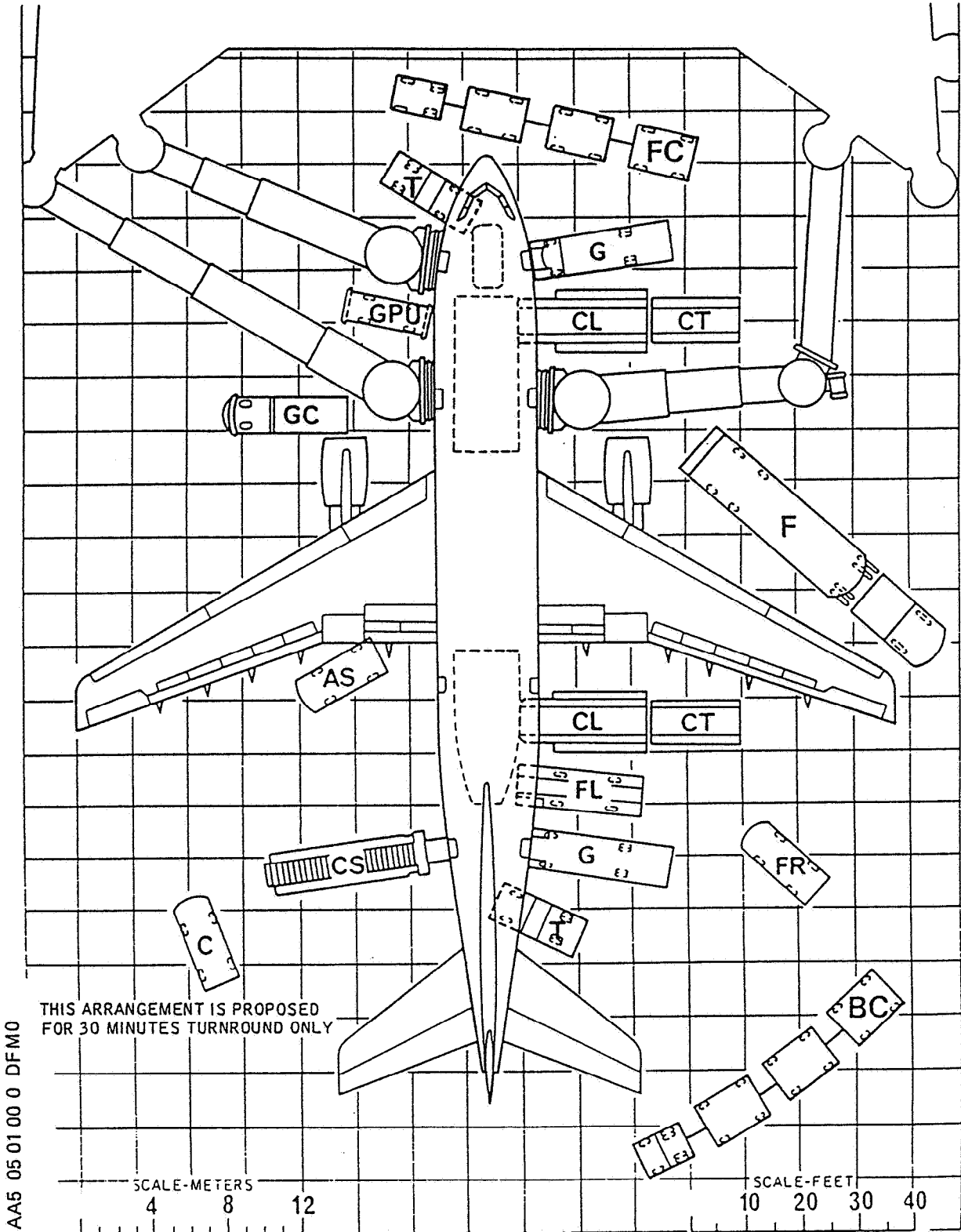

5.1 AIRPLANE SERVICING ARRANGEMENT

**5.1.5. THREE PASSENGER GANGWAYS - NOSE IN - APU NOT RUNNING
 MODEL B2 - B4 - C4 PASS**

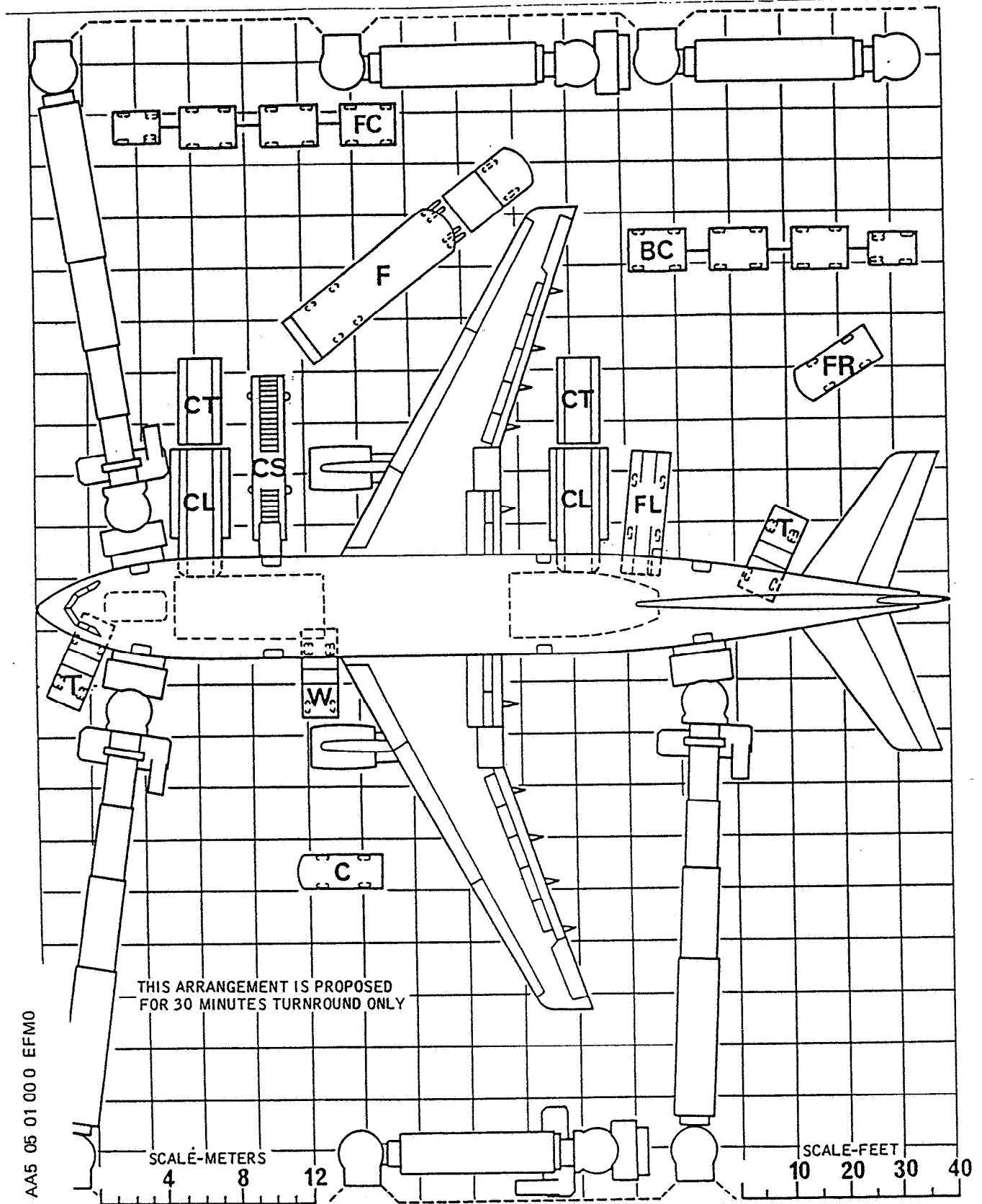

5.1 AIRPLANE SERVICING ARRANGEMENT
5.1.6 THREE PASSENGER GANGWAYS - DOUBLE PARALLEL - APU RUNNING
MODEL B2 - B4 - C4 PASS

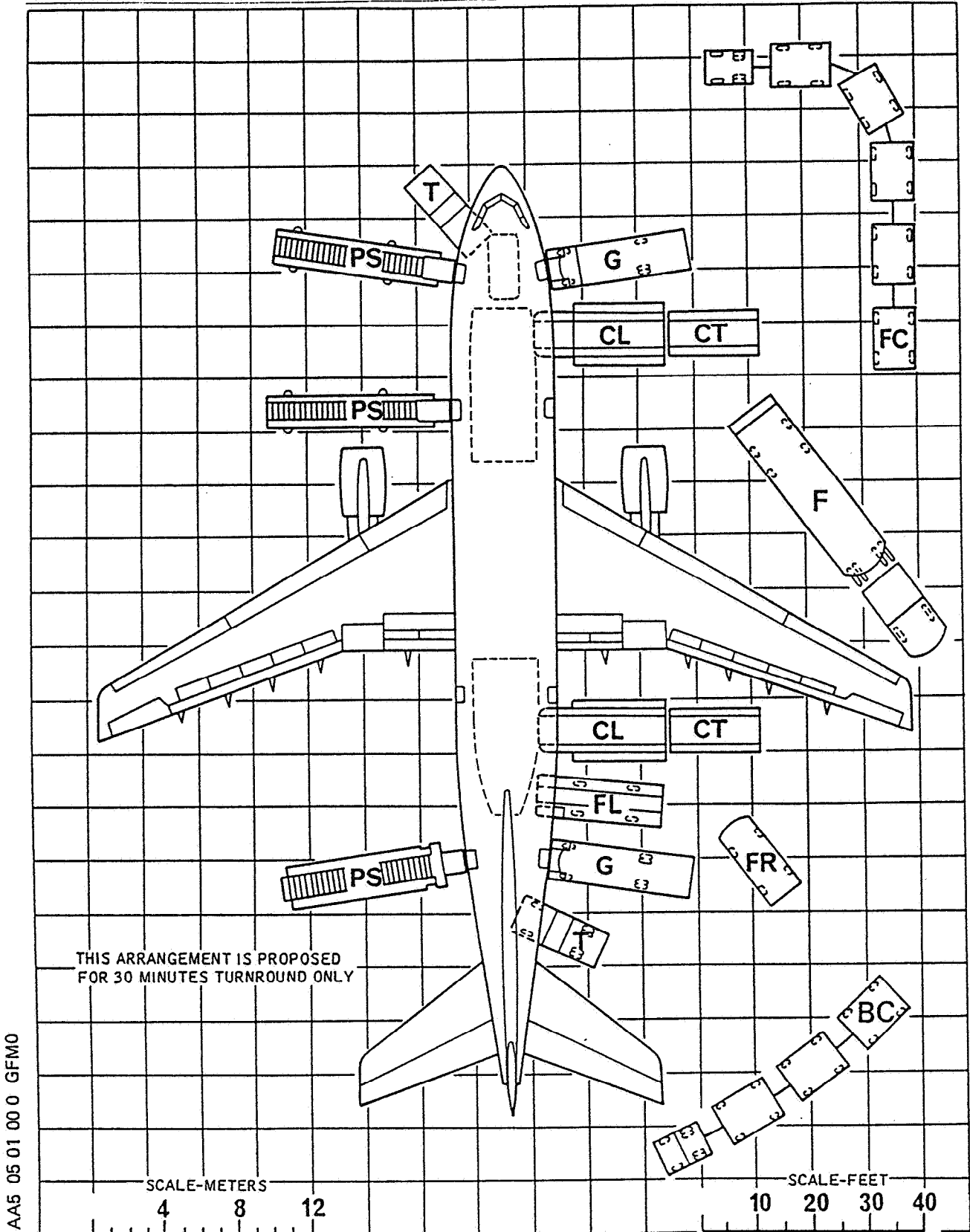

5.1 AIRPLANE SERVICING ARRANGEMENT
5.1.7 OPEN APRON FREE STANDING - APU RUNNING
MODEL B2 - B4 - C4 PASS

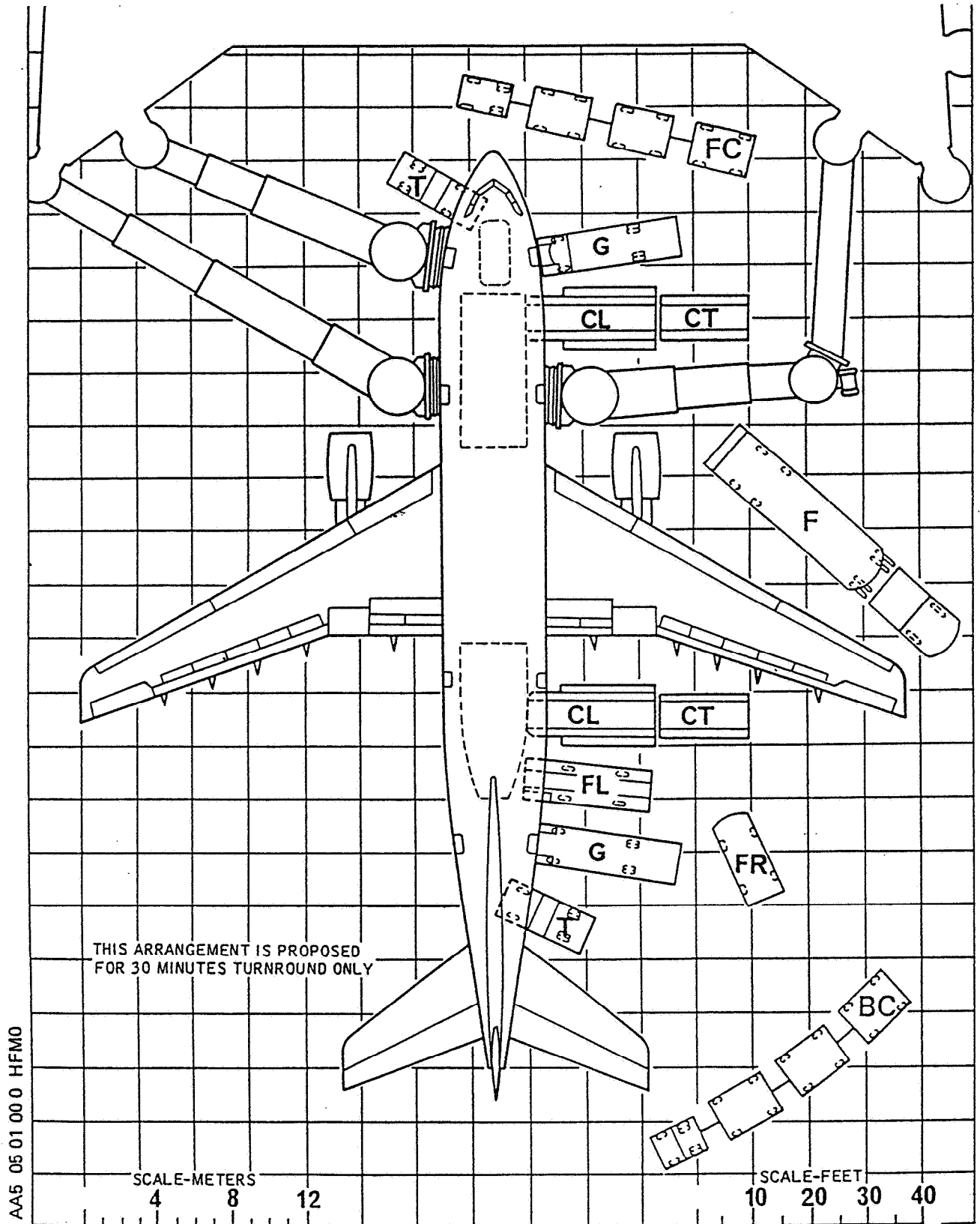

5.1 AIRPLANE SERVICING ARRANGEMENT
5.1.8 THREE PASSENGER GANGWAYS - NOSE IN - APU RUNNING
MODEL B2 - B4 - C4 PASS

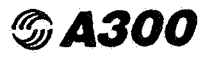

AIRPLANE CHARACTERISTICS FOR AIRPORT PLANNING

THIS PAGE LEFT BLANK INTENTIONALLY

A 300

AIRPLANE CHARACTERISTICS

ESTIMATED TIME-MINUTES

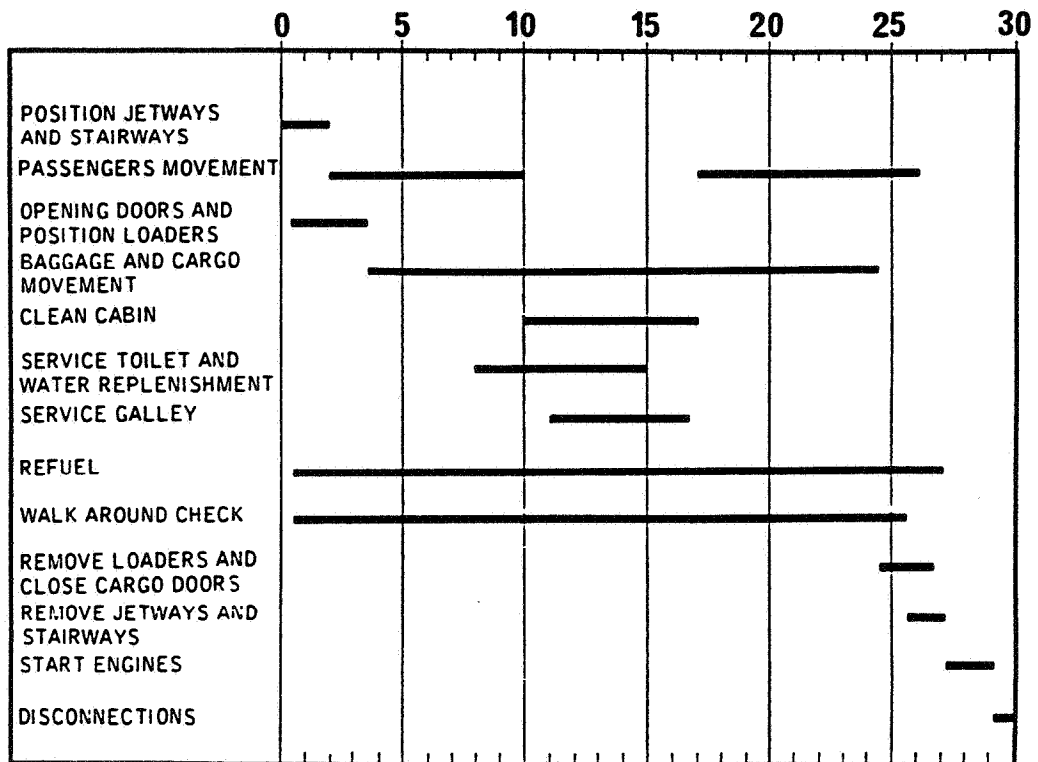

Printed in France

145 PASSENGERS - 1 DOOR OPEN - 100% PASSENGER MOVEMENT
REFUELLING OF 80%

PASSENGER FLOW RATE $\left\{ \begin{array}{l} 18 \text{ PAX/DOOR MINUTE - DEPLANING} \\ 16 \text{ PAX/DOOR MINUTE - BOARDING} \end{array} \right.$

APU RUNNING

FREIGHT AND BAGGAGE CONTAINERIZED

100% UNLOAD - LOAD

AA 5 05 02 00 0 AA 0

5.2 TERMINAL OPERATION

5.2.1 TURNROUND STATION - 30 MINUTES - 1 DOOR OPEN

MODEL C4 FREIGHT/PASSENGER

A 300
AIRPLANE CHARACTERISTICS

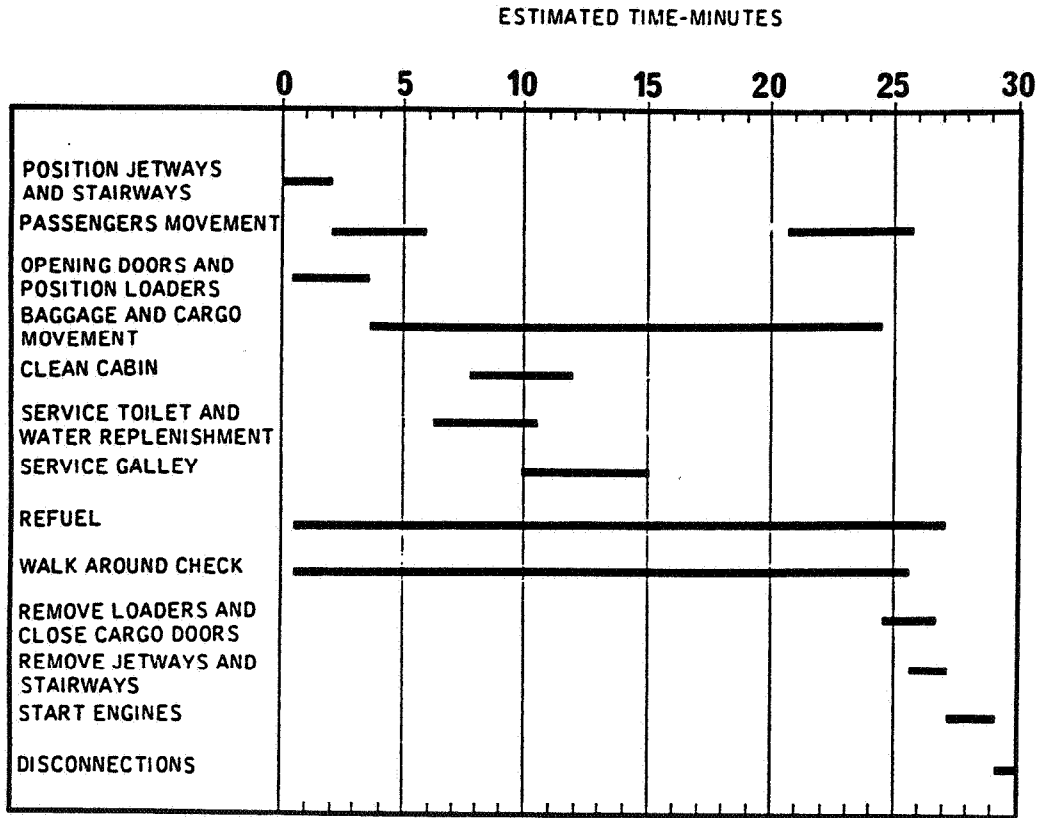

Printed in France

75 PASSENGERS - 1 DOOR OPEN - 100% PASSENGER MOVEMENT
REFUELLING OF 80%

PASSENGER FLOW RATE $\left\{ \begin{array}{l} 18 \text{ PAX/DOOR MINUTE - DEPLANING} \\ 16 \text{ PAX/DOOR MINUTE - BOARDING} \end{array} \right.$

APU RUNNING

FREIGHT AND BAGGAGE CONTAINERIZED

100% UNLOAD - LOAD

5.2 TERMINAL OPERATION

5.2.1 TURNROUND STATION - 30 MINUTES - 1 DOOR OPEN
MODEL C4 FREIGHT/PASSENGER

A A 5 05 02 00 0 AB 0

A 300
AIRPLANE CHARACTERISTICS

Printed in France

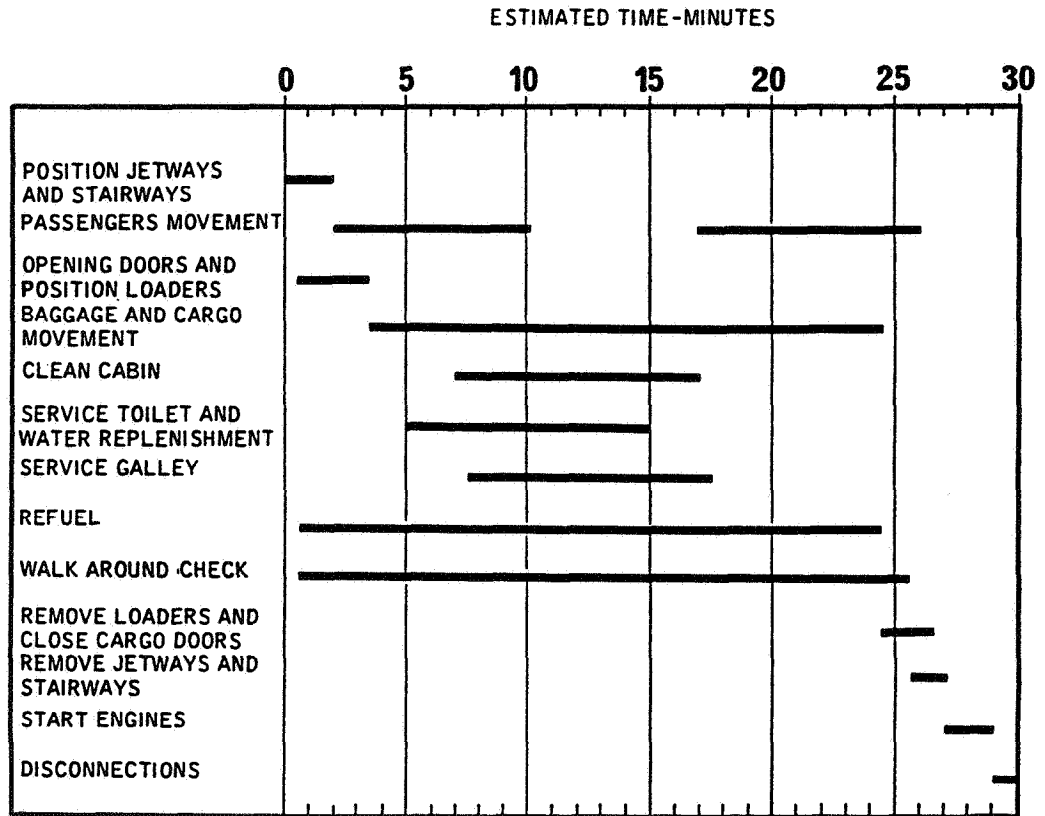

281 PASSENGERS - 2 DOORS OPEN - 100 % PASSENGER MOVEMENT
REFUELLING OF 80 %

PASSENGER FLOW RATE $\left\{ \begin{array}{l} 18 \text{ PAX/DOOR MINUTE - DEPLANING} \\ 16 \text{ PAX/DOOR MINUTE - BOARDING} \end{array} \right.$

APU RUNNING

BAGGAGE CONTAINERIZED

A A 5 05 02 00 0 AF 0

5.2 TERMINAL OPERATION
5.2.2 TURNROUND STATION - 30 MINUTES - 2 DOORS OPEN
MODEL B2

A 300
AIRPLANE CHARACTERISTICS

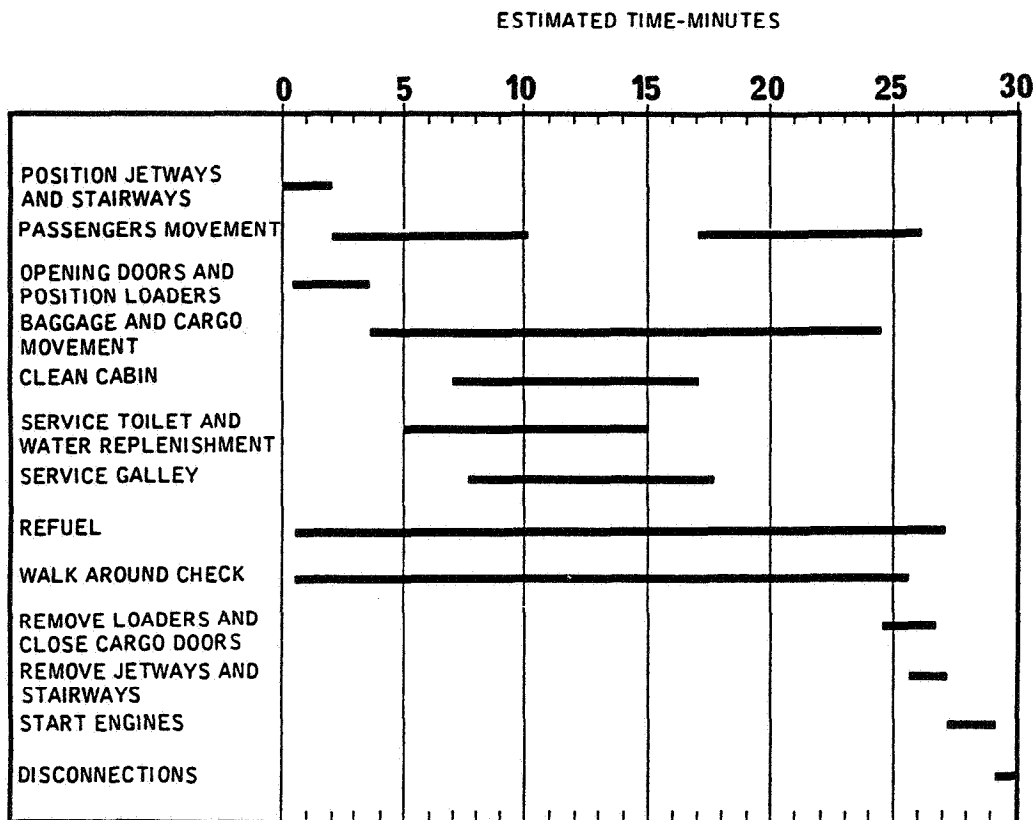

Printed in France

281 PASSENGERS - 2 DOORS OPEN - 100 % PASSENGER MOVEMENT
REFUELLING OF 80 %

PASSENGER FLOW RATE $\left\{ \begin{array}{l} 18 \text{ PAX/DOOR MINUTE - DEPLANING} \\ 16 \text{ PAX/DOOR MINUTE - BOARDING} \end{array} \right.$

APU RUNNING

BAGGAGE CONTAINERIZED

5.2 TERMINAL OPERATION

5.2.2 TURNROUND STATION - 30 MINUTES - 2 DOORS OPEN
MODEL B4 - C4 PASS

A A 5 05 02 00 0 AT 0

A 300
AIRPLANE CHARACTERISTICS

Printed in France

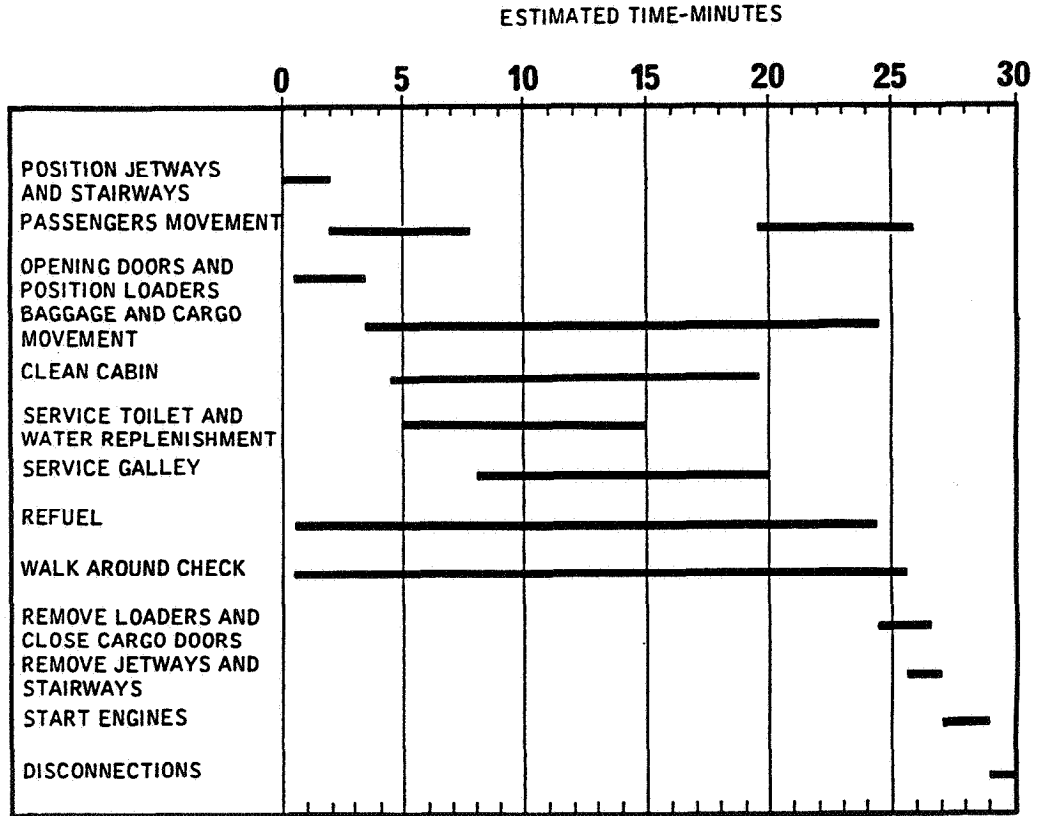

281 PASSENGERS - 3 DOORS OPEN - 100 % PASSENGER MOVEMENT
REFUELLING OF 80 %

PASSENGER FLOW RATE $\left\{ \begin{array}{l} 18 \text{ PAX/DOOR MINUTE - DEPLANING} \\ 16 \text{ PAX/DOOR MINUTE - BOARDING} \end{array} \right.$

APU RUNNING
BAGGAGE CONTAINERIZED

A A 5 05 02 00 0 BF 0

5.2 TERMINAL OPERATION
5.2.3 TURNROUND STATION - 30 MINUTES - 3 DOORS OPEN
MODEL B2

AIRBUS  INDUSTRIE
A 300
 AIRPLANE CHARACTERISTICS

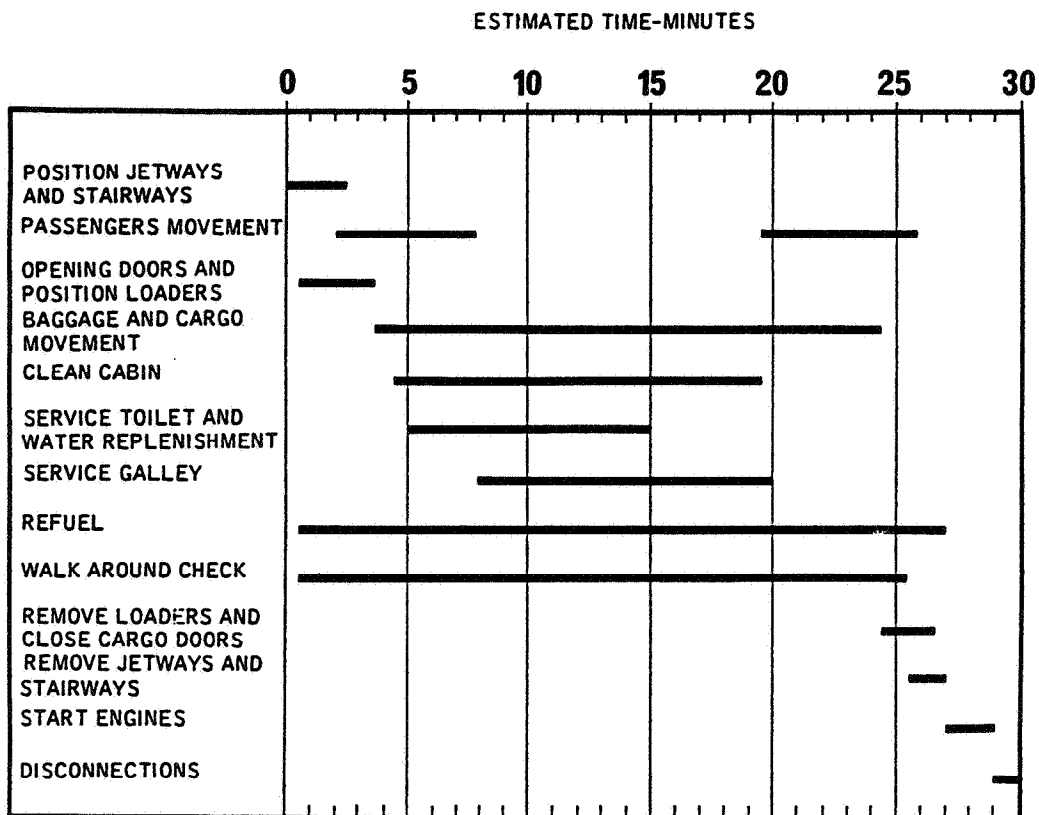

Printed in France

281 PASSENGERS - 3 DOORS OPEN - 100 % PASSENGER MOVEMENT
 REFUELLING OF 80 %

PASSENGER FLOW RATE $\left\{ \begin{array}{l} 18 \text{ PAX/DOOR MINUTE - DEPLANING} \\ 16 \text{ PAX/DOOR MINUTE - BOARDING} \end{array} \right.$

APU RUNNING

BAGGAGE CONTAINERIZED

A A 5 05 02 00 0 BT 0

5.2 TERMINAL OPERATION
 5.2.3 TURNROUND STATION - 30 MINUTES - 3 DOORS OPEN
 MODEL B4 - C4 PASS

A 300
AIRPLANE CHARACTERISTICS

Printed in France

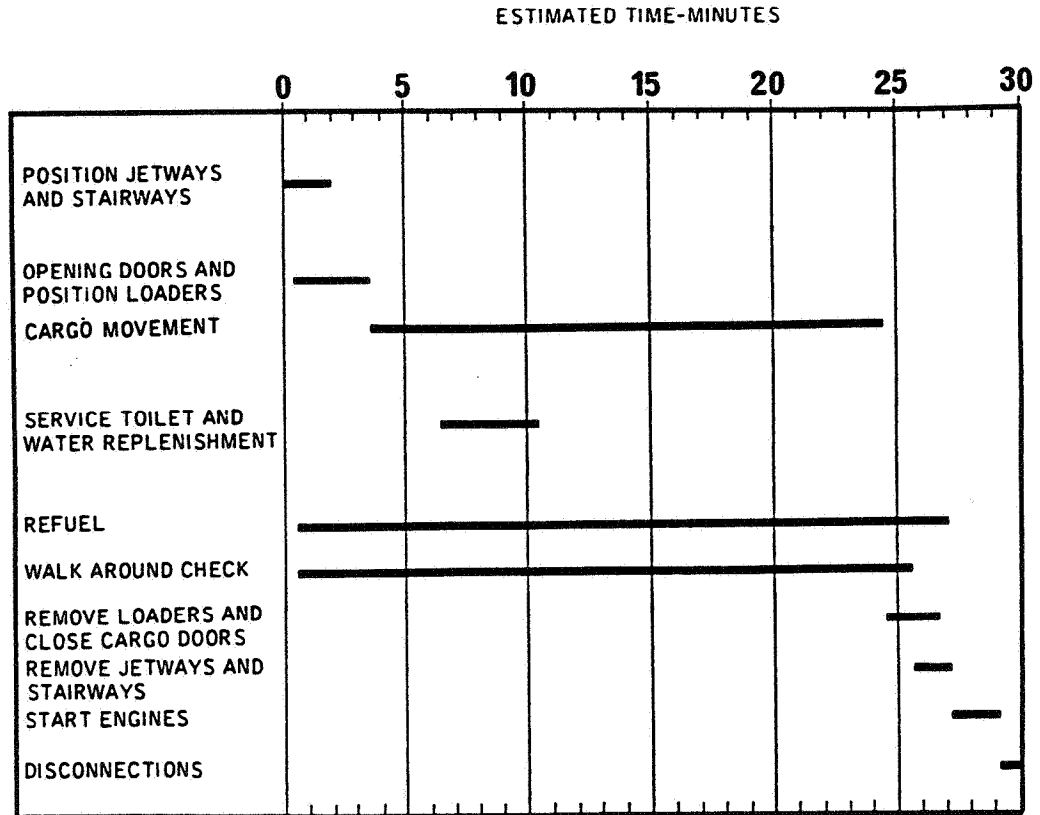

100% UNLOAD - LOAD
REFUELLING OF 80 %
APU RUNNING
FREIGHT CONTAINERIZED

A A 5 05 02 00 0CFO

5.2 TERMINAL OPERATION
5.2.4 TURNROUND STATION - 30 MINUTES - FREIGHT MODE
MODEL C4 FREIGHT

A 300
AIRPLANE CHARACTERISTICS

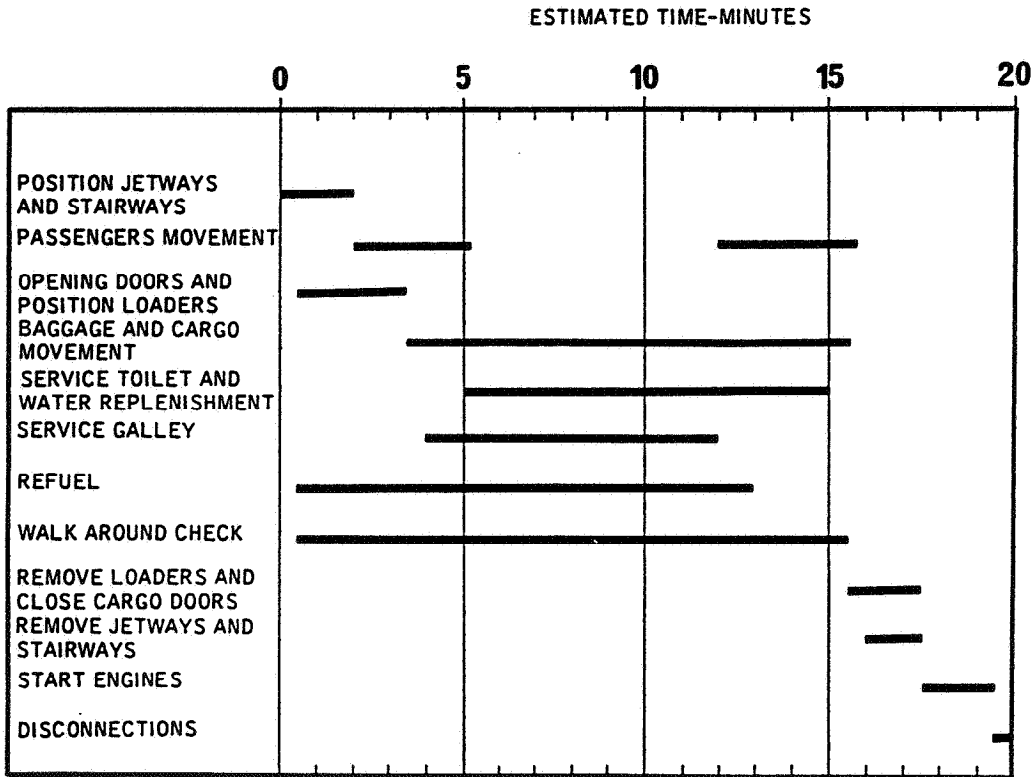

Printed in France

281 PASSENGERS - 3 DOORS OPEN - 60 % PASSENGER MOVEMENT
 REFUELLING OF 30 %
 PASSENGER FLOW RATE $\left\{ \begin{array}{l} 18 \text{ PAX/DOOR MINUTE - DEPLANING} \\ 16 \text{ PAX/DOOR MINUTE - BOARDING} \end{array} \right.$
 APU RUNNING
 BAGGAGE CONTAINERIZED

5.3 TERMINAL OPERATION
 5.3.1 ENROUTE STATION - 20 MINUTES - 3 DOORS OPEN
 MODEL B2

A A 5 05 03 00 0 AF 0

A 300
AIRPLANE CHARACTERISTICS

Printed in France

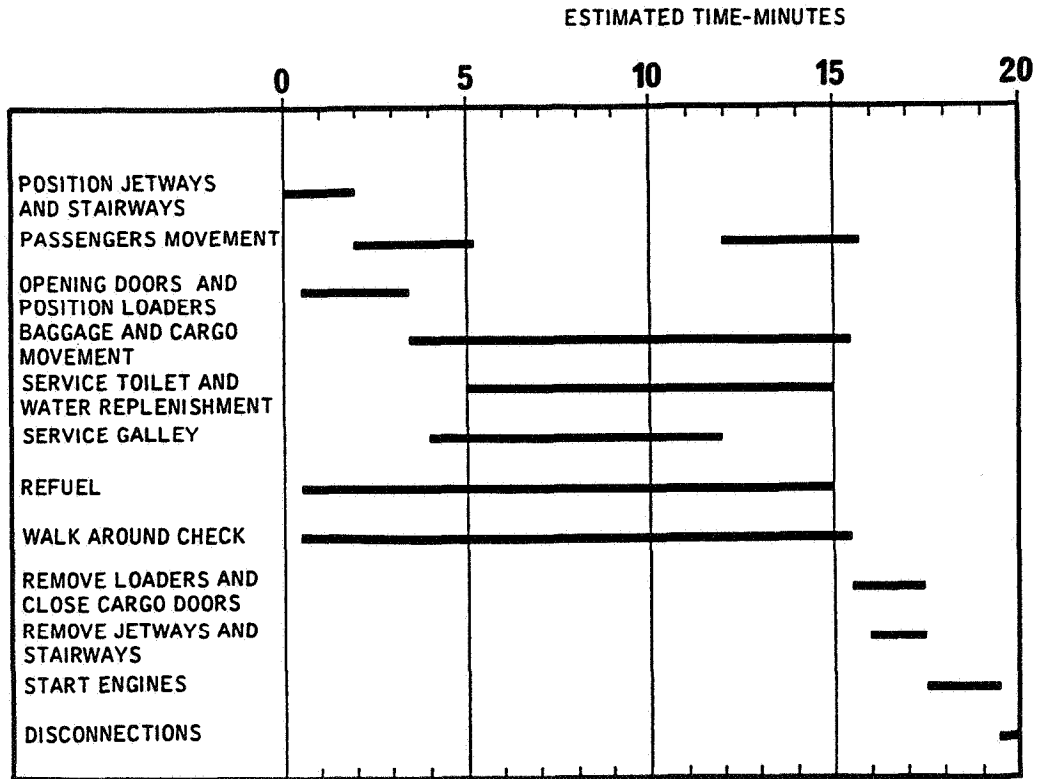

281 PASSENGERS - 3 DOORS OPEN - 60 % PASSENGER MOVEMENT
REFUELLING OF 30 %

PASSENGER FLOW RATE $\left\{ \begin{array}{l} 18 \text{ PAX/DOOR MINUTE - DEPLANING} \\ 16 \text{ PAX/DOOR MINUTE - BOARDING} \end{array} \right.$

APU RUNNING

BAGGAGE CONTAINERIZED

A A 5 05 03 00 0 AT 0

5.3 TERMINAL OPERATION

5.3.1 ENROUTE STATION - 20 MINUTES - 3 DOORS OPEN
MODEL B4 - C4 PASS

A 300
AIRPLANE CHARACTERISTICS

A	POTABLE WATER FILLING
A1	POTABLE WATER FLUSHING AND DRAINING
B	OXYGEN CHARGING POINT
C	HYDRAULIC POWER GROUND CONNECTION
D	ENGINE AND CSD OIL FILLING CONNECTIONS
E	TOILET SERVICING CONNECTION
F	ELECTRICAL GROUND CONNECTION
G	PRE-CONDITIONING CONNECTIONS - LP
H	GRAVITY FUELING CONNECTIONS
I	ACCUMULATOR AIR CHARGING
J	HYDRAULIC TANK FILLING CONNECTIONS
K	HYDRAULIC TANK AIR CHARGING
L	PRESSURE FUELING CONNECTIONS
M	PRE-CONDITIONING CONNECTION/ENGINE STARTING - HP

Printed in France

5.4 GROUND SERVICE CONNECTIONS
 5.4.1 GROUND SERVICE CONNECTIONS DATA
 MODEL B2 - B4

A 300

AIRPLANE CHARACTERISTICS

Printed in France

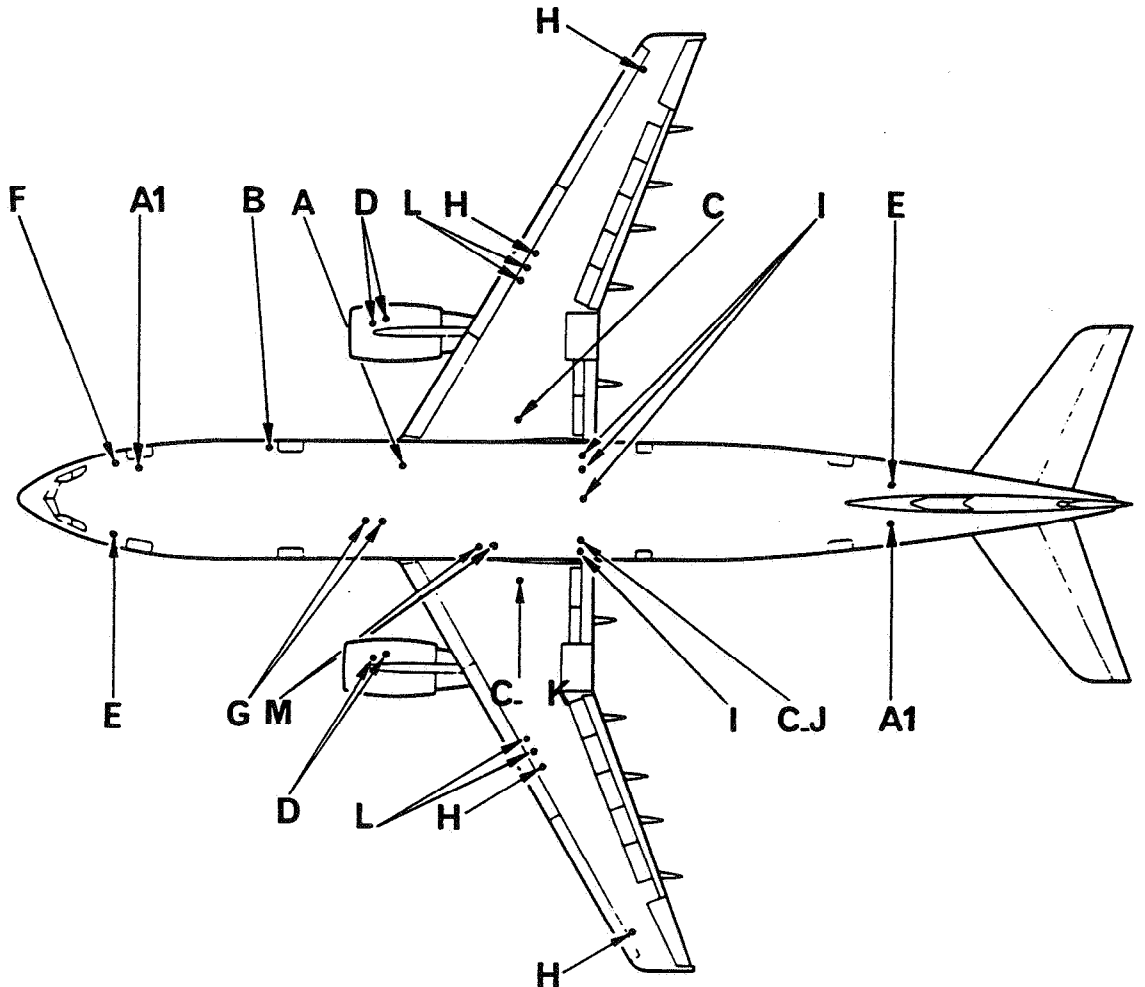
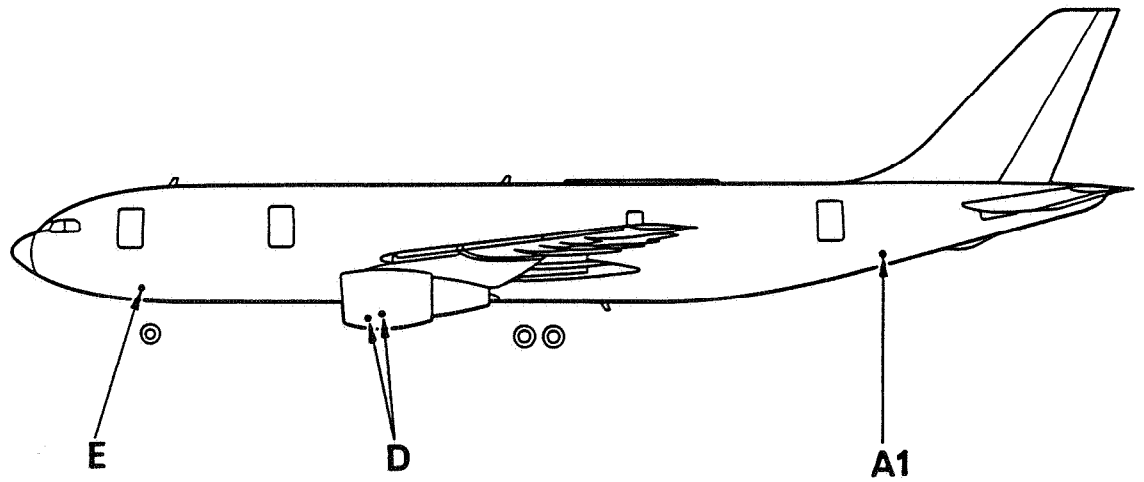

A 12 5 B P 026 02 01 A

5.4 GROUND SERVICE CONNECTIONS

5.4.2 GROUND SERVICE CONNECTIONS LAYOUT

MODEL B2 - B4

A 300
AIRPLANE CHARACTERISTICS

A	POTABLE WATER FILLING
A1	POTABLE WATER FLUSHING AND DRAINING
B	OXYGEN CHARGING POINT
C	HYDRAULIC POWER GROUND CONNECTION
D	ENGINE AND CSD OIL FILLING CONNECTIONS
E	TOILET SERVICING CONNECTION
F	ELECTRICAL GROUND CONNECTION
G	PRE-CONDITIONING CONNECTIONS - LP
H	GRAVITY FUELING CONNECTIONS
I	ACCUMULATOR AIR CHARGING
J	HYDRAULIC TANK FILLING CONNECTIONS
K	HYDRAULIC TANK AIR CHARGING
L	PRESSURE FUELING CONNECTIONS
M	PRE-CONDITIONING CONNECTION/ENGINE STARTING - HP

Printed in France

5.4 GROUND SERVICE CONNECTIONS
 5.4.1 GROUND SERVICE CONNECTIONS DATA
 MODEL C4

A 300

AIRPLANE CHARACTERISTICS

Printed in France

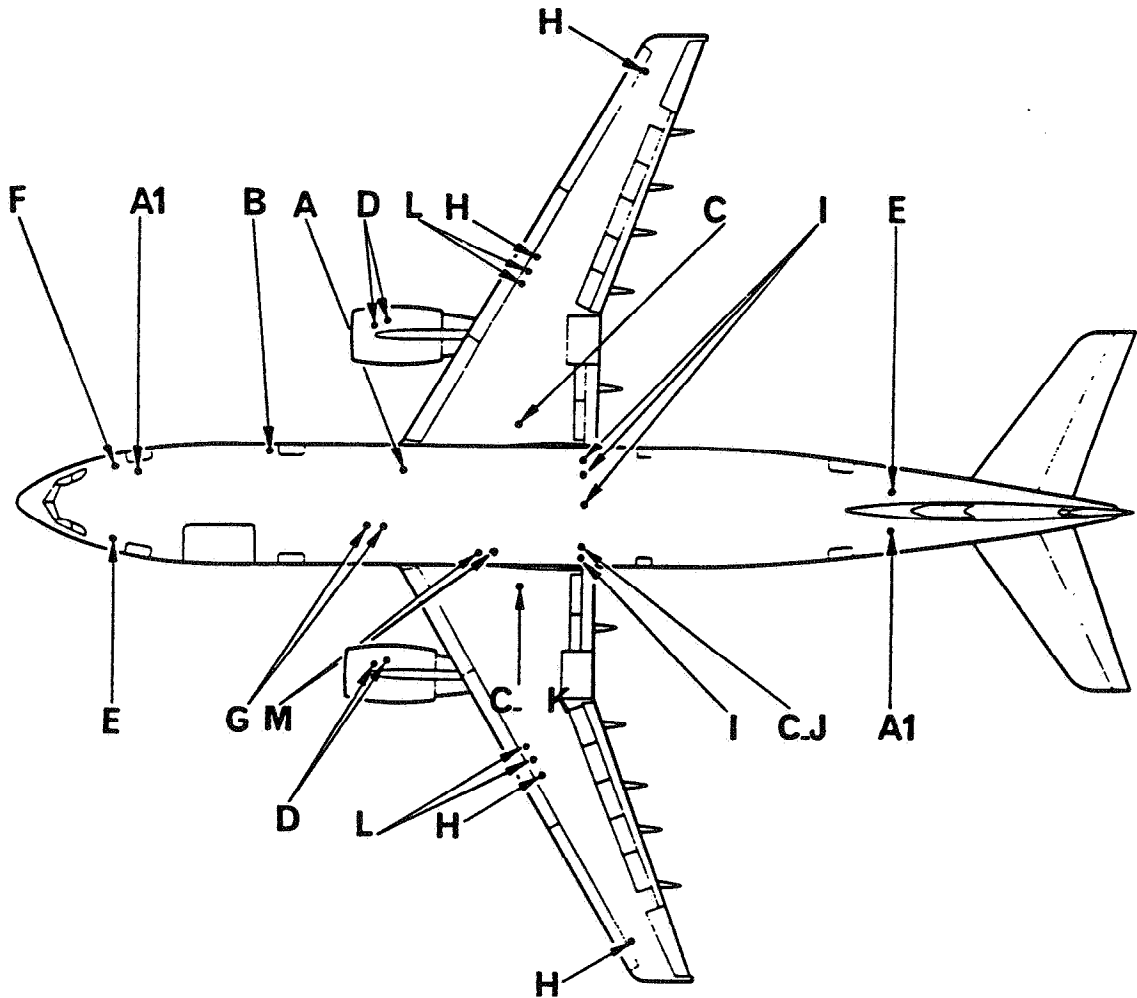
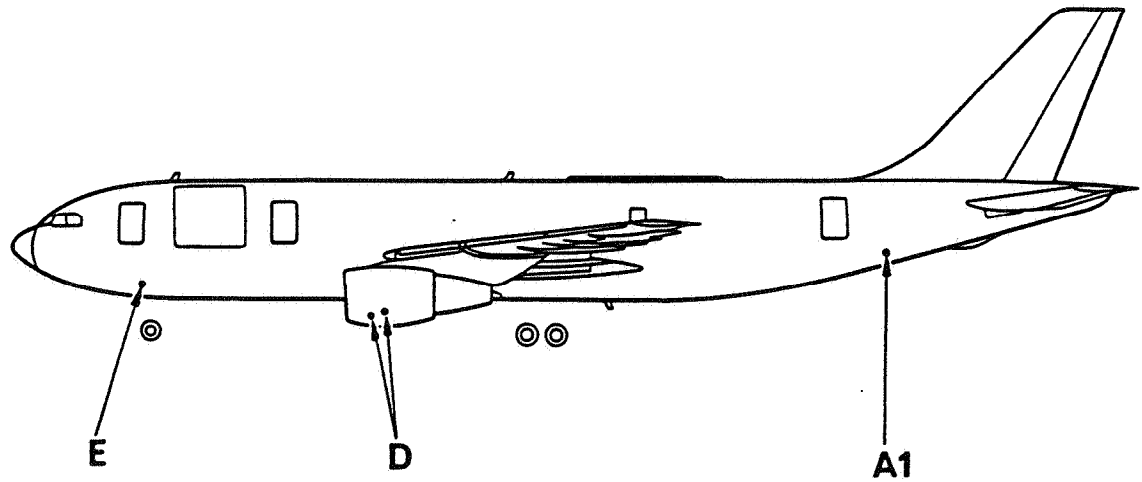

AA 5 05 04 00 0 BM 0

5.4 GROUND SERVICE CONNECTIONS

5.4.2 GROUND SERVICE CONNECTIONS LAYOUT

MODEL C4

A 300
AIRPLANE CHARACTERISTICS

	DISTANCE <u>Meters</u> (Ft - In.)		MEAN HEIGHT FROM GROUND	
	AFT OF NOSE	FROM AIRPLANE CENTERLINE		
		RH SIDE		LH SIDE
A. Reservoir charging : One 1/4 in. self sealing connection common for the 3 reservoirs	22.89 (75-1)		3.60 (11-10)	3.59 (11-9)
B. Accumulator charging : Five MS 28889-1 connec- tions (one per accumu- lator)				
- Green	26.07 (85-6)		0.30 (1-0)	2.98 (9-9)
- Yellow and Blue	26.07 (85-6)	2.30 (7-7)	2.30 (7-7)	3.73 (12-3)
- Braking	26.07 (85-6)	2.10 (6-11)		3.73 (12-3)
	26.07 (85-6)	2.10 (6-11)		4.10 (12-5)
C. Reservoir filling : One 1/4 in. self sealing connection common for the 3 reservoirs	25.87 (84-10)		1.77 (5-10)	2.88 (9-5)
D. Reservoir overflow : Three 1/4 in. sealf sealing connections (one per reservoir)				
- Green	25.87 (84-10)		1.77 (5-10)	2.88 (9-5)
- Yellow and Blue	22.89 (75-1)	3.60 (11-10)	3.60 (11-10)	3.59 (11-9)
E. Ground test Three 1 in. self sealing connections and three 1 1/4 in. self sealing connections (one pair per system)				
- Green	25.87 (84-10)		1.77 (5-10)	2.88 (9-5)
- Yellow and Blue	22.89 (75-1)	3.60 (11-10)	3.60 (11-10)	3.59 (11-9)

Printed in France

5.4.3 Hydraulic System
MODEL B2

A 300
AIRPLANE CHARACTERISTICS

Printed in France

	DISTANCE $\frac{\text{Meters}}{\text{(Ft - In.)}}$		MEAN HEIGHT FROM GROUND
	AFT OF NOSE	FROM AIRPLANE CENTERLINE	
		RH SIDE	
A. Reservoir charging : One 1/4 in. self sealing connection common for the 3 reservoirs	22.89 (75-1)		3.60 (11-10)
B. Accumulator charging : Five MS 28889-1 connections (one per accumulator)			
- Green	26.07 (85-6)		0.30 (1-0) 2.99 (9-10)
- Yellow and Blue	26.07 (85-6)	2.30 (7-7)	2.30 (7-7) 3.74 (11-5)
- Braking	26.07 (85-6)	2.10 (6-11)	3.74 (13-5)
- Braking	26.07 (85-6)	2.10 (6-11)	4.11 (13-5)
C. Reservoir filling : One 1/4 in. self sealing connection common for the 3 reservoirs	25.87 (84-10)		1.77 (5-10) 2.89 (9-5)
D. Reservoir overflow : Three 1/4 in. self sealing connections (one per reservoir)			
- Green	25.87 (84-10)		1.77 (5-10) 2.89 (9-5)
- Yellow and Blue	22.89 (75-1)	3.60 (11-10)	3.60 (11-10) 3.60 (11-9)
E. Ground test : Three 1 in. self sealing connections and three 1 1/4 in. self sealing connections (one pair per system)			
- Green	25.87 (84-10)		1.77 (5-10) 2.89 (9-5)
- Yellow and Blue	22.89 (75-1)	3.60 (11-10)	3.60 (11-10) 3.60 (11-9)

5.4.3 Hydraulic System
MODEL B2 320 - B4 - C4

A 300
AIRPLANE CHARACTERISTICS

ELECTRICAL SYSTEM

DISTANCE $\frac{\text{Meters}}{\text{(Ft - In.)}}$		MEAN HEIGHT FROM GROUND	
AFT OF NOSE	FROM AIRPLANE CENTERLINE		
		RH SIDE	LH SIDE
4.40 (14-5)	1.71 (5-7)		3.29 (10-9)

One standard 6 pin connection - ISO R461 specification

Supply :
 115/200 Volt Phase 400 HZ
 Power required : 90 KVA

Printed in France

ELECTRICAL SYSTEM

DISTANCE $\frac{\text{Meters}}{\text{(ft - in.)}}$			MEAN HEIGHT FROM GROUND
AFT OF NOSE	FROM AIRPLANE CENTERLINE		
	RH SIDE	LH SIDE	
4.40 (14-5)	1.71 (5-7)		3.30 (10-10)

One standard 6 pin connection -
ISO R461 specification

Supply:
115/200 Volt 3 Phase 400 Hz
Power required: 90 KVA

R Electrical Connectors for Servicing

R Note: For mating connectors contact HUBBEL (FSCM 7H582)

OXYGEN SYSTEM

One service connection
 (external charging) 3/8 in.
 UNF x 24 TPI

DISTANCE		Meters		MEAN HEIGHT FROM GROUND
		(ft - in.)		
AFT OF NOSE	FROM AIRPLANE CENTERLINE			
	RH SIDE	LH SIDE		
12.05 (38-10)	2.52 (8-3)			3.60 (11-9)

5.4.5 Oxygen System
 MODEL B2

A 300
AIRPLANE CHARACTERISTICS

OXYGEN SYSTEM

One service connection
(external charging) 3/8 in.
UNF x 24 TPI

DISTANCE ^{Meters} (Ft - In.)			MEAN HEIGHT FROM GROUND
AFT OF NOSE	FROM AIRPLANE CENTERLINE		
	RH SIDE	LH SIDE	
12.05 (39-6.4)	2.52 (8-3)	—	3.59 (11-9)

Printed in France

R

5.4.5 Oxygen System
MODEL B2 320 - B4 - C4

Jul 31/82

Chapter 5
Page 33

A 300
AIRPLANE CHARACTERISTICS

FUEL SYSTEM

Two standard 2 1/2 in. connections - ISO R45 Specification

Two Standard 2 1/2 in. connections - ISO R45 Specification

Two service connections (gravity feed)

Two service connections (gravity feed)

AFT OF NOSE	DISTANCE <u>Meters</u> (Ft - In.)		MEAN HEIGHT FROM GROUND
	FROM AIRPLANE CENTERLINE		
	RH SIDE	LH SIDE	
24.31 (79-9)	11.84 (38-10)	—	4.27 (14-0)
24.32 (79-9)	—	11.84 (38-10)	4.27 (14-0)
24.95 (81-10)	12.35 (40-6)	12.35 (40-6)	4.72 (15-6)
31.02 (101-9)	20.39 (66-11)	20.39 (66-11)	5.27 (17-3)

Printed in France

Flow Rate :
1135 l/mn (250 Imp. gal/mn) (300 U.S. gal/mn) per connection

Maximum Pressure :
50 psig (3.45 bars)

APPROX. CAPACITIES PER AIRPLANE

	LITERS	IMP. GALLONS	U.S. GALLONS
Two outboard tanks	9,230	2,030	2,438
Two inboard tanks	34,770	7,650	9,185
Total per airplane	44,000	9,680	11,623

5.4.6 Fuel System
MODEL B2-B2K

A 300
AIRPLANE CHARACTERISTICS

FUEL SYSTEM

	DISTANCE <u>Meters</u> (Ft - In.)		MEAN HEIGHT FROM GROUND	
	AFT OF NOSE	FROM AIRPLANE CENTERLINE		
		RH SIDE		LH SIDE
Two standard 2 1/2 in. connections - ISO R45 Specification	24.31 (79-9)	11.84 (38-10)	—	4.26 (13-11)
Two Standard 2 1/2 in. connections - ISO R45 Specification	24.31 (79-9)	—	11.84 (38-10)	4.26 (13-11)
Two service connections (gravity feed)	24.95 (81-10)	12.35 (40-6)	12.35 (40-6)	4.72 (15-5)
Two service connections (gravity feed)	31.02 (101-9)	20.39 (66-11)	20.39 (66-11)	5.27 (17-3)

Printed in France

Flow Rate :
1135 l/mn (250 Imp. gal/mn) (300 U.S. gal/mn) per connection
Maximum Pressure :
50 psig (3.45 bars)

APPROX. CAPACITIES PER AIRPLANE

	LITERS	IMP. GALLONS	U.S. GALLONS
Two outboard tanks	9,230	2,030	2,438
Two inboard tanks	34,770	7,650	9,185
Total per airplane	44,000	9,680	11,623

5.4.6 Fuel System
MODEL B2 320

FUEL SYSTEM

	DISTANCE Meters (Ft - In.)			MEAN HEIGHT FROM GROUND
	AFT OF NOSE	FROM AIRPLANE CENTERLINE		
		RH SIDE	LH SIDE	
Two standard 2 1/2 in. connections - ISO R45 Specification	24.31 (79-9)	11.84 (38-10)	—	4.26 (13-11)
Two Standard 2 1/2 in. connections - ISO R45 Specification	24.31 (79-9)	—	11.84 (38-10)	4.26 (13-11)
Two service connections (gravity feed)	24.95 (81-10)	12.35 (40-6)	12.35 (40-6)	4.72 (15-5)
Two service connections (gravity feed)	31.02 (101-9)	20.39 (66-11)	20.39 (66-11)	5.27 (17-3)

Flow Rate :

1475 l/mn (325 Imp. gal/mn) (390 U.S. gal/mn) per connection

Maximum Pressure :

50 psig (3.45 bars)

APPROX. CAPACITIES PER AIRPLANE

	LITERS BASIC	LITERS OPTIONAL	IMP. GALLONS BASIC	IMP. GALLONS OPTIONAL	U.S. GALLONS BASIC	U.S. GALLONS OPTIONAL
Two outboard tanks	9,210	9,260	2,030	2,040	2,430	2,450
Two inboard tanks	34,560	35,140	7,600	7,730	9,130	9,280
One center tank	14,330	17,600	3,150	3,870	3,790	4,650
R Total per airplane	58,100	62,000	12,780	13,640	15,350	16,380

5.4.6 Fuel System MODEL B4

AIRPLANE CHARACTERISTICS FOR AIRPORT PLANNING

FUEL SYSTEM

	DISTANCE Meters (Ft - In.)			MEAN HEIGHT FROM GROUND
	AFT OF NOSE	FROM AIRPLANE CENTERLINE		
		RH SIDE	LH SIDE	
Two standard 2 1/2 in. connections - ISO R45 Specification	24.31 (79-9)	11.84 (38-10)	—	4.26 (13-11)
Two Standard 2 1/2 in. connections - ISO R45 Specification	24.31 (79-9)	—	11.84 (38-10)	4.26 (13-11)
Two service connections (gravity feed)	24.95 (81-10)	12.35 (40-6)	12.35 (40-6)	4.72 (15-5)
Two service connections (gravity feed)	31.02 (101-9)	20.39 (66-11)	20.39 (66-11)	5.27 (17-3)

Flow Rate :

1475 l/mn (325 Imp. gal/mn) (390 U.S. gal/mn) per connection

Maximum Pressure :

50 psig (3.45 bars)

APPROX. CAPACITIES PER AIRPLANE

	LITERS BASIC	LITERS OPTIONAL	IMP. GALLONS BASIC	IMP. GALLONS OPTIONAL	U.S. GALLONS BASIC	U.S. GALLONS OPTIONAL
Two outboard tanks	9,210	9,260	2,030	2,040	2,430	2,450
Two inboard tanks	34,560	35,140	7,600	7,730	9,130	9,280
One center tank	14,330	17,600	3,150	3,870	3,790	4,650
R Total per airplane	58,100	62,000	12,780	13,640	15,350	16,380

5.4.6 Fuel System MODEL C4

A 300
AIRPLANE CHARACTERISTICS

PNEUMATIC SYSTEM

Two standard 3 in. ISO TC20 connections for engine starting and cabin conditioning.

Two standard 8 in. connections (MS33562) for pre-conditioned air (optional).

AFT OF NOSE	DISTANCE $\frac{\text{Meters}}{\text{(Ft - In.)}}$		MEAN HEIGHT FROM GROUND
	FROM AIRPLANE CENTERLINE		
	RH SIDE	LH SIDE	
21.60 (70-10)		0.88 (2-11)	2.15 (7-1)
17.31 (56-9)		0.82 (2-8)	2.27 (7-5)
16.82 (55-2)		0.82 (2-8)	2.27 (7-5)

Printed in France

A 300
AIRPLANE CHARACTERISTICS

PNEUMATIC SYSTEM

Two standard 3 in. ISO TC20 connections for engine starting and cabin conditioning.

Two standard 8 in. connections (MS33562) for pre-conditioned air (optional).

AFT OF NOSE	DISTANCE <u>Meters</u> (Ft - In.)		MEAN HEIGHT FROM GROUND
	FROM AIRPLANE CENTERLINE		
	RH SIDE	LH SIDE	
21.60 (70-10)		0.88 (2-11)	2.16 (7-1)
17.31 (56-9)		0.82 (2-8)	2.27 (7-5)
16.82 (55-2)		0.82 (2-8)	2.27 (7-5)

Printed in France

A 300
AIRPLANE CHARACTERISTICS

OIL SYSTEM

DISTANCE ^{Meters} (Ft - In.)			MEAN HEIGHT FROM GROUND	
AFT OF NOSE	FROM AIRPLANE CENTERLINE			
	RH SIDE	LH SIDE		
A. Engine oil replenishment : One gravity fill cap and one pressure fill connec- tion per engine fill	18.00 (59-1)	8.80 (28-11)	7.00 (22-11)	1.40 (4-7)

Delivery pressure required : 25 psi (1.72 bars)

Tank capacity :

- Full level : 6 U.S. Gal (22.710 liters)
- Usable : 3 U.S. Gal (11.355 liters)

B. C.S.D. oil replenishment :

One pressure fill connec-
tion per engine and one
gravity fill port

17.50 (57-4)	9.00 (29-6)	6.80 (22-4)	1.00 (3-3)
-----------------	----------------	----------------	---------------

Delivery pressure required : 25 psi (1.72 bars)

Tank capacity : 8.5 U.S. quarts (8.04 liters)

Printed in France

A 300
AIRPLANE CHARACTERISTICS

OIL SYSTEM

AFT OF NOSE	DISTANCE <u>Meters</u> (Ft - In.)		MEAN HEIGHT FROM GROUND	
	FROM AIRPLANE CENTERLINE			
	RH SIDE	LH SIDE		
A. Engine oil replenishment : One gravity fill cap and one pressure fill connection per engine fill	18.20 (59-8)	8.86 (29-1)	7.02 (23-00)	1.36 (4-6)

A. Engine oil replenishment :
One gravity fill cap and one pressure fill connection per engine fill

Delivery pressure required : 25 psi (1.72 bar)

Tank capacity :

- Full level : 10.6 U.S. Gal (40.12 liters)
- Usable : 8.6 U.S. Gal (32.55 liters)

B. C.S.D. oil replenishment :
One pressure fill connection per engine and one gravity fill port

18.05 (59-3)	8.53 (28-0)	7.34 (24-1)	1.05 (3-5)
-----------------	----------------	----------------	---------------

Delivery pressure required : 25 psi (1,72 bar)

Tank capacity : 8.5 U.S. quarts (8.04 liters)

Printed in France

N

5.4.8 Engine and CSD Oil System
MODEL B2 320

A 300
AIRPLANE CHARACTERISTICS

OIL SYSTEM

AFT OF NOSE	DISTANCE <u>Meters</u> (Ft - In.)		MEAN HEIGHT FROM GROUND	
	FROM AIRPLANE CENTERLINE			
	RH SIDE	LH SIDE		
A. Engine oil replenishment : One gravity fill cap and one pressure fill connection per engine fill	18.00 (59-1)	8.80 (28-11)	7.00 (22-11)	1.40 (4-7)

Delivery pressure required : 25 psi (1.72 bar)

Tank capacity :

- Full level : 6 U.S. Gal (22.710 liters)
- Usable : 3 U.S. Gal (11.355 liters)

B. C.S.D. oil replenishment :
One pressure fill connection per engine and one gravity fill port

17.50 (57-4)	9.00 (29-6)	6.80 (22-4)	1.00 (3-3)
-----------------	----------------	----------------	---------------

Delivery pressure required : 25 psi (1.72 bar)

Tank capacity : 8.5 U.S. quarts (8.04 liters)

Printed in France

A 300
AIRPLANE CHARACTERISTICS

OIL SYSTEM

AFT OF NOSE	DISTANCE <u>Meters</u> (Ft - In.)		MEAN HEIGHT FROM GROUND	
	FROM AIRPLANE CENTERLINE			
	RH SIDE	LH SIDE		
A. Engine oil replenishment : One gravity fill cap and one pressure fill connection per engine fill	18.00 (59-1)	8.80 (28-11)	7.00 (22-11)	1.40 (4-7)

A. Engine oil replenishment :
One gravity fill cap and one pressure fill connection per engine fill

Delivery pressure required : 25 psi (1.72 bar)

Tank capacity :

- Full level : 6 U.S. Gal (22.710 liters)
- Usable : 3 U.S. Gal (11.355 liters)

B. C.S.D. oil replenishment :
One pressure fill connection per engine and one gravity fill port

17.50 (57-4)	9.00 (29-6)	6.80 (22-4)	1.00 (3-3)
-----------------	----------------	----------------	---------------

Delivery pressure required : 25 psi (1.72 bar)

Tank capacity : 8.5 U.S. quarts (8.04 liters)

Printed in France

POTABLE WATER SYSTEM

DISTANCE $\frac{\text{Meters}}{\text{(Ft - In.)}}$			MEAN HEIGHT FROM GROUND
AFT OF NOSE	FROM AIRPLANE CENTERLINE		
	RH SIDE	LH SIDE	
18.41 (60-5)	1.13 (3-8)		2.48 (6-8)
5.13 (16-10)	1.63 (5-4)		3.05 (10-0)
42.10 (137-6)		0.70 (2-3)	4.32 (14-2)

One standard 3/4 in. self sealing quick release coupling for filling.
Two drain and two flushing connections

Fill rate :

- Flow : 91 l/mn (20 Imp. gal/mn) (24 U.S. gal/mn)
- R - Pressure : 25 psi (1.72 bar)

Usable capacity :

- 400 liters (88 Imp. gal.) (106 U.S. gal.)

POTABLE WATER SYSTEM

One standard 3/4 in. self sealing quick release coupling for filling.
Two drain and two flushing connections

AFT OF NOSE	DISTANCE <u>Meters</u> (Ft - In.)		MEAN HEIGHT FROM GROUND
	FROM AIRPLANE CENTERLINE		
	RH SIDE	LH SIDE	
18.41 (60-5)	1.13 (3-8)		2.48 (6-8)
5.13 (16-10)	1.63 (5-4)		3.06 (10-0)
42.10 (137-6)		0.70 (2-3)	4.33 (14-2)

Fill rate :

- Flow : 91 l/mn (20 Imp. gal/mn) (24 U.S. gal/mn)
- R - Pressure : 25 psi (1.72 bar)

Usuable capacity :

- 400 liters (88 Imp. gal. (106 U.S. gal.))

A 300
AIRPLANE CHARACTERISTICS

TOILET SYSTEM

DISTANCE		Meters (Ft - In.)		MEAN HEIGHT FROM GROUND
AFT OF NOSE	FROM AIRPLANE CENTERLINE			
	RH SIDE	LH SIDE		
4.40 (14-5)		1.71 (5.7)	3.28 (10-9)	
42.16 (138-4)	0.64 (2-1)		4.26 (13-10)	

Per servicing panel
One Standard 4 in. drain.
connection and two 1 in.
flush connection

Capacity Single toilet :

- Waste : 58,7 liters (12.9 Imp. gal.) (15.5 U.S. gal.)
- Chemical fluid : 9,5 liters (2.1 Imp. gal.) (2.5 U.S. gal.)

Capacity Double toilet :

- Waste : 120 liters (26.4 Imp. gal.) (31.6 U.S. gal.)
- Chemical fluid : 19 liters (4.2 Imp. gal.) (5.0 U.S. gal.)

Printed in France

5.4.10 Toilet System
MODEL B2

A 300
AIRPLANE CHARACTERISTICS

TOILET SYSTEM

DISTANCE		Meters (Ft- In.)		MEAN HEIGHT FROM GROUND
AFT OF NOSE	FROM AIRPLANE CENTERLINE			
	RH SIDE	LH SIDE		
4.40 (14-5)		1.71 (5-7)	3.29 (10-9)	
42.16 (138-4)	0.64 (2-1)		4.29 (14-0)	

Per servicing panel
One Standard 4 in. drain
connection and two 1 in.
flush connection

Printed in France

Capacity Single toilet :

- Waste : 58,7 liters (12.9 Imp. gal.) (15.5 U.S. gal.)
- Chemical fluid : 9,5 liters (2.1 Imp. gal.) (2.5 U.S. gal.)

Capacity Double toilet :

- Waste : 120 liters (26.4 Imp. gal.) (31.6 U.S. gal.)
- Chemical fluid : 19 liters (4.2 Imp. gal.) (5.0 U.S. gal.)

A 300
AIRPLANE CHARACTERISTICS

AIR SUPPLY TEMPERATURE
AT FUSELAGE CONNECTION

AIR SUPPLY PRESSURE
AT GROUND CONNECTION

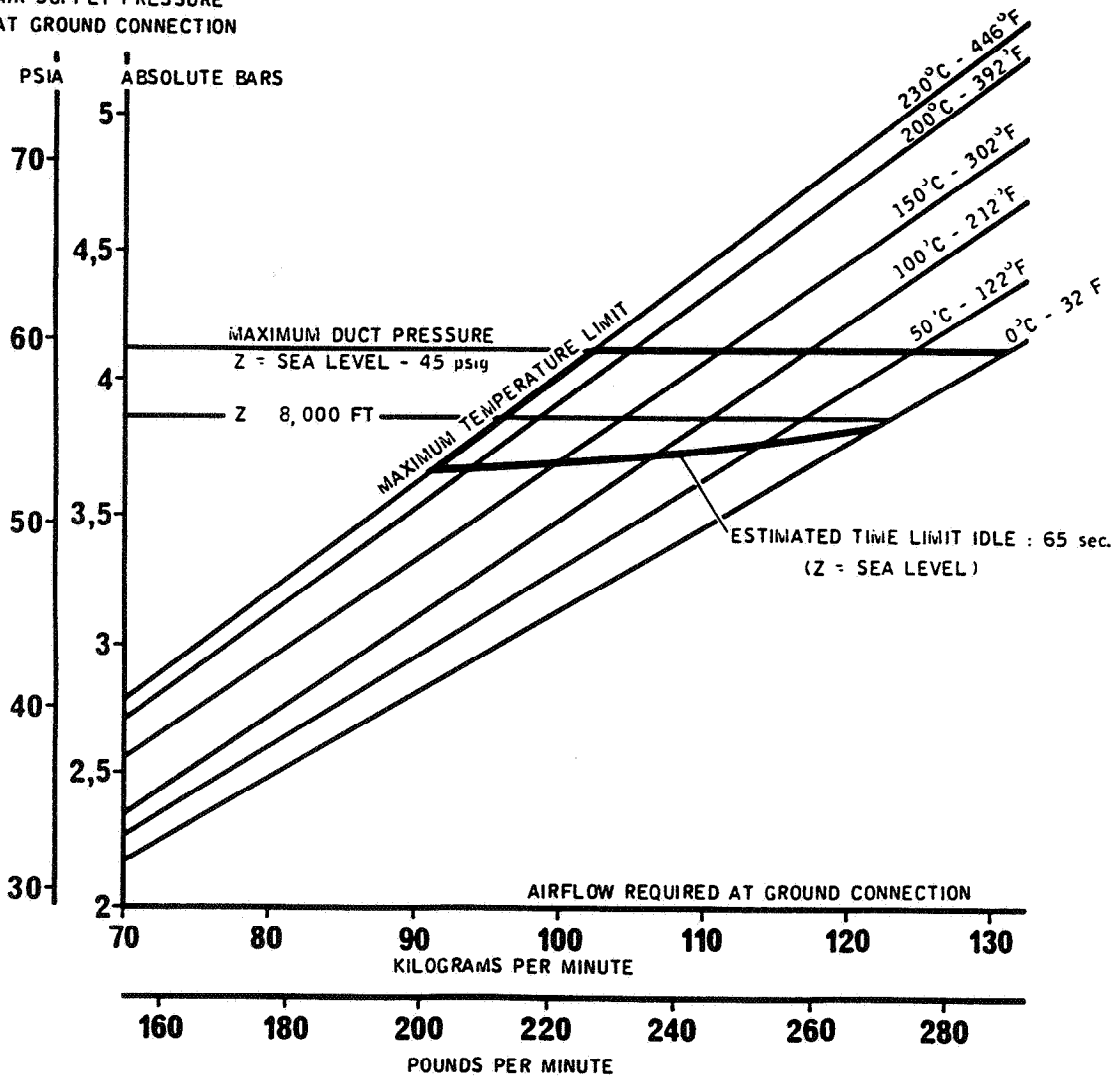

Printed in France

AA 5 05 05 01 0 AB 0

0 TO 8,000 FT. ALT.
TEMP. AMBIENT : - 20°C - 4°F

5.5 ENGINE STARTING PNEUMATIC REQUIREMENTS
5.5.1 AMBIENT TEMPERATURE -20°C (-4°F)
MODEL B2-320

A 300

AIRPLANE CHARACTERISTICS

AIR SUPPLY TEMPERATURE
AT FUSELAGE CONNECTION

Printed in France

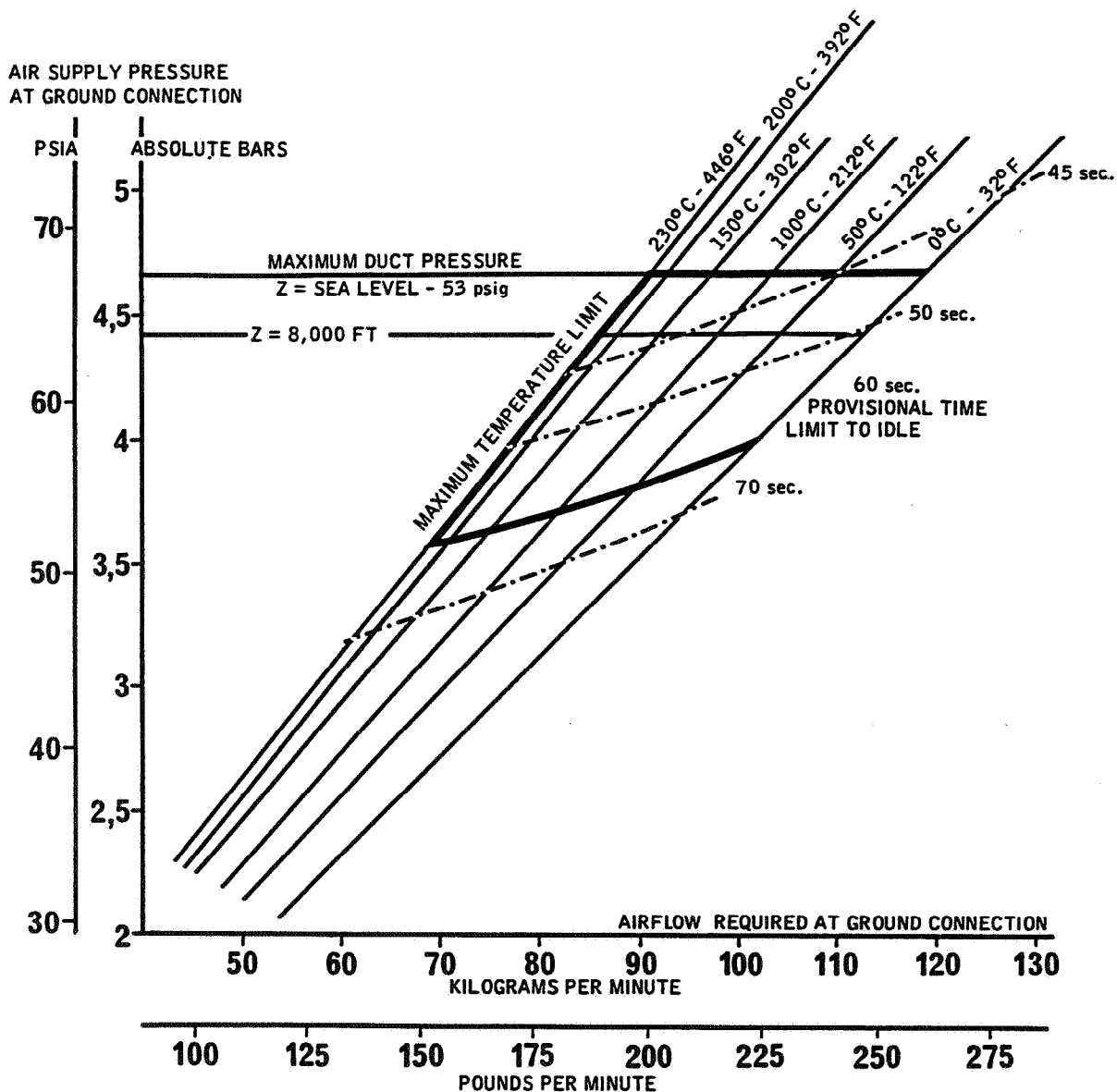

0 TO 8,000 FT. ALT.
TEMP. AMBIENT : - 40°C - 40°F

AA 5 05 01 0 AA 0

R

5.5 ENGINE STARTING PNEUMATIC REQUIREMENTS
5.5.1 AMBIENT TEMPERATURE -40°C (-40°F)
MODEL B2 - B4 - C4

A 300

AIRPLANE CHARACTERISTICS

AIR SUPPLY TEMPERATURE
AT FUSELAGE CONNECTION

AIR SUPPLY PRESSURE
AT GROUND CONNECTION

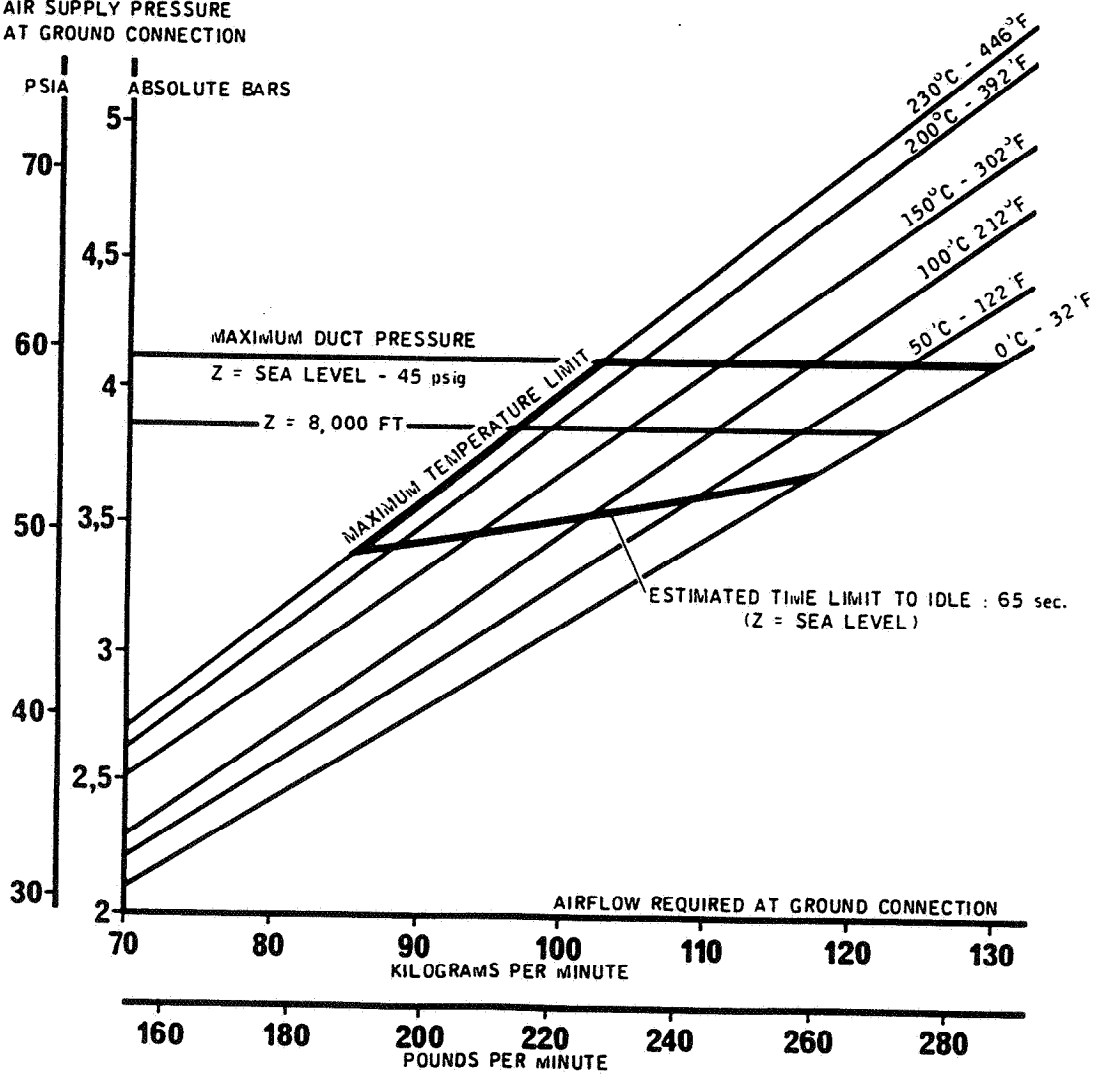

Printed in France

A A 5 05 05 02 0 A B 0

0 TO 8,000 FT. ALT.
TEMP. AMBIENT : + 15°C + 59°F

5.5 ENGINE STARTING PNEUMATIC REQUIREMENTS

5.5.2 AMBIENT TEMPERATURE +15°C (+60°F)

MODEL B2-320

A 300
AIRPLANE CHARACTERISTICS

AIR SUPPLY TEMPERATURE
AT FUSELAGE CONNECTION

AIR SUPPLY PRESSURE
AT GROUND CONNECTION

Printed in France

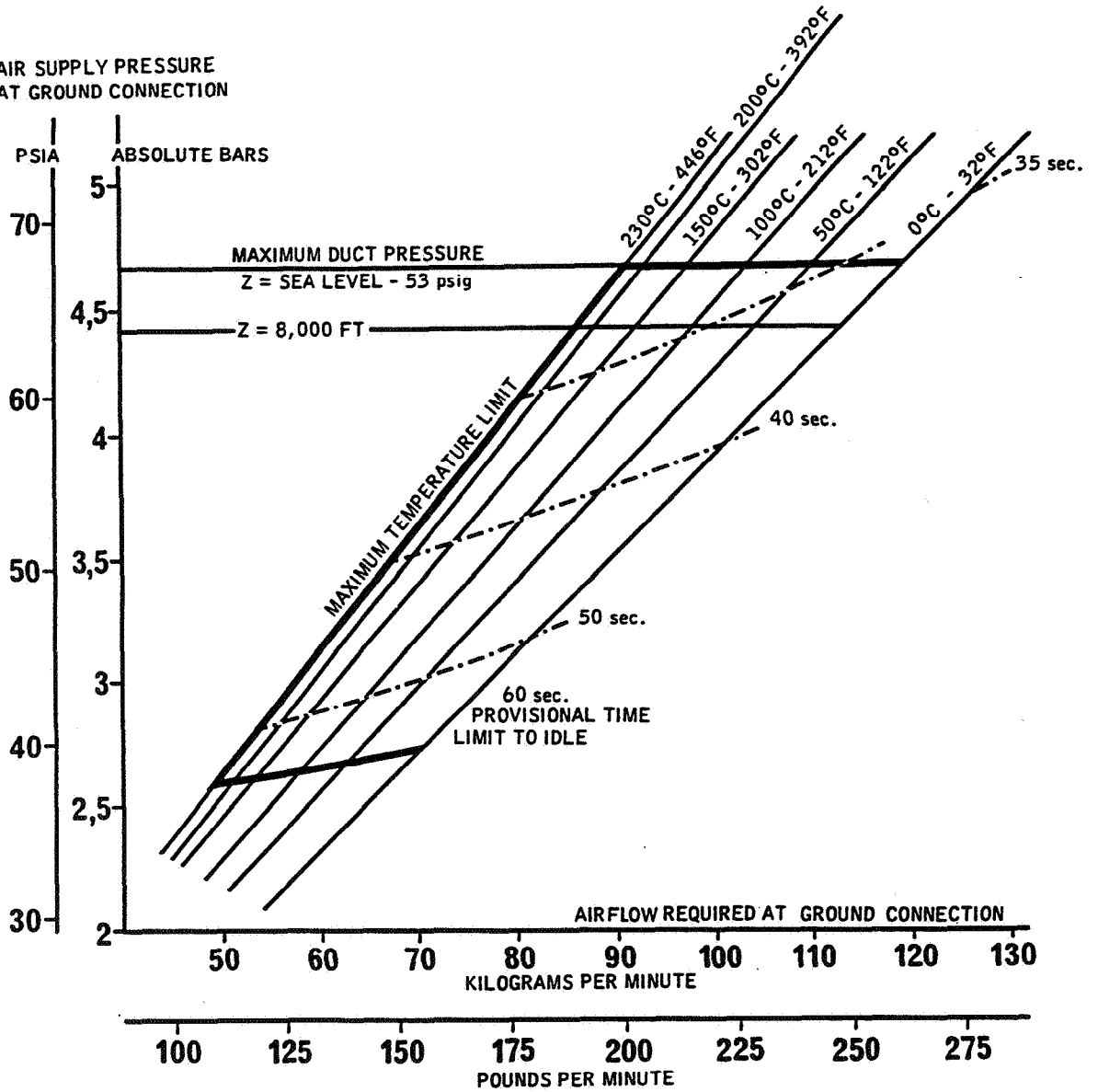

0 TO 8,000 FT. ALT.
TEMP. AMBIENT : + 15°C + 60°F

AA 5 05 05 02 0 AA 0

R

5.5 ENGINE STARTING PNEUMATIC REQUIREMENTS
5.5.2 AMBIENT TEMPERATURE +15°C (+60°F)
MODEL B2 - B4 - C4

AIRBUS  INDUSTRIE
A 300
 AIRPLANE CHARACTERISTICS

AIR SUPPLY TEMPERATURE
 AT FUSELAGE CONNECTION

AIR SUPPLY PRESSURE
 AT GROUND CONNECTION

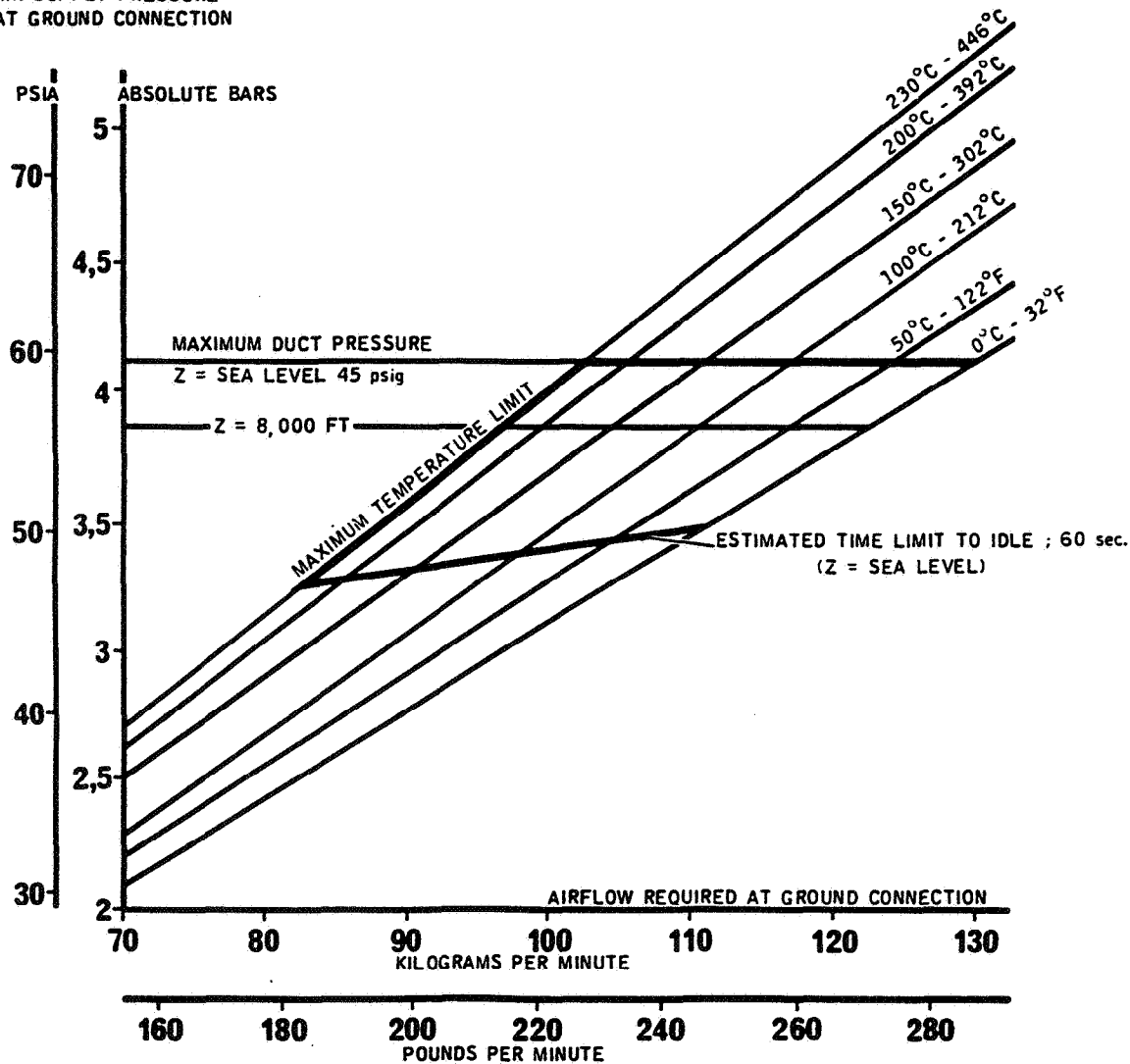

Printed in France

0 TO 8,000 FT. ALT.
 TEMP. AMBIENT : + 38°C + 100°F

A A 5 05 05 03 0 AB 0

5.5 ENGINE STARTING PNEUMATIC REQUIREMENTS
 5.5.3 AMBIENT TEMPERATURE +38°C (+100°F)
 MODEL B2-320

A 300
AIRPLANE CHARACTERISTICS

AIR SUPPLY TEMPERATURE
AT FUSELAGE CONNECTION

Printed in France

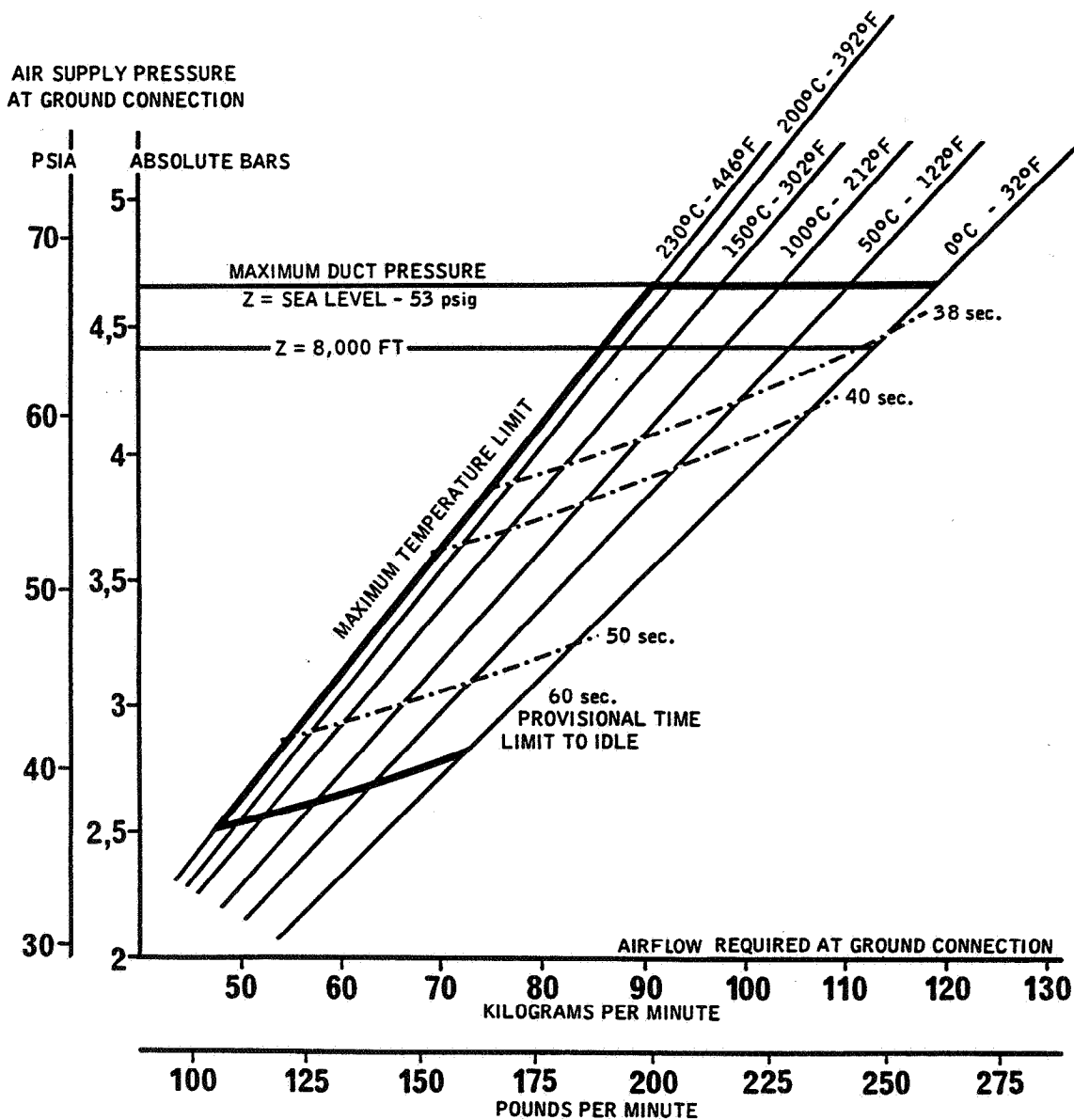

0 TO 8,000 FT. ALT.
TEMP. AMBIENT : +37,8°C + 100°F

AA 5 05 03 0 AA 0

R

5.5 ENGINE STARTING PNEUMATIC REQUIREMENTS
5.5.3 AMBIENT TEMPERATURE +38°C (+100°F)
MODEL B2 - B4 - C4

A 300
AIRPLANE CHARACTERISTICS

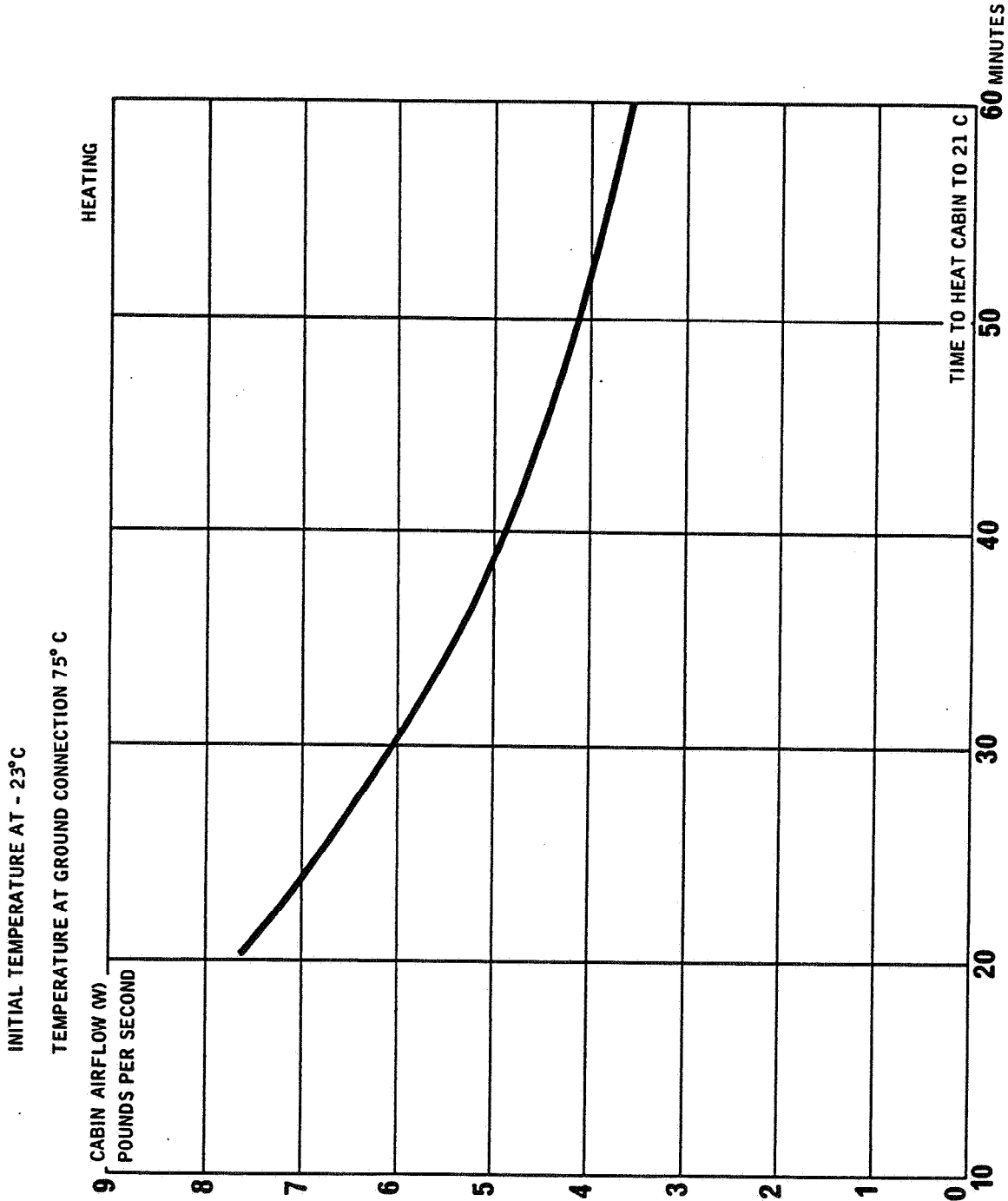

A A 5 05 06 00 0 AM 0

5.6 GROUND PNEUMATIC POWER REQUIREMENTS
5.6.1 HEATING (U.S. UNITS)
MODEL B2 - B4 - C4

Printed in France

A 300
AIRPLANE CHARACTERISTICS

Printed in France

A A 5 05 06 00 0 BM 0

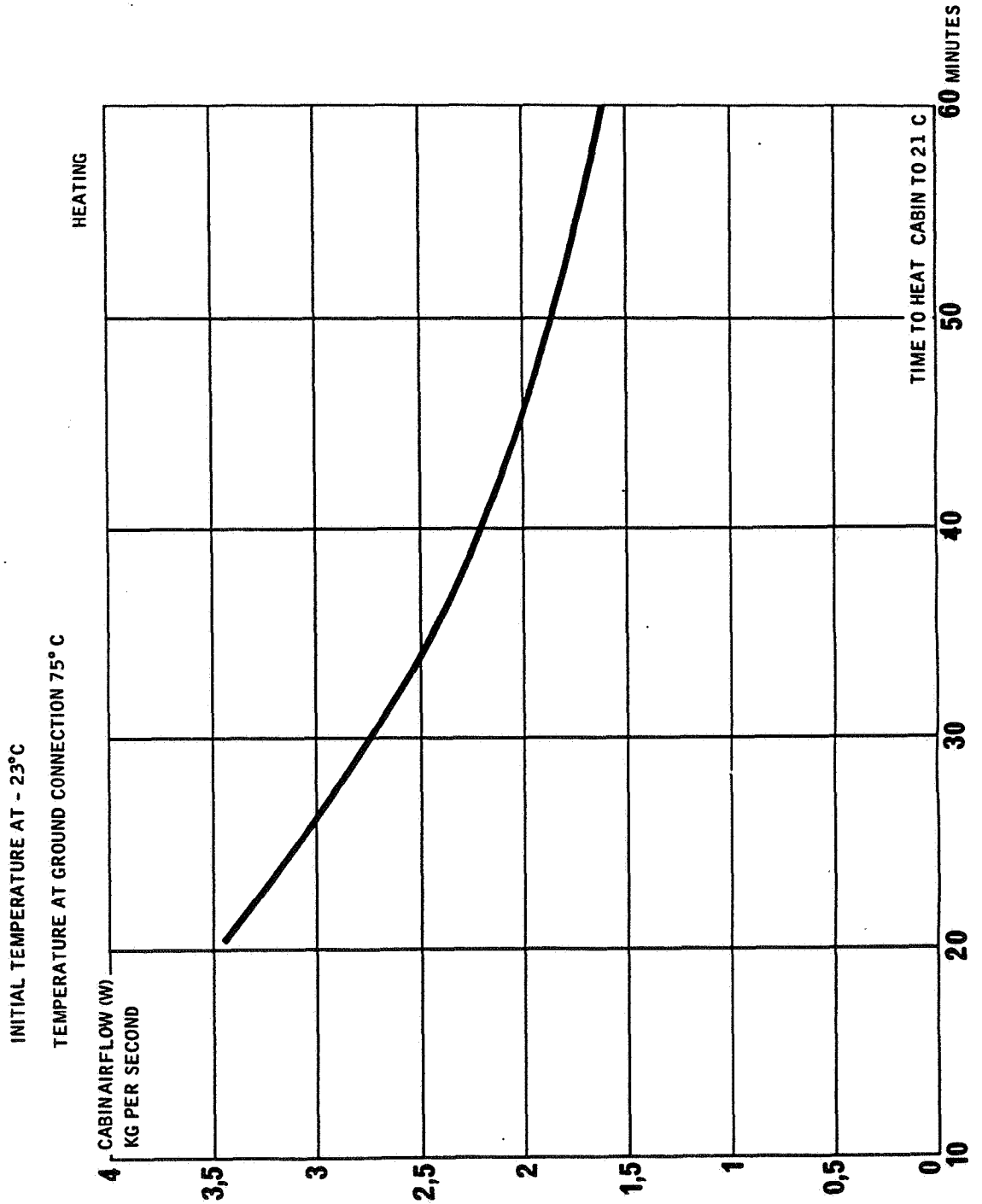

5.6 GROUND PNEUMATIC POWER REQUIREMENTS
5.6.2 HEATING (METRIC UNITS)
MODEL B2 - B4 - C4

A 300
AIRPLANE CHARACTERISTICS

A A 5 05 06 00 0 CM 0

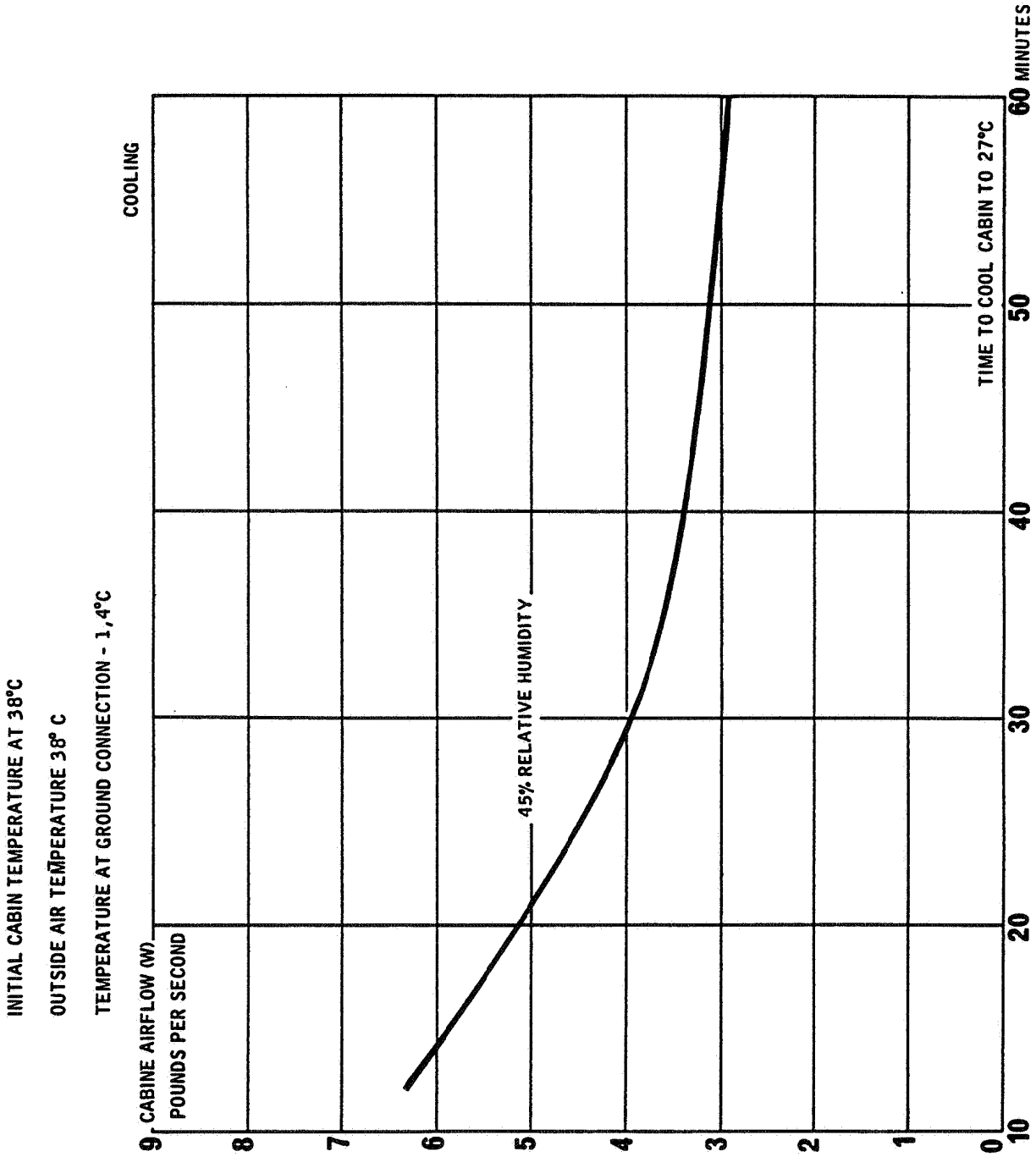

5.6 GROUND PNEUMATIC POWER REQUIREMENTS
5.6.3 COOLING (U.S. UNITS)
MODEL B2 - B4 - C4

A 300
AIRPLANE CHARACTERISTICS

Printed in France

A A 5 05 06 00 0 DM 0

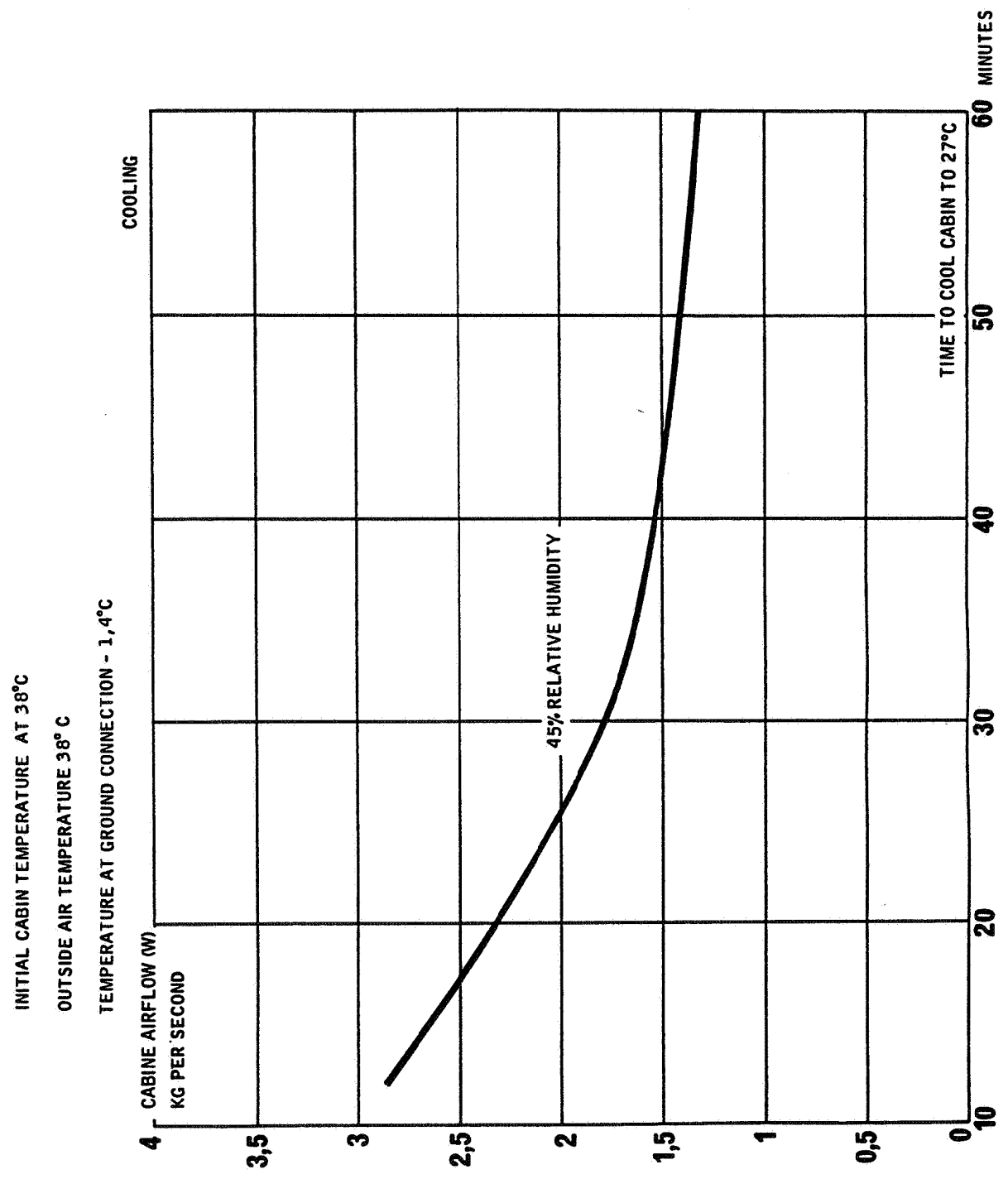

5.6 GROUND PNEUMATIC POWER REQUIREMENTS
5.6.4 COOLING (METRIC UNITS)
MODEL B2 - B4 - C4

A 300
AIRPLANE CHARACTERISTICS

R A A 5 05 06 00 EM 0
A 00 5 B P021 01 00 A

- 1 - CABIN AT 24° C PASSENGER AND CREW 279, NO GALLEY LOAD
BRIGHT DAY SOLAR LOAD 4330W, ELECTRICAL LOAD 4050W
- 2 - CABIN AT 26,7 C. ALL OTHER CONDITIONS SAME AS IN 1
- 3 - 4 - 5- CABIN AT 24° C. NO CREW OR PASSENGERS NO OTHER HEAT LOAD

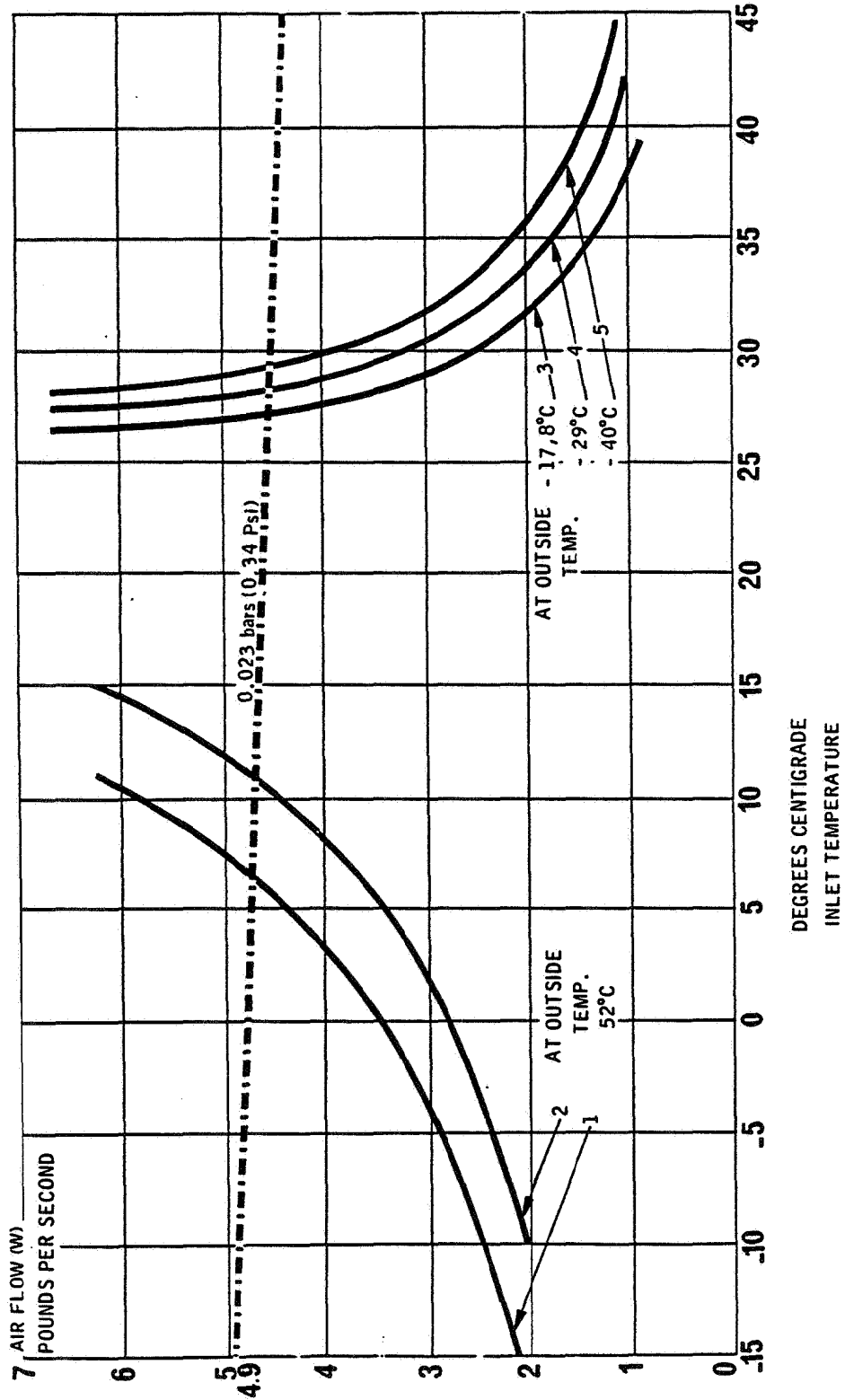

5.7 PRECONDITIONED AIRFLOW REQUIREMENTS
5.7.1 (U.S. UNITS)
MODEL B2 - B4 - C4

A 300
AIRPLANE CHARACTERISTICS

Printed in France

R A A 5 05 06 00 FM 0
A 00 5 B P022 01 00 A

- 1 - CABIN AT 24°C PASSENGER AND CREW 279. NO GALLEY LOAD
BRIGHT DAY SOLAR LOAD 4330W. ELECTRICAL LOAD 4050W
- 2 - CABIN AT 26,7°C. ALL OTHER CONDITIONS SAME AS IN 1
- 3 - 4 - 5 - CABIN AT 24°C. NO CREW OR PASSENGERS NO OTHER HEAT LOAD

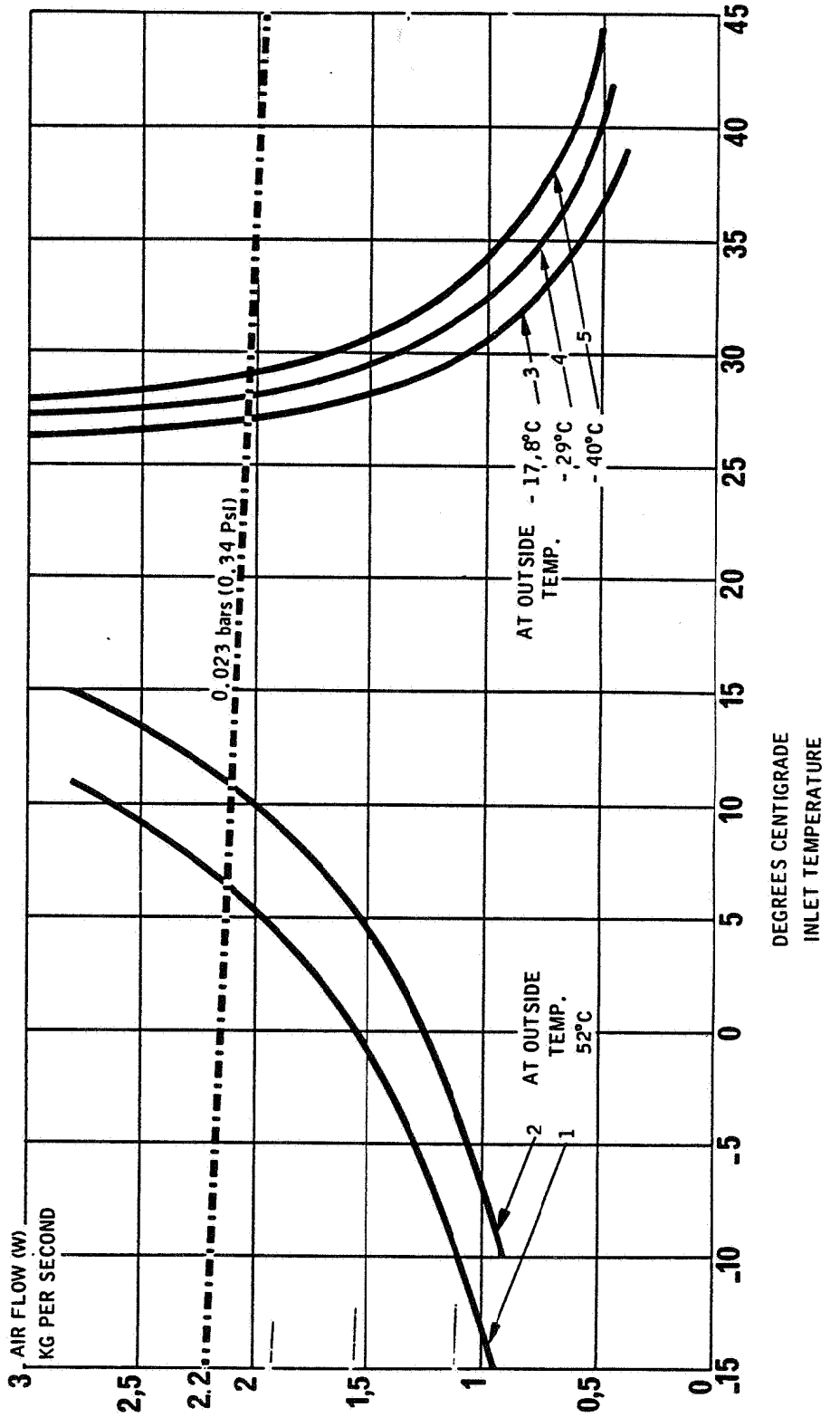

5.7 PRECONDITIONED AIRFLOW REQUIREMENTS
5.7.2 (METRIC UNITS)
MODEL B2 - B4 - C4

AIRBUS  INDUSTRIE
A 300
AIRPLANE CHARACTERISTICS

5.8 Ground Towing Requirements

The following charts show the drawbar pull needed to tow the A 300 under various conditions, and also the total load needed on the traction wheels to enable them to exert this pull without slipping. Chart 5-8-1 is in U.S. Units and chart 5-8-2 is in Metric Units.

EXAMPLE shown by broken line :

The airplane at a weight of 290,000 lb (131,542 kg) is being towed backwards on wet concrete up a 2% slope. Engines are not running. The drawbar pull required is 19,500 lb (8,845kg). The total weight on the traction wheels should be at least 33,000 lb (13,745 kg). If the airplane were being towed with engines running at idle thrust the pull required would be 24,050 lb (10,900 kg) and the traction wheels weight 42,350 lb (19,190 kg).

Printed in France

A 300

AIRPLANE CHARACTERISTICS

- UNUSUAL BREAKAWAY CONDITIONS NOT REFLECTED
- ESTIMATED FOR RUBBER TIERED TOW VEHICLES
- COEFFICIENTS OF FRICTION (μ) APPROXIMATE

Printed in France

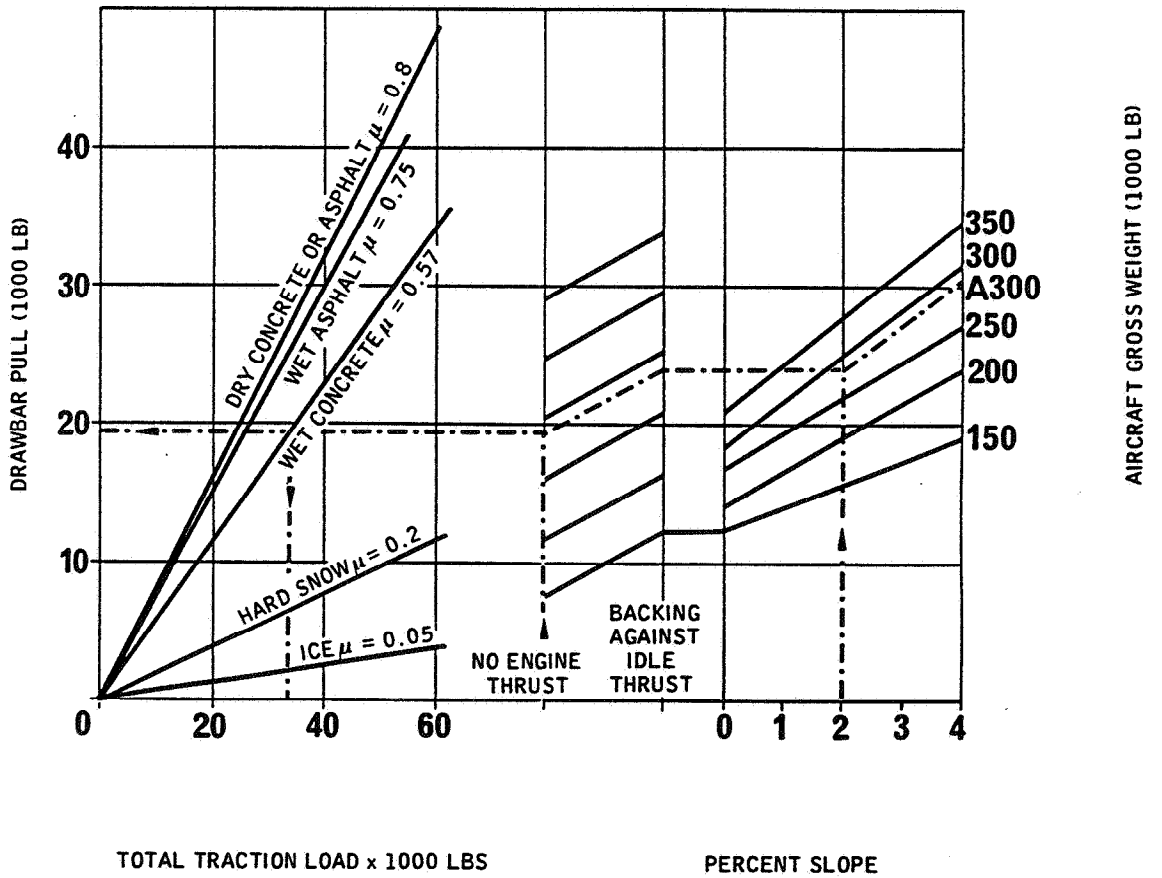

A A 5 05 08 00 0 AM 0

5.8 GROUND TOWING REQUIREMENTS

5.8.1 (U.S. UNITS)

MODEL B2 - B4 - C4

A 300

AIRPLANE CHARACTERISTICS

- UNUSUAL BREAKAWAY CONDITIONS NOT REFLECTED
- ESTIMATED FOR RUBBER TIRED TOW VEHICLES
- COEFFICIENTS OF FRICTION (μ) APPROXIMATE

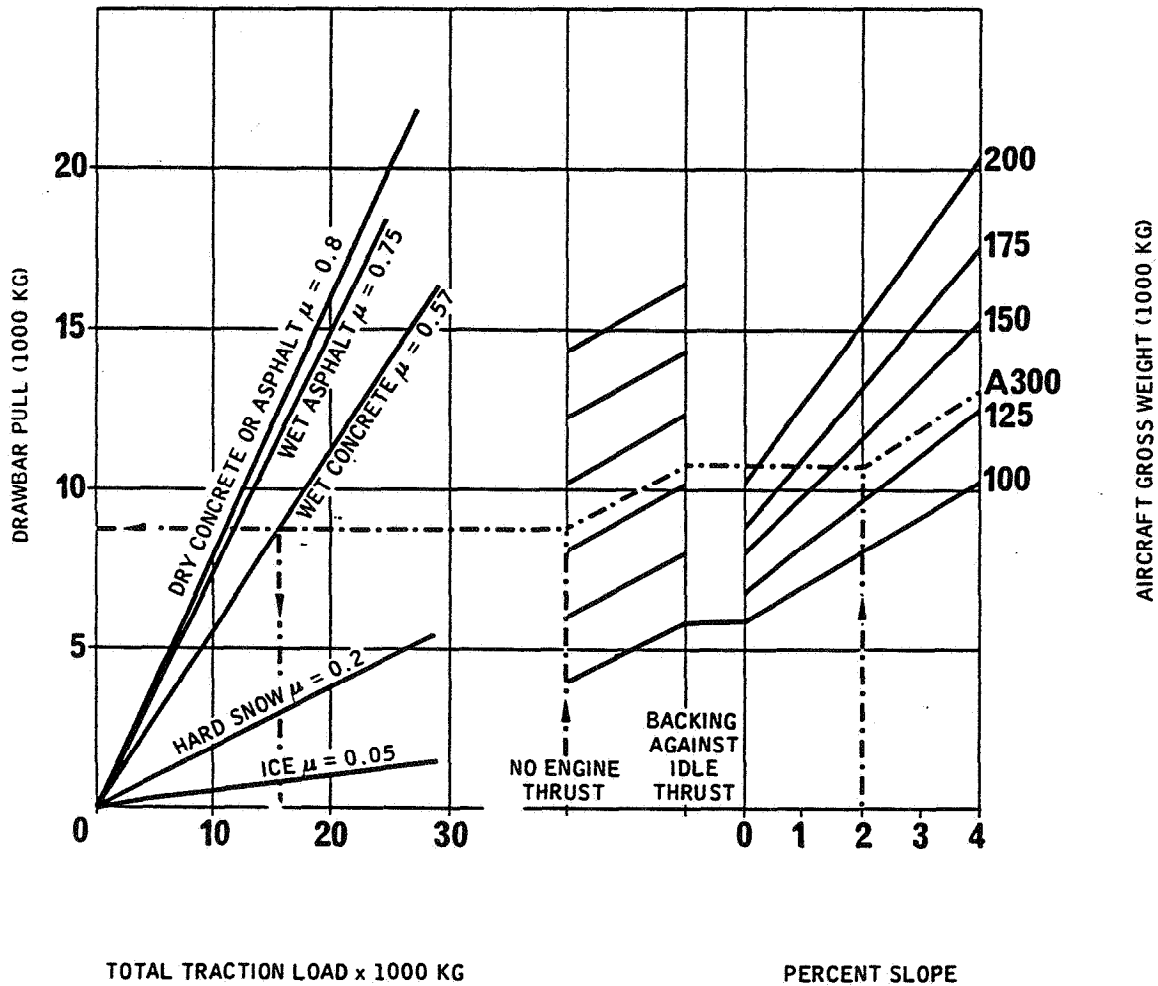

Printed in France

A A 5 05 08 00 0 BM 0

5.8 GROUND TOWING REQUIREMENTS

5.8.2 (METRIC UNITS)

MODEL B2 - B4 - C4

6.0 OPERATING CONDITIONS

6.1 Jet engine exhaust velocities and temperatures

- 6.1.1 Exhaust velocity contours - Breakaway power (U.S. units)
- 6.1.2 Exhaust velocity contours - Breakaway power (Metric units)
- 6.1.3 Exhaust temperature contours - Breakaway power (U.S. units)
- 6.1.4 Exhaust temperature contours - Breakaway power (Metric units)
- 6.1.5 Exhaust velocity contours - Take-off power (U.S. units)
- 6.1.6 Exhaust velocity contours - Take-off power (Metric units)
- 6.1.7 Exhaust temperature contours - Take-off power (U.S. units)
- 6.1.8 Exhaust temperature contours - Take-off power (Metric units)
- 6.1.9 Exhaust velocity contours - Idle power (U.S. units)
- 6.1.10 Exhaust velocity contours - Idle power (Metric units)
- 6.1.11 Exhaust temperature contours - Idle power (U.S. units)
- 6.1.12 Exhaust temperature contours - Idle power (Metric units)

6.2 Airport and communit noise

- 6.2.1 External noise
- 6.2.2 Noise data
- 6.2.3 APU noise levels

6.3 Danger areas of the engines

- 6.3.1 Danger areas forward of the engines (Ground idle)
- 6.3.2 Danger areas forward of the engines (Take-off)
- 6.3.3 Accoustic protection areas
- 6.3.4 APU - Exhaust Gas Temperature & Velocity

R - Definition of Breakaway Power

R Breakaway Power means the minimum power necessary for the aircraft
R to be able to start moving.

A A 5 06 01 01 0 AA 0

NOTE: ALL VELOCITY VALUES ARE STATUTE MILES PER HOUR.
 BREAKAWAY POWER - SEA LEVEL STATIC, ZERO WIND,
 STANDARD DAY, ZERO RAMP GRADIENT ENGINE TYPE.
 8 700 POUNDS OF THRUST

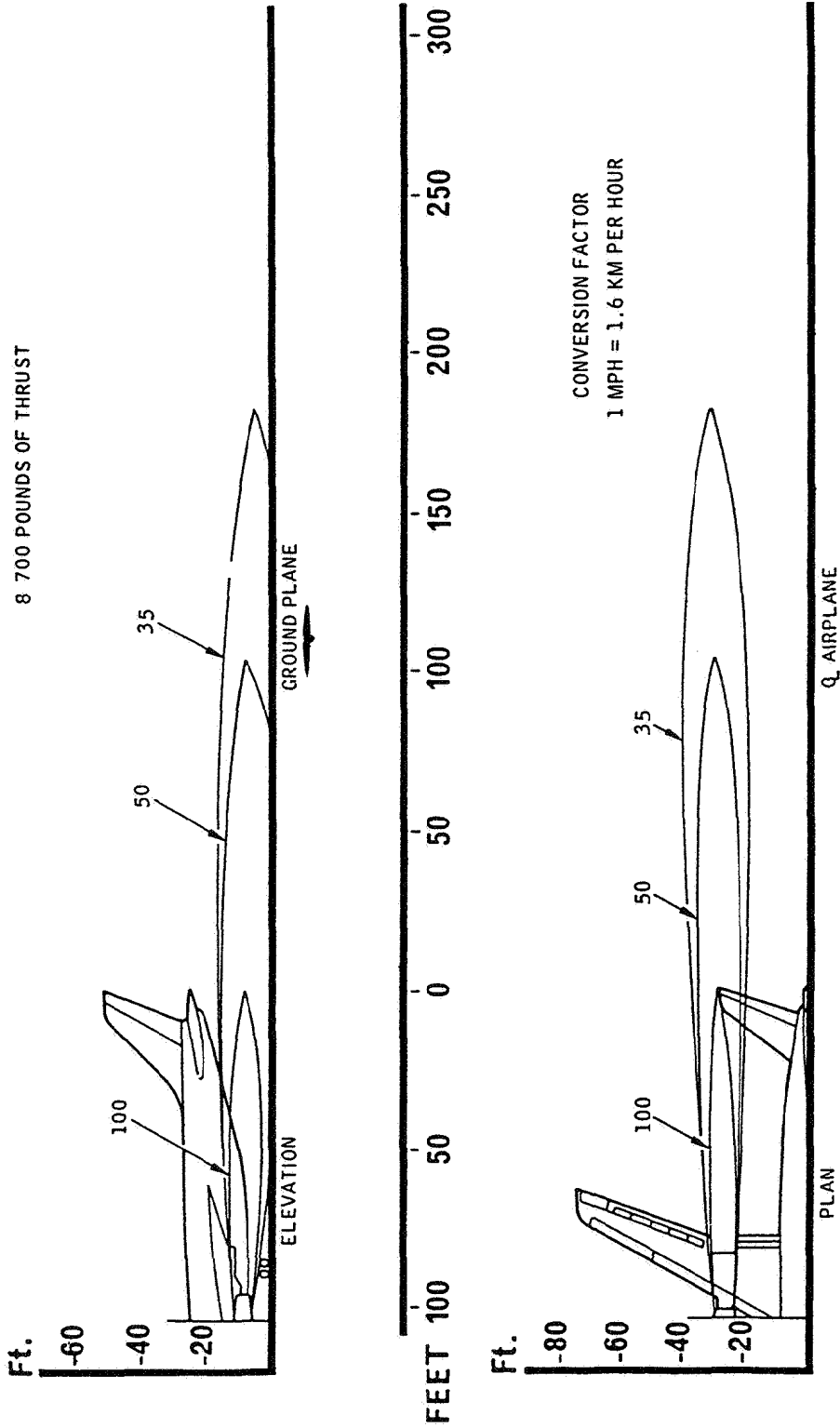

6.1 JET ENGINE EXHAUST VELOCITIES AND TEMPERATURES
6.1.1 EXHAUST VELOCITY CONTOURS - BREAKAWAY POWER (U.S. UNITS)
 MODEL B2 - B4 - C4

A 300
AIRPLANE CHARACTERISTICS

Printed in France

A A 5 06 01 01 0 A B 0

NOTE : ALL VELOCITY VALUES ARE STATUTE MILES PER HOUR.
BREAKAWAY POWER. SEA LEVEL STATIC, ZERO WIND,
STANDARD DAY, ZERO RAMP GRADIENT ENGINE TYPE
8700 POUNDS OF THRUST

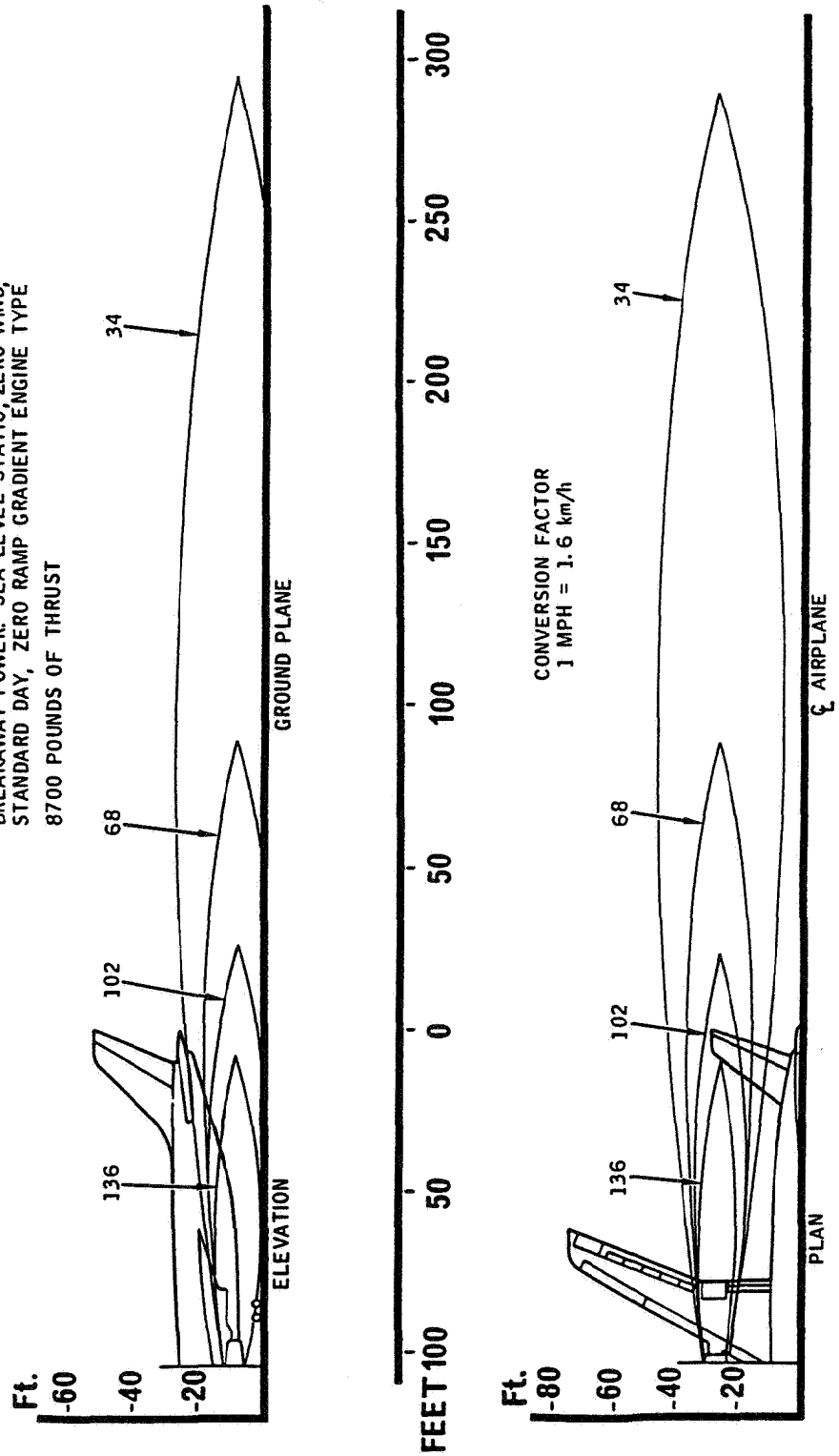

R

6.1 JET ENGINE EXHAUST VELOCITIES AND TEMPERATURES
6.1.1 EXHAUST VELOCITY CONTOURS - BREAKAWAY POWER (U.S. UNITS)
MODELS B2-320 AND B4-120

A 300
AIRPLANE CHARACTERISTICS

Printed in France

A A 5 06 01 02 0 AA 0

NOTE: ALL VELOCITY VALUES ARE STATUTE MILES PER HOUR.
BREAKAWAY POWER - SEA LEVEL STATIC, ZERO WIND,
STANDARD DAY, ZERO RAMP GRADIENT ENGINE TYPE.

8 700 POUNDS OF THRUST

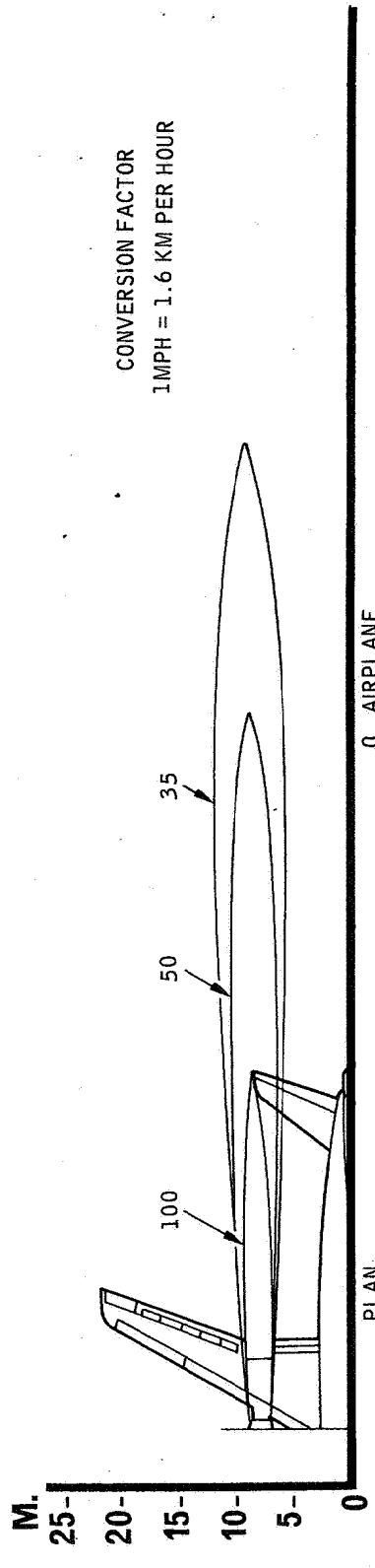
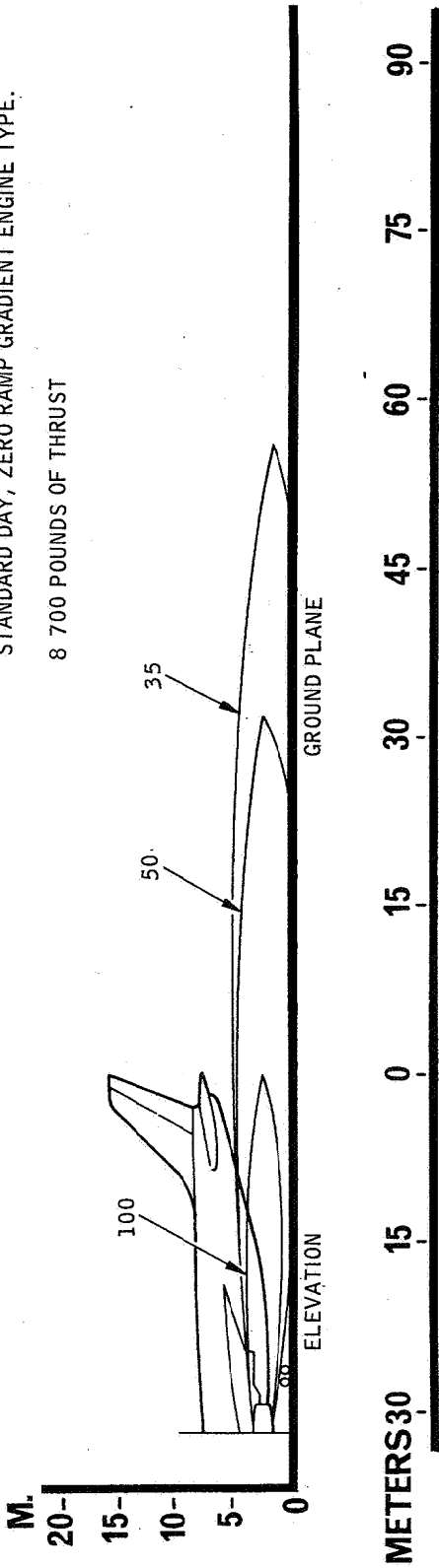

CONVERSION FACTOR
1MPH = 1.6 KM PER HOUR

R

6.1 JET ENGINE EXHAUST VELOCITIES AND TEMPERATURES
6.1.2 EXHAUST VELOCITY CONTOURS - BREAKAWAY POWER (METRIC UNITS)
MODEL B2 - B4 - C4

A 300
AIRPLANE CHARACTERISTICS

Printed in France

A A 5 06 01 02 0 A B 0

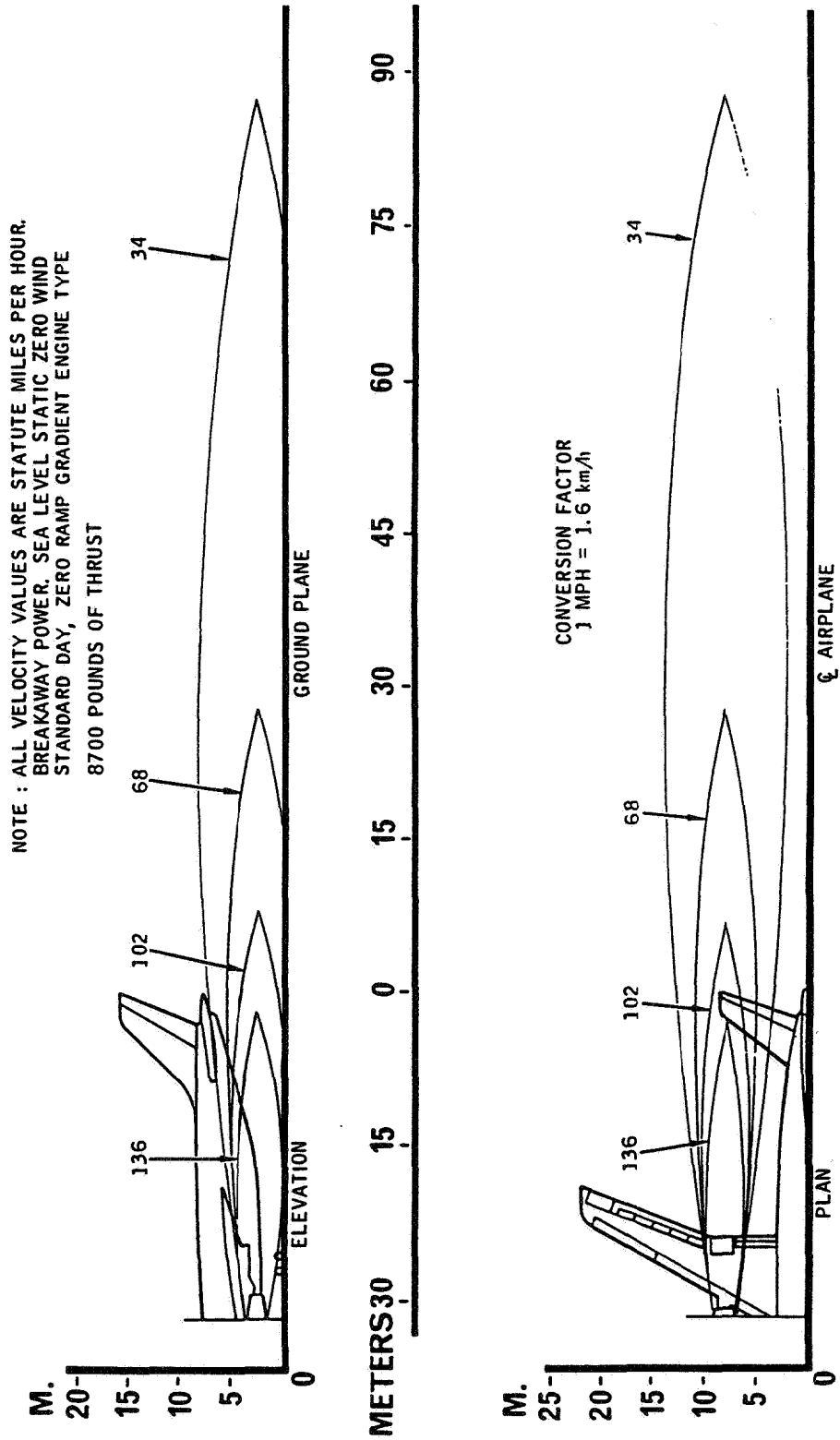

R

6.1 JET ENGINE EXHAUST VELOCITIES AND TEMPERATURES
6.1.2 EXHAUST VELOCITY CONTOURS - BREAKAWAY POWER (METRIC UNITS)
MODELS B2-320 AND B4-120

A 300
AIRPLANE CHARACTERISTICS

NOTE: ALL TEMPERATURES ARE IN DEGREES FAHRENHEIT.
BREAKAWAY POWER - SEAL LEVEL STATIC, ZERO WIND,
STANDARD DAY, ZERO RAMP GRADIENT ENGINE TYPE.

8 700 POUNDS OF THRUST

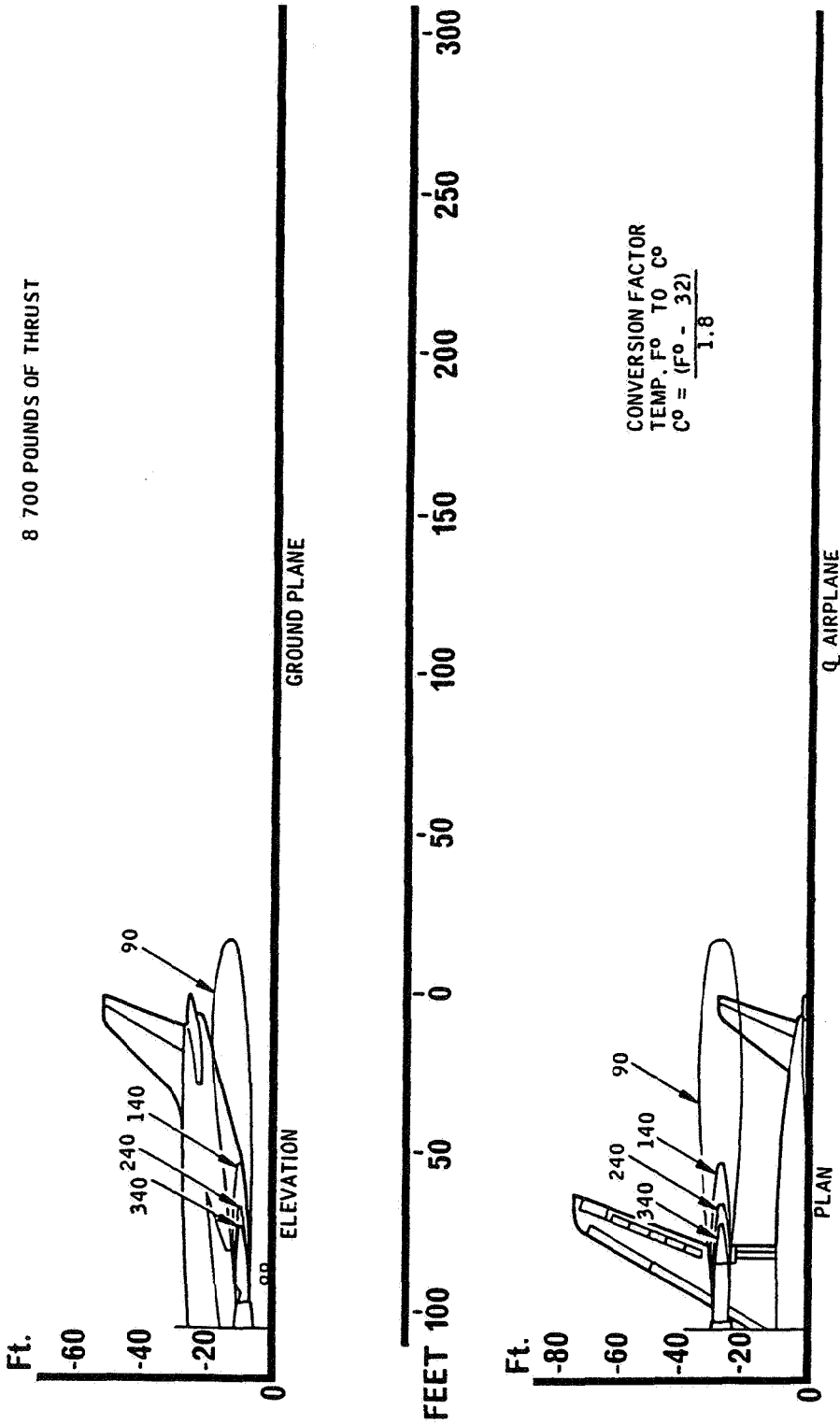

Printed in France

A A 5 06 01 03 0 AA 0

R

6.1 JET ENGINE EXHAUST VELOCITIES AND TEMPERATURES
6.1.3 EXHAUST TEMPERATURE CONTOURS - BREAKAWAY POWER (U.S. UNITS)
MODEL B2 - B4 - C4

A 300

AIRPLANE CHARACTERISTICS

A A 5 06 01 03 0 AB 0

NOTE : ALL TEMPERATURES ARE IN DEGREES FAHRENHEIT
BREAKAWAY POWER, SEA LEVEL STATIC, ZERO WIND
STANDARD DAY, ZERO RAMP GRADIENT, ENGINE TYPE,
8700 POUNDS OF THRUST

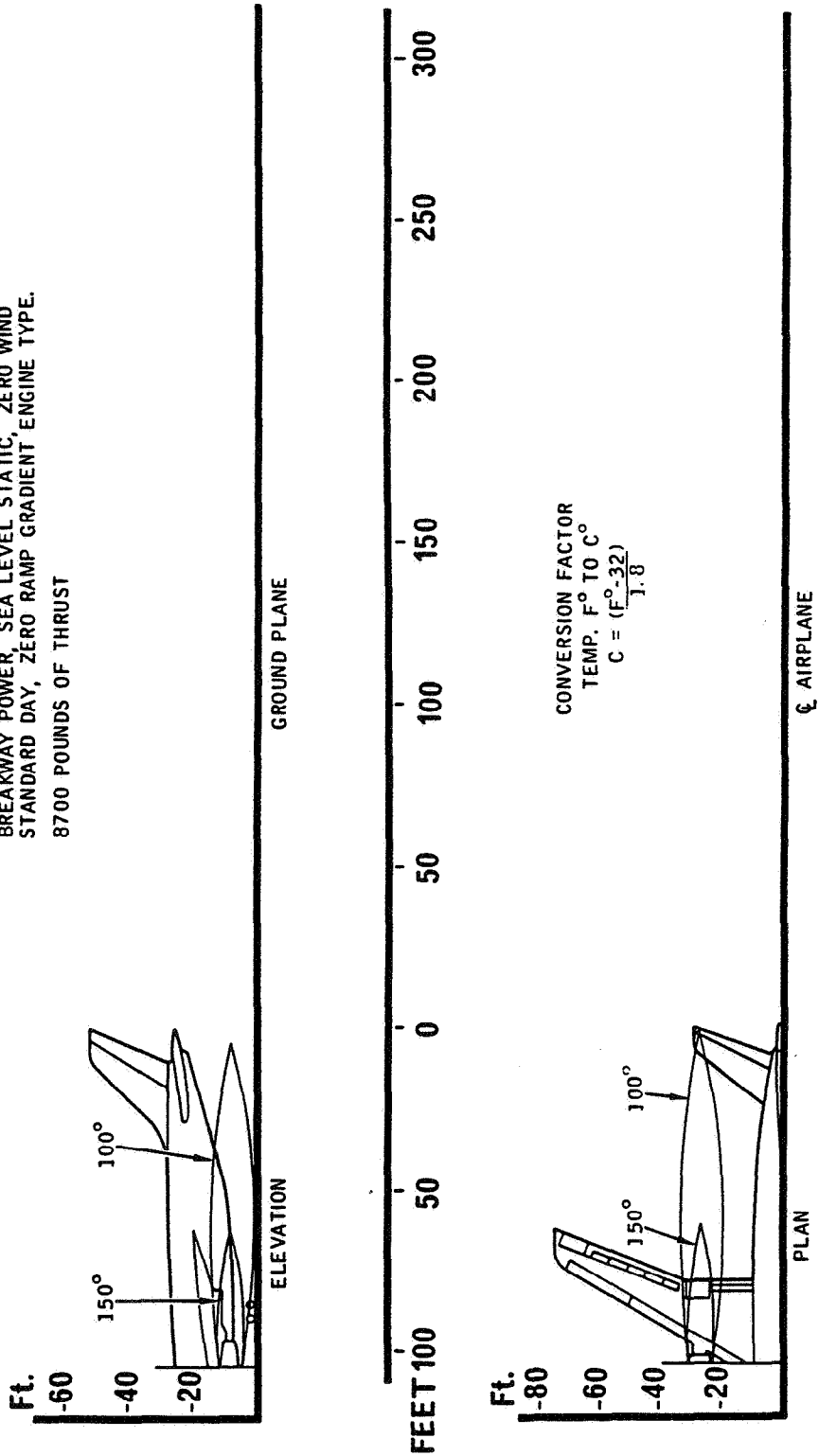

R

6.1 JET ENGINE EXHAUST VELOCITIES AND TEMPERATURES

6.1.3 EXHAUST TEMPERATURE CONTOURS - BREAKAWAY POWER (U.S. UNITS)

MODELS B2-320 AND B4-120

A 300
AIRPLANE CHARACTERISTICS

A A 5 06 01 04 0 AA 0

NOTE : ALL TEMPERATURES ARE IN DEGREES FAHRENHEIT.
BREAKAWAY POWER - SEAL LEVEL STATIC, ZERO WIND,
STANDARD DAY, ZERO RAMP GRADIENT ENGINE TYPE.

8 700 POUNDS OF THRUST

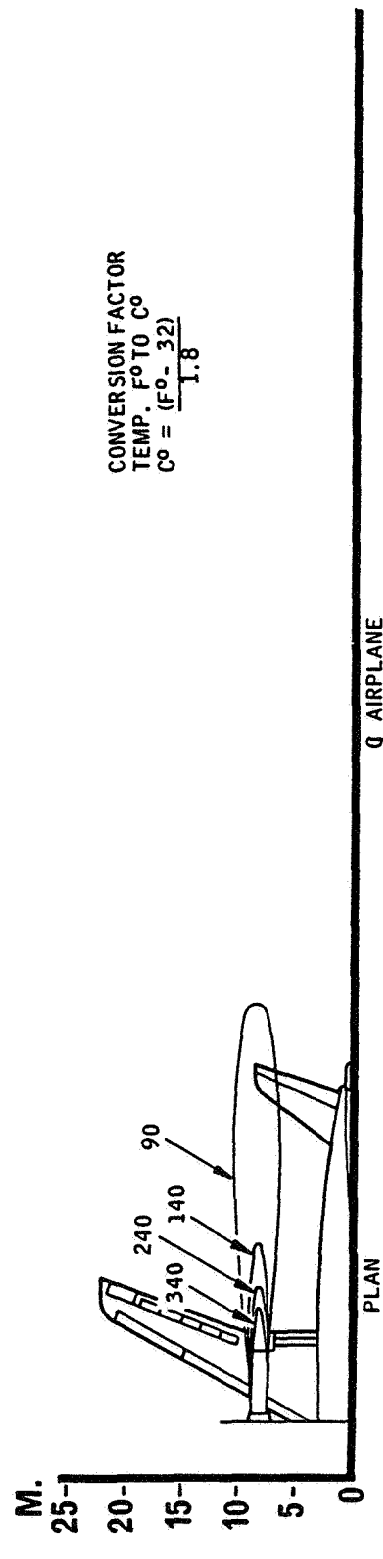
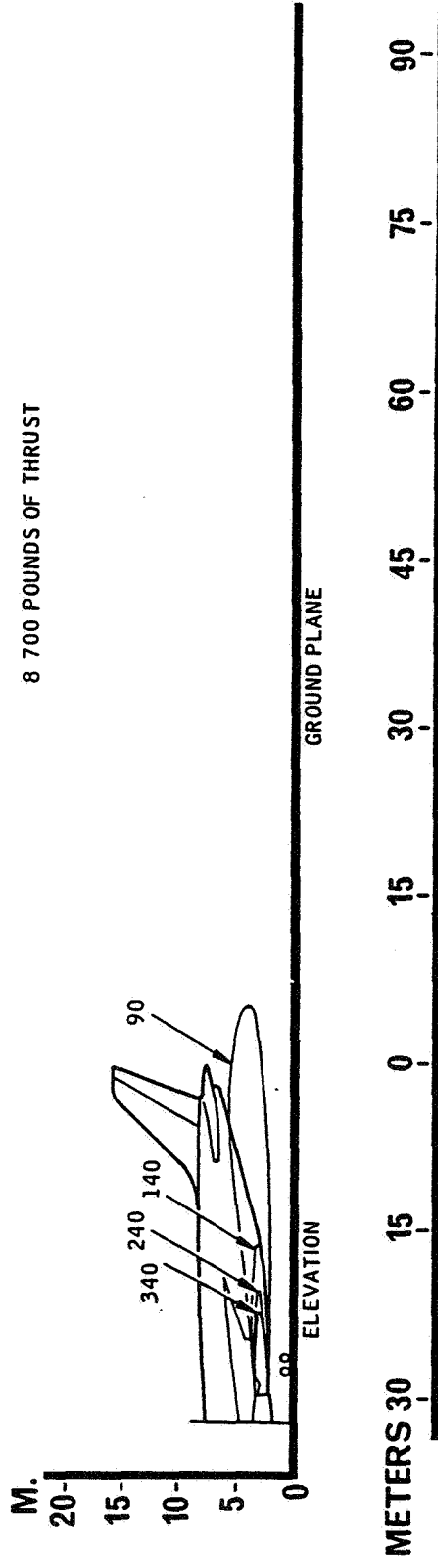

CONVERSION FACTOR
TEMP. F° TO C°
 $C° = \frac{F° - 32}{1.8}$

6.1 JET ENGINE EXHAUST VELOCITIES AND TEMPERATURES
6.1.4 EXHAUST TEMPERATURE CONTOURS - BREAKAWAY POWER (METRIC UNITS)
MODEL B2 - B4 - C4

A 300

AIRPLANE CHARACTERISTICS

Printed in France

A A 5 06 01 04 0 AB 01

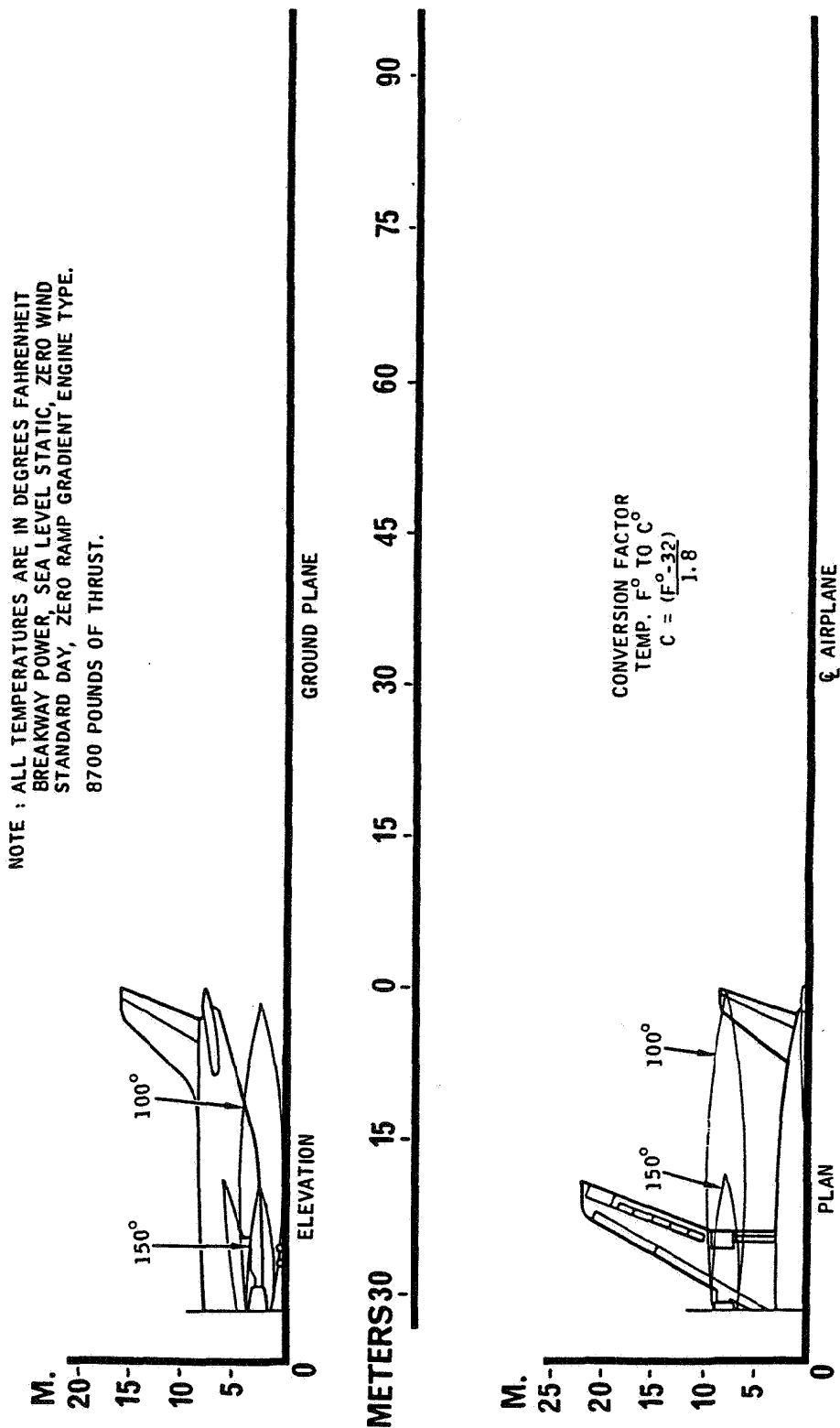

R

6.1 JET ENGINE EXHAUST VELOCITIES AND TEMPERATURES
 6.1.4 EXHAUST TEMPERATURE CONTOURS - BREAKAWAY POWER (METRIC UNITS)
 MODELS B2-320 AND B4-120

A 300
AIRPLANE CHARACTERISTICS

NOTE : ALL VELOCITY VALUES ARE STATUTE MILES PER HOUR.
TAKE OFF POWER - SEA LEVEL STATIC, ZERO WIND,
STANDARD DAY, ZERO RAMP GRADIENT ENGINE TYPE.

50 000 POUNDS OF THRUST

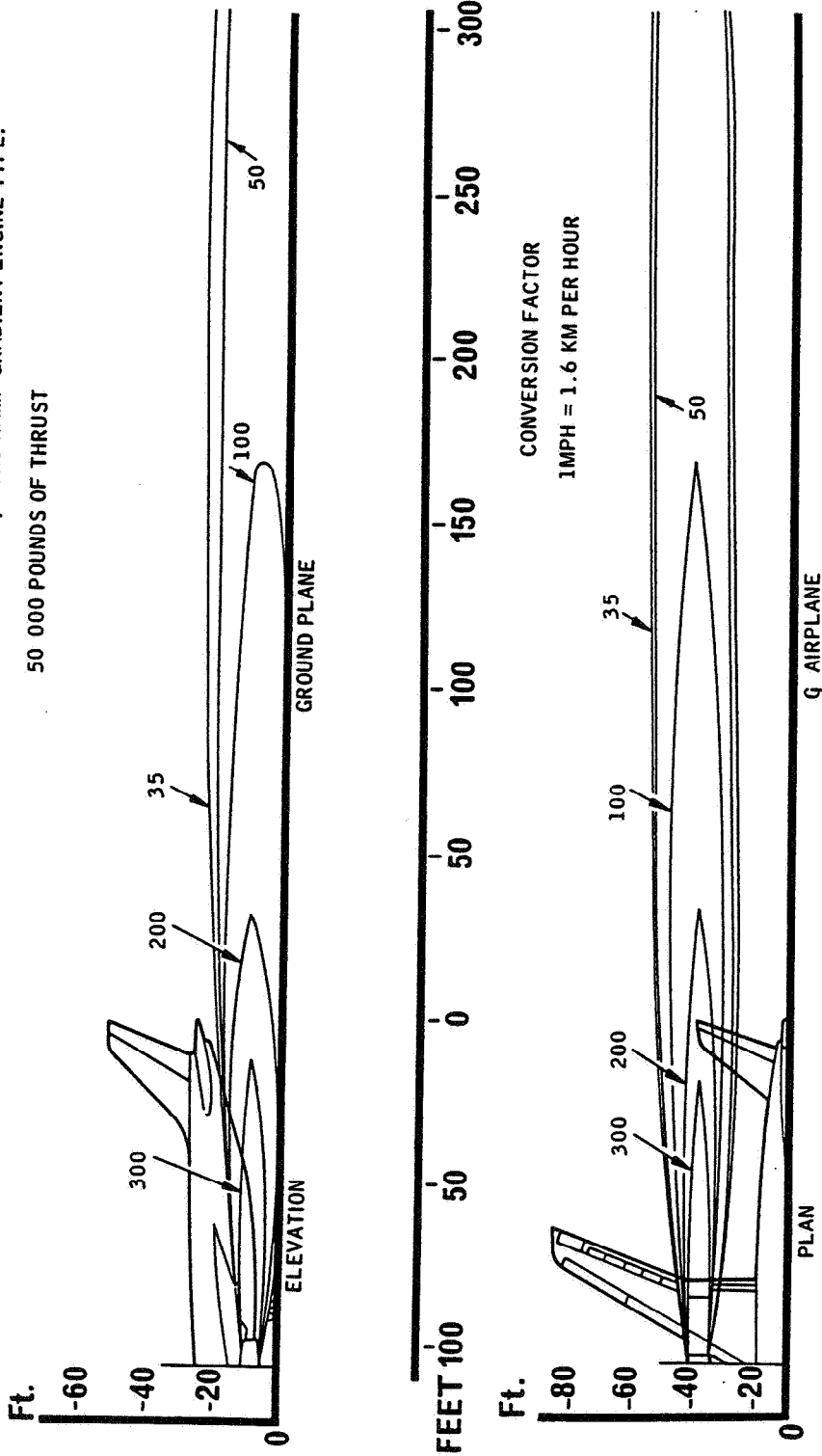

A A 5 06 01 05 0 AA 0

Printed in France

6.1 JET ENGINE EXHAUST VELOCITIES AND TEMPERATURES
6.1.5 EXHAUST VELOCITY CONTOURS - TAKEOFF POWER (U.S. UNITS)
MODEL B2 - B4 - C4

A 300
AIRPLANE CHARACTERISTICS

Printed in France

A A 5 06 01 05 0 AB 0

NOTE : ALL VELOCITY VALUES ARE STATUTE MILES PER HOUR
TAKEOFF POWER, SEA LEVEL STATIC, ZERO WIND
STANDARD DAY, ZERO RAMP GRADIENT ENGINE TYPE
51 720 POUNDS OF THRUST

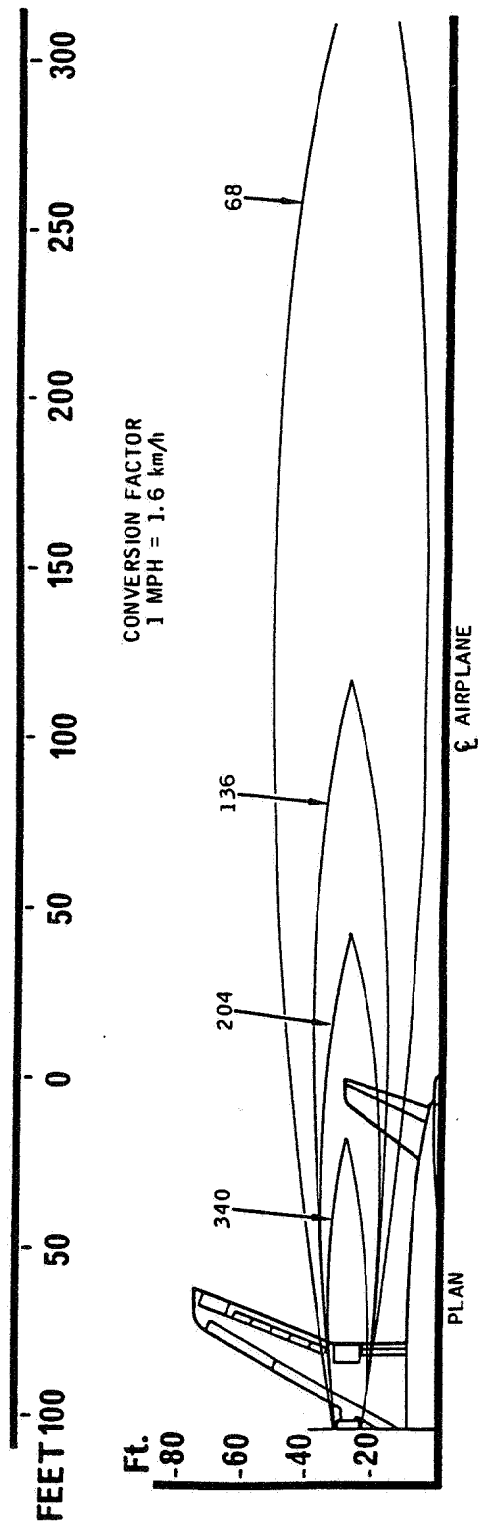
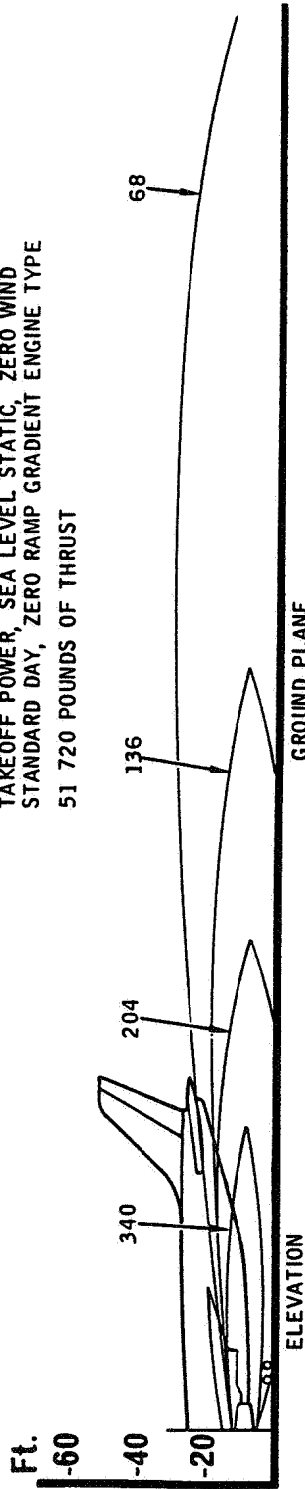

CONVERSION FACTOR
1 MPH = 1.6 km/h

R

6.1 JET ENGINE EXHAUST VELOCITIES AND TEMPERATURES
6.1.5 EXHAUST VELOCITY CONTOURS - TAKEOFF POWER (U.S.UNITS)
MODELS B2-320 AND B4-120

A 300
AIRPLANE CHARACTERISTICS

NOTE: ALL VELOCITY VALUES ARE STATUTE MILES PER HOUR.
TAKE OFF POWER - SEA LEVEL STATIC, ZERO WIND,
STANDARD DAY, ZERO RAMP GRADIENT ENGINE TYPE.

50 000 POUNDS OF THRUST

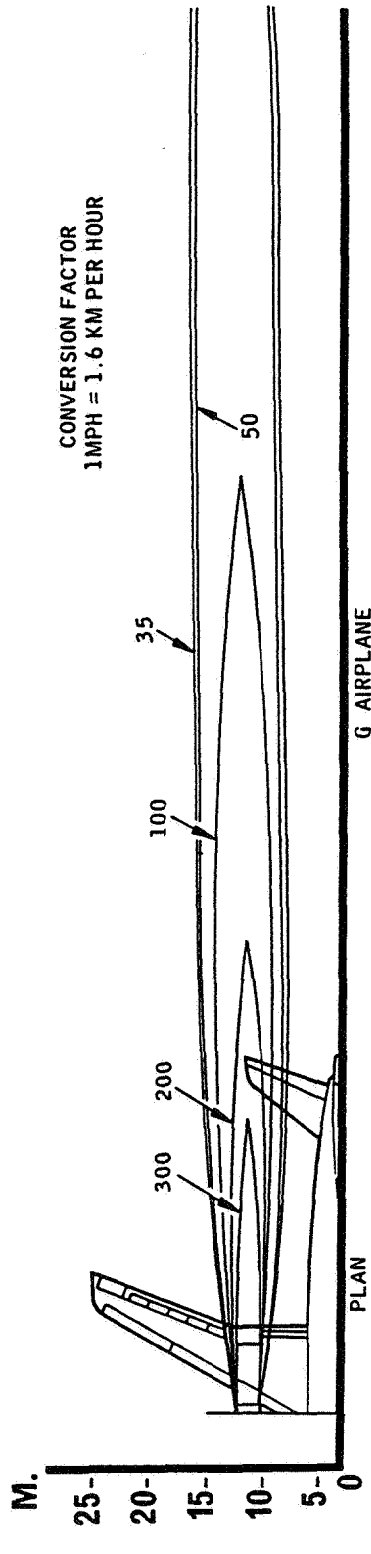
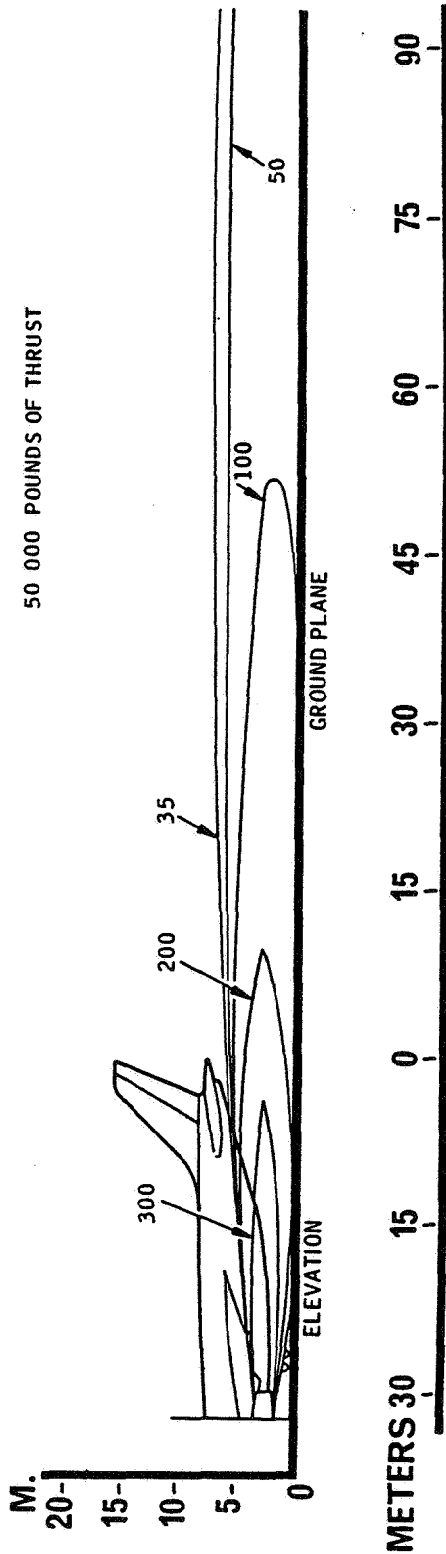

CONVERSION FACTOR
1MPH = 1.6 KM PER HOUR

A A 5 06 01 06 0 AA 0

6.1 JET ENGINE EXHAUST VELOCITIES AND TEMPERATURES
6.1.6 EXHAUST VELOCITY CONTOURS - TAKEOFF POWER (METRIC UNITS)
MODEL B2 - B4 - C4

A 300

AIRPLANE CHARACTERISTICS

Printed in France

A A 5 06 01 06 0 AB 0

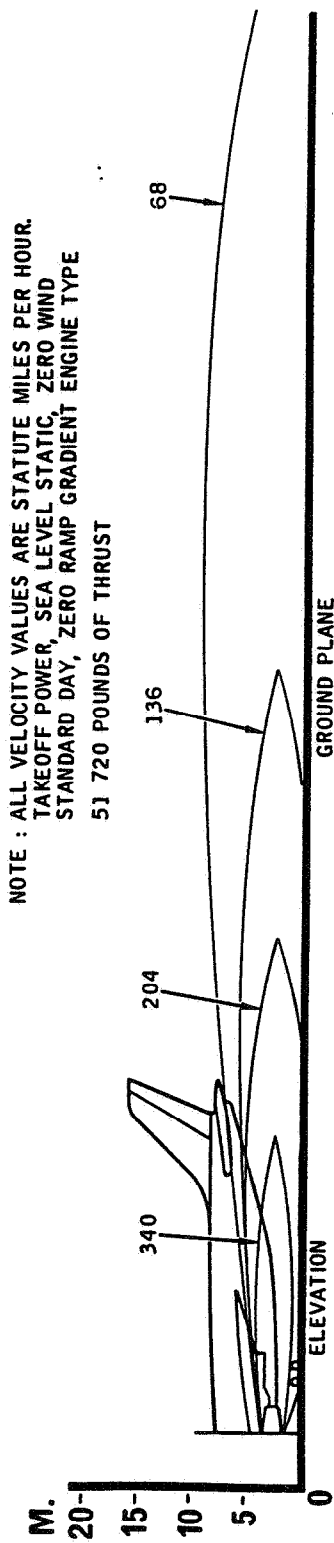

NOTE : ALL VELOCITY VALUES ARE STATUTE MILES PER HOUR.
 TAKEOFF POWER, SEA LEVEL STATIC, ZERO WIND
 STANDARD DAY, ZERO RAMP GRADIENT ENGINE TYPE
 51 720 POUNDS OF THRUST

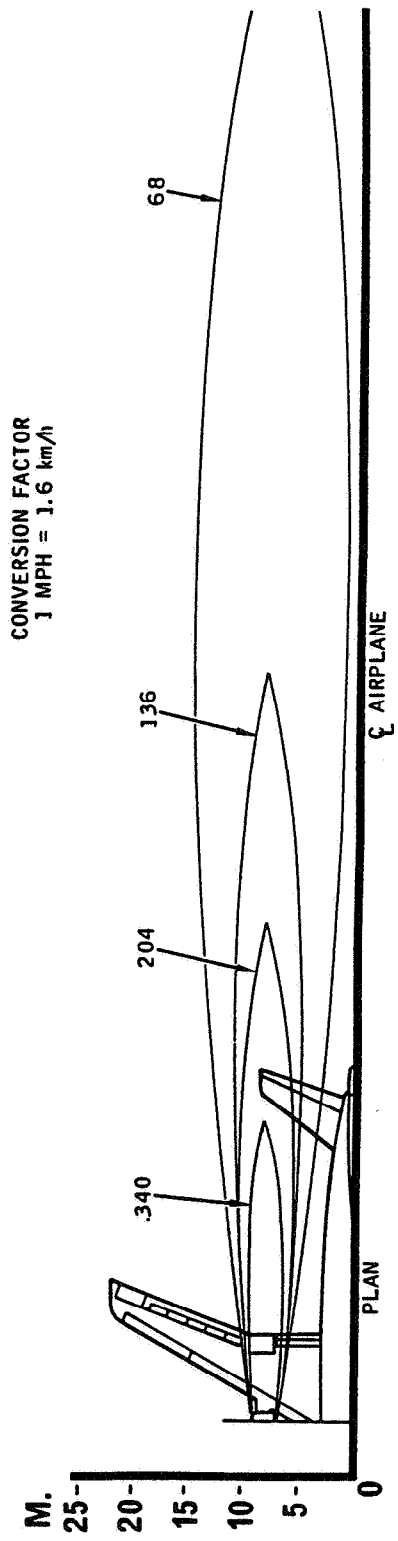

CONVERSION FACTOR
 1 MPH = 1.6 km/h

R

6.1 JET ENGINE EXHAUST VELOCITIES AND TEMPERATURES
 6.1.6 EXHAUST VELOCITY CONTOURS - TAKEOFF POWER (METRIC UNITS)
 MODELS B2-320 AND B4-120

A 300

AIRPLANE CHARACTERISTICS

NOTE : ALL TEMPERATURES ARE IN DEGREES FAHRENHEIT.
TAKE OFF POWER - SEA LEVEL STATIC, ZERO WIND,
STANDARD DAY, ZERO RAMP GRADIENT ENGINE TYPE.

50 000 POUNDS OF THRUST

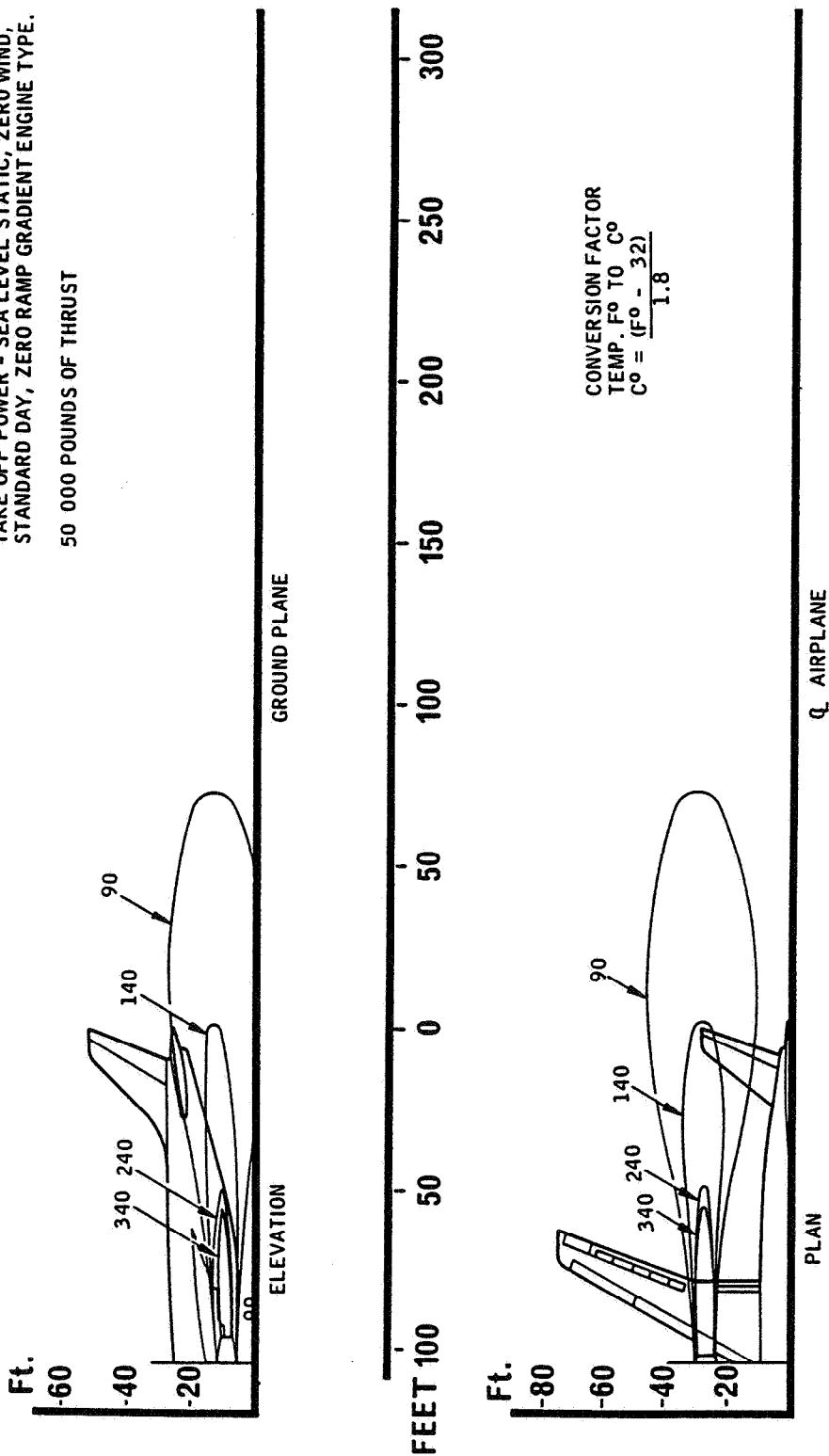

Printed in France

A A 5 06 01 07 0 AA 0

R 6.1 JET ENGINE EXHAUST VELOCITIES AND TEMPERATURES
6.1.7 EXHAUST TEMPERATURE CONTOURS TAKEOFF POWER (U.S. UNITS)
MODEL B2 - B4 - C4

A 300
AIRPLANE CHARACTERISTICS

Printed in France

A A 5 06 01 07 0 AB 0

NOTE : ALL TEMPERATURES ARE IN DEGREES FAHRENHEIT
TAKEOFF POWER, SEA LEVEL STATIC, ZERO WIND
STANDARD DAY, ZERO RAMP GRADIENT ENGINE TYPE.
51 720 POUNDS OF THRUST.

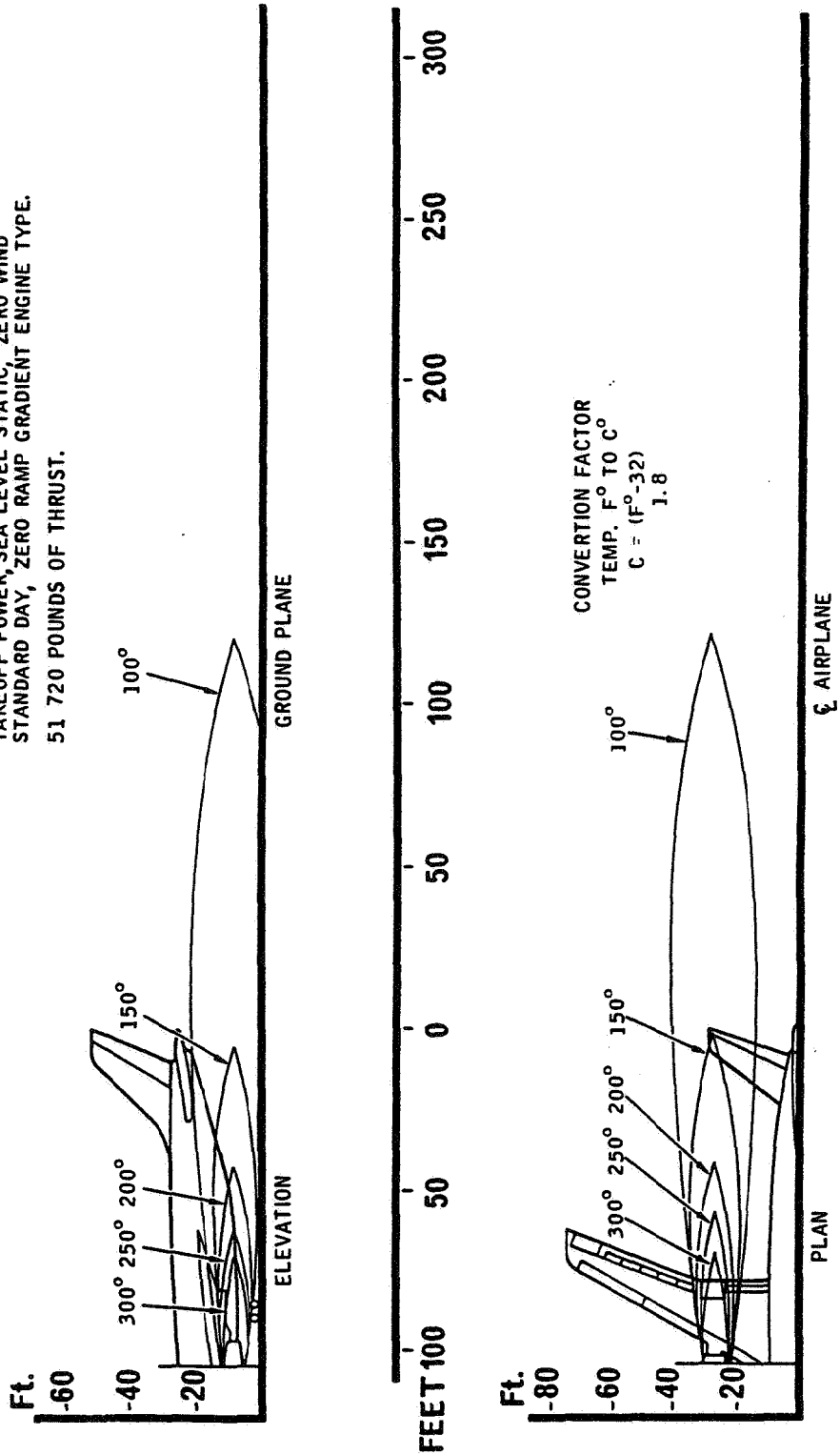

R

6.1 JET ENGINE EXHAUST VELOCITIES AND TEMPERATURES
6.1.7 EXHAUST TEMPERATURE CONTOURS - TAKEOFF POWER (U.S. UNITS)
MODELS B2-320 AND B4-120

A 300
AIRPLANE CHARACTERISTICS

NOTE : ALL TEMPERATURES ARE IN DEGREES FAHRENHEIT.
TAKE OFF POWER - SEA LEVEL STATIC, ZERO WIND,
STANDARD DAY, ZERO RAMP GRADIENT ENGINE TYPE.
50 000 POUNDS OF THRUST

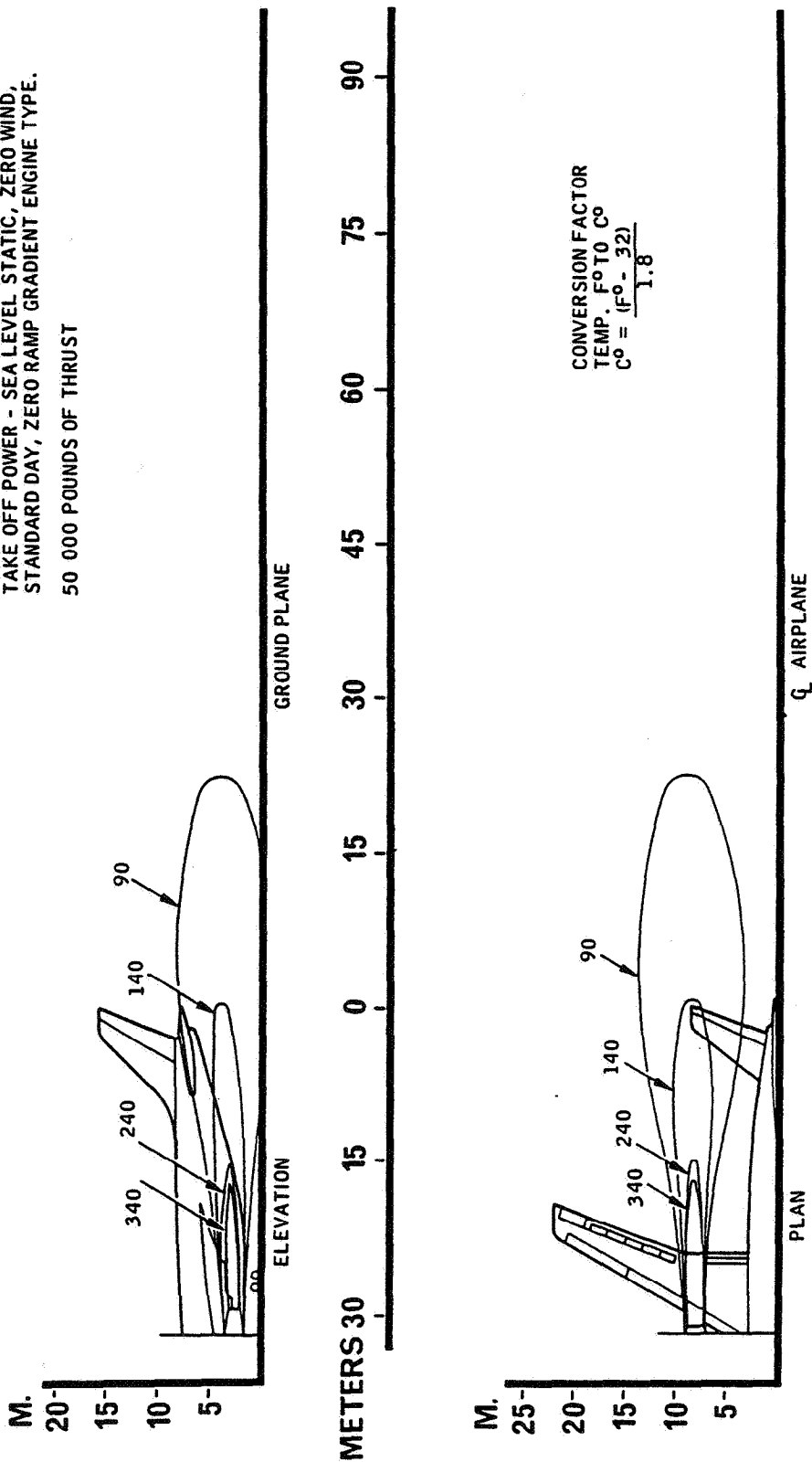

6.1 JET ENGINE EXHAUST VELOCITIES AND TEMPERATURES
6.1.8 EXHAUST TEMPERATURE CONTOURS TAKEOFF POWER (METRIC UNITS)
MODEL B2 - B4 - C4

A A 5 06 01 08 0 AA 0

Printed in France

A 300

AIRPLANE CHARACTERISTICS

A A 5 06 01 08 0 AB 0

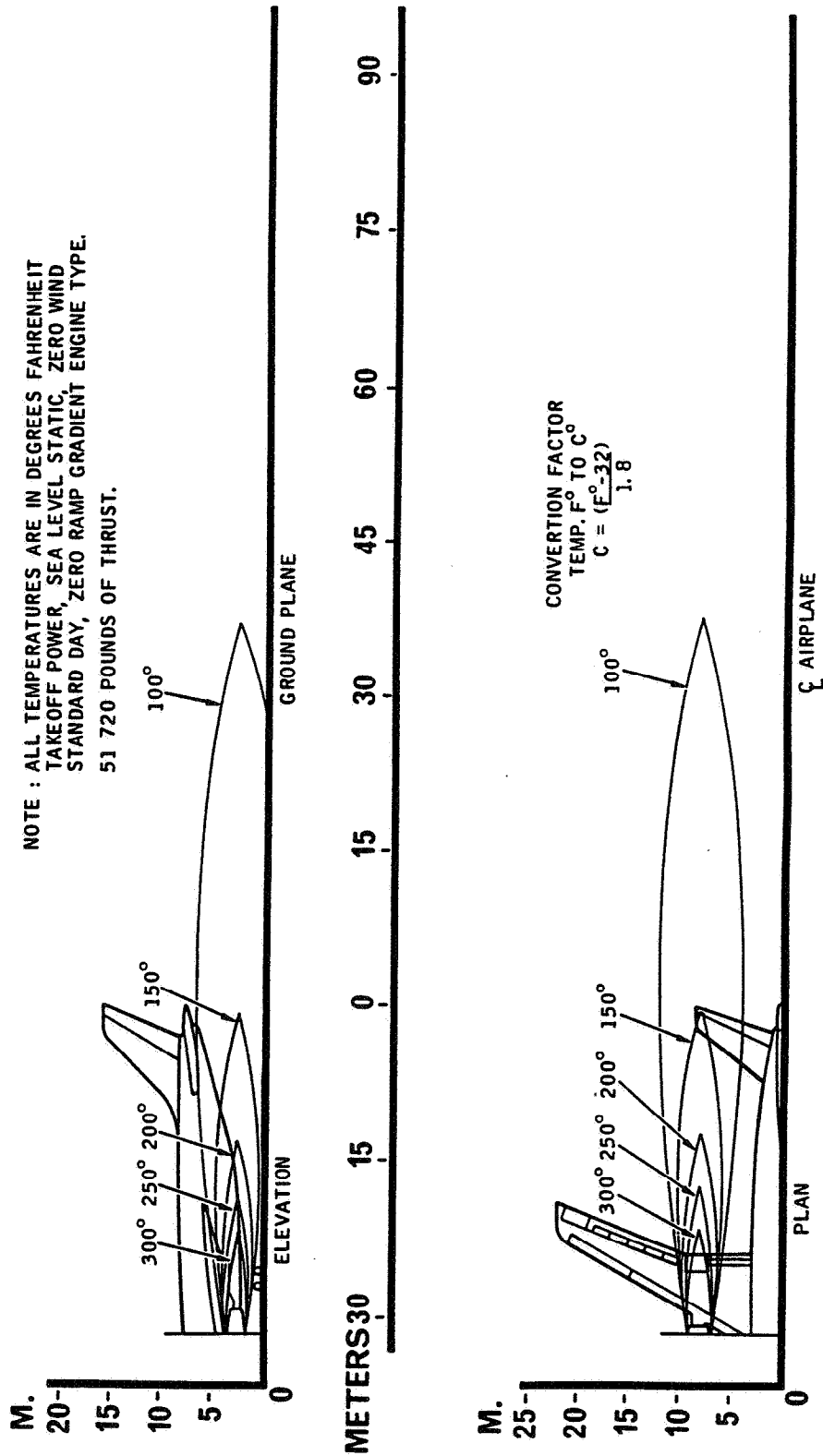

R

6.1 JET ENGINE EXHAUST VELOCITIES AND TEMPERATURES

6.1.8 EXHAUST TEMPERATURE CONTOURS - TAKEOFF POWER (METRIC UNITS)

MODELS B2-320 AND B4-120

A 300

AIRPLANE CHARACTERISTICS

NOTE: ALL VELOCITY VALUES ARE STATUTE MILES PER HOUR.
 GROUND IDLE POWER - SEA LEVEL STATIC, ZERO WIND,
 STANDARD DAY, ZERO RAMP GRADIENT ENGINE TYPE.

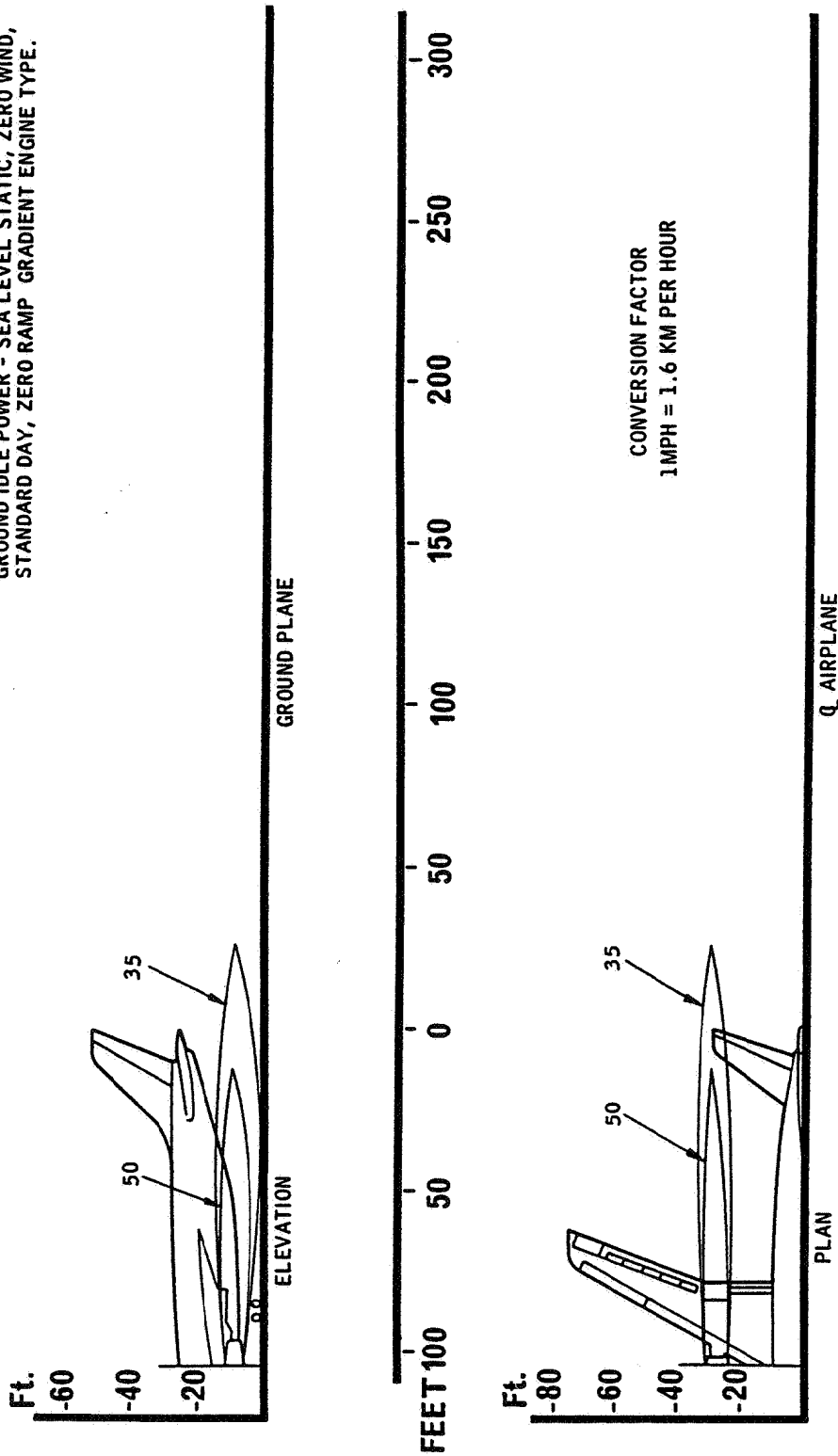

A A 5 06 01 09 0 AA 0

Printed in France

6.1 JET ENGINE EXHAUST VELOCITIES AND TEMPERATURES
 6.1.9 EXHAUST VELOCITY CONTOURS - IDLE POWER (U.S. UNITS)
 MODEL B2 - B4 - C4

A A 5 06 01 09 0 A B 0

NOTE : ALL VELOCITY VALUES ARE STATUTE MILES PER HOUR.
GROUND IDLE POWER, SEA LEVEL STATIC, ZERO WIND
STANDARD DAY, ZERO RAMP GRADIENT ENGINE TYPE

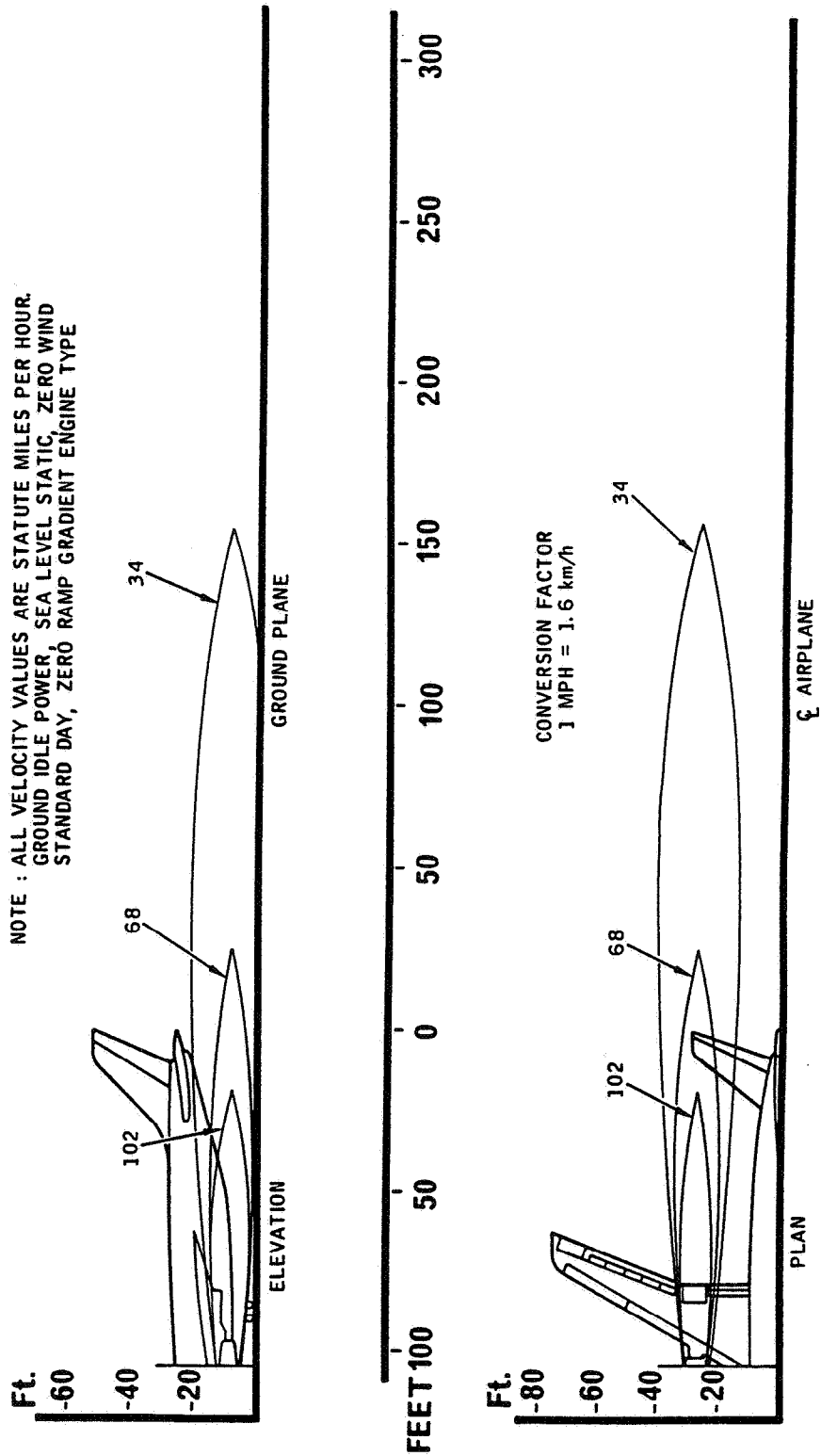

R

6.1 JET ENGINE EXHAUST VELOCITIES AND TEMPERATURES
 6.1.9 EXHAUST VELOCITY CONTOURS - IDLE POWER (U.S. UNITS)
 MODELS B2-320 AND B4-120

A 300
AIRPLANE CHARACTERISTICS

NOTE : ALL VELOCITY VALUES ARE STATUTE MILES PER HOUR.
GROUND IDLE POWER - SEA LEVEL STATIC, ZERO WIND,
STANDARD DAY, ZERO RAMP GRADIENT ENGINE TYPE.

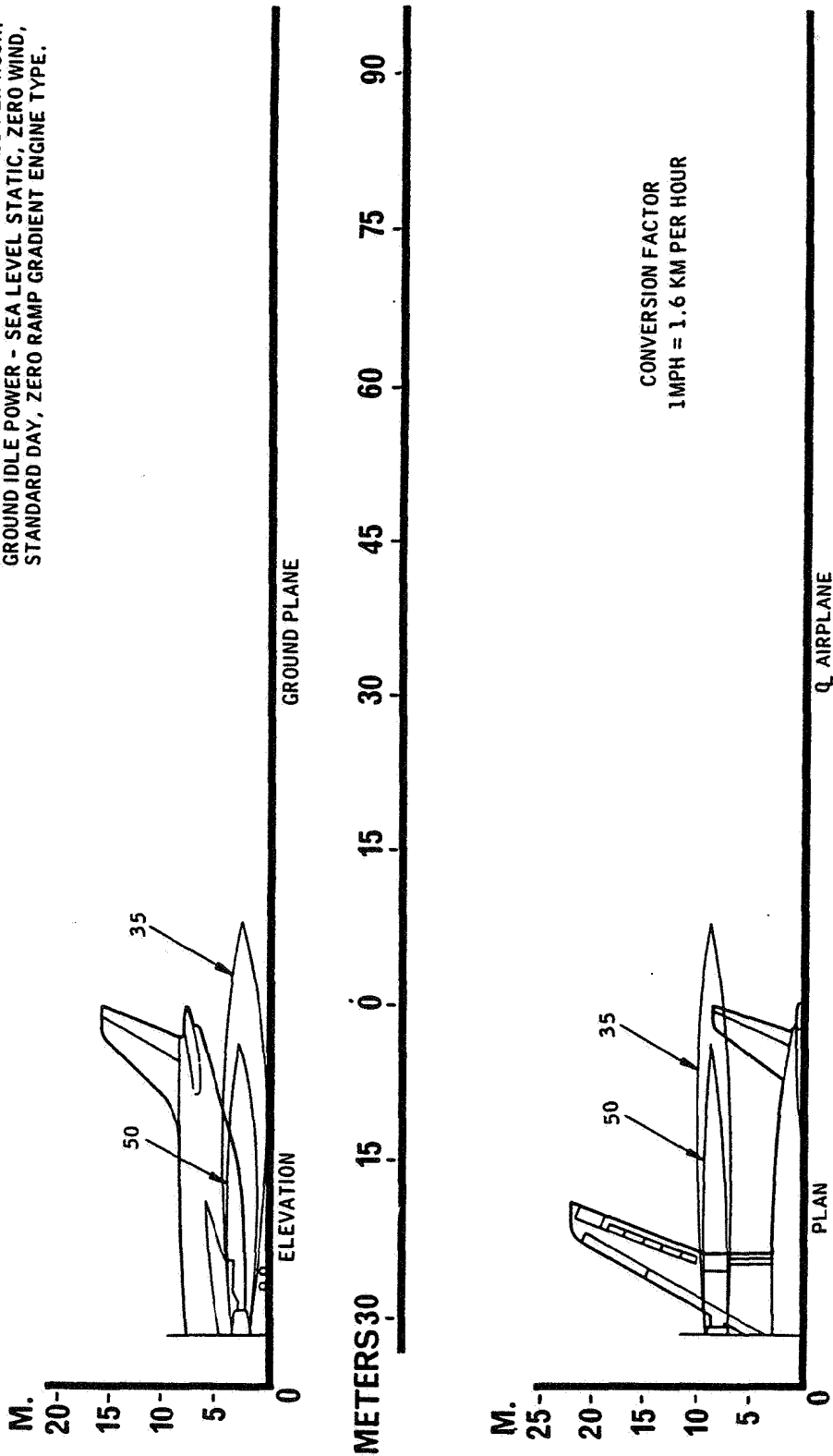

6.1 JET ENGINE EXHAUST VELOCITIES AND TEMPERATURES
6.1.10 EXHAUST VELOCITY CONTOURS - IDLE POWER (METRIC UNITS)
MODEL B2 - B4 - C4

A A 5 06 01 10 0 AA 0

Printed in France

Printed in France

- A A 5 06 01 10 0 A B 0'

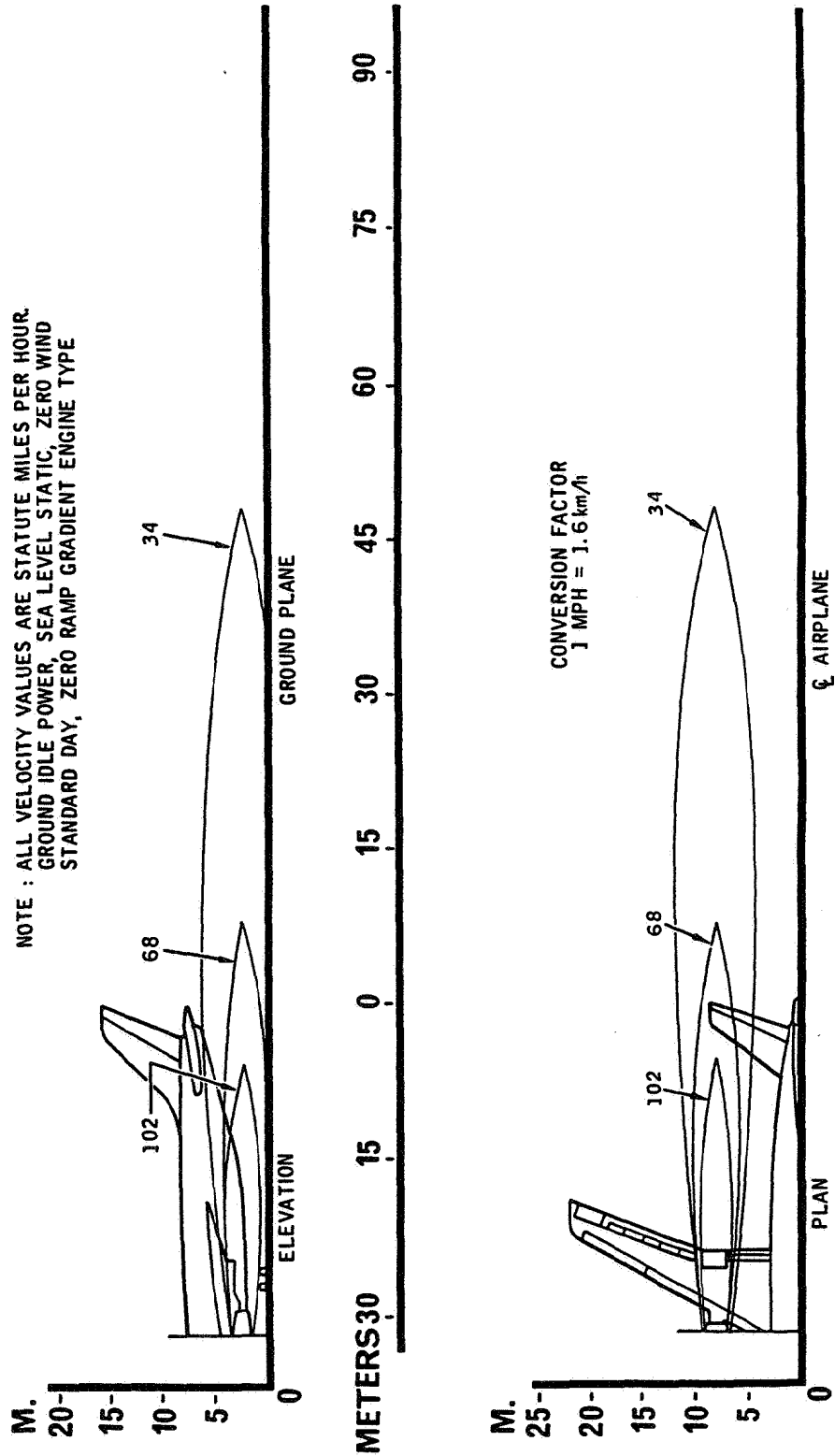

R

6.1 JET ENGINE EXHAUST VELOCITIES AND TEMPERATURES
6.1.10 EXHAUST VELOCITY CONTOURS - IDLE POWER (METRIC UNITS)
MODELS B2-320 AND B4-120

A 300
AIRPLANE CHARACTERISTICS

A A 5 06 01 11 0 AA 0

NOTE : ALL TEMPERATURES ARE IN DEGREES FAHRENHEIT.
GROUND IDLE POWER - SEA LEVEL STATIC, ZERO WIND,
STANDARD DAY, ZERO RAMP GRADIENT ENGINE TYPE.

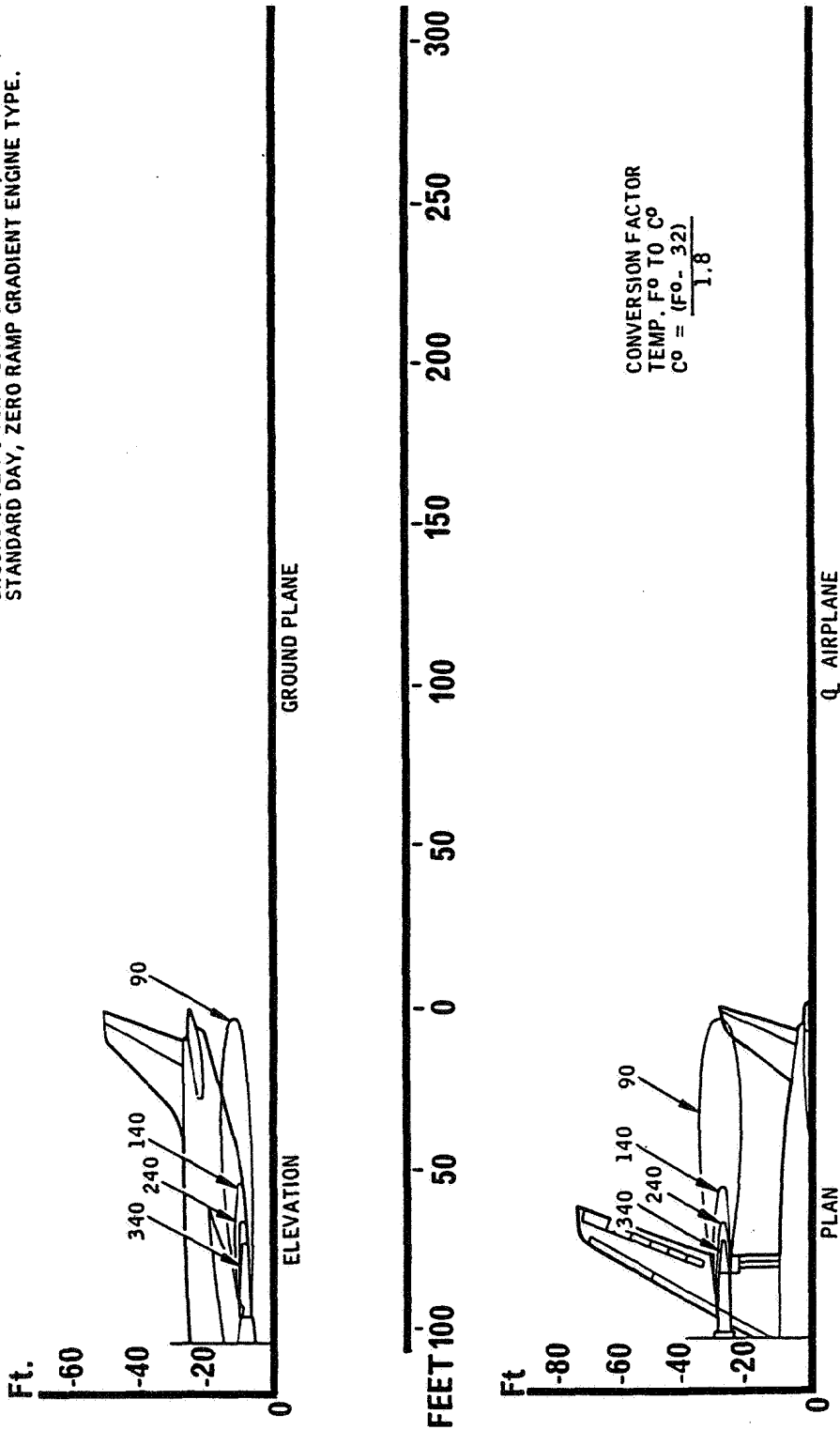

Printed in France

R

6.1 JET ENGINE EXHAUST VELOCITIES AND TEMPERATURES
6.1.11 EXHAUST TEMPERATURE CONTOURS - IDLER POWER (U.S. UNITS)
MODEL B2 - B4 - C4

A 300

AIRPLANE CHARACTERISTICS

Printed in France

A A 5 06 01 11 0 A B 0

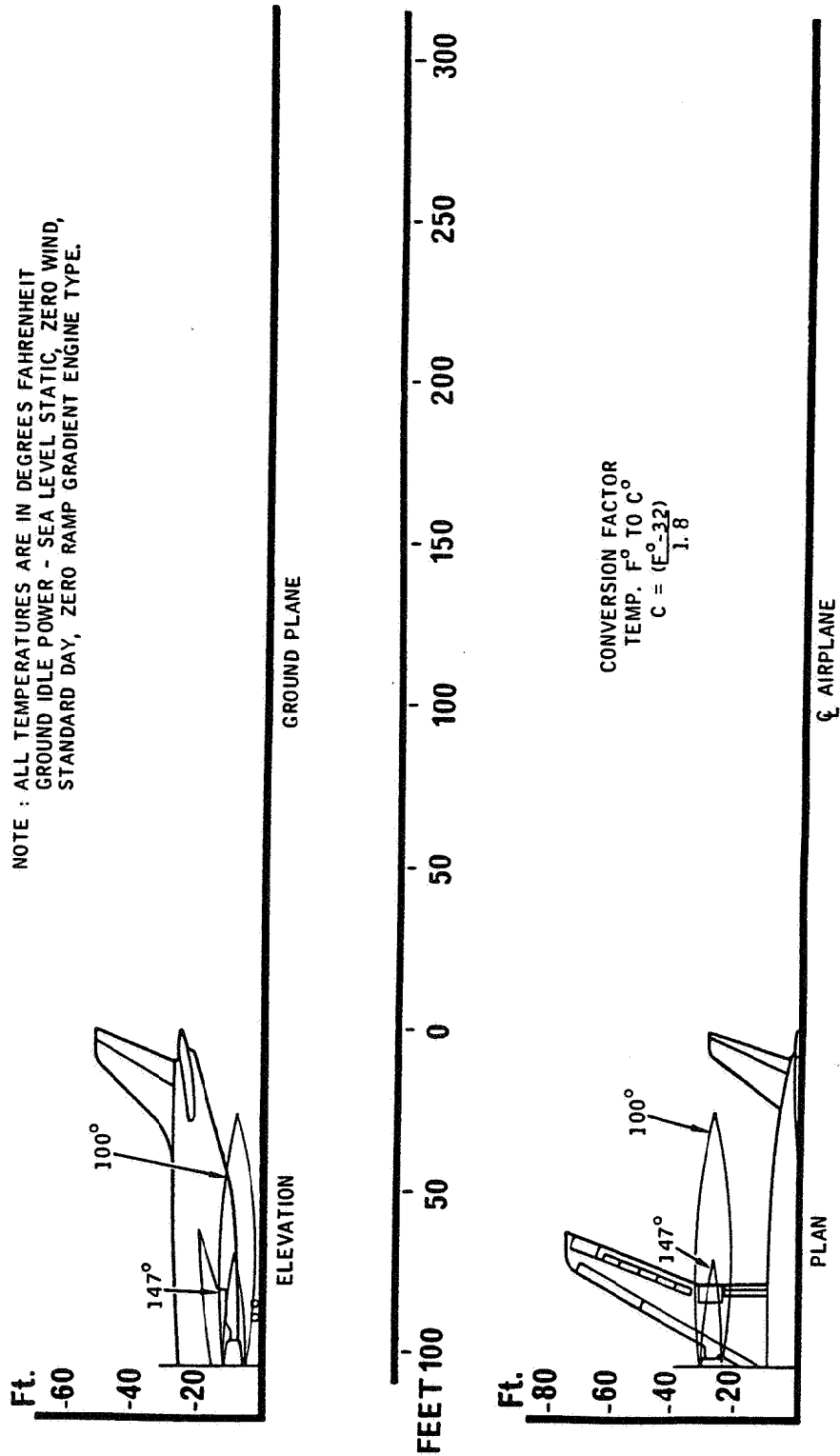

R

6.1 JET ENGINE EXHAUST VELOCITIES AND TEMPERATURES
6.1.11 EXHAUST TEMPERATURE CONTOURS - IDLE POWER (U.S. UNITS)
MODELS B2-320 AND B4-120

A 300
AIRPLANE CHARACTERISTICS

A A 5 06 01 12 0 AA 0

NOTE : ALL TEMPERATURES ARE IN DEGREES FAHRENHEIT.
GROUND IDLE POWER - SEA LEVEL STATIC, ZERO WIND,
STANDARD DAY, ZERO RAMP GRADIENT ENGINE TYPE.

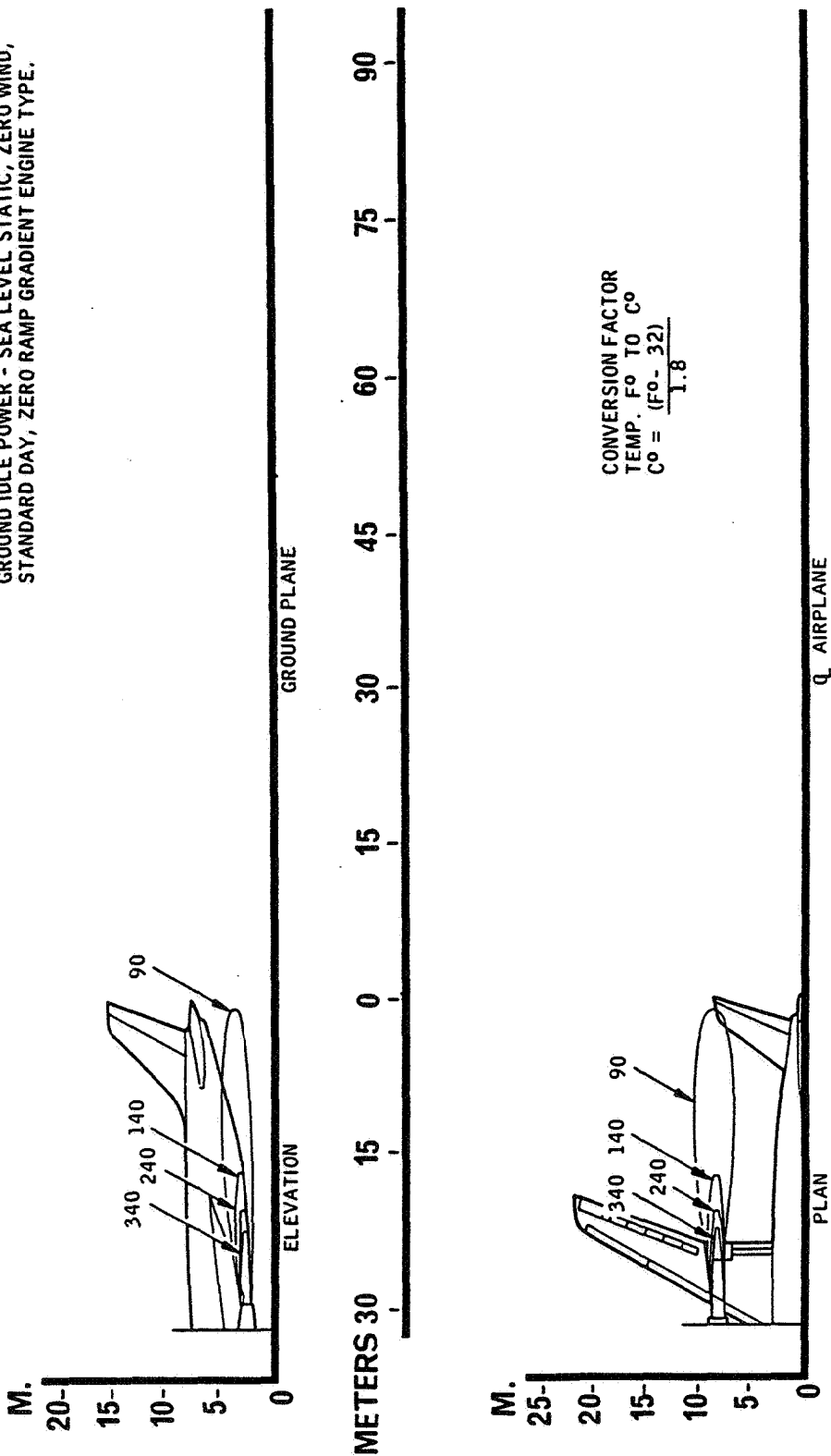

6.1 JET ENGINE EXHAUST VELOCITIES AND TEMPERATURES
6.1.12 EXHAUST TEMPERATURE CONTOURS - IDLE POWER (METRIC UNITS)
MODEL B2 - B4 - C4

A 300

AIRPLANE CHARACTERISTICS

- A A 5 06 01 12 0 A B 0

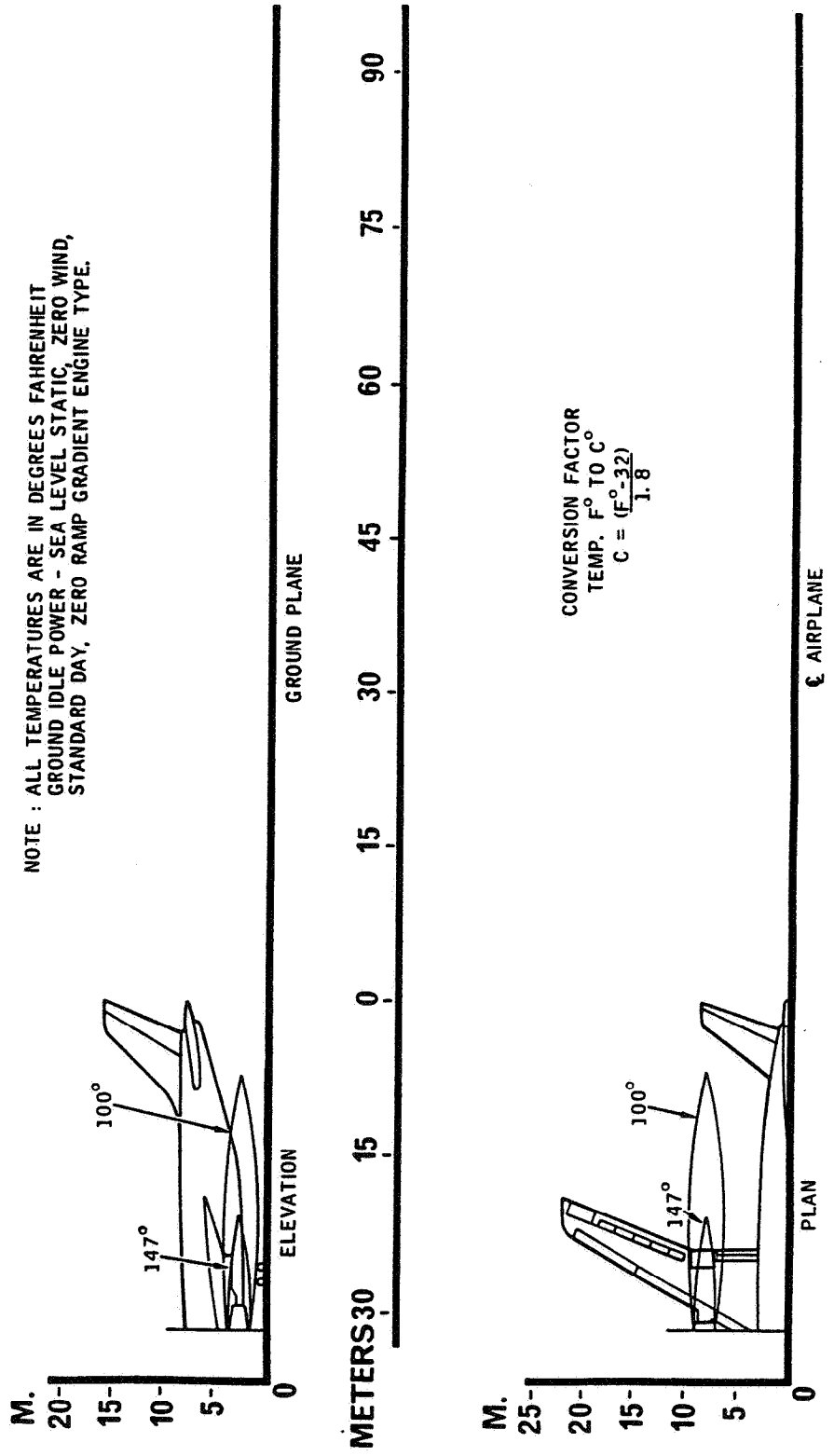

R

6.1 JET ENGINE EXHAUST VELOCITIES AND TEMPERATURES
 6.1.12 EXHAUST TEMPERATURE CONTOURS - IDLE POWER (METRIC UNITS)
 MODELS B2-320 AND B4-120

A 300
AIRPLANE CHARACTERISTICS

6.2 Airport and Community Noise

Noise level footprint contours will reflect the noise level impingement upon a theoretical ground level plane at the same elevation as the runway. Contours are provided for both take-off and landing operations.

These footprint contours will permit investigations of the noise associated with operation of the airplane at individual airports as it relates to the airport proper and the adjoining community. This will assist in planning investigations related to clear zones, zoning for nonsensitive land utilization or alternate compatible land development.

The foregoing data availability depends on :

1. Action taken on pending legislation related to airplane noise
2. Possible restrictions imposed by the regulatory agencies
3. Development and acceptance of a common noise measuring method

As an interim measure for airport planning it is recommended that FAA DS-67-14 "Techniques for Developing Noise Exposure Forecasts", with the exception of Section 4 "Land Use Planning" be used as representative of noise contours for 2, 3 and 4 engine airplanes. It must be kept in mind that the data presented is for effective perceived noise level in units of EPNdB, and as such must be considered to have a tolerance of ± 8 EPNdB.

In addition to the preceding, table 6.2.2 provides data concerning engine maintenance run-up noise to permit evaluation of possible attenuation requirements.

A 300
AIRPLANE CHARACTERISTICS

CONDITIONS

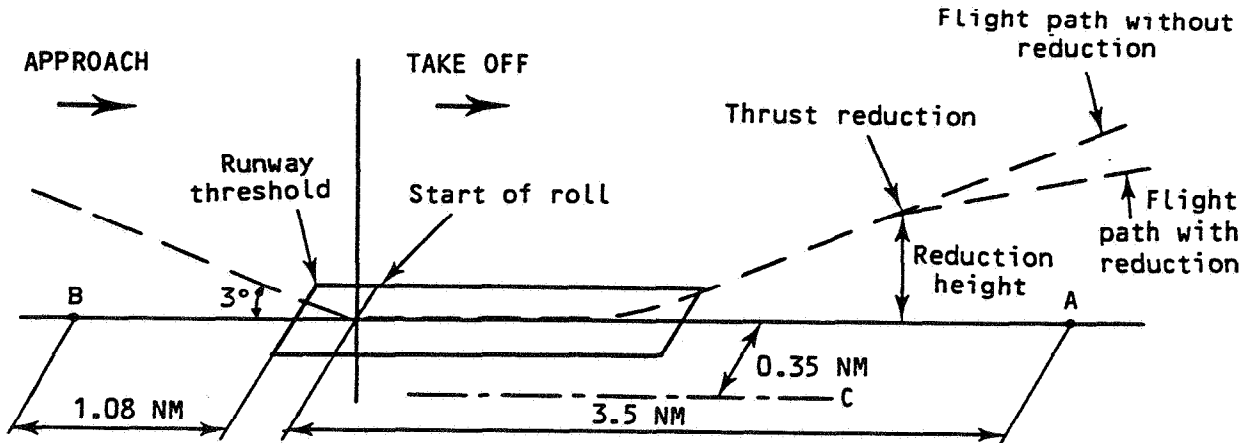

Printed in France

EXTERNAL NOISE LEVEL

		NOISE LEVEL CERTIFIED (EPNdB)										
		B2 101	B2(1) 101	B2(2) 101	B2 201/202	B2 320	B4 101	B4(3) 101	B4(4) 101	B4 102/103	B4(4) 102/103	B4/C4 203
POINT A (overflight at take-off) "Slats 16° - Flaps 0°"		87.1	87.1	88.2	87	*90.3	89	89.6	90.5	88.1	90.1	91.9
LINE C (sideline at take-off) "Slats 16° - Flaps 0°"		91.0	91.0	92.6	92.6	*98.3	92.4	92.4	92.4	93.3	93.3	93.2
POINT B (overflight in approach)	Slats 25°/ Flaps 25°	101.1	101.3	101.3	101.7	103.0	101.9	101.9	101.9	101.9	101.9	101.9
	Slats 20°/ Flaps 15°	100.8	100.8	100.8	---	---	---	---	---	---	---	---
	Slats 16°/ Flaps 15°	---	---	---	101.1	---	101.2	101.2	101.2	101.2	101.2	101.2

AA 5 06 02 01 0 AA 0

- (1) After Mod. 1569
- (2) After Mod. 1357
- (3) After Mod. 1614
- (4) After Mod. 1652

* Take-off with Slats 16°/ Flaps 8°

FIELD HEIGHT : sea level

ATMOSPHERE : ISA + 10° without wind
relative humidity 70 %

6.2 AIRPORT AND COMMUNITY NOISE
6.2.1 EXTERNAL NOISE
MODEL B2 - B4 - C4

A 300
AIRPLANE CHARACTERISTICS

OCTAVE BAND CENTER FREQUENCY	OCTAVE BAND SPL, dB (RE : 0002 Dynes/cm ²)		
	45° TO EXHAUST	40° TO EXHAUST	50° TO EXHAUST
35 Hz (Extrapolated)	107.6	110.0	105.1
63 Hz	107.8	109.8	105.8
125 Hz	108.0	109.2	106.7
250 Hz	104.0	104.8	103.2
500 Hz	98.9	98.6	99.1
1000 Hz	94.0	93.9	94.0
2000 Hz	95.1	93.4	96.7
4000 Hz	93.9	92.3	95.5

Printed in France

GROUND STATIC
TAKEOFF POWER
100 METERS RADIUS
45° LEVELS ARE AVERAGE OF 40° AND 50° LEVELS

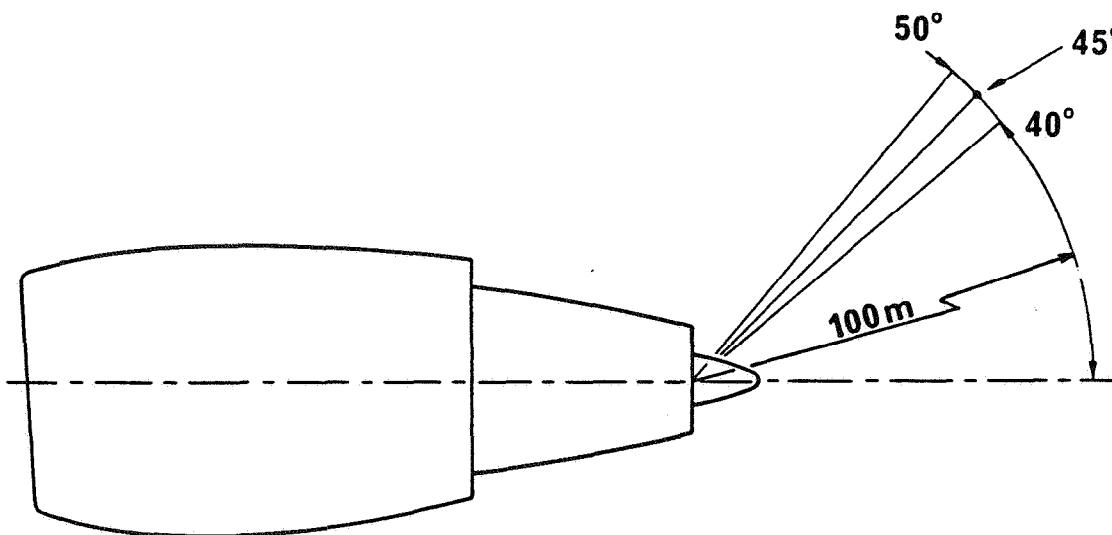

A A 5 06 02 02 0 AA 0

6.2 AIRPORT AND COMMUNITY NOISE
6.2.2 NOISE DATA
MODEL B2 - B4 - C4

AIRBUS  INDUSTRIE

A 300
AIRPLANE CHARACTERISTICS

Printed in France

TO BE ISSUED LATER

A A 5 06 02 02 0 AB 0

6.2 AIRPORT AND COMMUNITY NOISE
6.2.2 NOISE DATA
MODEL B2-320

Feb. 1980

Chapter 6
Page 29

A 300
AIRPLANE CHARACTERISTICS

6.2.3 APU NOISE LEVELS

The figures presented hereafter have been obtained after analysis of third octave on the 45-11, 200Hz frequency band in compliance with Technical Specifications.

Passenger door sound levels were recorded 1.50 metres from cabin floor and 0.30 m from outside fuselage wall.

SURROUNDING NOISE AT FORWARD/AFT

POINTS OF THE AIRCRAFT:

and in some other points (in dB)

Measurement Points	Config. 1 APU only operating at 65%	Config. 2 APU at 84% + air cond. doors closed	Config. 3 APU at 84% + air cond. some doors Open	Config. 4 APU at 97% + air cond. FULL HEAT
1	68.0		70.0	71.2
2	69.8	72.1	70.8	72.3
3	76.1	80.7	78.8	82.5
4	73.9	78.9	78.4	80.6
5	83.7	88.0	88.1	87.9
6	82.6	86.0	85.5	86.3
7	75.7	79.9	79.4	80.2
8	80.5	81.9	78.2	82.5
9	82.4	82.7	80.9	82.9
	77.7	81.0	79.9	80.9
11	75.9	80.2	79.8	80.7
12		81.3	80.9	80.8
13		81.6	80.8	80.8
A	88.1			90.4
B	88.0			91.7

MEASUREMENT POINT LOCATION

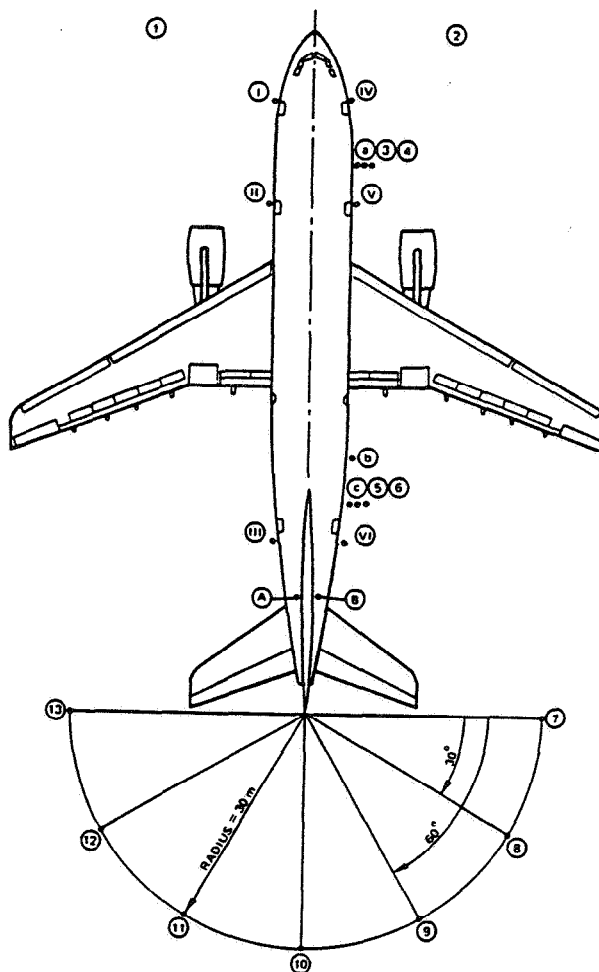

Printed in France

SURROUNDING NOISE AT T.S.

MEASUREMENT POINTS

Measurement Points	Guarantees	Config. 1 APU only operating at 65%	Config. 2 APU at 84% + air cond. doors closed	Config. 3 APU at 84% + air cond. some doors open	Config. 4 APU at 97% + air cond. FULL HEAT
I	83 ± 3	71.5	73.9	73.1	75.6
II	83 ± 3	77.1	81.1	81.3 G	84.0
III	87 ± 3	80.4	86.2	86.0	86.8
IV	83 ± 3	70.4	72.2	74.9	74.4
V	83 ± 3	75.2	78.5	77.5 G	80.8
VI	87 ± 3	83.8	88.1	86.6	88.9
a	83 ± 3	77.0	81.0*	79.0*	83.0*
b	83 ± 3	82.1	85.2	84.6	86.9
c	87 ± 3	85.9	87.7	87.5	90.0
f	83 ± 3	77.5	82.5*	81.0*	79.9

Config. 3 : Only middle and aft RH doors were open. Values marked "G" were obtained in the guarantee conditions, i.e. doors open. Cases pointed out * correspond to measurements that cannot be proceeded to. The values transcribed are estimations from measurements recorded for very close points, namely pt. 3 for "a", and a point located on the same vertical axis 1.2 m above the ground for "f".

6.2 AIRPORT AND COMMUNITY NOISE

6.2.3 APU NOISE LEVELS

MODEL B2 - B4 - C4

A A 5 06 02 03 0 AA 0

A 300
AIRPLANE CHARACTERISTICS

LEVELS RECORDED AROUND THE APU
(AIRseach TSCP 700-5 APU)

MEASUREMENTS ALONG A 30 METRE RADIUS CIRCLE

- Config. 1 : APU alone - Rating 65%
- Config. 2 : APU + air cond. packs - Doors closed - 84%
- - - - - Config. 3 : APU + air cond. packs - Doors open - 84%
- Config. 4 : APU + air cond. packs on FULL HEAT - 97%

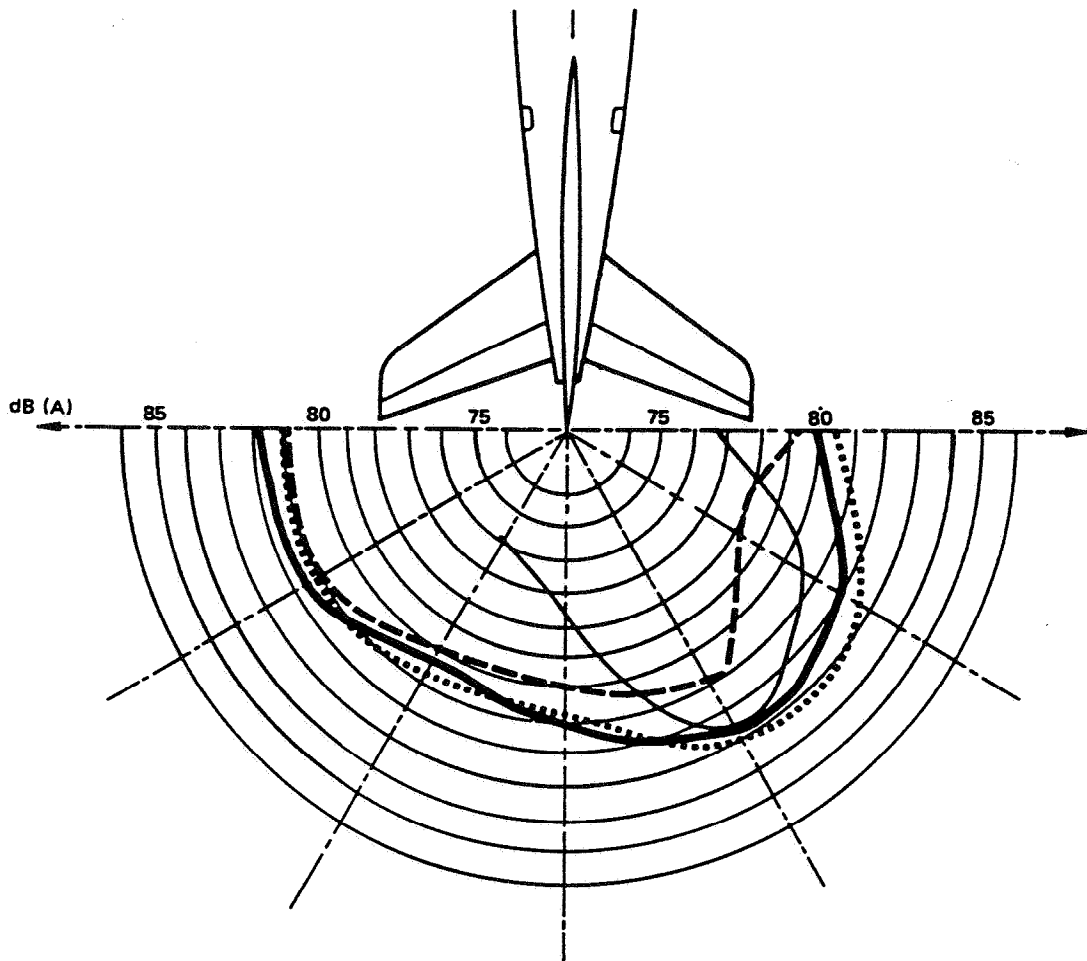

A A 5 06 02 03 0 AB 0

6.2 AIRPORT AND COMMUNITY NOISE
6.2.3 APU NOISE LEVELS
MODEL B2 - B4 - C4

Printed in France

A 300
AIRPLANE CHARACTERISTICS

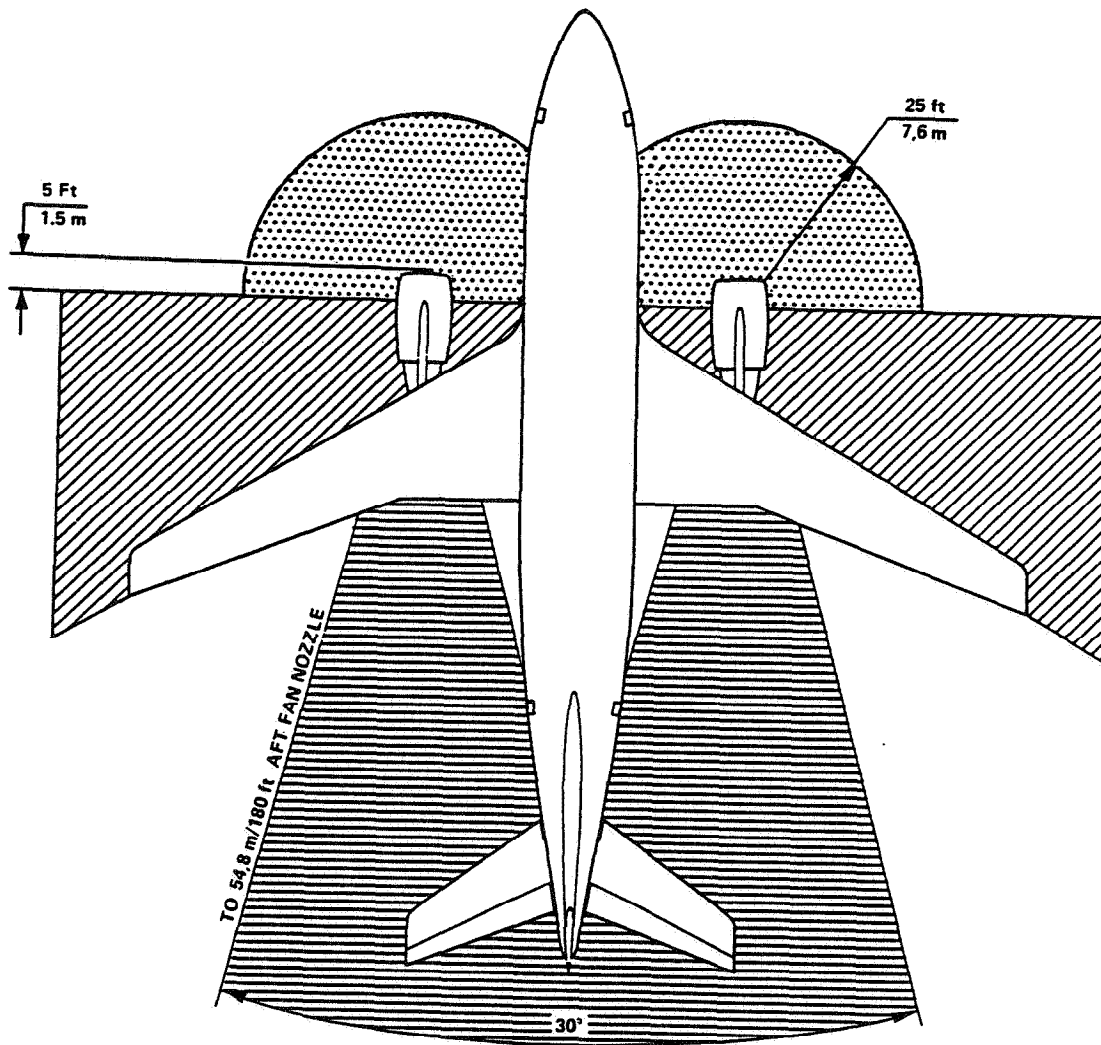

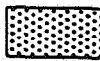
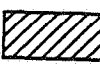
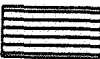
-  INTAKE SUCTION DANGER AREA GROUND IDLE
-  ENTRY CORRIDOR
-  SET WAKE AREA

6.3 DANGER AREAS OF THE ENGINES
6.3.1 DANGER AREAS OF THE ENGINES (GROUND IDLE)
MODEL B2 - B4 - C4

A 300
AIRPLANE CHARACTERISTICS

Printed in France

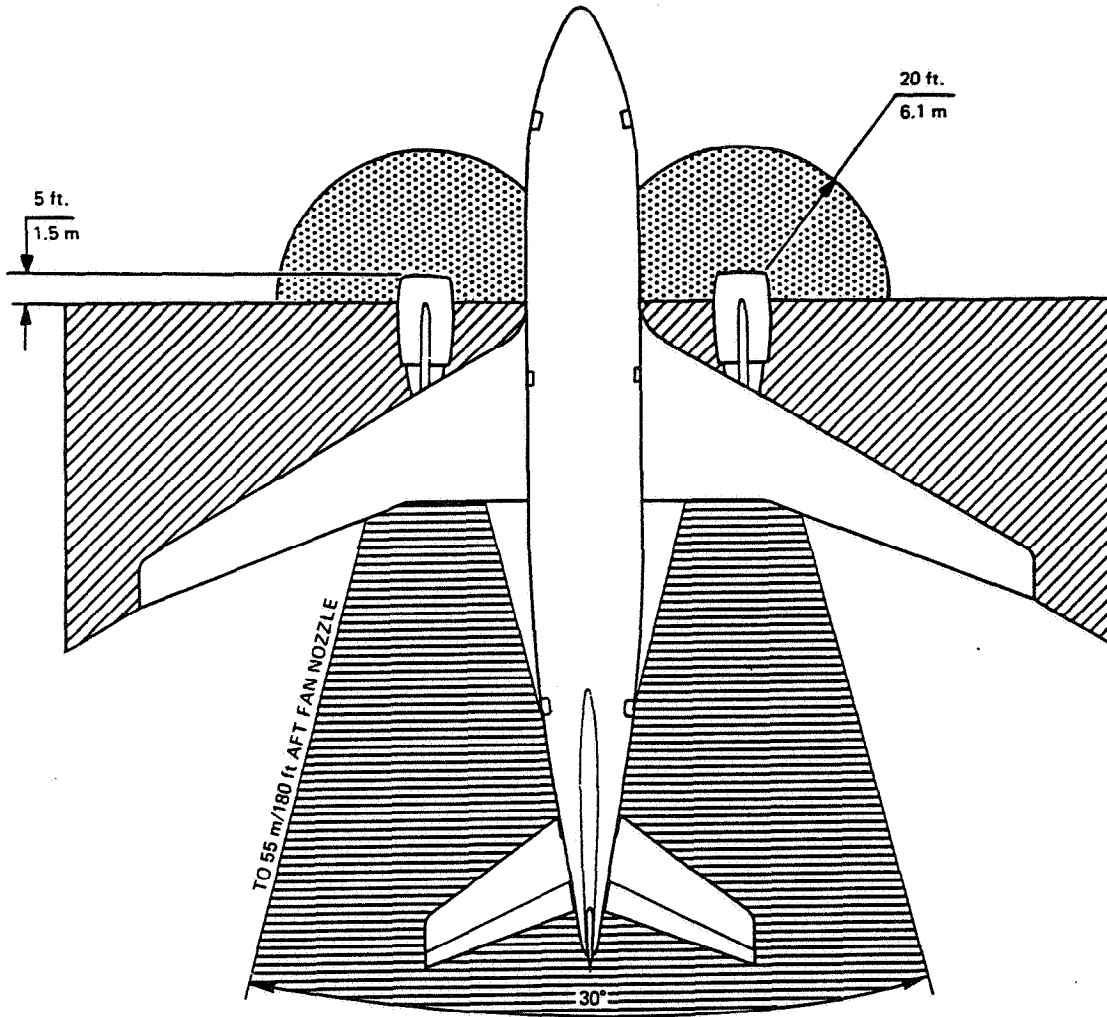

 INLET SUNCTION DANGER AREA GROUND IDLE

 ENTRY CORRIDOR

 EXHAUST WAKE DANGER

6.3 DANGER AREAS OF THE ENGINES
6.3.1 DANGER AREAS OF THE ENGINES (GROUND IDLE)
MODEL B2-320

A 300

AIRPLANE CHARACTERISTICS

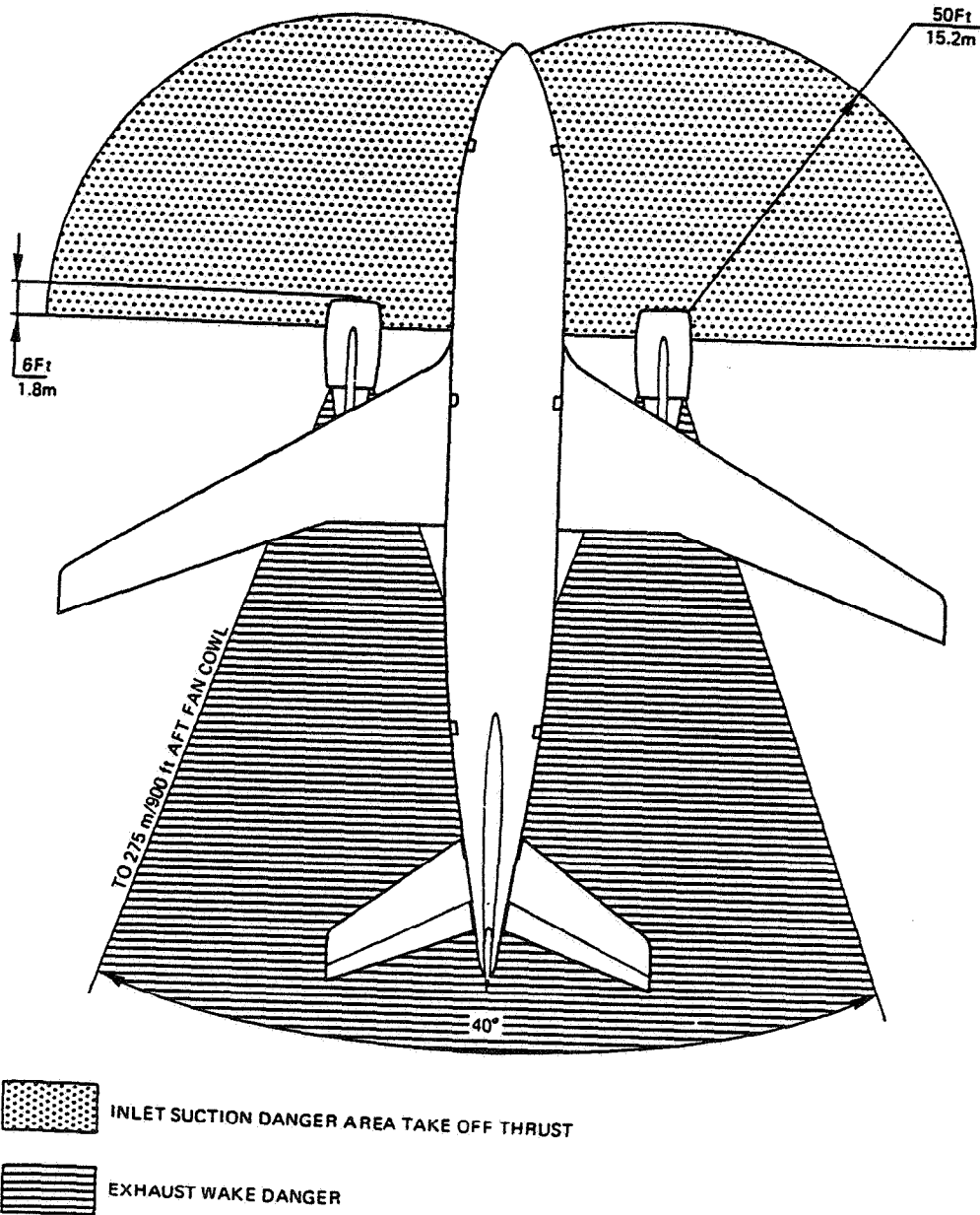

Printed in France

6.3 DANGER AREAS OF THE ENGINES

6.3.2 DANGER AREAS OF THE ENGINES (TAKE OFF)

MODEL B2 - B4 - C4

Printed in France

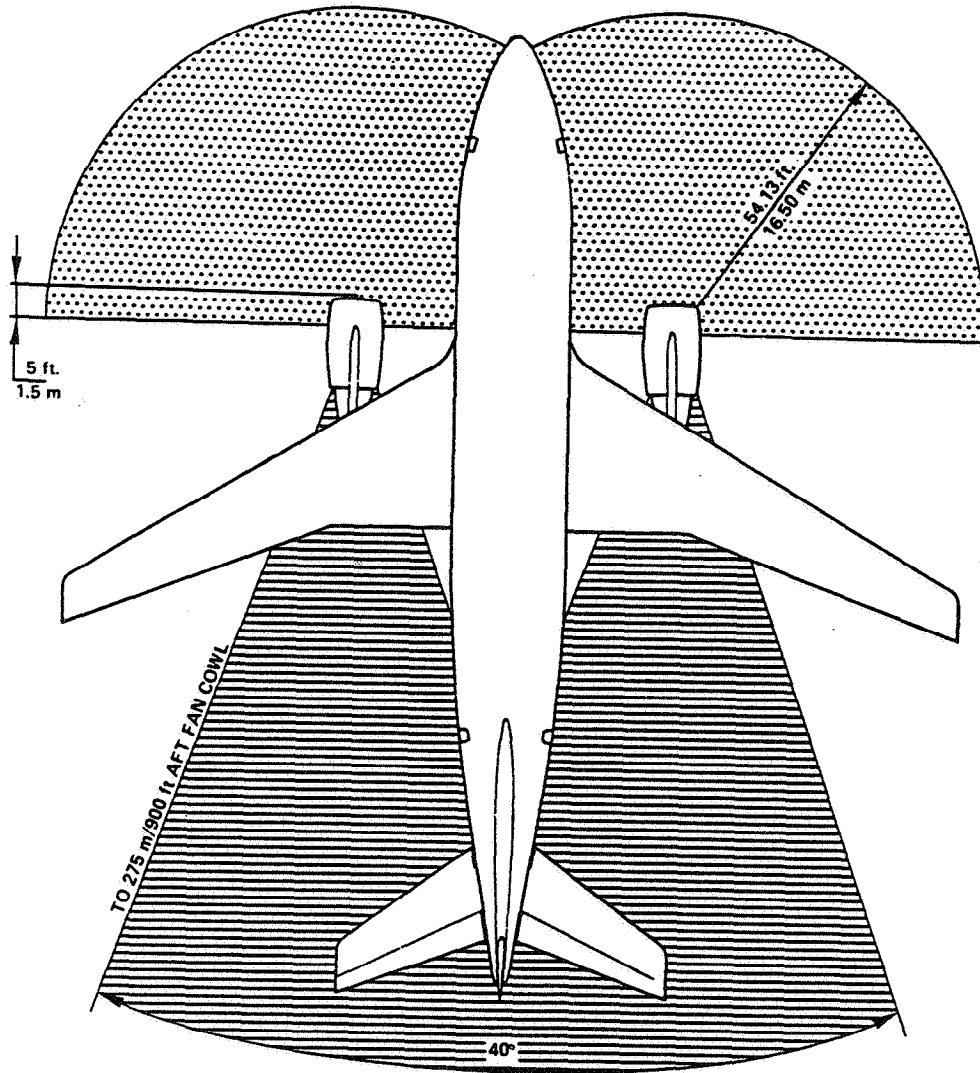

 INTAKE SUCTION DANGER AREA TAKEOFF THRUST

 JET WAKE AREA

6.3 DANGER AREAS OF THE ENGINES
6.3.2 DANGER AREAS OF THE ENGINES (TAKE OFF)
MODEL B2-320

A 300
AIRPLANE CHARACTERISTICS

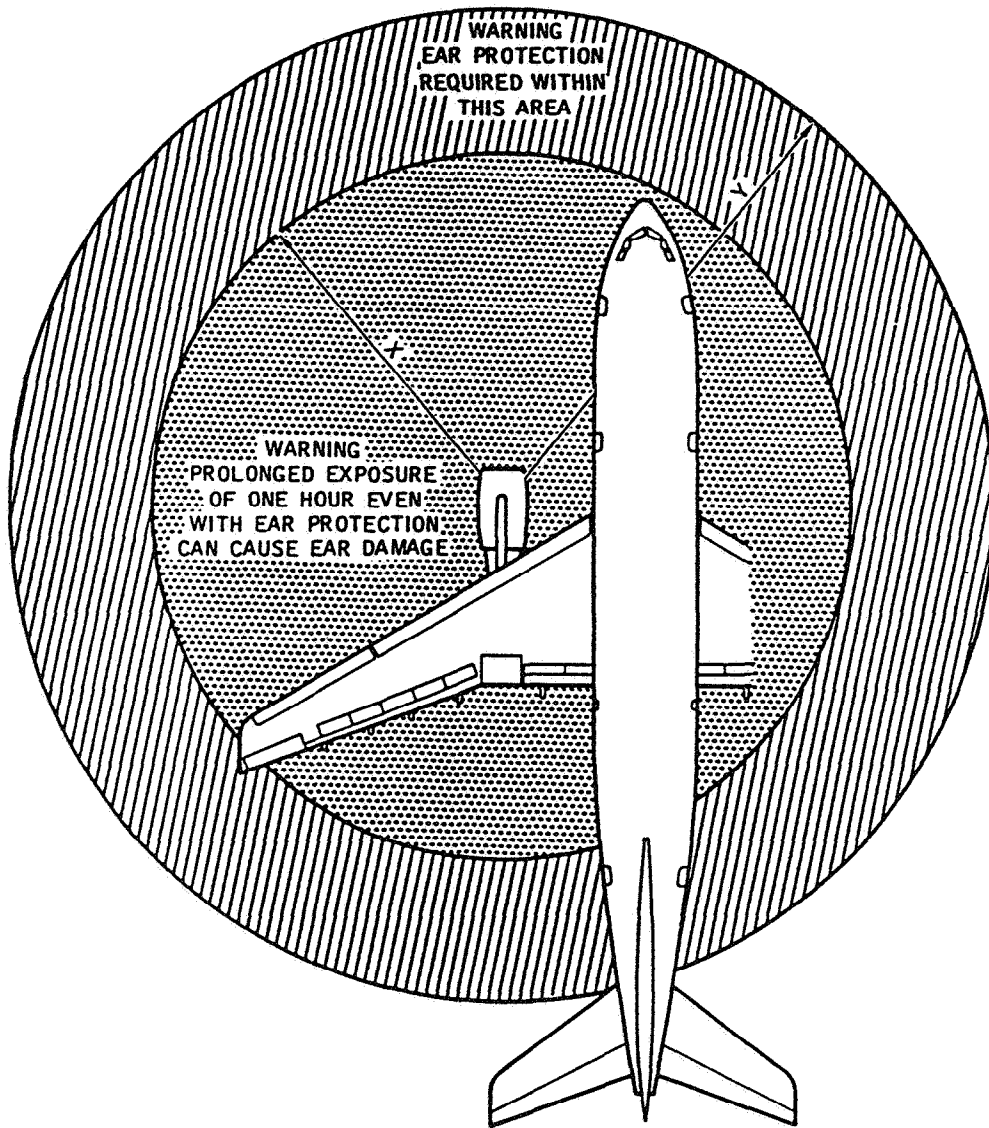

Printed in France

POWER SETTING	RADIUS X	RADIUS Y
GROUND IDLE	23m	31m
TAKE-OFF THRUST	31m	62m

GENERAL ELECTRIC CF6-50C ENGINES

6.3 DANGER AREAS OF THE ENGINES
6.3.3 ACOUSTIC PROTECTION AREAS

MODEL B2 - B4 - C4

A A 5 06 03 03 0 AA 0

A 300
AIRPLANE CHARACTERISTICS

Printed in France

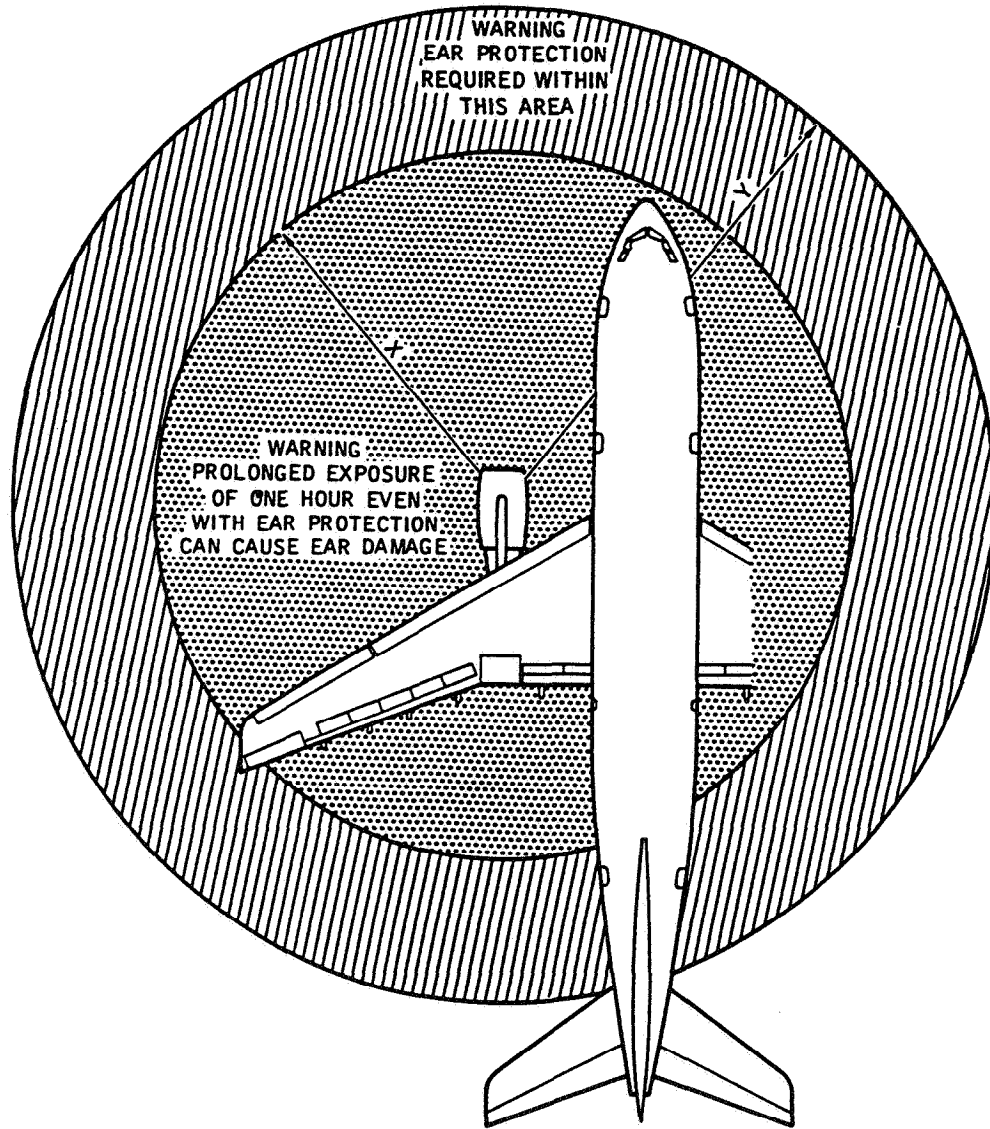

A A 5 06 03 03 0 AB 0

POWER SETTING	RADIUS X	RADIUS Y
GROUND IDLE	23m	30m
TAKE-OFF THRUST	38m	60m

PRATT & WHITNEY JT9D59A ENGINES

6.3 DANGER AREAS OF THE ENGINES
6.3.3 ACOUSTIC PROTECTION AREAS

MODEL B2-320

A300
AIRPLANE CHARACTERISTICS

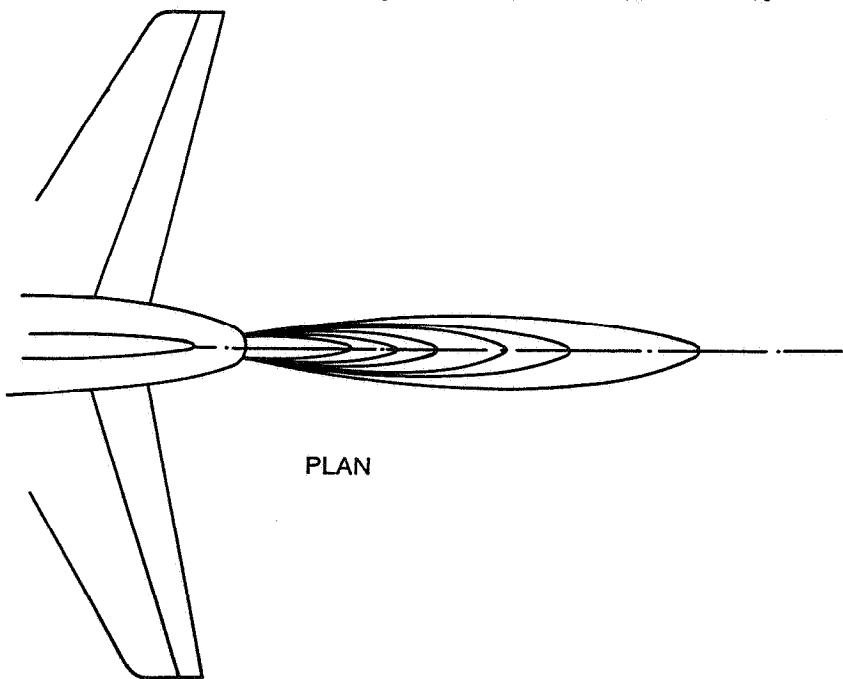
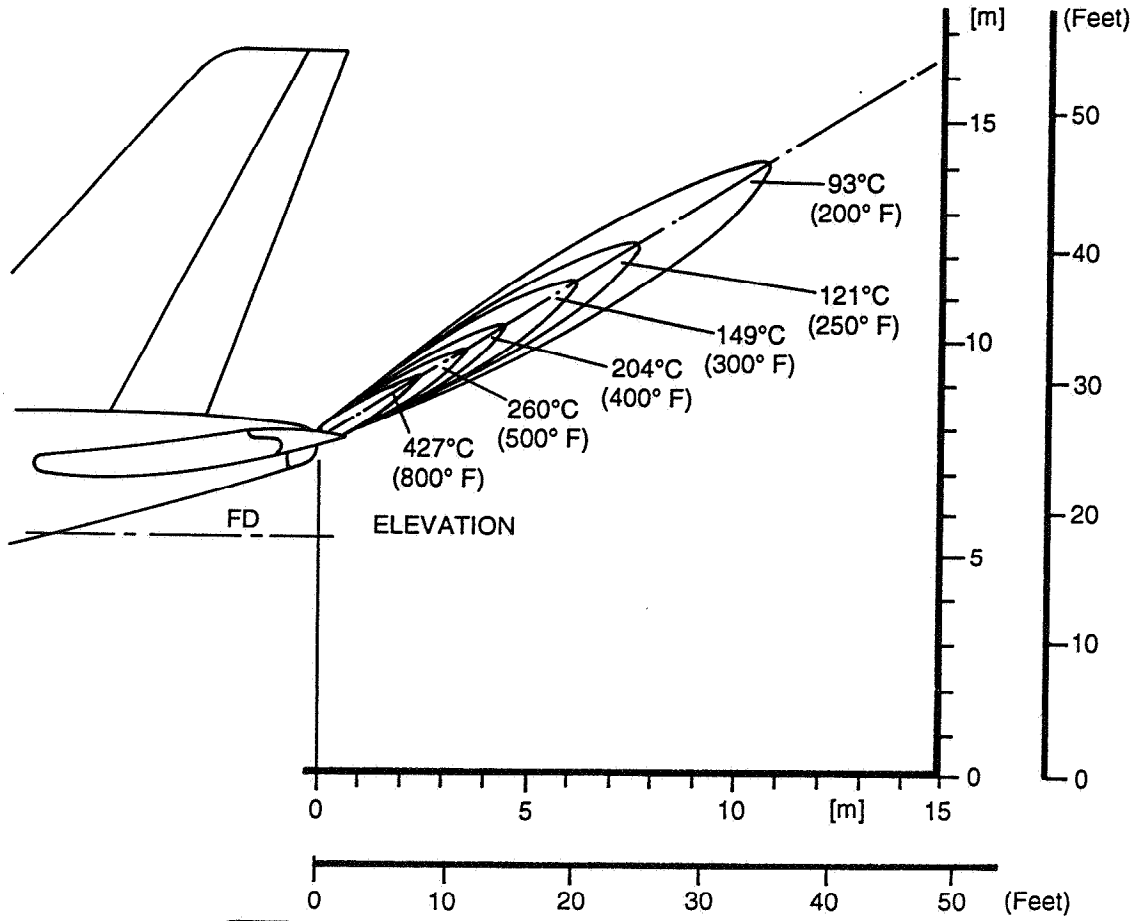

AA5 06 03 04 0 AAMC-00

R
R
R

6.3 DANGER AREAS OF THE ENGINES
6.3.4 APU - Exhaust Gas Temperature
MODEL B2 - B4 - C4

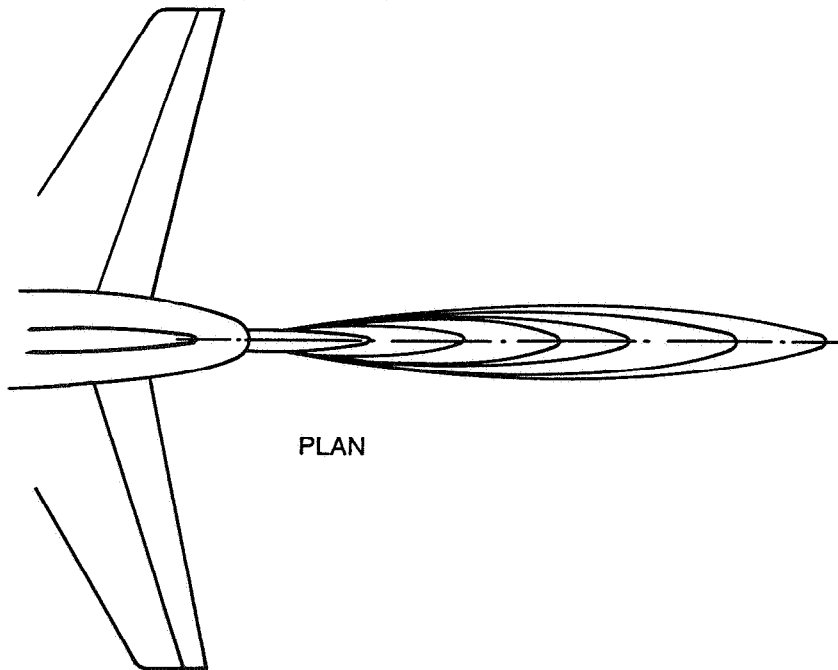
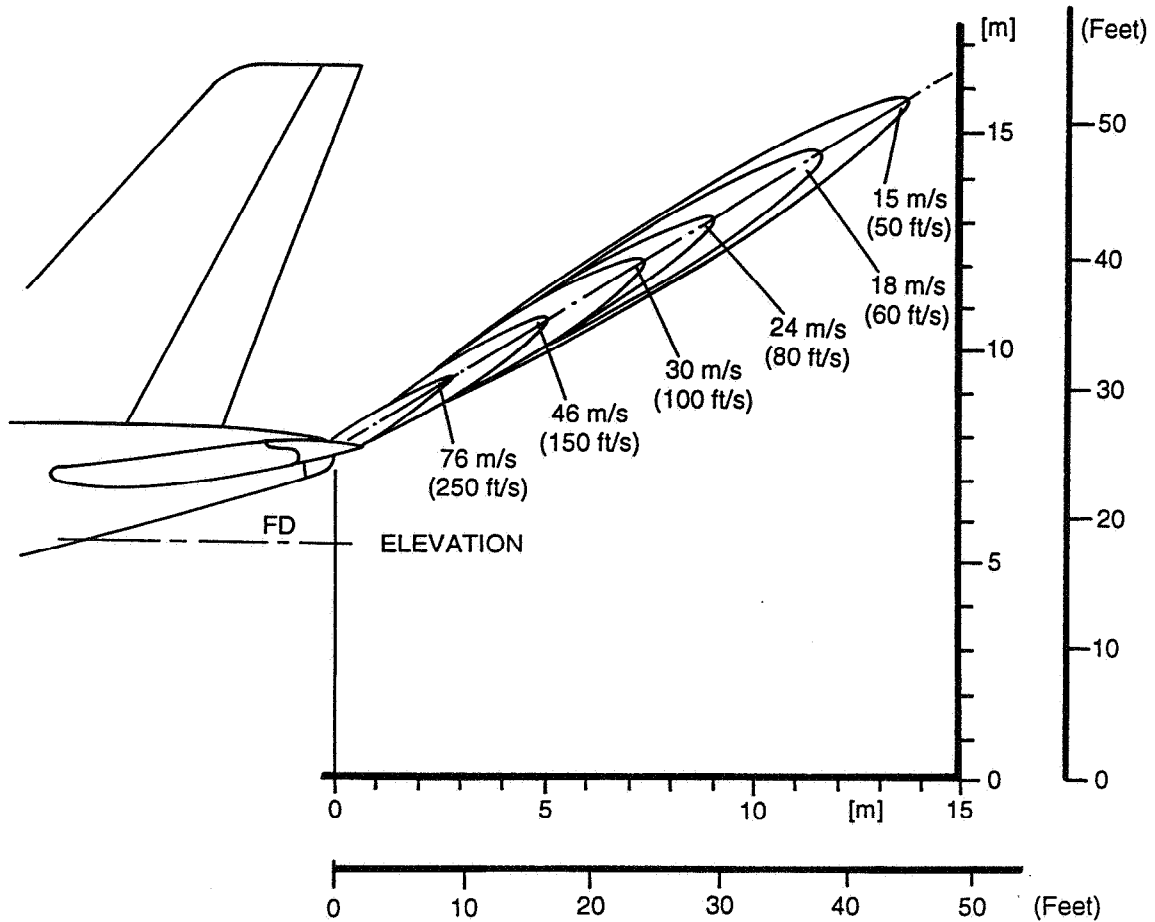

AA5 06 03 04 0 ACMO-00

R
R
R

6.3 DANGER AREAS OF THE ENGINES 6.3.4 APU - Exhaust Gas Velocity MODEL B2 - B4 - C4

Apr 1995

Chapter 6
Page 39



AIRPLANE CHARACTERISTICS

THIS PAGE LEFT BLANK INTENTIONALLY

A 300
AIRPLANE CHARACTERISTICS

- 7.0 PAVEMENT DATA
- 7.1 General Information
- 7.2 Landing Gear Footprint
- 7.3 Maximum Pavement Loads
- 7.4 Landing Gear Loading on Pavement
- 7.5 Flexible Pavement Requirements US Corps of Engineers
Design Method
- 7.6 Flexible Pavement Requirements LCN Conversion
- 7.7 Rigid Pavement Requirements - Portland Cement Association
- 7.8 Rigid Pavement Requirements LCN Conversion
- 7.9 Aircraft Classification Number
Flexible and Rigid Pavement

Printed in France

AIRBUS  INDUSTRIE
A 300
AIRPLANE CHARACTERISTICS

Printed in France

THIS PAGE LEFT BLANK INTENTIONALLY

A 300

AIRPLANE CHARACTERISTICS

7.1 GENERAL INFORMATION

A brief description of the appended pavement charts will be helpful in their use for airport planning.

All pavement requirement charts give data for a constant main gear standardized tire pressure (TRA*) which will produce a tire deflection of 32 percent with the airplane loaded to the maximum ramp weight and the C.G. at its maximum permissible aft position.

Sub-section 7.2 gives basic data on the landing gear footprint configuration and tire sizes.

Maximum ramp weights and corresponding tire pressures are also indicated.

Sub-section 7.3 gives maximum vertical and horizontal pavement loads for certain critical conditions.

Sub-section 7.4 provides charts which show the static loads supported by the main landing gear struts for the operational limits of the airplane. These main landing gear loads are used for the interpretation of the attached pavement design charts from which load values are extrapolated when necessary.

For the A300, the certified C.G.'s are as follows :

- . 18 to 33 % of the MAC** for take-off
- . 15 to 35 % of the MAC** in flight and for landing

Sub-section 7.5 presents pavement requirement charts for flexible pavements based upon format and procedures set forth in SEFL report No. 165A being "Evaluation of C-5A (CX-HLS) Aircraft Ground Flotation Characteristics for Operation from Flexible Pavements" dated February 1965, prepared by Systems and Engineering Group Research and Technology Division, Air Force Systems Command, Wright-Patterson Air Force Base, Ohio, U.S.A.

Sub-section 7.6 consists of LCN conversion curves for flexible pavements. The LCN chart also gives load plots for airplane A300 showing equivalent single wheel load versus pavement thickness "h" for flexible pavements.

* TRA : Tire and Rim Association

** MAC : Mean Aerodynamic Chord

A 300

AIRPLANE CHARACTERISTICS

Sub-section 7.7 provides rigid pavement design curves prepared with the use of the Westergaard Equations in general accordance with the procedures outlined in the 1955 edition of "Design of Concrete Airport Pavement" published by the Portland Cement Association, Illinois, U.S.A, but modified into the new computer program format described in the 1968 Portland Cement Association publication, "Computer Program for Airport Pavement Design". (Programm PDILB) by Robert G. Packard.

The following procedure is used to develop the rigid pavement design curves :

1. Having established the scale for pavement thickness to the left and the scale for allowable working stress to the right, an arbitrary load line is drawn representing the main landing gear maximum weight to be shown.
2. All values of the subgrade modules (k values) are then plotted using the maximum load lines.
3. Additional load lines for the incremental value of weight on the main landing gear are then established on the basis of the curve for $k = 300$ psi, already established.

Sub-section 7.8 represents LCN conversion curves for rigid pavements having been plotted using procedures and curves in international Civil Aviation Organization (ICAO) document 7290-AN/865-2, Aerodrome Manual, part 2, 2nd edition 1965, + Addendum corrigendum No. 1 dated 1.8.67.

The LCN charts also illustrate load plots for airplane A300 showing equivalent single wheel load versus radius of relative stiffness factor for rigid pavements.

Note : Pavement requirements cover loads, tires and tire pressures presently planned for certified commercial usage on the A300.

All curves represent data at a constant specified tire pressure.

R

CAUTION :

TIRE INFLATING PRESSURES QUOTED BELOW ARE NOMINAL, AIRPLANE ON JACKS. NOMINAL PRESSURES FOR TIRES SUPPORTING THE AIRPLANE WEIGHT ARE 4% HIGHER. OPERATORS SHALL CONFORM WITH THE TIRE INFLATING PRESSURES QUOTED IN THE RELEVANT MAINTENANCE DOCUMENTS (MM CH 12 AND 32)

A 300

AIRPLANE CHARACTERISTICS

Printed in France

Sub-section 7.9 represents the ACN/PCN system as referenced in Amendment 35 to ICAO Annex 14, "Aerodromes", 7th Edition, June 1976, provides a standardized international airplane/pavement rating system replacing the various S, TT, LCN, AUW, ISWL, etc., rating systems used throughout the world. ACN is the Aircraft Classification Number and PCN is the Pavement Classification Number. An aircraft having an ACN equal to or less than the PCN can operate on the pavement subject to any limitation on the tire pressure. Numerically, the ACN is two times the derived single-wheel load expressed in thousands of kilograms, where the derived single wheel load is defined as the load on a single tire inflated to 1.25 MPa (181 psi) that would have the same pavement requirements as the aircraft. Computationally, the ACN/PCN system used the PCA program PD ILB for rigid pavements and S-77-1 for flexible pavements to calculate ACN values. The method of pavement evaluation is left up to the airport with the results of their evaluation presented as follows :

PCN	PAVEMENT TYPE	SUBGRADE CATEGORY	TIRE-PRESSURE CATEGORY	EVALUATION METHOD
	R-Rigid	A-High	W-No Limit	T-Technical
	F-Flexible	B-Medium	X-To 1.5 MPa (217 psi)	U-Using aircraft
		C-Low	Y-To 1.0 MPa (145 psi)	
		D-Ultra Low	Z-To 0.5 MPa (73 psi)	

Chapter 7.9 pages 2 and 3 shows the aircraft ACN values for flexible pavements. The four subgrade categories are :

- A-High Strength - CBR 15
- B-Medium Strength - CBR 10
- C-Low Strength - CBR 6
- D-Ultra Low Strength - CBR 3

Chapter 7.9 pages 4 and 5 shows the aircraft ACN values for rigid pavements. The four subgrade categories are :

- A-High Strength, $k = 150 \text{ MN/m}^3$ (550 pci)
- B-Medium Strength, $k = 80 \text{ MN/m}^3$ (300 pci)
- C-Low Strength, $k = 40 \text{ MN/m}^3$ (150 pci)
- D-Ultra Low Strength, $k = 20 \text{ MN/m}^3$ (75 pci)

AIRBUS  INDUSTRIE
A 300
AIRPLANE CHARACTERISTICS

Printed in France

THIS PAGE LEFT BLANK INTENTIONALLY

A 300

AIRPLANE CHARACTERISTICS

	MODEL B2		B2 K	MODEL B4			B4 Stage III	MODEL C4
Maximum ramp weight	137,900 Kg 304,000 lb	142,900 Kg 315,000 lb	142,900 Kg 315,000 lb	150,900 Kg 332,700 lb	153,900 Kg 339,300 lb	158,400 Kg 349,200 lb	165,900 Kg 365,750 lb	165,900 Kg 365,750 lb
Percent of weight on main gear	See 7.4.1			See 7.4.2				
Nose tire size	40 in. x 14 in. -16 in. Type VII							
Nose tire pressure*	8.2 bar 119 psi	8.6 bar 125 psi	8.6 bar 125 psi	9 bar 131 psi	9 bar 131 psi	9 bar 131 psi		
Main gear tire size (standard tires)	46 in. x 16 in. -20 in. Type VII						49 in. x 17 in. -20 in. Type VII	
Main gear tires pressure* (standard tires)	11.6 bar 168 psi	12.4 bar 180 psi	12.4 bar 180 psi	13.37 bar 194 psi	13.65 bar 198 psi	14.2 bar 206 psi	12.4 bar 180 psi	12.4 bar 180 psi
Main gear tire size (optional tires)	49 in. x 17 in. -20 in. Type VII						49 in. x 19 in. -20 in. Type VII **	
Main gear tire pressure* (optional tires)	10.35 bar 150 psi	10.7 bar 155 psi	10.7 bar 155 psi	11.3 bar 164 psi	11.5 bar 167 psi	11.86 bar 172 psi	11.1 bar 161 psi	11.1 bar 161 psi
Main gear tire size (optional tires)	—	—	—	—	—	49 in. x 19 in. -20 in. ** Type VII	—	—
Main gear tire pressure* (optional tires)	—	—	—	—	—	10.6 bar 154 psi	—	—

Printed in France

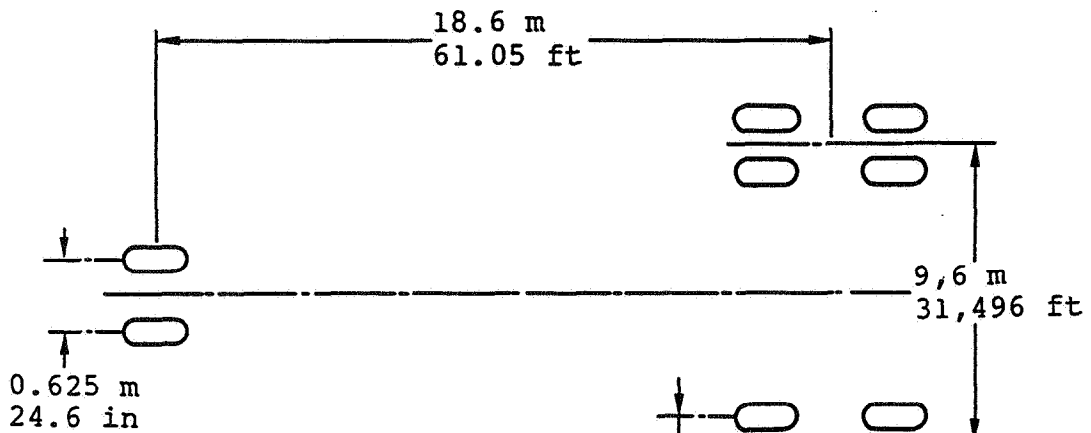

A 300	A	B
B2	0.889m. (35 in.)	1.397m. (55in.)
B2K-B4 and C4	0.927m. (36.5in.)	1.397m. (55in.)
B4 and C4 (After MOD.2204)	0.978m. (38.5in.)	1.524m. (60in.)

* TRA standardized tire pressure
(TRA: Tire and Rim Association)

** Associated to a landing geometry of 0.978m (38.5in) x 1.524m (60in) for B2, B4, and C4.

A A 5 07 02 00 0 AA 0

7.2 LANDING GEAR FOOTPRINT MODEL B2 - B4 - C4

AIRBUS  INDUSTRIE
A 300
AIRPLANE CHARACTERISTICS

Printed in France

THIS PAGE LEFT BLANK INTENTIONALLY

A 300

AIRPLANE CHARACTERISTICS

Printed in France

A A 5 07 03 00 0 AA 0

V_{NG} = MAXIMUM VERTICAL NOSE GEAR GROUND LOAD AT MOST FORWARD C.G.

V_{MG} = MAXIMUM VERTICAL NOSE GEAR GROUND LOAD AT MOST AFT C.G.

H = MAXIMUM HORIZONTAL GROUND LOAD FROM BRAKING
 NOTE ALL LOADS CALCULATED USING AIRPLANE MAXIMUM GROSS WEIGHT.

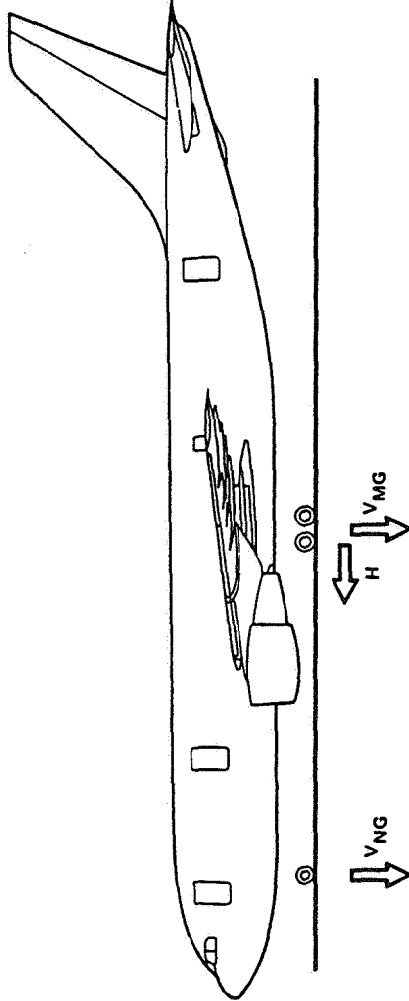

MODEL	MAXIMUM GROSS WEIGHT		V _{NG}		V _{MG}		H					
	LB	KG	LB	KG	LB	KG	LB	KG				
B2	302,030	137,000	38,790	17,595	60,572	27,475	141,605	64,231	45,294	20,545	113,860	51,646
B2 and B2K	313,055	142,000	40,137	18,206	62,721	28,450	146,790	66,583	46,945	21,294	118,068	53,555
B2 320	313,055	142,000	40,137	18,206	62,721	28,450	146,790	66,583	46,945	21,294	118,068	53,555
B4	330,690	150,000	42,472	19,265	66,150	30,005	155,009	70,311	49,593	22,495	124,874	56,642
	337,305	153,000	43,336	19,657	67,446	30,593	158,100	71,713	50,583	22,944	127,387	57,782
C4	347,225	157,500	44,672	20,263	69,495	31,568	162,630	73,768	52,071	23,619	130,974	59,409
	363,980	165,000	47,064	21,348	72,788	33,016	170,247	77,223	54,551	24,744	137,323	62,289
	363,980	165,000	47,064	21,348	72,788	33,016	170,247	77,223	54,551	24,744	137,323	62,289

7.3 MAXIMUM PAVEMENT LOADS MODEL B2 - B4 - C4

AIRBUS  INDUSTRIE
A 300
AIRPLANE CHARACTERISTICS

Printed in France

THIS PAGE LEFT BLANC INTENTIONALLY

A 300

AIRPLANE CHARACTERISTICS

Printed in France

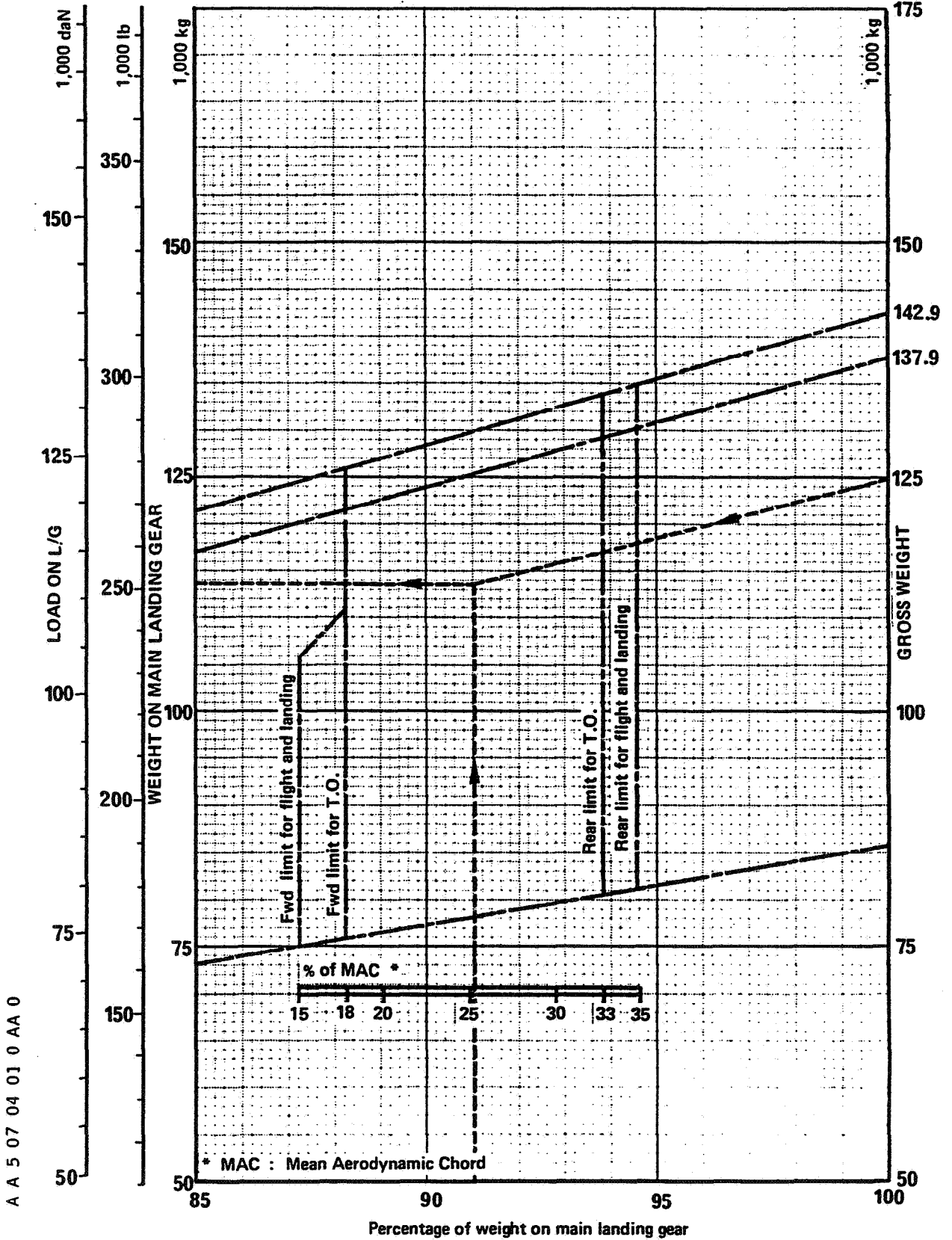

7.4.1 LANDING GEAR LOADING ON PAVEMENT
MODEL B2/B2K

A 300

AIRPLANE CHARACTERISTICS

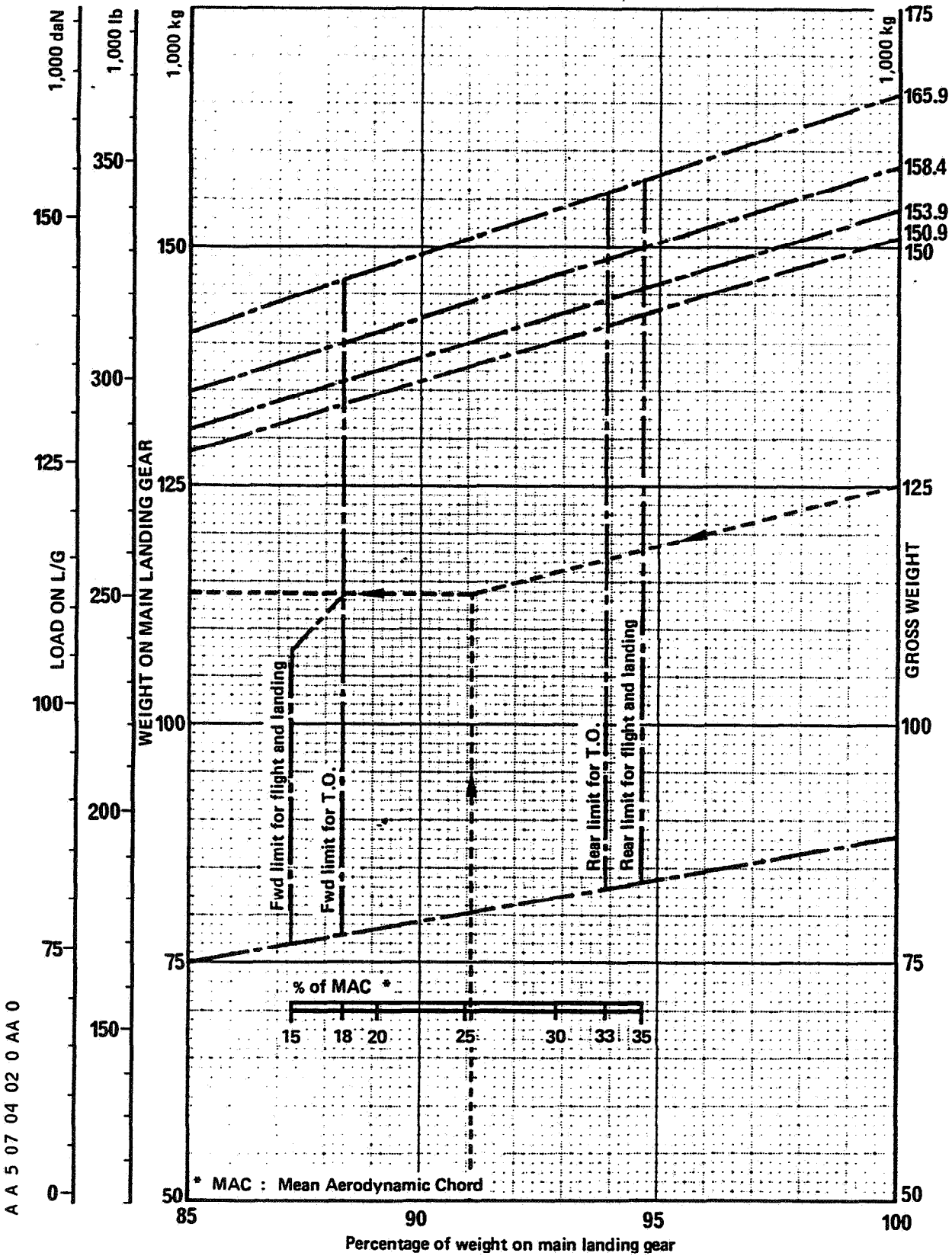

7.4.2 LANDING GEAR LOADING ON PAVEMENT
MODEL B4 - C4

A A 5 07 04 02 0 AA 0

Printed in France

A 300
AIRPLANE CHARACTERISTICS

Printed in France

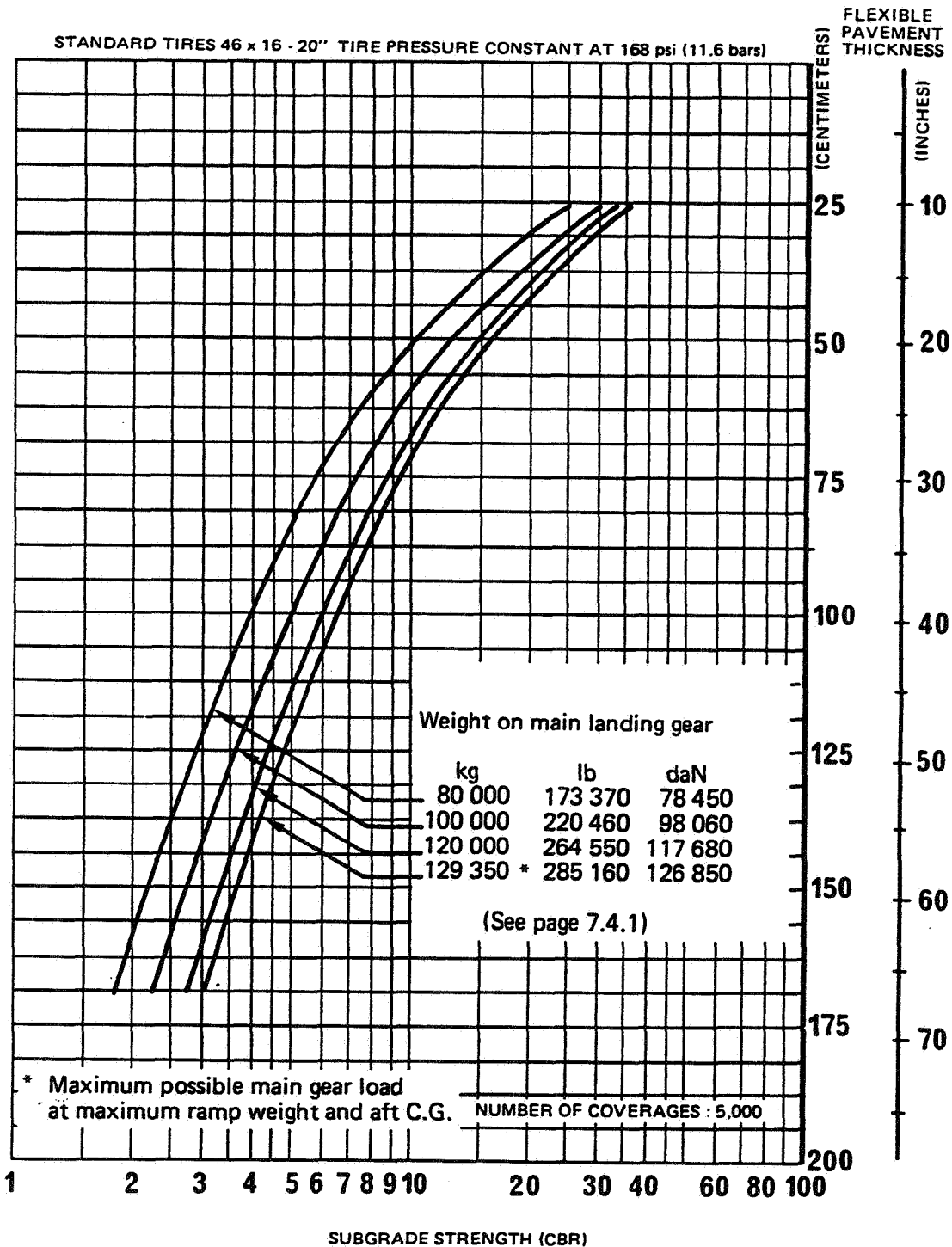

A A 5 07 05 01 0 AA 0

7.5.1.1 FLEXIBLE PAVEMENT REQUIREMENTS
U.S. CORPS OF ENGINEERS DESIGN METHOD
MODEL B2 - 137t STANDARD TIRES

A 300
AIRPLANE CHARACTERISTICS

OPTIONAL TIRES 49 x 17 - 20" TIRE PRESSURE CONSTANT AT 150 psi (10.35 bars)

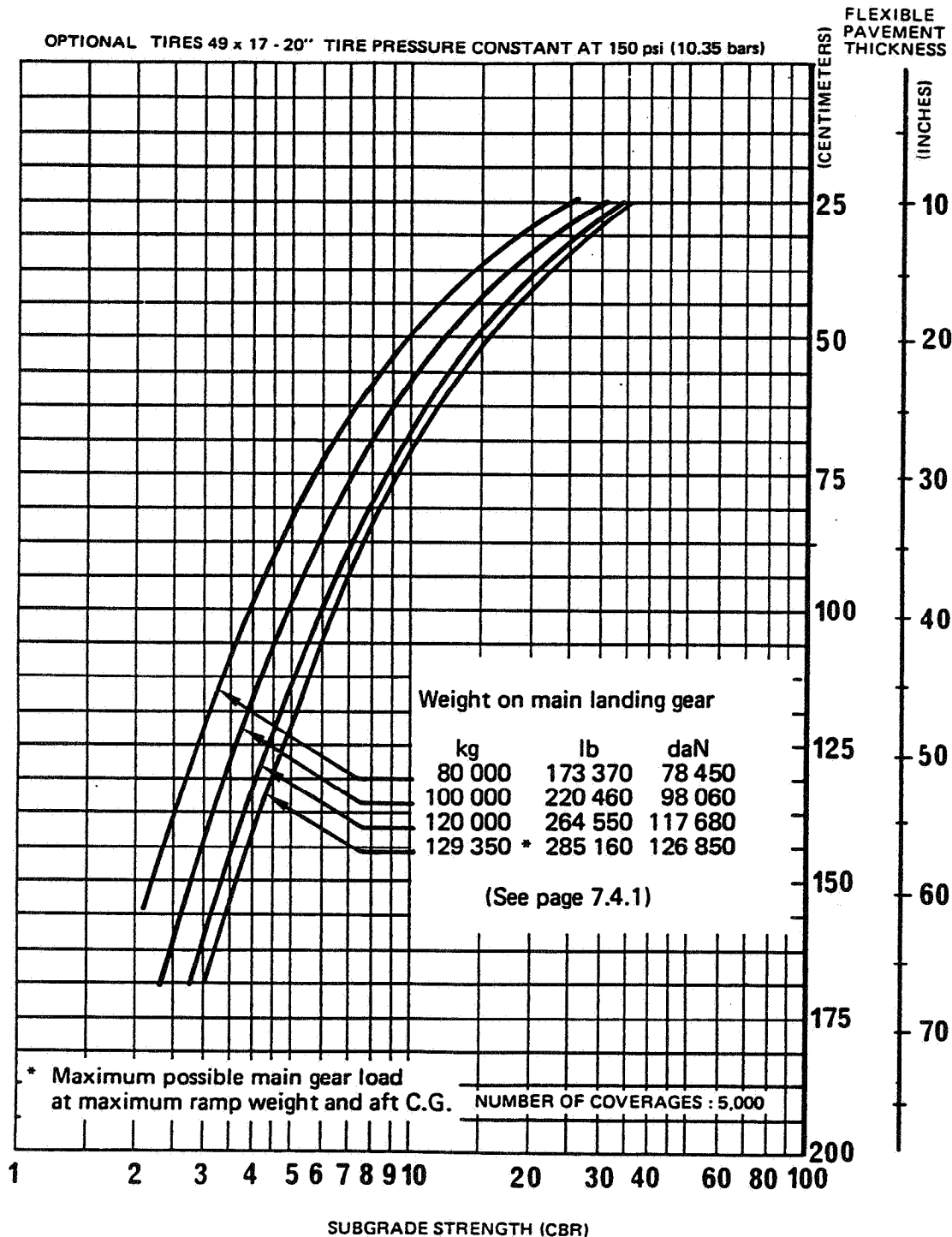

A A 5 07 05 01 0 A B 0

Printed in France

7.5.1.2 FLEXIBLE PAVEMENT REQUIREMENTS
U.S. CORPS OF ENGINEERS DESIGN METHOD
MODEL B2 - 137t OPTIONAL TIRES

A 300
AIRPLANE CHARACTERISTICS

Printed in France

A A 5 07 05 01 0 A C 0

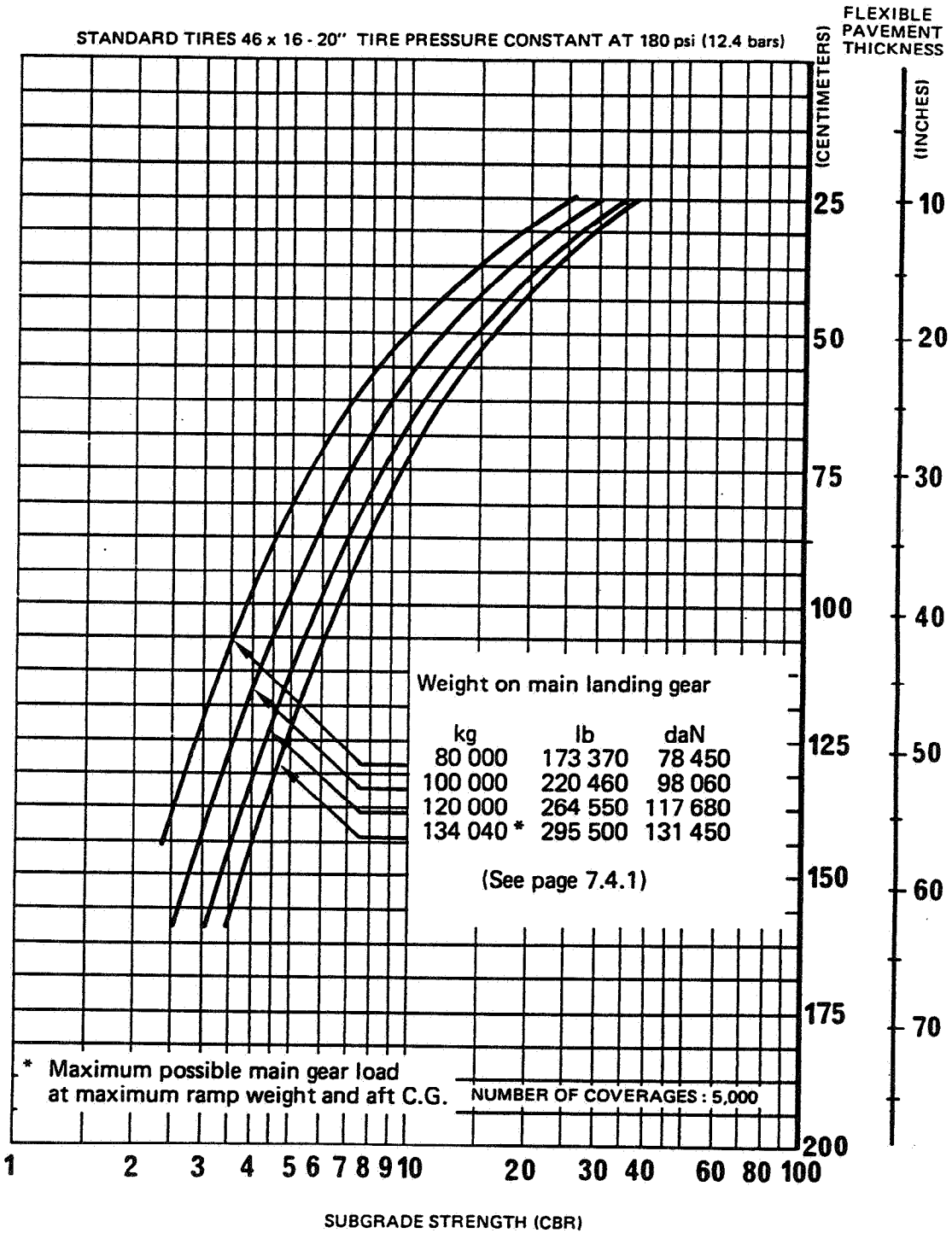

7.5.1.3 FLEXIBLE PAVEMENT REQUIREMENTS
U.S. CORPS OF ENGINEERS DESIGN METHOD
MODEL B2 - 142t STANDARD TIRES

A 300
AIRPLANE CHARACTERISTICS

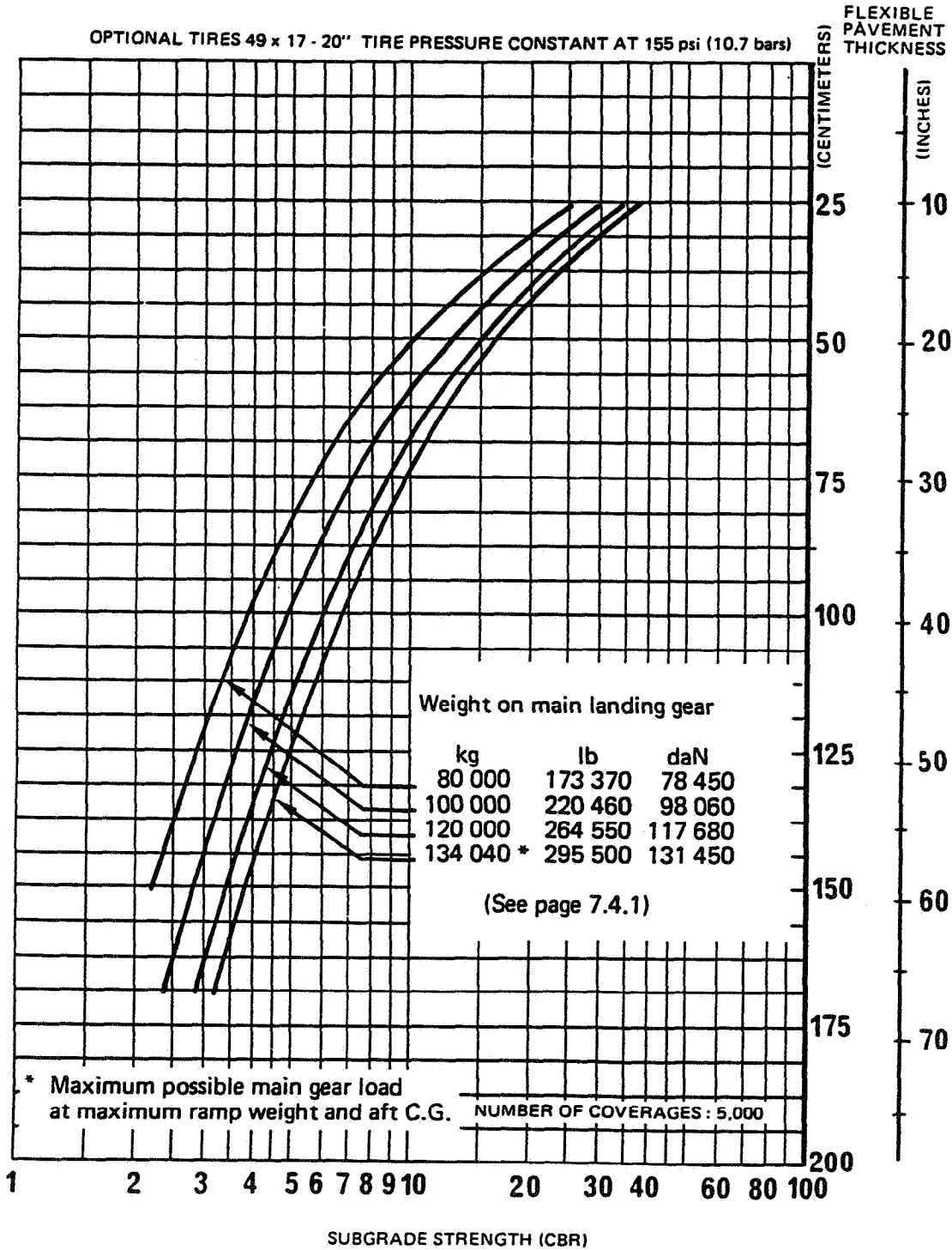

A A 5 07 05 01 0 AD 0

Printed in France

7.5.1.4 FLEXIBLE PAVEMENT REQUIREMENTS
U.S. CORPS OF ENGINEERS DESIGN METHOD
MODEL B2 - 142t OPTIONAL TIRES

AIRBUS  INDUSTRIE

A 300
AIRPLANE CHARACTERISTICS

Printed in France

THIS PAGE LEFT BLANK INTENTIONALLY

A 300

AIRPLANE CHARACTERISTICS

STANDARD TIRES 46 x 16 - 20" TIRE PRESSURE CONSTANT AT 180 psi (12.4 bars)

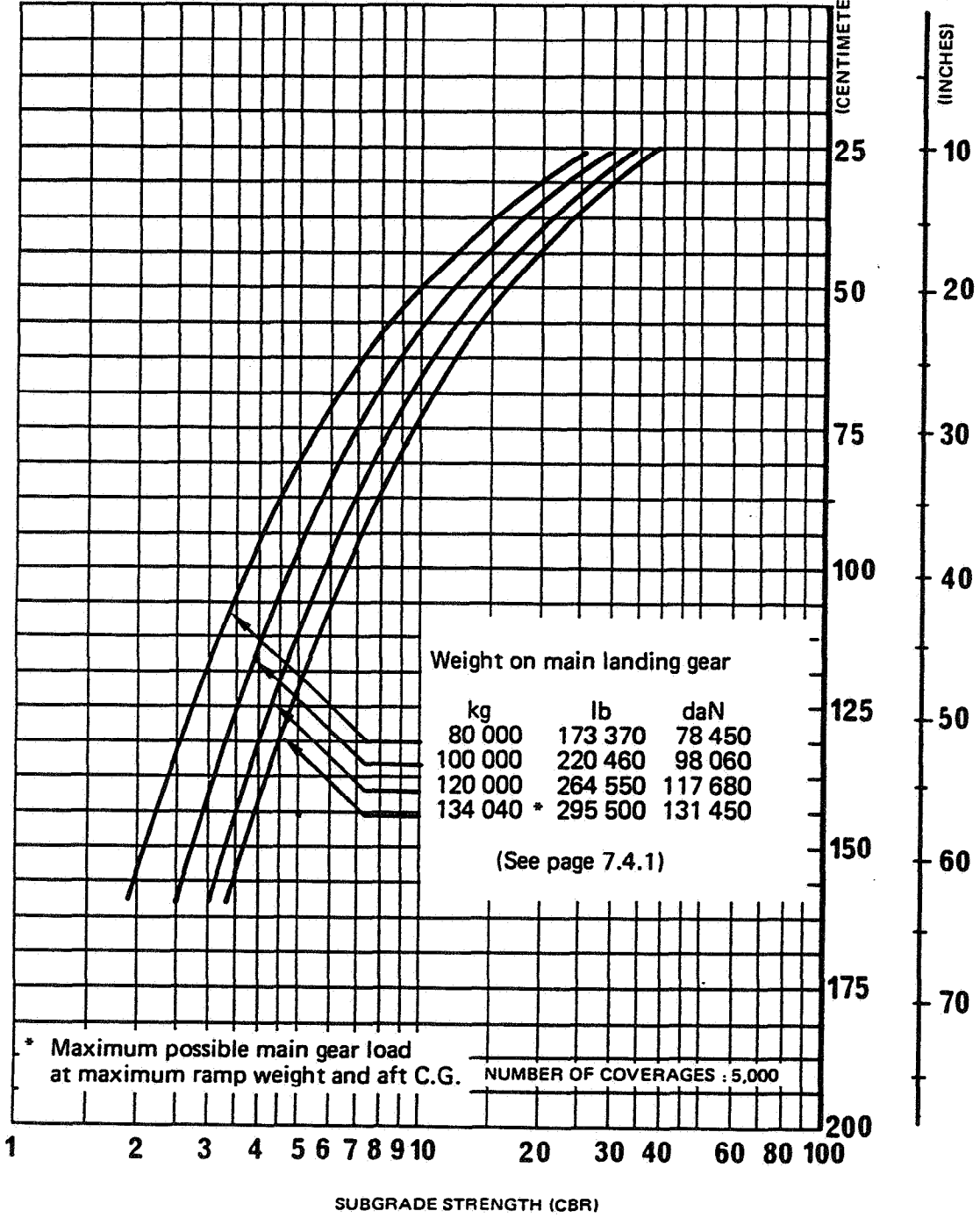

Printed in France

A A 5 07 05 02 0 AA 0

7.5.2.1 FLEXIBLE PAVEMENT REQUIREMENTS
 U.S. CORPS OF ENGINEERS DESIGN METHOD
 MODEL B2K - 142t STANDARD TIRES

A 300

AIRPLANE CHARACTERISTICS

OPTIONAL TIRES 49 x 17 - 20" TIRE PRESSURE CONSTANT AT 155 psi (10.7 bars)

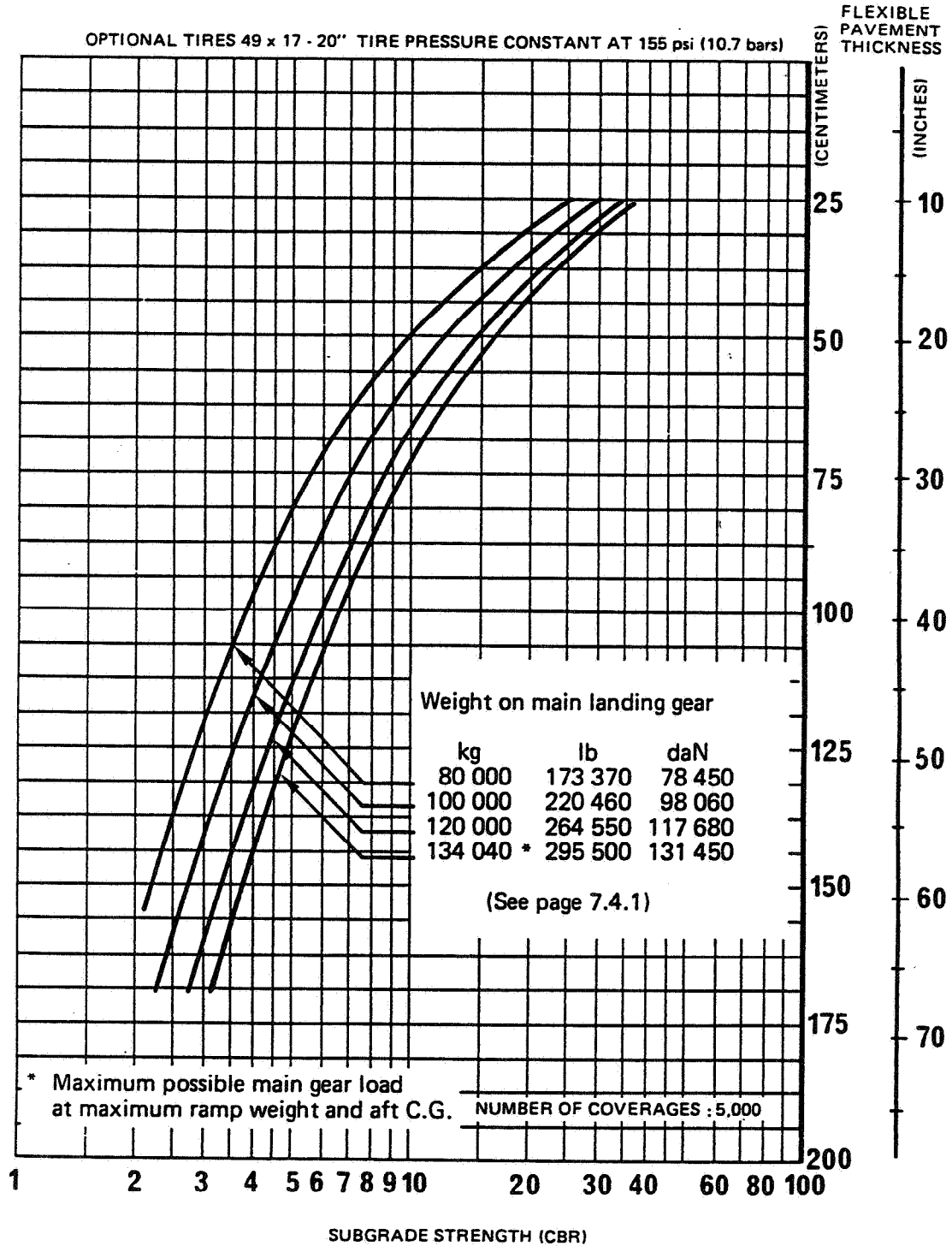

Printed in France

A A 5 07 05 02 0 AB 0

7.5.2.2 FLEXIBLE PAVEMENT REQUIREMENTS

U.S. CORPS OF ENGINEERS DESIGN METHOD

MODEL B2K - OPTIONAL TIRES

AIRBUS  INDUSTRIE
A 300
AIRPLANE CHARACTERISTICS

Printed in France

THIS PAGE LEFT BLANK INTENTIONALLY

A 300
AIRPLANE CHARACTERISTICS

Printed in France

A A 5 07 05 03 0 AA 0

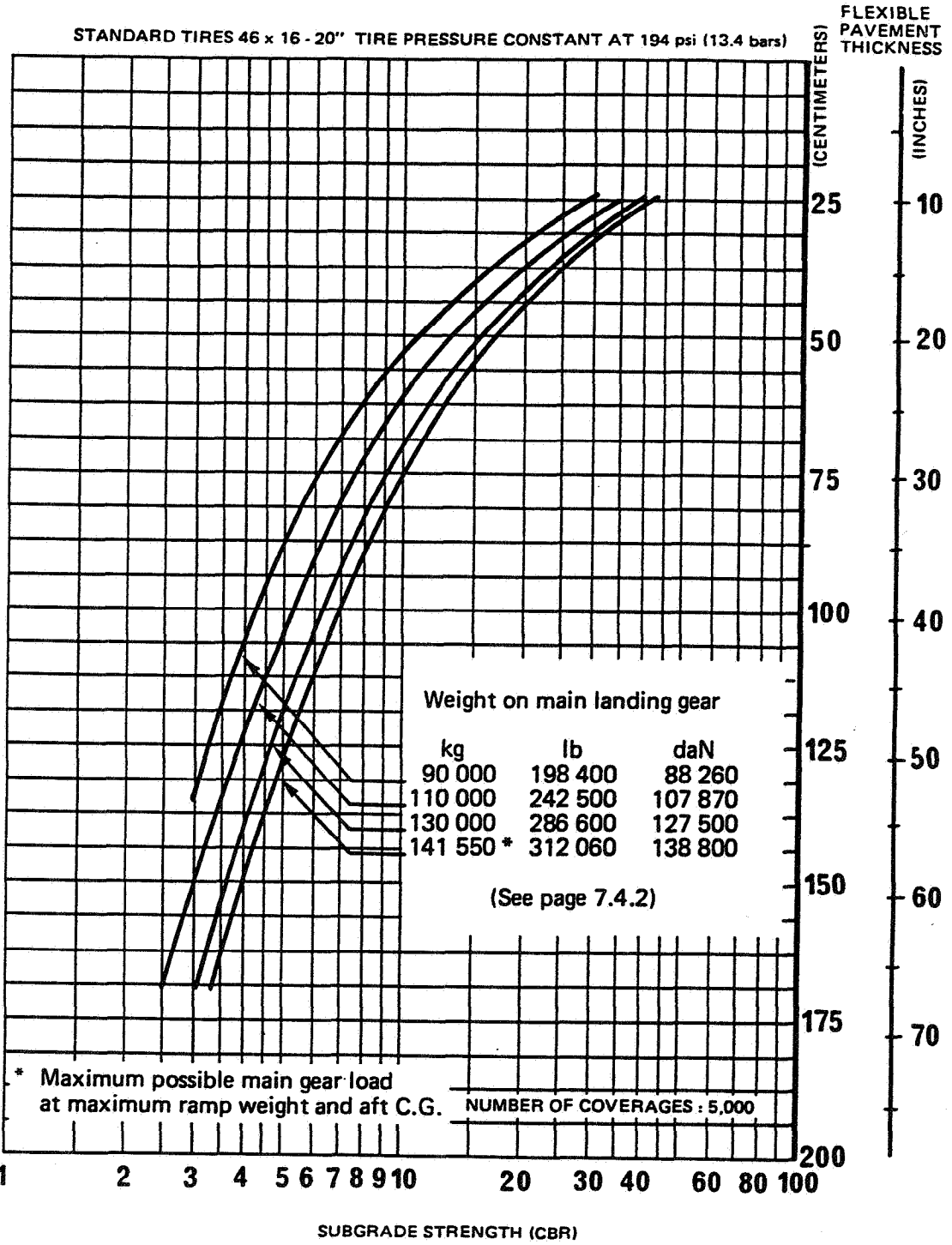

7.5.3.1 FLEXIBLE PAVEMENT REQUIREMENTS
U.S. CORPS OF ENGINEERS DESIGN METHOD
MODEL B4 - 150t STANDARD TIRES

A 300
AIRPLANE CHARACTERISTICS

OPTIONAL TIRES 49 x 17 - 20" TIRE PRESSURE CONSTANT AT 164 psi (11.3 bars)

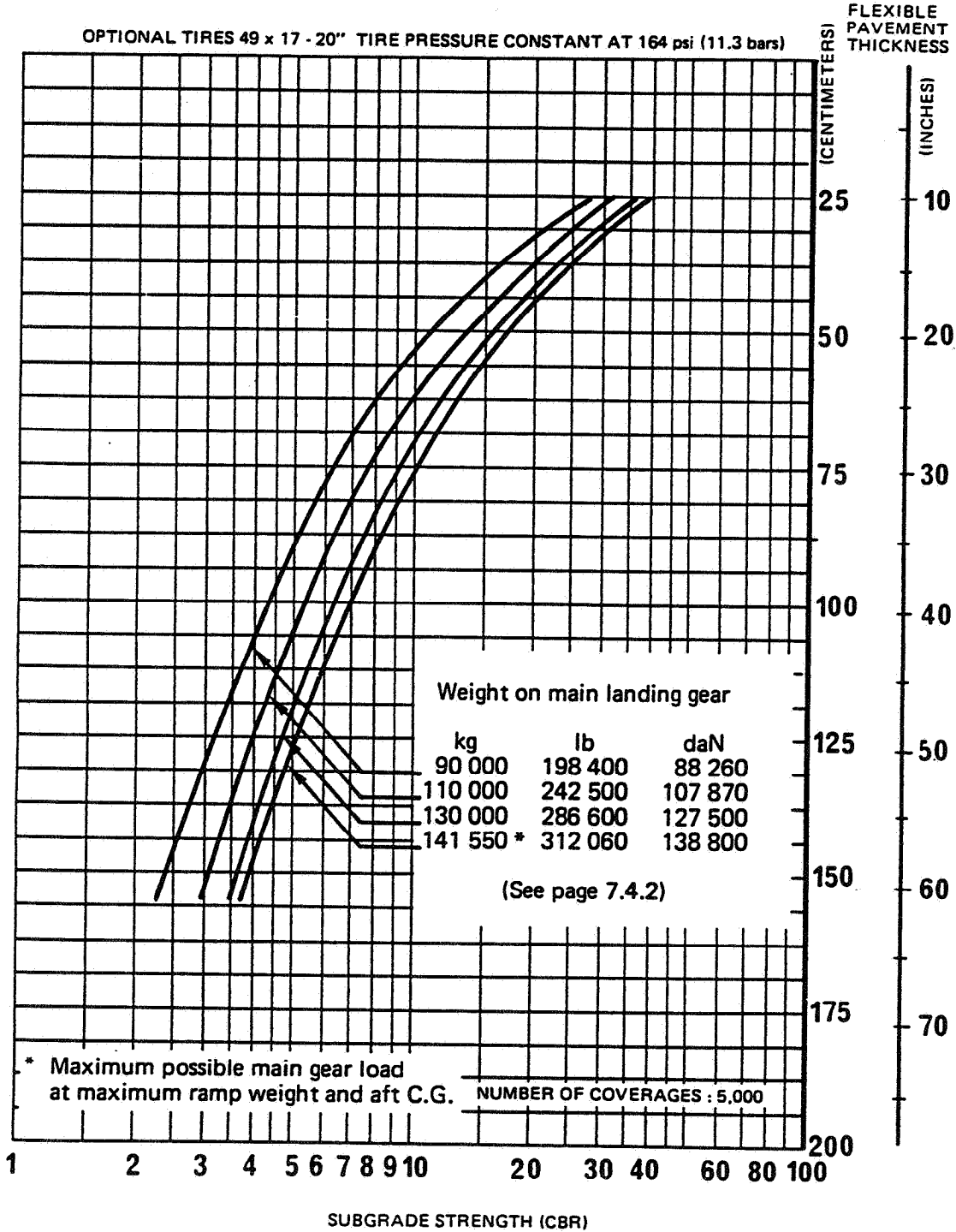

AA 5 07 05 03 0 AB 0

Printed in France

7.5.3.2 FLEXIBLE PAVEMENT REQUIREMENTS
U.S. CORPS OF ENGINEERS DESIGN METHOD
MODEL B4 - 150t OPTIONAL TIRES

A 300
AIRPLANE CHARACTERISTICS

Printed in France

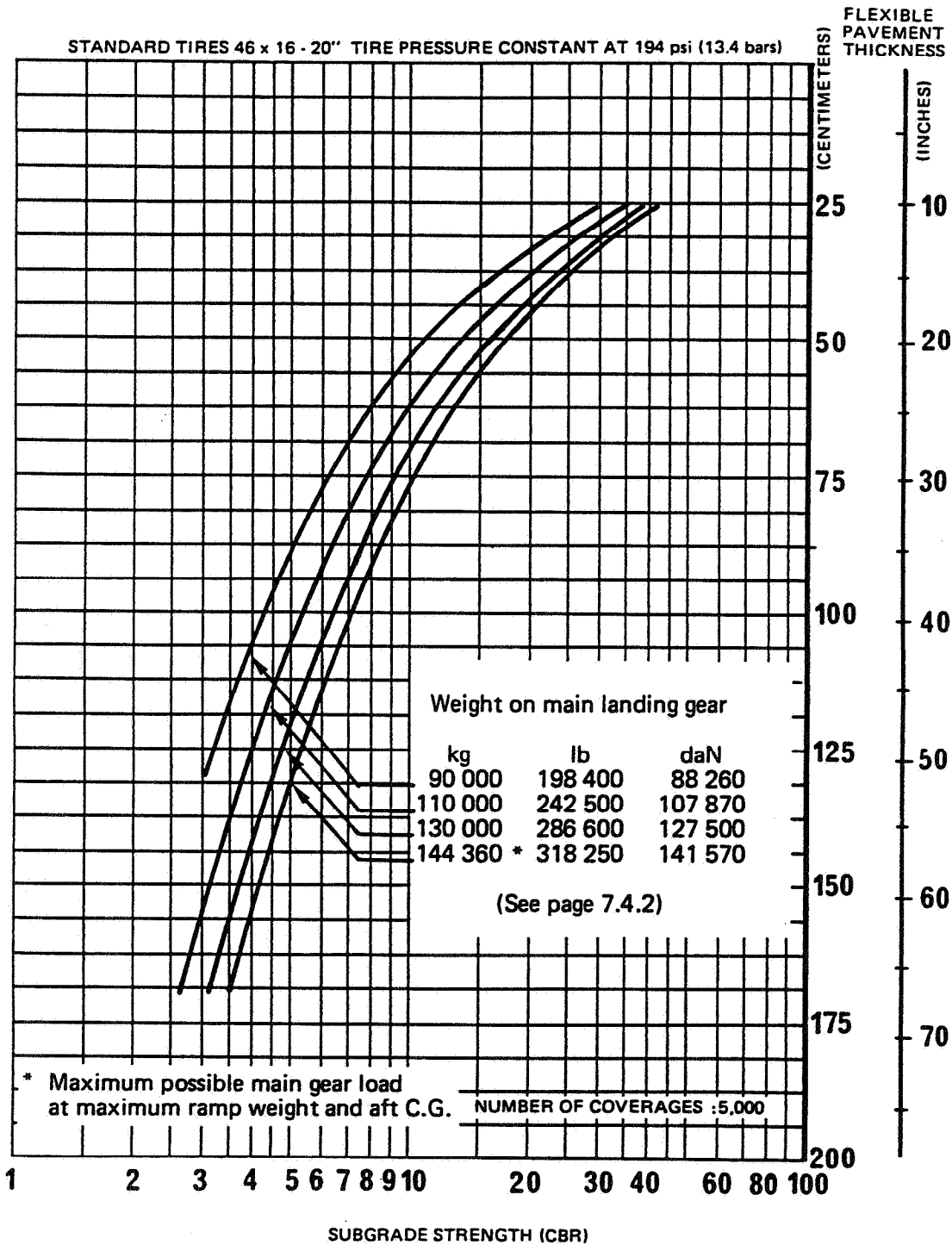

A A 5 07 05 03 0 AC 0

7.5.3.3 FLEXIBLE PAVEMENT REQUIREMENTS
U.S. CORPS OF ENGINEERS DESIGN METHOD
MODEL B4 - 153t STANDARD TIRES

A 300
AIRPLANE CHARACTERISTICS

OPTIONAL TIRES 49 x 17 - 20" TIRE PRESSURE CONSTANT AT 164 psi (11.3 bars)

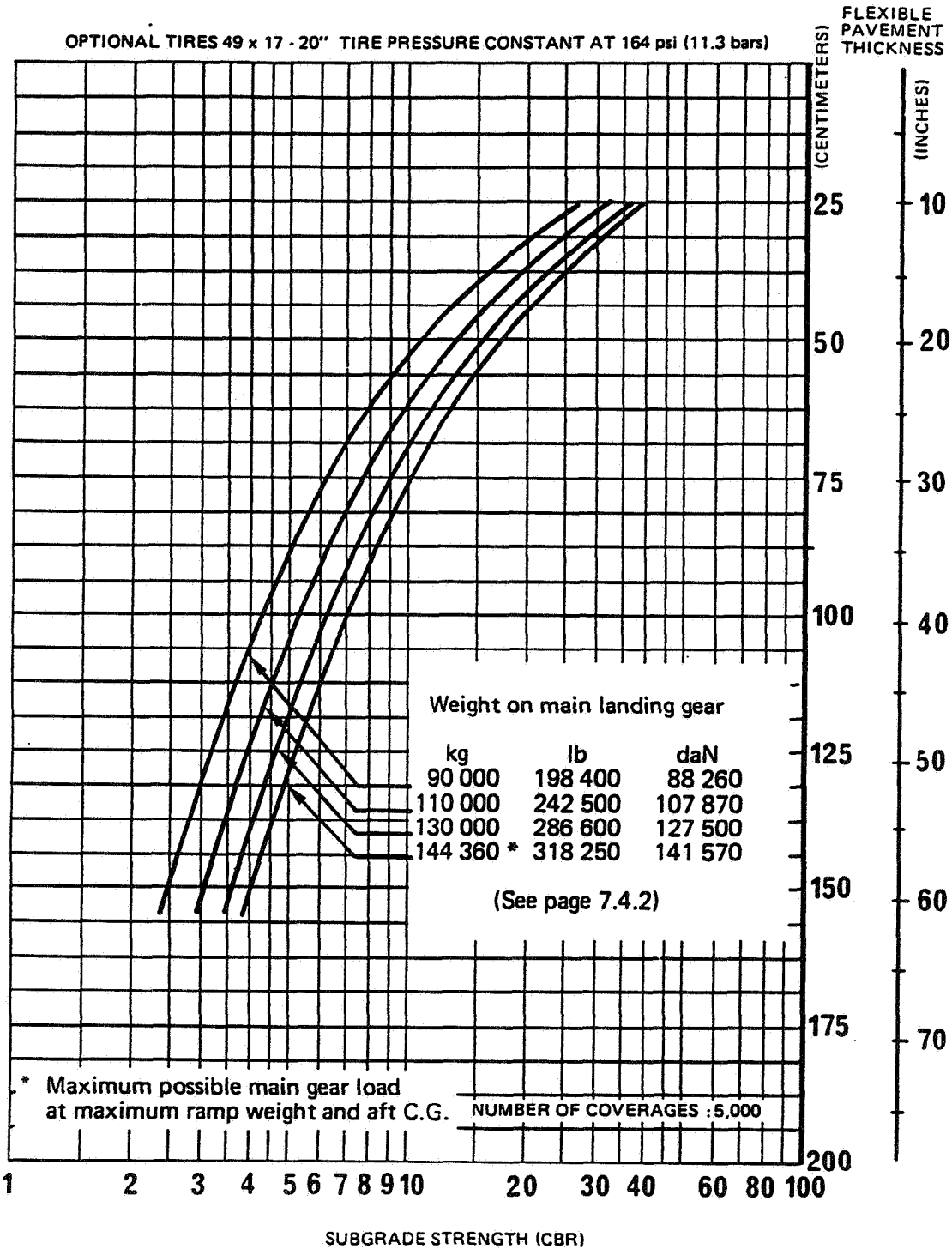

Printed in France

A A 5 07 05 03 0 AD 0

7.5.3.4 FLEXIBLE PAVEMENT REQUIREMENTS
U.S. CORPS OF ENGINEERS DESIGN METHOD
MODEL B4 - 153t OPTIONAL TIRES

A 300

AIRPLANE CHARACTERISTICS

Printed in France

A A 5 07 05 03 0 AE 0

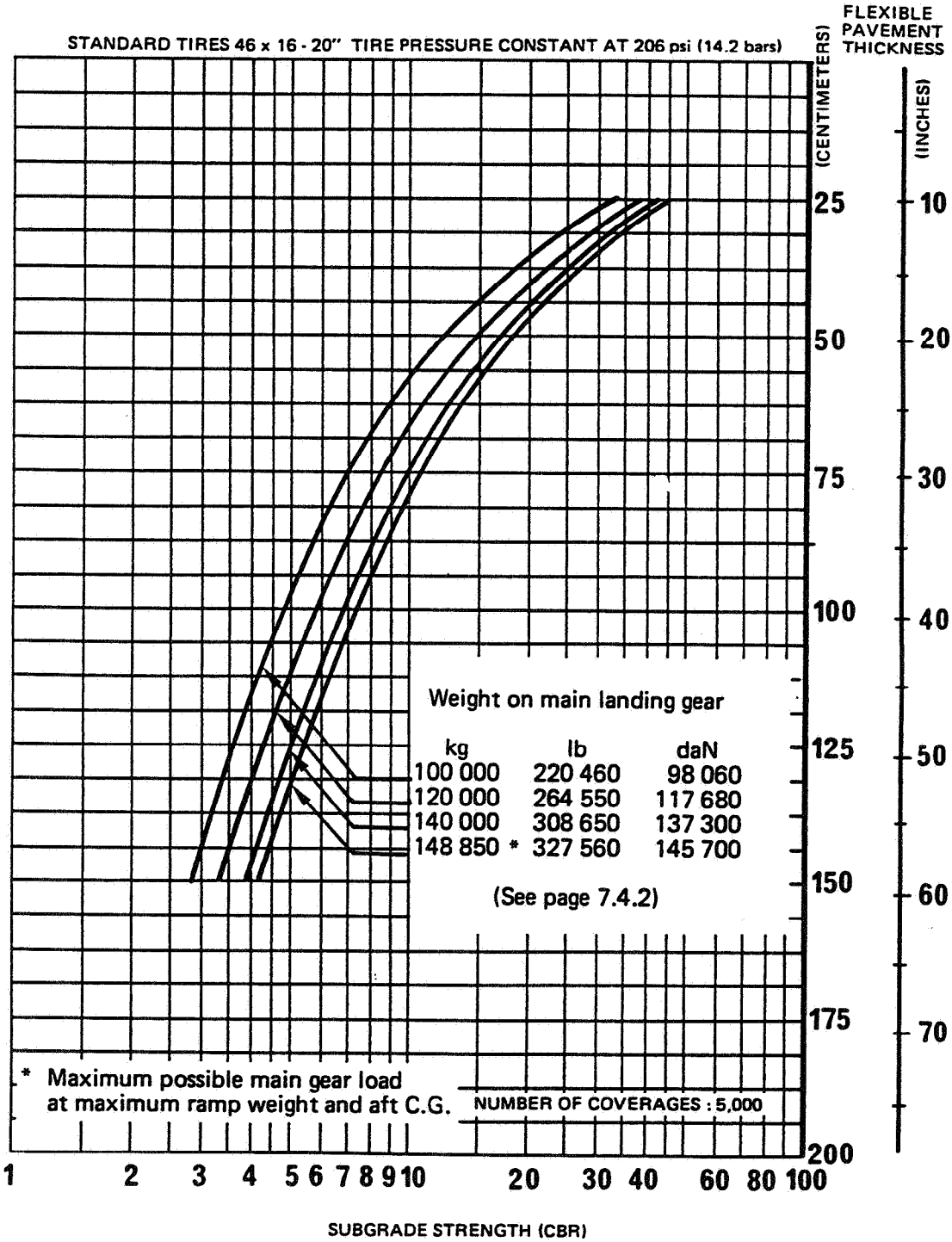

7.5.3.5 FLEXIBLE PAVEMENT REQUIREMENTS
 U.S. CORPS OF ENGINEERS DESIGN METHOD
 MODEL B4 - 157.5t STANDARD TIRES

A 300
AIRPLANE CHARACTERISTICS

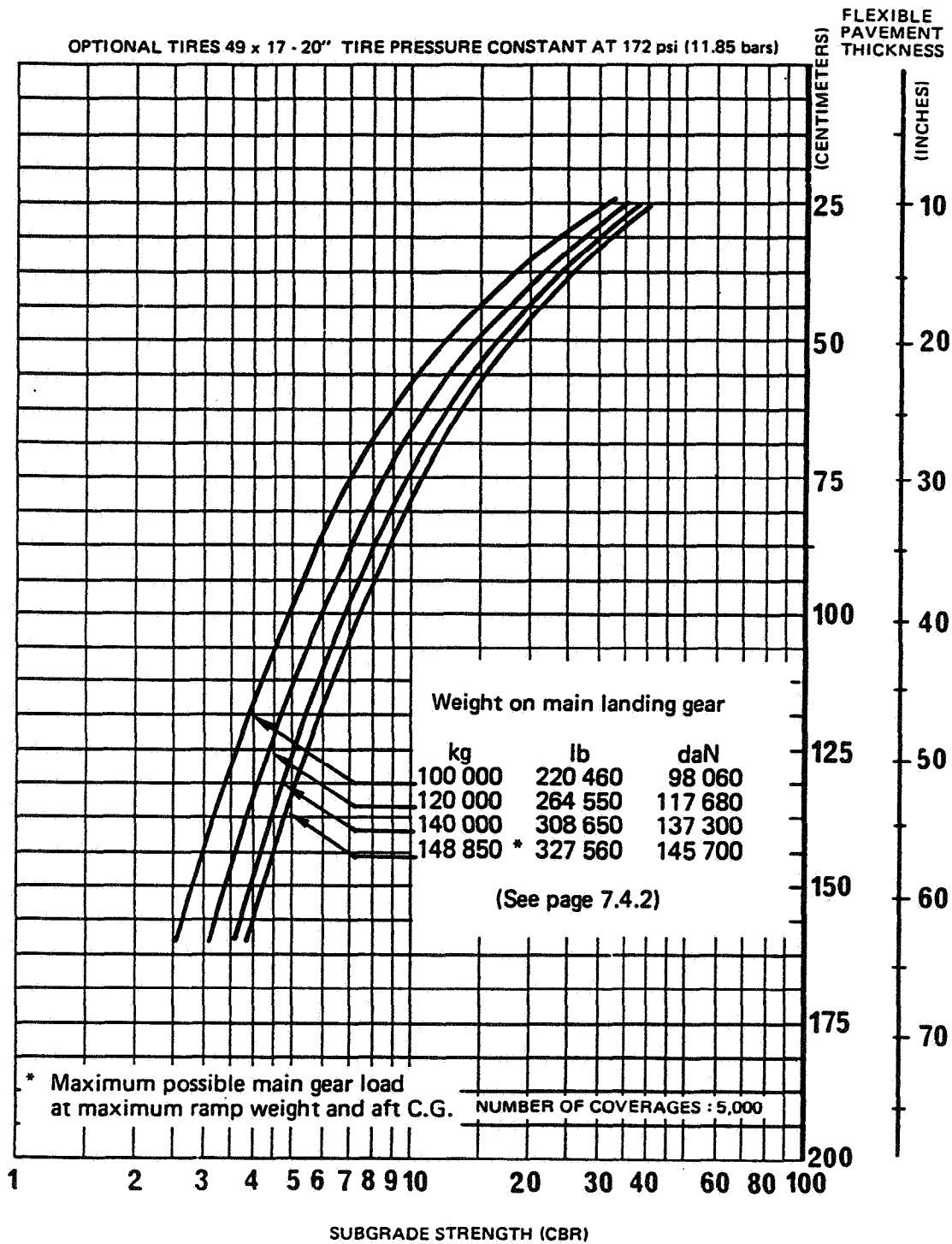

Printed in France

A A 5 07 05 03 0 AF 0

7.5.3.6 FLEXIBLE PAVEMENT REQUIREMENTS
U.S. CORPS OF ENGINEERS DESIGN METHOD
MODEL B4 - 157.5t OPTIONAL TIRES

A 300

AIRPLANE CHARACTERISTICS

Printed in France

A A 5 07 05 03 0 AG 0

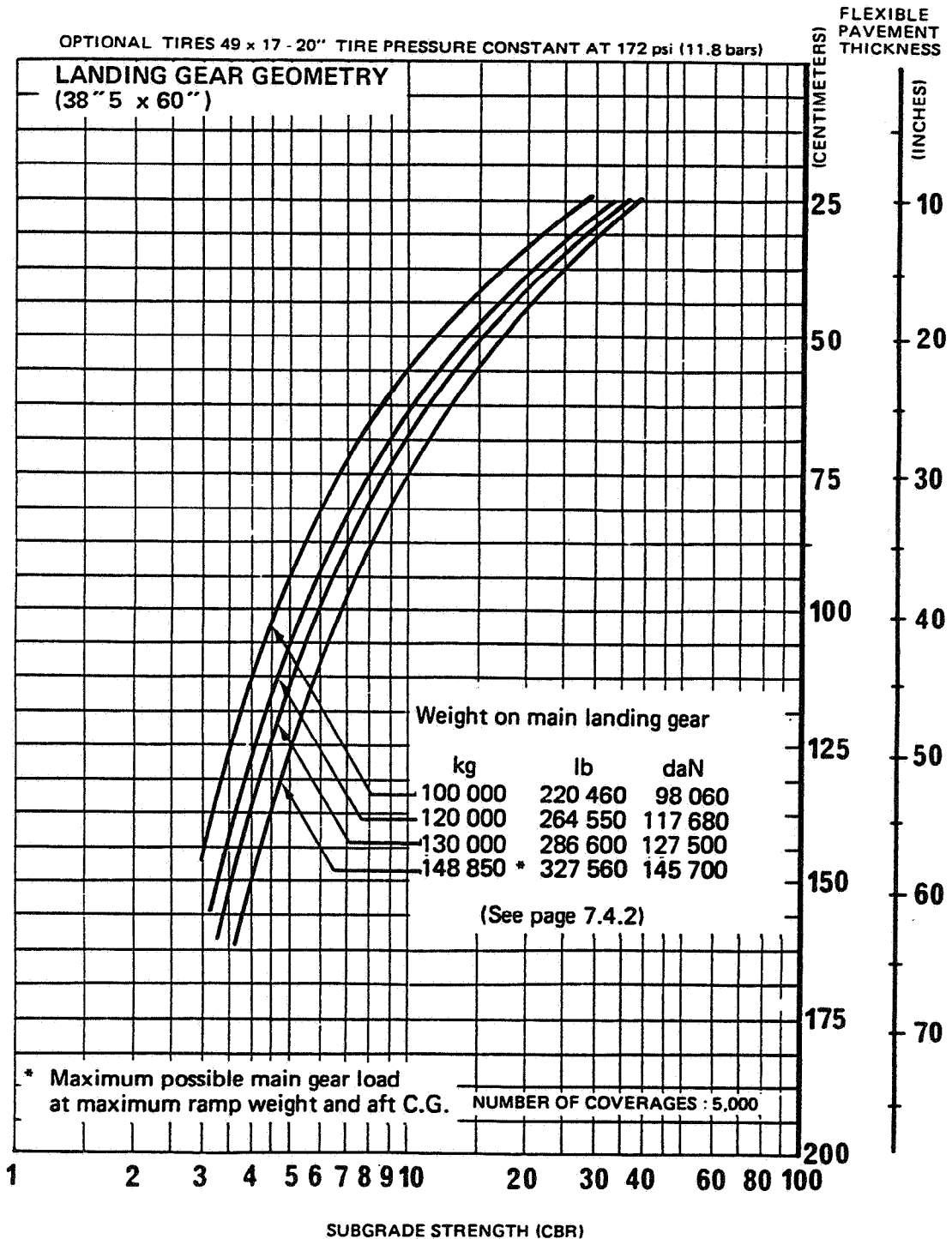

N

7.5.3.7 FLEXIBLE PAVEMENT REQUIREMENTS
 U.S. CORPS OF ENGINEERS DESIGN METHOD
 MODEL B4 - 157.5t OPTIONAL TIRES
 LANDING GEAR GEOMETRY
 38"5x60"

AIRBUS  INDUSTRIE
A 300
 AIRPLANE CHARACTERISTICS

STANDARD TIRES 49 x 17 - 20" TIRE PRESSURE CONSTANT AT 180 psi (12.4 bars)

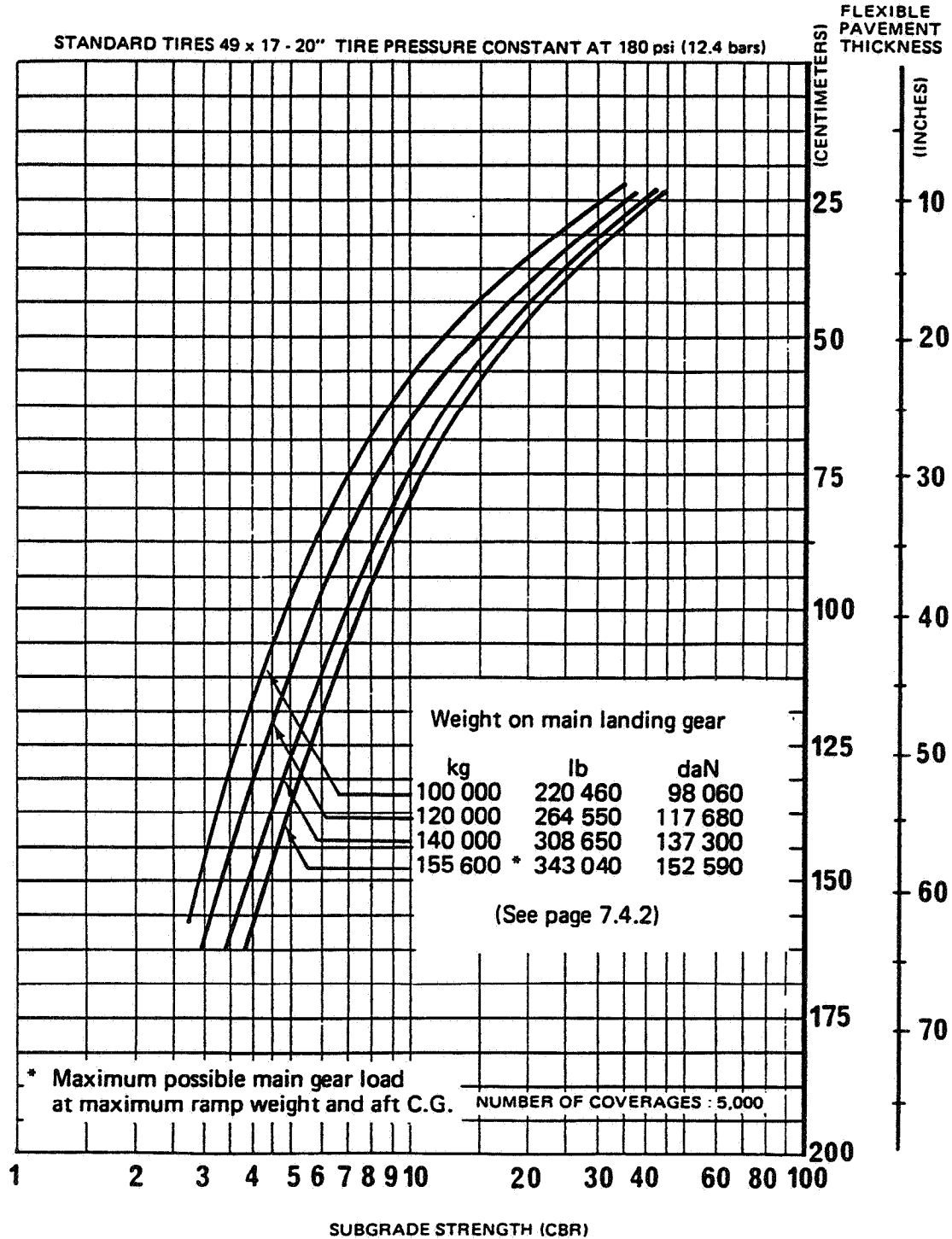

A A 5 07 05 03 0 AH 0

Printed in France

7.5.3.8 FLEXIBLE PAVEMENT REQUIREMENTS
 U.S. CORPS OF ENGINEERS DESIGN METHOD
 MODEL B4-C4 - 165t STANDARD TIRES

A 300

AIRPLANE CHARACTERISTICS

STANDARD TIRES 49 x 17 - 20" TIRE PRESSURE CONSTANT AT 180 psi (12.4 bars)

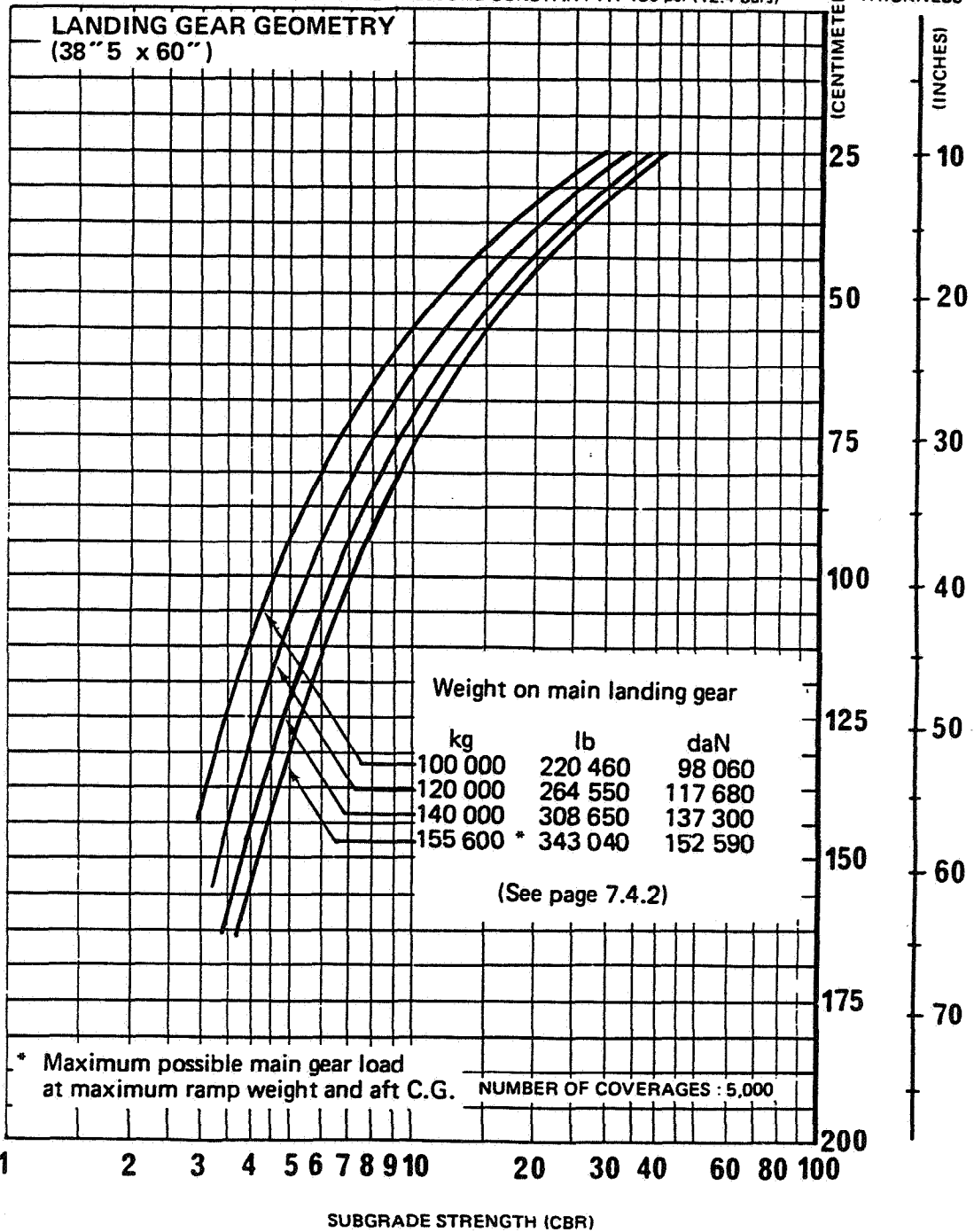

Printed in France

AA 5 07 05 03 0 A1 0

N

7.5.3.9 FLEXIBLE PAVEMENT REQUIREMENTS
U.S. CORPS OF ENGINEERS DESIGN METHOD
MODEL B4-C4 - 165t STANDARD TIRES
LANDING GEAR GEOMETRY
38"5x60"

A 300
AIRPLANE CHARACTERISTICS

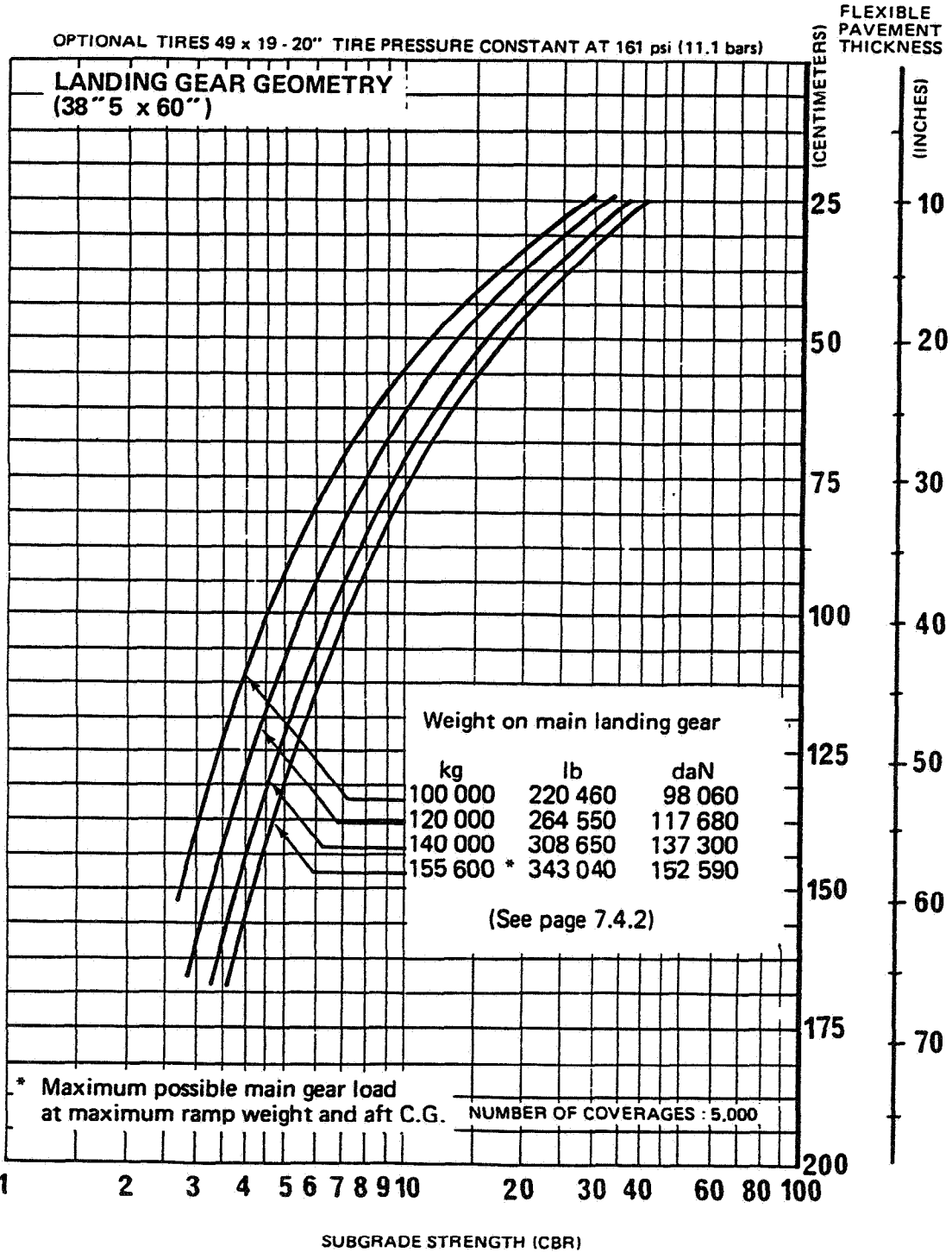

A A 5 07 05 03 0 AJ 0

Printed in France

7.5.3.10 FLEXIBLE PAVEMENT REQUIREMENTS
U.S. CORPS OF ENGINEERS DESIGN METHOD
MODEL B4-C4 - 165t OPTIONAL TIRES

A 300
AIRPLANE CHARACTERISTICS

7.6 FLEXIBLE PAVEMENT REQUIREMENTS - L.C.N. CONVERSION

In order to determine the airplane weight that can be accommodated on a particular flexible airport pavement, both the LCN of the pavement and the thickness "h" of the pavement must be known.

Example No. 1

Determination of the LCN of an A300 on a given runway.

Data :

- . Runway : h = 25"
- . Aircraft A300 B2 : Ramp weight 132 t
 - Tires : 46 x 16-20 (standard)
 - Average C.G. position

- a) Determination of the weight on main landing gear for the average C.G. position
Refer Page 7.4.1

- Load on main landing gear : 91 % of the total load :

$$\frac{132T \times 91}{100} = 120 T$$

- b) Aircraft LCN at "h" = 25"
Refer to page 7.6.1.1
Aircraft LCN : 73

Example No. 2

Determination of the max. ramp weight admissible on a given runway.

Data :

- . Runway : LCN 68
Thickness : 48 cm
- . Aircraft A300 B4 basic (150 T)
 - Tires : 49 x 17-20 (option)
 - Max. aft C.G. position

- a) Determination of the max. admissible load on main landing gear
Refer to page 7.6.3.2

Admissible weight on main landing gear : 125,000 kg.

AIRBUS  INDUSTRIE
A 300
AIRPLANE CHARACTERISTICS

b) Determination of the max. permissible aircraft ramp weight
Refer to page 7.4.2

- % of weight on main landing gear : 93.8 %
- Max. admissible aircraft ramp weight :

$$\frac{125\ 000\ \text{kg} \times 100}{93.8} = 133\ 260\ \text{kg}$$

Printed in France

A 300
AIRPLANE CHARACTERISTICS

Printed in France

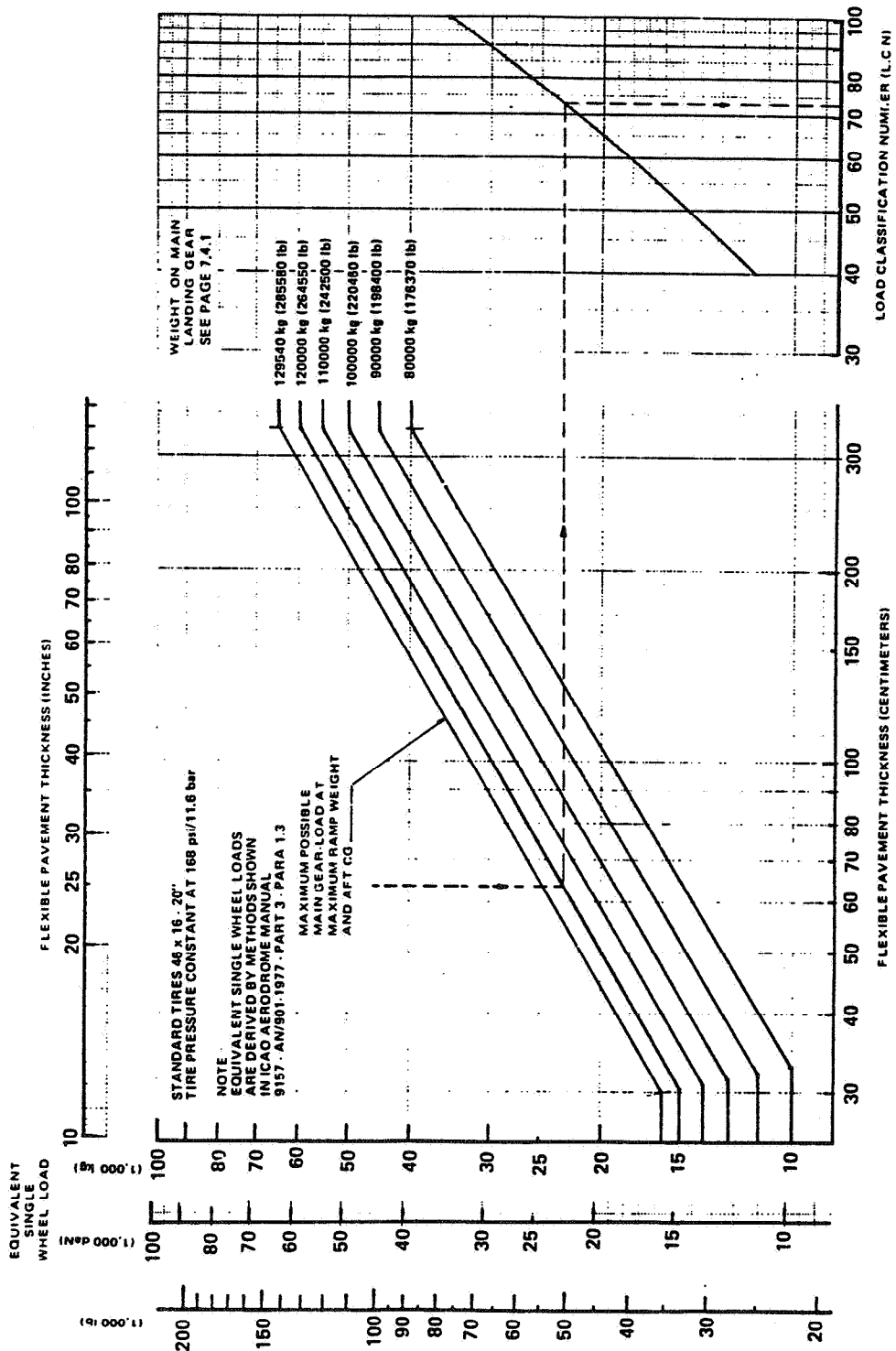

7.6.1.1 FLEXIBLE PAVEMENT REQUIREMENTS L.C.N. CONVERSION
MODEL B2 - 137t STANDARD TIRES

AIRBUS INDUSTRIE
A 300
 AIRPLANE CHARACTERISTICS

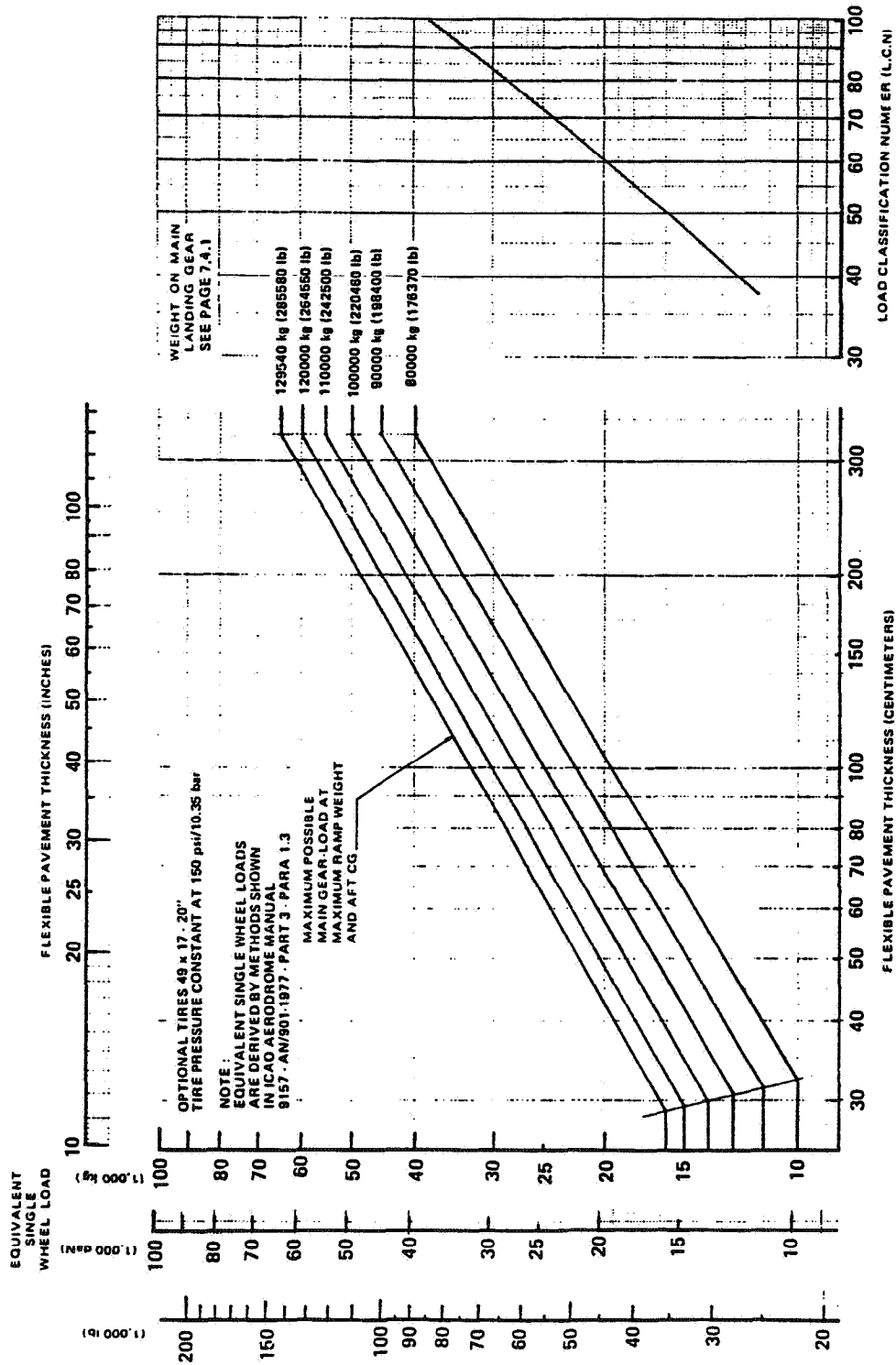

7.6.1.2 FLEXIBLE PAVEMENT REQUIREMENTS L.C.N. CONVERSION
 MODEL B2 - 137t OPTIONAL TIRES

A 300
AIRPLANE CHARACTERISTICS

Printed in France

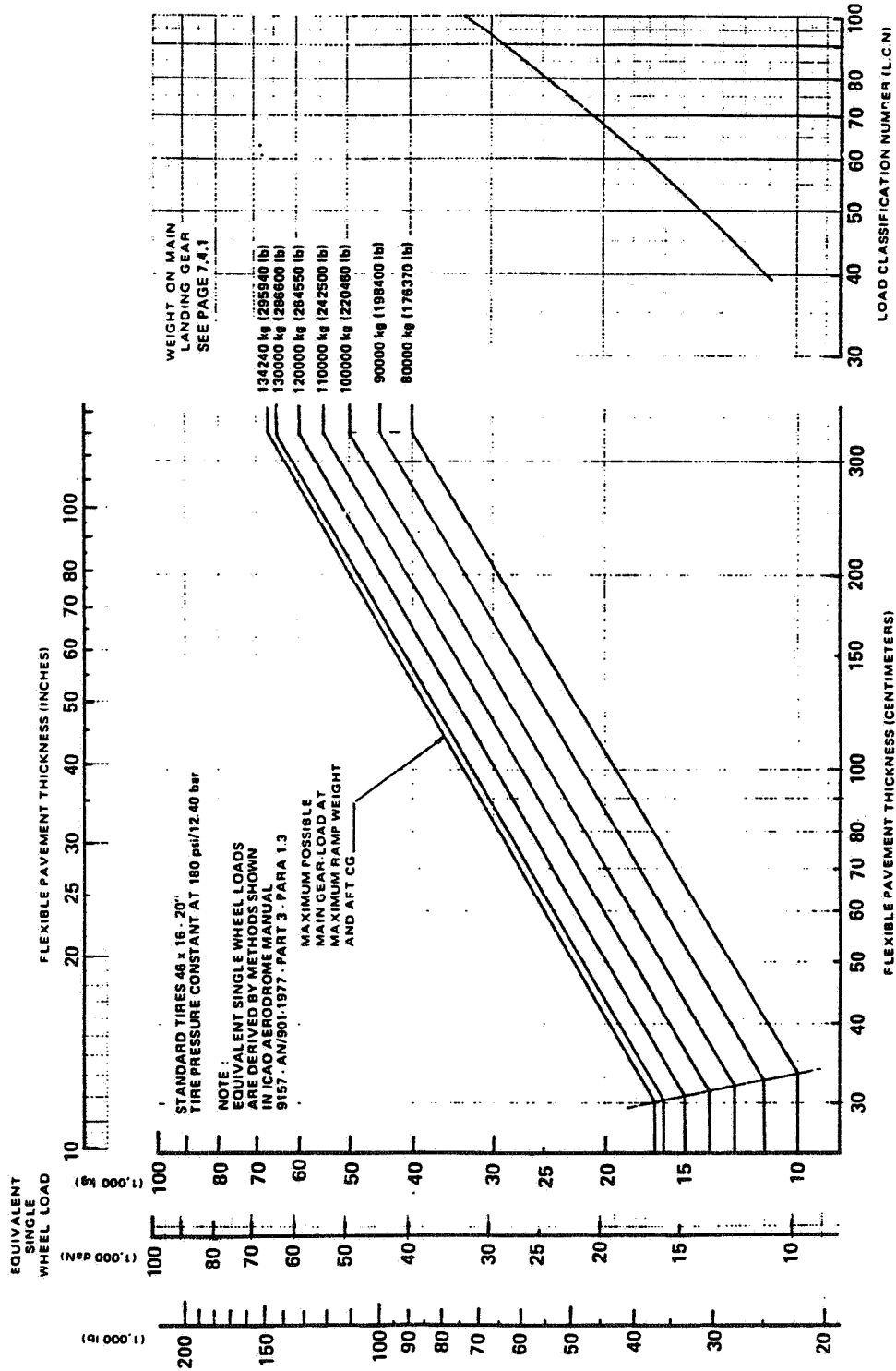

7.6.1.3 FLEXIBLE PAVEMENT REQUIREMENTS L.C.N. CONVERSION
MODEL B2 - 142t STANDARD TIRES

AIRBUS INDUSTRIE
A 300
 AIRPLANE CHARACTERISTICS

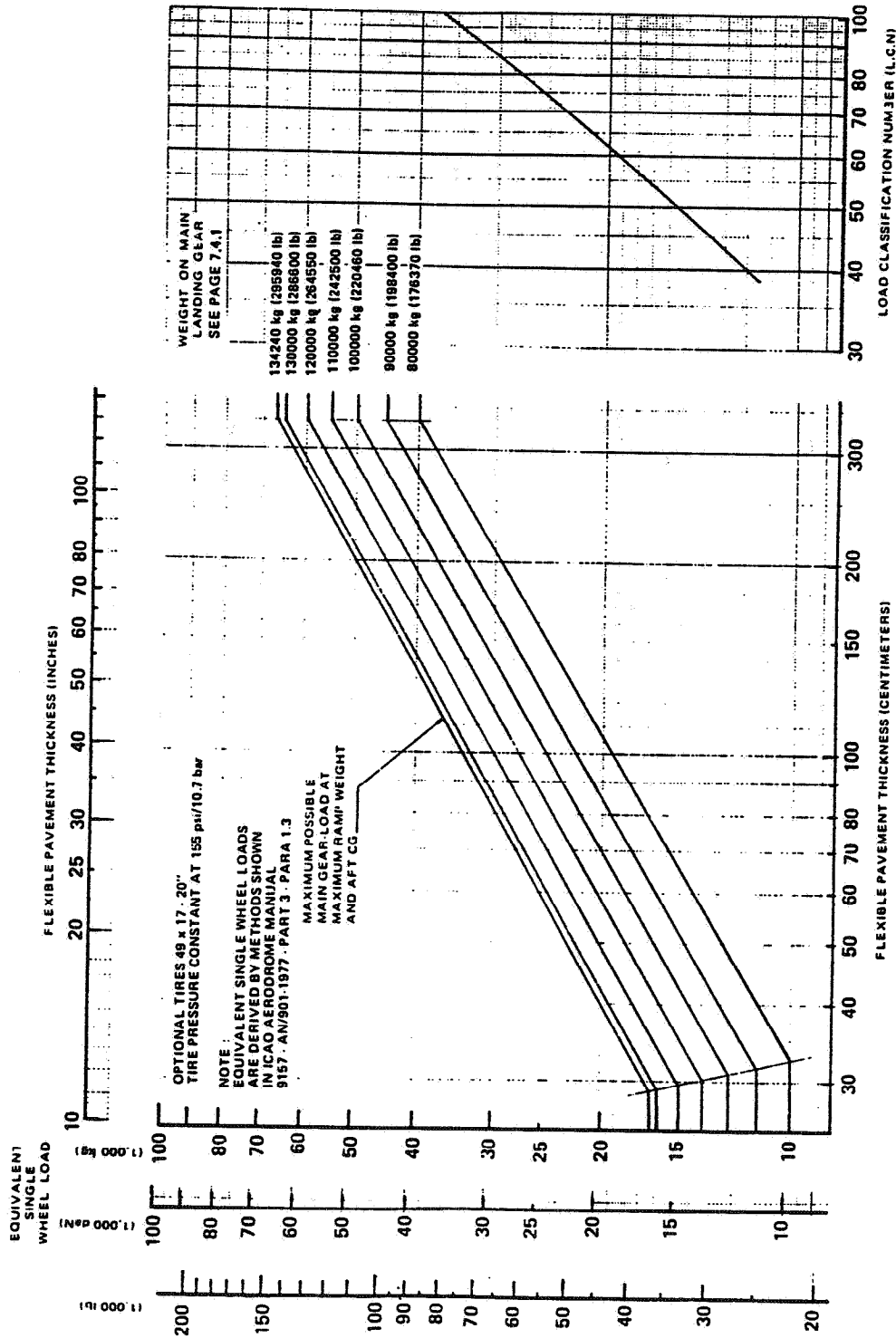

7.6.1.4 FLEXIBLE PAVEMENT REQUIREMENTS L.C.N. CONVERSION
 MODEL B2 - 142t OPTIONAL TIRES

AIRBUS  INDUSTRIE
A 300
AIRPLANE CHARACTERISTICS

Printed in France

THIS PAGE LEFT BLANK INTENTIONALLY

AIRBUS INDUSTRIE
A 300
 AIRPLANE CHARACTERISTICS

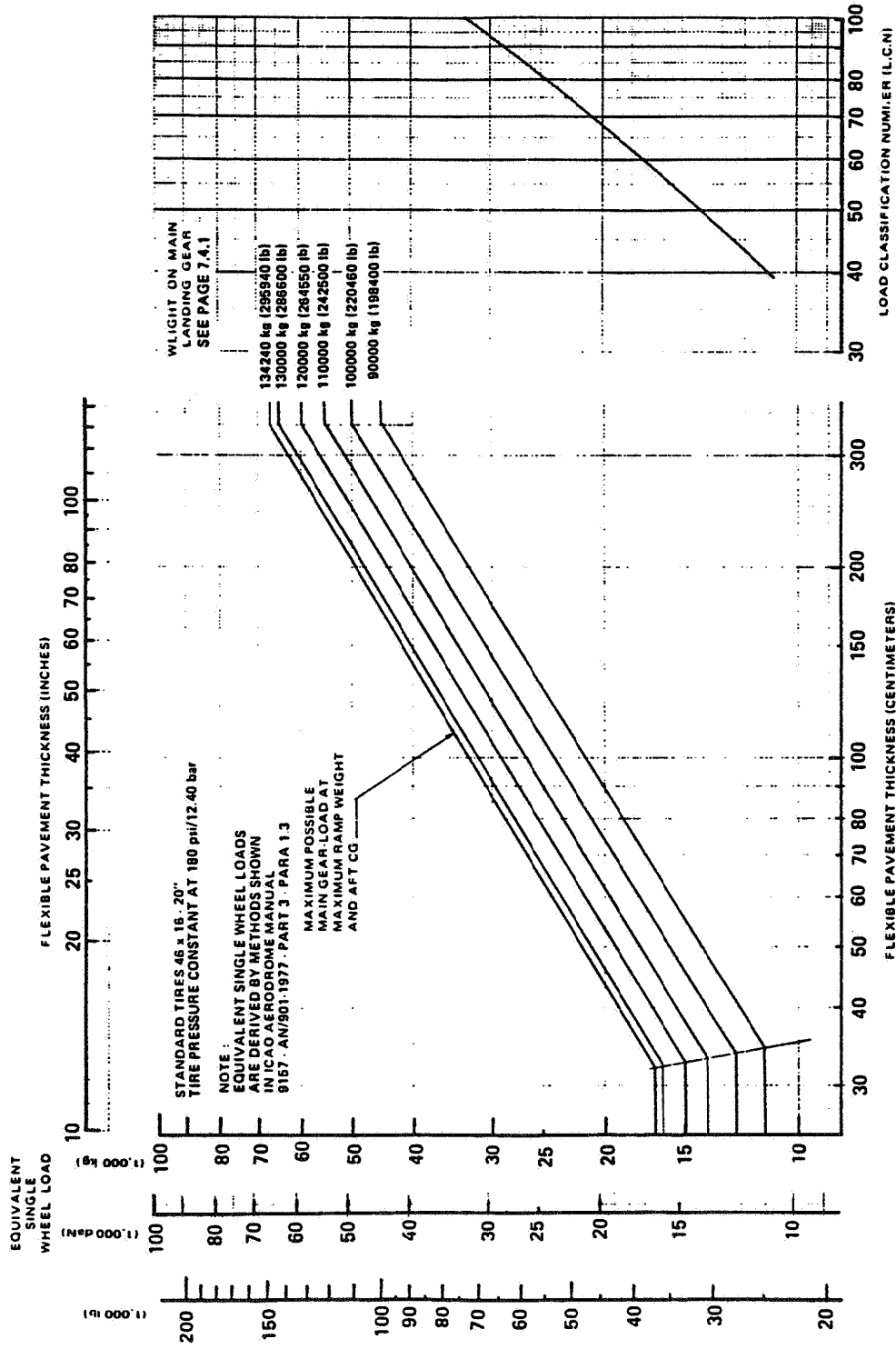

7.6.2.1 FLEXIBLE PAVEMENT REQUIREMENTS L.C.N. CONVERSION
 MODEL B2K - 142t STANDARD TIRES

AIRBUS INDUSTRIE
A 300
 AIRPLANE CHARACTERISTICS

Printed in France

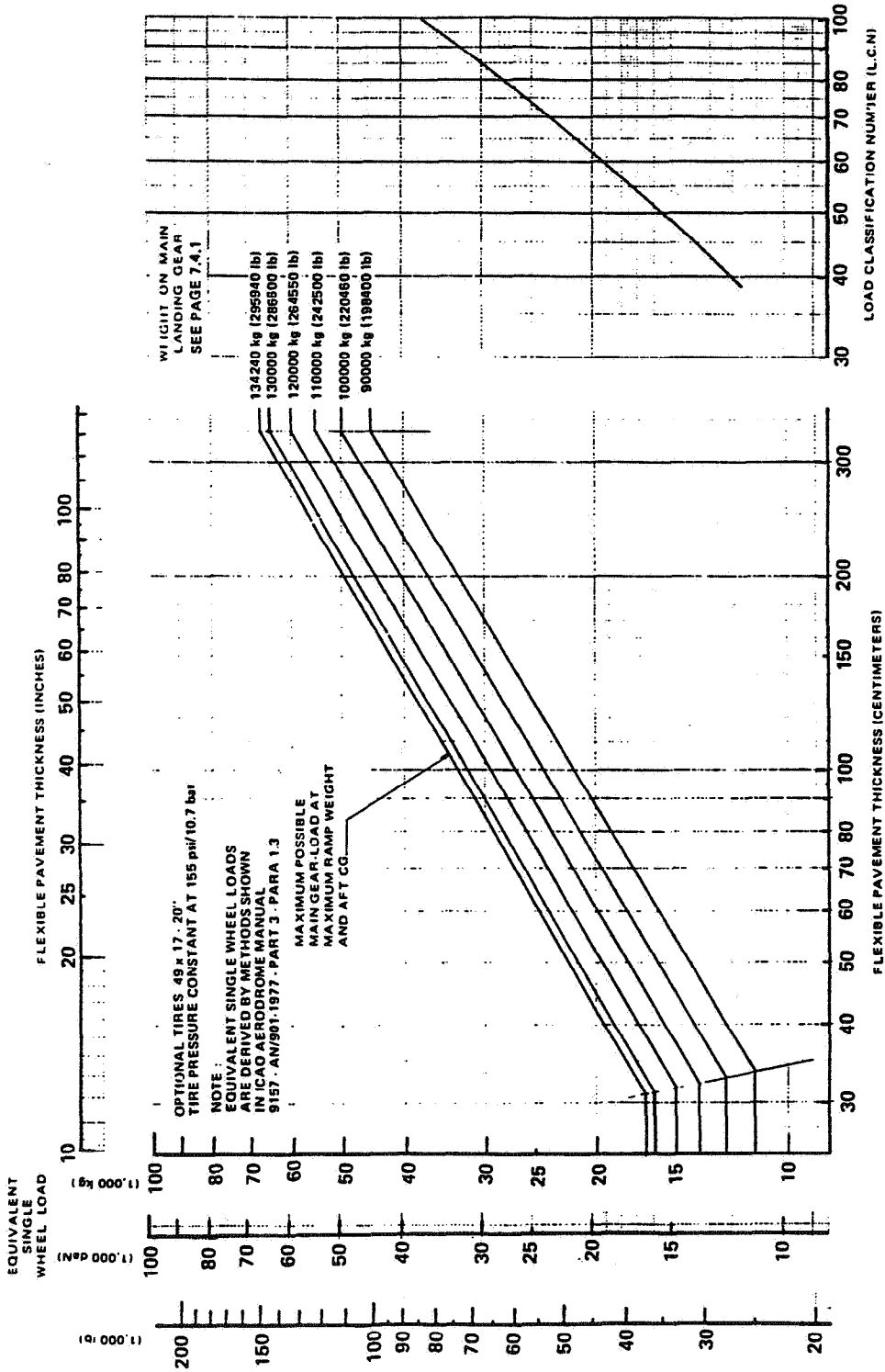

7.6.2.2 FLEXIBLE PAVEMENT REQUIREMENTS L.C.N. CONVERSION
 MODEL B2K - 142t OPTIONAL TIRES

AIRBUS  INDUSTRIE
A 300
AIRPLANE CHARACTERISTICS

Printed in France

THIS PAGE LEFT BLANK INTENTIONALLY

AIRBUS  INDUSTRIE
A 300
 AIRPLANE CHARACTERISTICS

Printed in France

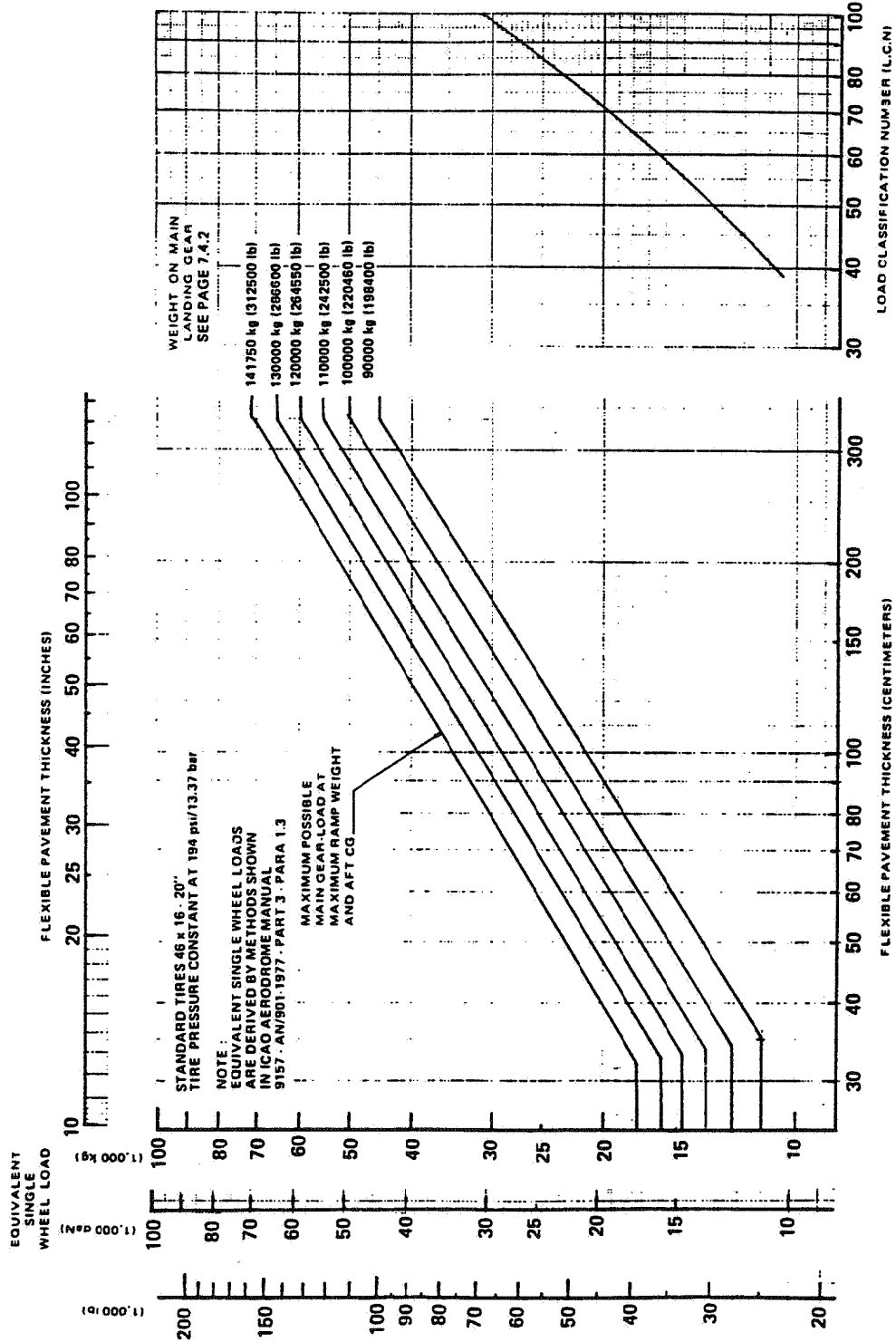

7.6.3.1 FLEXIBLE PAVEMENT REQUIREMENTS L.C.N. CONVERSION
 MODEL B4 - 150t STANDARD TIRES

AIRBUS INDUSTRIE
A 300
 AIRPLANE CHARACTERISTICS

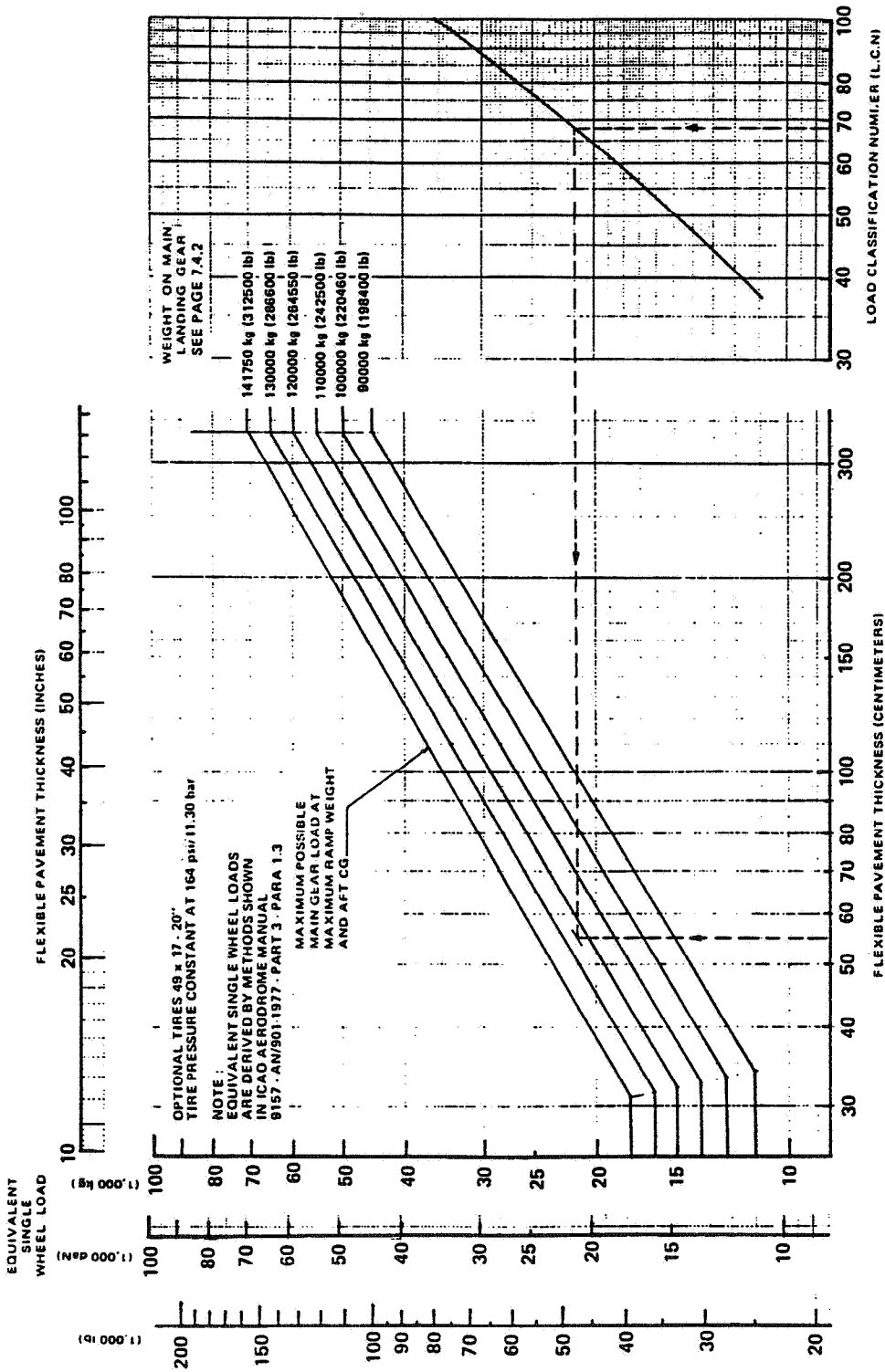

7.6.3.2 FLEXIBLE PAVEMENT REQUIREMENTS L.C.N. CONVERSION
 MODEL B4 - 150t OPTIONAL TIRES

AIRBUS  INDUSTRIE
A 300
 AIRPLANE CHARACTERISTICS

Printed in France

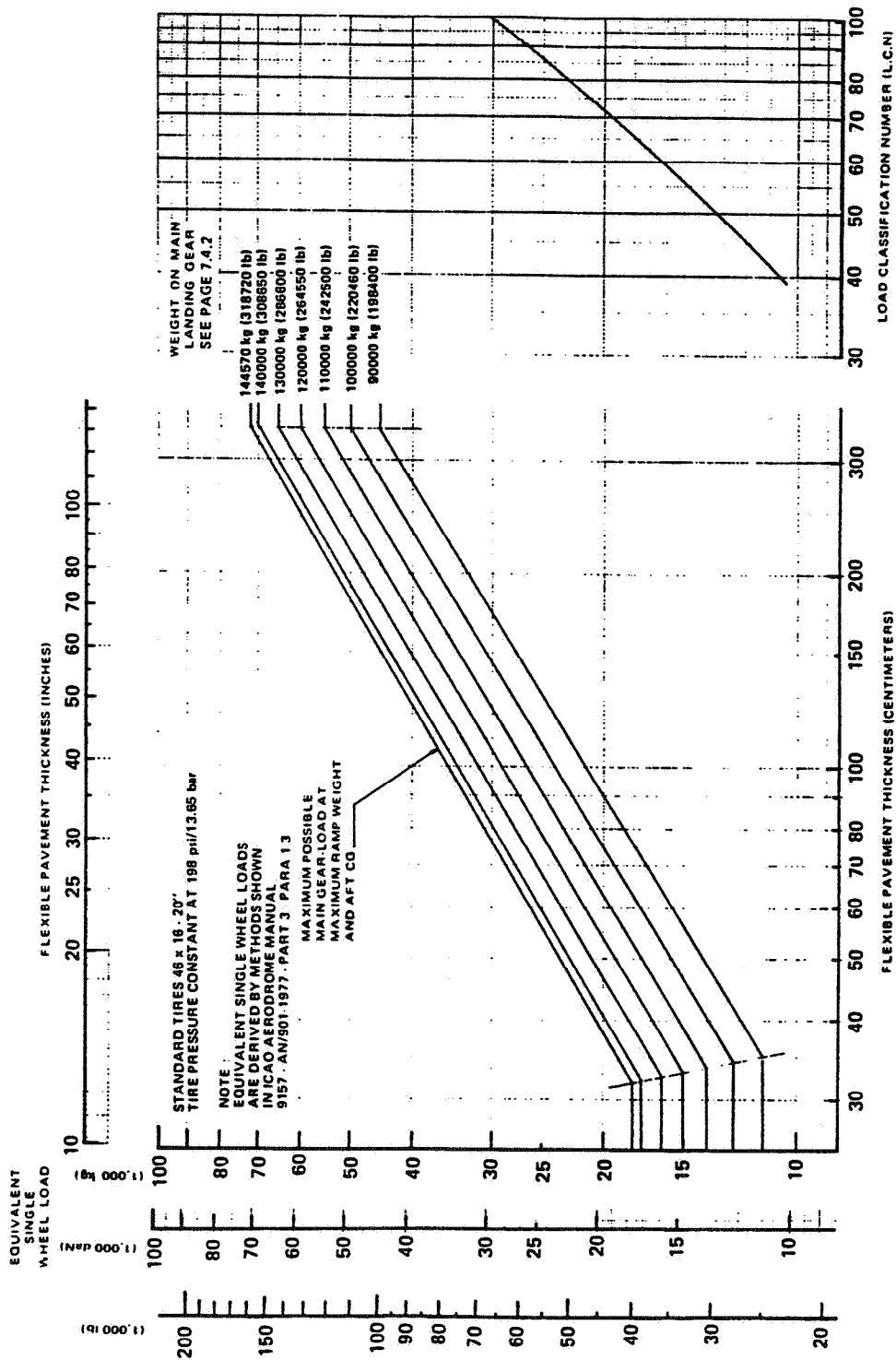

7.6.3.3 FLEXIBLE PAVEMENT REQUIREMENTS L.C.N. CONVERSION
 MODEL B4 - 153t STANDARD TIRES

AIRBUS  INDUSTRIE
A 300
 AIRPLANE CHARACTERISTICS

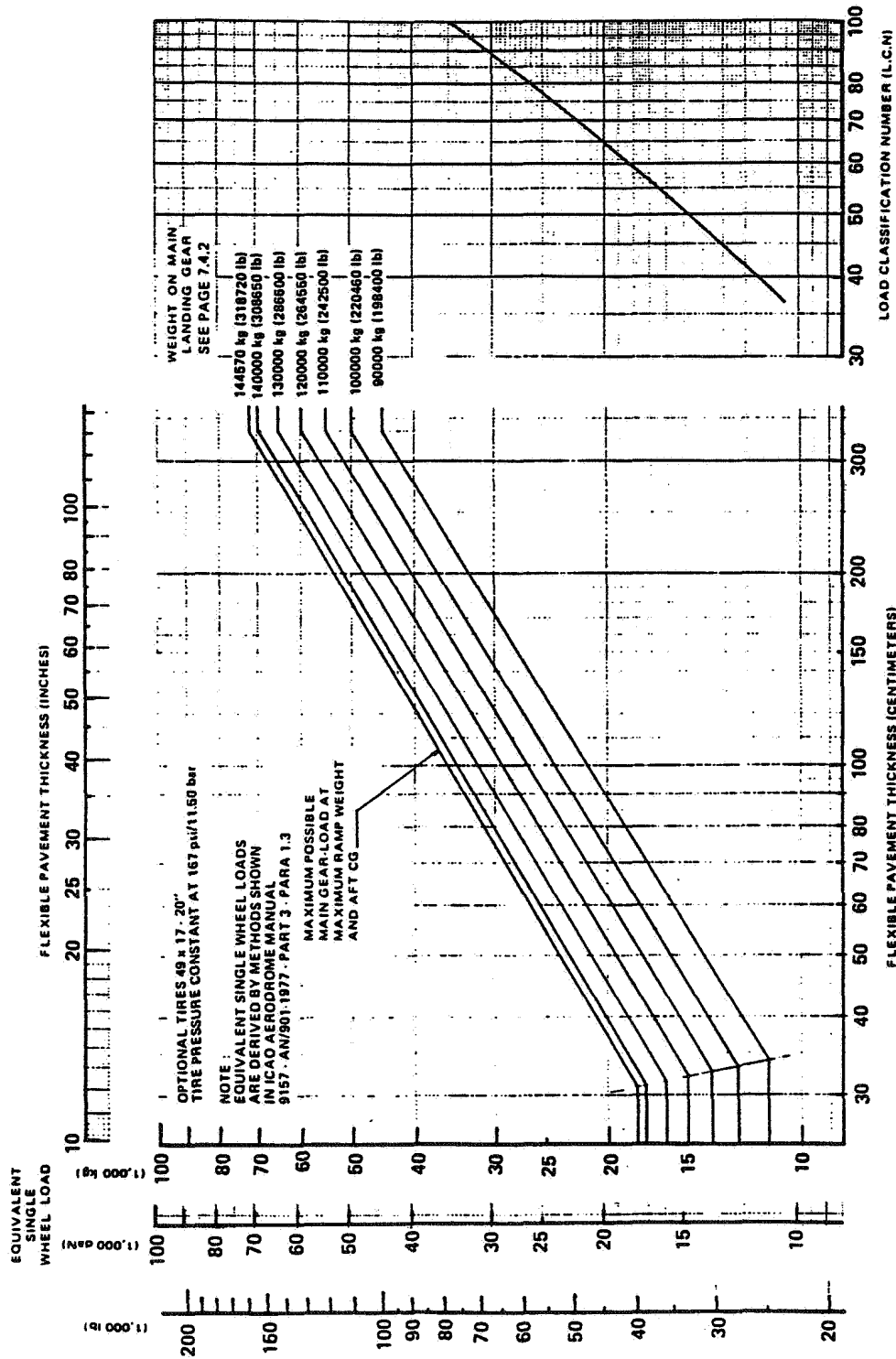

7.6.3.4 FLEXIBLE PAVEMENT REQUIREMENTS L.C.N. CONVERSION
 MODEL B4 - 153t OPTIONAL TIRES

AIRBUS  INDUSTRIE
A 300
 AIRPLANE CHARACTERISTICS

Printed in France

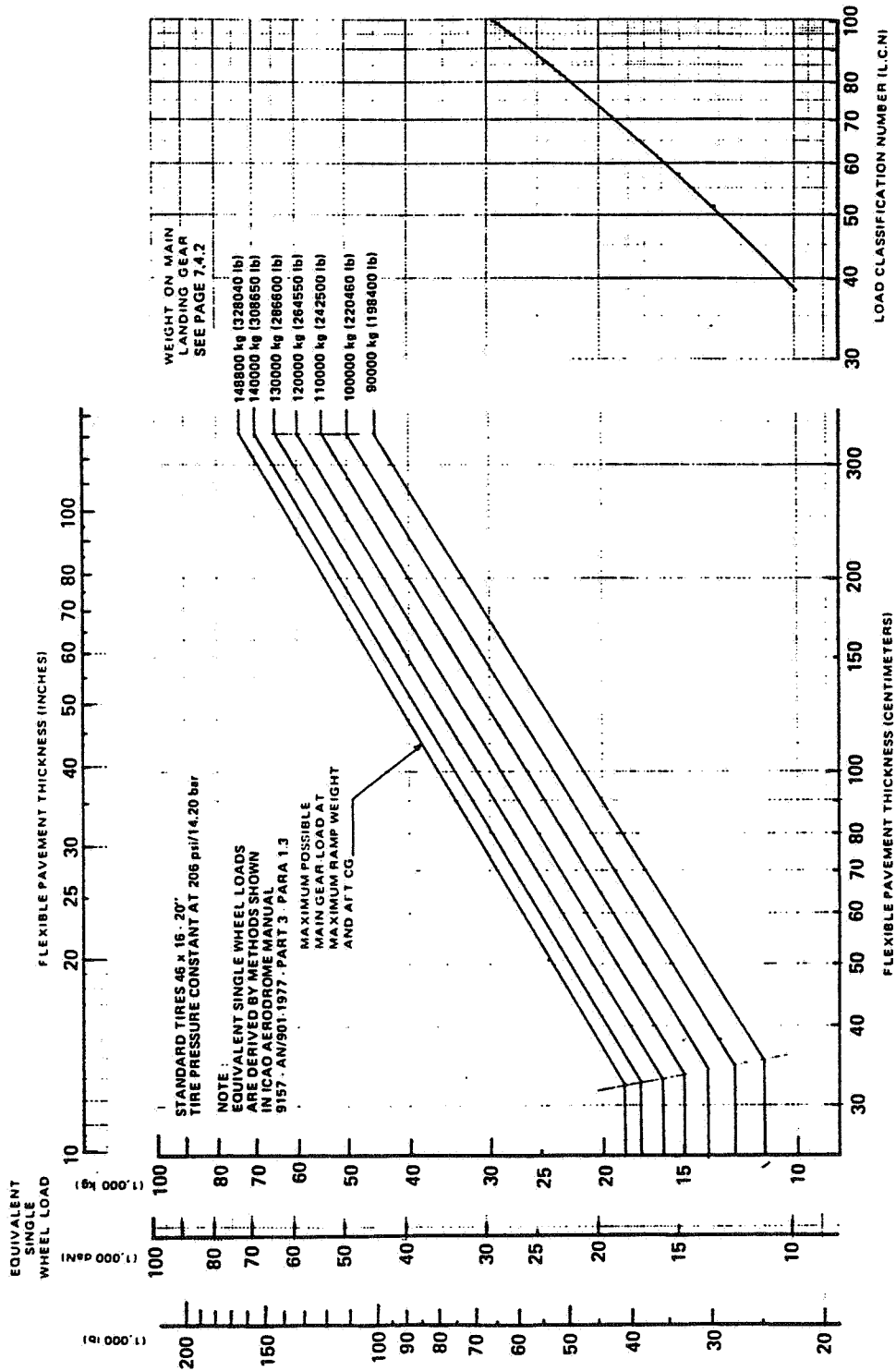

7.6.3.5 FLEXIBLE PAVEMENT REQUIREMENTS L.C.N. CONVERSION
 MODEL B4 - STANDARD TIRES

AIRBUS  INDUSTRIE
A 300
 AIRPLANE CHARACTERISTICS

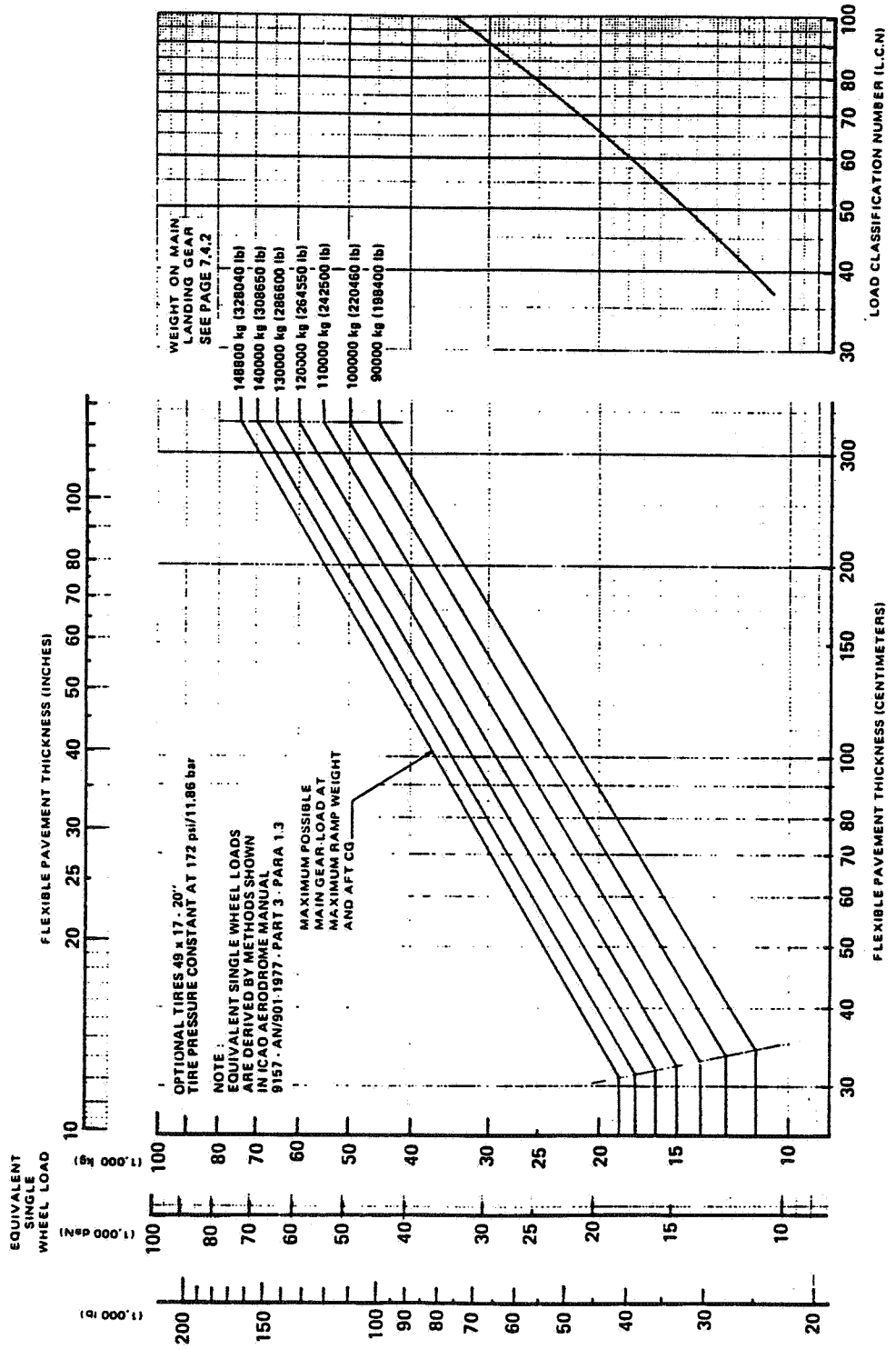

7.6.3.6 FLEXIBLE PAVEMENT REQUIREMENTS L.C.N. CONVERSION MODEL B4 - OPTIONAL TIRES

A 300

AIRPLANE CHARACTERISTICS

Printed in France

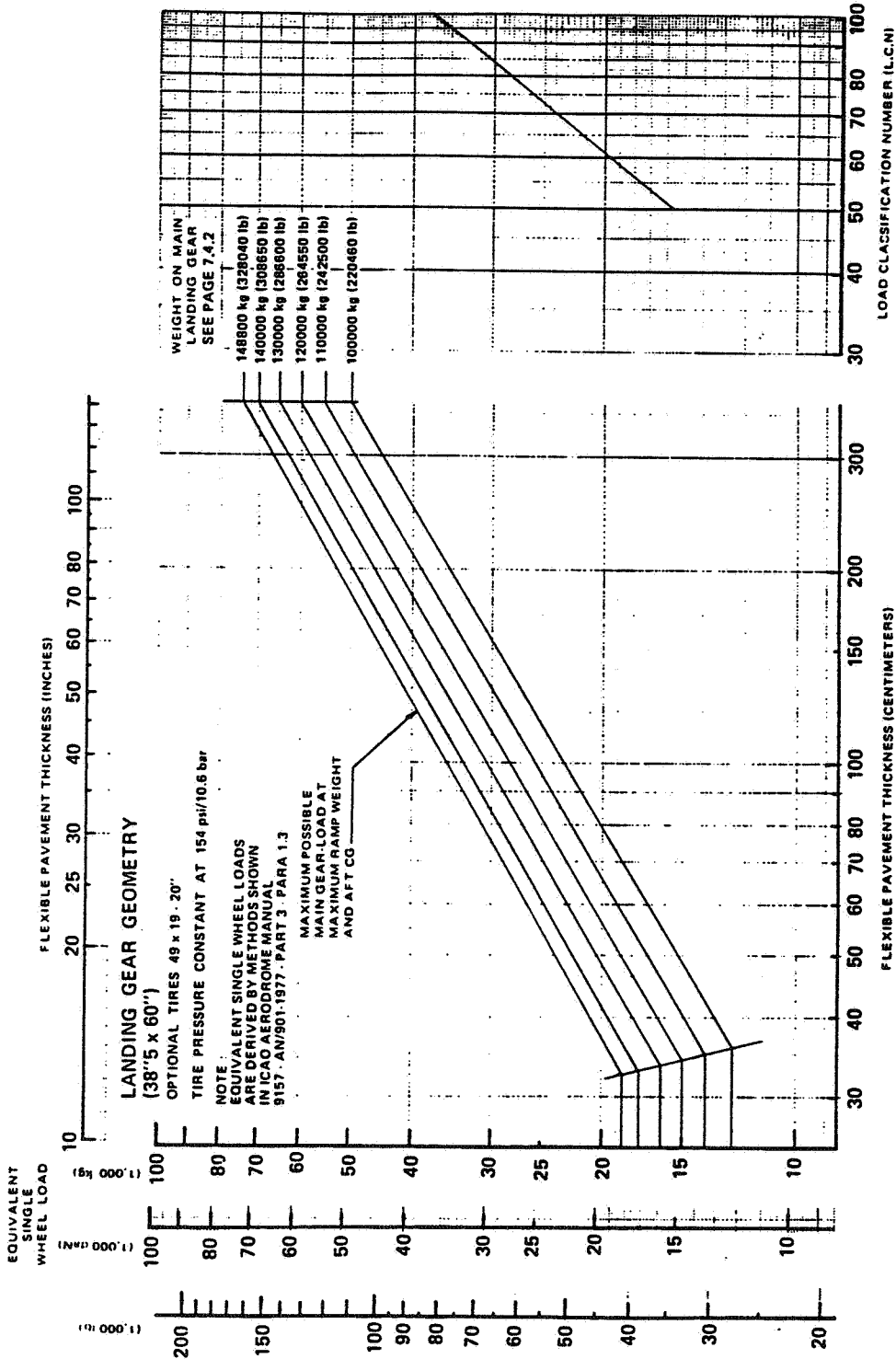

7.6.3.7 FLEXIBLE PAVEMENT REQUIREMENTS L.C.N. CONVERSION MODEL B4 - OPTIONAL TIRES

AIRBUS  INDUSTRIE
A 300
 AIRPLANE CHARACTERISTICS

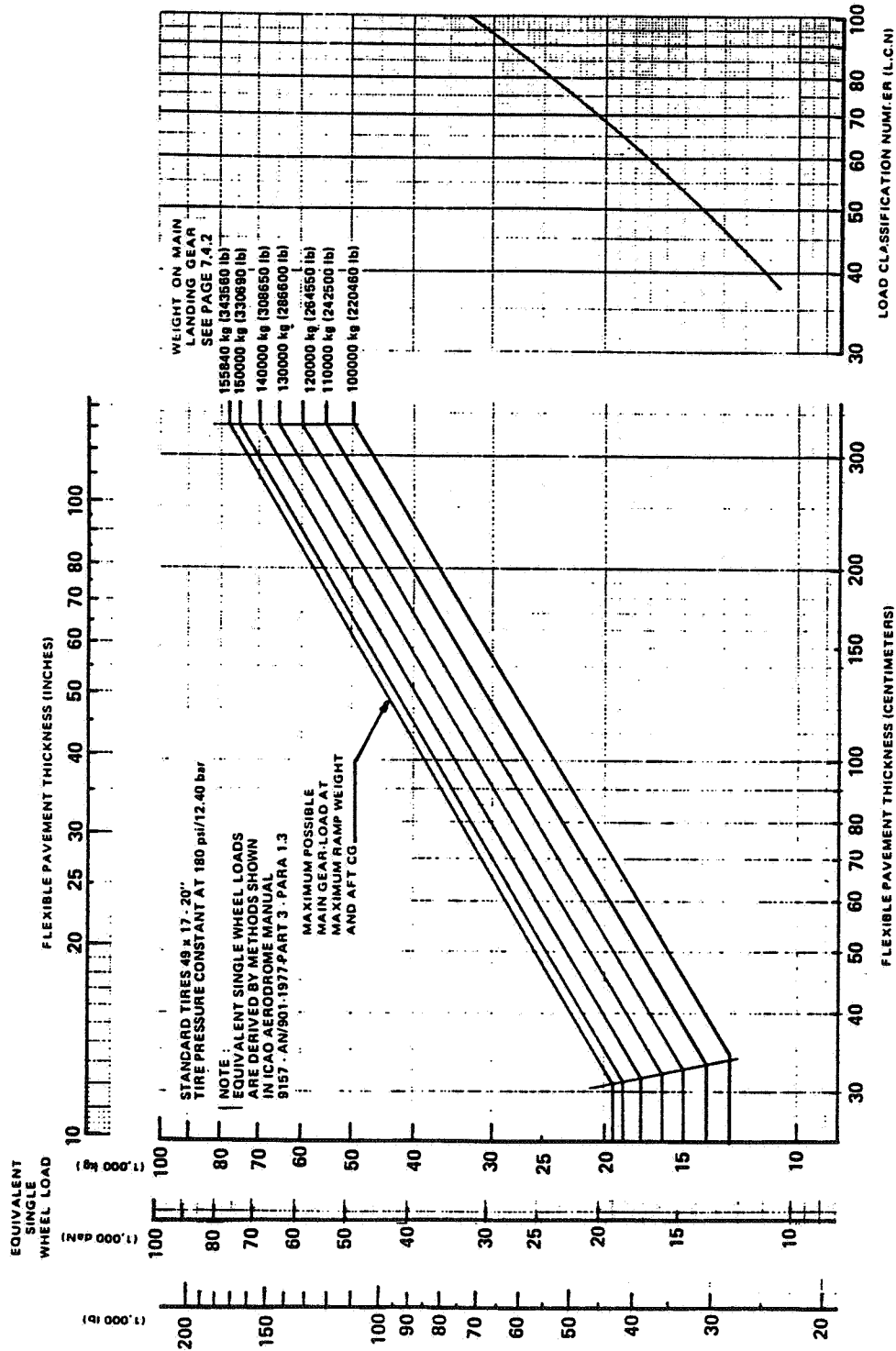

7.6.3.8 FLEXIBLE PAVEMENT REQUIREMENTS L.C.N. CONVERSION
 MODEL B4-C4 - 165t STANDARD TIRES

Printed in France

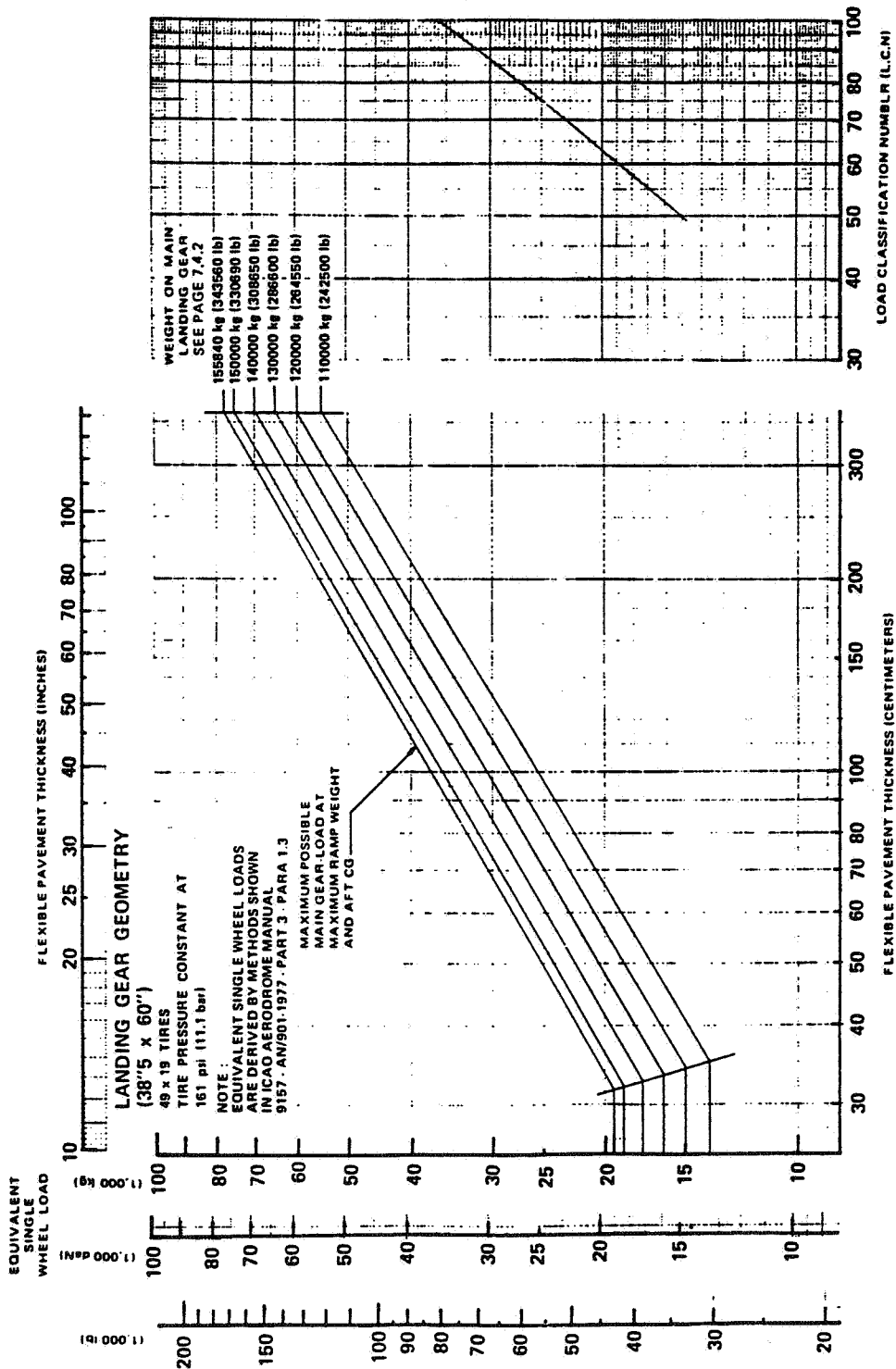

7.6.3.9 FLEXIBLE PAVEMENT REQUIREMENTS L.C.N. CONVERSION
MODEL B4-C4 - 165t OPTIONAL TIRES

AIRBUS  INDUSTRIE
A 300
AIRPLANE CHARACTERISTICS

Printed in France

THIS PAGE LEFT BLANK INTENTIONALLY

A 300

AIRPLANE CHARACTERISTICS

7.7 Rigid Pavement Requirements - Portland Cement Association Design Method

Rigid pavement requirements, presented herein, are based upon two Portland Cement Association practices :

- The former, standard manual method of counting unit moment blocks of the Pickett and Ray influence charts (Reference : Portland Cement Association publication "The Design of Concrete Airport Pavement, 1955).
- The new computerized version of the above as described in "Computer Program for Airport Pavement Design" by Robert G. Packard, Portland Cement Association, 1967, and "Operating Instructions for Computer Program BDILB". 1968.

Higher stresses for equivalent pavement thicknesses are obtained by the computerized method. These occur because of the following :

- INCREASED RADIUS OF INFLUENCE

The effect of influence from adjacent wheels by the manual method was limited to approximately 2 (the radius of relative stiffness). The computer utilizes the Westergaard equation directly and includes influence from all wheels within a radius of 3.

- MAXIMIZING PROCESS

It has been a common practice when using the manual count method to align the landing gear footprint on the major axis of the influence chart with one wheel centered over the origin. While this practice does not necessarily produce the maximum possible moment, the values obtained have been considered practical because the procedure eliminates arduous repetitive manual summations of moment blocks.

The computer determines the actual maximum stress values by a combination of shifting the footprint in relationship to the origin and by angular rotation of the footprint.

- DIFFERENCE IN FOOTPRINT SHAPE

An elliptical contact area is used in the computerized version to represent a single-wheel footprint instead of a rectangle with rounded ends. The variance in moment attributed to this change is minor.

Actual pavement stress for any given model or airplane has not increased. The state of the art in calculation of pavement stress has advanced to permit prediction of stress values to a higher degree of certainty. This permits a proportionate decrease in design stress safety factor.

A 300
AIRPLANE CHARACTERISTICS

Printed in France

THIS PAGE LEFT BLANK INTENTIONALLY

A 300

AIRPLANE CHARACTERISTICS

NOTE : THE VALUES OBTAINED BY USING THE MAXIMUM-LOAD REFERENCE LINE AND ANY VALUE OF k ARE EXACT, FOR LOADS LESS THAN MAXIMUM, THE CURVES ARE EXACT FOR $k = 300$ BUT DEVIATE SLIGHTLY FOR OTHER VALUES OF k .

REFERENCE : "DESIGN OF CONCRETE AIRCRAFT PAVEMENT AND COMPUTER PROGRAM FOR AIRPORT PAVEMENT DESIGN" (PROGRAM PDILB). PORTLAND CEMENT ASSN.

ALLOWABLE WORKING STRESS

PAVEMENT THICKNESS

STANDARD TIRES 46 x 16 - 20"
TIRE PRESSURE CONSTANT AT
168 psi (11.6 bars)

WEIGHT ON MAIN LANDING GEAR
SEE PAGE 7.4.1

Printed in France

A A 5 07 07 01 0 AA 0

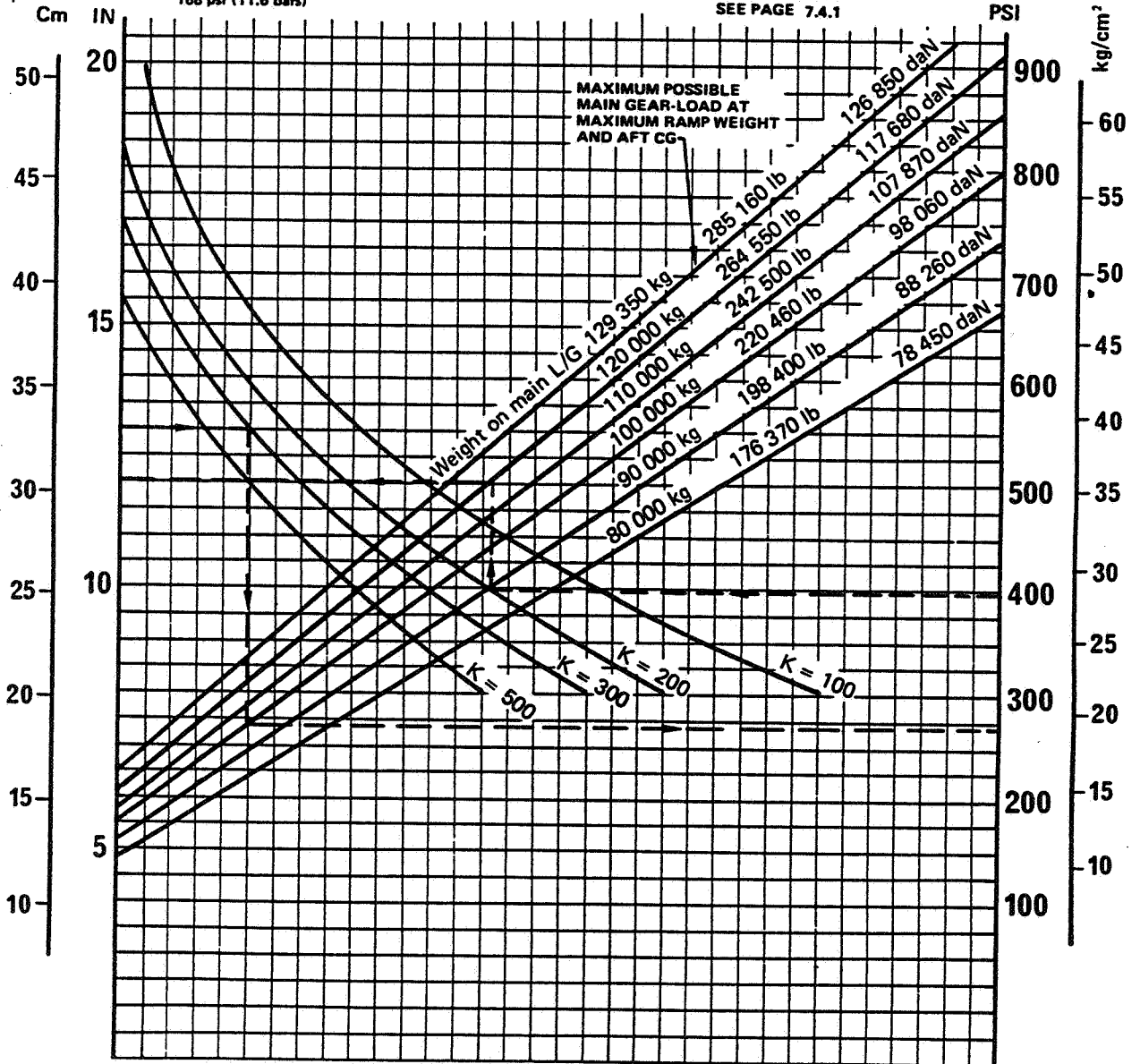

7.7.1.1 RIGID PAVEMENT REQUIREMENTS
PORTLAND CEMENT ASSOCIATION DESIGN METHOD
MODEL B2 - 137t STANDARD TIRES

A 300

AIRPLANE CHARACTERISTICS

NOTE : THE VALUES OBTAINED BY USING THE MAXIMUM-LOAD REFERENCE LINE AND ANY VALUE OF k ARE EXACT, FOR LOADS LESS THAN MAXIMUM, THE CURVES ARE EXACT FOR $k = 300$ BUT DEVIATE SLIGHTLY FOR OTHER VALUES OF k .

REFERENCE : "DESIGN OF CONCRETE AIRCRAFT PAVEMENT AND COMPUTER PROGRAM FOR AIRPORT PAVEMENT DESIGN" (PROGRAM PDILB). PORTLAND CEMENT ASSN.

ALLOWABLE WORKING STRESS

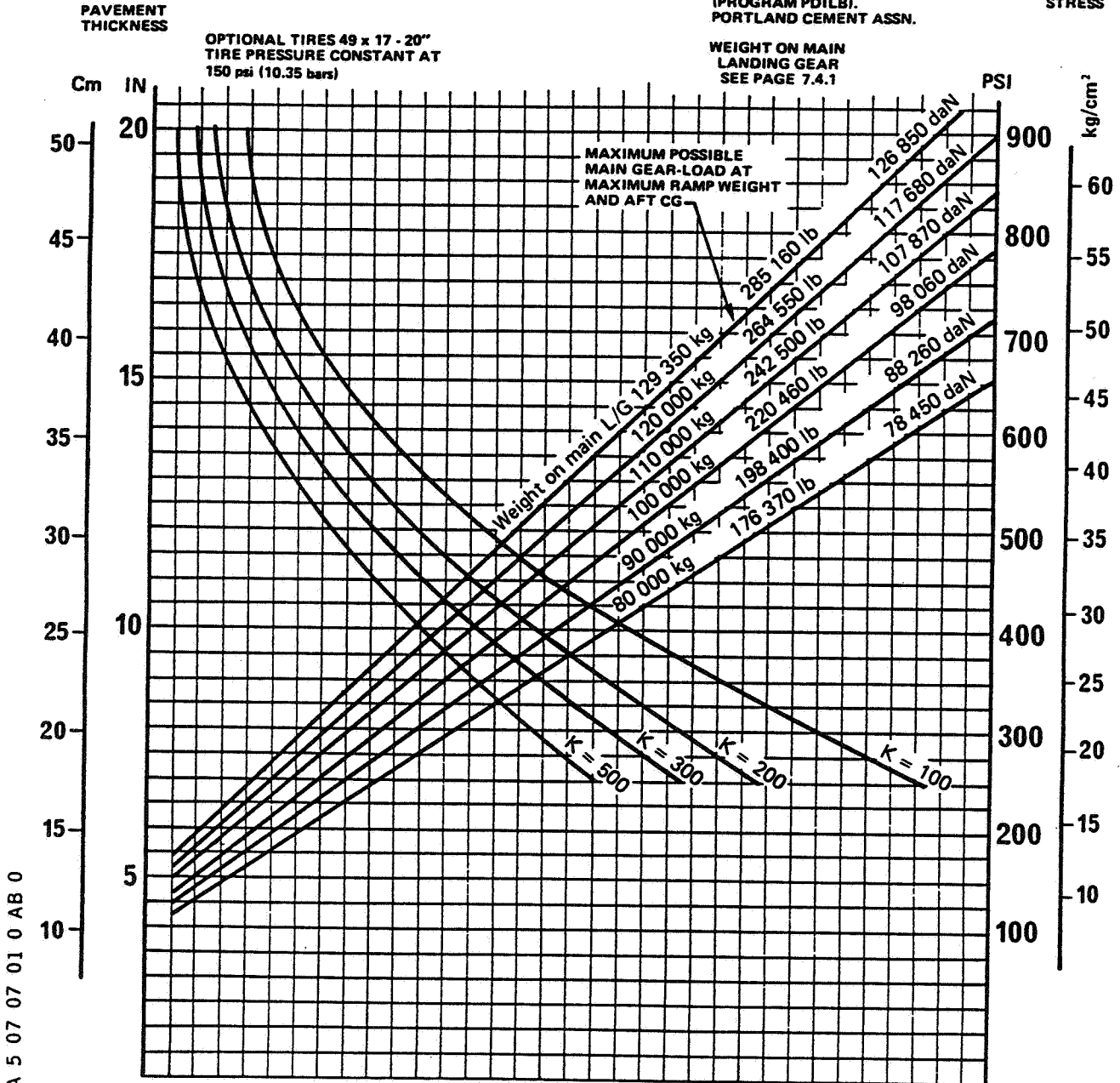

Printed in France

A A 5 07 07 01 0 A B 0

7.7.1.2 RIGID PAVEMENT REQUIREMENTS PORTLAND CEMENT ASSOCIATION DESIGN METHOD MODEL B2 - 137t OPTIONAL TIRES

A 300

AIRPLANE CHARACTERISTICS

NOTE : THE VALUES OBTAINED BY USING THE MAXIMUM-LOAD REFERENCE LINE AND ANY VALUE OF k ARE EXACT, FOR LOADS LESS THAN MAXIMUM, THE CURVES ARE EXACT FOR $k = 300$ BUT DEVIATE SLIGHTLY FOR OTHER VALUES OF k .

REFERENCE : "DESIGN OF CONCRETE AIRCRAFT PAVEMENT AND COMPUTER PROGRAM FOR AIRPORT PAVEMENT DESIGN" (PROGRAM PDILB). PORTLAND CEMENT ASSN.

ALLOWABLE WORKING STRESS

PAVEMENT THICKNESS

STANDARD TIRES 46 x 16 - 20"
TIRE PRESSURE CONSTANT AT
180 psi (12.4 bars)

WEIGHT ON MAIN LANDING GEAR
SEE PAGE 7.4.1

Printed in France

A A 5 07 07 01 0 AC 0

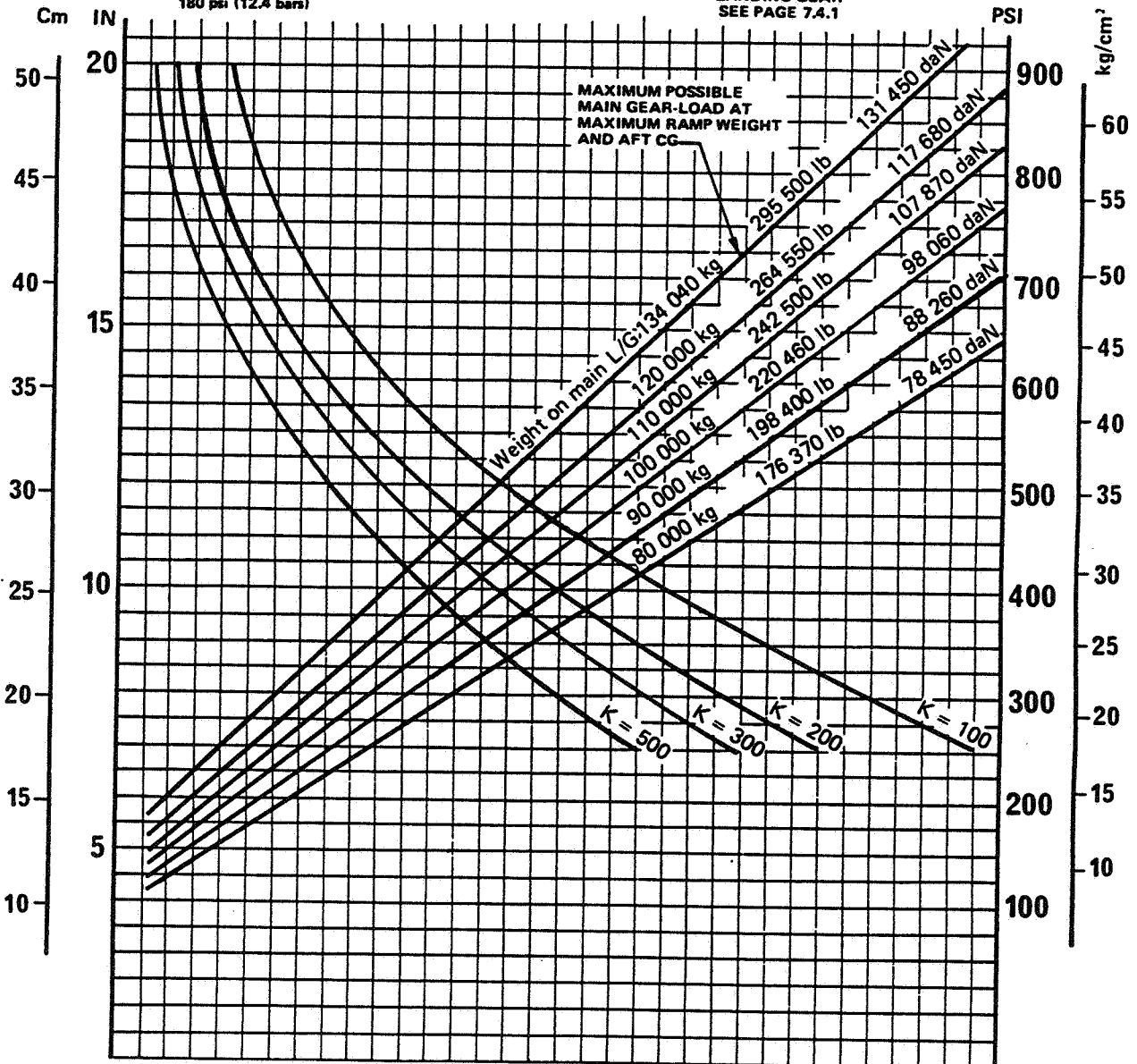

7.7.1.3 RIGID PAVEMENT REQUIREMENTS
PORTLAND CEMENT ASSOCIATION DESIGN METHOD
MODEL B2 - 142t STANDARD TIRES

A 300

AIRPLANE CHARACTERISTICS

NOTE : THE VALUES OBTAINED BY USING THE MAXIMUM-LOAD REFERENCE LINE AND ANY VALUE OF k ARE EXACT, FOR LOADS LESS THAN MAXIMUM, THE CURVES ARE EXACT FOR $k = 300$ BUT DEVIATE SLIGHTLY FOR OTHER VALUES OF k .

REFERENCE : "DESIGN OF CONCRETE AIRCRAFT PAVEMENT AND COMPUTER PROGRAM FOR AIRPORT PAVEMENT DESIGN" (PROGRAM PDILB). PORTLAND CEMENT ASSN.

ALLOWABLE WORKING STRESS

PAVEMENT THICKNESS

OPTIONAL TIRES 49 x 17 - 20"
TIRE PRESSURE CONSTANT AT
155 psi (10.7 bars)

WEIGHT ON MAIN LANDING GEAR
SEE PAGE 7.4.1

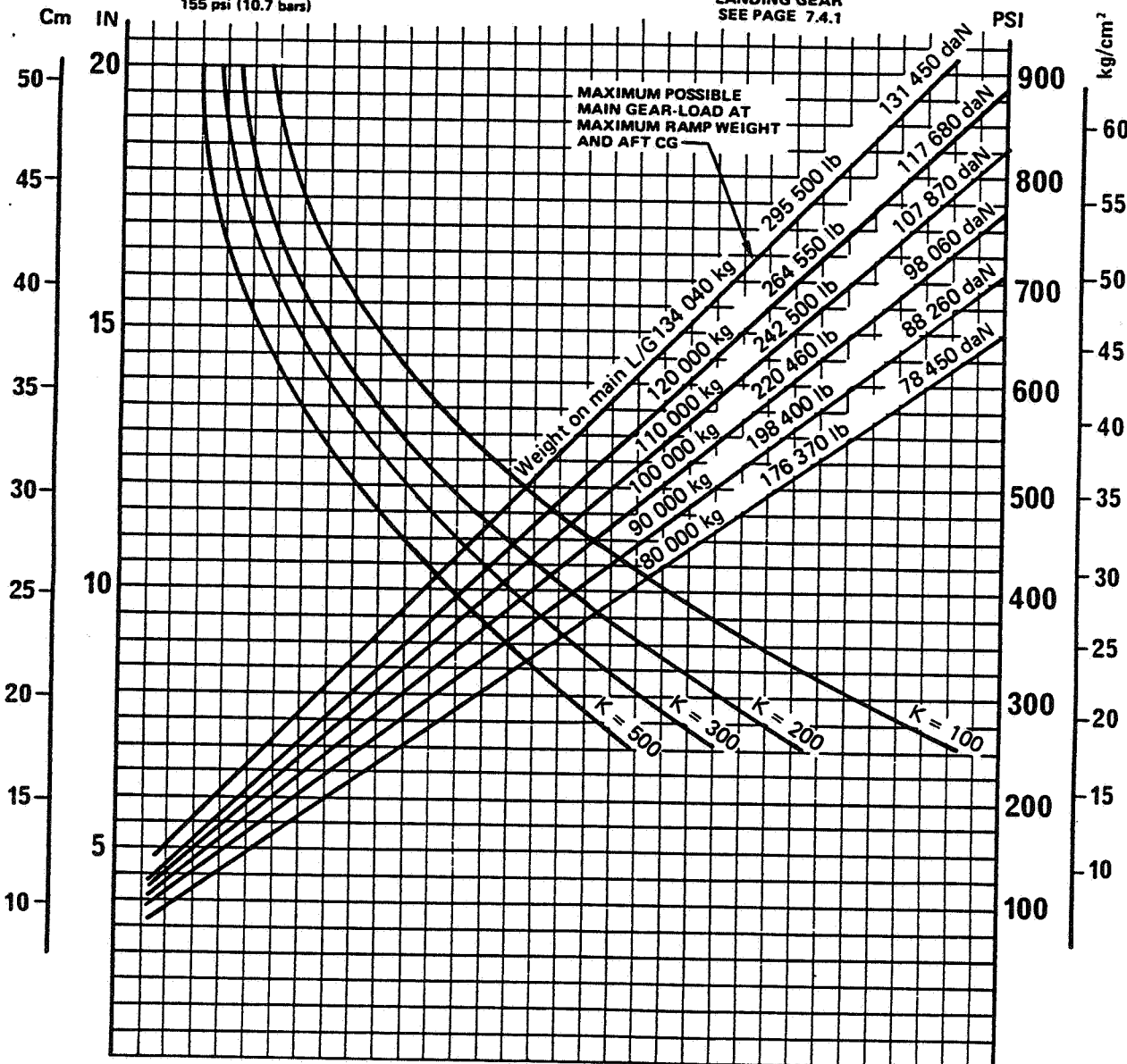

A A 5 07 07 01 0 A D 0

Printed in France

7.7.1.4 RIGID PAVEMENT REQUIREMENTS PORTLAND CEMENT ASSOCIATION DESIGN METHOD MODEL B2 - 142t OPTIONAL TIRES

AIRBUS  INDUSTRIE

A 300
AIRPLANE CHARACTERISTICS

Printed in France

THIS PAGE LEFT BLANK INTENTIONALLY

A 300

AIRPLANE CHARACTERISTICS

NOTE : THE VALUES OBTAINED BY USING THE MAXIMUM-LOAD REFERENCE LINE AND ANY VALUE OF k ARE EXACT, FOR LOADS LESS THAN MAXIMUM, THE CURVES ARE EXACT FOR $k = 300$ BUT DEVIATE SLIGHTLY FOR OTHER VALUES OF k .

REFERENCE : "DESIGN OF CONCRETE AIRCRAFT PAVEMENT AND COMPUTER PROGRAM FOR AIRPORT PAVEMENT DESIGN" (PROGRAM PDILB). PORTLAND CEMENT ASSN.

ALLOWABLE WORKING STRESS

PAVEMENT THICKNESS

STANDARD TIRES 46 x 16 - 20"
TIRE PRESSURE CONSTANT AT
180 psi (12.4 bars)

WEIGHT ON MAIN
LANDING GEAR
SEE PAGE 7.4.1

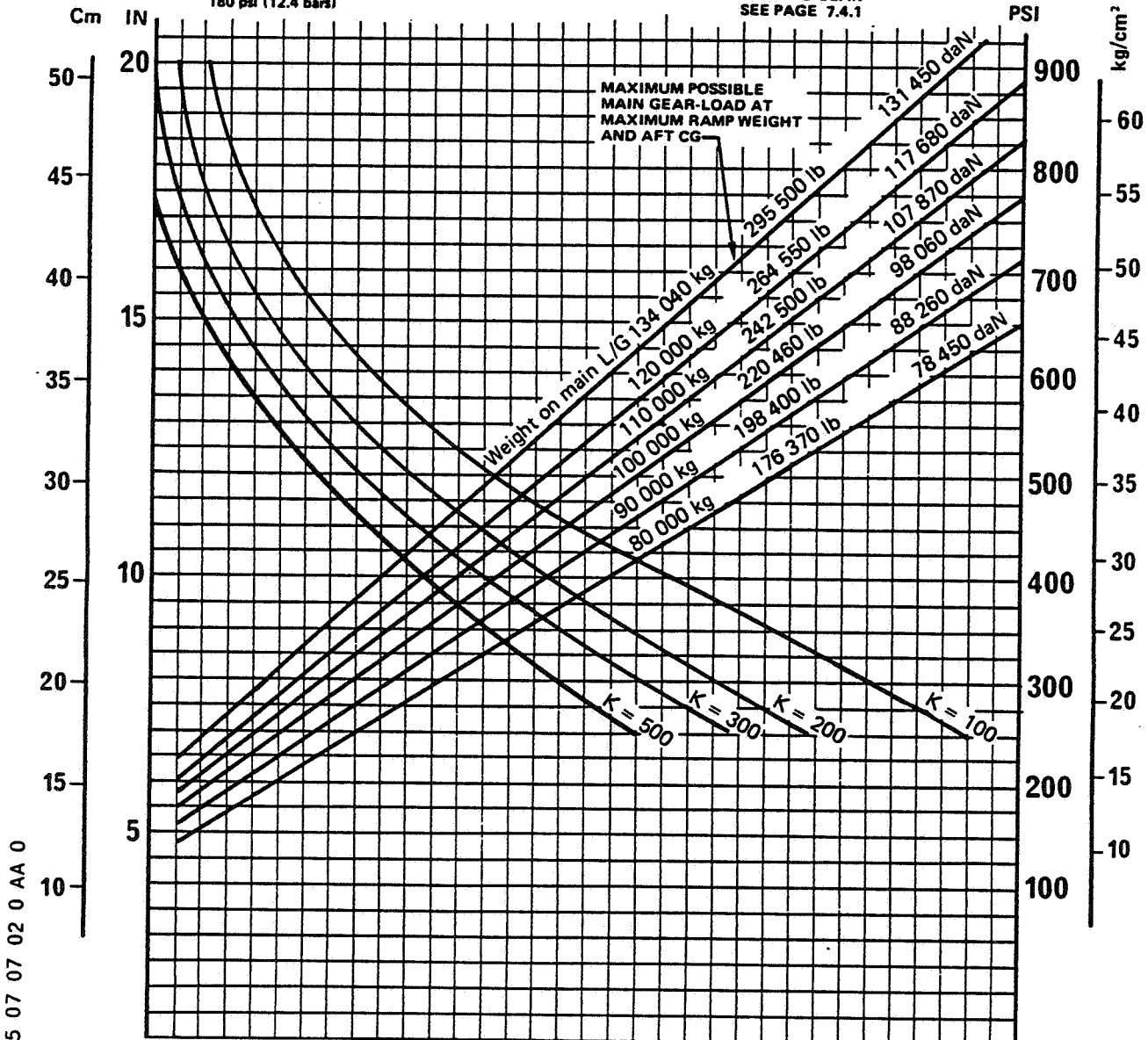

A A 5 07 07 02 0 AA 0

Printed in France

7.7.2.1 RIGID PAVEMENT REQUIREMENTS PORTLAND CEMENT ASSOCIATION DESIGN METHOD MODEL B2K - 142t STANDARD TIRES

A 300

AIRPLANE CHARACTERISTICS

NOTE : THE VALUES OBTAINED BY USING THE MAXIMUM-LOAD REFERENCE LINE AND ANY VALUE OF k ARE EXACT, FOR LOADS LESS THAN MAXIMUM, THE CURVES ARE EXACT FOR $k = 300$ BUT DEVIATE SLIGHTLY FOR OTHER VALUES OF k .

REFERENCE : "DESIGN OF CONCRETE AIRCRAFT PAVEMENT AND COMPUTER PROGRAM FOR AIRPORT PAVEMENT DESIGN" (PROGRAM PDILB). PORTLAND CEMENT ASSN.

ALLOWABLE WORKING STRESS

PAVEMENT THICKNESS

OPTIONAL TIRES 49 x 17 - 20"
TIRE PRESSURE CONSTANT AT
155 psi (10.7 bars)

WEIGHT ON MAIN LANDING GEAR
SEE PAGE 7.4.1

Printed in France

A A 5 07 07 02 0 A B 0

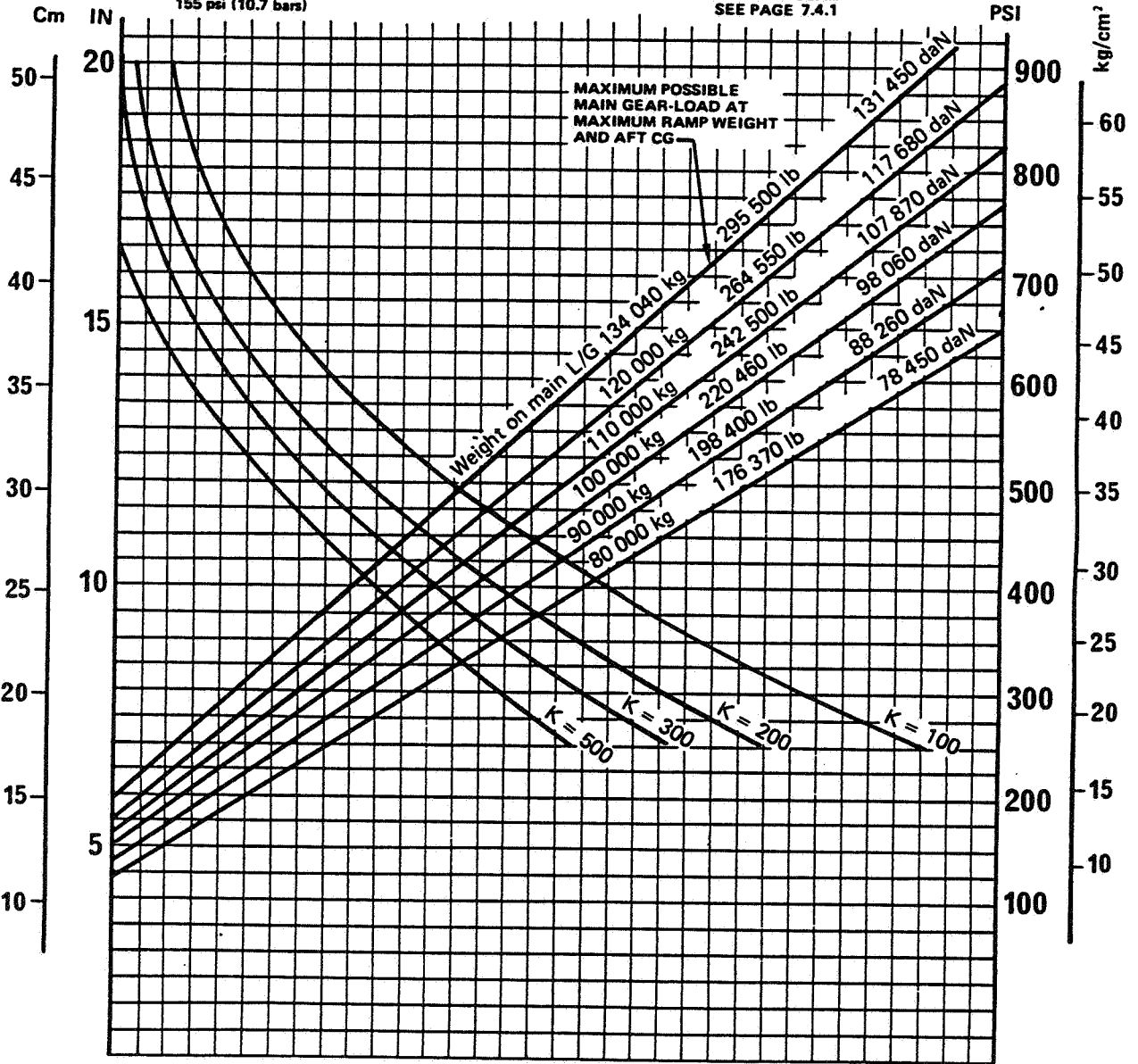

7.7.2.2 RIGID PAVEMENT REQUIREMENTS PORTLAND CEMENT ASSOCIATION DESIGN METHOD MODEL B2K - 142t OPTIONAL TIRES

AIRBUS  INDUSTRIE
A 300
AIRPLANE CHARACTERISTICS

Printed in France

THIS PAGE LEFT BLANK INTENTIONALLY

A 300

AIRPLANE CHARACTERISTICS

NOTE : THE VALUES OBTAINED BY USING THE MAXIMUM-LOAD REFERENCE LINE AND ANY VALUE OF k ARE EXACT, FOR LOADS LESS THAN MAXIMUM, THE CURVES ARE EXACT FOR $k = 300$ BUT DEVIATE SLIGHTLY FOR OTHER VALUES OF k .

REFERENCE : "DESIGN OF CONCRETE AIRCRAFT PAVEMENT AND COMPUTER PROGRAM FOR AIRPORT PAVEMENT DESIGN" (PROGRAM PDILB). PORTLAND CEMENT ASSN.

ALLOWABLE WORKING STRESS

PAVEMENT THICKNESS

STANDARD TIRES 46 x 16 - 20"
TIRE PRESSURE CONSTANT AT
194 psi (13.4 bars)

WEIGHT ON MAIN LANDING GEAR
SEE PAGE 7.4.2

Printed in France

A A 5 07 07 03 0 AA 0

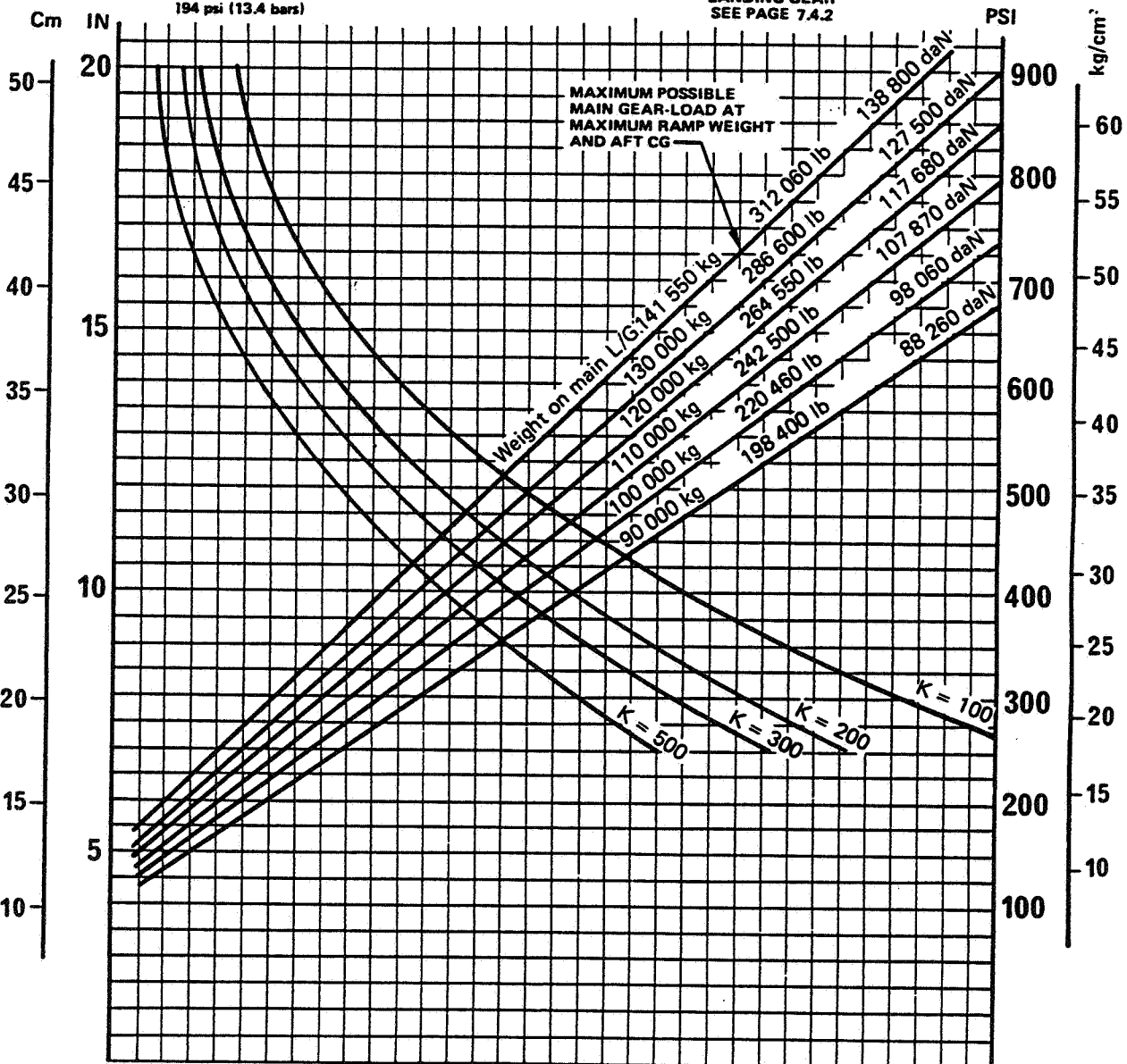

7.7.3.1 RIGID PAVEMENT REQUIREMENTS PORTLAND CEMENT ASSOCIATION DESIGN METHOD MODEL B4 - 150t STANDARD TIRES

A 300

AIRPLANE CHARACTERISTICS

NOTE : THE VALUES OBTAINED BY USING THE MAXIMUM-LOAD REFERENCE LINE AND ANY VALUE OF k ARE EXACT, FOR LOADS LESS THAN MAXIMUM, THE CURVES ARE EXACT FOR $k = 300$ BUT DEVIATE SLIGHTLY FOR OTHER VALUES OF k .

REFERENCE : "DESIGN OF CONCRETE AIRCRAFT PAVEMENT AND COMPUTER PROGRAM FOR AIRPORT PAVEMENT DESIGN" (PROGRAM PDILB). PORTLAND CEMENT ASSN.

ALLOWABLE WORKING STRESS

PAVEMENT THICKNESS

OPTIONAL TIRES 49 x 17 - 20"
TIRE PRESSURE CONSTANT AT
164 psi (11.3 bars)

WEIGHT ON MAIN LANDING GEAR
SEE PAGE 7.4.2

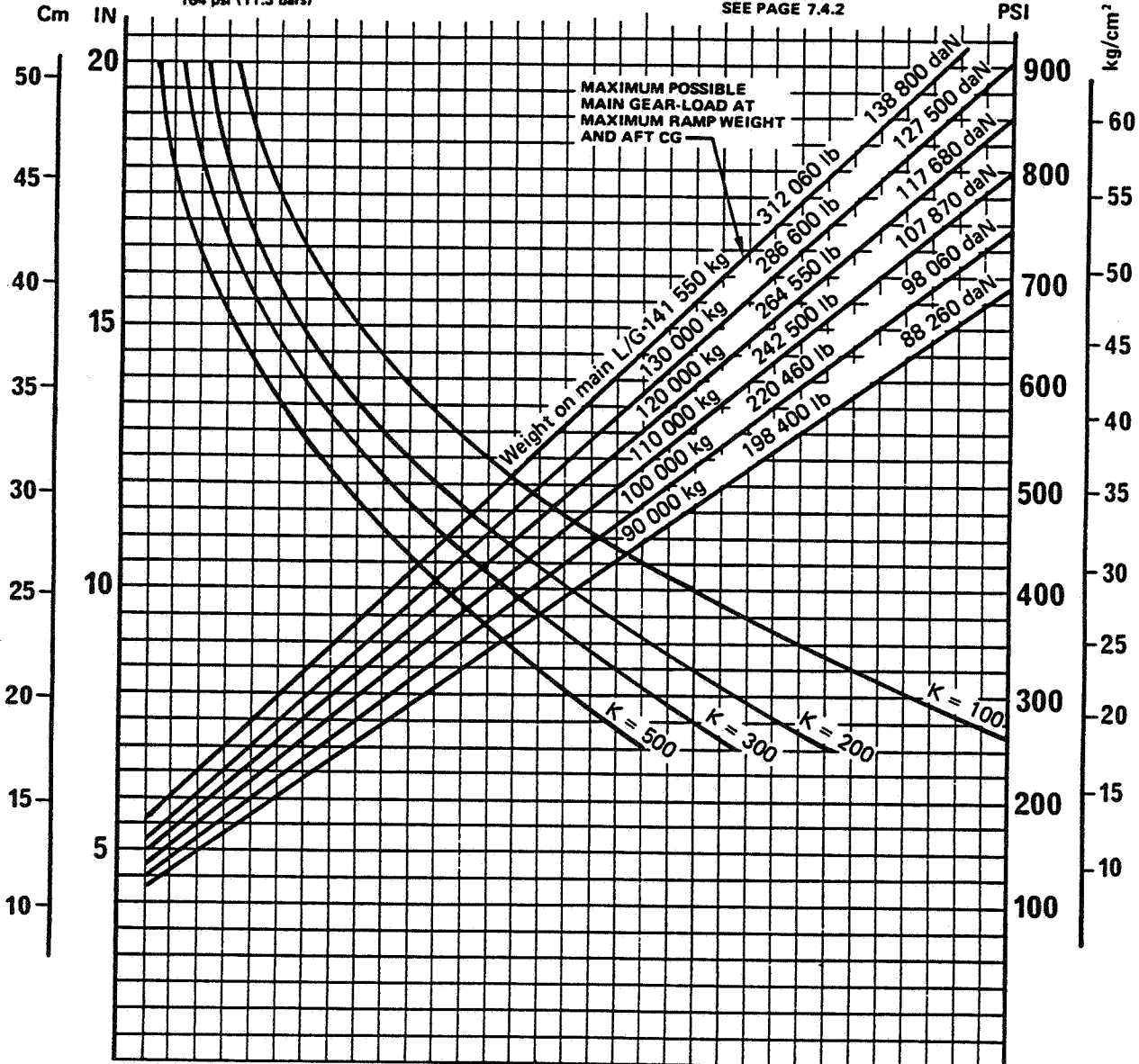

A A 5 07 07 03 0 A B 0

Printed in France

7.7.3.2 RIGID PAVEMENT REQUIREMENTS

PORTLAND CEMENT ASSOCIATION DESIGN METHOD

MODEL B4 - 150t OPTIONAL TIRES

A 300

AIRPLANE CHARACTERISTICS

NOTE : THE VALUES OBTAINED BY USING THE MAXIMUM-LOAD REFERENCE LINE AND ANY VALUE OF k ARE EXACT, FOR LOADS LESS THAN MAXIMUM, THE CURVES ARE EXACT FOR $k = 300$ BUT DEVIATE SLIGHTLY FOR OTHER VALUES OF k .

REFERENCE : "DESIGN OF CONCRETE AIRCRAFT PAVEMENT AND COMPUTER PROGRAM FOR AIRPORT PAVEMENT DESIGN" (PROGRAM PD1B). PORTLAND CEMENT ASSN.

ALLOWABLE WORKING STRESS

PAVEMENT THICKNESS

STANDARD TIRES 46 x 16 - 20"
TIRE PRESSURE CONSTANT AT
194 psi (13.4 bars)

WEIGHT ON MAIN LANDING GEAR
SEE PAGE 7.4.2

Printed in France

A A 5 07 07 03 0 AC 0

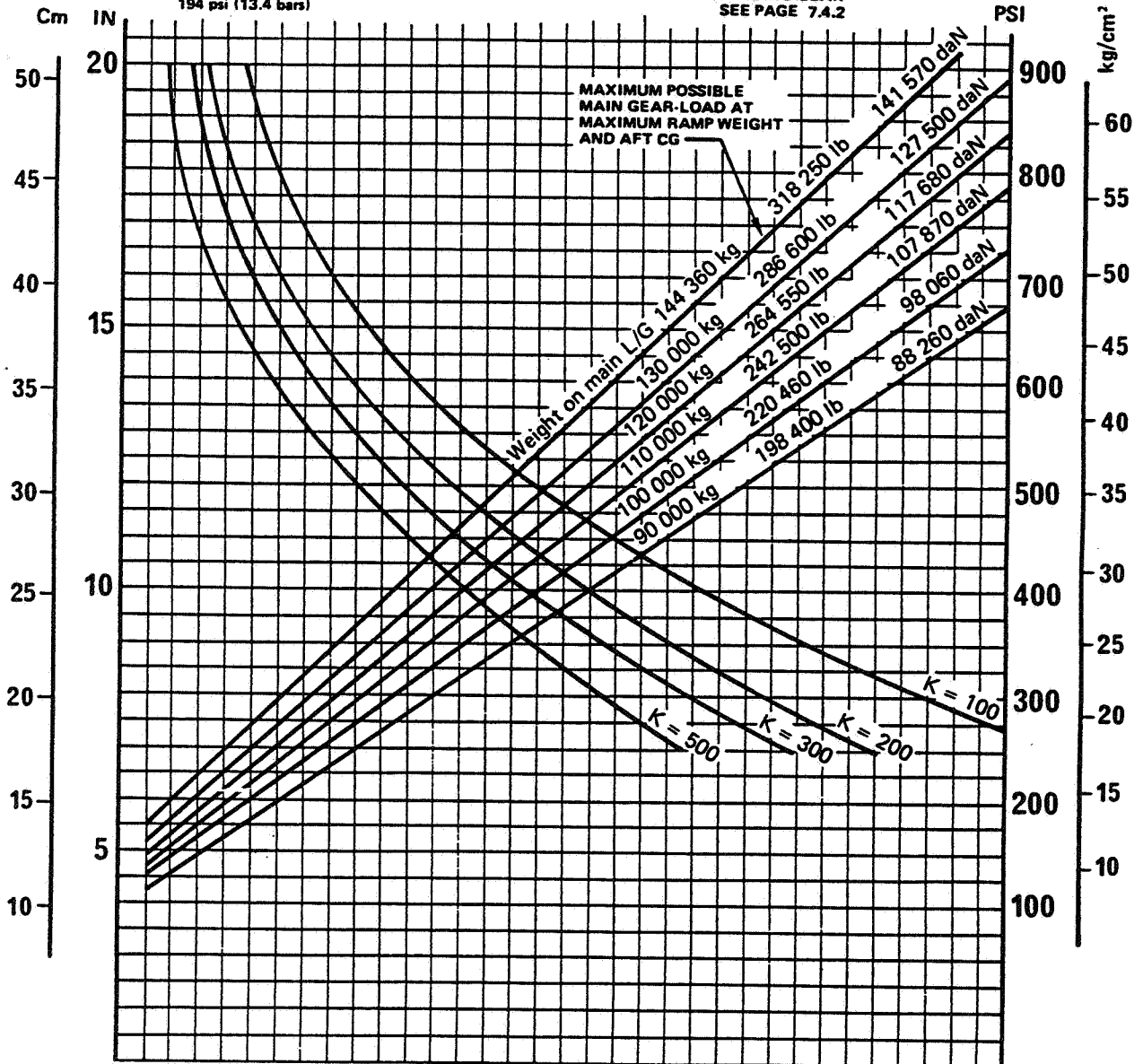

7.7.3.3 RIGID PAVEMENT REQUIREMENTS PORTLAND CEMENT ASSOCIATION DESIGN METHOD MODEL B4 - 153t STANDARD TIRES

A 300
AIRPLANE CHARACTERISTICS

NOTE : THE VALUES OBTAINED BY USING THE MAXIMUM-LOAD REFERENCE LINE AND ANY VALUE OF k ARE EXACT, FOR LOADS LESS THAN MAXIMUM, THE CURVES ARE EXACT FOR $k = 300$ BUT DEVIATE SLIGHTLY FOR OTHER VALUES OF k .

REFERENCE : "DESIGN OF CONCRETE AIRCRAFT PAVEMENT AND COMPUTER PROGRAM FOR AIRPORT PAVEMENT DESIGN" (PROGRAM PDILB), PORTLAND CEMENT ASSN.

ALLOWABLE WORKING STRESS

PAVEMENT THICKNESS

OPTIONAL TIRES 49 x 17 - 20"
TIRE PRESSURE CONSTANT AT
164 psi (11.3 bars)

WEIGHT ON MAIN LANDING GEAR
SEE PAGE 7.4.2

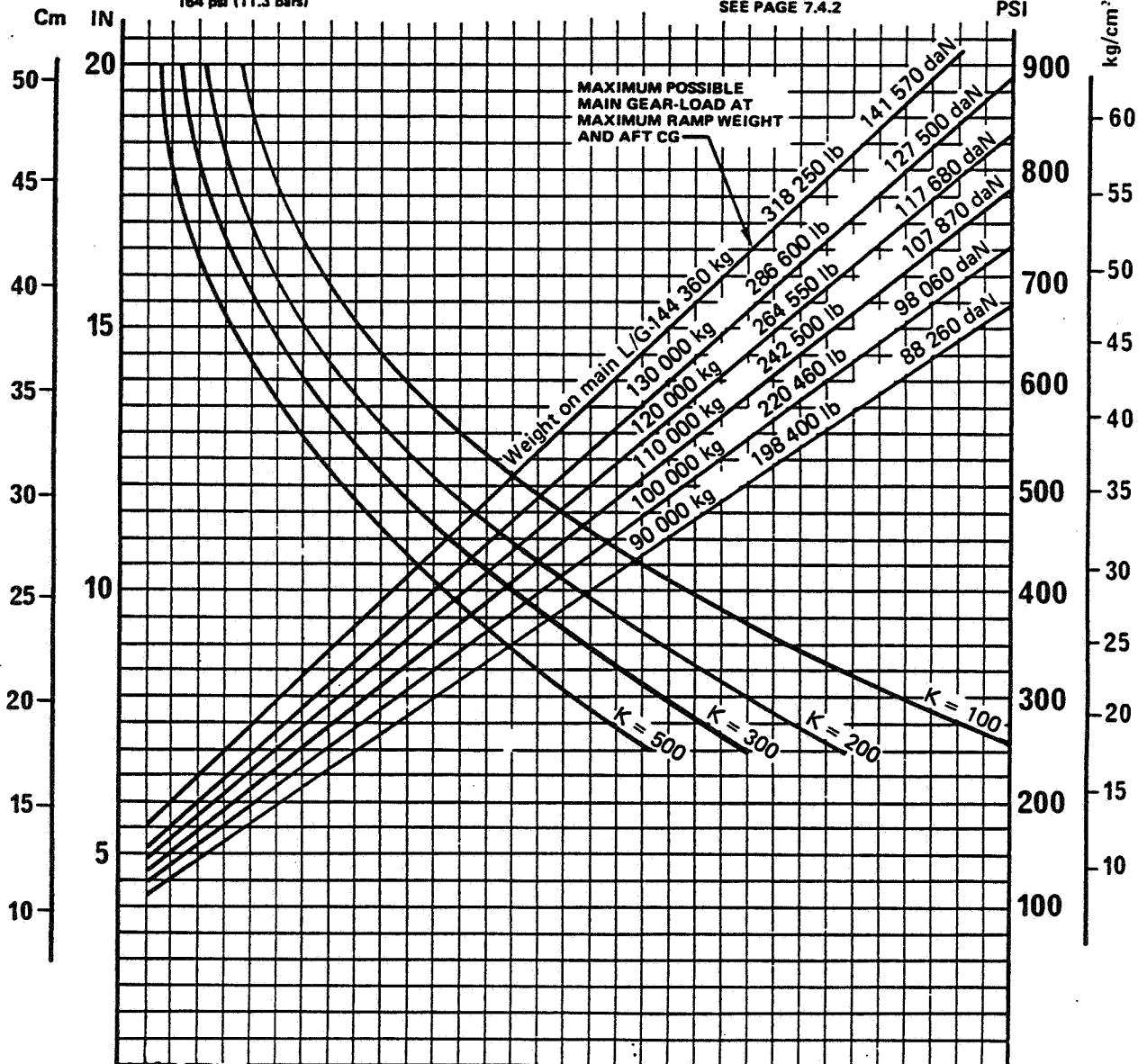

A A 5 07 07 03 0 AD 0

Printed in France

7.7.3.4 RIGID PAVEMENT REQUIREMENTS
PORTLAND CEMENT ASSOCIATION DESIGN METHOD
MODEL B4 - 153t OPTIONAL TIRES

A 300

AIRPLANE CHARACTERISTICS

NOTE : THE VALUES OBTAINED BY USING THE MAXIMUM-LOAD REFERENCE LINE AND ANY VALUE OF k ARE EXACT, FOR LOADS LESS THAN MAXIMUM, THE CURVES ARE EXACT FOR $k = 300$ BUT DEVIATE SLIGHTLY FOR OTHER VALUES OF k .

REFERENCE : "DESIGN OF CONCRETE AIRCRAFT PAVEMENT AND COMPUTER PROGRAM FOR AIRPORT PAVEMENT DESIGN" (PROGRAM PDILB). PORTLAND CEMENT ASSN.

ALLOWABLE WORKING STRESS

PAVEMENT THICKNESS

STANDARD TIRES 46 x 16 - 20"
TIRE PRESSURE CONSTANT AT
206 psi (14.2 bars)

WEIGHT ON MAIN LANDING GEAR:
SEE PAGE 7.4.2

Printed in France

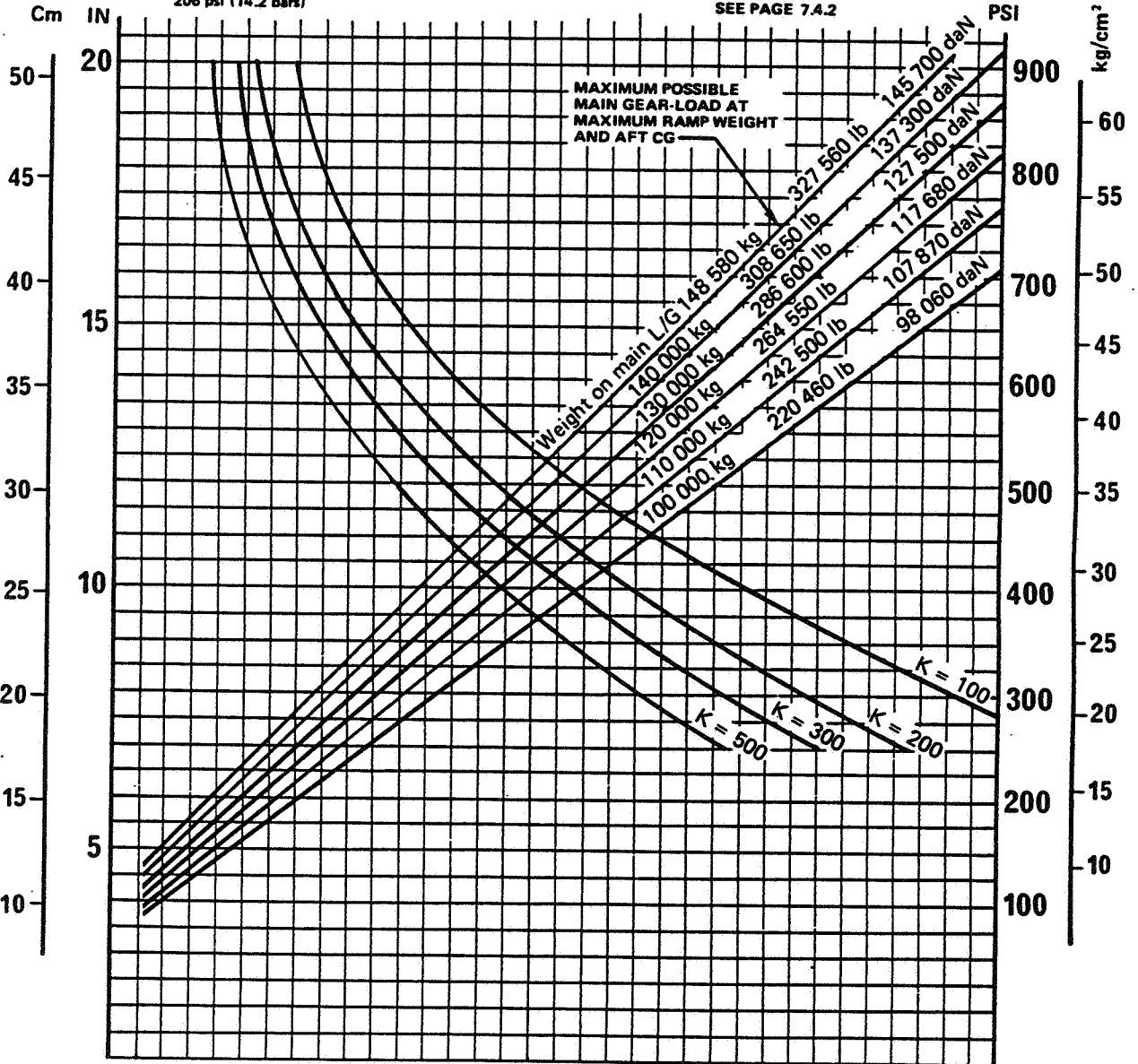

A A 5 07 07 03 0 AE 0

7.7.3.5 RIGID PAVEMENT REQUIREMENTS PORTLAND CEMENT ASSOCIATION DESIGN METHOD MODEL B4 - 157.5t STANDARD TIRES

A 300

AIRPLANE CHARACTERISTICS

NOTE : THE VALUES OBTAINED BY USING THE MAXIMUM-LOAD REFERENCE LINE AND ANY VALUE OF k ARE EXACT, FOR LOADS LESS THAN MAXIMUM, THE CURVES ARE EXACT FOR $k = 300$ BUT DEVIATE SLIGHTLY FOR OTHER VALUES OF k .

REFERENCE : "DESIGN OF CONCRETE AIRCRAFT PAVEMENT AND COMPUTER PROGRAM FOR AIRPORT PAVEMENT DESIGN" (PROGRAM PDILB). PORTLAND CEMENT ASSN.

ALLOWABLE WORKING STRESS

PAVEMENT THICKNESS

OPTIONAL TIRES 49 x 17 - 20"
TIRE PRESSURE CONSTANT AT
172 psi (11.85 bars)

WEIGHT ON MAIN LANDING GEAR
SEE PAGE 7.4.2

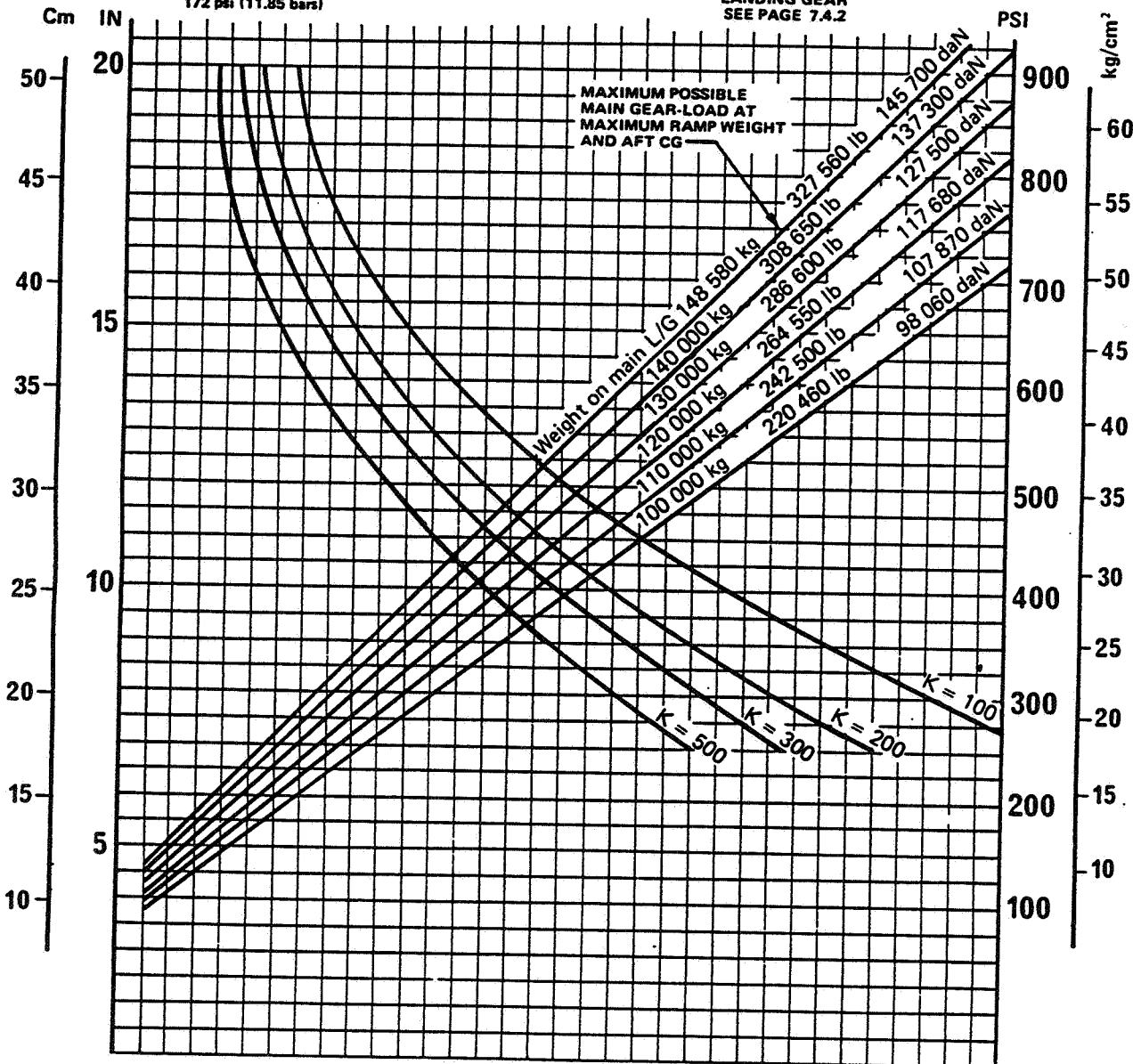

Printed in France

7.7.3.6 RIGID PAVEMENT REQUIREMENTS PORTLAND CEMENT ASSOCIATION DESIGN METHOD MODEL B4 - 157.5t OPTIONAL TIRES

A 300

AIRPLANE CHARACTERISTICS

NOTE : THE VALUES OBTAINED BY USING THE MAXIMUM-LOAD REFERENCE LINE AND ANY VALUE OF k ARE EXACT, FOR LOADS LESS THAN MAXIMUM, THE CURVES ARE EXACT FOR k = 300 BUT DEVIATE SLIGHTLY FOR OTHER VALUES OF k.

REFERENCE : "DESIGN OF CONCRETE AIRCRAFT PAVEMENT AND COMPUTER PROGRAM FOR AIRPORT PAVEMENT DESIGN" (PROGRAM POILB). PORTLAND CEMENT ASSN.

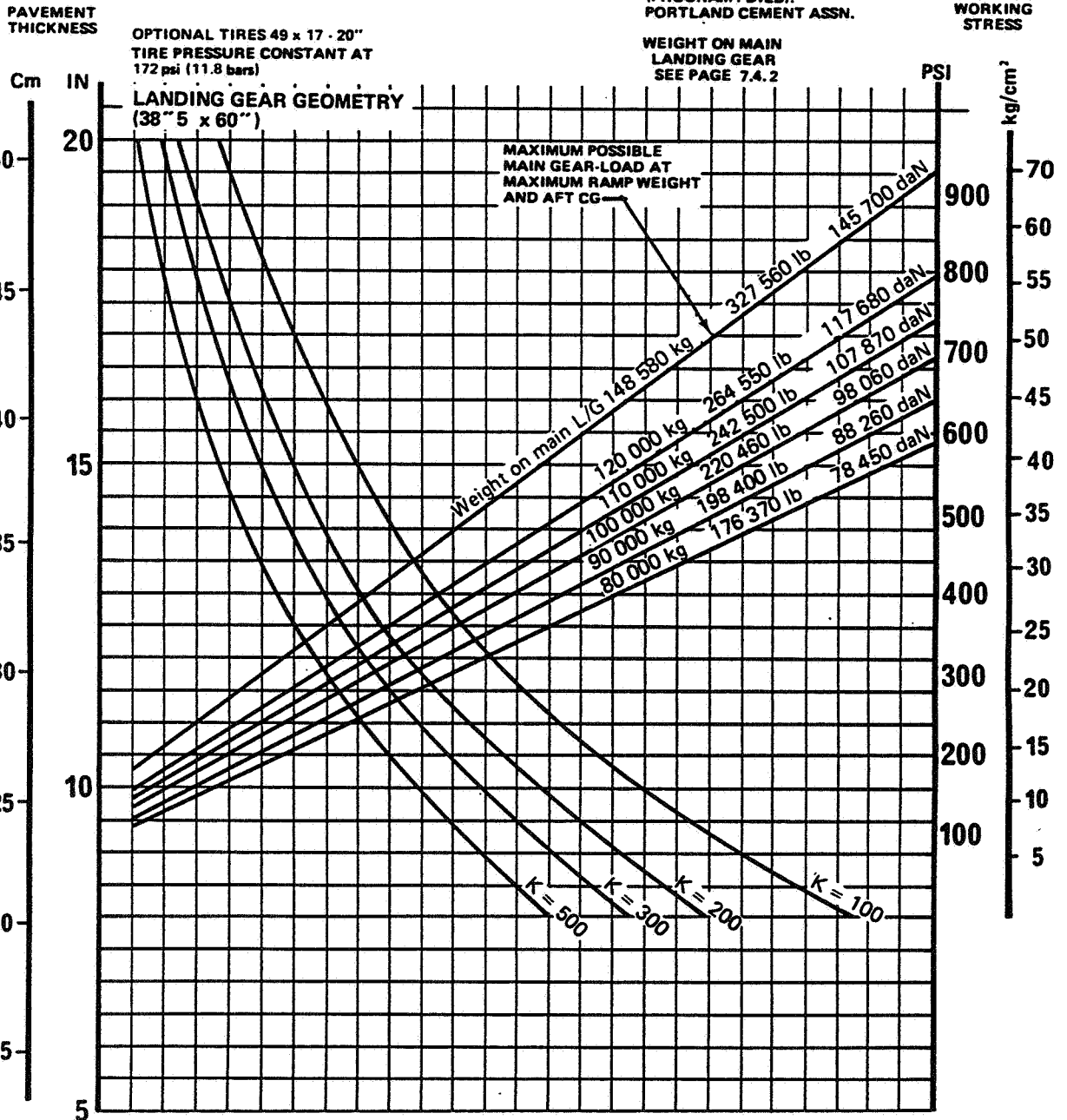

Printed in France

A A 5 07 07 03 0 AG 0

N

7.7.3.7 RIGID PAVEMENT REQUIREMENTS
PORTLAND CEMENT ASSOCIATION DESIGN METHOD
MODEL B4 - 157.5t OPTIONAL TIRES
LANDING GEAR GEOMETRY
38"5x60"

A 300

AIRPLANE CHARACTERISTICS

NOTE : THE VALUES OBTAINED BY USING THE MAXIMUM-LOAD REFERENCE LINE AND ANY VALUE OF k ARE EXACT. FOR LOADS LESS THAN MAXIMUM, THE CURVES ARE EXACT FOR $k = 300$ BUT DEVIATE SLIGHTLY FOR OTHER VALUES OF k .

REFERENCE : "DESIGN OF CONCRETE AIRCRAFT PAVEMENT AND COMPUTER PROGRAM FOR AIRPORT PAVEMENT DESIGN" (PROGRAM PDILB). PORTLAND CEMENT ASSN.

ALLOWABLE WORKING STRESS

WEIGHT ON MAIN LANDING GEAR
SEE PAGE 7.4.2

STANDARD TIRES 49 x 17 - 20"
TIRE PRESSURE CONSTANT AT
180 psi (12.4 bars)

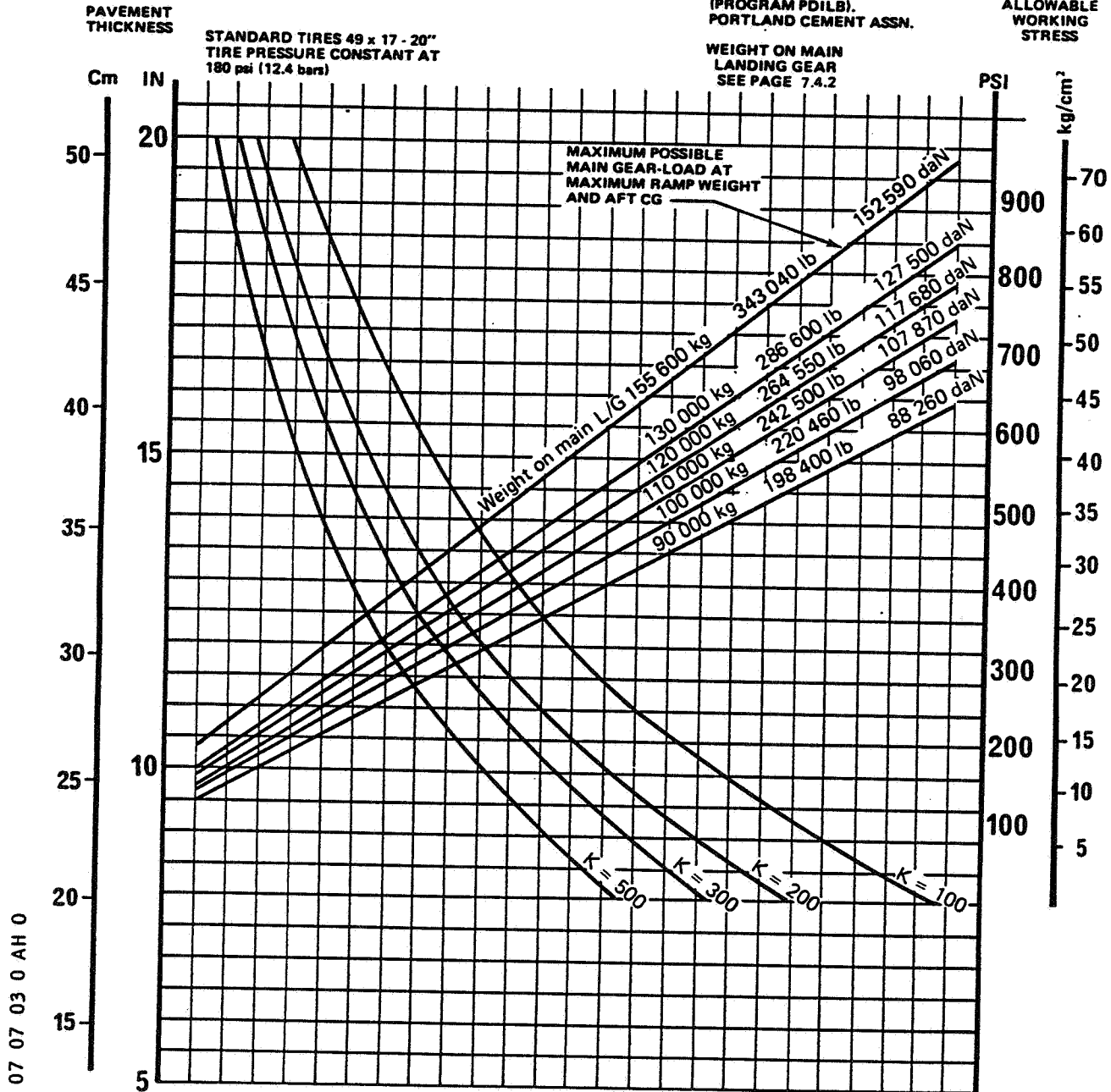

A A 5 07 07 03 0 AH 0

Printed in France

7.7.3.8 RIGID PAVEMENT REQUIREMENTS PORTLAND CEMENT ASSOCIATION DESIGN METHOD MODEL B4-C4 - 165t STANDARD TIRES

A 300

AIRPLANE CHARACTERISTICS

NOTE : THE VALUES OBTAINED BY USING THE MAXIMUM-LOAD REFERENCE LINE AND ANY VALUE OF k ARE EXACT, FOR LOADS LESS THAN MAXIMUM, THE CURVES ARE EXACT FOR k = 300 BUT DEVIATE SLIGHTLY FOR OTHER VALUES OF k.

REFERENCE : "DESIGN OF CONCRETE AIRCRAFT PAVEMENT AND COMPUTER PROGRAM FOR AIRPORT PAVEMENT DESIGN" (PROGRAM PDILB). PORTLAND CEMENT ASSN.

ALLOWABLE WORKING STRESS

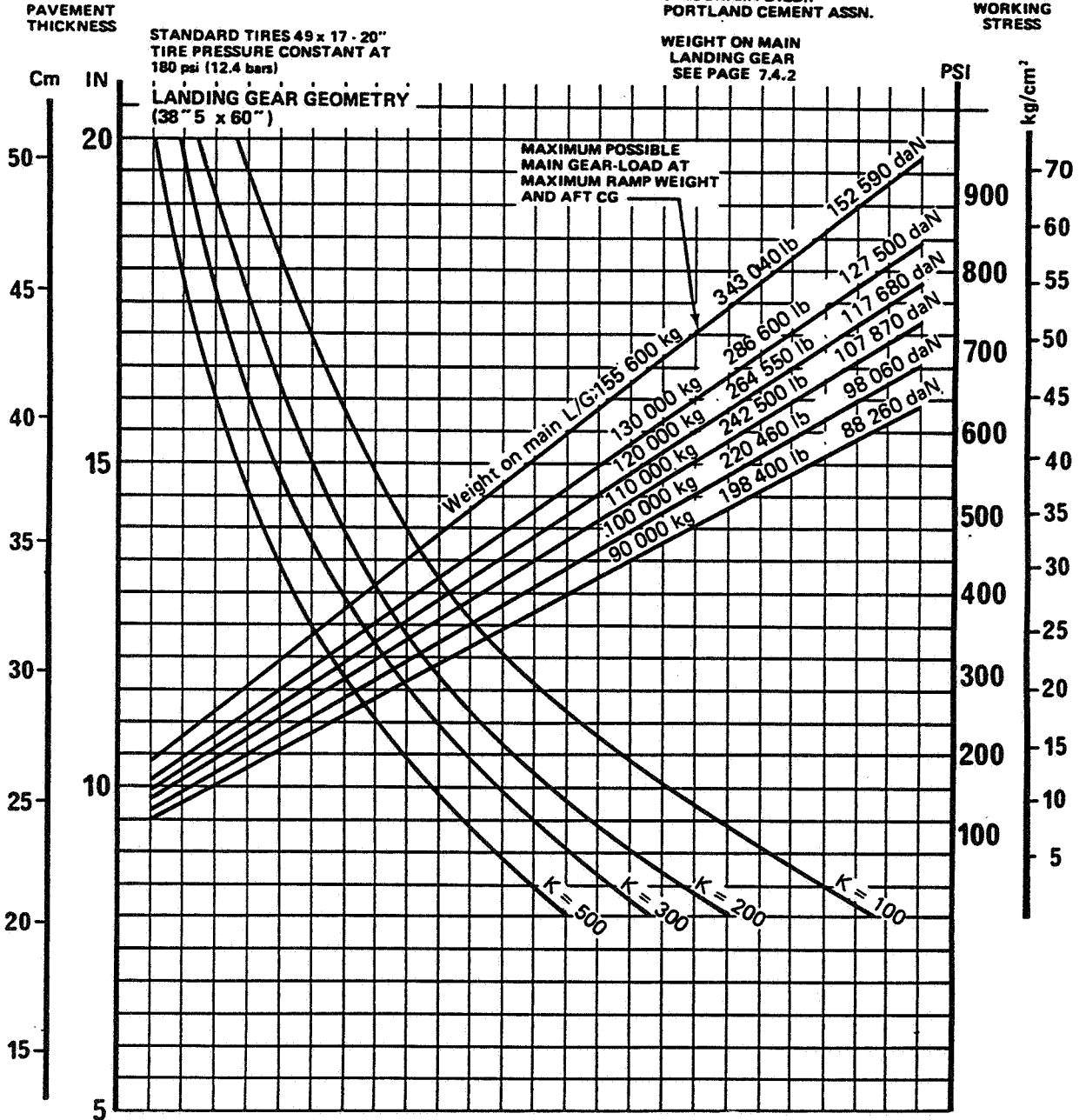

Printed in France

A A 5 07 07 03 0 A I 0

N

7.7.3.9 RIGID PAVEMENT REQUIREMENTS
PORTLAND CEMENT ASSOCIATION DESIGN METHOD
MODEL B4-C4 - 165t STANDARD TIRES

LANDING GEAR GEOMETRY
38"5x60"

A 300

AIRPLANE CHARACTERISTICS

NOTE : THE VALUES OBTAINED BY USING THE MAXIMUM-LOAD REFERENCE LINE AND ANY VALUE OF k ARE EXACT. FOR LOADS LESS THAN MAXIMUM, THE CURVES ARE EXACT FOR $k = 300$ BUT DEVIATE SLIGHTLY FOR OTHER VALUES OF k .

REFERENCE : "DESIGN OF CONCRETE AIRCRAFT PAVEMENT AND COMPUTER PROGRAM FOR AIRPORT PAVEMENT DESIGN" (PROGRAM PDILB). PORTLAND CEMENT ASSN.

ALLOWABLE WORKING STRESS

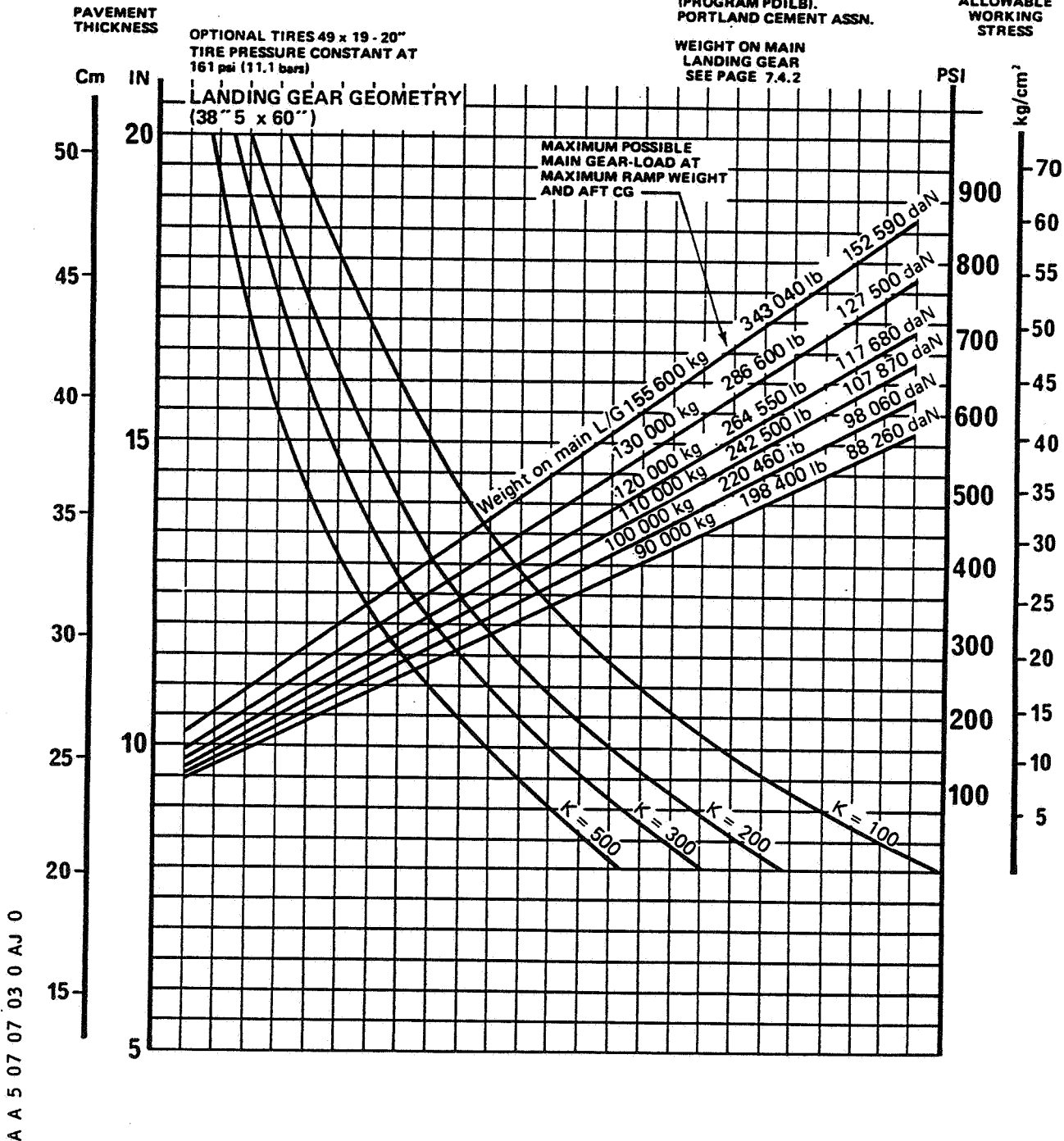

Printed in France

7.7.3.10 RIGID PAVEMENT REQUIREMENTS
PORTLAND CEMENT ASSOCIATION DESIGN METHOD
MODEL B4-C4 - 165t OPTIONAL TIRES

A 300
AIRPLANE CHARACTERISTICS

RADIUS OF RELATIVE STIFFNESS (ℓ)

VALUES OF ℓ IN INCHES

FOR $E = 4,000,000$ P.S.I AND $\mu = 0.15$

$$\text{RADIUS OF RELATIVE STIFFNESS } = \ell = \sqrt[4]{\frac{Ed^3}{12(1-\mu^2)k}} = 24.1652 \sqrt[4]{\frac{d^3}{k}}$$

Printed in France

d in in.	K=50	K=100	K=150	K=200	K=250	K=300	K=350	K=400	K=500
6.0	34.84	29.30	26.47	24.63	23.30	22.26	21.42	20.72	19.59
6.5	36.99	31.11	28.11	26.16	24.74	23.64	22.74	22.00	20.80
7.0	39.11	32.89	29.72	27.65	26.15	24.99	24.04	23.25	21.99
7.5	41.19	34.63	31.29	29.12	27.54	26.32	25.32	24.49	23.16
8.0	43.23	36.35	32.85	30.57	28.91	27.62	26.58	25.70	24.31
8.5	45.24	38.04	34.37	31.99	30.25	28.91	27.81	26.90	25.44
9.0	47.22	39.71	35.88	33.39	31.58	30.17	29.03	28.08	26.55
9.5	49.17	41.35	37.36	34.77	32.89	31.42	30.23	29.24	27.65
10.0	51.10	42.97	38.83	36.14	34.17	32.65	31.42	30.39	28.74
10.5	53.01	44.57	40.28	37.48	35.45	33.87	32.59	31.52	29.81
11.0	54.89	46.16	41.71	38.81	36.71	35.07	33.75	32.64	30.87
11.5	56.75	47.72	43.12	40.13	37.95	36.26	34.89	33.74	31.91
12.0	58.59	49.27	44.52	41.43	39.18	37.44	36.02	34.84	32.95
12.5	60.41	50.80	45.90	42.72	40.40	38.60	37.14	35.92	33.97
13.0	62.22	52.32	47.27	43.99	41.61	39.75	38.25	36.99	34.99
13.5	64.00	53.82	48.63	45.26	42.80	40.89	39.35	38.06	35.99
14.0	65.77	55.31	49.98	46.51	43.98	42.02	40.44	39.11	36.99
14.5	67.53	56.78	51.31	47.75	45.16	43.15	41.51	40.15	37.97
15.0	69.27	58.25	52.63	48.98	46.32	44.26	42.58	41.19	38.95
15.5	70.99	59.70	53.94	50.20	47.47	45.36	43.64	42.21	39.92
16.0	72.70	61.13	55.24	51.41	48.62	46.45	44.70	43.23	40.88
16.5	74.40	62.56	56.53	52.61	49.75	47.54	45.74	44.24	41.84
17.0	76.08	63.98	57.81	53.80	50.88	48.61	46.77	45.24	42.78
17.5	77.75	65.38	59.48	54.98	52.00	49.68	47.80	46.23	43.72
18.0	79.41	66.78	60.35	56.16	53.11	50.74	48.82	47.22	44.66
19.0	82.70	69.54	62.84	58.48	55.31	52.84	50.84	49.17	46.51
20.0	85.95	72.27	65.30	60.77	57.47	54.92	52.84	51.10	48.33
21.0	89.15	74.97	67.74	63.04	59.62	56.96	54.81	53.01	50.13
22.0	92.31	77.63	70.14	65.28	61.73	58.98	56.75	54.89	51.91
23.0	95.44	80.26	72.52	67.49	63.83	60.98	58.68	56.75	53.67
24.0	98.54	82.86	74.87	69.68	65.90	62.96	60.58	58.59	55.41

7.7.4.1 RADIUS OF RELATIVE STIFFNESS
(REFERENCE : PORTLAND CEMENT ASSOCIATION)

A 300
AIRPLANE CHARACTERISTICS7.7.4.2 Radius of Relative Stiffness (other values of E and μ)

The chart of section 7.7.4.1 presents ρ -values based on Young's Modulus (E) of 4,000,000 psi and Poisson's (μ) Ratio of 0.15. For convenience in finding ρ values based on other values of E and μ , the curves of section 7.7.4.3 are included. For example, to find an ρ -value based on an E of 3,000,000 psi, the ρ factor of 0.931 is multiplied by the ρ -value found in table of section 7.7.3. The effect of variations of μ on the ρ -value is treated in a similar manner.

A 300
AIRPLANE CHARACTERISTICS

Printed in France

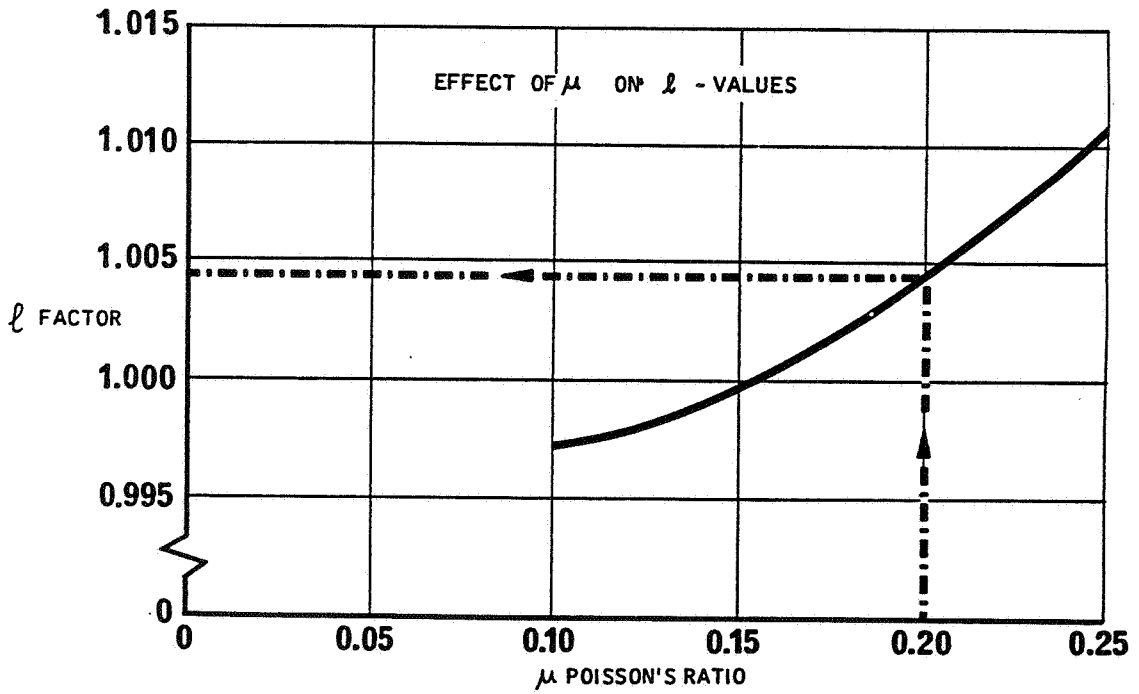
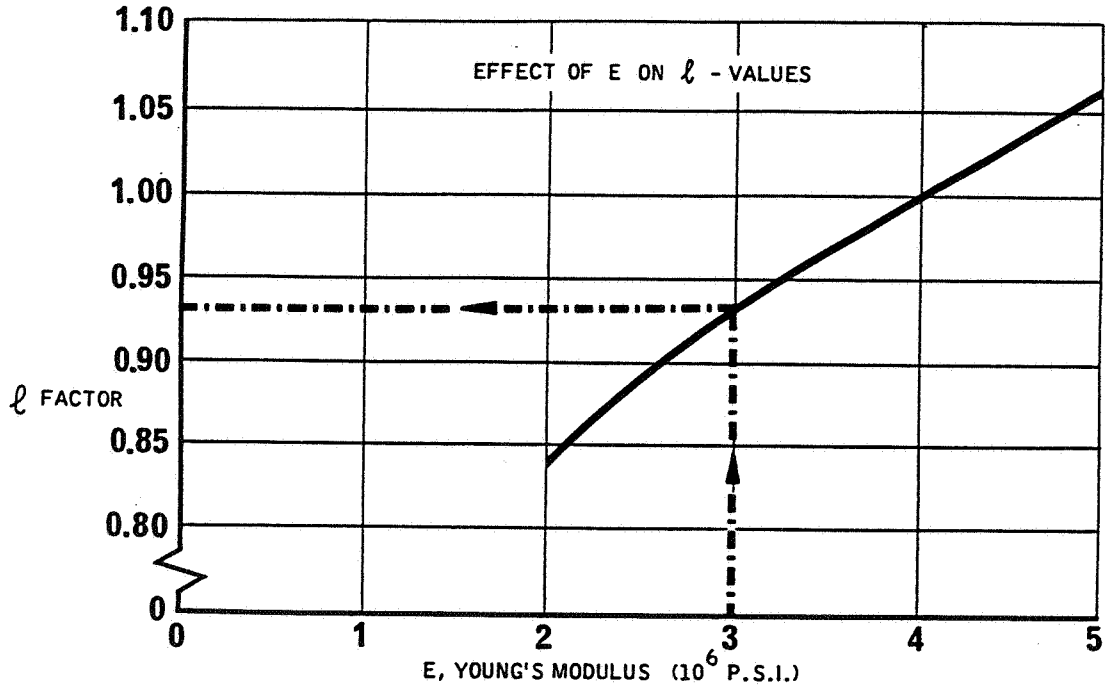

NOTE : BOTH CURVES ON THIS PAGE ARE USED TO ADJUST THE l VALUES OF THE TABLE IN SECTION 7.7.3

A A 5 07 07 00 0 CM 0
A 00 5 B P014 01 00 A

7.7.4.3 RADIUS OF RELATIVE STIFFNESS
(EFFECT OF E AND μ ON l VALUES)
MODEL B2 - B4

AIRBUS  INDUSTRIE
A 300
AIRPLANE CHARACTERISTICS

Printed in France

THIS PAGE LEFT BLANK INTENTIONALLY

A 300
AIRPLANE CHARACTERISTICS

7.8 RIGID PAVEMENT REQUIREMENTS LCN CONVERSION

In order to determine the airplane weight that can be accommodated on a particular rigid airport pavement, both the LCN of the pavement and the radius of relative stiffness "l" must be known.

See examples given Sub-section 7.6 for flexible runways.

AIRBUS  INDUSTRIE

A 300
AIRPLANE CHARACTERISTICS

Printed in France

THIS PAGE LEFT BLANK INTENTIONALLY

A 300
AIRPLANE CHARACTERISTICS

Printed in France

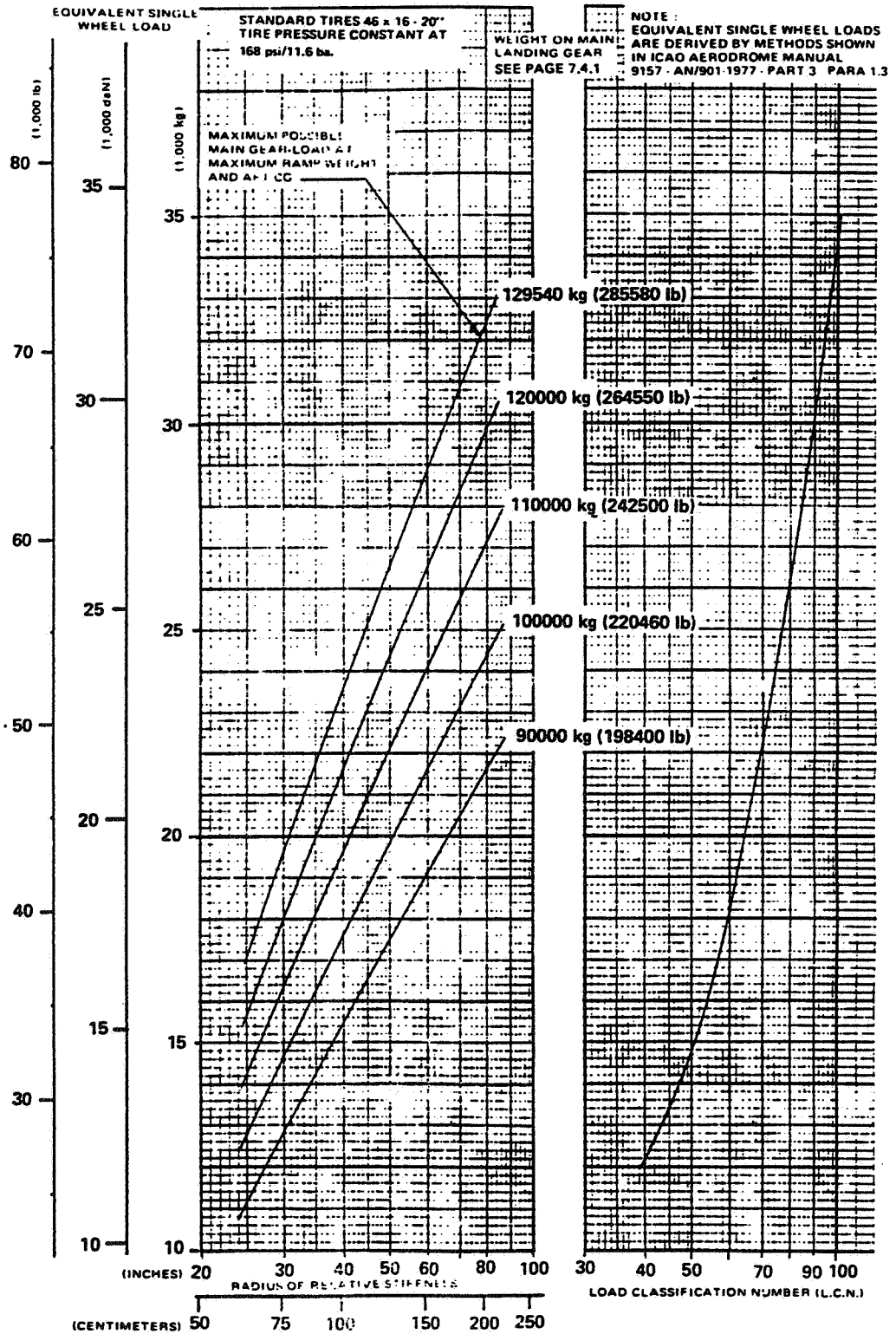

7.8.1.1 RIGID PAVEMENT REQUIREMENTS L.C.N. CONVERSION
MODEL B2 - 137t STANDARD TIRES

A 300

AIRPLANE CHARACTERISTICS

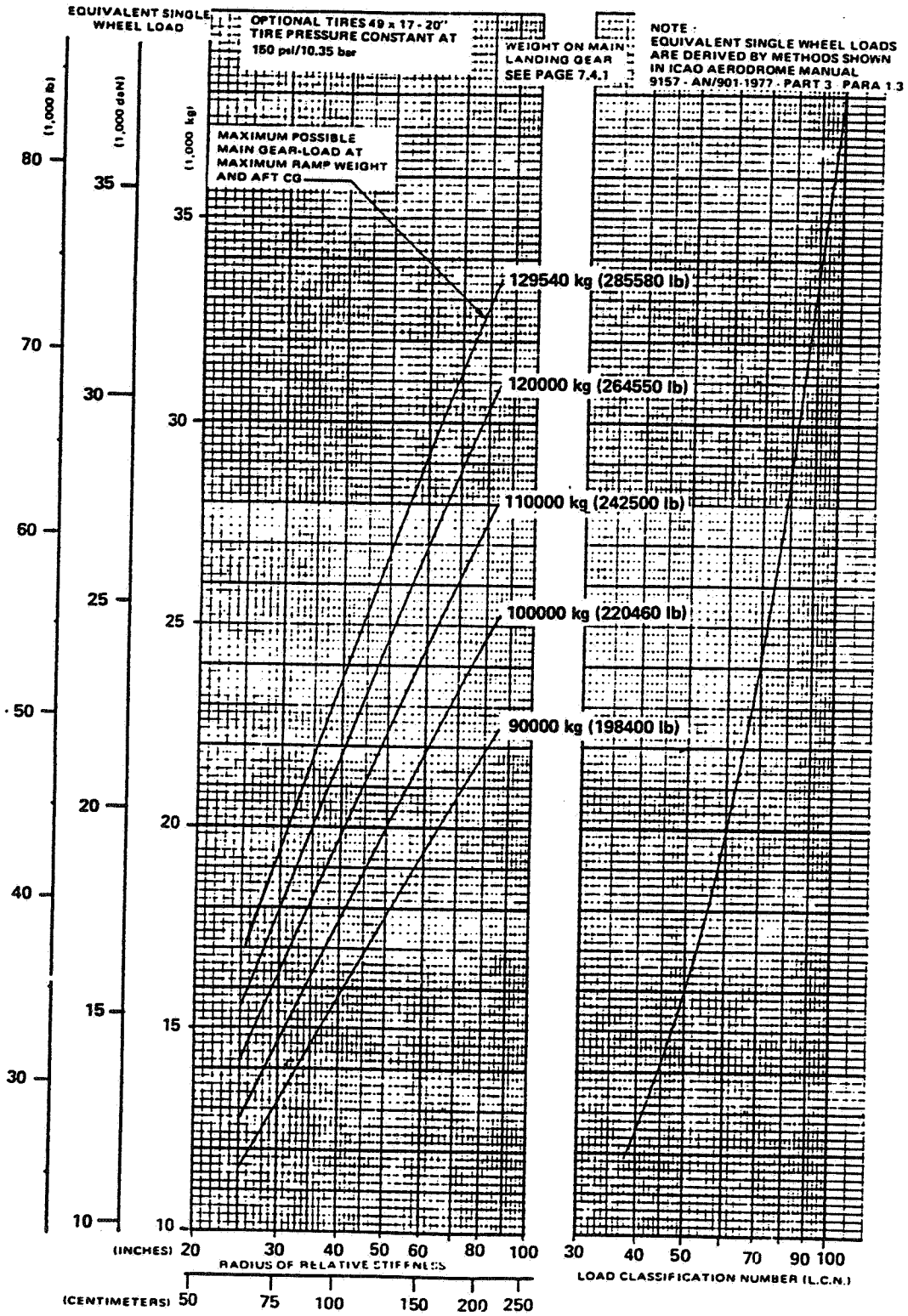

Printed in France

7.8.1.2 RIGID PAVEMENT REQUIREMENTS L.C.N. CONVERSION MODEL B2 - 137t OPTIONAL TIRES

A 300

AIRPLANE CHARACTERISTICS

Printed in France

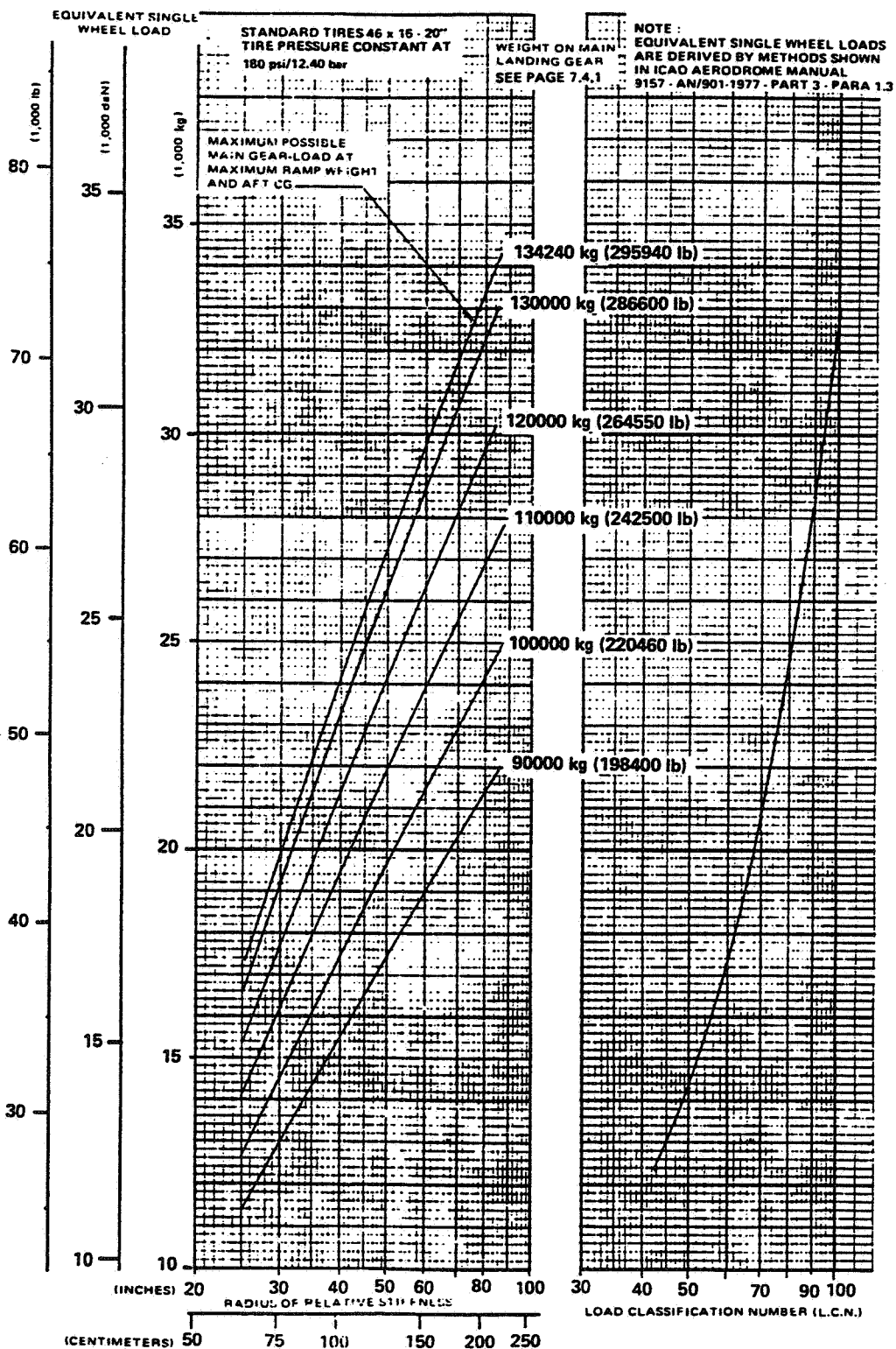

7.8.1.3 RIGID PAVEMENT REQUIREMENTS L.C.N. CONVERSION
 MODEL B2 - 142t STANDARD TIRES

A 300

AIRPLANE CHARACTERISTICS

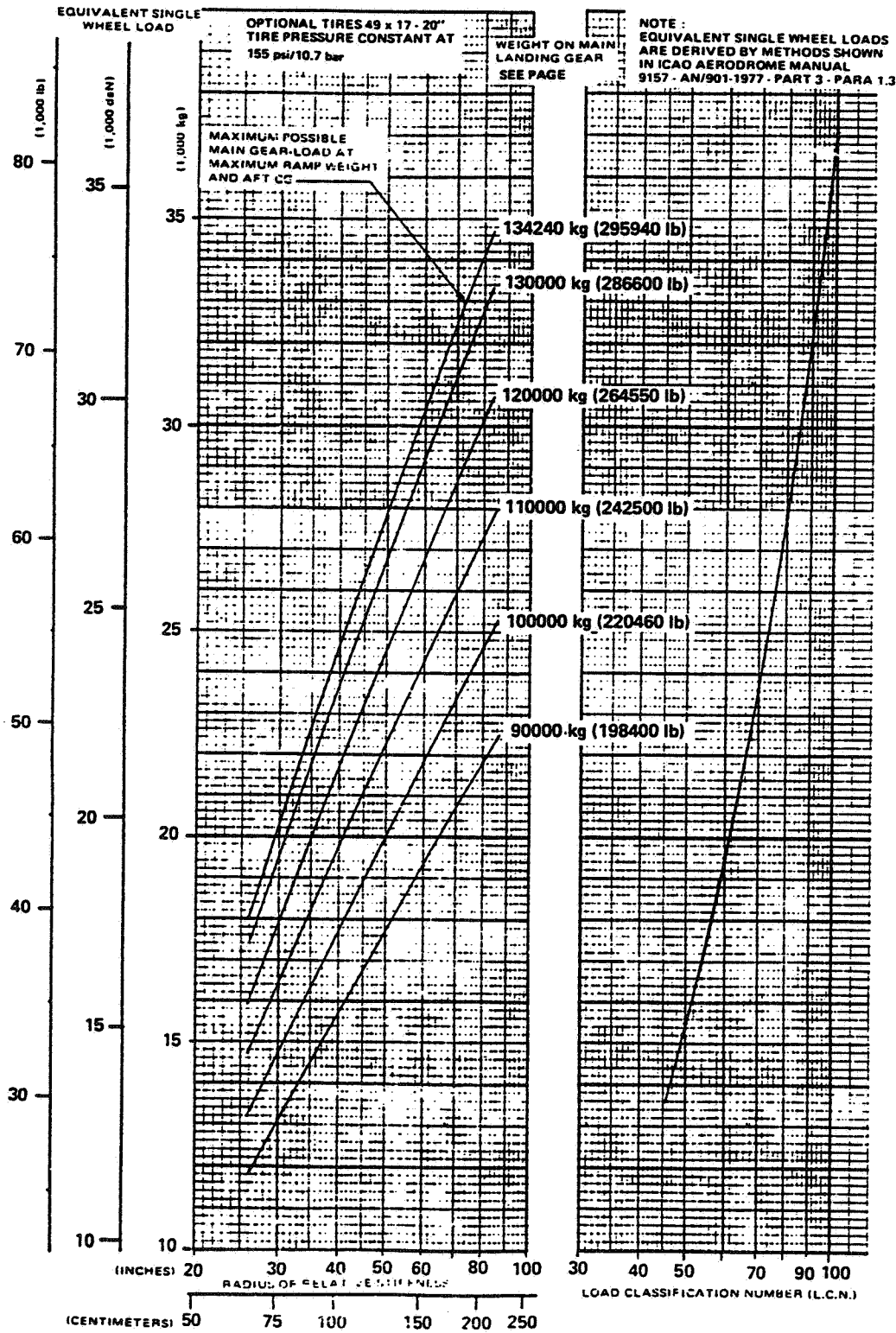

Printed in France

7.8.1.4 RIGID PAVEMENT REQUIREMENTS L.C.N. CONVERSION MODEL B2 - 142t OPTIONAL TIRES

AIRBUS  INDUSTRIE

A 300
AIRPLANE CHARACTERISTICS

Printed in France

THIS PAGE LEFT BLANK INTENTIONALLY

A 300

AIRPLANE CHARACTERISTICS

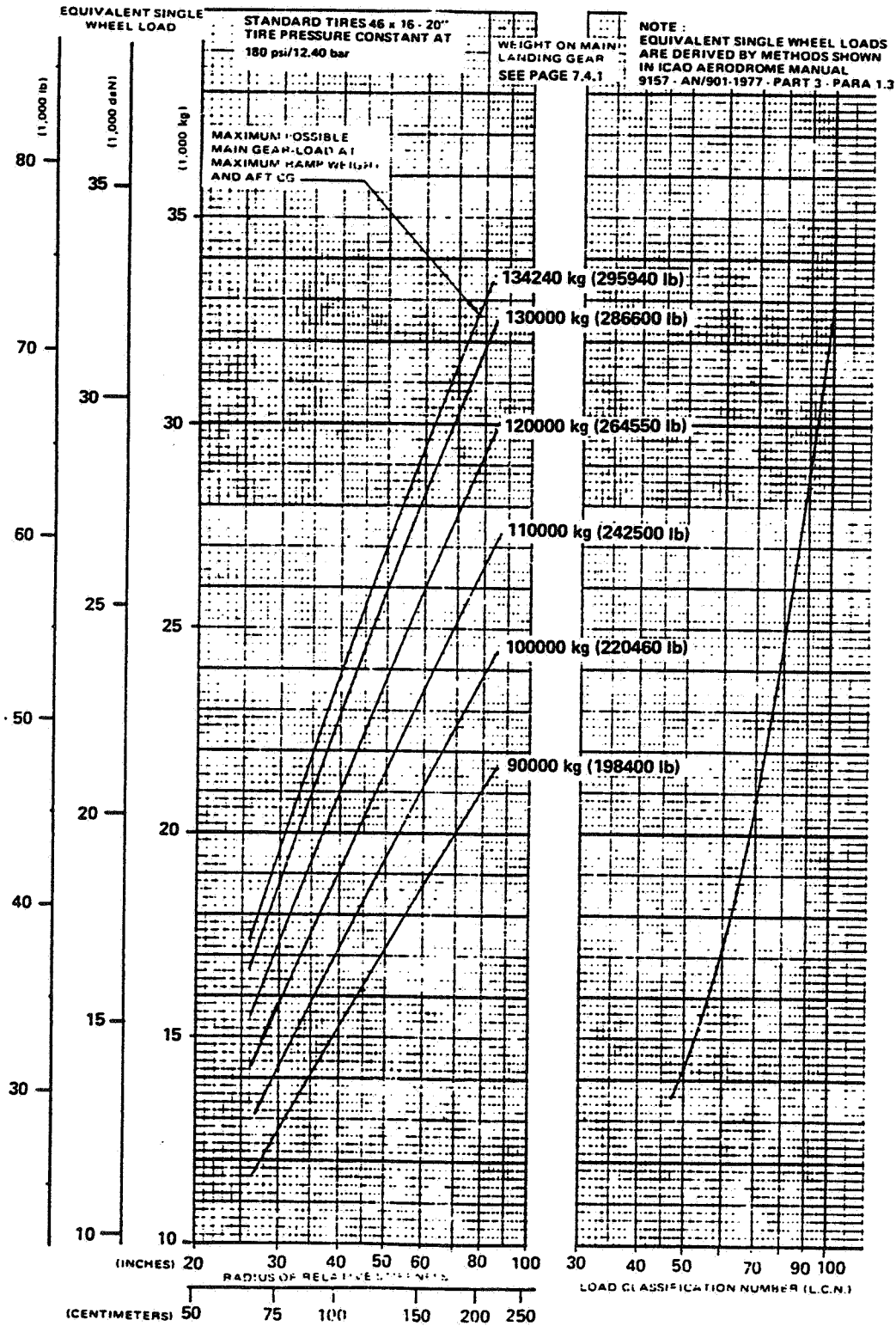

Printed in France

7.8.2.1 RIGID PAVEMENT REQUIREMENTS L.C.N. CONVERSION
MODEL B2K - 142t STANDARD TIRES

A 300
AIRPLANE CHARACTERISTICS

Printed in France

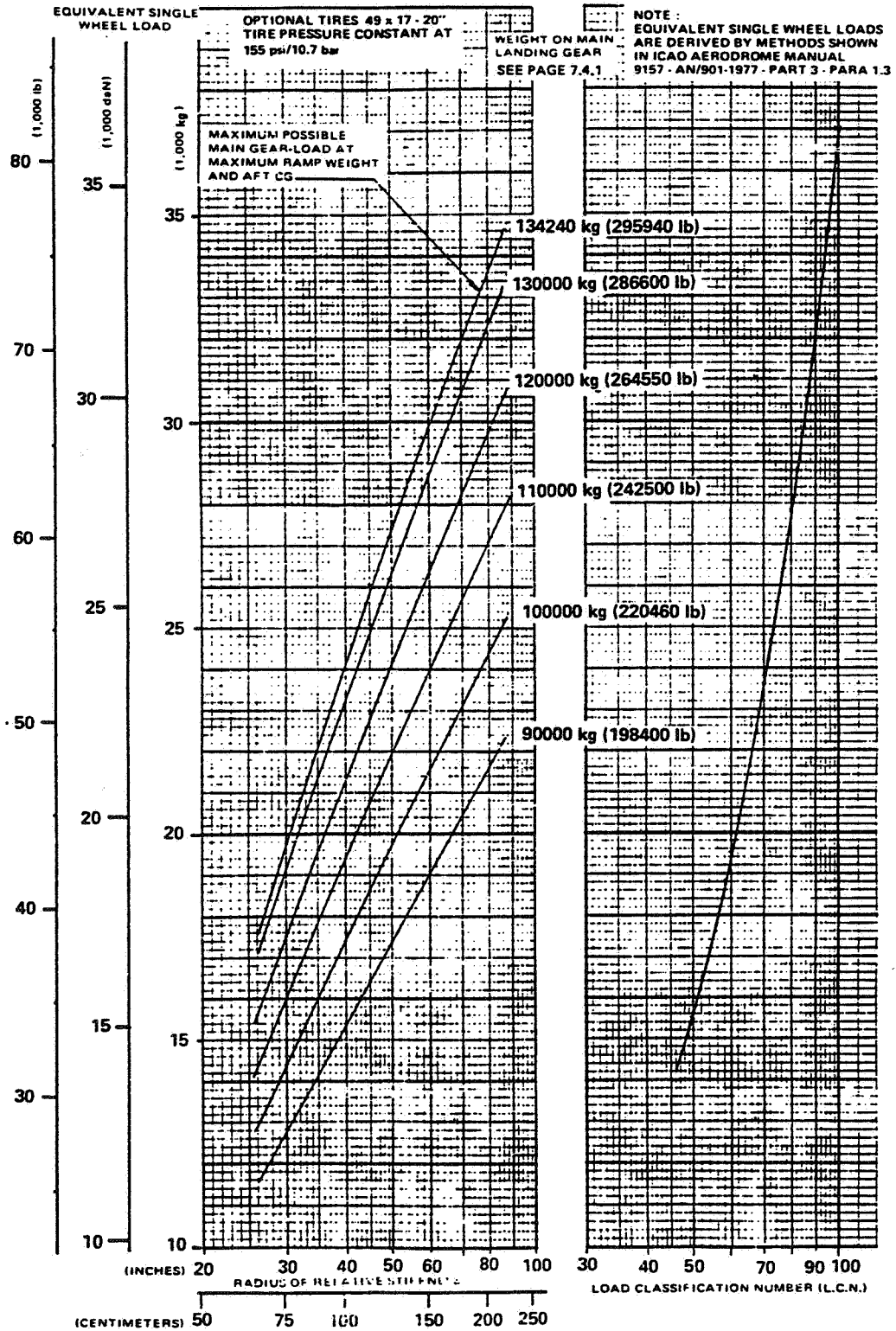

7.8.2.2 RIGID PAVEMENT REQUIREMENTS L.C.N. CONVERSION
MODEL B2K - 142t OPTIONAL TIRES

AIRBUS  INDUSTRIE
A 300
AIRPLANE CHARACTERISTICS

Printed in France

THIS PAGE LEFT BLANK INTENTIONALLY

A 300

AIRPLANE CHARACTERISTICS

Printed in France

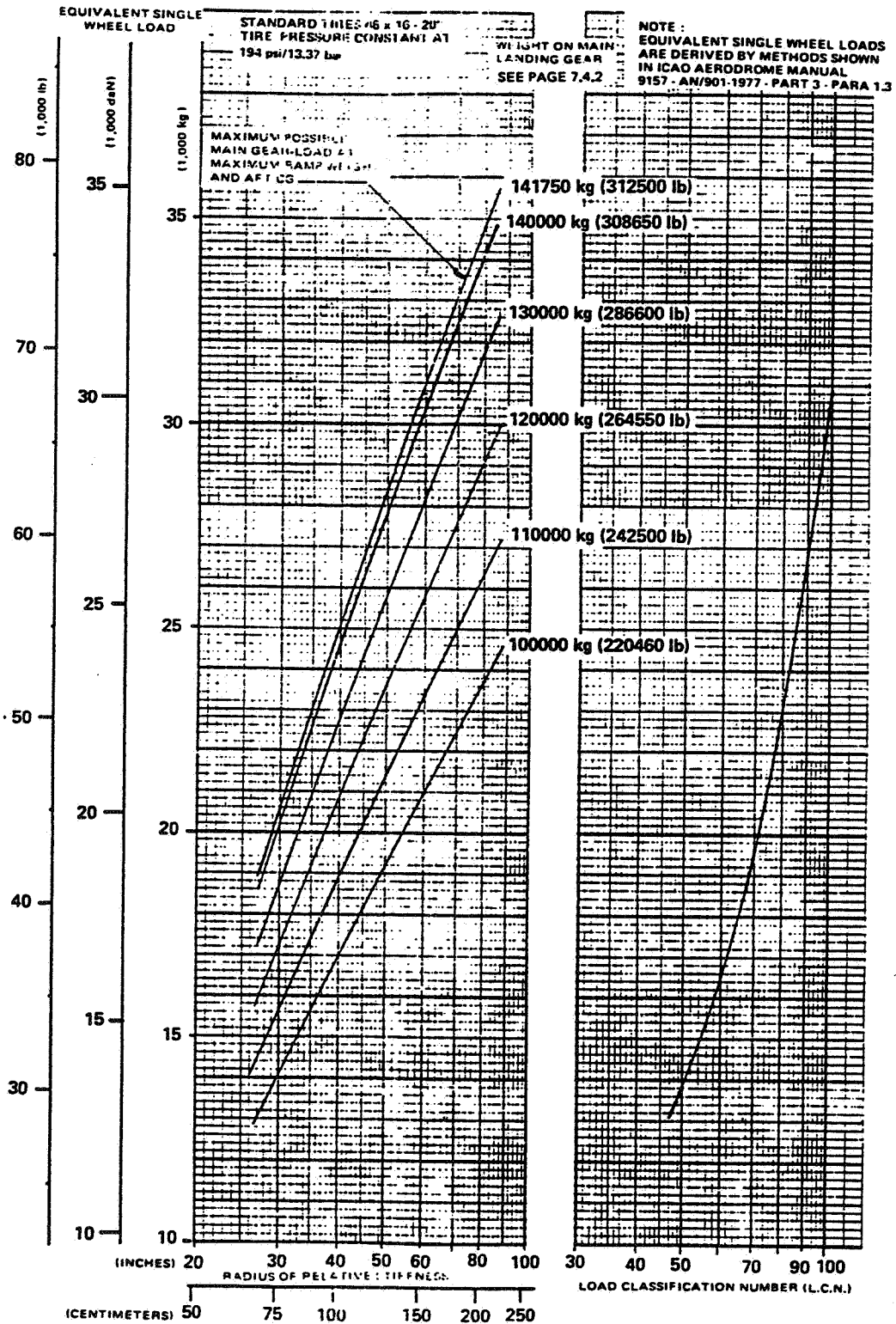

7.8.3.1 RIGID PAVEMENT REQUIREMENTS L.C.N. CONVERSION
MODEL B4 - 150t STANDARD TIRES

A 300

AIRPLANE CHARACTERISTICS

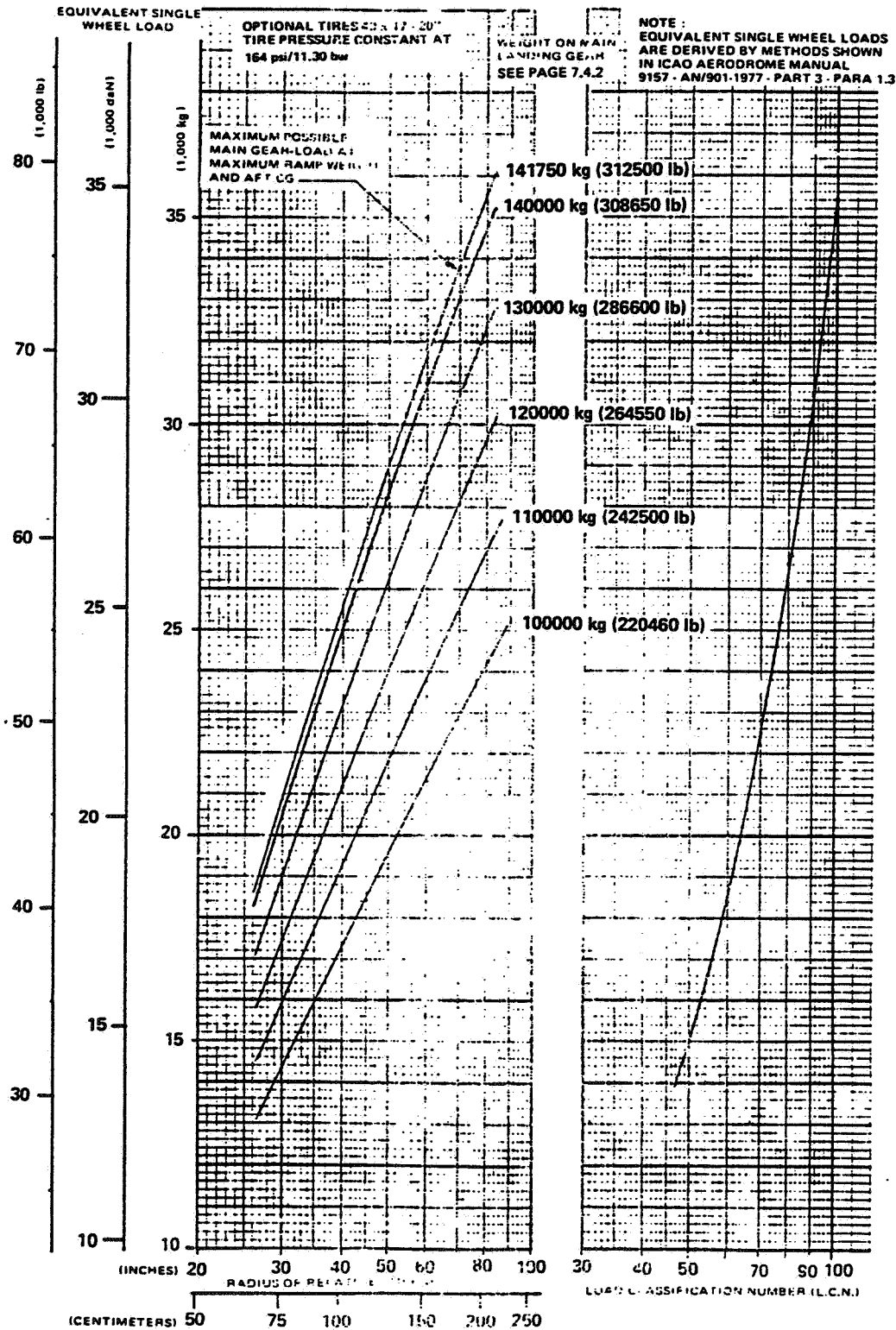

Printed in France

7.8.3.2 RIGID PAVEMENT REQUIREMENTS L.C.N. CONVERSION MODEL B4 - 150t OPTIONAL TIRES

A 300
AIRPLANE CHARACTERISTICS

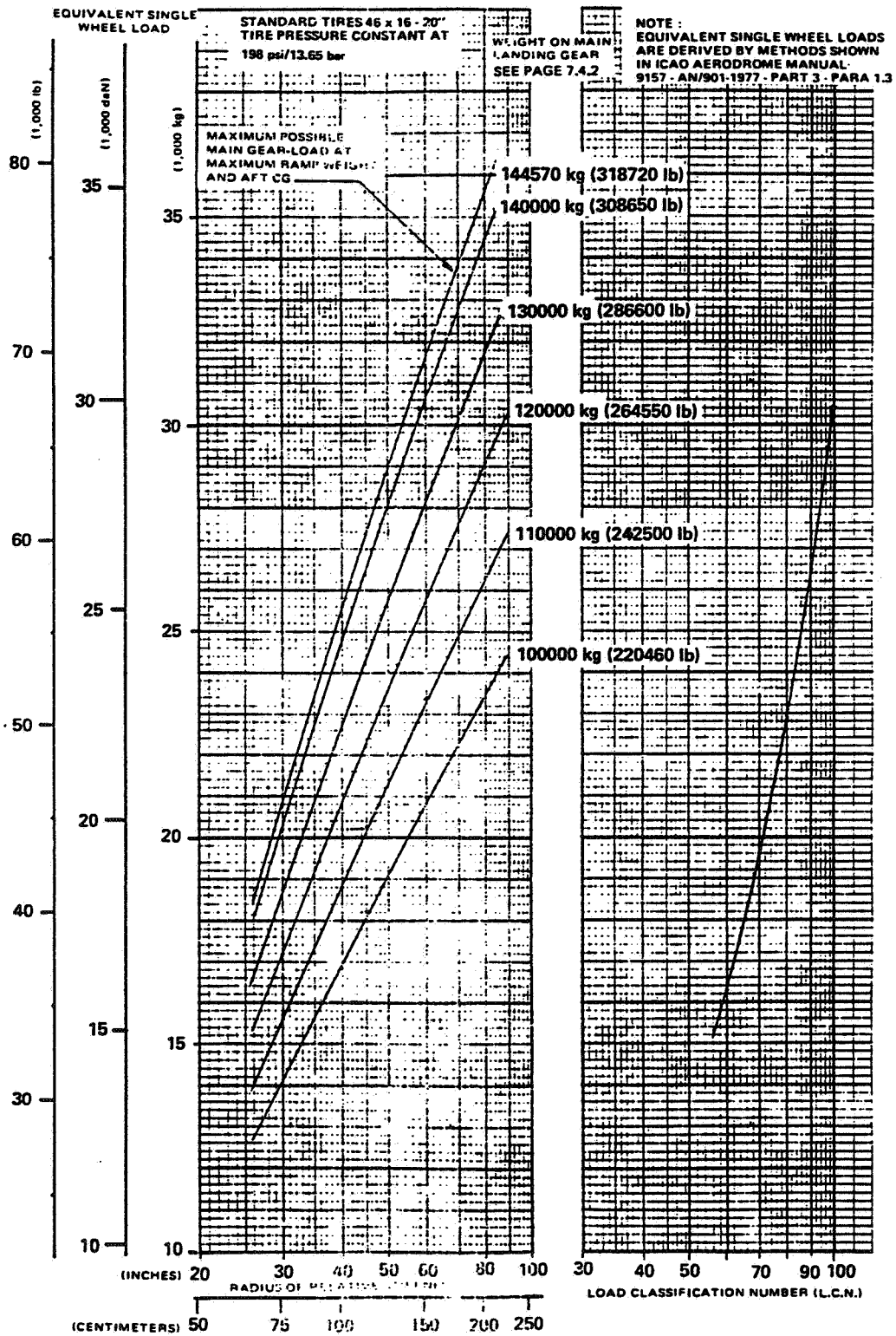

Printed in France

7.8.3.3 RIGID PAVEMENT REQUIREMENTS L.C.N. CONVERSION
MODEL B4 - 153t STANDARD TIRES

A 300

AIRPLANE CHARACTERISTICS

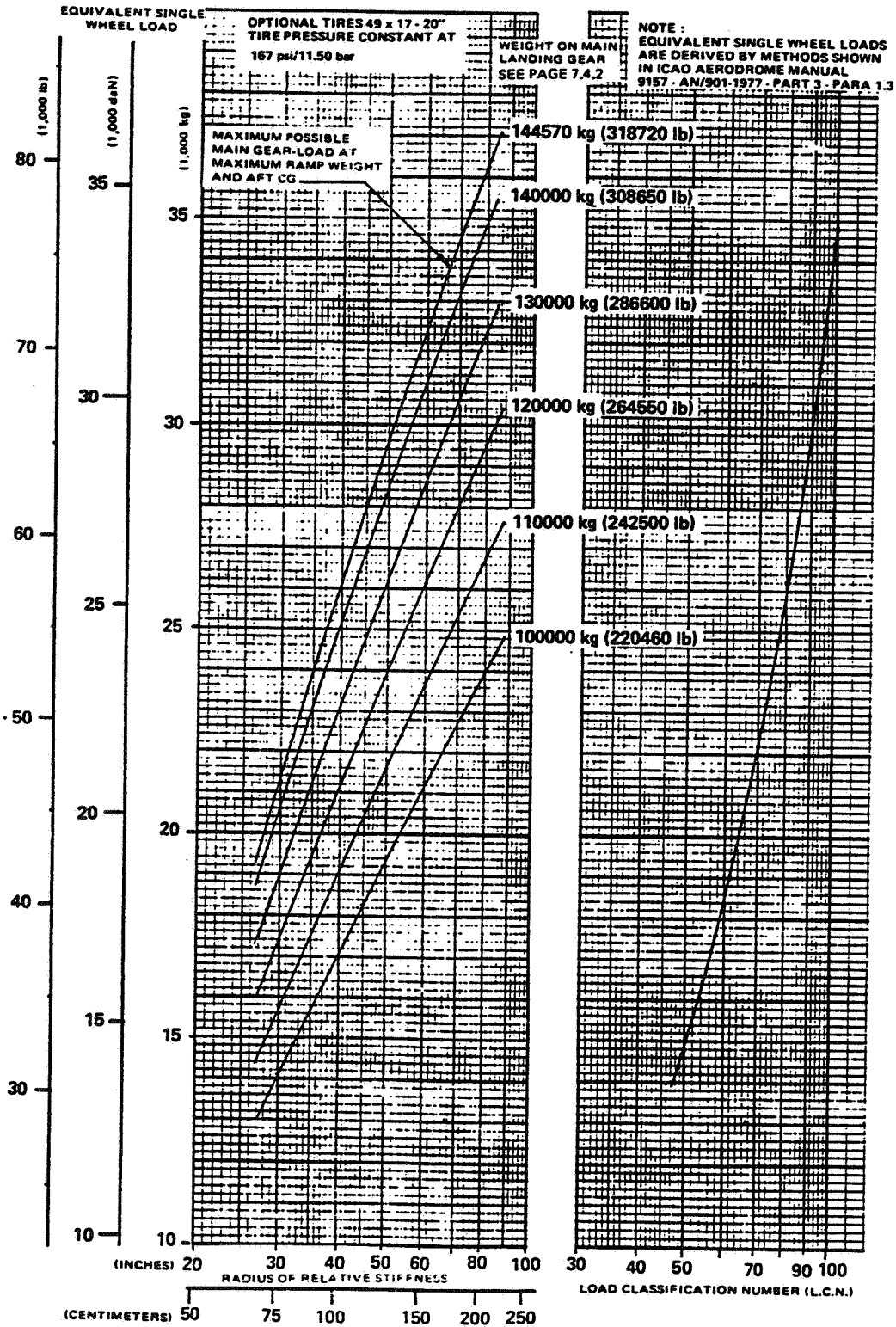

Printed in France

7.8.3.4 RIGID PAVEMENT REQUIREMENTS L.C.N. CONVERSION MODEL B4 - 153t OPTIONAL TIRES

A 300

AIRPLANE CHARACTERISTICS

Printed in France

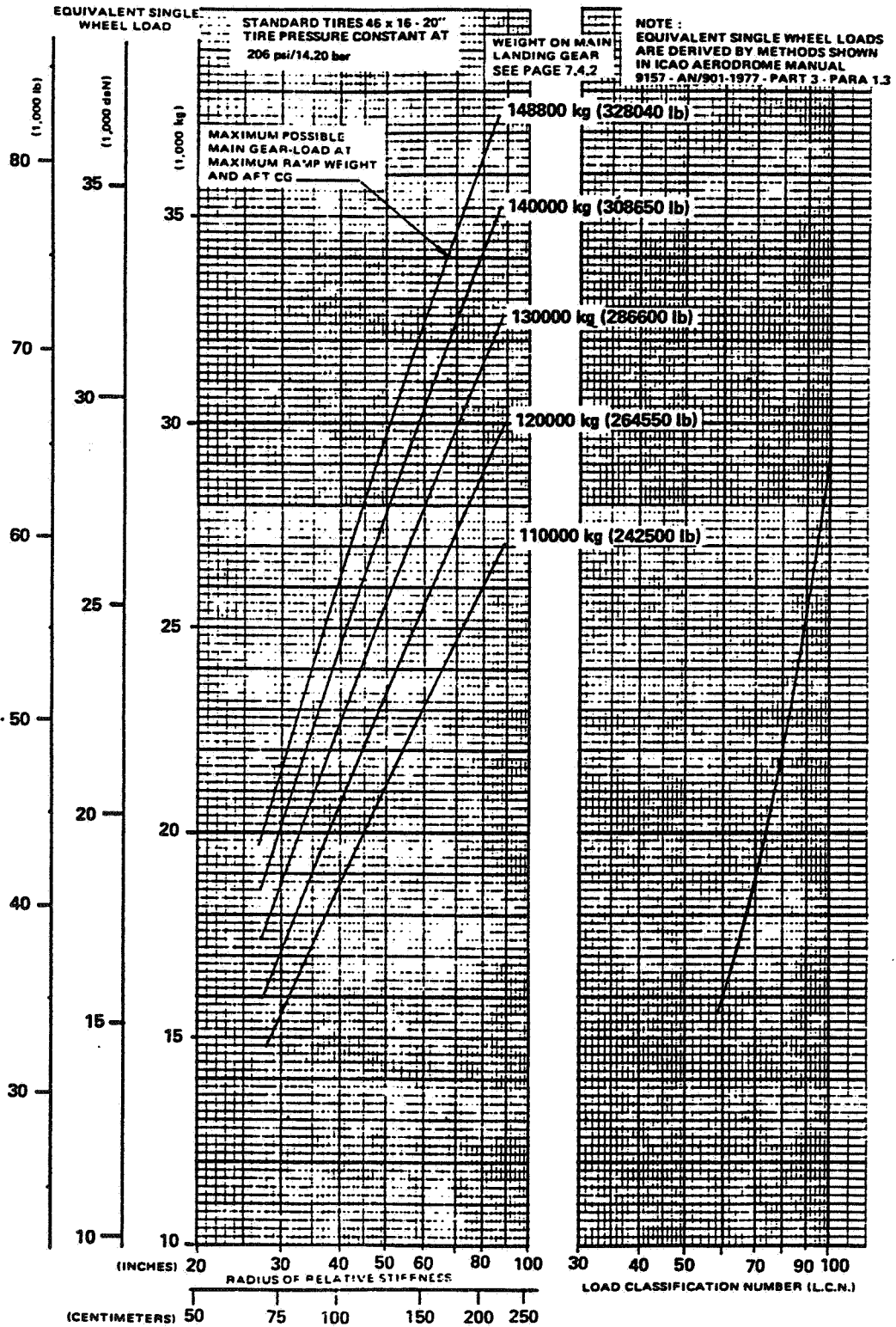

7.8.3.5 RIGID PAVEMENT REQUIREMENTS L.C.N. CONVERSION
 MODEL B4 - 157.5t STANDARD TIRES

A 300
AIRPLANE CHARACTERISTICS

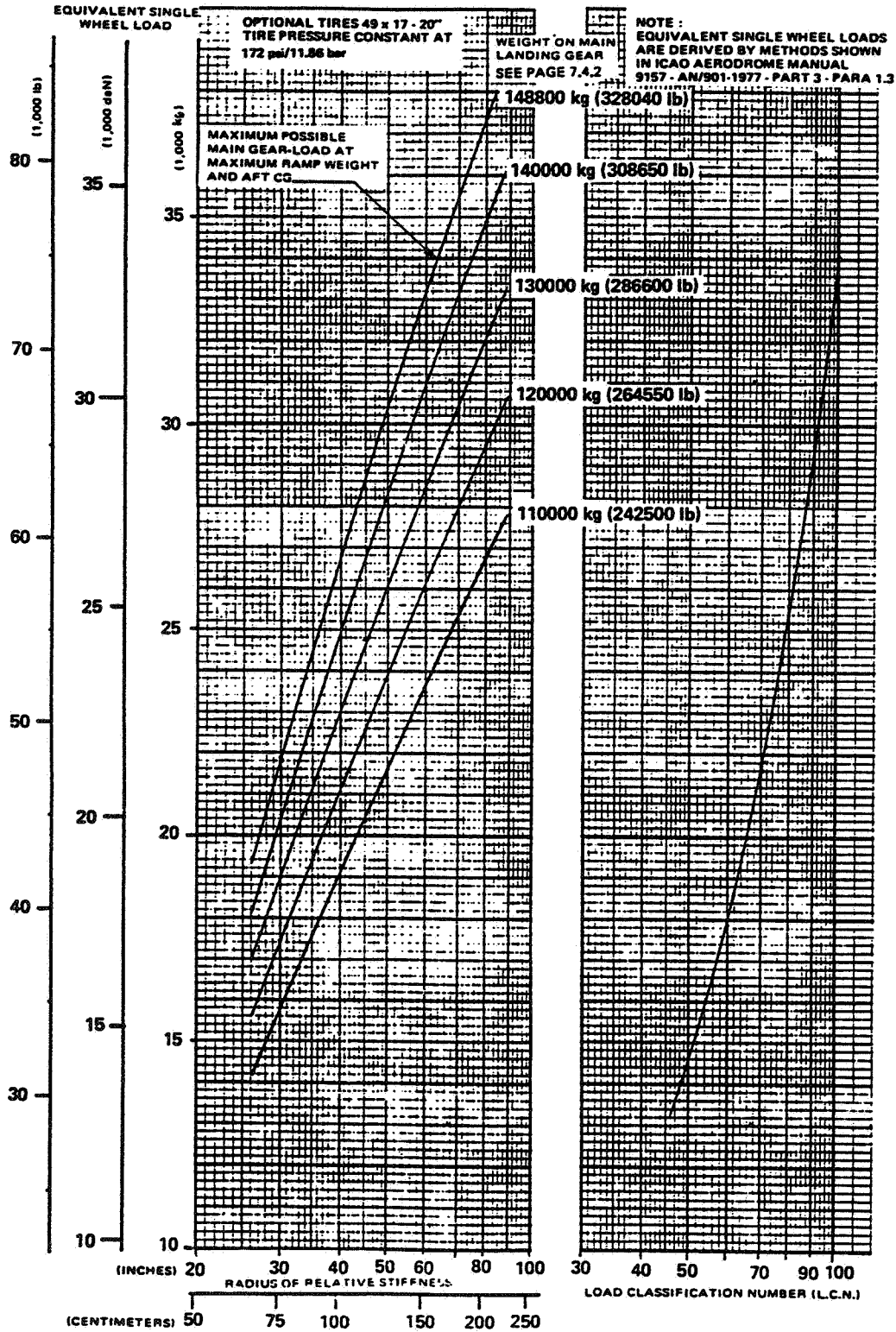

Printed in France

7.8.3.6 RIGID PAVEMENT REQUIREMENTS L.C.N. CONVERSION
MODEL B4 - 157.5t OPTIONAL TIRES

A 300

AIRPLANE CHARACTERISTICS

Printed in France

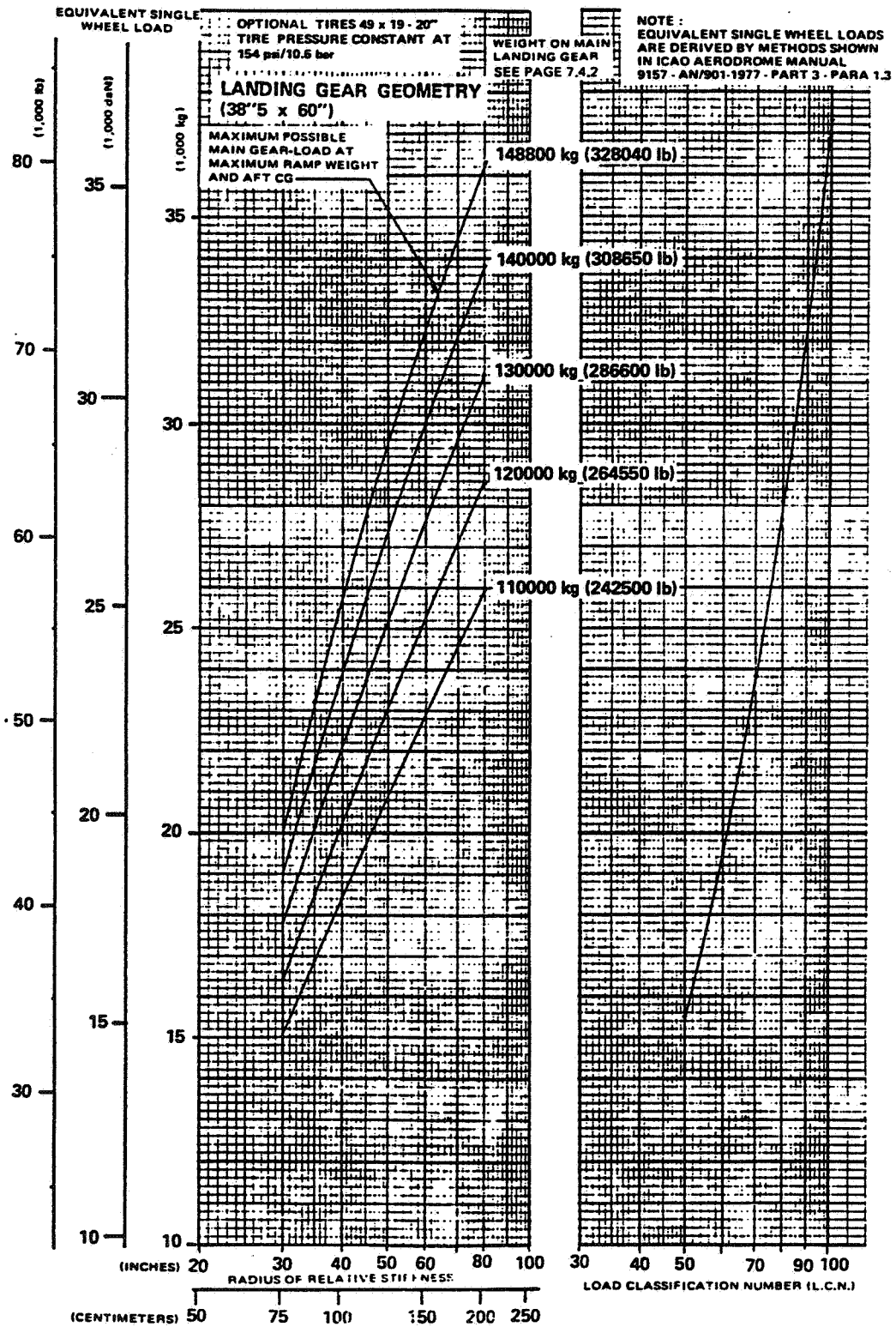

7.8.3.7 RIGID PAVEMENT REQUIREMENTS L.C.N. CONVERSION
 MODEL B4 - 157.5t OPTIONAL TIRES

A 300

AIRPLANE CHARACTERISTICS

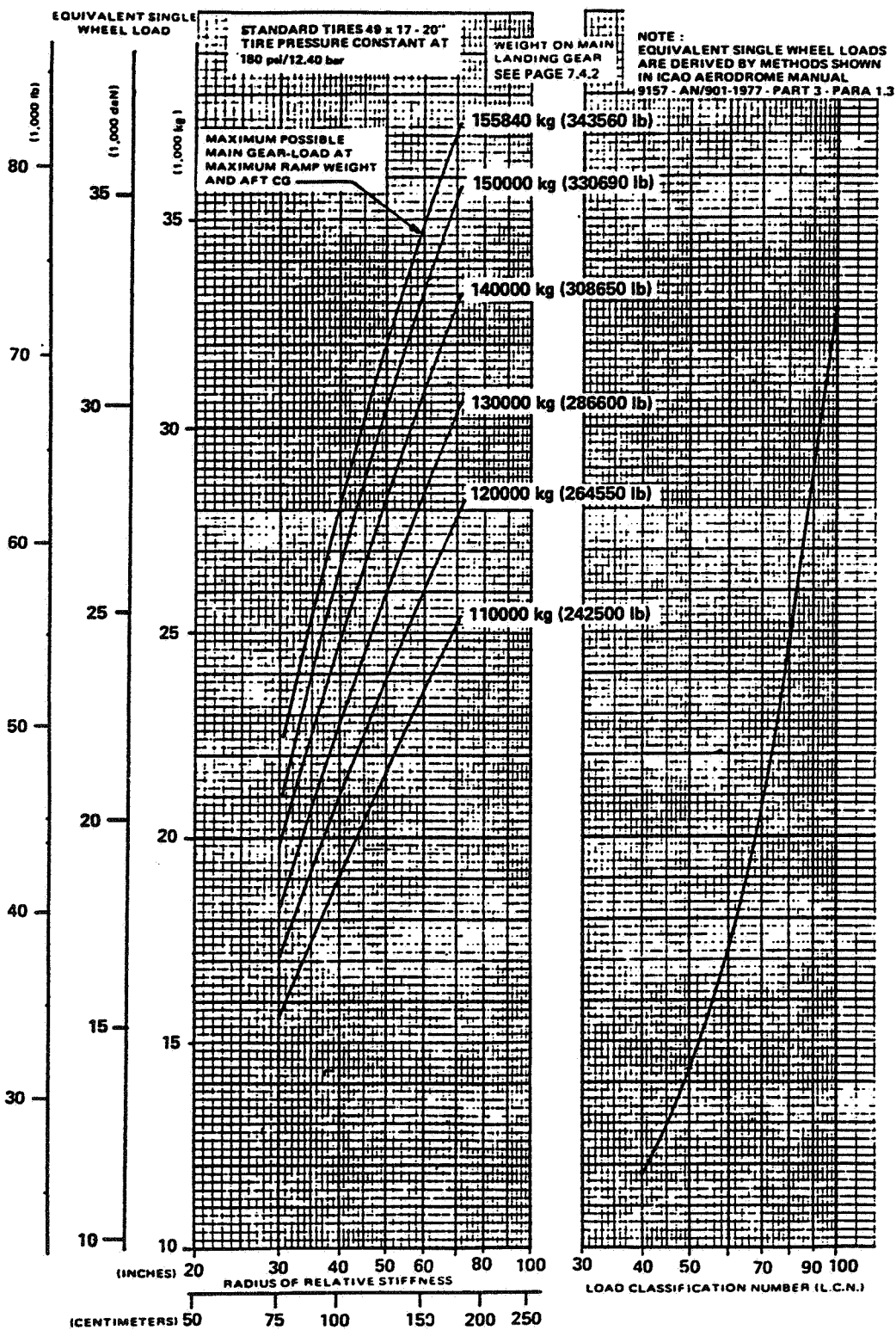

Printed in France

7.8.3.8 RIGID PAVEMENT REQUIREMENTS L.C.N. CONVERSION
 MODEL B4-C4 - 165t STANDARD TIRES

A 300

AIRPLANE CHARACTERISTICS

Printed in France

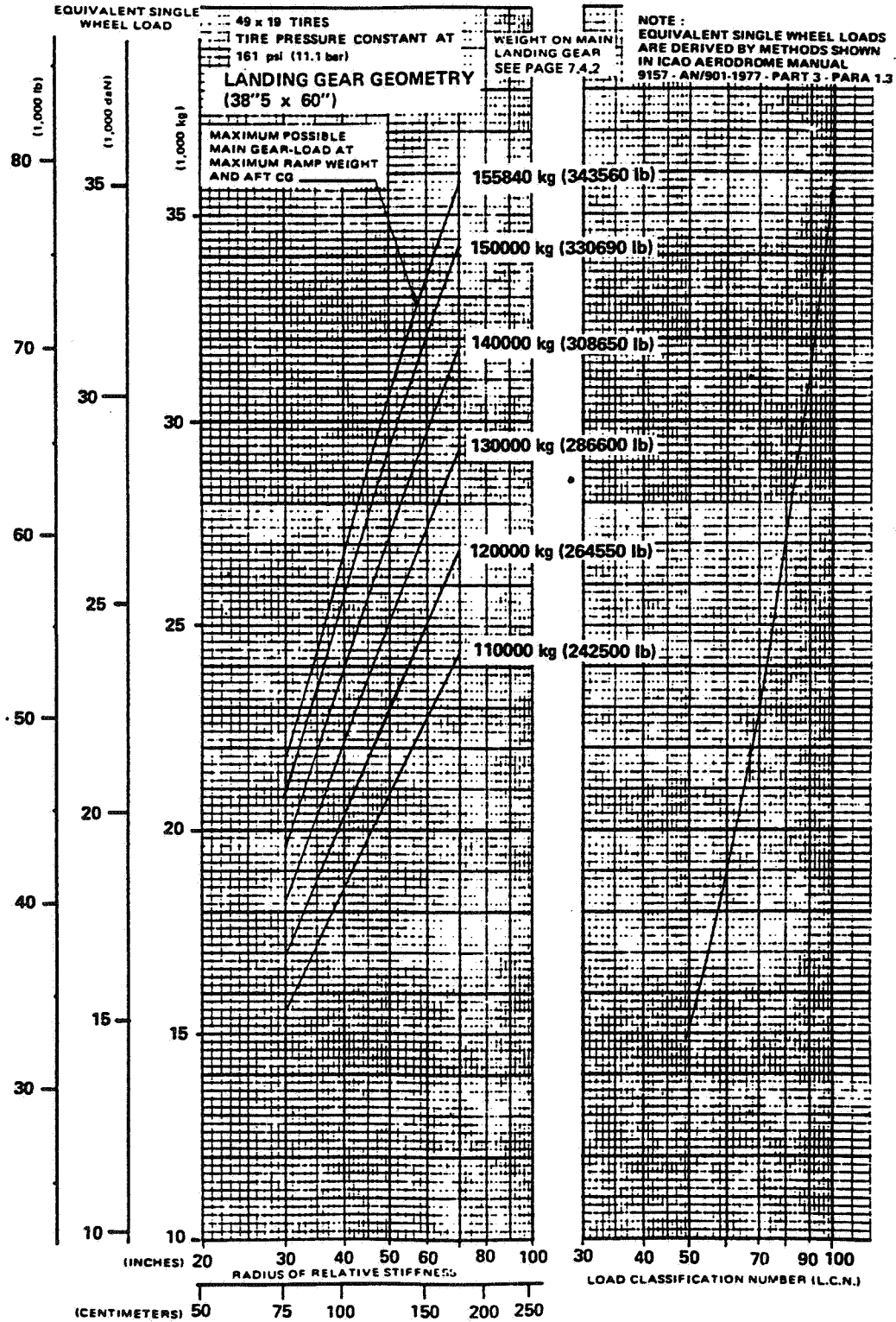

7.8.3.9 RIGID PAVEMENT REQUIREMENTS L.C.N. CONVERSION
 MODEL B4-C4 - 165t OPTIONAL TIRES

AIRBUS  INDUSTRIE
A 300
AIRPLANE CHARACTERISTICS

Printed in France

THIS PAGE LEFT BLANK INTENTIONALLY

7.9 ACN/PCN REPORTING SYSTEM - FLEXIBLE AND RIGID PAVEMENTS

To determine the ACN of an aircraft on a flexible or rigid pavements, both the aircraft TOW and the subgrade strength category of the pavement must be known.

Examples of calculations are given hereafter.

Note : An aircraft having an ACN equal or less than the PCN can operate without any limitations. However, if the aircraft tire pressure is higher than the maximum admissible tire pressure published for the pavement concerned, the aircraft operations will not be authorized.

EXAMPLE 1 : CALCULATION OF THE ACN OF AN AIRCRAFT AT MAX. RAMP WEIGHT

Aircraft Data : A300B2 at 137.9 t
Standard tires 46 X 16 - 20 Type VII
Pavement Data : Flexible CAT B (CBR 10)

Referring to the relevant ACN curve 7.9.1.1 given in chapter 7 page 95 will give ACN 43 for max ramp weight (column CBR 10, for 129540 kg, which corresponds to the maximum load on main L/G at max. aft C.G. position).

EXAMPE 2 : CALCULATION OF THE ACN OF AN AIRCRAFT AT INTERMEDIATE WEIGHT

Data Aircraft : A300 (Design TOW 137 t)
operating at an intermediate TOW of 125 t.
- Standard tires 46 X 16 - 20 Type VII
- Medium CG position 25 %
Runway : Flexible, CAT A (CBR 15)

At first, the real load on the main L/G must be calculated. For this exercise, use the curve 7.4.1 given in Chapter 7 page 9.

Load on the main L/G at 25 % CG : 114 t. Then, enter this value in the relevant ACN curve 7.9.1.1 given in chapter 7 page 95. ACN found is 33.

EXAMPLE 3 : CALCULATION OF THE MAXIMUM PERMISSIBLE TOW FOR AN AIRCRAFT OPERATING ON A GIVEN RUNWAY

Aircraft Data : A300 (Design TOW 137 t)
Standard tires 46 X 16 - 20 Type VII
Medium CG position 25 %
Pavement Data : PCN 45/R/C/...

The maximum load on main L/G admissible on that pavement must be determined by using the relevant ACN curve 7.9.4.1 in Chapter 7 page 111.

This load equals 120 t.

Then, using the graph 7.4.1 given in Chapter 7 page 9, the corresponding permissible TOW is determined. In the present case, it equals 133 t.

AIRBUS  INDUSTRIE
A 300
 AIRPLANE CHARACTERISTICS

Printed in France

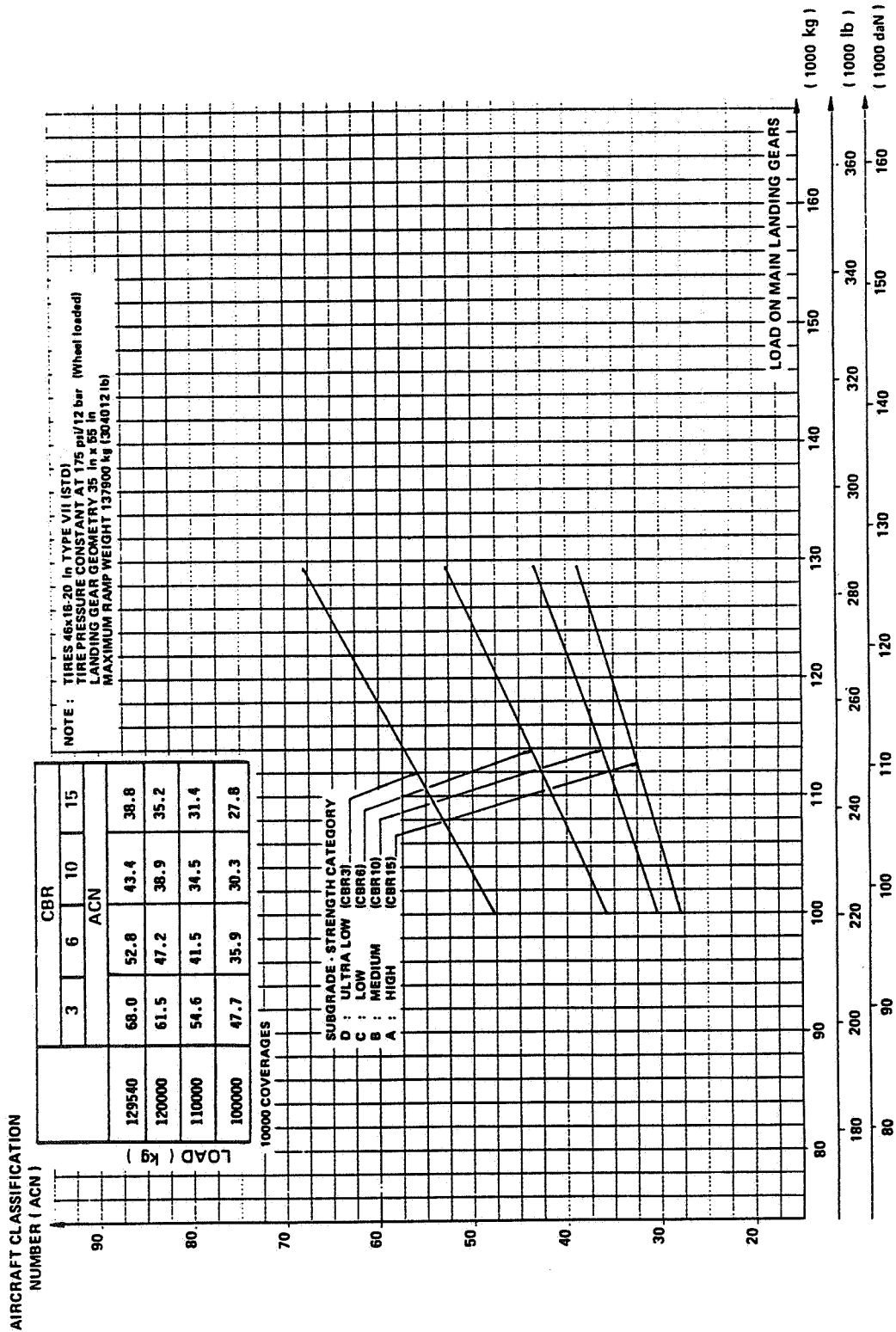

7.9.1.1 AIRCRAFT CLASSIFICATION NUMBER
 FLEXIBLE PAVEMENT - STANDARD TIRES
 MODEL B2-137t

AIRBUS  INDUSTRIE
A 300
AIRPLANE CHARACTERISTICS

Printed in France

THIS PAGE LEFT BLANK INTENTIONALLY

A 300
AIRPLANE CHARACTERISTICS

Printed in France

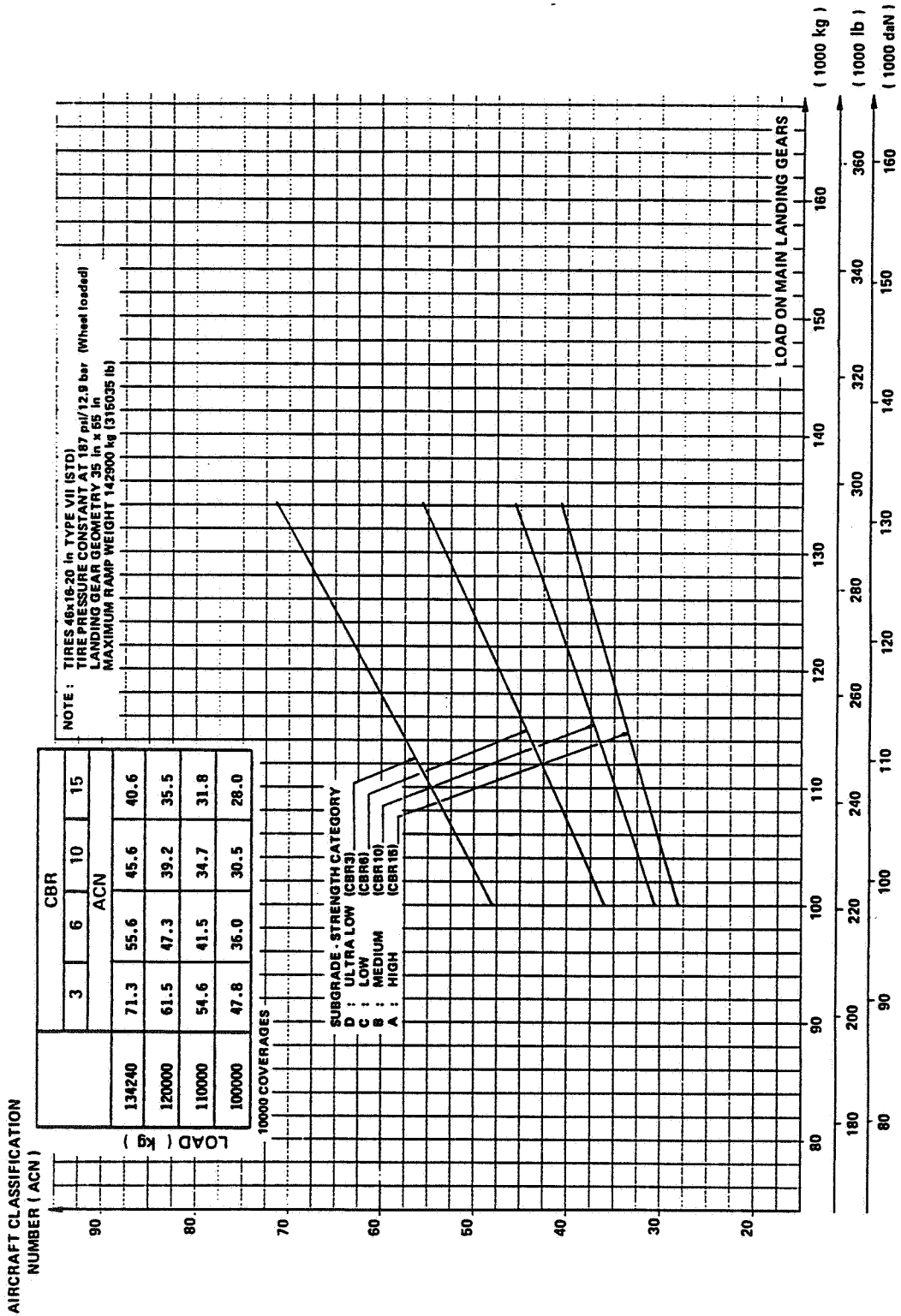

7.9.1.3 AIRCRAFT CLASSIFICATION NUMBER
FLEXIBLE PAVEMENT - STANDARD TIRES
MODEL B2-142t

A 300

AIRPLANE CHARACTERISTICS

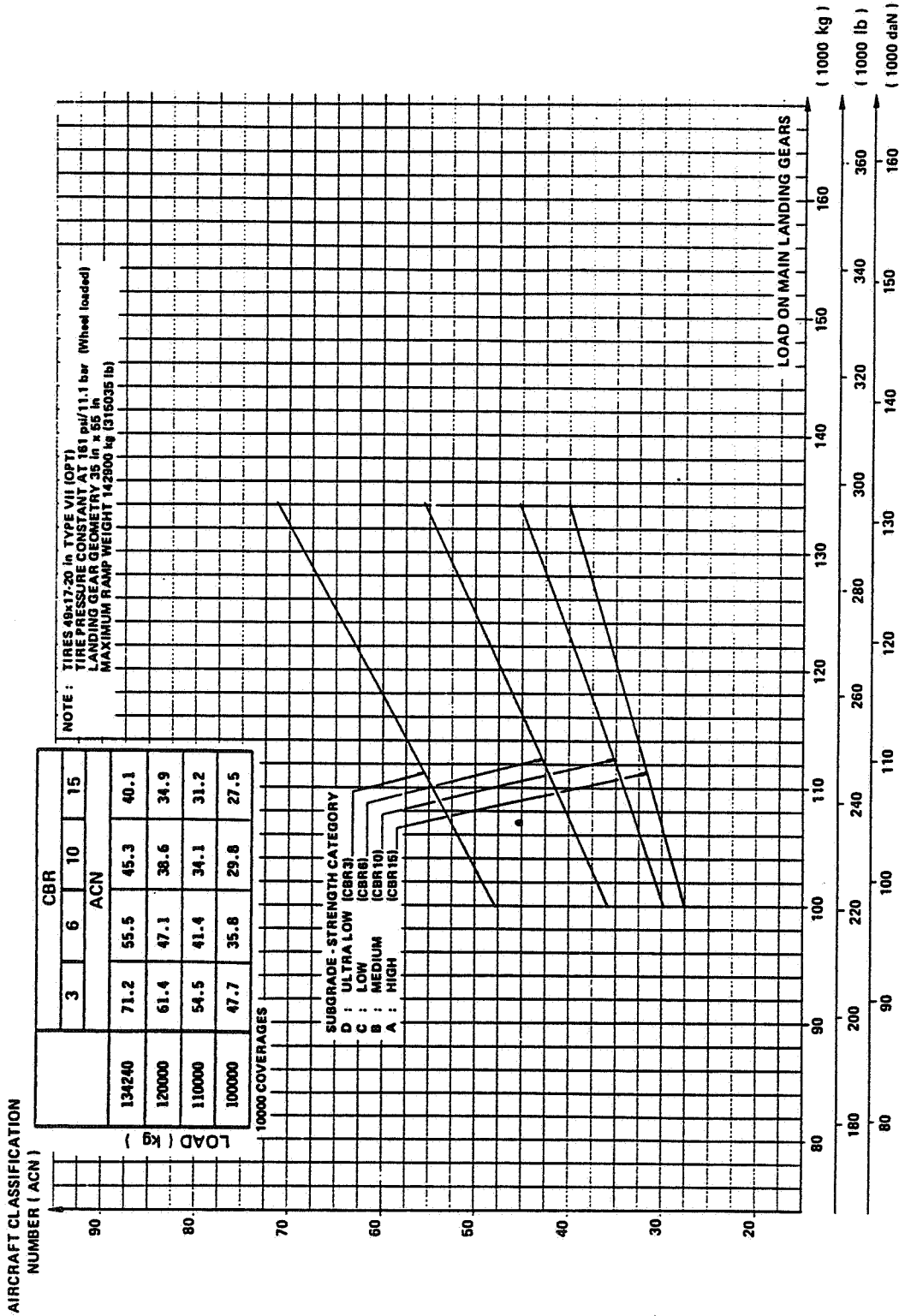

7.9.1.4 AIRCRAFT CLASSIFICATION NUMBER
 FLEXIBLE PAVEMENT - OPTIONAL TIRES
 MODEL B2-142t

A 300

AIRPLANE CHARACTERISTICS

Printed in France

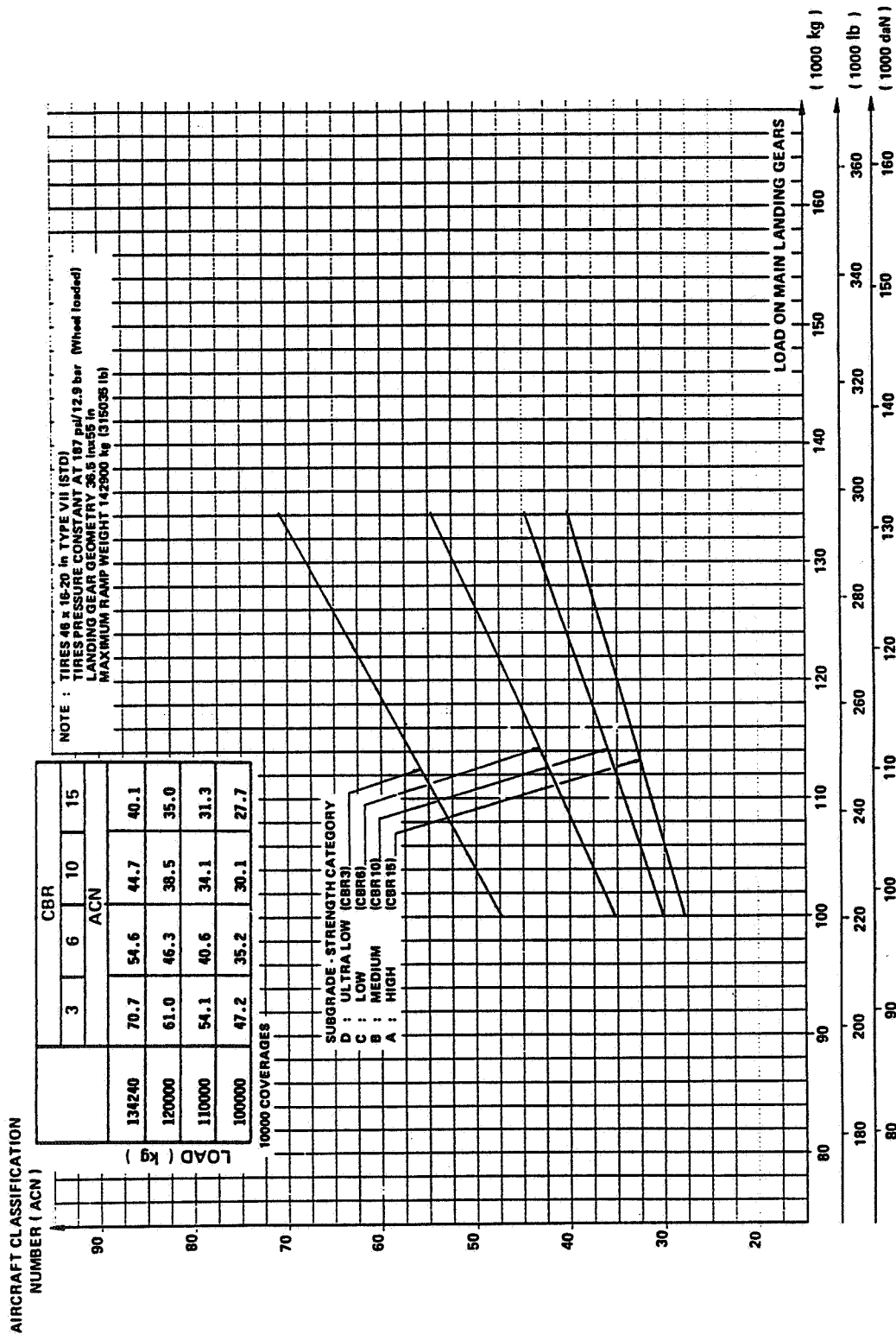

7.9.2.1 AIRCRAFT CLASSIFICATION NUMBER
 FLEXIBLE PAVEMENT - STANDARD TIRES
 MODEL B2K-142t

AIRBUS INDUSTRIE
A 300
 AIRPLANE CHARACTERISTICS

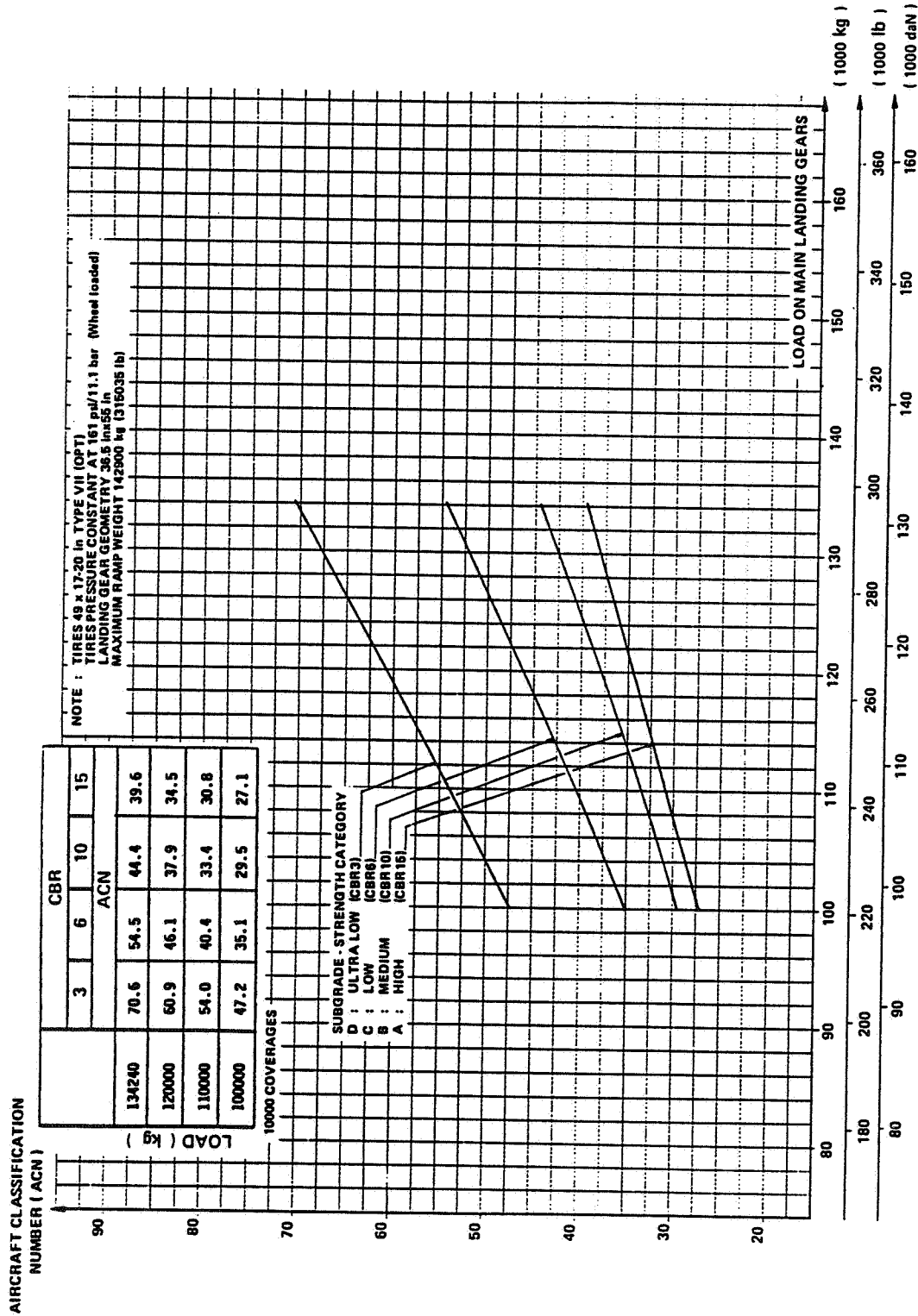

7.9.2.2 AIRCRAFT CLASSIFICATION NUMBER
 FLEXIBLE PAVEMENT - OPTIONAL TIRES
 MODEL B2K-142t

A 300
AIRPLANE CHARACTERISTICS

Printed in France

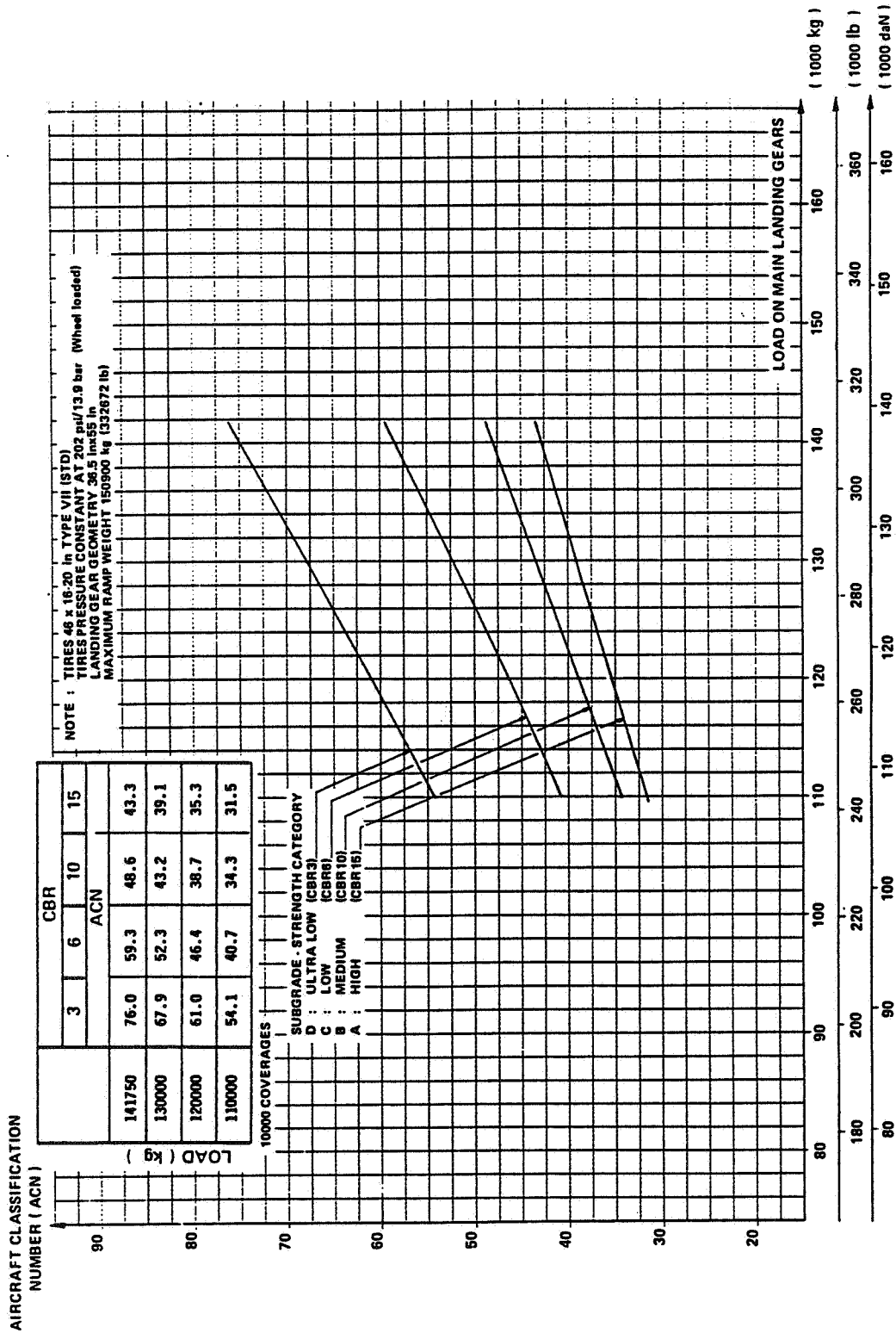

7.9.3.1 AIRCRAFT CLASSIFICATION NUMBER
FLEXIBLE PAVEMENT - STANDARD TIRES
MODEL B4-150t

AIRBUS INDUSTRIE
A 300
 AIRPLANE CHARACTERISTICS

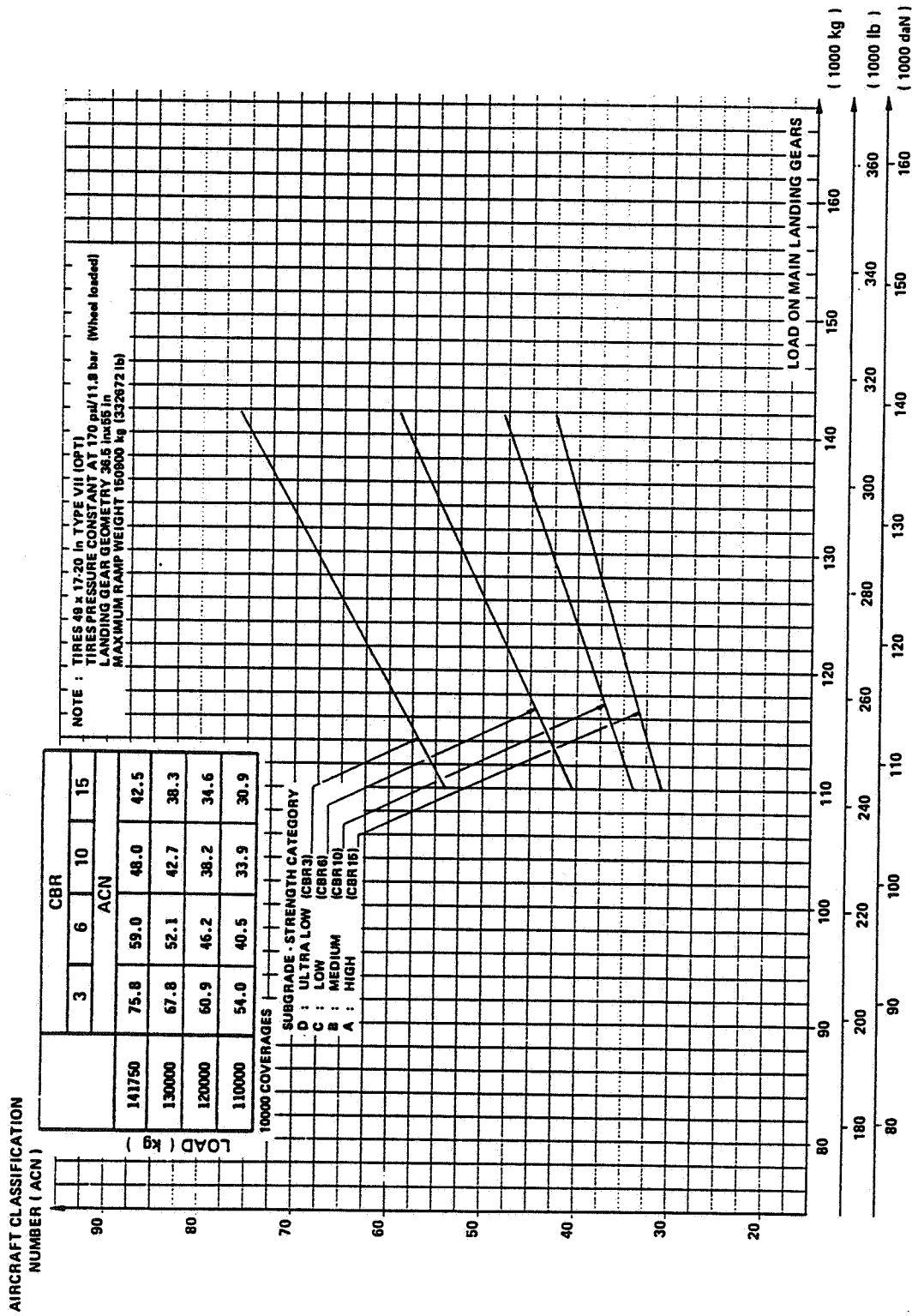

7.9.3.2 AIRCRAFT CLASSIFICATION NUMBER
 FLEXIBLE PAVEMENT - OPTIONAL TIRES
 MODEL B4-150t

AIRBUS INDUSTRIE
A 300
 AIRPLANE CHARACTERISTICS

Printed in France

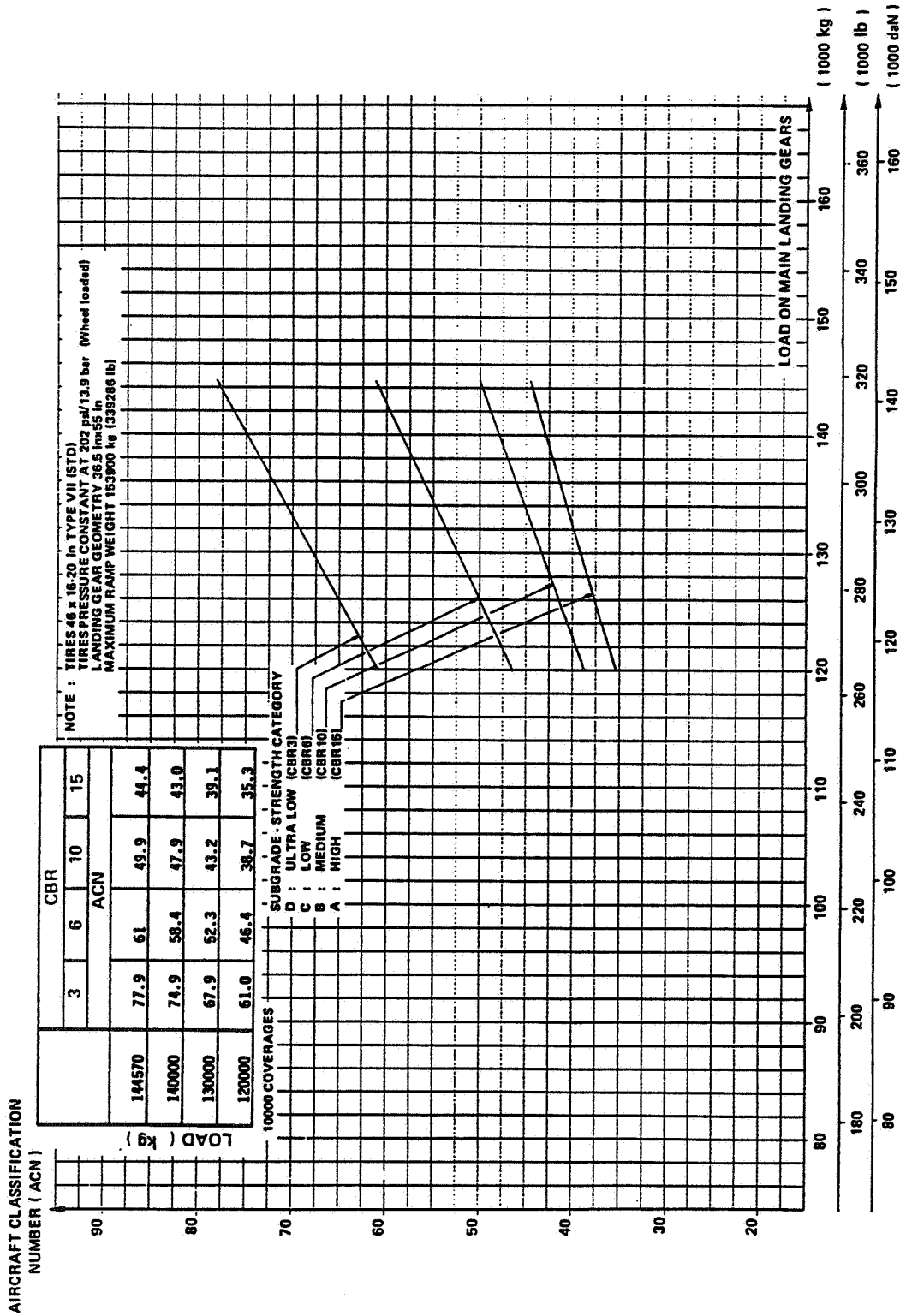

7.9.3.3 AIRCRAFT CLASSIFICATION NUMBER
 FLEXIBLE PAVEMENT - STANDARD TIRES
 MODEL B4-153t

AIRBUS INDUSTRIE
A 300
 AIRPLANE CHARACTERISTICS

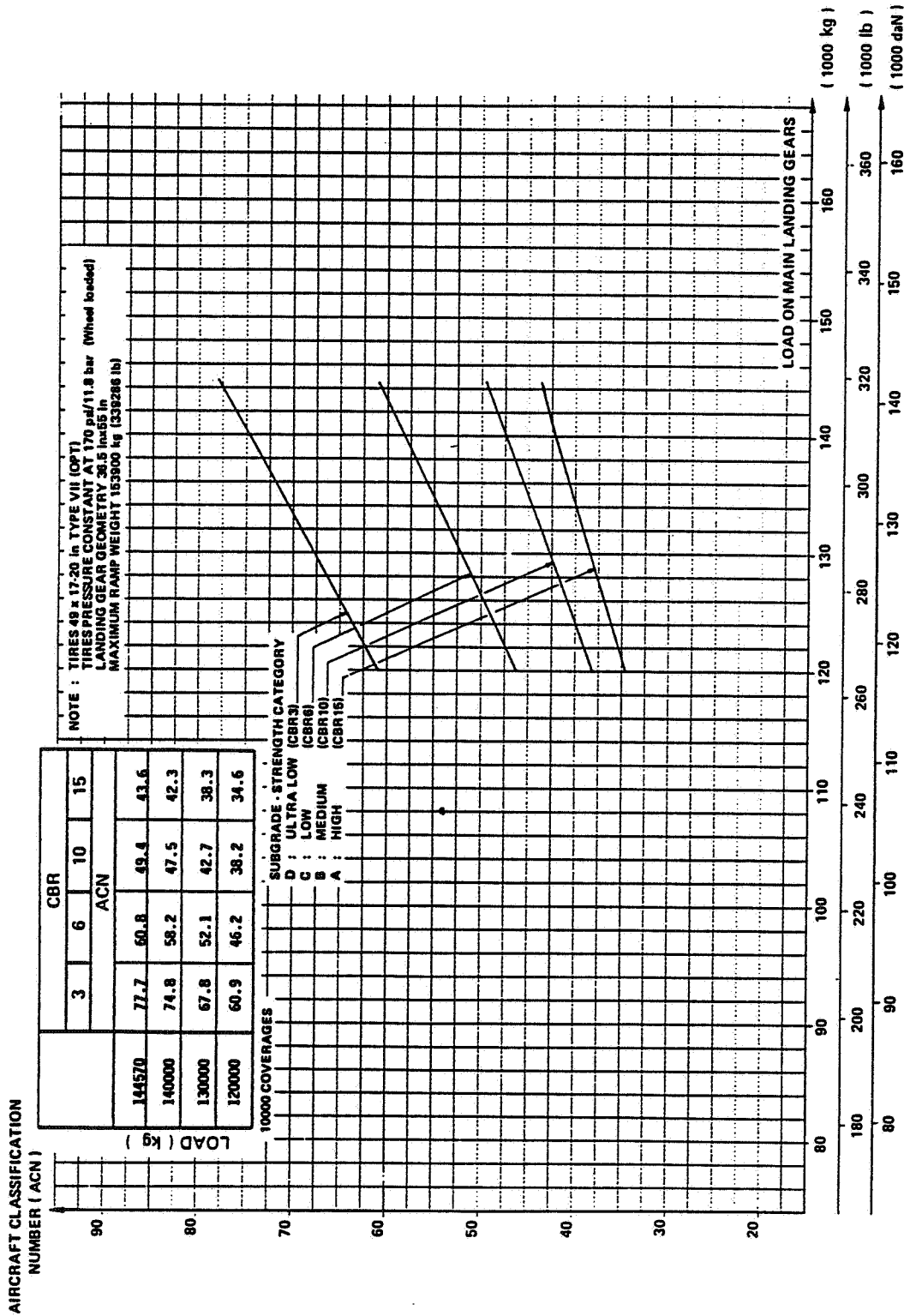

7.9.3.4 AIRCRAFT CLASSIFICATION NUMBER
 FLEXIBLE PAVEMENT - OPTIONAL TIRES
 MODEL B4-153t

A 300
AIRPLANE CHARACTERISTICS

Printed in France

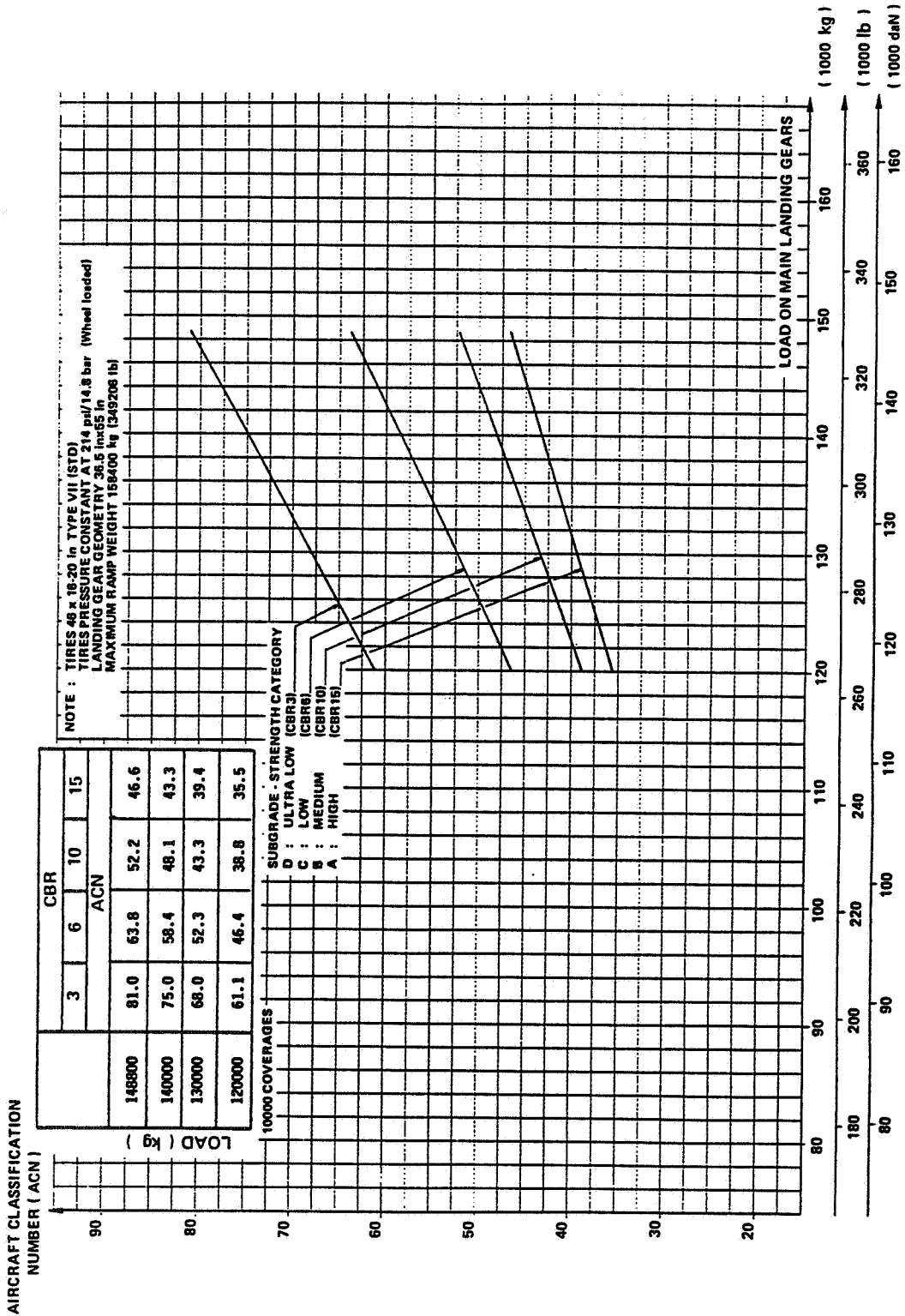

7.9.3.5 AIRCRAFT CLASSIFICATION NUMBER
FLEXIBLE PAVEMENT - STANDARD TIRES
MODEL B4-157.5t

A 300
AIRPLANE CHARACTERISTICS

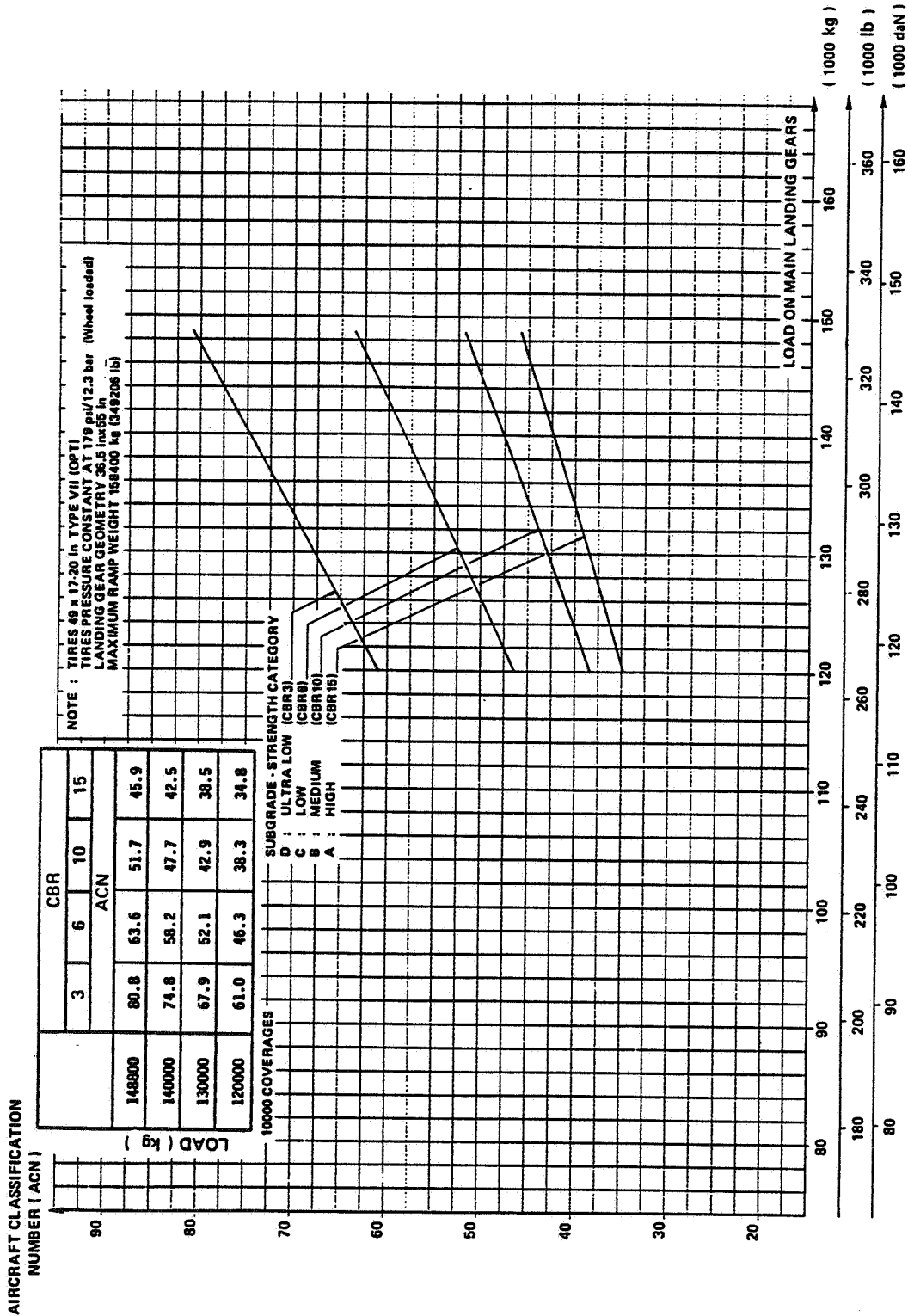

7.9.3.6 AIRCRAFT CLASSIFICATION NUMBER
FLEXIBLE PAVEMENT - OPTIONAL TIRES
MODEL B4-157.5t

AIRBUS INDUSTRIE
A 300
 AIRPLANE CHARACTERISTICS

Printed in France

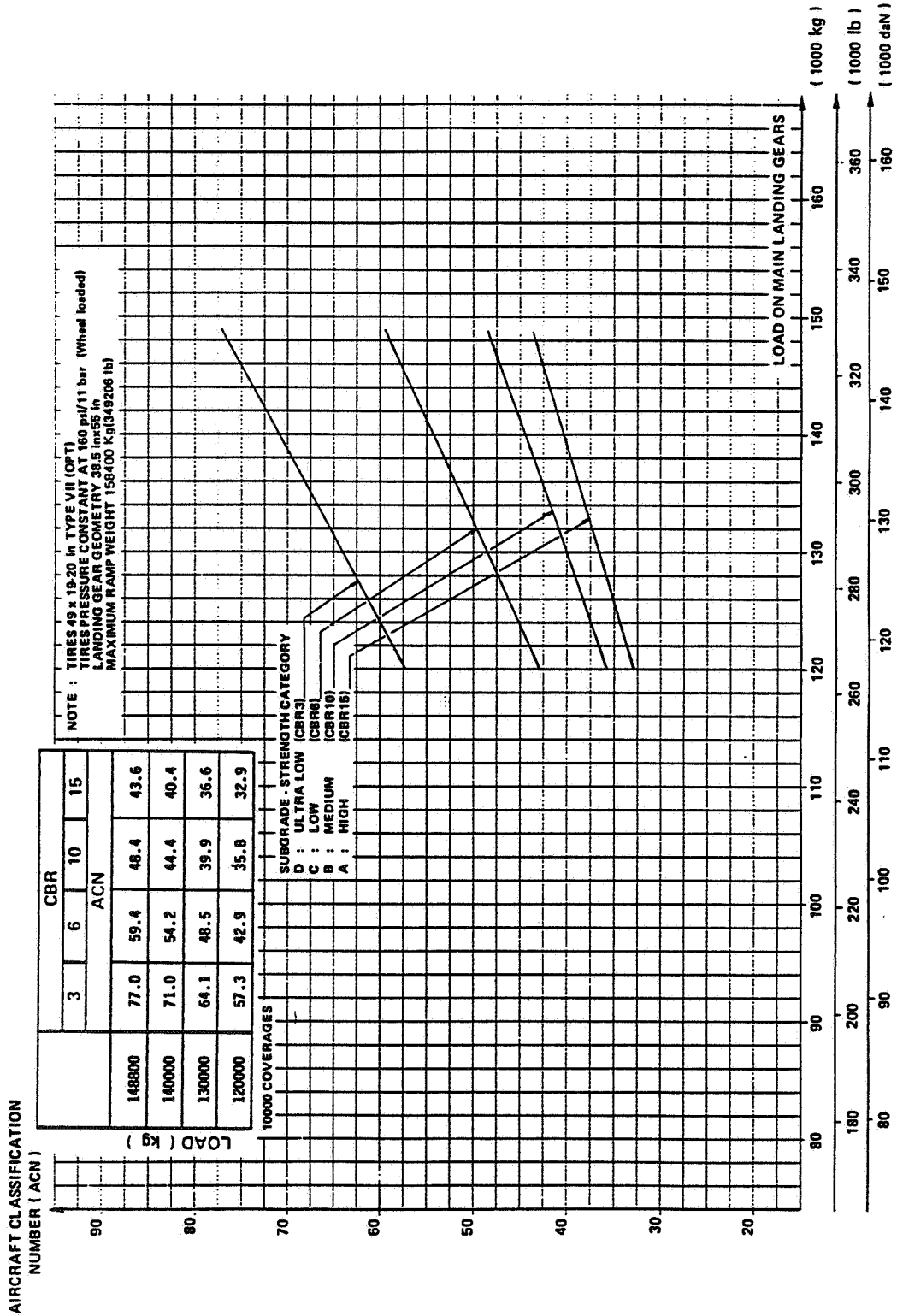

7.9.3.7 AIRCRAFT CLASSIFICATION NUMBER
 FLEXIBLE PAVEMENT - OPTIONAL TIRES
 MODEL B4-157.5t

AIRBUS  INDUSTRIE
A 300
AIRPLANE CHARACTERISTICS

Printed in France

THIS PAGE LEFT BLANK INTENTIONALLY

A 300
AIRPLANE CHARACTERISTICS

Printed in France

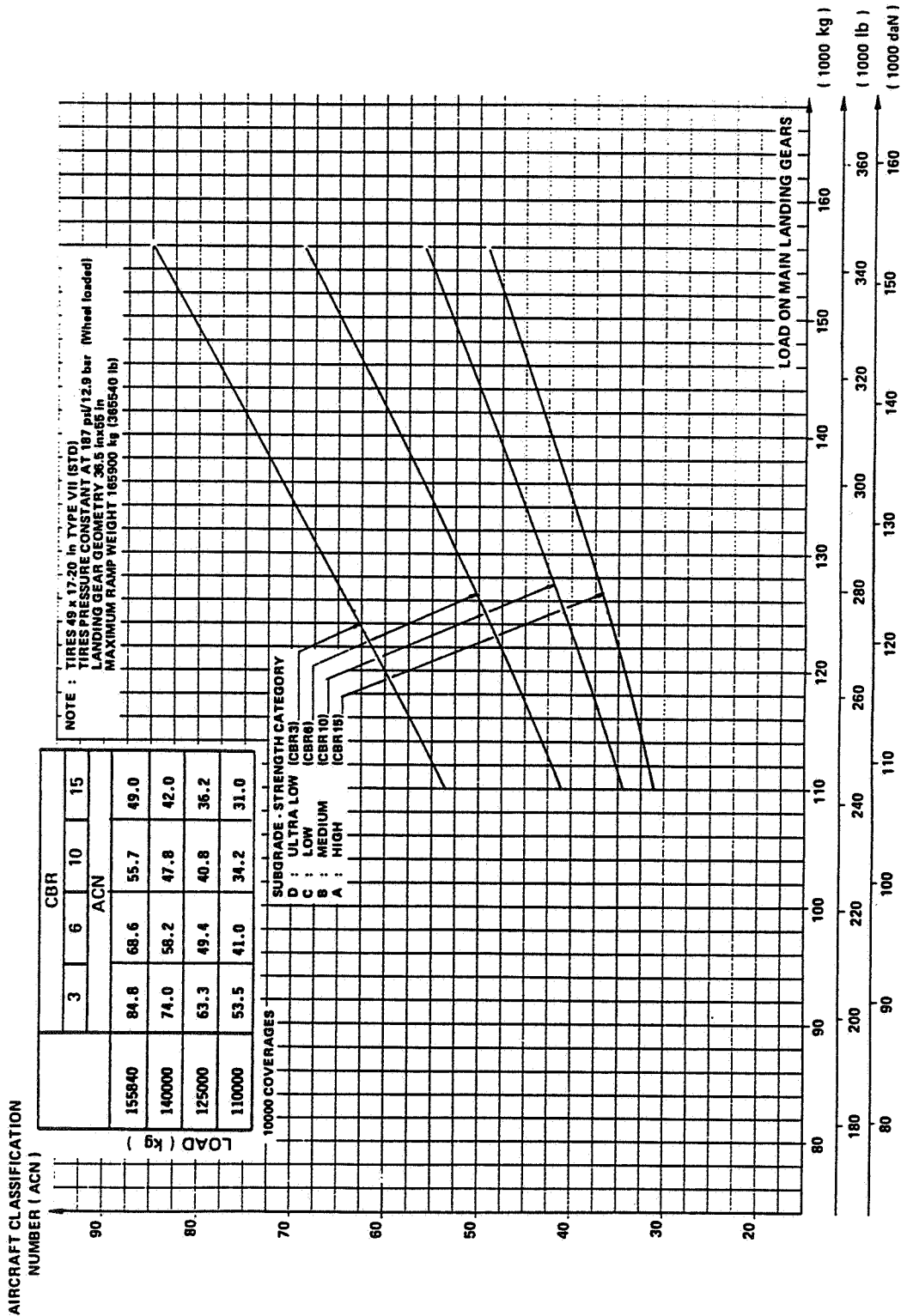

7.9.3.9 AIRCRAFT CLASSIFICATION NUMBER
FLEXIBLE PAVEMENT - STANDARD TIRES
MODEL B4 - C4 - 165t

AIRBUS INDUSTRIE
A 300
 AIRPLANE CHARACTERISTICS

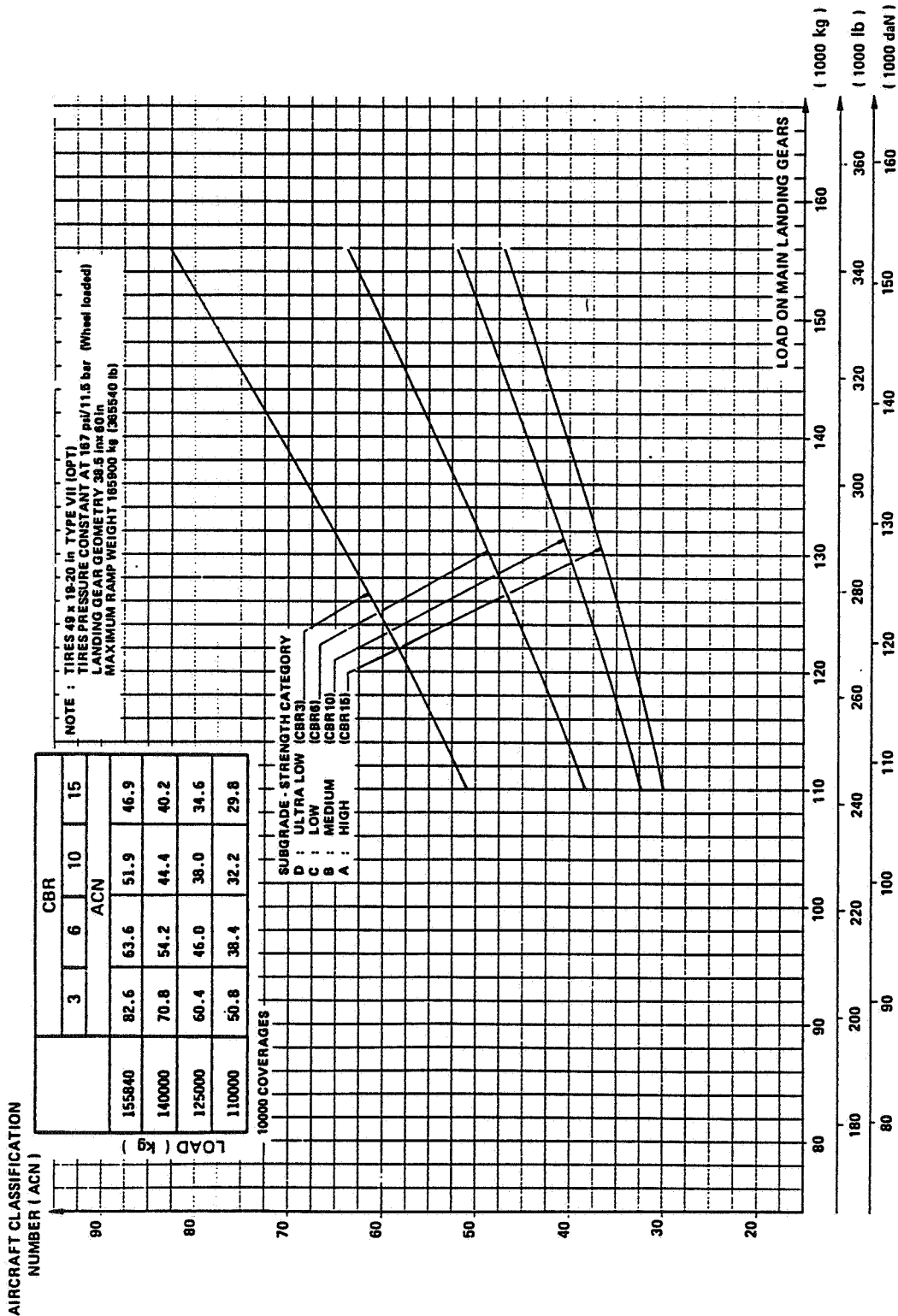

7.9.3.10 AIRCRAFT CLASSIFICATION NUMBER
 FLEXIBLE PAVEMENT - OPTIONAL TIRES
 MODEL B4 - C4 - 165t

AIRBUS INDUSTRIE
A 300
 AIRPLANE CHARACTERISTICS

Printed in France

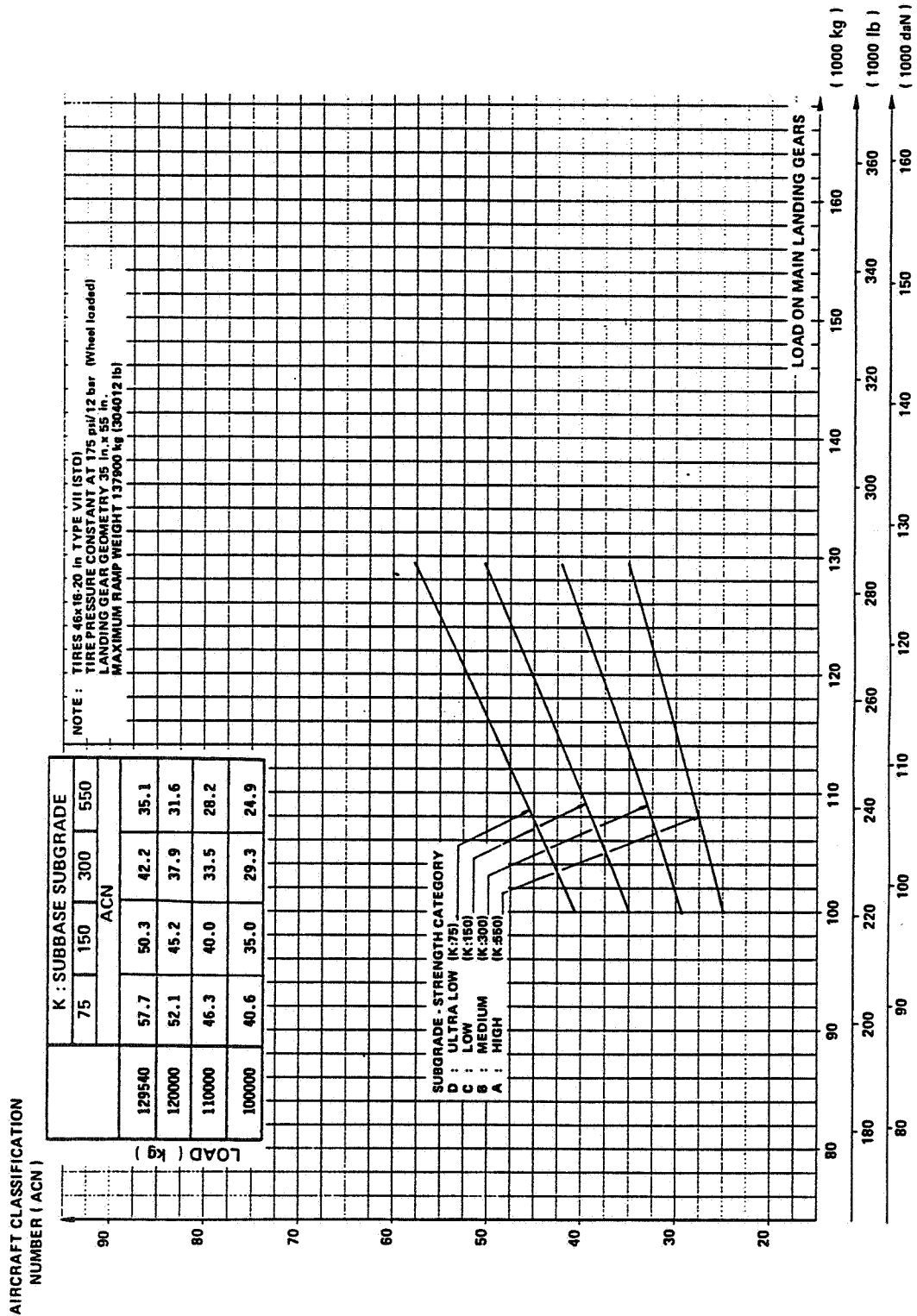

7.9.4.1 AIRCRAFT CLASSIFICATION NUMBER
 RIGID PAVEMENT - STANDARD TIRES
 MODEL B2-137t

AIRBUS  INDUSTRIE
A 300
AIRPLANE CHARACTERISTICS

Printed in France

THIS PAGE LEFT BLANK INTENTIONALLY

AIRBUS INDUSTRIE
A 300
 AIRPLANE CHARACTERISTICS

Printed in France

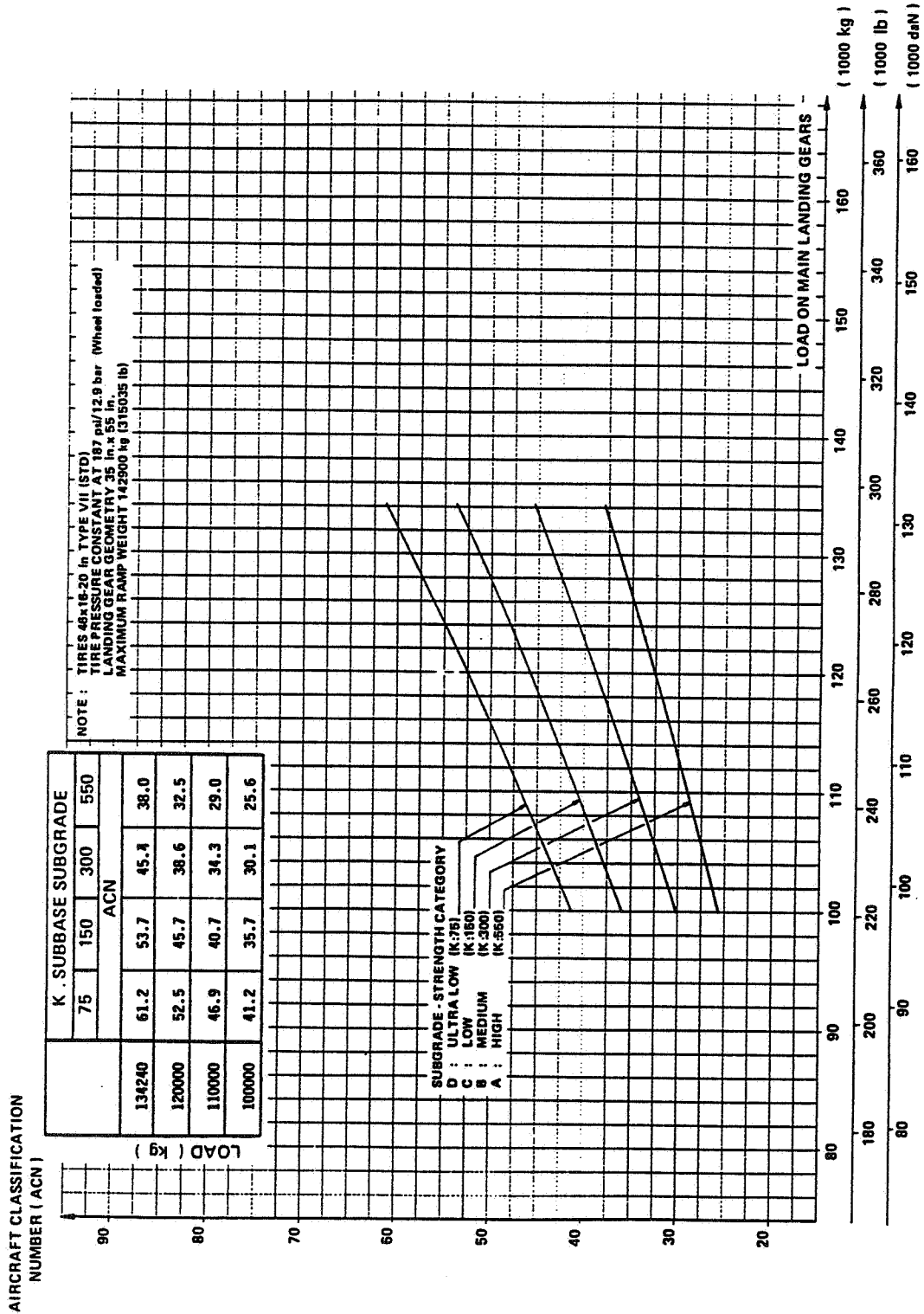

7.9.4.3 AIRCRAFT CLASSIFICATION NUMBER
 RIGID PAVEMENT - STANDARD TIRES
 MODEL B2-142t

AIRBUS INDUSTRIE
A 300
 AIRPLANE CHARACTERISTICS

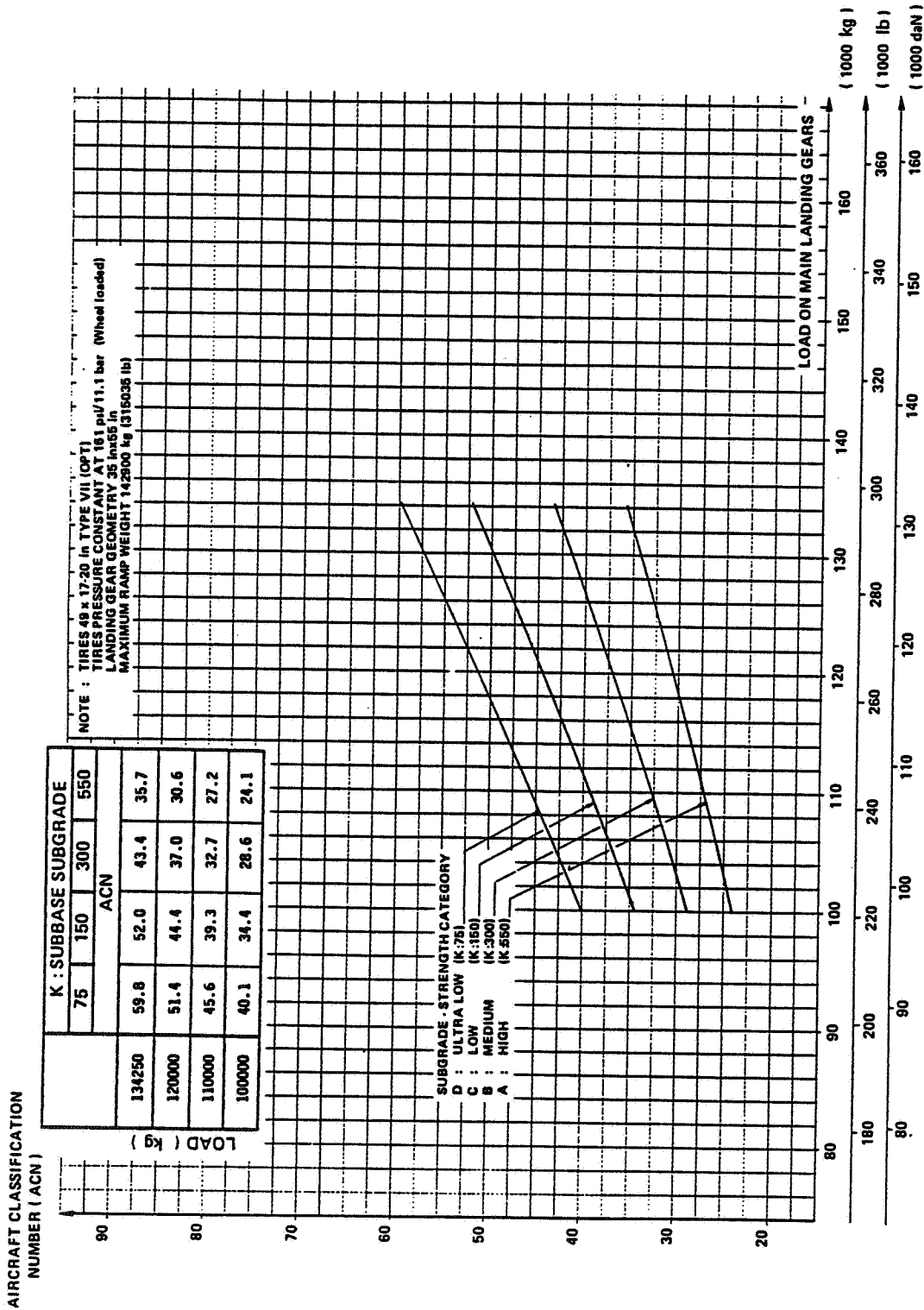

7.9.4.4 AIRCRAFT CLASSIFICATION NUMBER
 RIGID PAVEMENT - OPTIONAL TIRES
 MODEL B2-142t

AIRBUS INDUSTRIE
A 300
 AIRPLANE CHARACTERISTICS

Printed in France

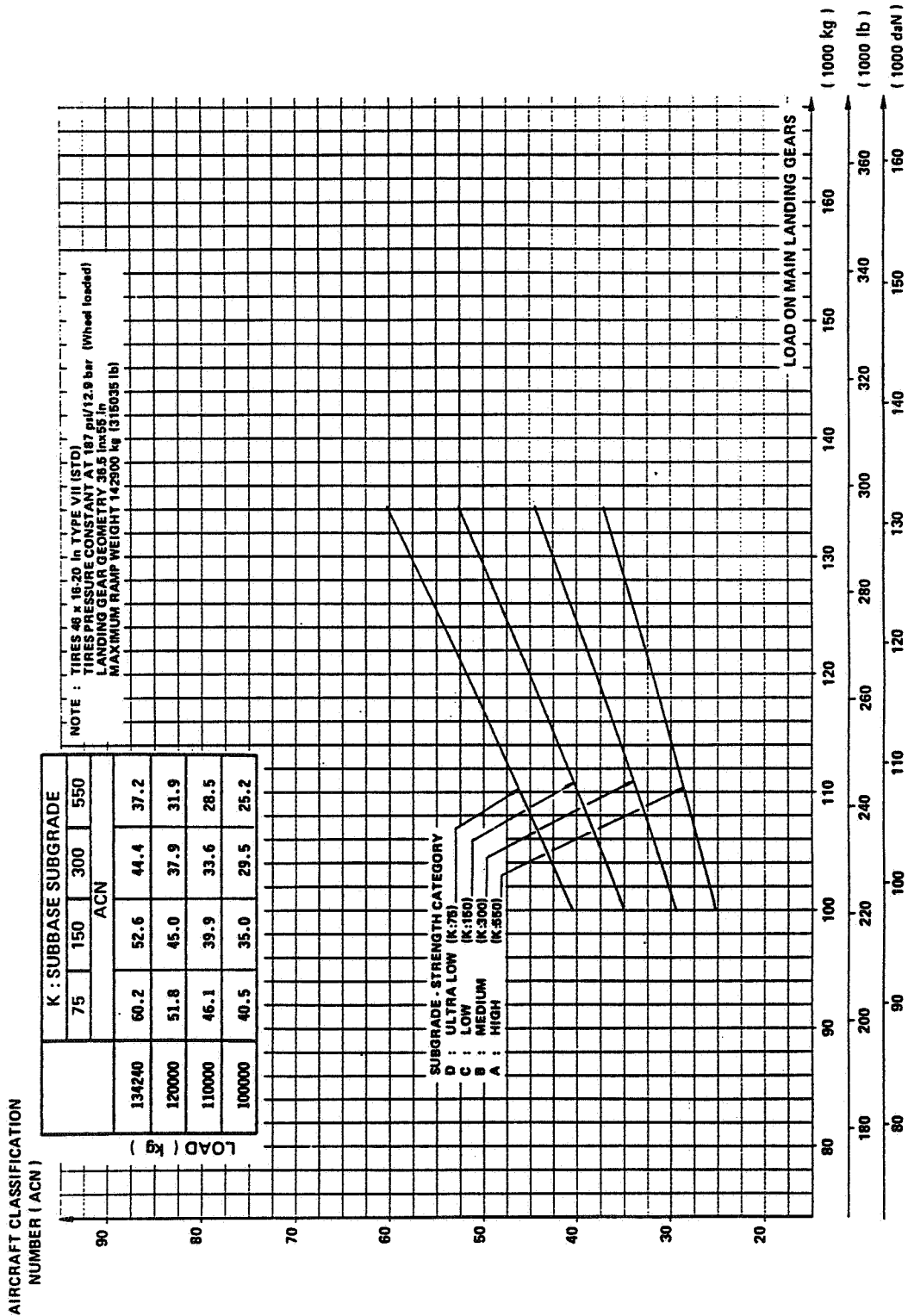

7.9.5.1 AIRCRAFT CLASSIFICATION NUMBER
 RIGID PAVEMENT - STANDARD TIRES
 MODEL B2K-142t

AIRBUS  INDUSTRIE
A 300
 AIRPLANE CHARACTERISTICS

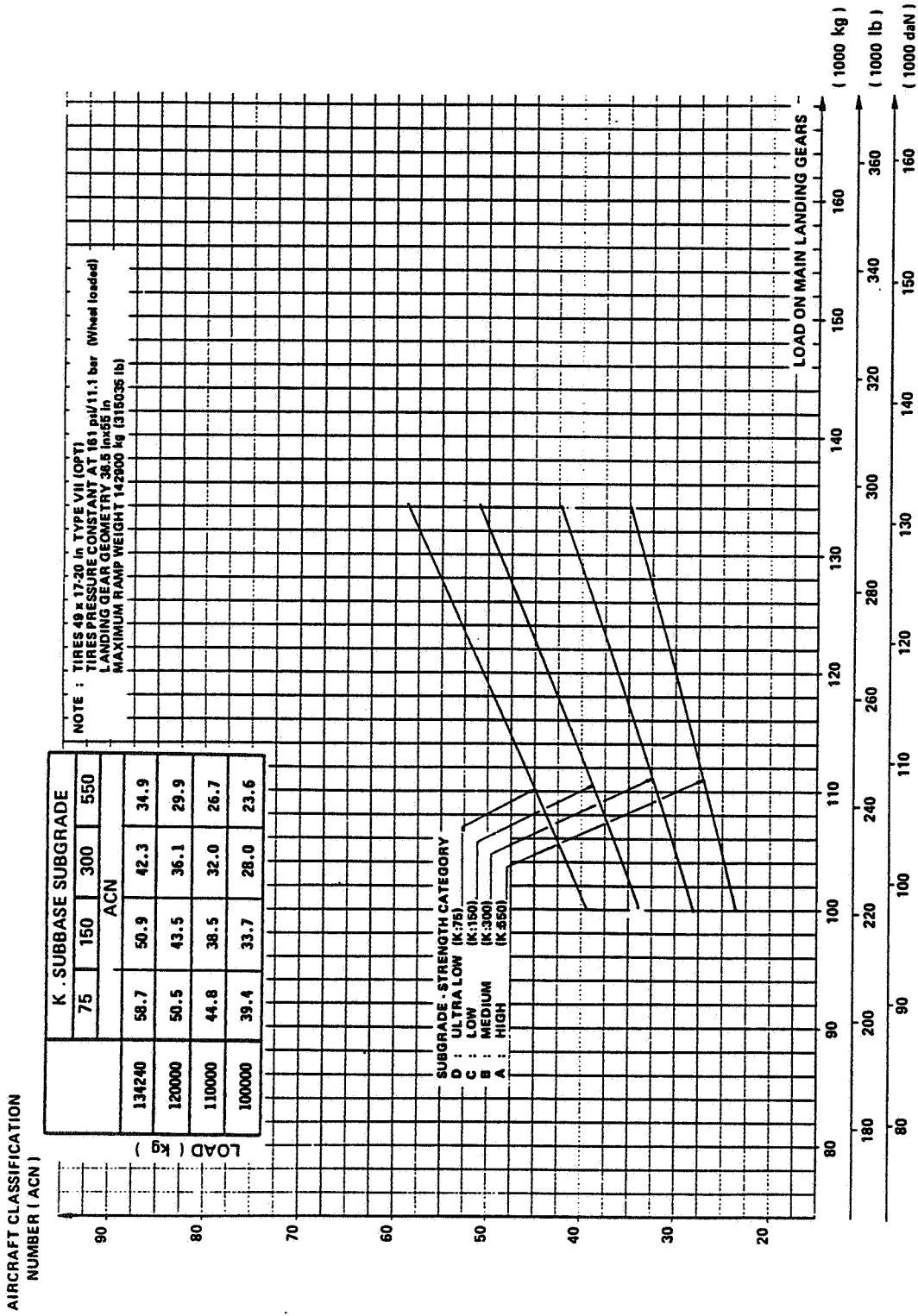

7.9.5.2 AIRCRAFT CLASSIFICATION NUMBER
 RIGID PAVEMENT - OPTIONAL TIRES
 MODEL B2K - 142t

AIRBUS INDUSTRIE
A 300
 AIRPLANE CHARACTERISTICS

Printed in France

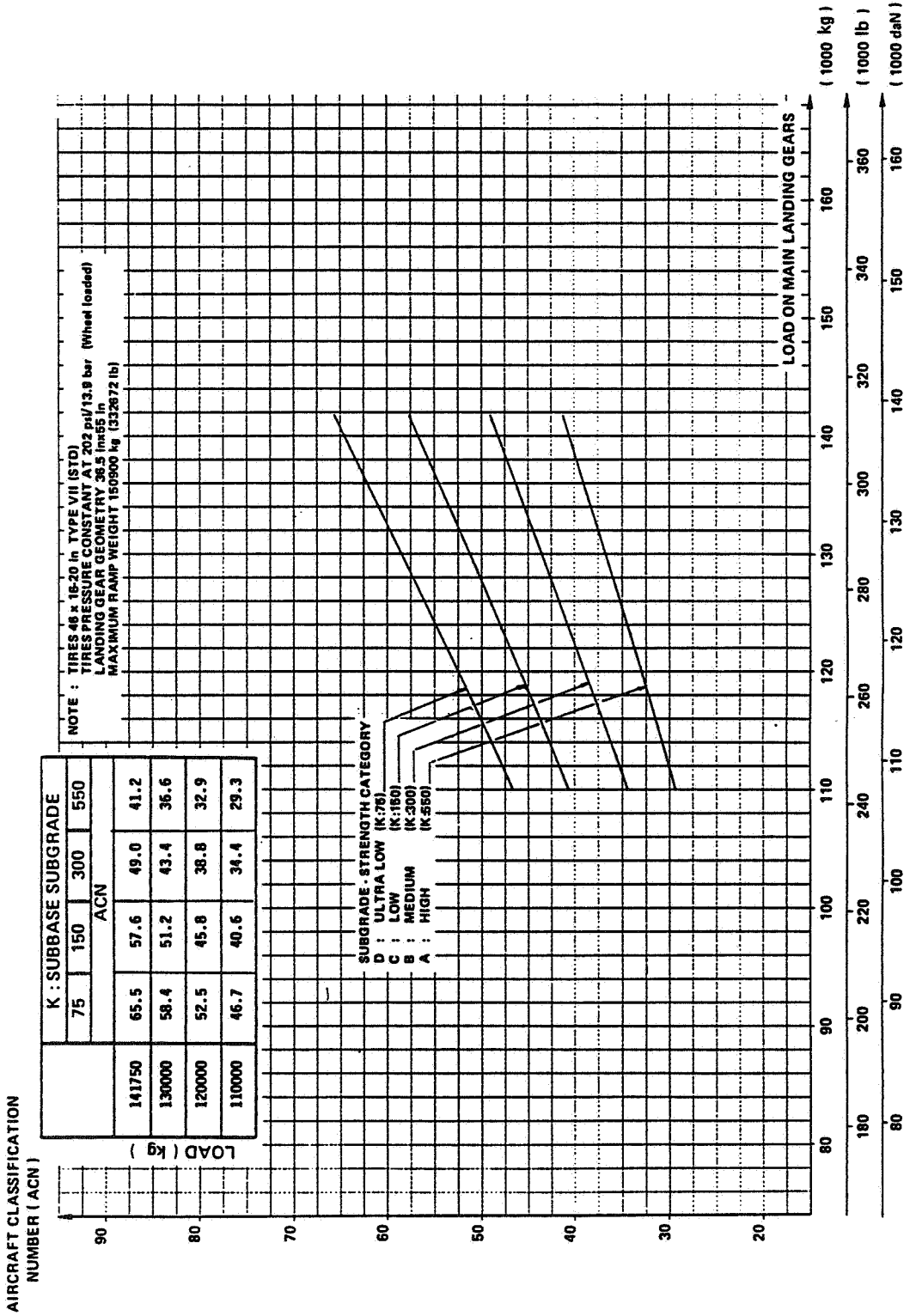

7.9.6.1 AIRCRAFT CLASSIFICATION NUMBER
 RIGID PAVEMENT - STANDARD TIRES
 MODEL B4-150t

AIRBUS INDUSTRIE
A 300
AIRPLANE CHARACTERISTICS

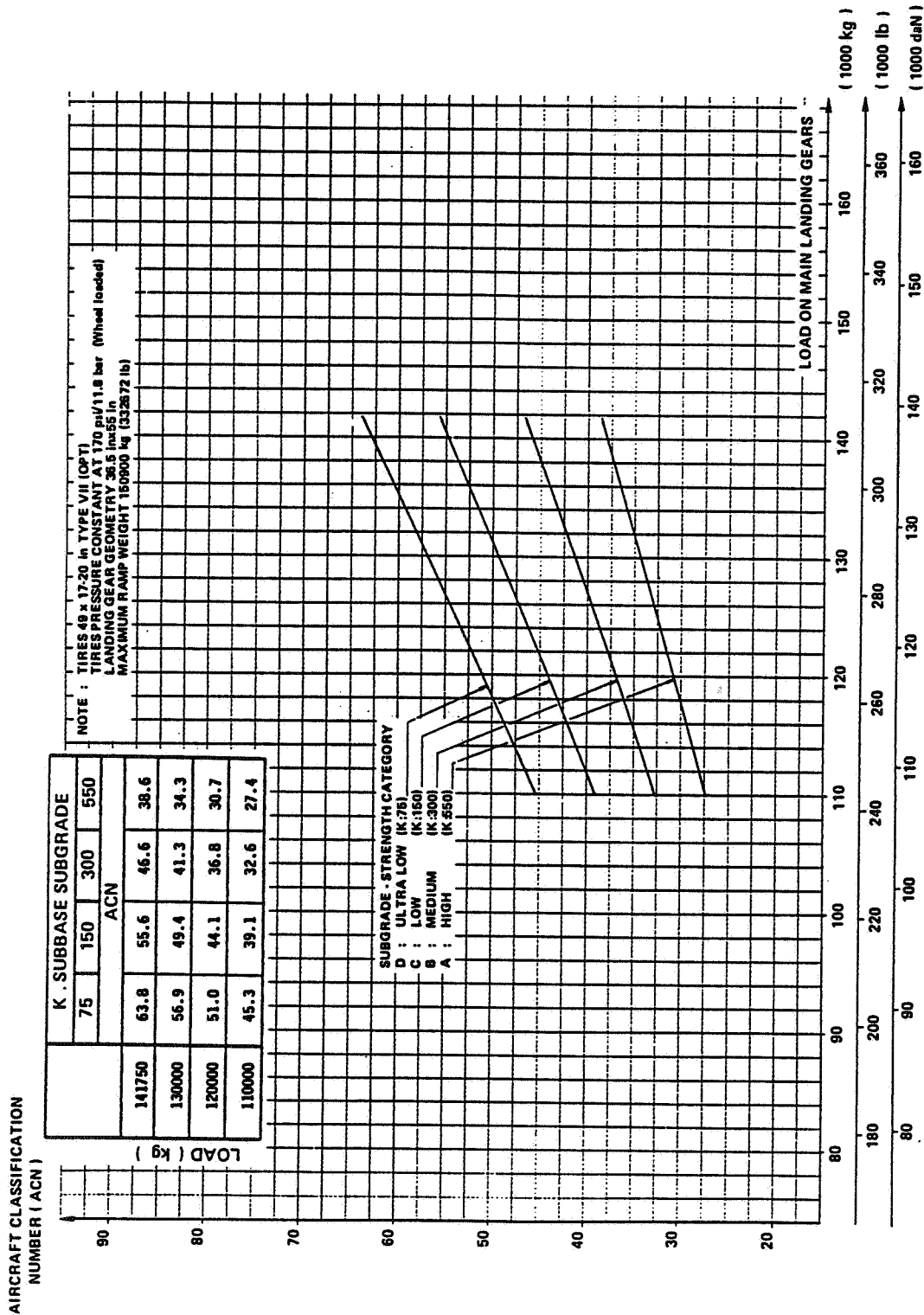

7.9.6.2 AIRCRAFT CLASSIFICATION NUMBER
RIGID PAVEMENT - OPTIONAL TIRES
MODEL B4-150t

AIRBUS INDUSTRIE
A 300
 AIRPLANE CHARACTERISTICS

Printed in France

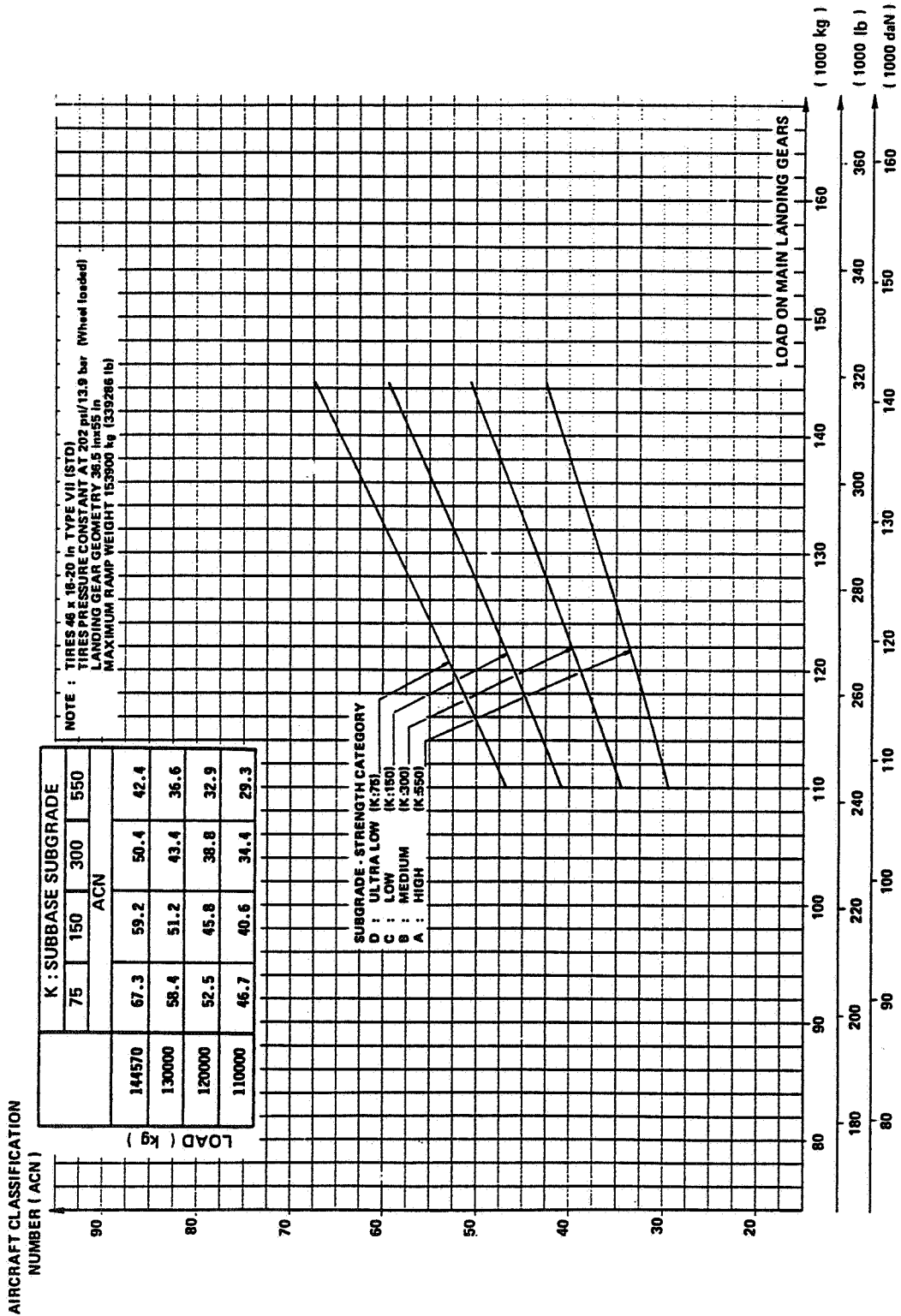

7.9.6.3 AIRCRAFT CLASSIFICATION NUMBER
 RIGID PAVEMENT - STANDARD TIRES
 MODEL B4 - 153t

A 300

AIRPLANE CHARACTERISTICS

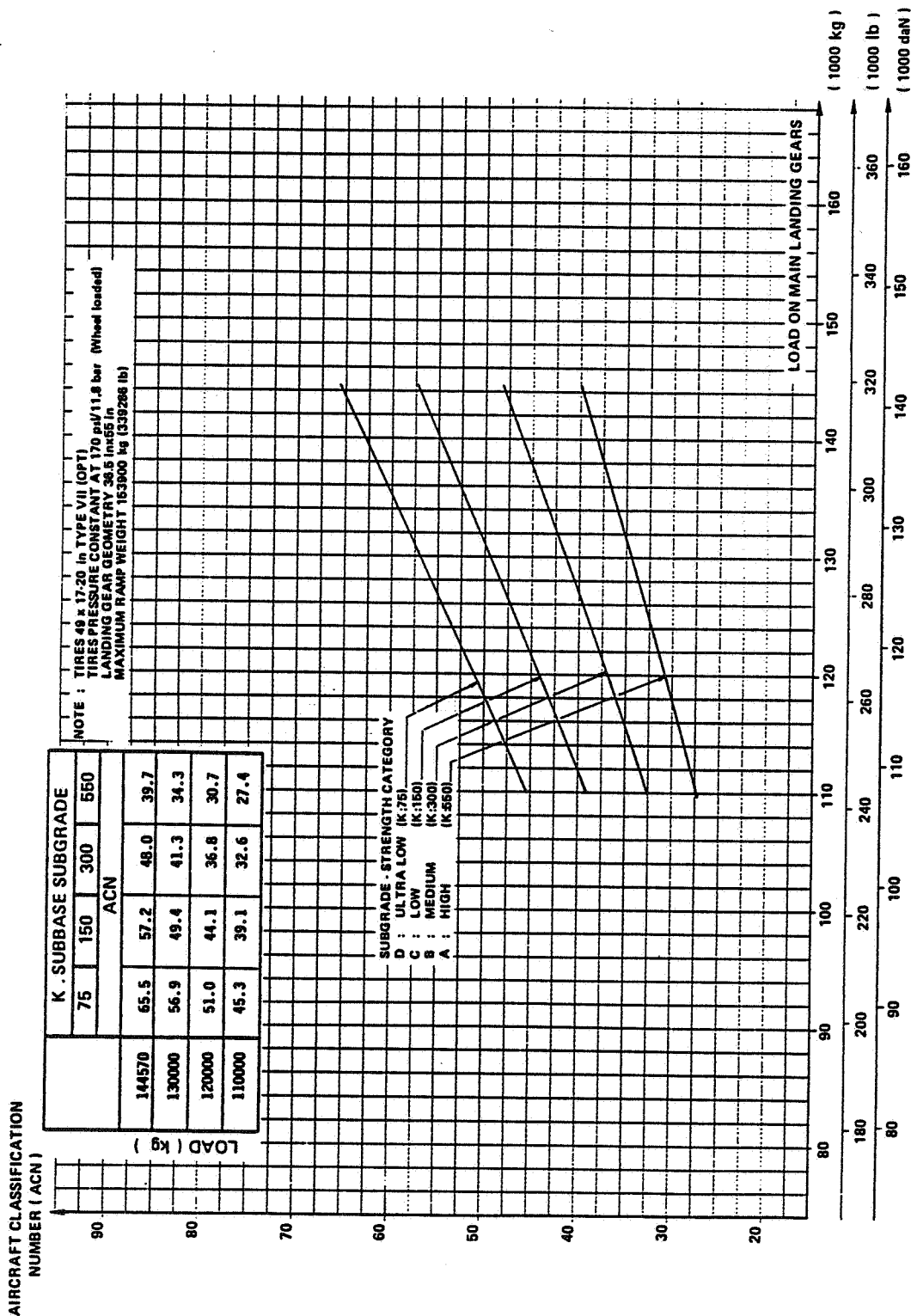

7.9.6.4 AIRCRAFT CLASSIFICATION NUMBER
 RIGID PAVEMENT - OPTIONAL TIRES
 MODEL B4-153t

AIRBUS INDUSTRIE
A 300
 AIRPLANE CHARACTERISTICS

Printed in France

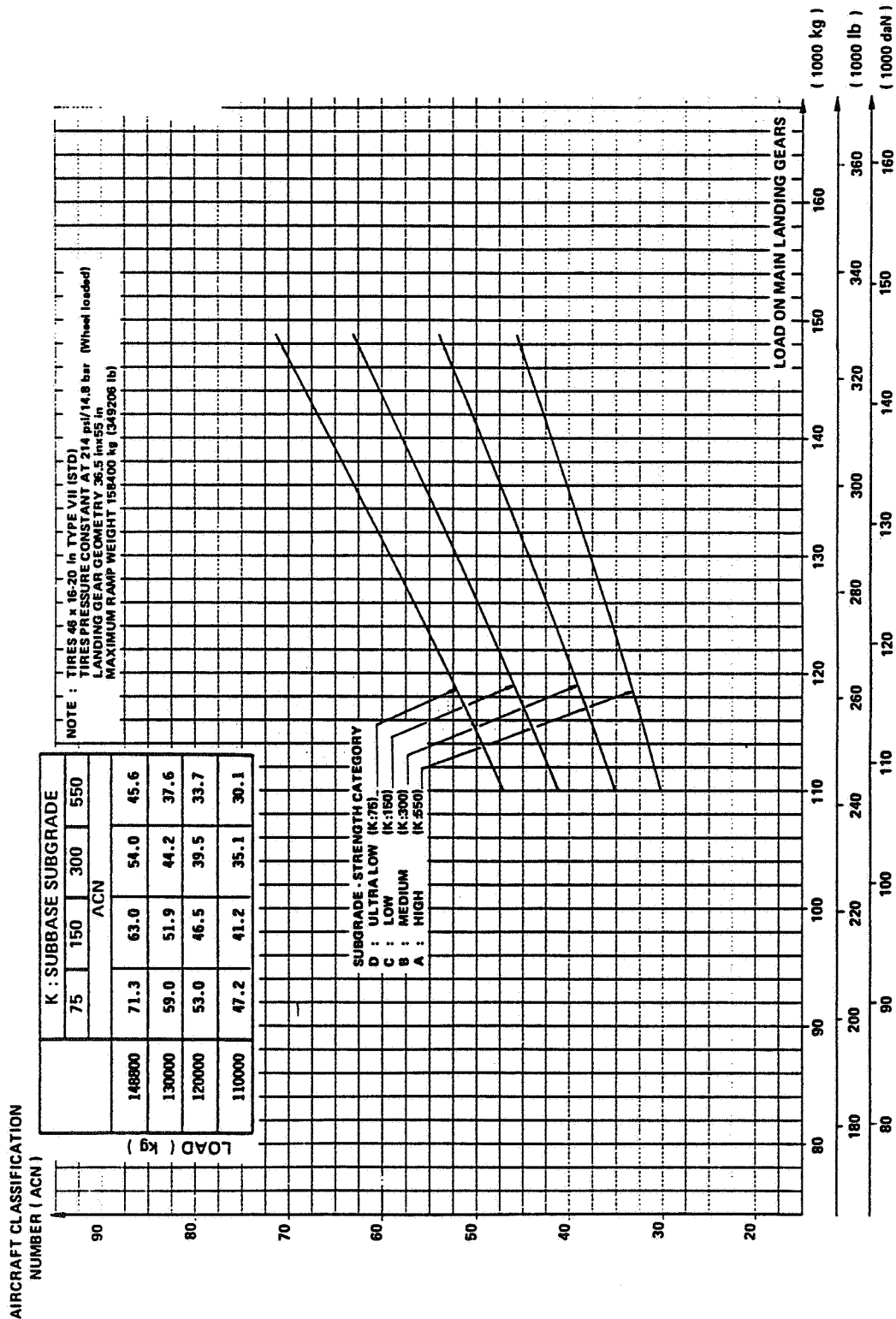

7.9.6.5 AIRCRAFT CLASSIFICATION NUMBER
 RIGID PAVEMENT - STANDARD TIRES
 MODEL B4-157.5t

A 300
AIRPLANE CHARACTERISTICS

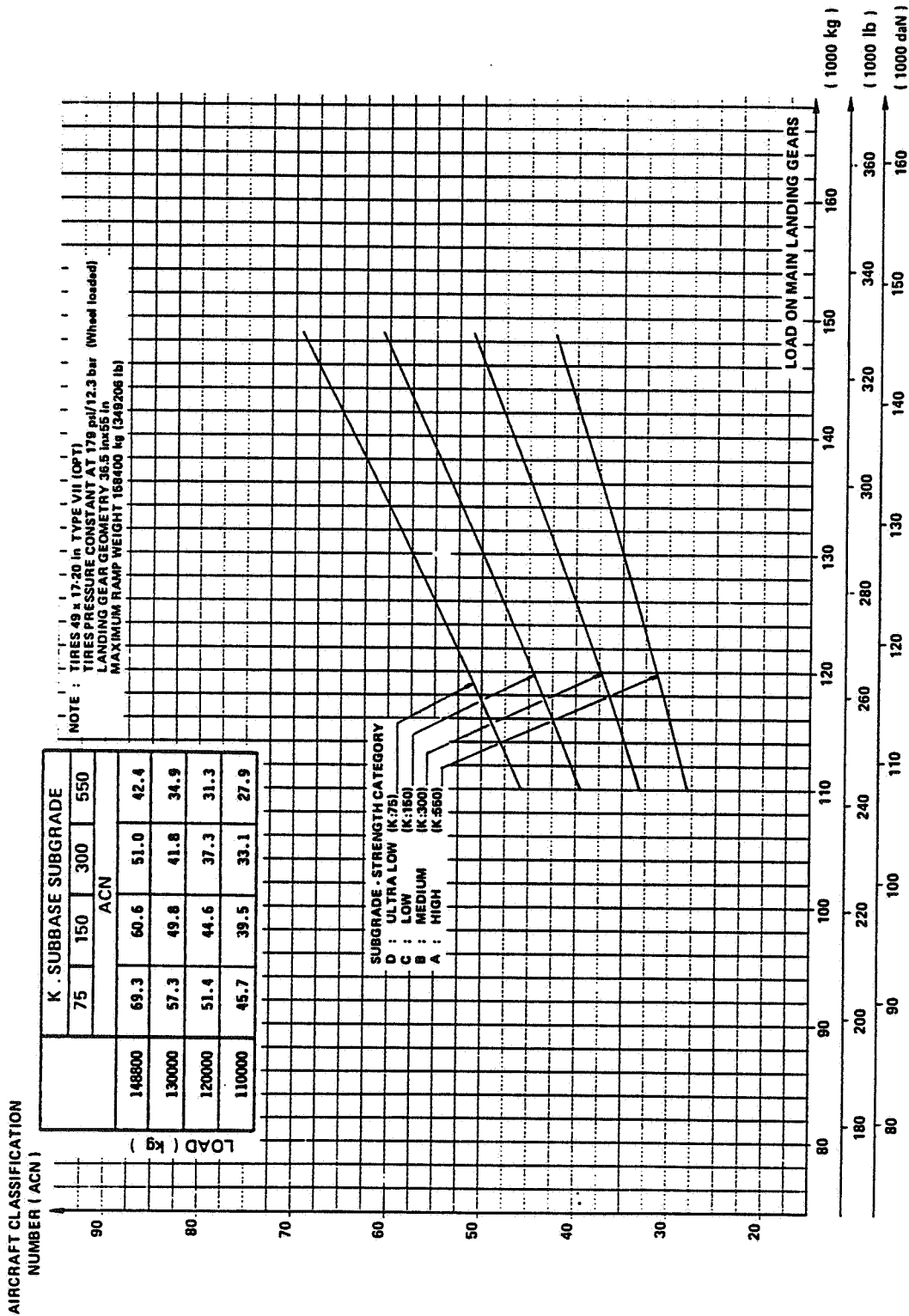

7.9.6.6 AIRCRAFT CLASSIFICATION NUMBER
RIGID PAVEMENT - OPTIONAL TIRES
MODEL B4-157.5t

Printed in France

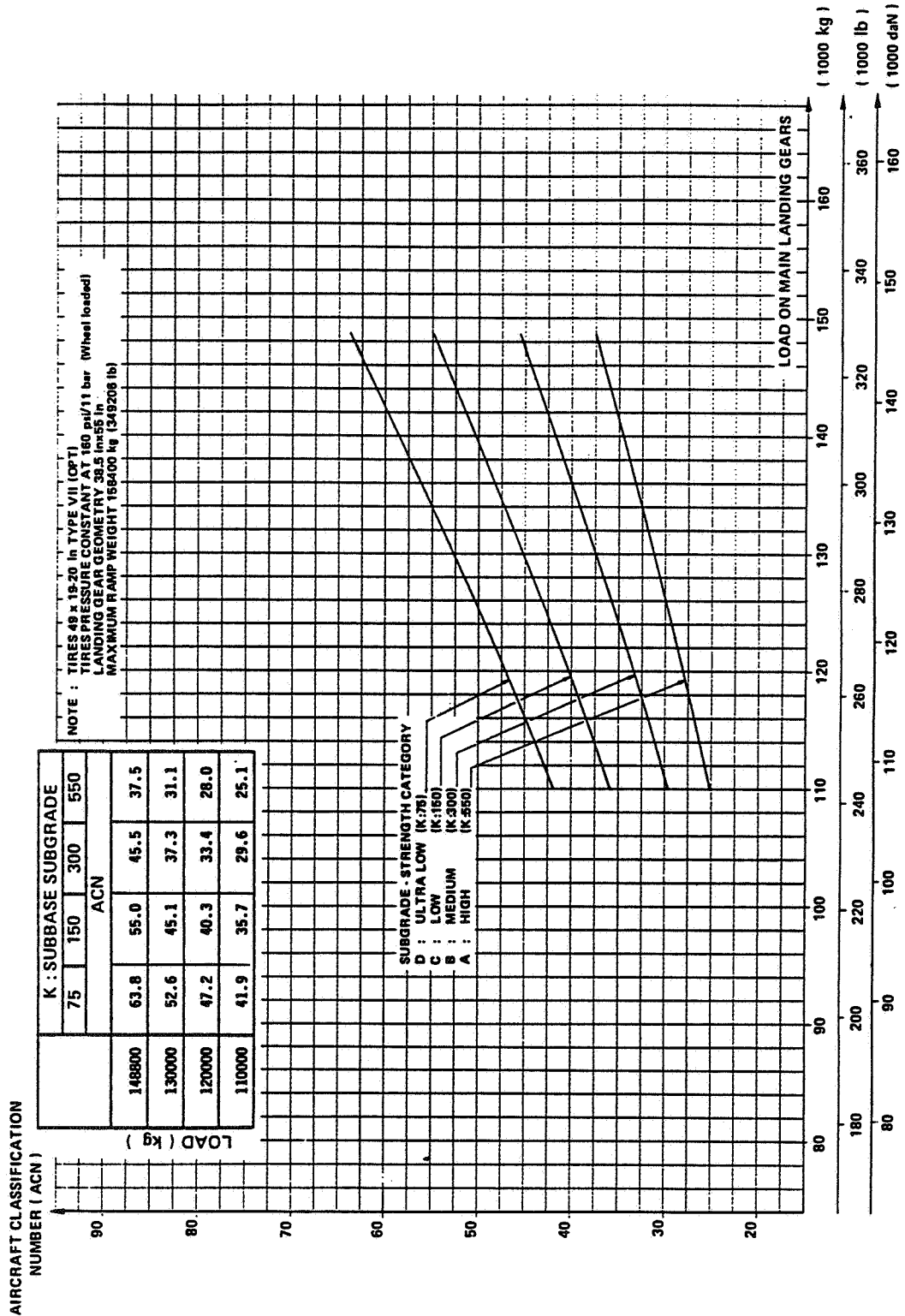

7.9.6.7 AIRCRAFT CLASSIFICATION NUMBER
 RIGID PAVEMENT - OPTIONAL TIRES
 MODEL B4-157.5t

AIRBUS  INDUSTRIE
A 300
AIRPLANE CHARACTERISTICS

Printed in France

THIS PAGE LEFT BLANK INTENTIONALLY

AIRBUS INDUSTRIE
A 300
 AIRPLANE CHARACTERISTICS

Printed in France

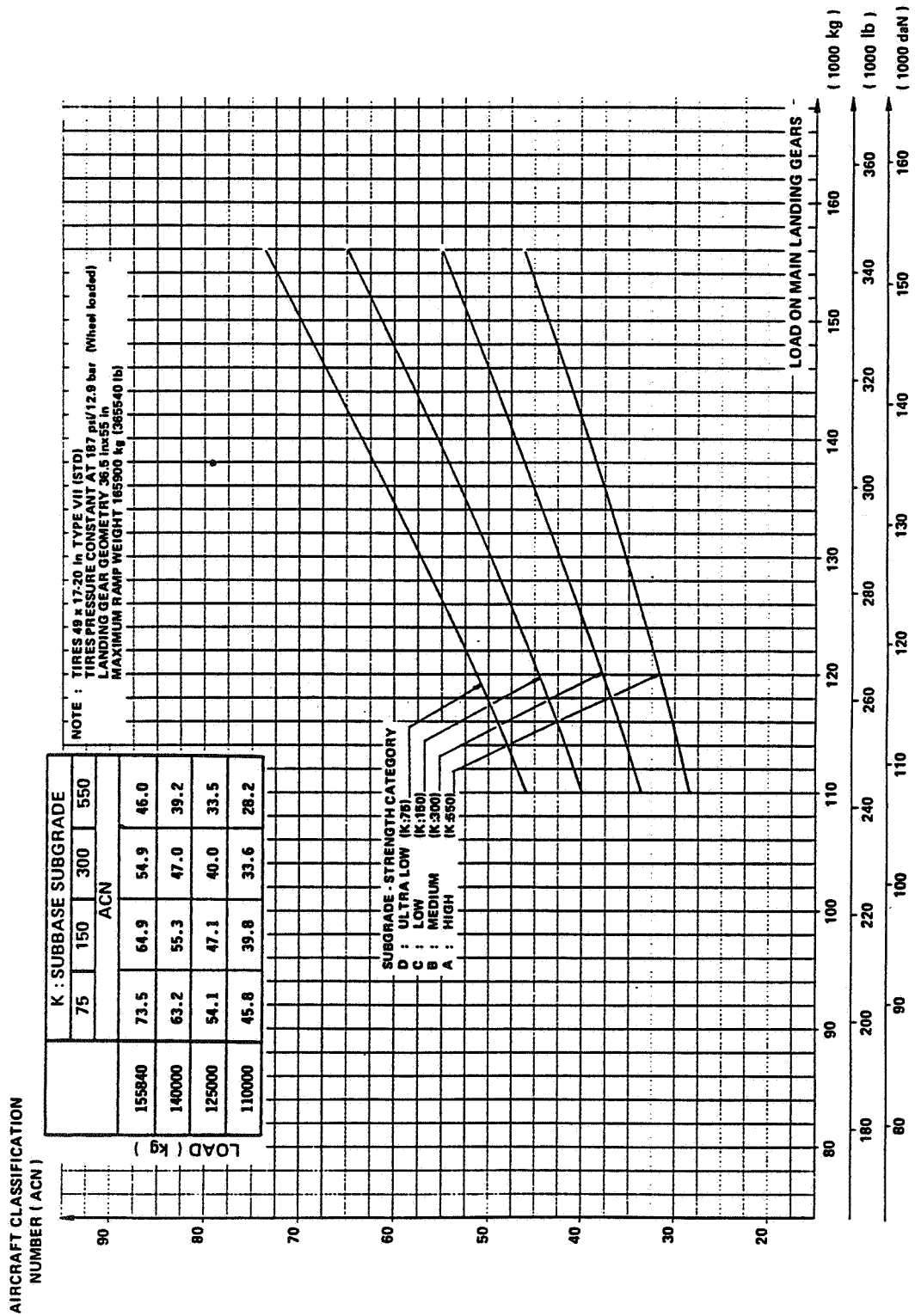

7.9.6.9 AIRCRAFT CLASSIFICATION NUMBER
 RIGID PAVEMENT - STANDARD TIRES
 MODEL B4 - C4 - 165t

A 300

AIRPLANE CHARACTERISTICS

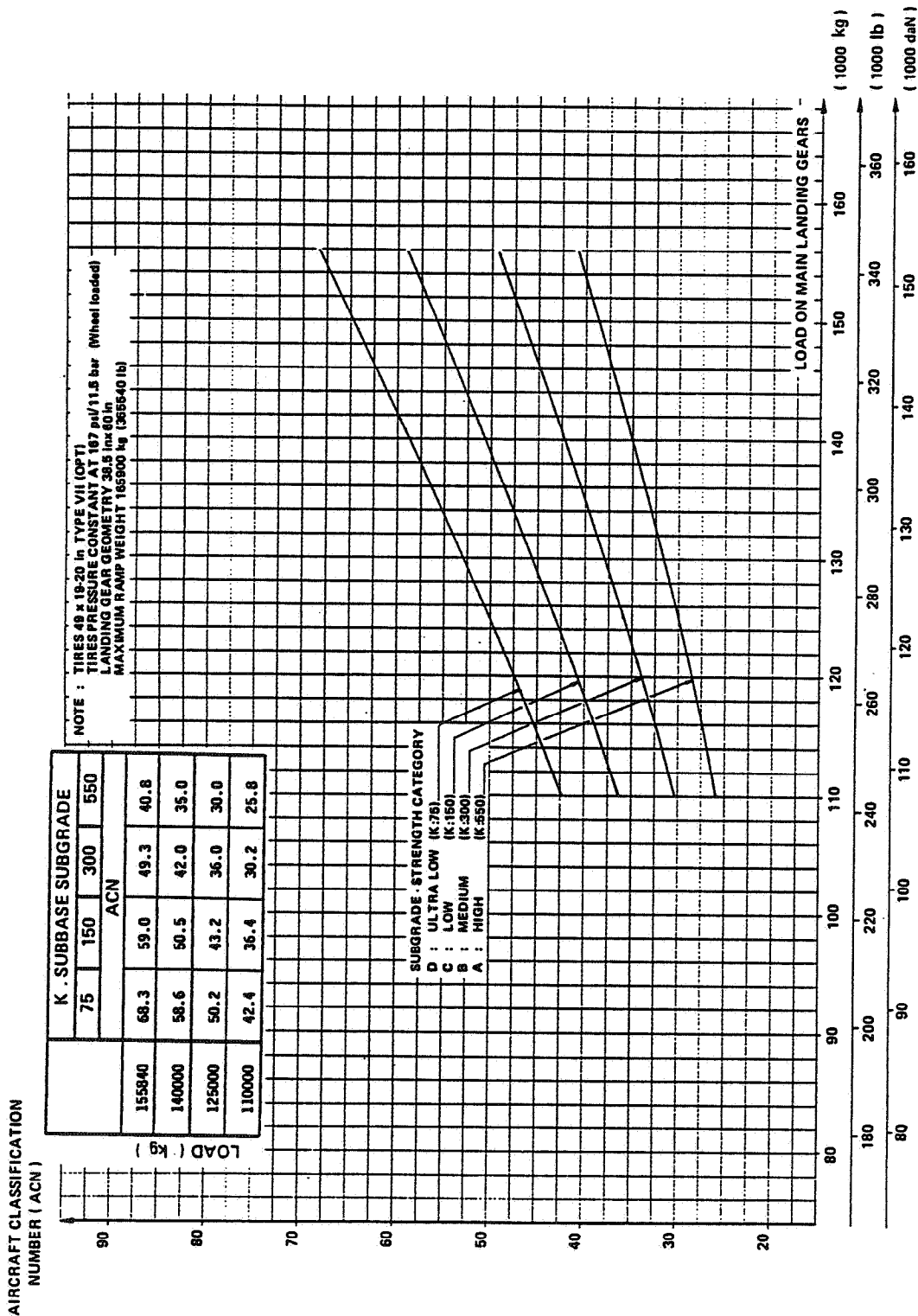

7.9.6.10 AIRCRAFT CLASSIFICATION NUMBER
RIGID PAVEMENT - OPTIONAL TIRES
MODEL B4 - C4 - 165t

A 300

AIRPLANE CHARACTERISTICS

7.9.7 Development of ACN Charts (for example)

The ACN charts for flexible and rigid pavements, as shown in Sections 7.9.1.1 to 7.9.3.10 thru 7.9.4.1 to 7.9.6.10 were developed by methods referenced in Amendment 35 to ICAO Annex 14. The procedures to develop these charts are also described below.

The following procedure is used to develop the flexible-pavement ACN charts, such as shown in Section 7.9.1.1.

1. Determine the percentage of weight on the main gear to be used below in steps 2, 3, and 4 below. It is the maximum aft center of gravity position that yields the critical loading on the critical gear (see chapter 7.4). This center of gravity position is used to determine main-gear loads at all gross weights of the model being considered.
2. Establish a flexible-pavement requirements chart using the S-77-1 design method, such as shown on the right-hand side of page 7. Use standard subgrade strengths of CBR 3, 6, 10 and 15 percent and 10 000 coverages. This chart provides the same thickness values as those of chapter 7.5, but is presented here in a different format.
3. Determine reference thickness values from the pavement requirements chart of step 2 for each standard subgrade strength and gear loading.
4. Enter the reference thickness values into the ACN flexible-pavement conversion chart shown on the left-hand side of page 7 to determine ACN. This chart was developed using the S-77-1 design method with a single tire inflated to 1.25 MPa (181 psi) pressure and 10,000 coverages. The ACN is two times the derived single-wheel load expressed in thousands of kilograms. These values of ACN are then plotted as a function of aircraft gross weight, as shown in Section 7.9.1.1.

The following procedure is used to develop the rigid-pavement ACN charts, such as those shown in Section 7.9.4.1.

1. Determine the percentage of weight on the main gear to be used in steps 2, 3 and 4 below. It is a maximum aft center of gravity position that yields the critical loading on the critical gear (see chapter 7.4). This center of gravity position is used to determine main-gear loads at all gross weights of the model being considered.

A 300
AIRPLANE CHARACTERISTICS

2. Establish a rigid-pavement-requirements chart using the PCA computer program PDILB, such as shown on the right-hand side of page 9. Use standard subgrade strengths of $k = 75, 150, 300$ and 550 pci (nominal values for $k = 20, 40, 80, 150$ MN/m³). This chart provides the same thickness values as those of chapter 7.7.
3. Determine reference thickness values from the pavement requirements chart of step 2 for each standard subgrade strength and gear loading at 400 psi working stress (nominal value for 2.75 MPa working stress).
4. Enter the reference thickness values into the ACN rigid-pavement conversion chart shown on the left-hand side of page 9 to determine ACN. This chart was developed using the PCA computer program PDILB with a single tire inflated to 1.25 MPa (181 psi) pressure and a working stress of 400 psi. The ACN is two times the derived single-wheel load expressed in thousands of kilograms. These values of ACN are then plotted as a function of aircraft gross weight, as shown in Section 7.9.4.1.



AIRPLANE CHARACTERISTICS FOR AIRPORT PLANNING

R 8.0 DERIVATIVE AIRPLANES

R 8.1 Possible Future A300 Derivative Airplanes



AIRPLANE CHARACTERISTICS FOR AIRPORT PLANNING

8.1 Possible Future A300 Derivative Airplanes

R No derivative versions of the "A300" are currently planned.



AIRPLANE CHARACTERISTICS FOR AIRPORT PLANNING

R 9.0 SCALED DRAWINGS

R 9.1 A300 Scaled Drawing 1 in. = 500 ft.

R 9.2 A300 Scaled Drawing 1 cm. = 500 cm.



AIRPLANE CHARACTERISTICS FOR AIRPORT PLANNING

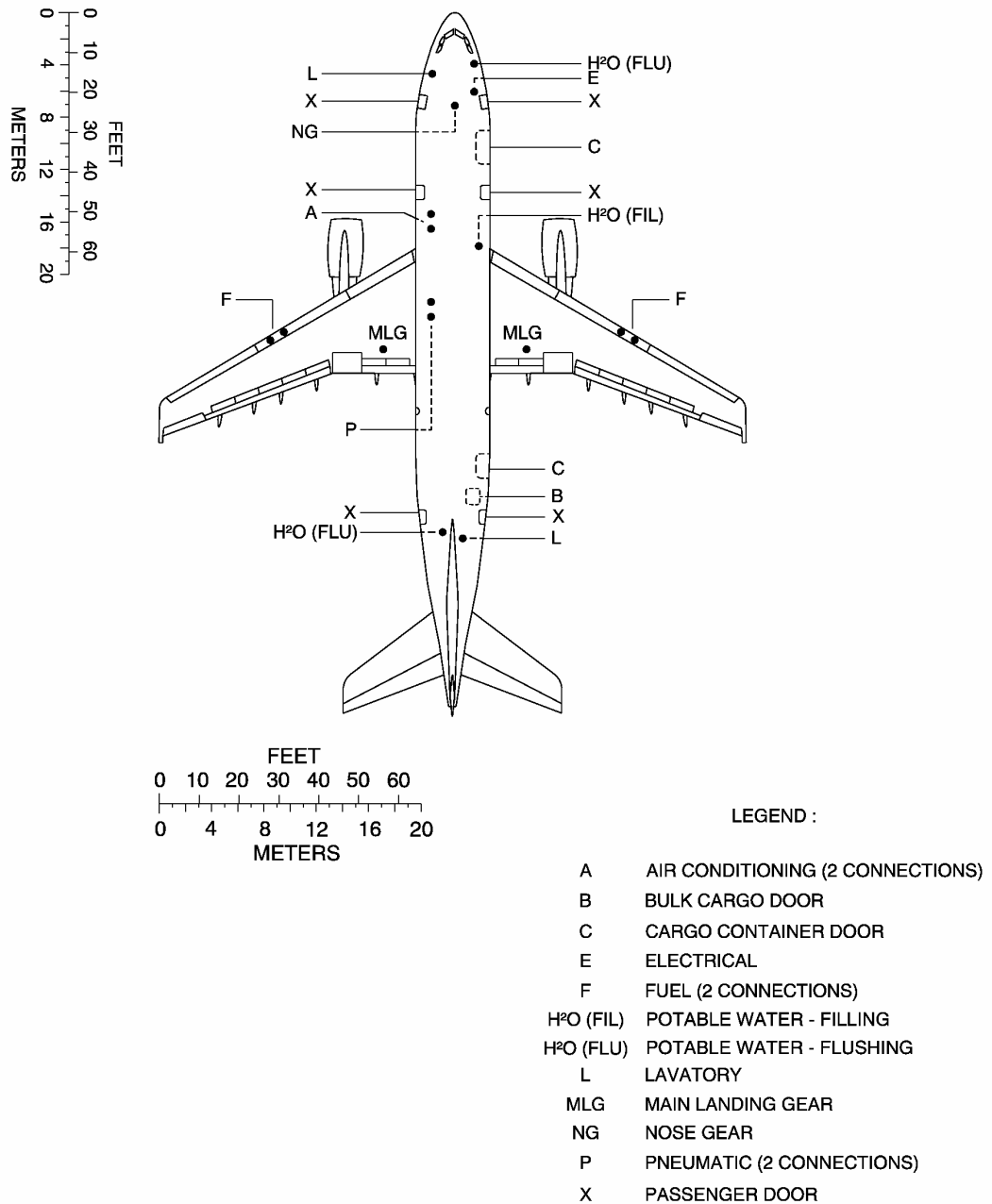

NOTE : WHEN PRINTING THIS DRAWING, SURE TO ADJUST FOR PROPER SCALING

9.1.1 Scaled Drawing - 1 in. = 500 ft.
Model B2 - B4

AA5 09 01 01 5 AAM0 00



AIRPLANE CHARACTERISTICS FOR AIRPORT PLANNING

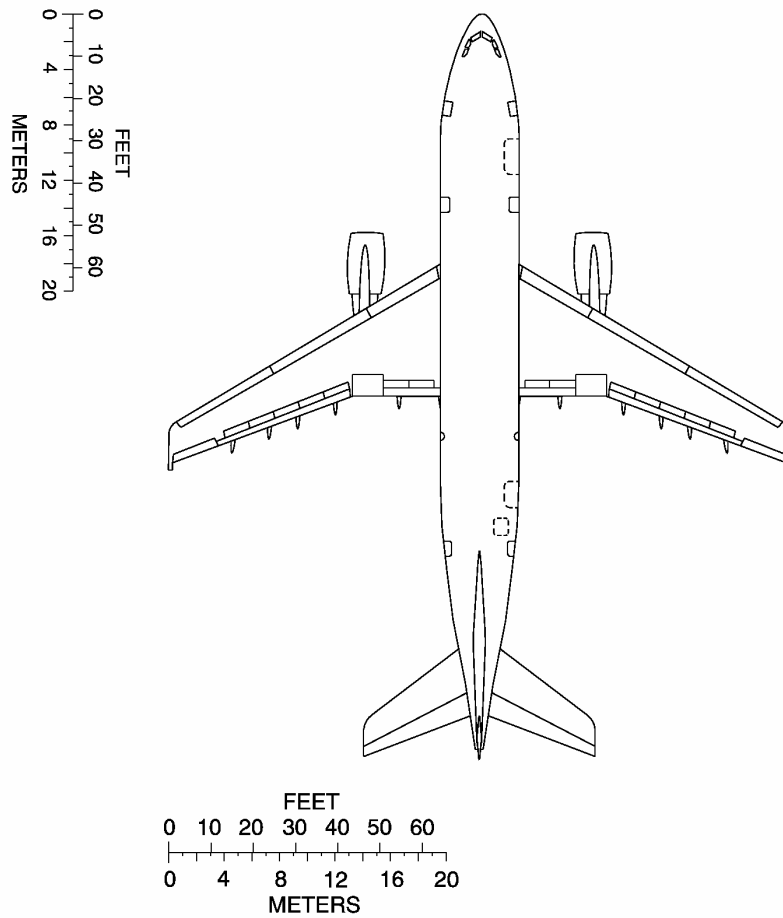

AA5 09 01 01 5 ABM0 00

NOTE : WHEN PRINTING THIS DRAWING, SURE TO ADJUST FOR PROPER SCALING

9.1.1 Scaled Drawing - 1 in. = 500 ft.
Model B2 - B4



AIRPLANE CHARACTERISTICS FOR AIRPORT PLANNING

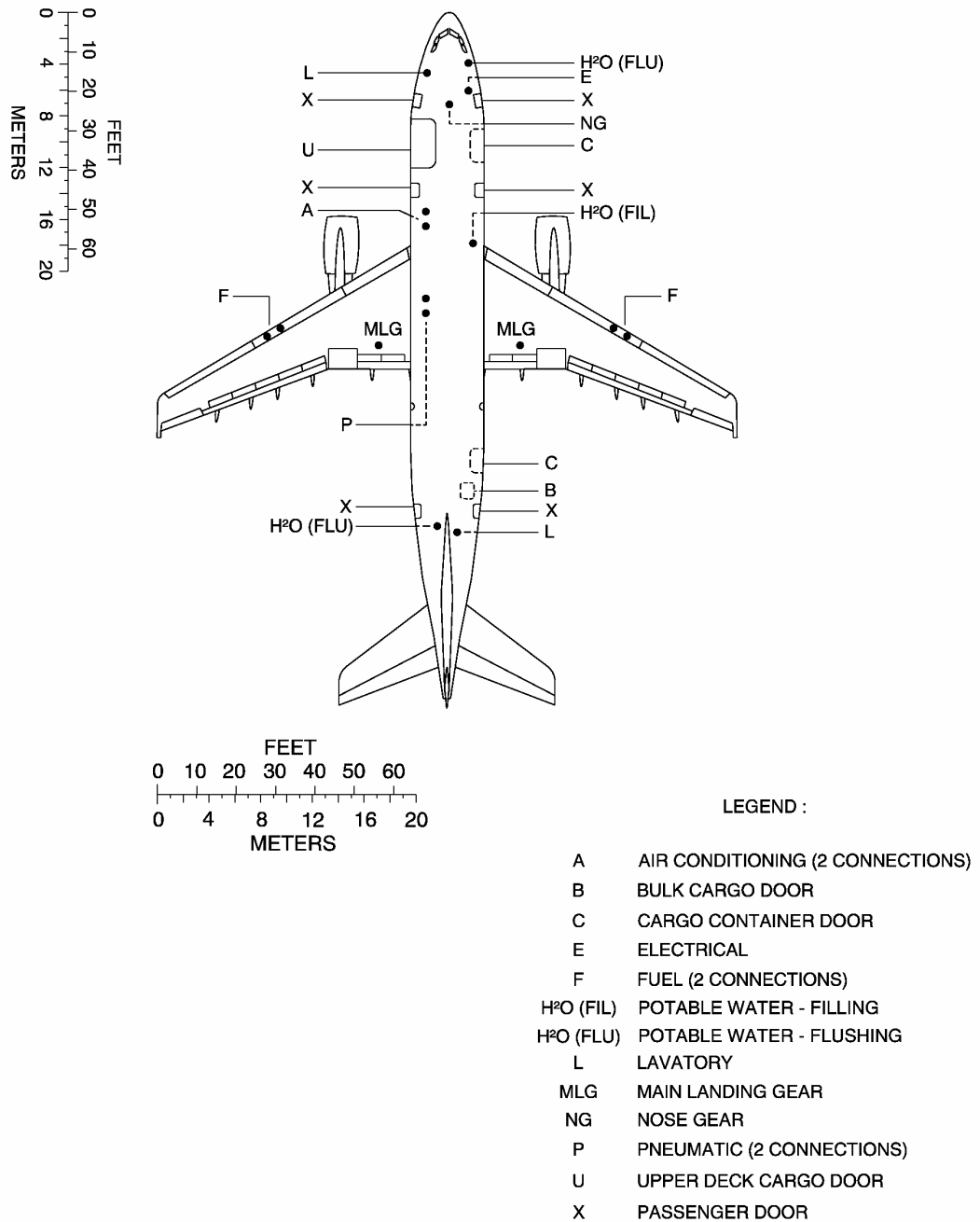

AA5 09 01 01 5 ACM0 00

NOTE : WHEN PRINTING THIS DRAWING, SURE TO ADJUST FOR PROPER SCALING

9.1.1 Scaled Drawing - 1 in. = 500 ft.
Model C4



AIRPLANE CHARACTERISTICS FOR AIRPORT PLANNING

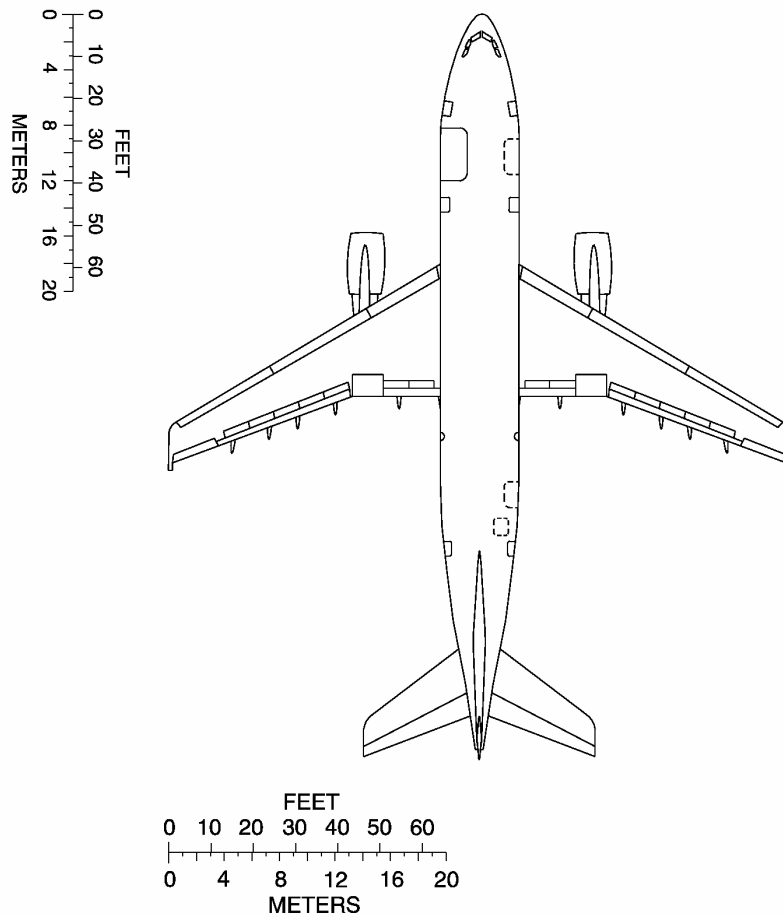

AA5 09 01 01 5 ADM0 00

NOTE : WHEN PRINTING THIS DRAWING, SURE TO ADJUST FOR PROPER SCALING

9.1.1 Scaled Drawing - 1 in. = 500 ft.
Model C4



AIRPLANE CHARACTERISTICS FOR AIRPORT PLANNING

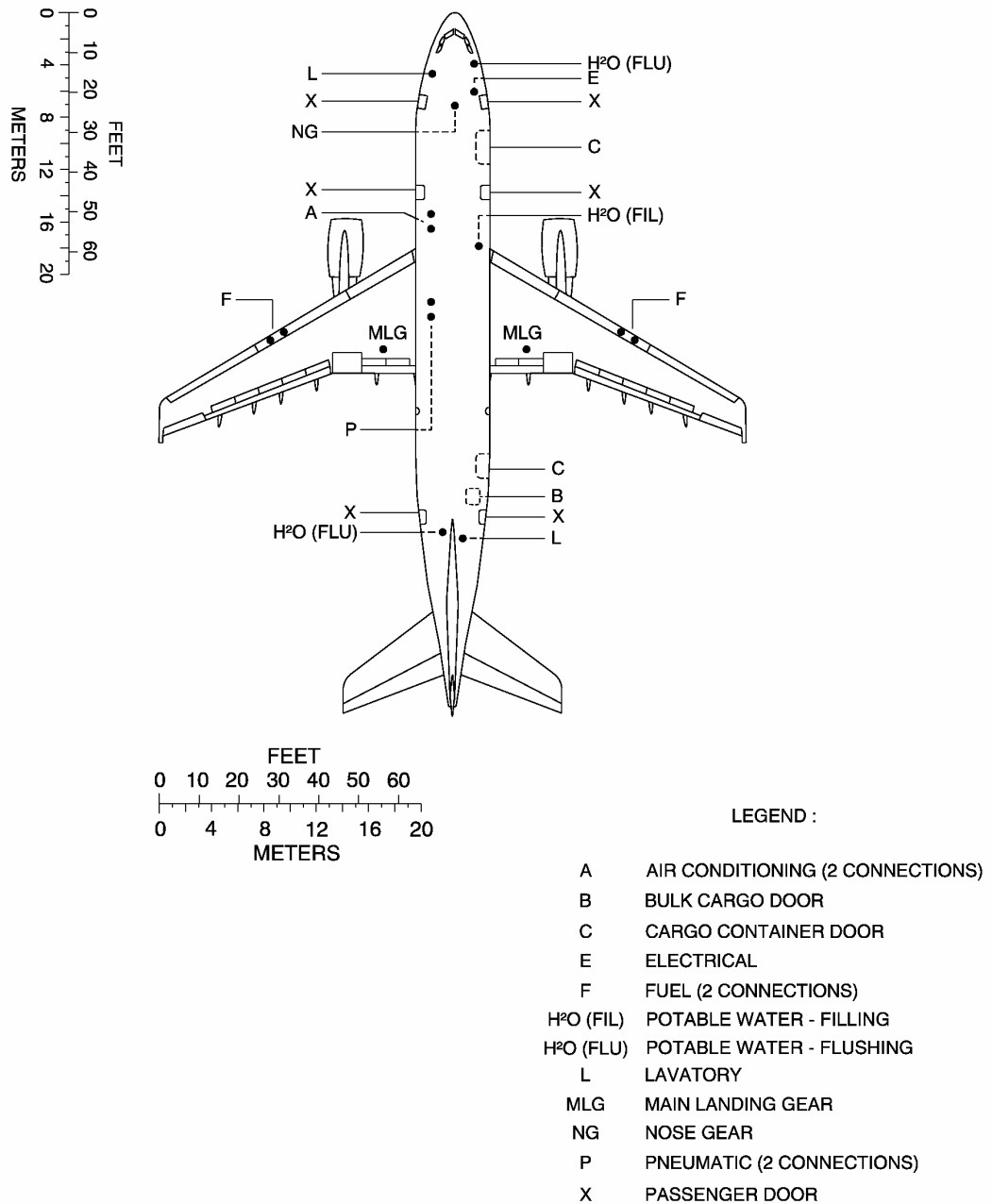

AA5 09 02 01 5 AAM0 00

NOTE : WHEN PRINTING THIS DRAWING, SURE TO ADJUST FOR PROPER SCALING

9.2.1 Scaled Drawing - 1 cm. = 500 cm.
Model B2 - B4



AIRPLANE CHARACTERISTICS FOR AIRPORT PLANNING

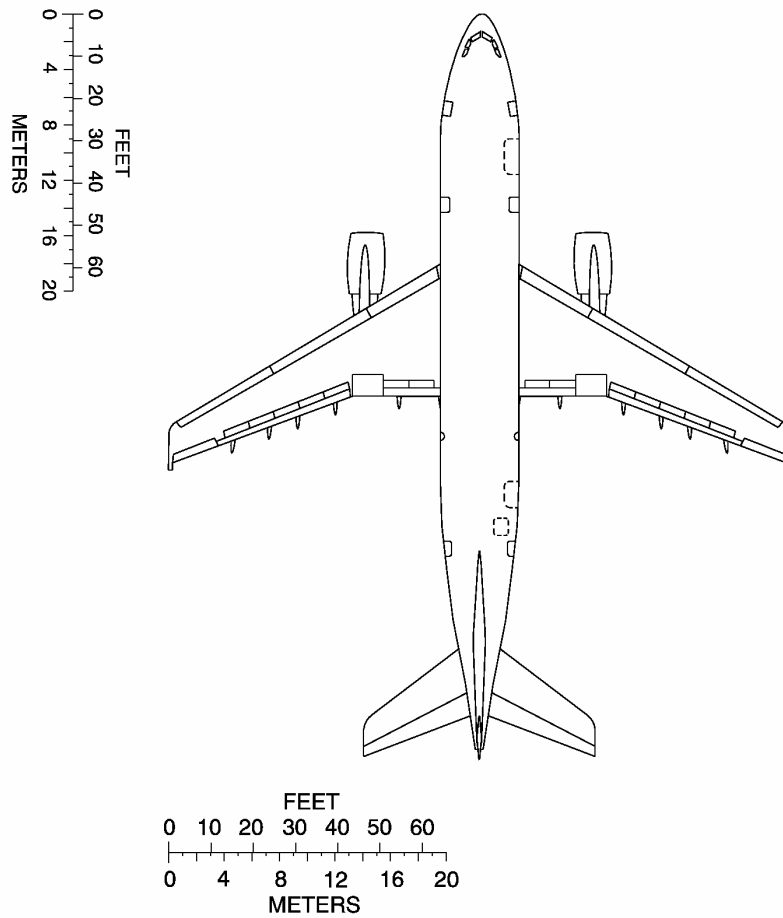

AA5 09 02 01 5 ABM0 00

NOTE : WHEN PRINTING THIS DRAWING, SURE TO ADJUST FOR PROPER SCALING

9.2.1 Scaled Drawing - 1 cm. = 500 cm.
Model B2 - B4



AIRPLANE CHARACTERISTICS FOR AIRPORT PLANNING

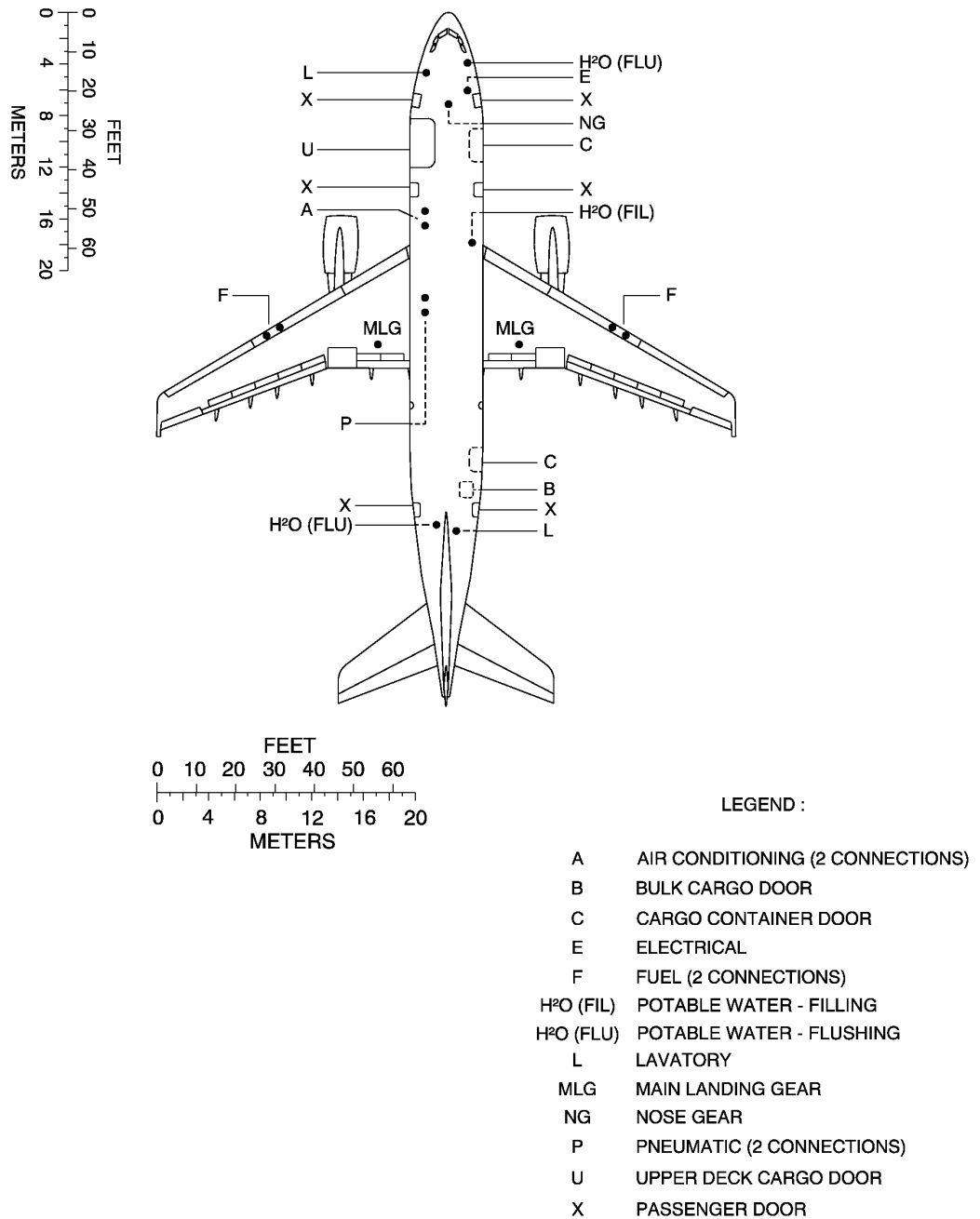

AA5 09 02 01 5 ACM0 00

NOTE : WHEN PRINTING THIS DRAWING, SURE TO ADJUST FOR PROPER SCALING

9.2.1 Scaled Drawing - 1 cm. = 500 cm.
Model C4



AIRPLANE CHARACTERISTICS FOR AIRPORT PLANNING

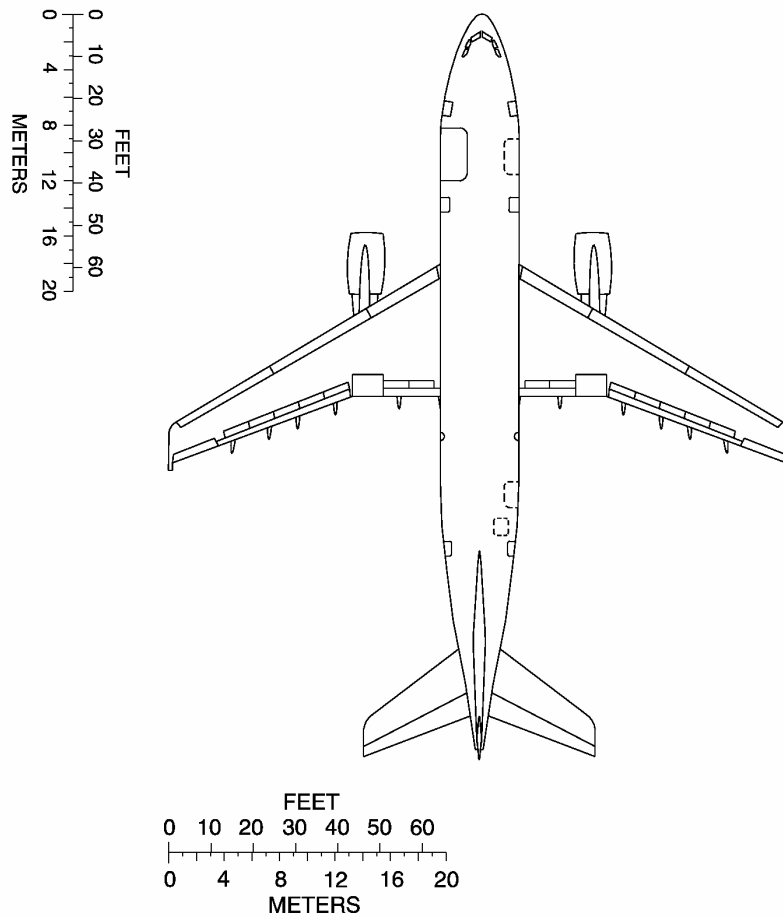

AA5 09 02 01 5 ADM0 00

NOTE : WHEN PRINTING THIS DRAWING, SURE TO ADJUST FOR PROPER SCALING

9.2.1 Scaled Drawing - 1 cm. = 500 cm.
Model C4