



A310

**Airplane Characteristics
For Airport Planning
AC**

The content of this document is the property of Airbus S.A.S.
It is supplied in confidence and commercial security on its
contents must be maintained.
It must not be used for any purpose other than that for which it is
supplied, nor may information contained in it be disclosed to un-
authorized persons. It must not be reproduced in whole or in part
without permission in writing from the owners of the copyright.
Requests for reproduction of any data in this document and the
media authorized for it must be addressed to Airbus.

© Airbus S.A.S. 2002. All rights reserved.

AIRBUS S.A.S.
31707 BLAGNAC CEDEX, FRANCE
CUSTOMER SERVICES
TECHNICAL DATA SUPPORT AND SERVICES
PRINTED IN FRANCE
©AIRBUS S.A.S. 2002
ALL RIGHTS RESERVED

AN EADS COMPANY



AIRPLANE CHARACTERISTICS FOR AIRPORT PLANNING

HIGHLIGHTS

REVISION 21 - DEC 01/09

This revision concerns introduction of new pages and corrections of pages.

Description of change.

<u>SECTION</u>	<u>PAGE(s)</u>	<u>REASON FOR CHANGE</u>
1.1.0	p 1	Update Mail address.
1.2.0	p 1 and p 2	Update Presentation.
2.1.0	p 1	Update Presentation.
2.1.1	p 2 to p 4	Update Presentation and added Weight Variants.
2.3.0	p 1	Added "Note".
	p 2 and p 3	Update Illustration.
5.1.1	p 1	Added Introduction and deleted Note.
5.1.2	p 1 and p 2	Updated Illustration.
5.1.3	p 1	Updated Illustration.
5.3	p 1	Added Terminal Operations - En Route Station.
5.8.0	p 1	Added New Section "Ground Towing Requirements".
7.0.0	All pages	Revised All Chapters - New Illustrations and New Text.
8.1.0	p 1	Change Text.
9.1.1	p 1 and p 2	Update Illustration.
9.2.1	p 1 and p 2	Update Illustration.
9.3.1	p 1 and p 2	Deleted Section.
9.4.1	p 1 and p 2	Deleted Section.
9.5.1	p 1 and p 2	Deleted Section.
9.6.1	p 1 and p 2	Deleted Section.

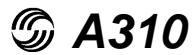

AIRPLANE CHARACTERISTICS FOR AIRPORT PLANNING

REVISION TRANSMITTAL SHEET

TO : ALL HOLDERS OF A310 AIRCRAFT RECOVERY MANUAL

R The revision, dated DEC 01/09 is attached and covers all the Airplane Characteristics, and the pavement data, which are identified in the highlights.

FILING INSTRUCTIONS

NOTE : Before introducing this revision make certain that previous revisions are incorporated.

- affected pages are listed on the "List of Effective Pages" and designated as follows :

R = revised (to be replaced)
D = deleted (to be removed)
N = new (to be introduced)

- make certain that the content of the manual is in compliance with the List of Effective Pages.

- update the Record of Revisions page accordingly.

- file the Revision Transmittal Sheet separately.

- remove and destroy the pages which are affected by this revision.

REASON FOR ISSUE

The attached Highlights detail the reasons for issue.

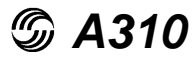

AIRPLANE CHARACTERISTICS FOR AIRPORT PLANNING

RECORD OF REVISIONS

REV No.	ISSUE DATE	DATE INSERTED	BY	REV No.	ISSUE DATE	DATE INSERTED	BY
	DEC 79						
1	MAR 80						
2	MAR 81						
3	FEB 82						
4	SEP 83						
5	FEB 84						
6	MAY 84						
7	MAY 85						
8	SEP 85						
9	APR 86						
10	OCT 87						
11	FEB 88						
12	AUG 88						
13	OCT 89						
14	OCT 90						
15	DEC 91						
16	JUN 92						
17	MAR 93						
18	NOV 94						
19	OCT 96						
20	MAY 98						
21	DEC 09						

R

R



AIRPLANE CHARACTERISTICS FOR AIRPORT PLANNING

LIST OF EFFECTIVE PAGES

CHAPTER/ SECTION		PAGE	DATE	CHAPTER/ SECTION	PAGE	DATE
L.E.P.	R	1	DEC 09	2.6.3	1	APR 86
L.E.P.	R	2	DEC 09	2.7.0	1	APR 86
L.E.P.	R	3	DEC 09	2.7.1	1	APR 86
L.E.P.	N	4	DEC 09	2.7.2	1	APR 86
L.E.P.	N	5	DEC 09	2.7.3	1	APR 86
				2.7.4	1	APR 86
R.O.R.	R	1	DEC 09	2.7.5	1	APR 86
R.O.R.	D	2	DEC 09	2.7.6	1	APR 86
				2.7.7	1	APR 86
T.O.C.	R	1	DEC 09	2.7.8	1	APR 86
T.O.C.	R	2	DEC 09	2.7.9	1	APR 86
T.O.C.	R	3	DEC 09			
T.O.C.	D	4	DEC 09	3.0	1	NOV 94
				3.1.0	1	NOV 94
1.0	R	1	DEC 09	3.2.1	1	SEP 85
1.1.0	R	1	DEC 09	3.2.1	2	APR 86
1.2.0	R	1	DEC 09	3.2.1	3	SEP 85
1.2.0	R	2	DEC 09	3.2.1	4	SEP 85
				3.2.1	5	SEP 85
2.0	R	1	DEC 09	3.2.1	6	SEP 85
2.1.0	R	1	DEC 09	3.2.1	7	SEP 85
2.1.1	R	1	DEC 09	3.2.1	8	SEP 85
2.1.1	R	2	DEC 09	3.2.1	9	SEP 85
2.1.1	R	3	DEC 09	3.2.1	10	SEP 85
2.1.1	R	4	DEC 09	3.2.1	11	MAR 93
2.2.0		1	APR 86	3.2.1	12	MAR 93
2.2.0		2	NOV 94	3.2.1	13	MAR 93
2.2.0		3	NOV 94	3.2.1	14	MAR 93
2.2.1		1	OCT 96	3.2.1	15	MAR 93
2.2.2		1	OCT 96	3.2.1	16	MAR 93
2.2.3		1	OCT 96	3.3.1	1	SEP 85
2.3.0	R	1	DEC 09	3.3.1	2	SEP 85
2.3.0	R	2	DEC 09	3.3.1	3	OCT 87
2.3.0	N	3	DEC 09	3.3.1	4	OCT 87
2.4.1		1	MAR 81	3.3.2	1	OCT 87
2.4.1		2	SEP 85	3.3.2	2	OCT 87
2.4.1		3	MAY 98	3.3.2	3	OCT 87
2.4.2		1	MAR 81	3.3.2	4	OCT 87
2.4.2		2	MAR 81	3.4.1	1	SEP 85
2.4.2		3	MAR 81	3.4.1	2	OCT 87
2.5.0		1	OCT 89	3.5.1	1	NOV 94
2.6.1		1	OCT 87			
2.6.2		1	APR 86			



AIRPLANE CHARACTERISTICS FOR AIRPORT PLANNING

LIST OF EFFECTIVE PAGES

CHAPTER/ SECTION		PAGE	DATE	CHAPTER/ SECTION		PAGE	DATE
4.0		1	DEC 79	5.5.2		2	MAY 98
4.1.0		1	APR 86	5.5.2		3	OCT 87
4.2.0		1	APR 86	5.5.3		1	APR 86
4.3.0		1	APR 86	5.5.3		2	AUG 88
4.4.0		1	NOV 94	5.5.3		3	OCT 87
4.5.1		1	APR 86	5.6.1		1	APR 86
4.5.2		1	APR 86	5.6.2		1	APR 86
4.5.3		1	APR 86	5.7.0		1	APR 86
4.6.0		1	APR 86	5.8	N	1	DEC 09
				5.8	N	2	DEC 09
5.0	R	1	DEC 09	5.8.1	N	1	DEC 09
5.1.1	R	1	DEC 09	5.8.1	N	2	DEC 09
5.1.2	R	1	DEC 09	5.8.1	N	3	DEC 09
5.1.2	R	2	DEC 09	5.8.1	N	4	DEC 09
5.1.3	R	1	DEC 09				
5.1.3	D	2	DEC 09	6.0		1	MAY 98
5.1.4	D	1	DEC 09	6.1.1		1	APR 86
5.2.1		1	OCT 96	6.1.1		2	MAR 80
5.2.2		1	OCT 96	6.1.1		3	OCT 87
5.2.3		1	OCT 96	6.1.1		4	OCT 87
5.2.4	D	1	MAR 93	6.1.1		5	OCT 87
5.3	N	1	DEC 09	6.1.1		6	MAY 98
5.3.1	D	1	DEC 09	6.1.2		1	APR 86
5.3.1	D	2	DEC 09	6.1.2		2	MAR 80
5.4.1		1	APR 86	6.1.2		3	OCT 87
5.4.2		1	SEP 85	6.1.2		4	MAY 98
5.4.2		2	SEP 85	6.1.3		1	APR 86
5.4.2		3	SEP 85	6.1.3		2	MAR 80
5.4.2		4	OCT 89	6.1.3		3	OCT 87
5.4.3		1	APR 86	6.1.3		4	OCT 87
5.4.4		1	MAY 98	6.1.4		1	APR 86
5.4.5		1	APR 86	6.1.4		2	MAR 80
5.4.6		1	APR 86	6.1.4		3	OCT 87
5.4.7		1	APR 86	6.1.4		4	OCT 87
5.4.8		1	OCT 96	6.1.5		1	APR 86
5.4.9		1	NOV 94	6.1.5		2	MAR 80
5.4.9		2	NOV 94	6.1.5		3	OCT 87
5.4.9		3	NOV 94	6.1.5		4	OCT 87
5.4.10		1	OCT 96	6.1.6		1	APR 86
5.5.1		1	APR 86	6.1.6		2	MAR 80
5.5.1		2	AUG 88	6.1.6		3	OCT 87
5.5.1		3	OCT 87	6.1.6		4	OCT 87
5.5.2		1	APR 86	6.2.0		1	DEC 79



AIRPLANE CHARACTERISTICS FOR AIRPORT PLANNING

LIST OF EFFECTIVE PAGES

CHAPTER/ SECTION		PAGE	DATE	CHAPTER/ SECTION		PAGE	DATE
6.2.1		1	APR 86	7.4.1	N	4	DEC 09
6.2.1		2	MAR 80	7.4.1	N	5	DEC 09
6.2.1		3	OCT 89	7.4.1	N	6	DEC 09
6.2.1		4	OCT 90	7.4.1	N	7	DEC 09
6.3.1		1	MAR 93	7.4.1	N	8	DEC 09
6.3.1		2	APR 86	7.4.1	N	9	DEC 09
6.3.1		3	OCT 87	7.4.1	N	10	DEC 09
6.3.2		1	MAR 93	7.4.1	N	11	DEC 09
6.3.2		2	APR 86	7.5	R	1	DEC 09
6.3.2		3	OCT 87	7.5	D	2	DEC 09
6.3.3		1	OCT 87	7.5.1	N	1	DEC 09
6.3.3		2	OCT 96	7.5.1	N	2	DEC 09
6.3.4		1	NOV 94	7.5.1	N	3	DEC 09
				7.5.1	N	4	DEC 09
7.0	R	1	DEC 09	7.5.1	N	5	DEC 09
7.1	R	1	DEC 09	7.5.1	N	6	DEC 09
7.1	R	2	DEC 09	7.5.1	N	7	DEC 09
7.1	R	3	DEC 09	7.5.1	N	8	DEC 09
7.1	N	4	DEC 09	7.5.1	N	9	DEC 09
7.2	R	1	DEC 09	7.5.1	N	10	DEC 09
7.2	R	2	DEC 09	7.5.1	N	11	DEC 09
7.2	N	3	DEC 09	7.5.1	N	12	DEC 09
7.2	N	4	DEC 09	7.5.1	N	13	DEC 09
7.2	N	5	DEC 09	7.5.1	N	14	DEC 09
7.2	N	6	DEC 09	7.5.1	N	15	DEC 09
7.2	N	7	DEC 09	7.5.1	N	16	DEC 09
7.2	N	8	DEC 09	7.6	R	1	DEC 09
7.2	N	9	DEC 09	7.6	D	2	DEC 09
7.2.1	D	1	DEC 09	7.6.1	R	1	DEC 09
7.2.1	D	2	DEC 09	7.6.1	R	2	DEC 09
7.2.1	D	3	DEC 09	7.6.1	R	3	DEC 09
7.2.1	D	4	DEC 09	7.6.1	R	4	DEC 09
7.3	R	1	DEC 09	7.6.1	R	5	DEC 09
7.3	N	2	DEC 09	7.6.1	R	6	DEC 09
7.3	N	3	DEC 09	7.6.1	R	7	DEC 09
7.4	R	1	DEC 09	7.6.1	R	8	DEC 09
7.4	D	2	DEC 09	7.6.1	R	9	DEC 09
7.4	D	3	DEC 09	7.6.1	R	10	DEC 09
7.4	D	4	DEC 09	7.6.1	R	11	DEC 09
7.4	D	5	DEC 09	7.6.1	R	12	DEC 09
7.4.1	N	1	DEC 09	7.6.1	R	13	DEC 09
7.4.1	N	2	DEC 09	7.6.1	R	14	DEC 09
7.4.1	N	3	DEC 09	7.6.1	N	15	DEC 09



AIRPLANE CHARACTERISTICS FOR AIRPORT PLANNING

LIST OF EFFECTIVE PAGES

CHAPTER/ SECTION		PAGE	DATE	CHAPTER/ SECTION		PAGE	DATE
7.6.1	N	16	DEC 09	7.9.1	N	3	DEC 09
7.7	R	1	DEC 09	7.9.1	N	4	DEC 09
7.7.1	R	1	DEC 09	7.9.1	N	5	DEC 09
7.7.1	R	2	DEC 09	7.9.1	N	6	DEC 09
7.7.1	N	3	DEC 09	7.9.1	N	7	DEC 09
7.7.1	N	4	DEC 09	7.9.1	N	8	DEC 09
7.7.1	N	5	DEC 09	7.9.1	N	9	DEC 09
7.7.1	N	6	DEC 09	7.9.1	N	10	DEC 09
7.7.1	N	7	DEC 09	7.9.1	N	11	DEC 09
7.7.1	N	8	DEC 09	7.9.1	N	12	DEC 09
7.7.1	N	9	DEC 09	7.9.1	N	13	DEC 09
7.7.1	N	10	DEC 09	7.9.1	N	14	DEC 09
7.7.1	N	11	DEC 09	7.9.1	N	15	DEC 09
7.7.1	N	12	DEC 09	7.9.1	N	16	DEC 09
7.7.1	N	13	DEC 09	7.9.1.1	D	1	DEC 09
7.7.1	N	14	DEC 09	7.9.1.2	D	2	DEC 09
7.7.1	N	15	DEC 09	7.9.2	N	1	DEC 09
7.7.1	N	16	DEC 09	7.9.2	N	2	DEC 09
7.8	R	1	DEC 09	7.9.2	N	3	DEC 09
7.8.1	R	1	DEC 09	7.9.2	N	4	DEC 09
7.8.2	R	1	DEC 09	7.9.2	N	5	DEC 09
7.8.2	R	2	DEC 09	7.9.2	N	6	DEC 09
7.8.2	R	3	DEC 09	7.9.2	N	7	DEC 09
7.8.2	R	4	DEC 09	7.9.2	N	8	DEC 09
7.8.2	R	5	DEC 09	7.9.2	N	9	DEC 09
7.8.2	R	6	DEC 09	7.9.2	N	10	DEC 09
7.8.2	R	7	DEC 09	7.9.2	N	11	DEC 09
7.8.2	R	8	DEC 09	7.9.2	N	12	DEC 09
7.8.2	R	9	DEC 09	7.9.2	N	13	DEC 09
7.8.2	R	10	DEC 09	7.9.2	N	14	DEC 09
7.8.2	R	11	DEC 09	7.9.2	N	15	DEC 09
7.8.2	R	12	DEC 09	7.9.2	N	16	DEC 09
7.8.2	R	13	DEC 09	7.9.2.1	D	1	DEC 09
7.8.2	R	14	DEC 09	7.9.2.2	D	2	DEC 09
7.8.2	N	15	DEC 09				
7.8.2	N	16	DEC 09	8.0	R	1	DEC 09
7.8.3	R	1	DEC 09	8.1	R	1	DEC 09
7.8.4	R	1	DEC 09				
7.9	R	1	DEC 09	9.0	R	1	DEC 09
7.9	R	2	DEC 09	9.1.1	R	1	DEC 09
7.9	D	3	DEC 09	9.1.1	R	2	DEC 09
7.9.1	N	1	DEC 09	9.2.1	R	1	DEC 09
7.9.1	N	2	DEC 09	9.2.1	R	2	DEC 09

N



AIRPLANE CHARACTERISTICS FOR AIRPORT PLANNING

LIST OF EFFECTIVE PAGES

CHAPTER/ SECTION		PAGE	DATE	CHAPTER/ SECTION	PAGE	DATE
9.3.1	D	1	DEC 09			
9.3.1	D	2	DEC 09			
9.4.1	D	1	DEC 09			
9.4.1	D	2	DEC 09			
9.5.1	D	1	DEC 09			
9.5.1	D	2	DEC 09			
9.6.1	D	1	DEC 09			
9.6.1	D	2	DEC 09			



AIRPLANE CHARACTERISTICS FOR AIRPORT PLANNING

TABLE OF CONTENTS

R	1.0	SCOPE
R	1.1.0	Purpose
R	1.2.0	Introduction
R	2.0	AIRPLANE DESCRIPTION
R	2.1.0	General Airplane Characteristics
R	2.1.1	General Airplane Characteristics Data Model 200, 200C and 300
	2.2.0	General Airplane Dimensions
	2.2.1	GE Engine CF6-80C2
	2.2.2	PW Engine
R	2.2.3	GE Engine CF6-80C2
	2.3.0	Ground Clearance
	2.4	Interior Arrangements
	2.4.1	Passengers
	2.4.2	Cargo (16 Pallets and 12 Pallets)
	2.5	Passenger Compartment Cross Section
	2.6	Lower Compartments
	2.6.1	Containers
	2.6.2	Pallets in Forward Cargo Compartment
	2.6.3	Upper Deck Cargo Compartment
	2.7	Door Clearances
	2.7.1	Forward Passenger/Crew Door
	2.7.2	Emergency Exit
	2.7.3	Aft Passenger/Crew Door
	2.7.4	Forward Cargo Compartment Door
	2.7.5	Bulk Cargo Compartment Door
	2.7.6	Aft Cargo Compartment Door
	2.7.7	Upper Deck Cargo Door
	2.7.8	Radome Travel
	2.7.9	Main Landing Gear Door
	3.0	AIRPLANE PERFORMANCE
	3.1	General Information
	3.2	Payload Range
	3.2.1	Long Range Cruise ISA Conditions
	3.3	FAR Take-off Runway Length Requirements
	3.3.1	ISA Conditions
	3.3.2	ISA +18.3°C (+65°F) Conditions
	3.4	FAR Landing Runway Requirements
	3.4.1	All Ambient Temperatures
	3.5	Landing Approach Speed
	3.5.1	Landing Approach Speed At 1.3 Vs



AIRPLANE CHARACTERISTICS FOR AIRPORT PLANNING

TABLE OF CONTENTS

4.0	GROUND MANEUVERING
4.1	General Information
4.2	Turning Radii, no Slip Angle
4.3	Minimum Turning Radii
4.4	Visibility From Flight Compartment in Static Position
4.5	Runway and Taxiway Turn Paths
4.5.1	More than 90 Deg. Turn Runway To Taxiway Turn
4.5.2	90 Deg. Turn-Runway to Taxiway
4.5.3	90 Deg. Turn-Taxiway to Taxiway
4.6	Runway Holding Bay (Apron)
R 5.0	TERMINAL SERVICING
5.1	Airplane Servicing Arrangements - Typical
R 5.1.1	Symbols Used On Servicing Diagrams
R 5.1.2	Open Apron Free Standing - Passenger's Stairways
R 5.1.3	Open Apron Free Standing - Cargo Loading
5.2.1	Turnaround Station (30 Minutes)
5.2.2	Turnaround Station (45 Minutes)
5.2.3	Turnaround Station (90 Minutes)
N 5.3	Terminal Operations - En route Station
5.4	Ground Service Connections
5.4.1	Symbols Used On Ground Service Connections Diagrams
5.4.2	Ground Service Connections Layout
5.4.3	Hydraulic System
5.4.4	Electrical System
5.4.5	Oxygen System
5.4.6	Fuel System
5.4.7	Pneumatic System
5.4.8	Potable Water System
5.4.9	Oil System
5.4.10	Toilet System
5.5	Engine Starting Pneumatic Requirements
5.5.1	Ambient Temperature -40°C (-40°F)
5.5.2	Ambient Temperature +15°C (+60°F)
5.5.3	Ambient Temperature +38°C (+100°F)
5.6	Ground Pneumatic Power Requirements
5.6.1	Heating
5.6.2	Cooling
5.7	Preconditioned Airflow Requirements
N 5.8	Ground Towing Requirements
N 5.8.1	Ground Towing Requirements - Towbar design

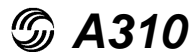

AIRPLANE CHARACTERISTICS FOR AIRPORT PLANNING

TABLE OF CONTENTS

6.0	OPERATING CONDITIONS
6.1	Jet Engine Exhaust Velocities and Temperatures
6.1.1	Exhaust Velocity Contours - Breakaway Power
6.1.2	Exhaust Temperature Contours - Breakaway Power
6.1.3	Exhaust Velocity Contours - Take-off Power
6.1.4	Exhaust Temperature Contours - Take-off Power
6.1.5	Exhaust Velocity Contours - Idle Power
6.1.6	Exhaust Temperature Contours - Idle Power
6.2	Airport and Community Noise
6.2.1	Noise Data
6.3	Danger Areas of the Engines
6.3.1	Danger Areas of the Engines - Ground Idle
6.3.2	Danger Areas of the Engines - Take-off
6.3.3	Acoustic Protection Areas
6.3.4	APU - Exhaust Gas Temperature & Velocity
R 7.0	PAVEMENT DATA
R 7.1	General Information
R 7.2	Landing Gear Footprint
R 7.3	Maximum Pavement Loads
R 7.4	LG Loading on Pavement
N 7.4.1	LG Loading on Pavement
R 7.5	Flexible Pavement Requirements U.S. Army
N 7.5.1	Flexible Pavement Requirements
R 7.6	Flexible Pavement Requirements LCN
R 7.6.1	Flexible Pavement Requirements LCN
R 7.7	Rigid Pavement Requirements PCA
R 7.7.1	Rigid Pavement Requirements PCA
R 7.8	Rigid Pavement Requirements LCN
R 7.8.1	Radius of Relative Stiffness - Inches
R 7.8.2	Rigid Pavement Requirements LCN
R 7.8.3	Radius of Relative Stiffness - other values
R 7.8.4	Radius of Relative Stiffness - other values
R 7.9	ACN-PCN Reporting System
N 7.9.1	ACN Number Flexible Pavement
N 7.9.2	ACN Number Rigid Pavement
R 8.0	DERIVATIVE AIRPLANES
R 8.1.0	Possible Future A310 Derivative Airplane
R 9.0	SCALED DRAWINGS
R 9.1.1	A310 Scaled Drawing 1 in. = 500 ft.
R 9.2.1	A310 Scaled Drawing 1 cm. = 500 cm.

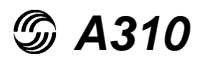

AIRPLANE CHARACTERISTICS FOR AIRPORT PLANNING

- R 1.0 SCOPE
- R 1.1.0 Purpose
- R 1.2.0 Introduction

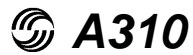

AIRPLANE CHARACTERISTICS FOR AIRPORT PLANNING

1.1.0 Purpose

The A310 AIRPLANE CHARACTERISTICS (AC) manual is issued to provide the necessary data which are needed for airport operators and airlines for the accomplishment of airport facilities planning. It provides characteristics for A310-200 and A310-300 basic versions.

This document conforms to NAS 3601.

CORRESPONDENCE

Correspondence concerning this publication should be directed to :

AIRBUS S.A.S.
Customer Services
Technical Data Support and Services
1, Rond Point Maurice BELLONTE
31707 BLAGNAC CEDEX
FRANCE



AIRPLANE CHARACTERISTICS FOR AIRPORT PLANNING

1.2.0 Introduction

This manual comprises 9 chapters with a List of Effective Pages (LEP) and a Table Of Content (TOC) at the beginning of each chapter.

Chapter 1 : SCOPE

Chapter 2 : AIRPLANE DESCRIPTION

This chapter contains general dimensional and other basic aircraft data concerning the A310.

It covers :

- aircraft dimensions and ground clearances,
- passengers and cargo compartments arrangement.

Chapter 3 : AIRPLANE PERFORMANCE

This chapter indicates the aircraft performance.

It covers :

- payload range,
- takeoff and landing runway requirements,
- landing approach speed.

Chapter 4 : GROUND MANEUVERING

This chapter provides the aircraft turning capability and maneuvering characteristics on the ground.

It includes :

- turning radii and visibility from the cockpit,
- runway and taxiway turn path.

Chapter 5 : TERMINAL SERVICING

This chapter provides information for the arrangement of ground handling and servicing equipments.

It covers :

- location and connections of ground servicing equipments,
- engines starting pneumatic and preconditioned airflow requirements.

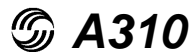

AIRPLANE CHARACTERISTICS FOR AIRPORT PLANNING

Chapter 6 : OPERATING CONDITIONS

This chapter contains data and safety/environmental precautions related to engine and APU operation on the ground.

It covers :

- contour size and shape of the jet engine exhaust velocities and temperature,
- noise data.

Chapter 7 : PAVEMENT DATA

This chapter contains the pavement data helpful for airport planning.

It gives :

- landing gear foot print and static load,
- charts for flexible pavements with Load Classification Number (LCN),
- charts for rigid pavements with LCN,
- Aircraft Classification Number (ACN), Pavement Classification Number (PCN), reporting system for flexible and rigid pavements.

Chapter 8 : DERIVATIVE AIRPLANES

This chapter gives relevant data of possible A310 new version with the associated size change.

Chapter 9 : SCALED DRAWING

This chapter contains different A310 scaled drawings.

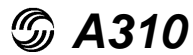

AIRPLANE CHARACTERISTICS FOR AIRPORT PLANNING

- R 2.0 AIRPLANE DESCRIPTION
- R 2.1.0 General Airplane Characteristics
- R 2.1.1 General Airplane Characteristics data
- 2.2 General Airplane Dimensions
 - 2.2.1 GE Engine CF6-80A3
 - 2.2.2 PW Engines
 - 2.2.3 GE Engine CF6-80C2
- R 2.3.0 Ground Clearances
- 2.4 Interior Arrangements
 - 2.4.1 Passengers
 - 2.4.2 Cargo (16 Pallets and 12 Pallets)
- 2.5 Passenger Compartment Cross Section
- 2.6 Lower Compartments
 - 2.6.1 Containers
 - 2.6.2 Pallets in Forward Cargo Compartment
 - 2.6.3 Upper Deck Cargo Compartment
- 2.7 Door Clearances
 - 2.7.1 Forward Passenger/Crew Door
 - 2.7.2 Emergency Exit
 - 2.7.3 Aft Passenger/Crew Door
 - 2.7.4 Forward Cargo Compartment Door
 - 2.7.5 Bulk Cargo Compartment Door
 - 2.7.6 Aft Cargo Compartment Door
 - 2.7.7 Upper Deck Cargo Door
 - 2.7.8 Radome Travel
 - 2.7.9 Main Landing Gear Door



AIRPLANE CHARACTERISTICS FOR AIRPORT PLANNING

2.1.0 General Airplane Characteristics

The weight terms used throughout this manual are given below together with their respective definitions.

Maximum Taxi Weight (MTW) :

Maximum weight for ground maneuver as limited by aircraft strength and airworthiness requirements. (It includes weight of run-up and taxi fuel). It is also called Maximum Ramp Weight (MRW).

Maximum Landing Weight (MLW) :

Maximum weight for landing as limited by aircraft strength and airworthiness requirements.

Maximum Takeoff Weight (MTOW) :

Maximum weight for takeoff as limited by aircraft strength and airworthiness requirements. (This is the maximum weight at start of the takeoff run).

Maximum Zero Fuel Weight (MZFW) :

Maximum operational weight of the aircraft without usable fuel.

Operational Empty Weight (OEW) :

Weight of structure, powerplant, furnishings, systems, and other items of equipment that are an integral part of a particular aircraft configuration plus the operator's items.

The operator's items are the flight and cabin crew and their baggage, unusable fuel, engine oil, emergency equipment, toilet chemical and fluids, galley structure, catering equipment, passenger seats and life vests, documents, etc.

Maximum Payload :

Maximum Zero Fuel Weight (MZFW) minus Operational Empty Weight (OEW).

Maximum Seating Capacity :

Maximum number of passengers specifically certified or anticipated for certification.

Maximum Cargo Volume :

Maximum usable volume available for cargo.

Usable Fuel :

Fuel available for aircraft propulsion.



AIRPLANE CHARACTERISTICS FOR AIRPORT PLANNING

		AIRPLANE VERSION							
		A310-200			Pax and Cargo	A310-200			
		WV000 (basic)	WV001	WV003	WV004	WV006	WV007	WV008	WV011
Maximum Taxi Weight (MTW)	kg	132 900	139 400	125 900	142 900	135 900	132 900	139 500	144 900
	lb	292 994	307 324	277 561	315 040	299 607	292 994	307 324	319 449
Maximum Takeoff Weight (MTOW)	kg	132 000	138 500	125 000	142 000	135 000	132 000	138 600	144 000
	lb	291 009	305 560	275 577	313 056	297 623	291 009	305 560	317 465
Maximum Landing Weight (MLW)	kg	118 500	121 500	118 500	121 500	118 500	119 500	122 000	121 500
	lb	261 247	267 861	261 247	267 861	261 247	263 452	268 963	267 861
Maximum Zero Fuel Weight (MZFW)	kg	108 500	111 500	108 500	111 500	111 500	111 500	112 000	111 500
	lb	239 201	245 815	239 201	245 815	245 815	245 815	246 917	245 815
Estimated Operational Empty Weight (OEW)	GE CF6-80 Engines	79 207 kg (174 619 lb)							
	PWJT9D Engines	79 166 kg (174 528 lb)							
Estimated Maximum Payload GE CF6-80	kg	29 293	32 293	29 293	32 293	32 293		32 793	
	lb	64 579	71 193	64 579	71 193	71 193		72 296	
Estimated Maximum Payload PWJT9D	kg	29 334	32 334	29 334	32 334	32 334	32 334		32 334
	lb	64 670	71 284	64 670	71 284	71 284	71 284		71 284
Standard Seating Capacity	single-class	237							
Usable Fuel Capacity	l	61 070							
	US Gallons	16 132							
	kg (d=0.785)	47 940							
	lb	105 689							
Pressurized Fuselage Volume (A/C non equipped)	m ³	680							
	ft ³	24 013							
Passenger Compartment Volume	m ³	454							
	ft ³	16 032							
Cockpit Volume	m ³	12							
	ft ³	424							
Usable Cargo Compartment Volume (1)	m ³	112.2							
	ft ³	3 962							

(1) Volume of Cargo Compartments : Fwd Cargo Compartment : 55 m³ (1 943 ft³)
 Aft Cargo Hold Compartment : 36.2 m³ (1 278 ft³)
 Bulk Cargo Compartment : 21 m³ (741 ft³)

2.1.1 General Airplane Characteristic Data Model 200 and C and F



AIRPLANE CHARACTERISTICS FOR AIRPORT PLANNING

		AIRPLANE VERSION		
		Pax and Cargo	A310-200	
		WV101	WV104	WV107
Maximum Taxi Weight (MTW)	kg	139 500	142 900	134 900
	lb	307 324	315 040	297 403
Maximum Takeoff Weight (MTOW)	kg	138 600	142 000	134 000
	lb	305 560	313 056	295 419
Maximum Landing Weight (MLW)	kg	122 000	122 000	122 000
	lb	268 963	268 963	268 963
Maximum Zero Fuel Weight (MZFW)	kg	112 000	112 000	112 000
	lb	246 917	246 917	246 917
Estimated Operational Empty Weight (OEW)	GE CF6-80 Engines	79 207 kg (174 619 lb)		
	PWJT9D Engines	79 166 kg (174 528 lb)		
Estimated Maximum Payload GE CF6-80	kg	32 793	32 793	32 793
	lb	72 296	72 296	72 296
Estimated Maximum Payload PWJT9D	kg	32 834	32 834	
	lb	72 386	72 386	
Standard Seating Capacity	single-class	237		
Usable Fuel Capacity	l	61 070		
	US Gallons	16 132		
	kg (d=0.785)	47 940		
	lb	105 689		
Pressurized Fuselage Volume (A/C non equipped)	m3	680		
	ft3	24 013		
Passenger Compartment Volume	m3	454		
	ft3	16 032		
Cockpit Volume	m3	12		
	ft3	424		
Usable Cargo Compartment Volume (1)	m3	112.2		
	ft3	3 962		

(1) Volume of Cargo Compartments : Fwd Cargo Compartment : 55 m3 (1 943 ft3)
 Aft Cargo Hold Compartment : 36.2 m3 (1 278 ft3)
 Bulk Cargo Compartment : 21 m3 (741 ft3)

2.1.1 General Airplane Characteristics Data Model 200



AIRPLANE CHARACTERISTICS FOR AIRPORT PLANNING

		AIRPLANE VERSION					
		A310-300					
		WV000 (Basic)	WV001	WV003	WV004	WV005	WV006
Maximum Taxi Weight (MTW)	kg	150 900	153 900	153 900	142 900	157 900	139 500
	lb	332 677	339 291	339 291	315 040	348 109	307 544
Maximum Takeoff Weight (MTOW)	kg	150 000	153 000	153 000	142 000	157 000	138 600
	lb	330 693	339 291	339 291	313 056	346 125	307 544
Maximum Landing Weight (MLW)	kg	123 000	123 000	124 000	123 000	124 000	123 000
	lb	271 168	271 168	273 372	271 168	273 372	271 168
Maximum Zero Fuel Weight (MZFW)	kg	113 000	113 000	114 000	113 000	114 000	113 000
	lb	249 122	249 122	251 326	249 122	251 326	249 122
Estimated Operational Empty Weight (OEW)	GE CF6-80 Engines	79 207 kg (174 619 lb)					
	PW JT9D Engines	77 397 kg (170 631 lb)					
	PW4000 Engines	79 166 kg (174 528 lb)					
Estimated Maximum Payload GE CF6-80	kg	33 793	33 793	34 793	33 793	34 793	33 793
	lb	74 500	74 500	76 705	74 500	76 705	74 500
Estimated Maximum Payload PW JT9D	kg	35 603	35 603	36 603			35 603
	lb	78 491	78 491	80 685			78 491
Estimated Maximum Payload PW4000	kg	33 834	33 834	34 834		34 834	33 834
	lb	74 591	74 591	76 795		76 795	74 591
Standard Seating Capacity	single-class	243					
Usable Fuel Capacity	l	61 070					
	US Gallons	16 132					
	kg (d=0.785)	47 940					
	lb	105 689					
Pressurized Fuselage Volume (A/C non equipped)	m ³	680					
	ft ³	24 013					
Passenger Compartment Volume	m ³	454					
	ft ³	16 032					
Cockpit Volume	m ³	12					
	ft ³	424					
Usable Cargo Compartment Volume (1)	m ³	112.2					
	ft ³	3 962					

(1) Volume of Cargo Compartments : Fwd Cargo Compartment : 55 m³(1 943 ft³)
 Aft Cargo Hold Compartment : 36.2 m³ (1 278 ft³)
 Bulk Cargo Compartment : 21 m³ (741 ft³)

2.1.1 General Airplane Characteristics Data Model 300



AIRPLANE CHARACTERISTICS FOR AIRPORT PLANNING

		AIRPLANE VERSION				
		A310-300				
		WV007	WV008	WV009	WV012	WV013
Maximum Taxi Weight (MTW)	kg	134 900	164 900	161 900	160 900	164 900
	lb	297 403	363 541	356 928	354 723	363 541
Maximum Takeoff Weight (MTOW)	kg	134 000	164 000	161 000	160 000	164 000
	lb	295 419	361 557	354 943	352 739	361 557
Maximum Landing Weight (MLW)	kg	124 000	124 000	124 000	124 000	124 000
	lb	273 372	273 372	273 372	273 372	273 372
Maximum Zero Fuel Weight (MZFW)	kg	114 000	114 000	114 000	114 000	116 500
	lb	251 326	251 326	251 326	251 326	256 838
Estimated Operational Empty Weight (OEW)	GE CF6-80 Engines	79 207 kg (174 619 lb)				
	PW JT9D Engines	77 397 kg (170 631 lb)				
	PW4000 Engines	79 166 kg (174 528 lb)				
Estimated Maximum Payload GE CF6-80	kg	34 793	34 793	34 793		37 293
	lb	76 705	76 705	76 705		82 216
Estimated Maximum Payload PW JT9D	kg	36 603				
	lb	80 695				
Estimated Maximum Payload PW 4000	kg	34 834			34 834	
	lb	76 795			76 795	
Standard Seating Capacity	single-class	243				
Usable Fuel Capacity	l	61 070				
	US Gallons	16 132				
	kg (d=0.785)	47 940				
	lb	105 689				
Pressurized Fuselage Volume (A/C non equipped)	m ³	680				
	ft ³	24 013				
Passenger Compartment Volume	m ³	454				
	ft ³	16 032				
Cockpit Volume	m ³	12				
	ft ³	424				
Usable Cargo Compartment Volume (1)	m ³	112.2				
	ft ³	3 962				

(1) Volume of Cargo Compartments : Fwd Cargo Compartment : 55 m³(1 943 ft³)
 Aft Cargo Hold Compartment : 36.2 m³ (1 278 ft³)
 Bulk Cargo Compartment : 21 m³ (741 ft³)

2.1.1 General Airplane Characteristics Data Model 300

Printed in France

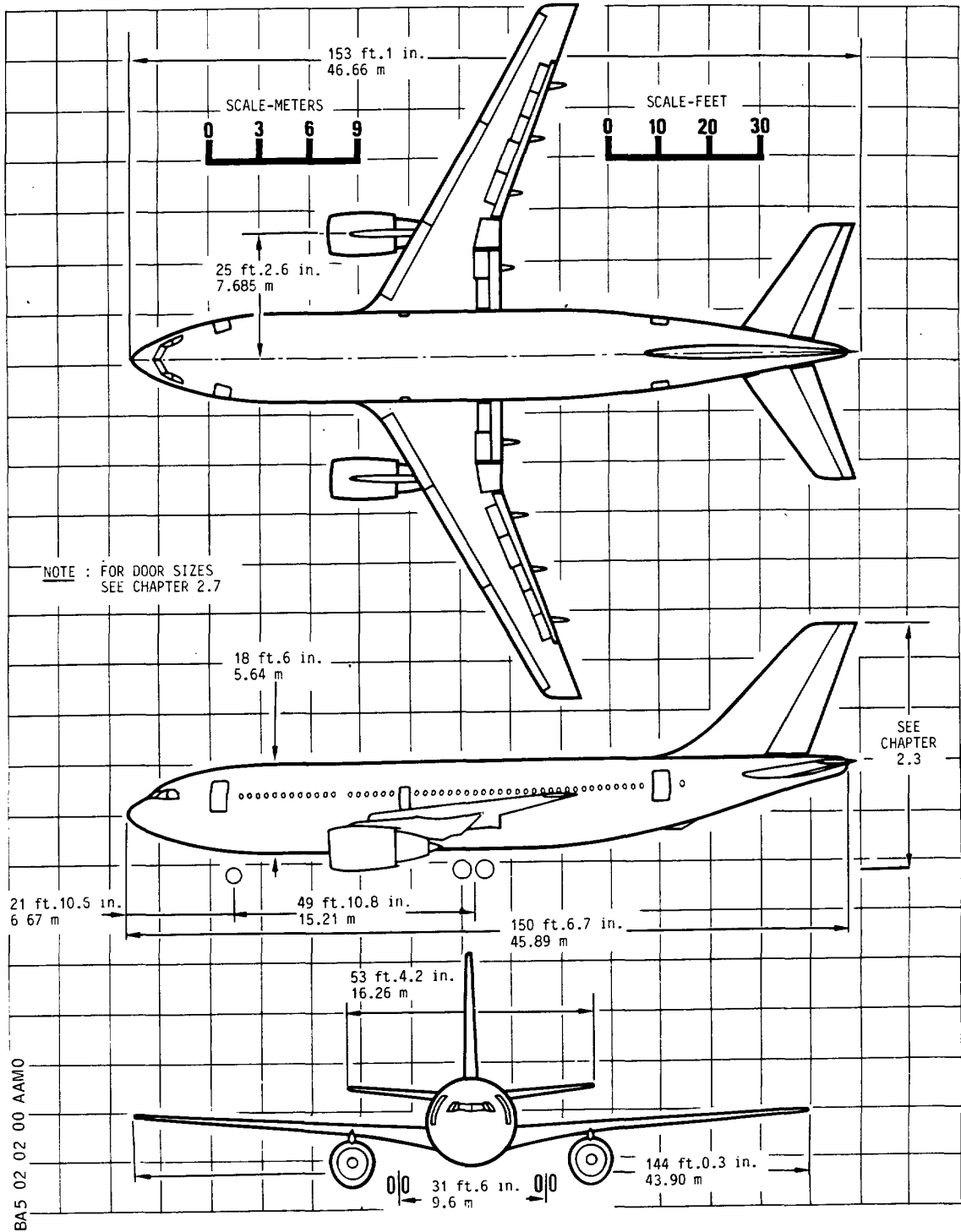

2.2 GENERAL AIRPLANE DIMENSIONS.

R

AIRPLANE CHARACTERISTICS FOR AIRPORT PLANNING

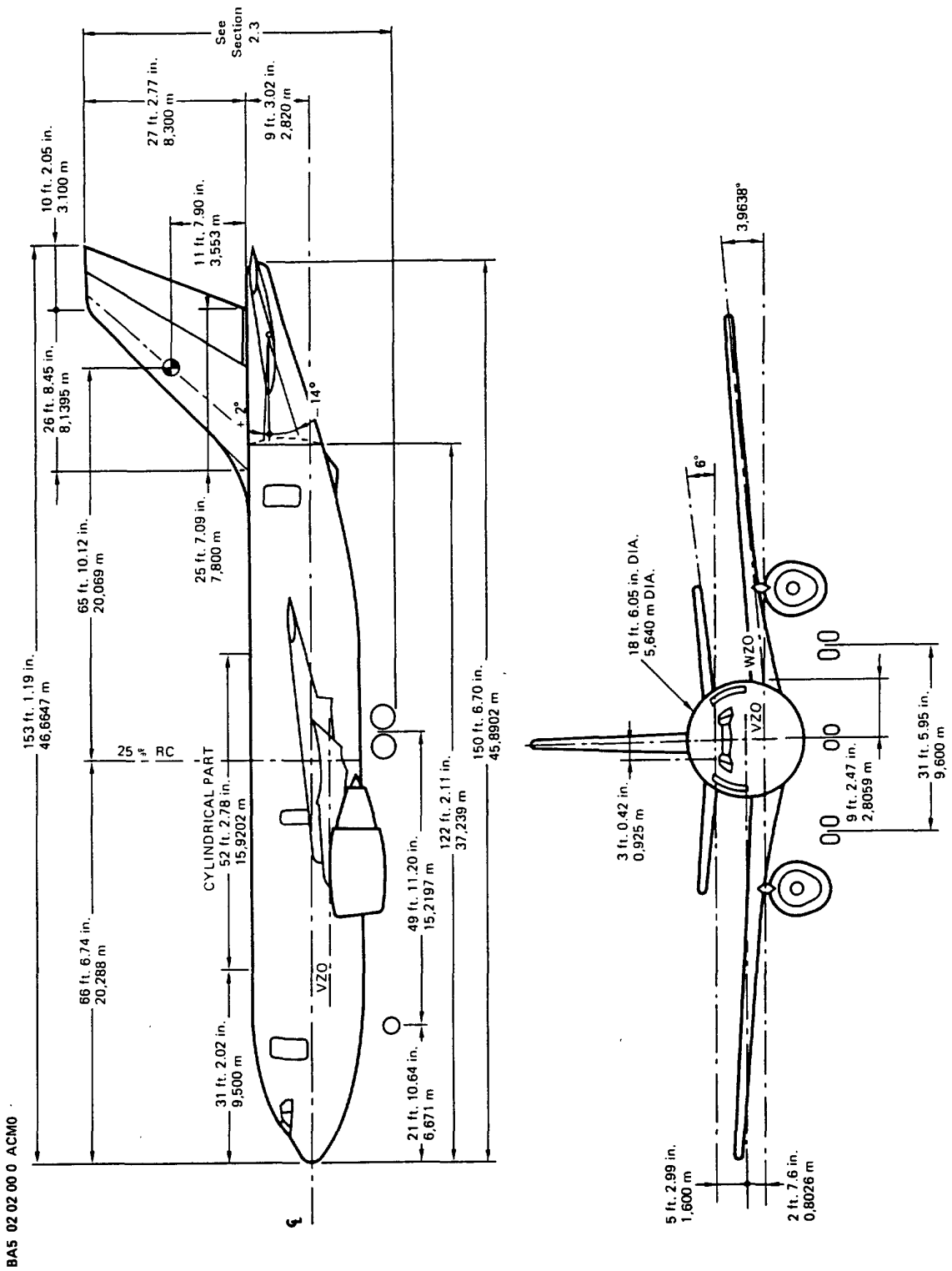

2.2 AIRPLANE DIMENSIONS



AIRPLANE CHARACTERISTICS

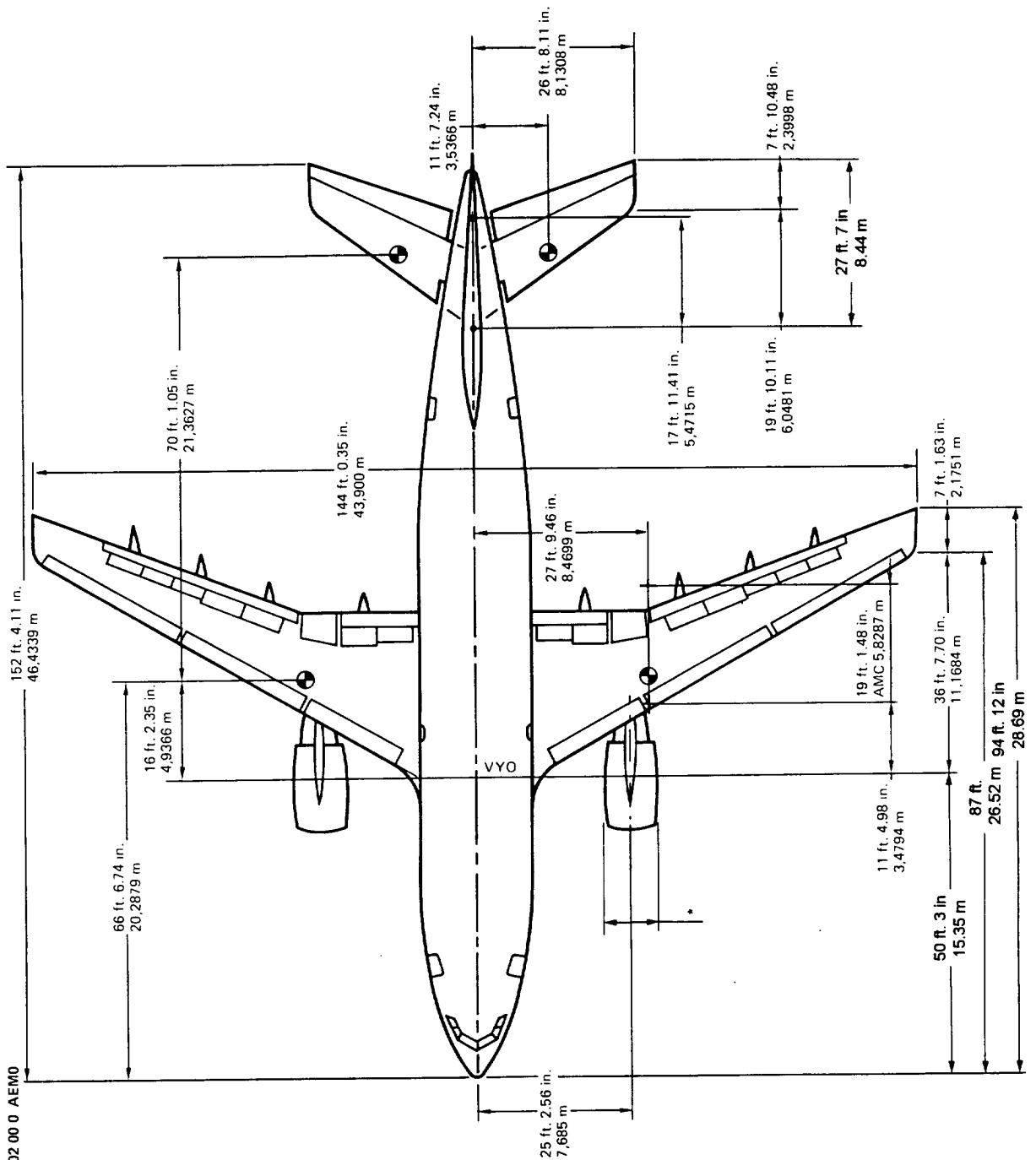

BA5 02 02 00 0 AEM0

- * PW JT9D : 2.718 m (107 in)
- GE CF6 : 2.918 m (114 in)
- PW 4000 : 2.768 m (109 in)

2.2 AIRPLANE DIMENSIONS

Chapter 2.2.0
Page 3
Nov /94

AIRPLANE CHARACTERISTICS FOR AIRPORT PLANNING

R
R

BA5 02 02 00 0 AGMO

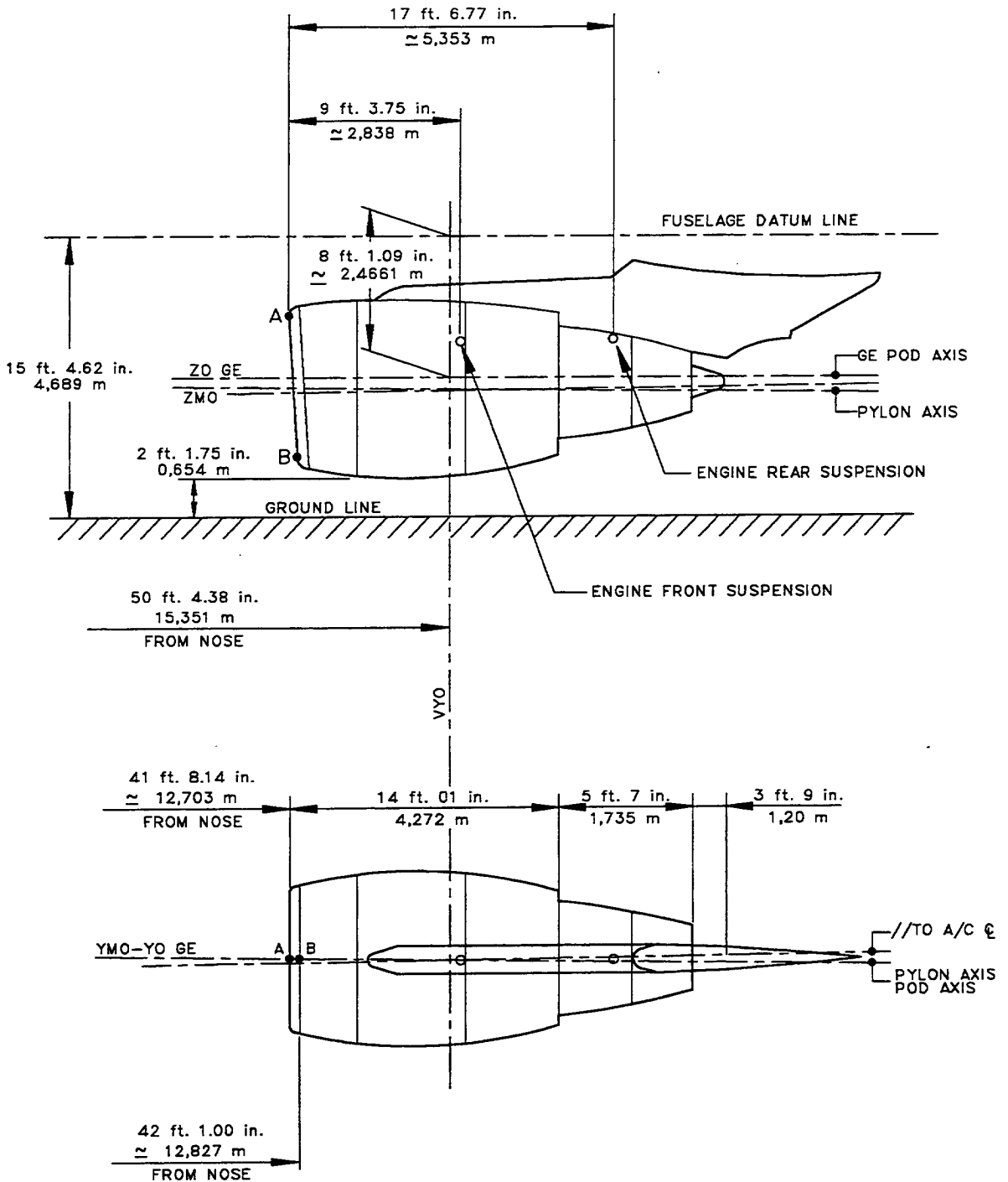

**2.2 AIRPLANE DIMENSIONS
2.2.1 GE ENGINE CF6-80A3**

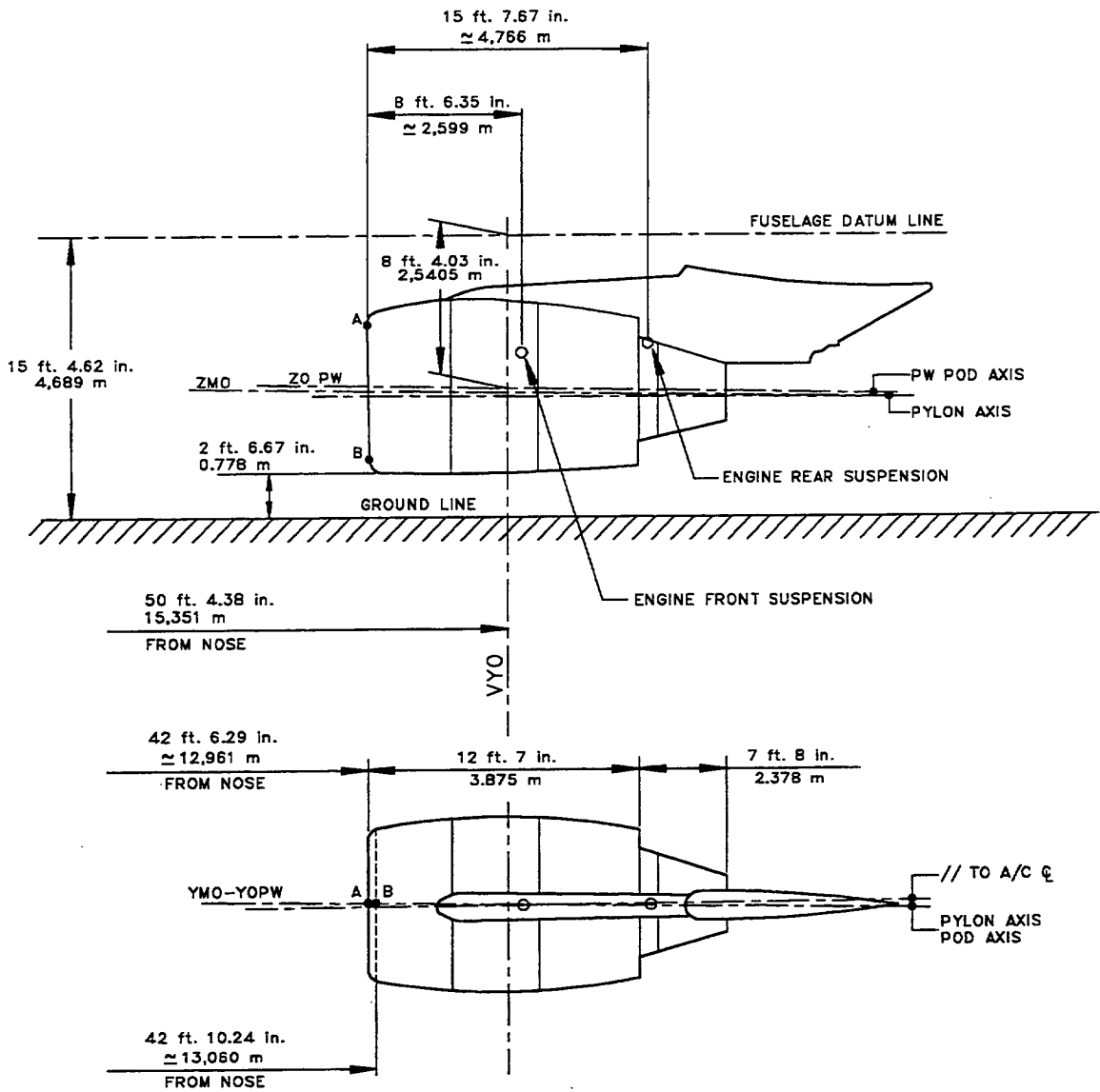

R
R
BA5 02 02 02 0 BGMO

2.2 AIRPLANE DIMENSIONS
2.2.2 ENGINES JT9D-7R4

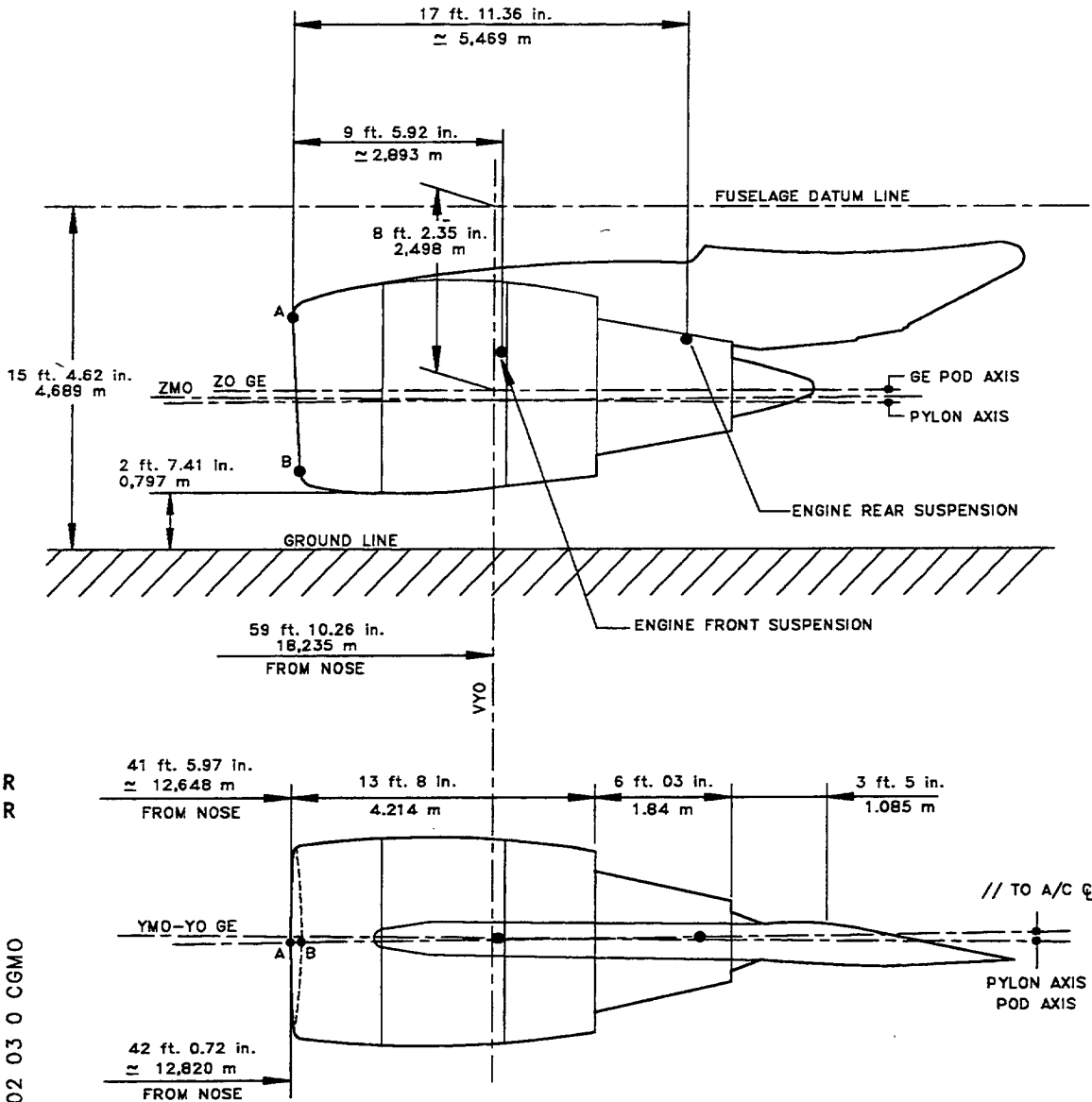

R
R
BA5 02 02 03 0 CGMO

2.2 AIRPLANE DIMENSIONS
2.2.3 ENGINE CF6-80C2



AIRPLANE CHARACTERISTICS FOR AIRPORT PLANNING

2.3.0 Ground Clearances

NOTE : The distances given in the Ground Clearances charts are reference distances calculated for A/C weight and CG conditions. The conditions used in the calculations are maximum A/C weight (minimum ground clearances) and a typical A/C maintenance weight (typical ground clearances for maintenance).

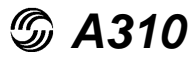

AIRPLANE CHARACTERISTICS FOR AIRPORT PLANNING

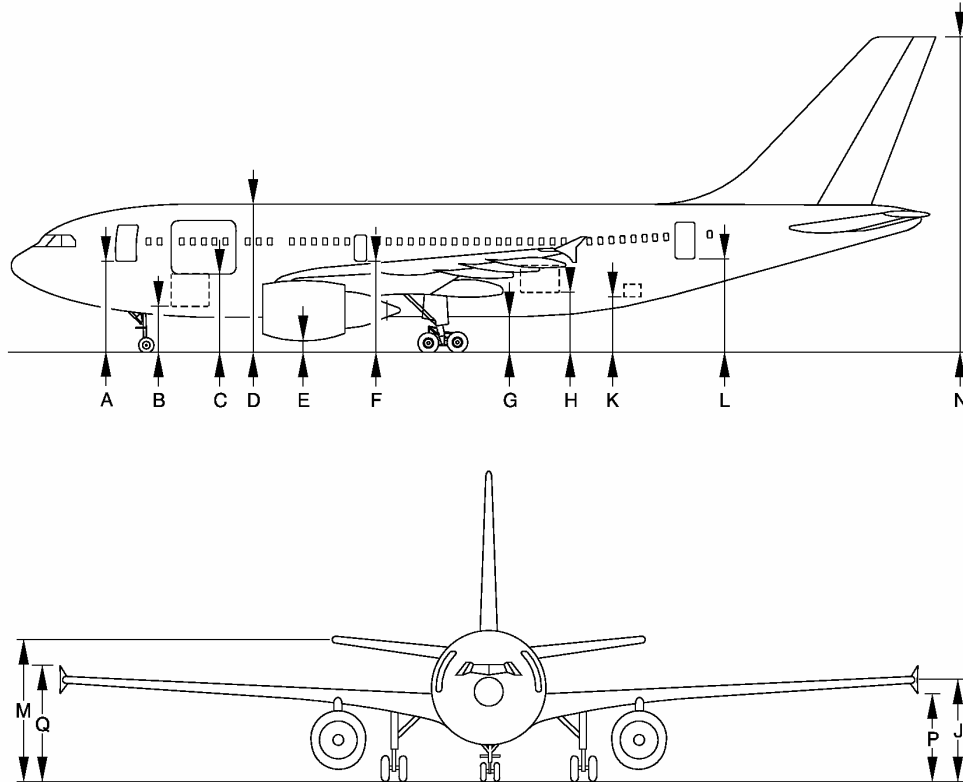

VERTICAL CLEARANCES							
	OPERATING WEIGHT EMPTY CG 25 %		MAXIMUM RAMP WEIGHT CG 18 %		MAXIMUM RAMP WEIGHT CG 35 %		
	m	ft	m	ft	m	ft	
MODEL C	A	4.536	14.88	4.421	14.50	4.530	14.86
	B	2.611	8.57	2.503	8.21	2.584	8.48
	C	4.610	15.12	4.505	14.78	4.573	15.00
	D	7.548	24.76	7.444	24.42	7.509	24.64
	E	varies between values 0.654 m (2.14 ft) and 0.778 m (2.55 ft)					
	F	4.573	15.00	4.481	14.70	4.502	14.77
	G	1.958	6.42	1.877	6.16	1.840	6.04
	H	2.720	8.92	2.640	8.66	2.592	8.50
	J	5.392	17.69	5.226	17.15	5.173	16.97
	K	2.751	9.03	2.676	8.78	2.603	8.54
	L	4.845	15.89	4.775	15.67	4.674	15.33
	M	7.301	23.95	7.246	23.77	7.060	23.16
	N	15.947	52.32	15.896	52.15	15.701	51.51
	P	4.70	15.42	4.53	14.88	4.48	14.70
Q	6.10	20.00	5.92	19.42	5.90	19.35	

BA5 02 03 00 5 AAM0 00

2.3 Ground Clearances Model 200 and 200C



AIRPLANE CHARACTERISTICS FOR AIRPORT PLANNING

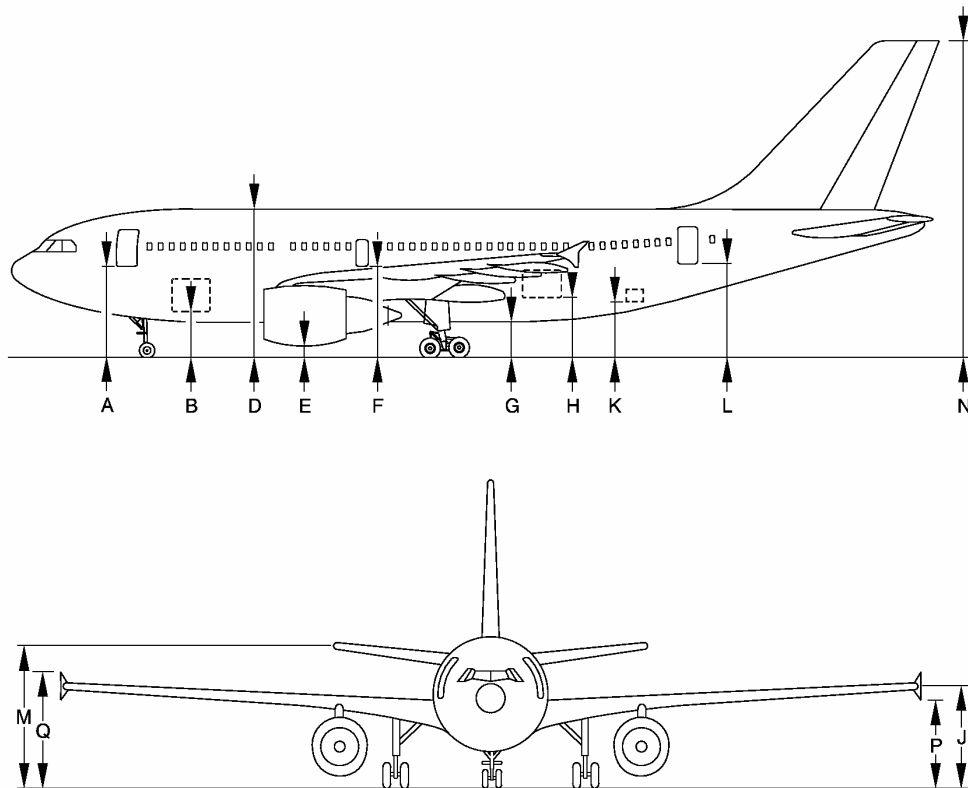

VERTICAL CLEARANCES						
	OPERATING WEIGHT EMPTY CG 25 %		MAXIMUM RAMP WEIGHT CG 18 %		MAXIMUM RAMP WEIGHT CG 35 %	
	m	ft	m	ft	m	ft
A	4.548	14.92	4.416	14.49	4.534	14.88
B	2.623	8.61	2.498	8.20	2.586	8.48
D	7.560	24.80	7.439	24.41	7.511	24.64
E	0.667	2.19	0.650	2.13	0.793	2.60
F	4.582	15.03	4.472	14.67	4.494	14.74
G	1.942	6.37	1.843	6.05	1.803	5.92
H	2.700	8.86	2.602	8.54	2.550	8.37
J	5.378	17.64	5.193	17.04	5.136	16.85
K	2.717	8.91	2.623	8.61	2.544	8.35
L	4.802	15.75	4.713	15.46	4.603	15.10
M	7.220	23.69	7.145	23.44	6.942	22.78
N	15.867	52.06	15.796	51.82	15.584	51.13
P	4.66	15.28	4.48	14.69	4.43	14.53
Q	6.09	19.97	5.89	19.31	5.83	19.12

BA5 02 03 00 5 AEM0 00

2.3 Ground Clearances Model 300

BA5 02 04 01 AAM0

R

NOTE : FOR DOOR SIZES
SEE CHAPTER 2.7

237 SEATS ALL TOURISTI CLASS

34 in. PITCH. 8 ABREAST, 2-2/2-2

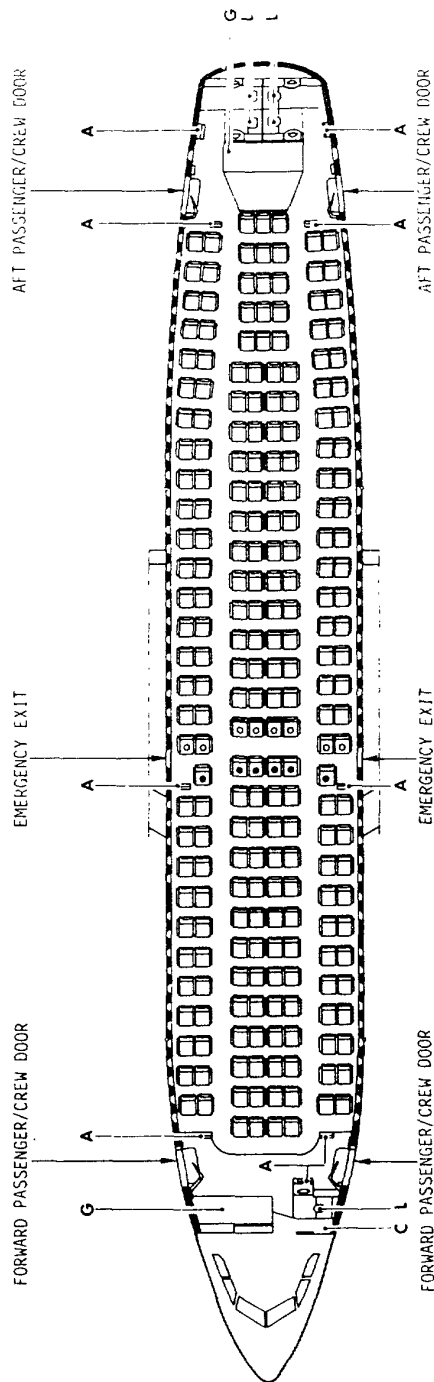

ITEM	DESIGNATION
A	ATTENDANT SEAT
C	COAT STORAGE
G	GALLEY
L	LAVATORY

2.4 INTERIOR ARRANGEMENTS
2.4.1 PASSENGERS
MODEL 200

BA5 02 04 01 ACMO

NOTE : FOR DOOR SIZES
SEE CHAPTER 2.7

243 SEATS ALL TOURIST CLASS
34 in. PITCH. 8 ABREAST. 2-2/2-2

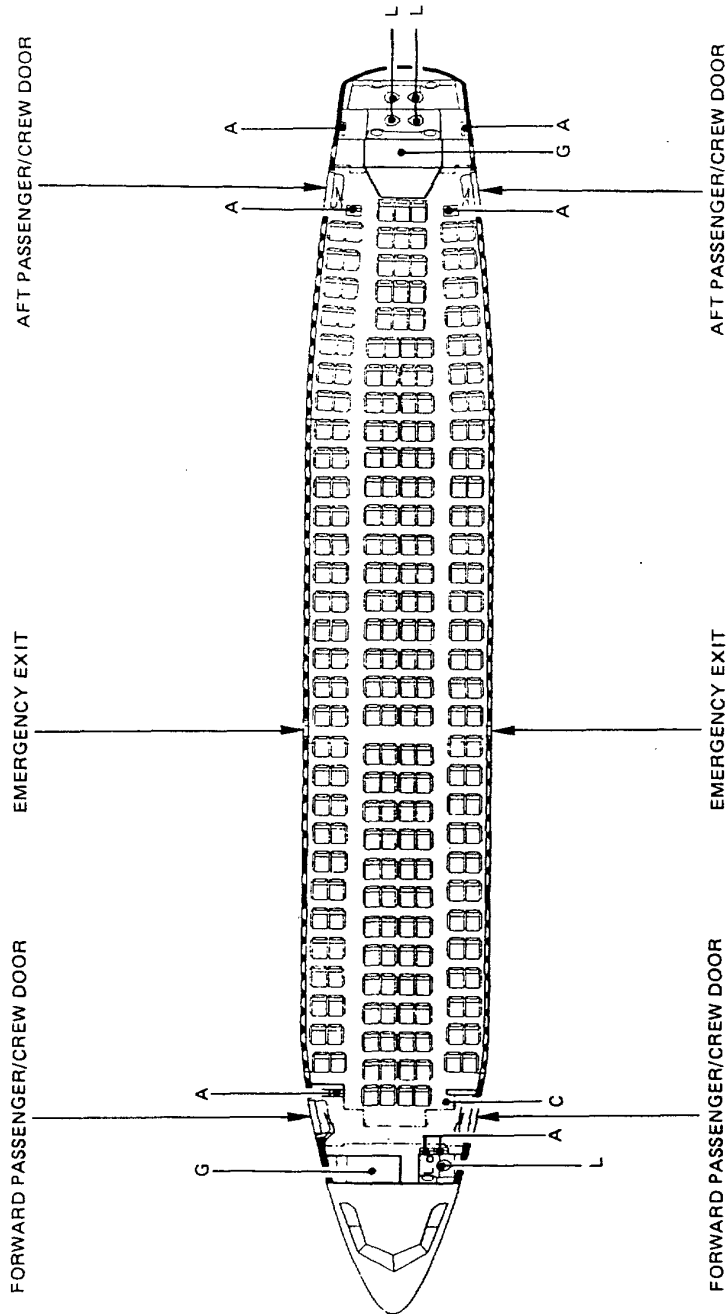

ITEM	DESIGNATION
A	ATTENDANT SEAT
C	COAT STOWAGE
G	GALLEY
L	LAVATORY

2.4 INTERIOR ARRANGEMENT
2.4.1 PASSENGERS
MODEL 300



AIRPLANE CHARACTERISTICS FOR AIRPORT PLANNING

BA5 02 04 01 0 ACMO

NOTE : FOR DOOR SIZES
SEE CHAPTER 2.7

265 SEATS ALL TOURIST CLASS

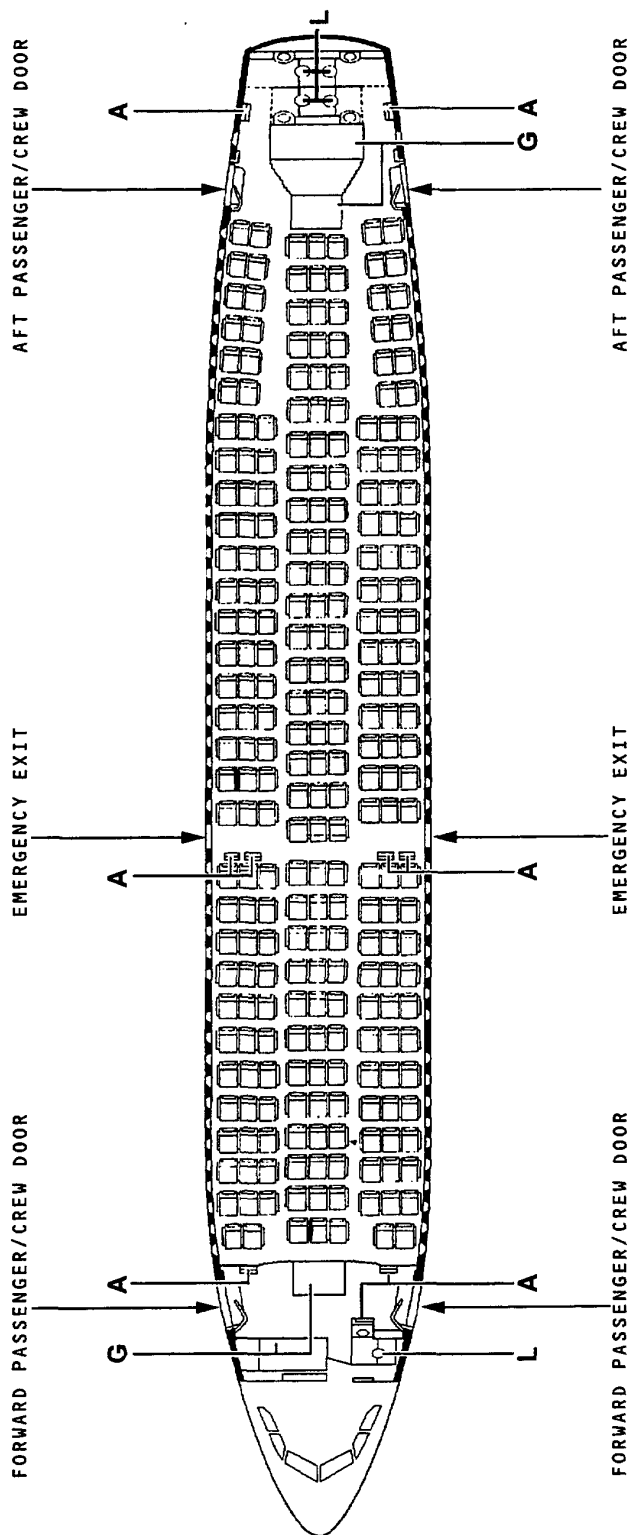

ITEM	DESIGNATION
A	ATTENDANT SEAT (9)
G	GALLEY (4)
L	LAVATORY (5)

2.4 INTERIOR ARRANGEMENT
2.4.1 PASSENGERS

N

Printed in France

BA5 02 04 02 AAMO

R

16 PALLETS 88 x 125 in. (2.235 x 3.175 m)

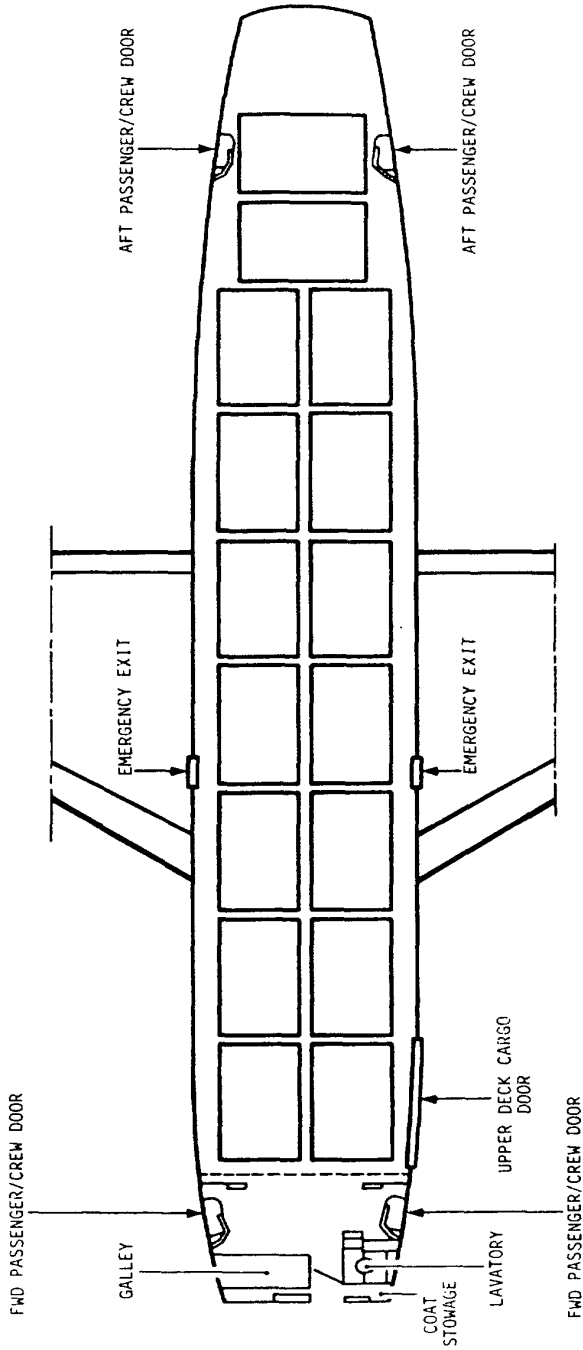

2.4 INTERIOR ARRANGEMENTS
2.4.2 CARGO (16 PALLETS)
MODEL C

BA5 02 04 02 ACMO

R

12 PALLETS 88 x 125 in. (2.235 x 3.175 m)

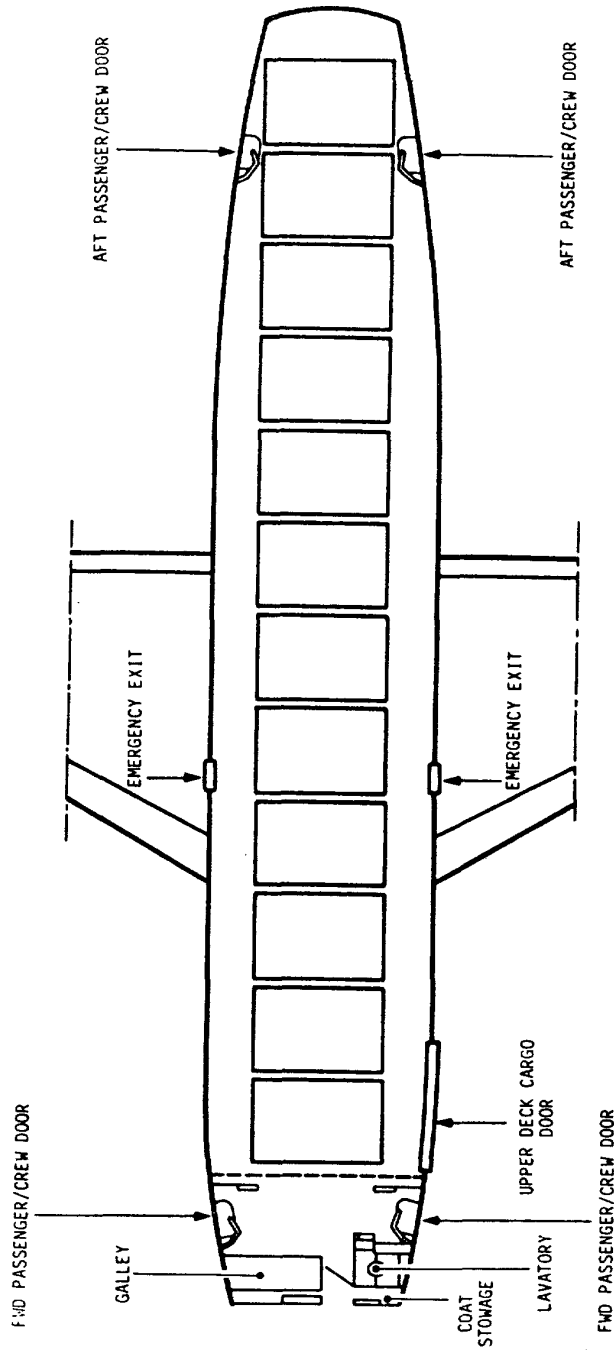

2.4 INTERIOR ARRANGEMENTS
2.4.2 CARGO (12 PALLETS)
MODEL C

BA5 02 04 02 ACMO

R

12 PALLETS 88 x 108 in. (2.235 x 2.743 m)

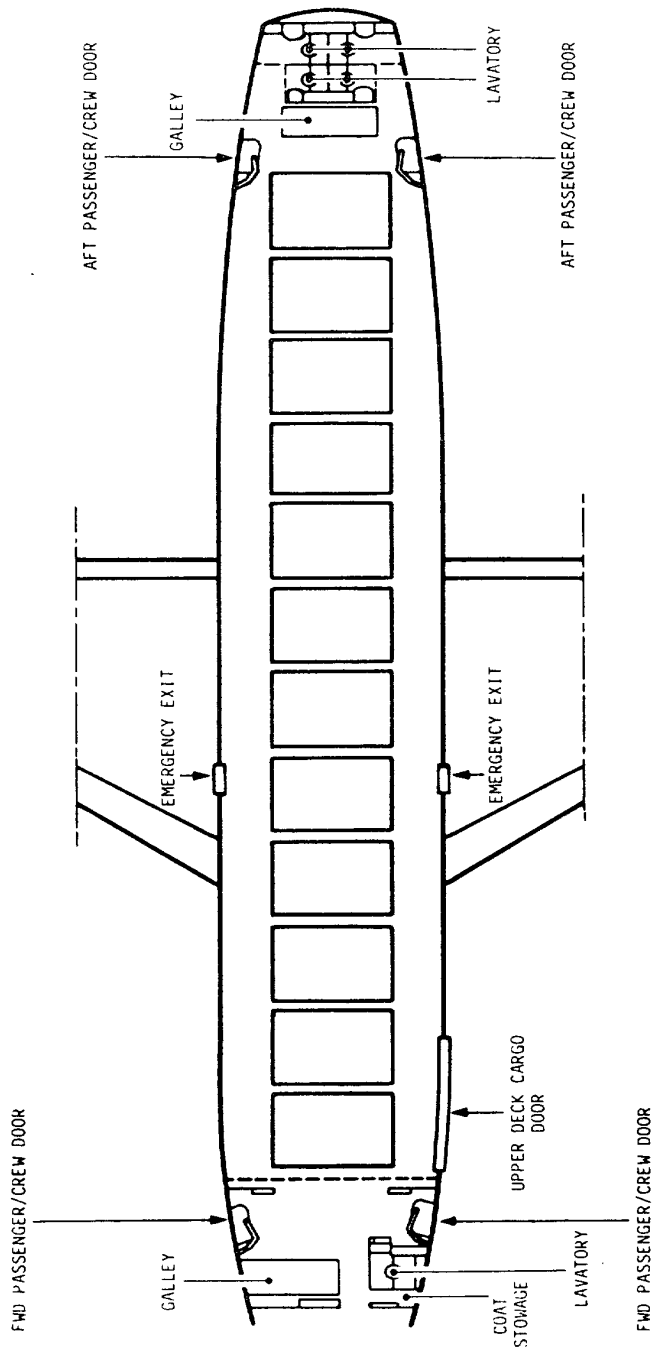

2.4 INTERIOR ARRANGEMENTS
2.4.2 CARGO (12 PALLETS)
MODEL C

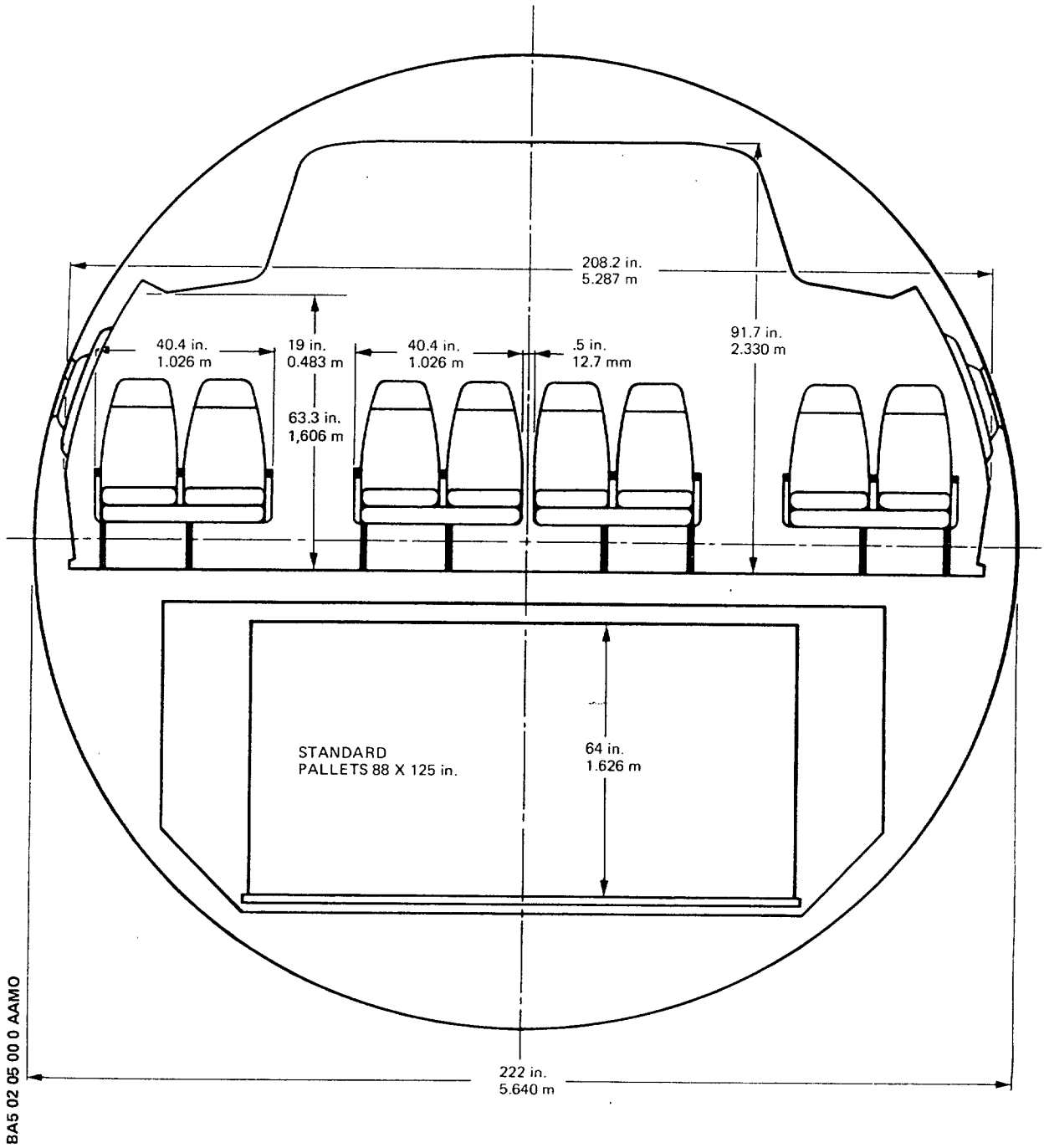

2.5 PASSENGER COMPARTMENT CROSS SECTION

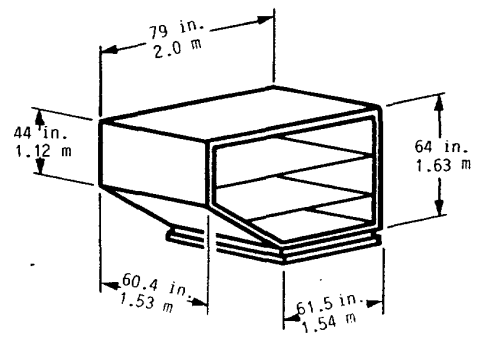
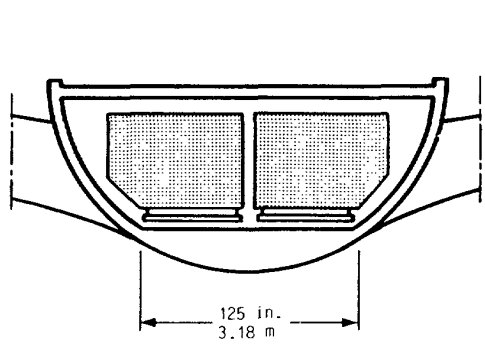
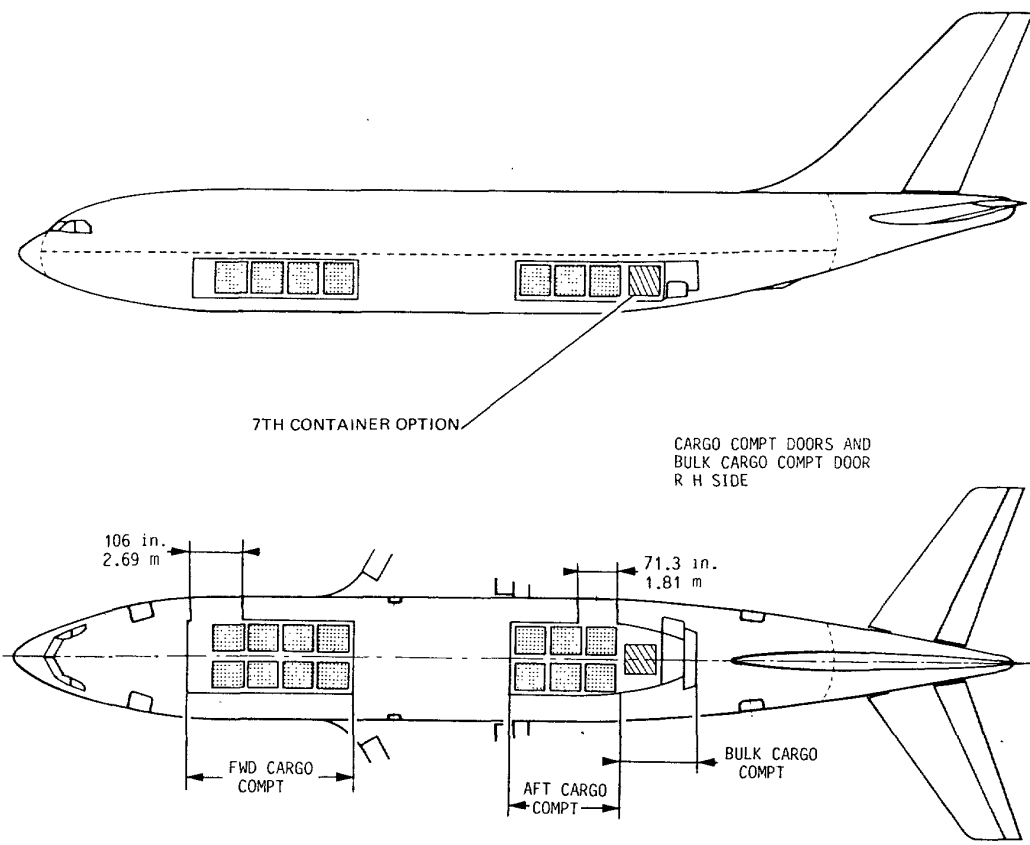

BA5 02.06 010 AAM0

2.6 LOWER COMPARTMENT CONTAINERS
2.6.1 CONTAINERS

Printed in France

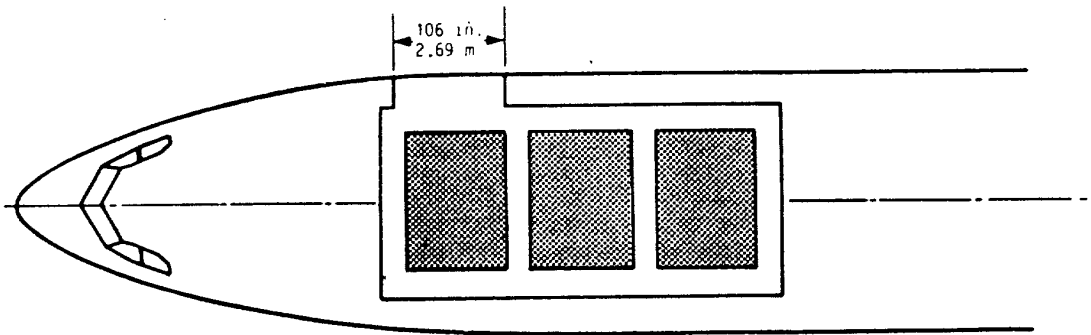
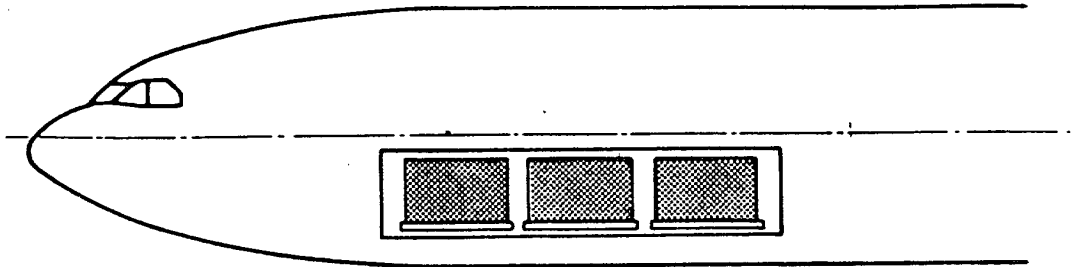

3 PALLETS FWD CARGO COMPT ONLY.
ENTRY DOOR R H SIDE

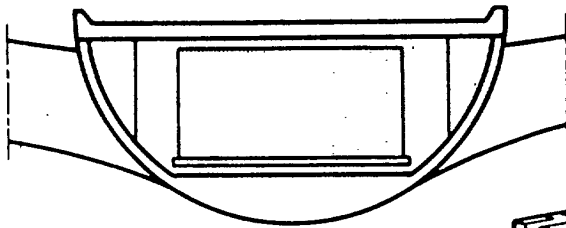

	A	
in.	88	96
m	2.23	2.44

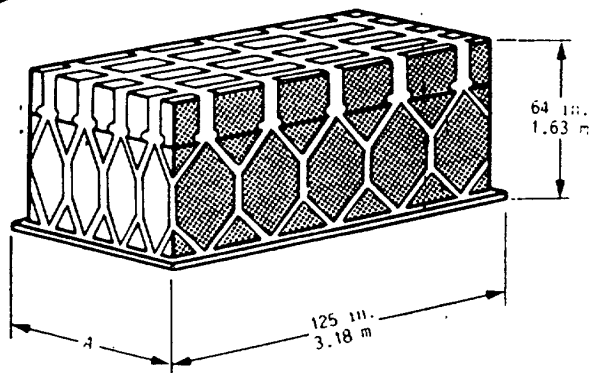

BA5 02 06 02 AAM10

2.6 LOWER COMPARTMENT
2.6.2 PALLETS IN FORWARD CARGO COMPARTMENT

R

Printed in France

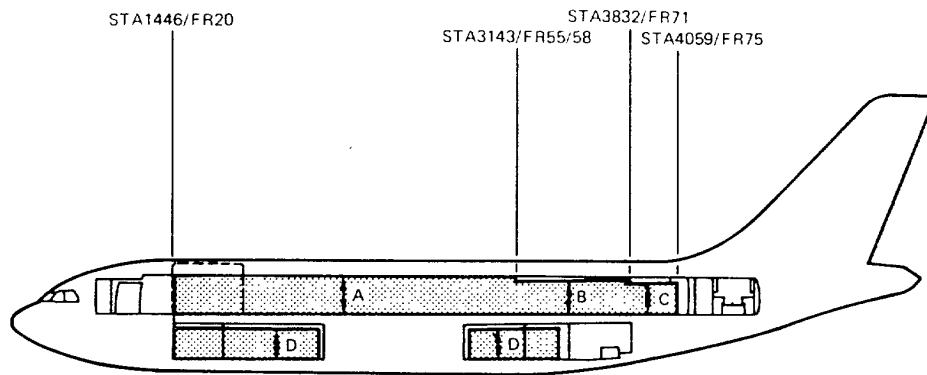

PERMISSIBLE CARGO HEIGHT

- A = 2.222 m (87.5 in)
- B = 2.197 m (86.5 in)
- C = 2.006 m (79.0 in)
- D = 1.625 m (64.0 in)

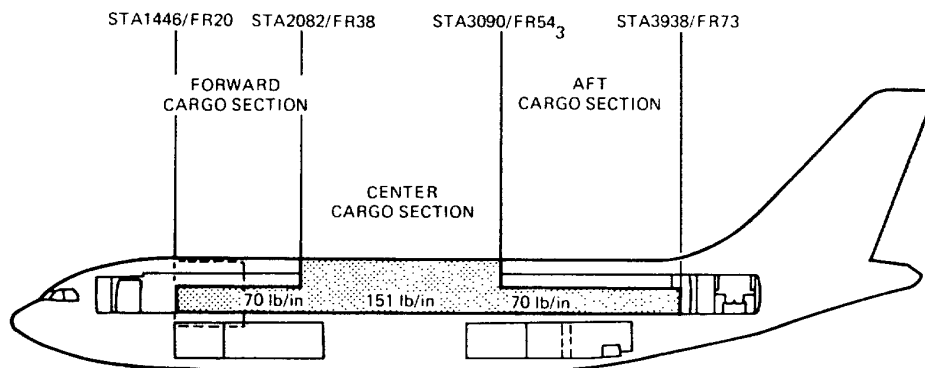

LOCAL FLOOR LOADS

BA5 02 06 03 AAWO

**2.6.3 UPPER DECK CARGO COMPARTMENT
MODEL 200C**

N

- 2.7 DOOR CLEARANCES
- 2.7.1 Forward Passenger/Crew Door
- 2.7.2 Emergency Exit
- 2.7.3 Aft Passenger/Crew Door
- 2.7.4 Forward Cargo Compartment Door
- 2.7.5 Bulk Cargo Compartment Door
- 2.7.6 Aft Cargo Compartment Door
- R 2.7.7 **Upper Deck Cargo Door**
- 2.7.8 Radome Travel
- 2.7.9 Main Landing Gear Door

Printed in France

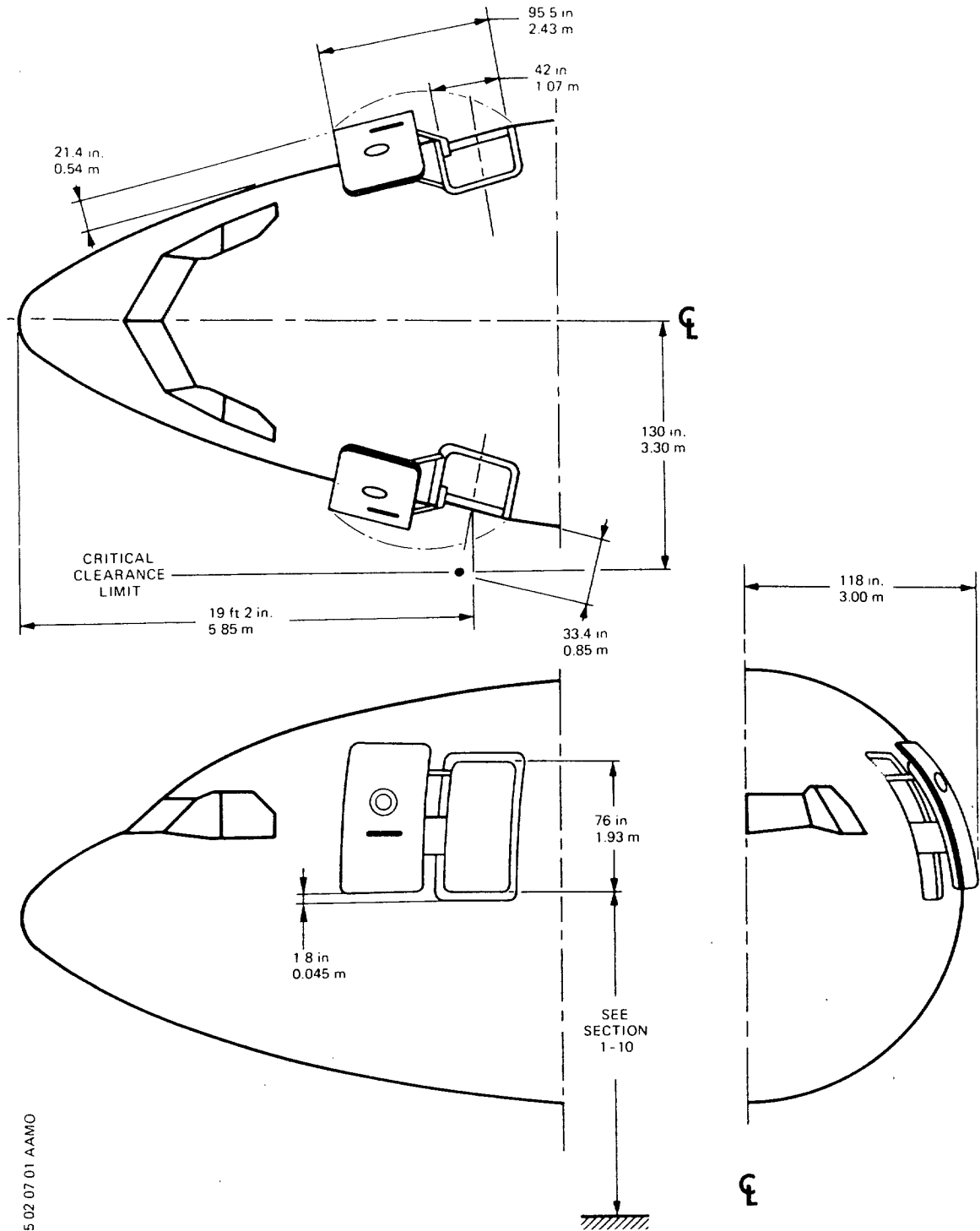

BA5 02 07 01 AAMO

2.7 DOOR CLEARANCES
2.7.1 FORWARD PASSENGER/CREW DOOR

R

Printed in France

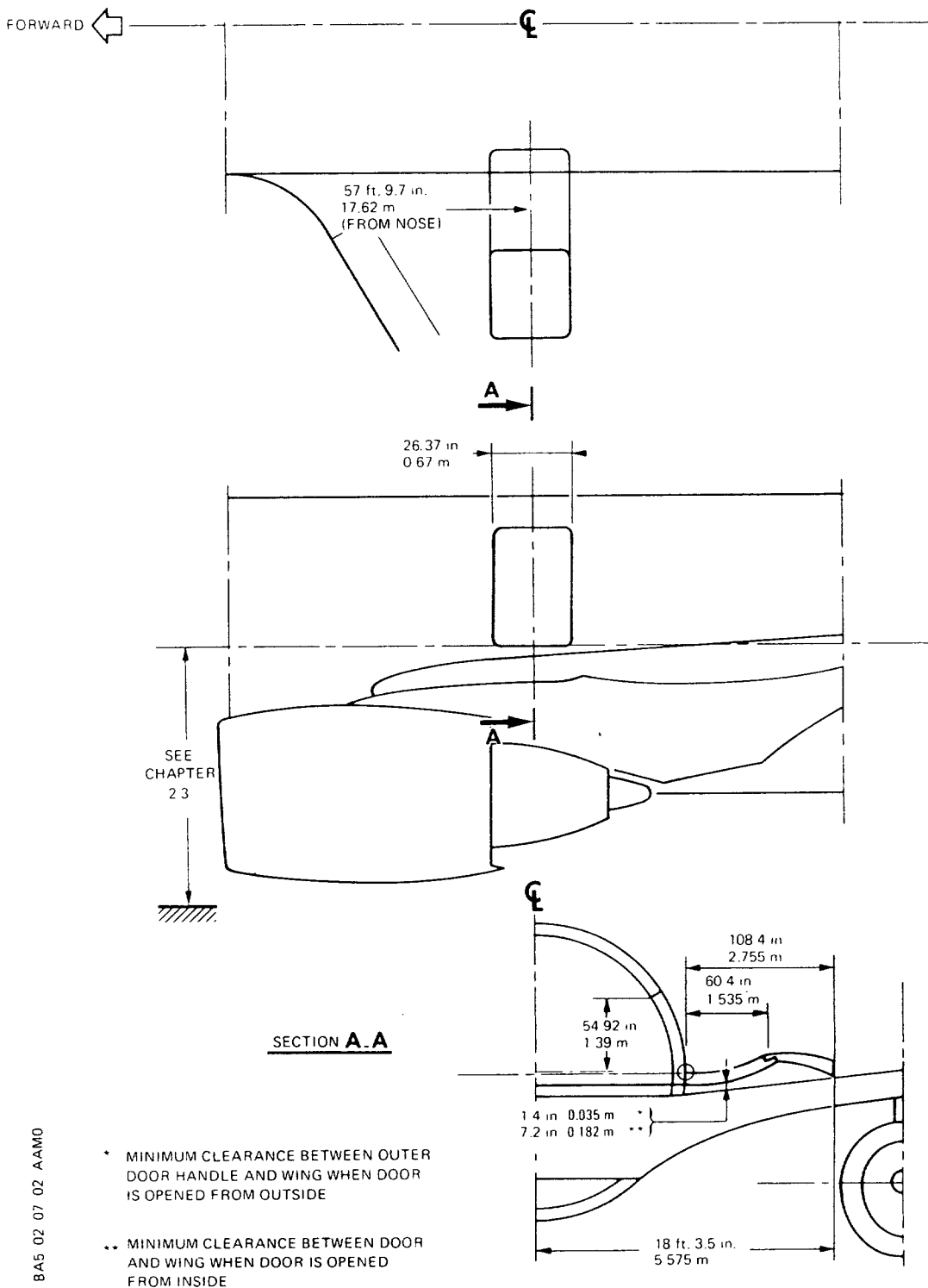

BA5 02 07 02 AAM0

2.7 DOOR CLEARANCES
2.7.2 EMERGENCY EXIT

Printed in France

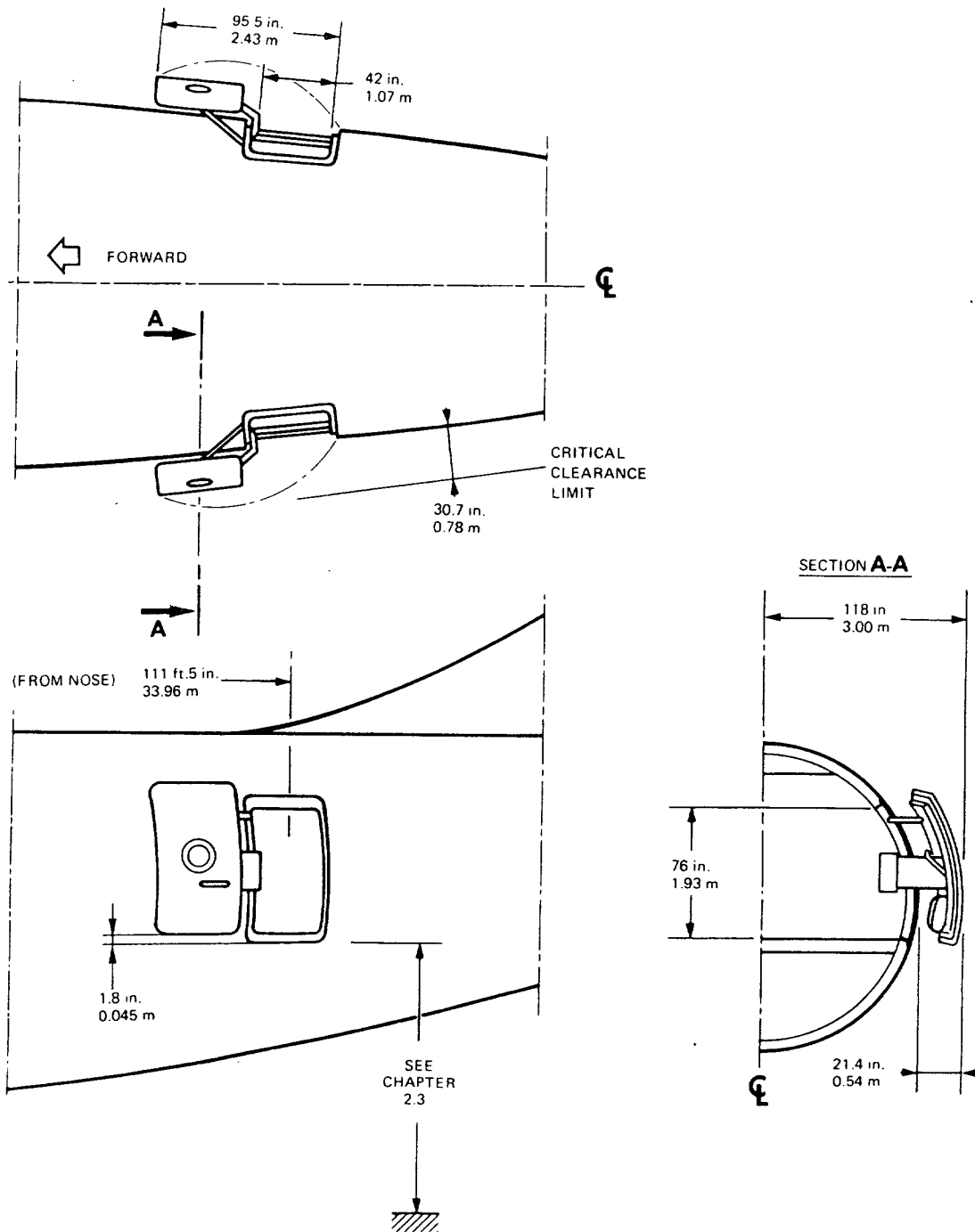

BA5 02 07 03 AAMO

2.7 DOOR CLEARANCES
2.7.3 AFT PASSENGER/CREW DOOR

R

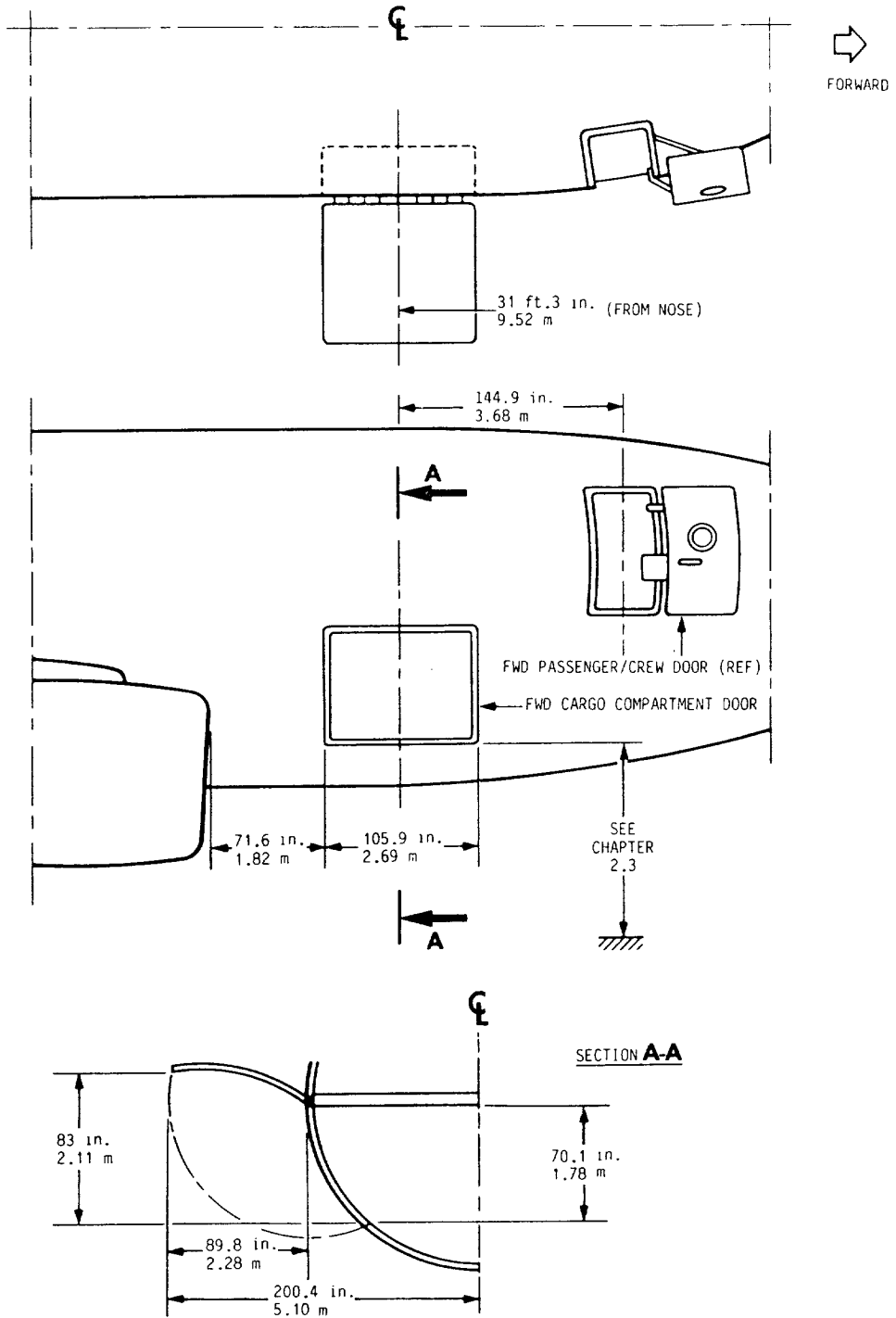

BA5 02 07 04 AAMD

2.7 DOOR CLEARANCES
2.7.4 FORWARD CARGO COMPARTMENT DOOR

Printed in France

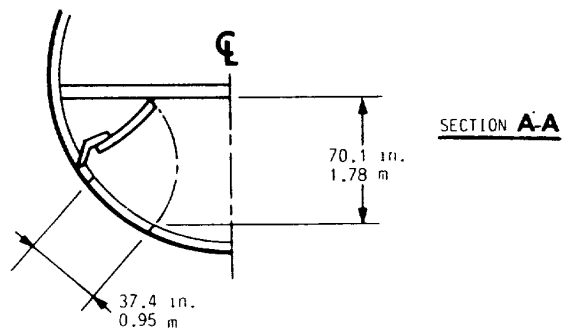
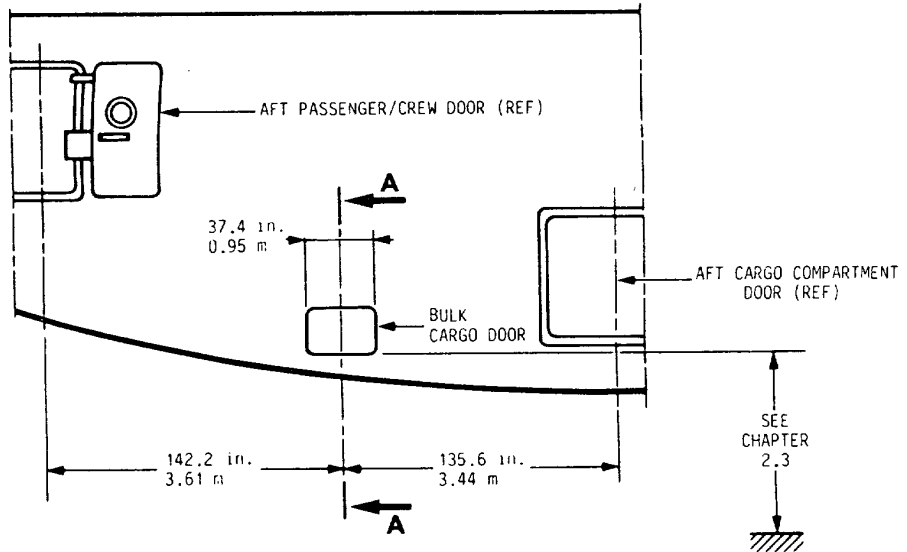
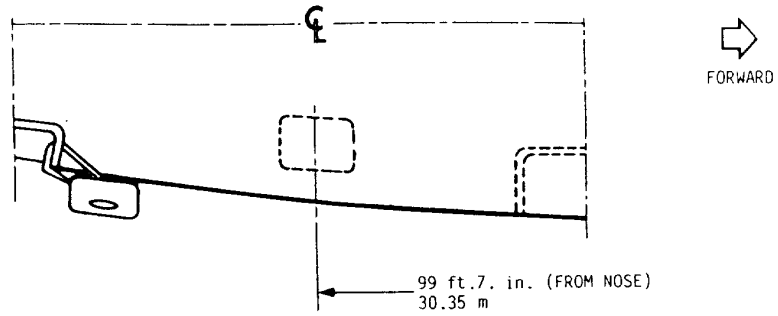

BA5 02 07 05 AAM0

2.7 DOOR CLEARANCES
2.7.5 BULK CARGO COMPARTMENT DOOR

R

Printed in France

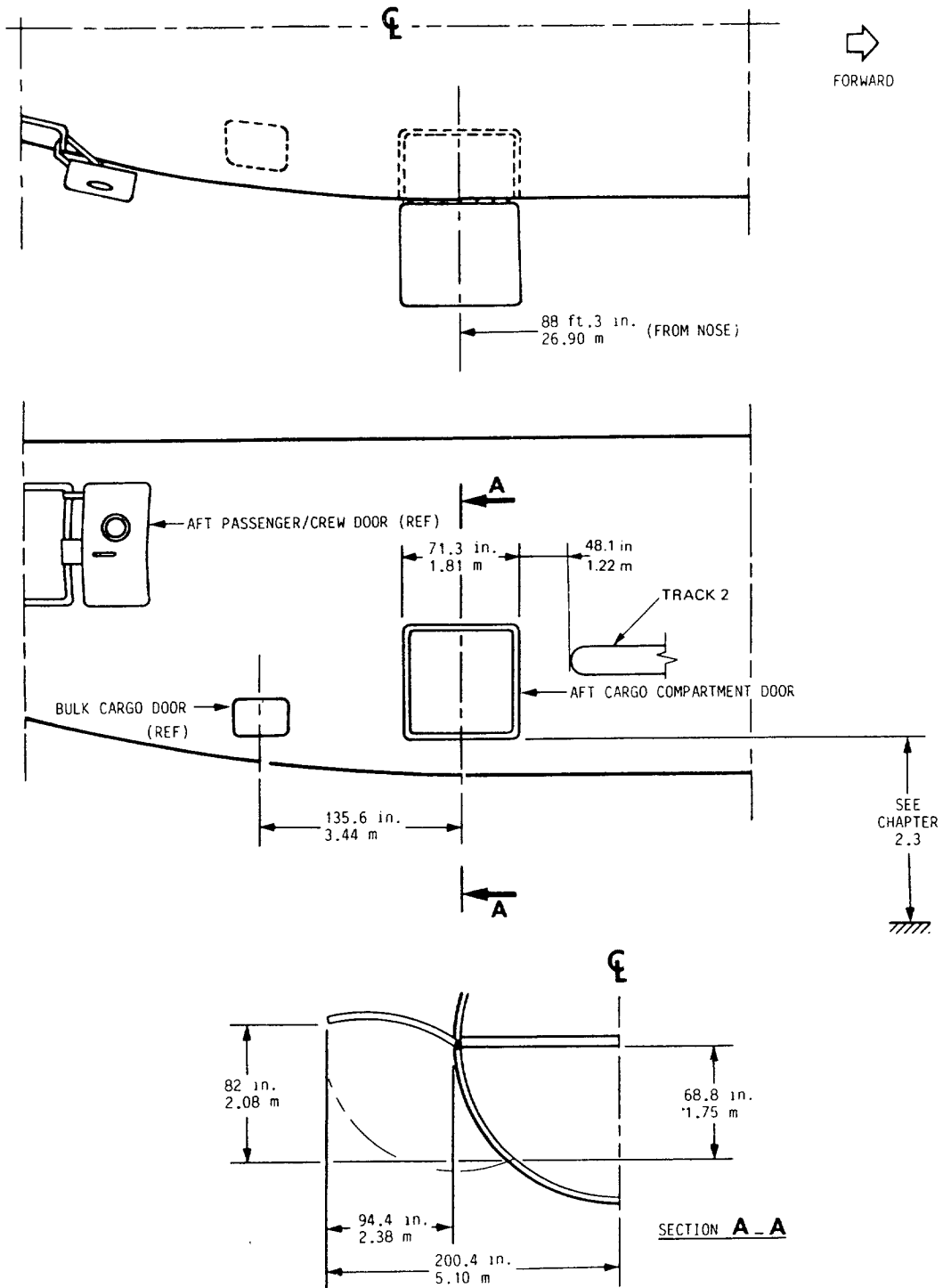

2.7 DOOR CLEARANCES
2.7.6 AFT CARGO COMPARTMENT DOOR

BA5 02 07 06 AAM0

R

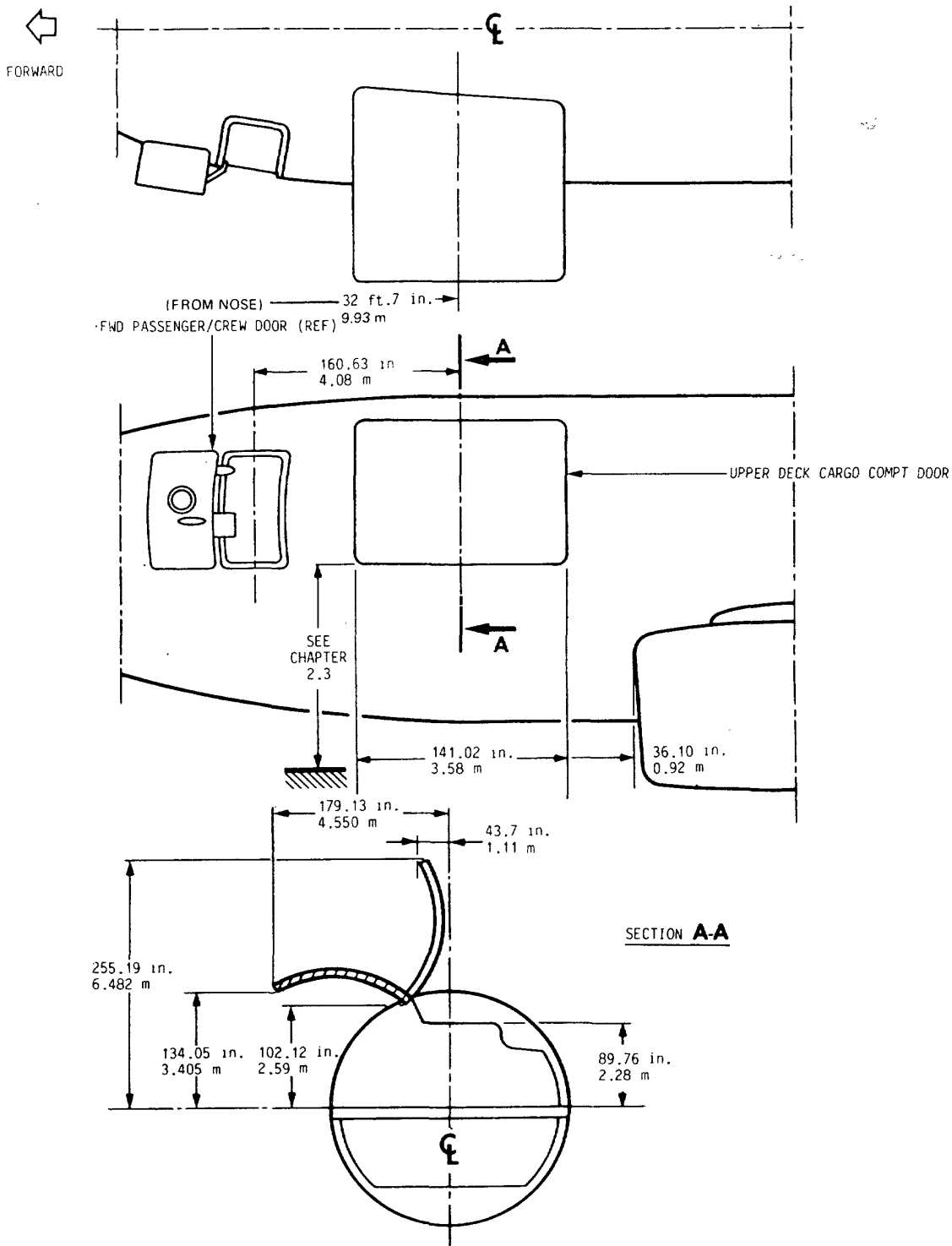

2.7 DOOR CLEARANCES
2.7.7 UPPER DECK CARGO DOOR
MODEL 200C

Printed in France

BA5 02 07 07 AAM0

R

Printed in France

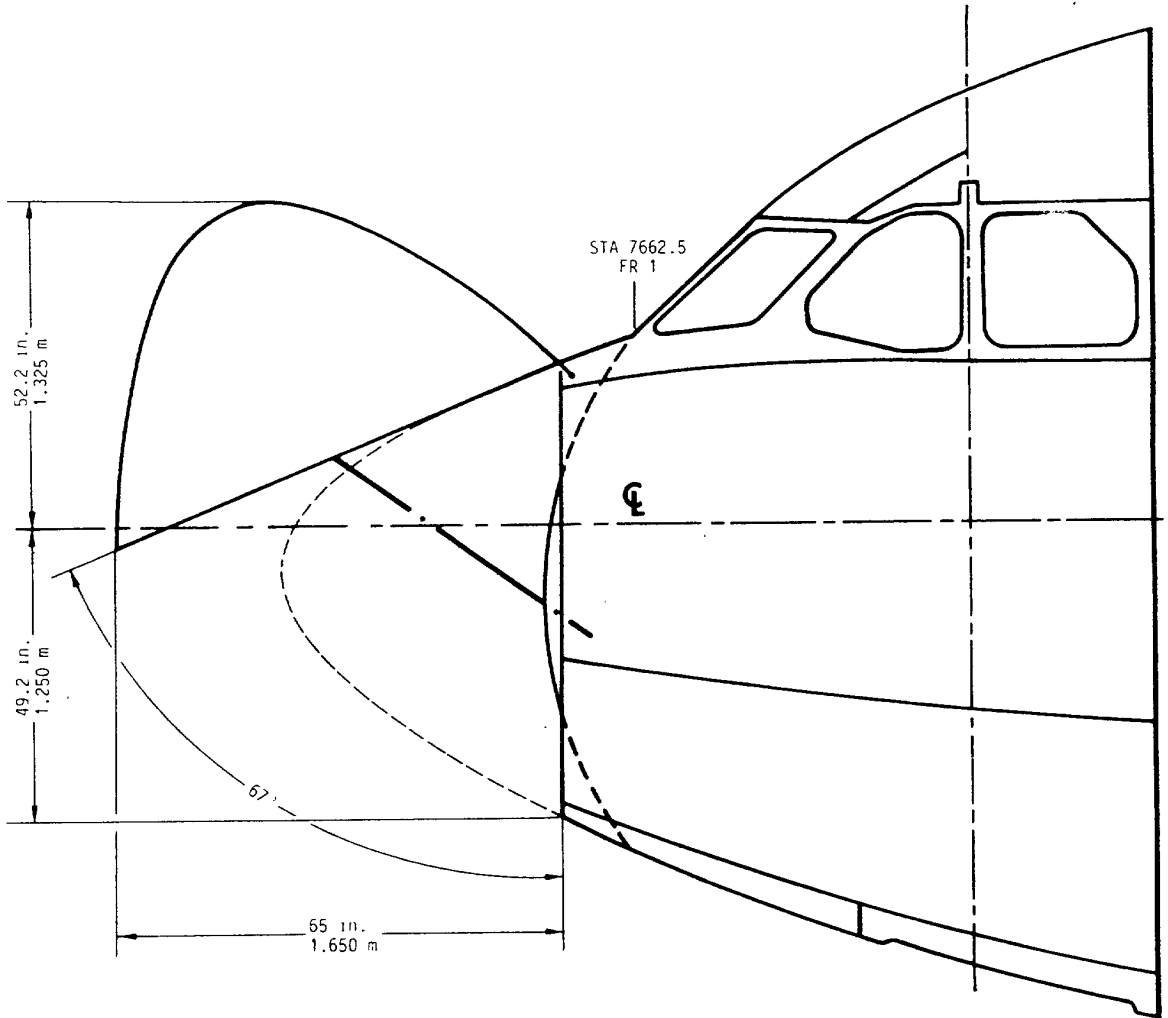

BAS 02 07 03 AAM0

2.7 DOOR CLEARANCES
2.7.8 RADOME TRAVEL

R

Printed in France

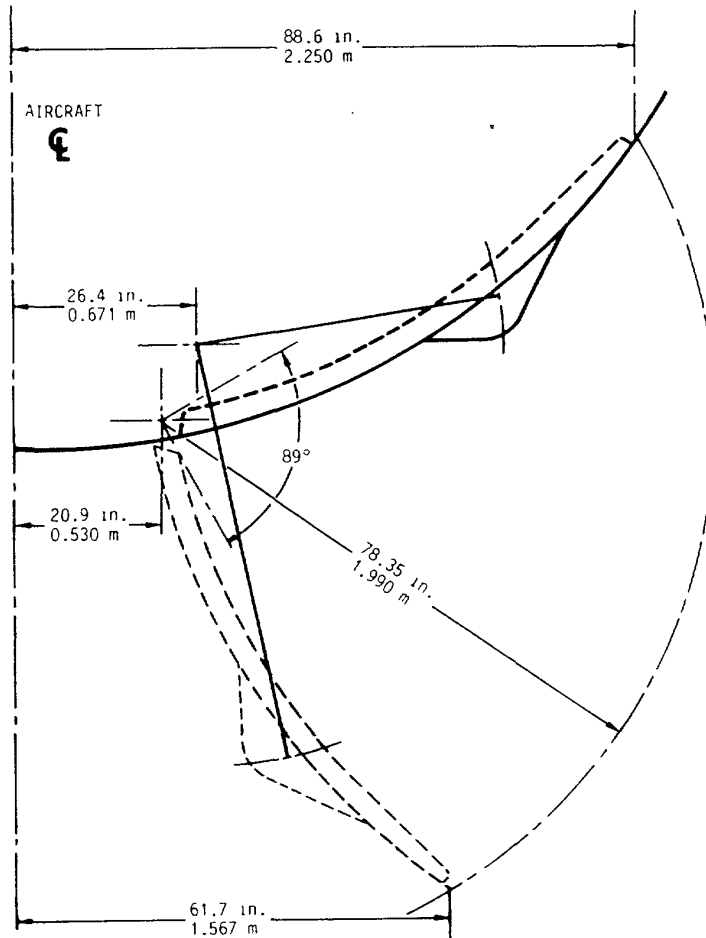
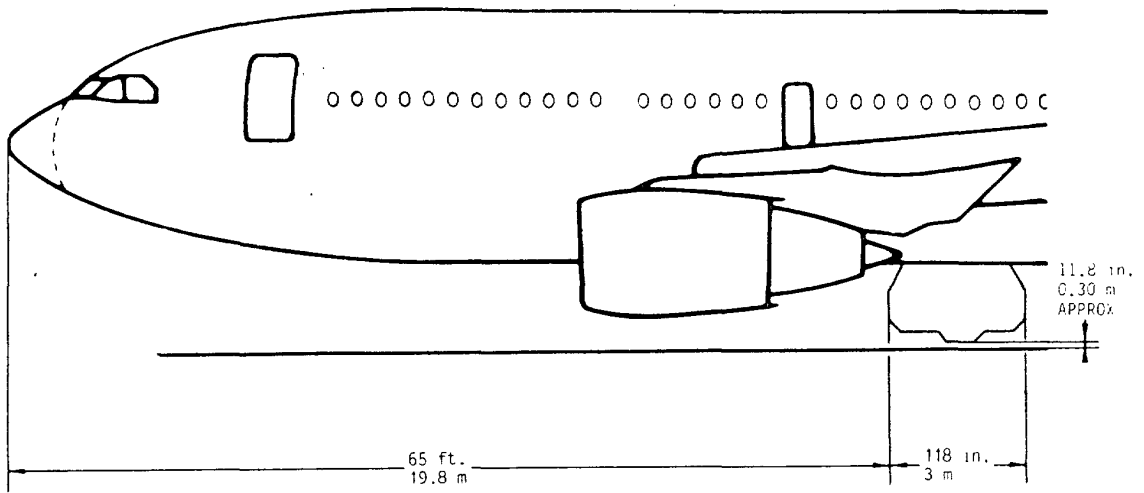

BA5 02 07 09 AAM0

2.7 DOOR CLEARANCES
2.7.9 MAIN LANDING GEAR DOOR

R



AIRPLANE CHARACTERISTICS FOR AIRPORT PLANNING

3.0	AIRPLANE PERFORMANCE
3.1	General Information
3.2	Payload Range
3.2.1	Long Range Cruise ISA Conditions
3.3	FAR Take off Runway Length Requirements
3.3.1	ISA Conditions
3.3.2	ISA various Conditions
3.4	FAR Landing Runway Requirements
3.4.1	All Ambient Temperatures
R 3.5	Final Approach Speed
R 3.5.1	Final Approach Speed at 1.3 V_S



AIRPLANE CHARACTERISTICS FOR AIRPORT PLANNING

3.1 General Information

Section 3.2 indicates payload range information at specific altitudes recommended for long range cruise with a given fuel reserve condition.

Section 3.3 represents FAR takeoff runway length requirements at ISA and ISA + 15.3°C (59°F) for PW JT9D-7R4 engines and ISA + 18.3°C (65°F) for GE CF6-80A3 engines conditions for FAA certification.

Section 3.4 represents FAR landing runway length requirements for FAA certification.

R Section 3.5 indicates Final approach speeds.

Standard day temperatures for the altitudes shown are tabulated below:

R

Altitude		ISA Temperature	
FEET	METERS	°F	°C
0	0	59	15.
2000	610	51.9	11.6
4000	1220	44.7	7.1
6000	1830	37.6	3.1
8000	2440	30.5	-0.8

Printed in France

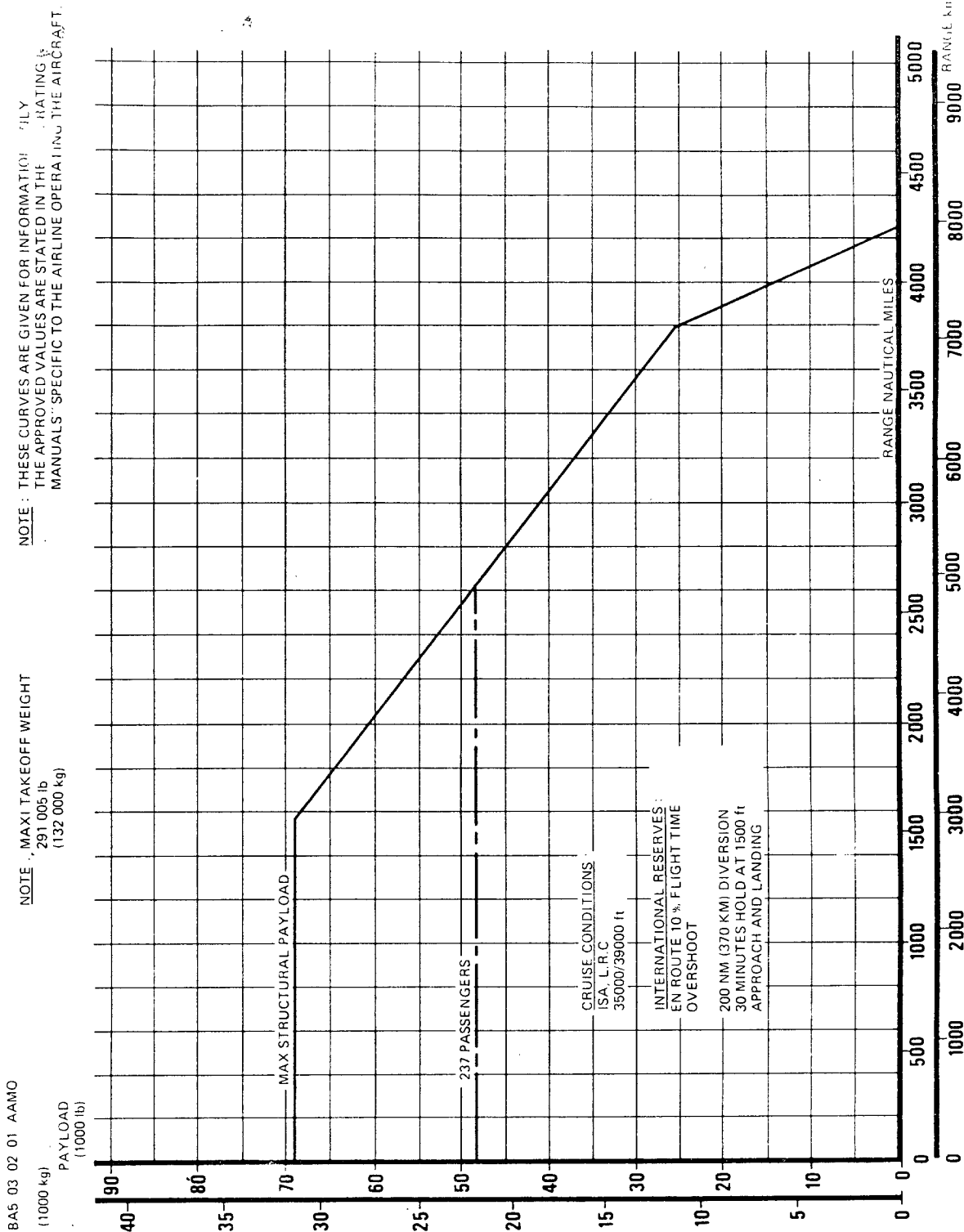

BA5 03 02 01 AAMO

3.2 PAYLOAD RANGE
3.2.1 PAYLOAD RANGE LONG RANGE CRUISE
GE - CF6 - 80 A3 ENGINE
MODEL 200 - 132 T

R

BA5 03 02 01 ACMO
 (1000 kg)
 PAYLOAD
 (1000 lb)

NOTE : MAXI TAKEOFF WEIGHT
 291005 lb
 (132000 kg)

NOTE : THESE CURVES ARE GIVEN FOR INFORMATION ONLY
 THE APPROVED VALUES ARE STATED IN THE "OPERATING
 MANUALS" SPECIFIC TO THE AIRLINE OPERATING THE AIRCRAFT

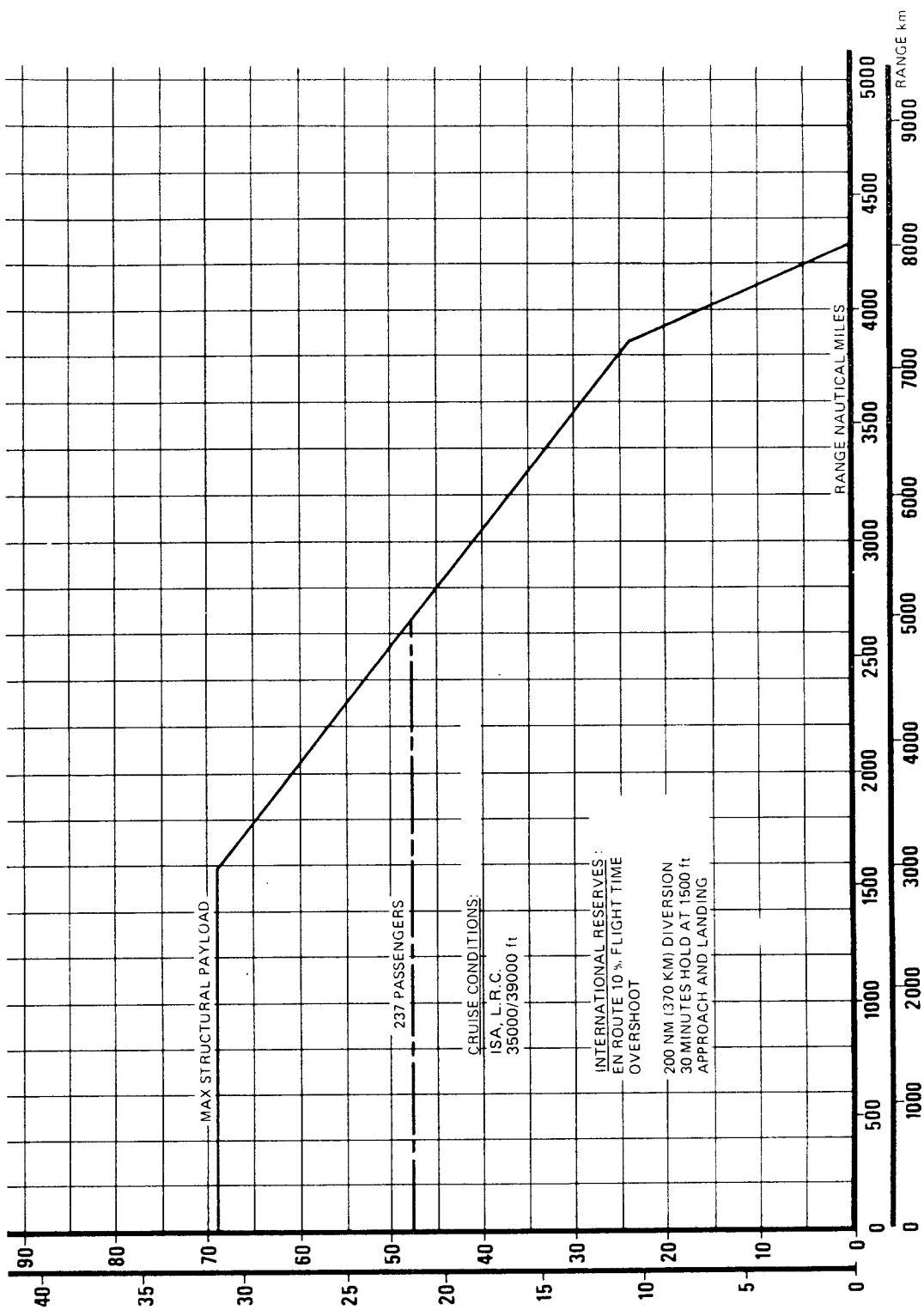

3.2 PAYLOAD RANGE
 3.2.1 PAYLOAD RANGE LONG RANGE CRUISE
 PW - JT9D - 7R4 ENGINE
 MODEL 200 - 132T

FIGURE 3.2

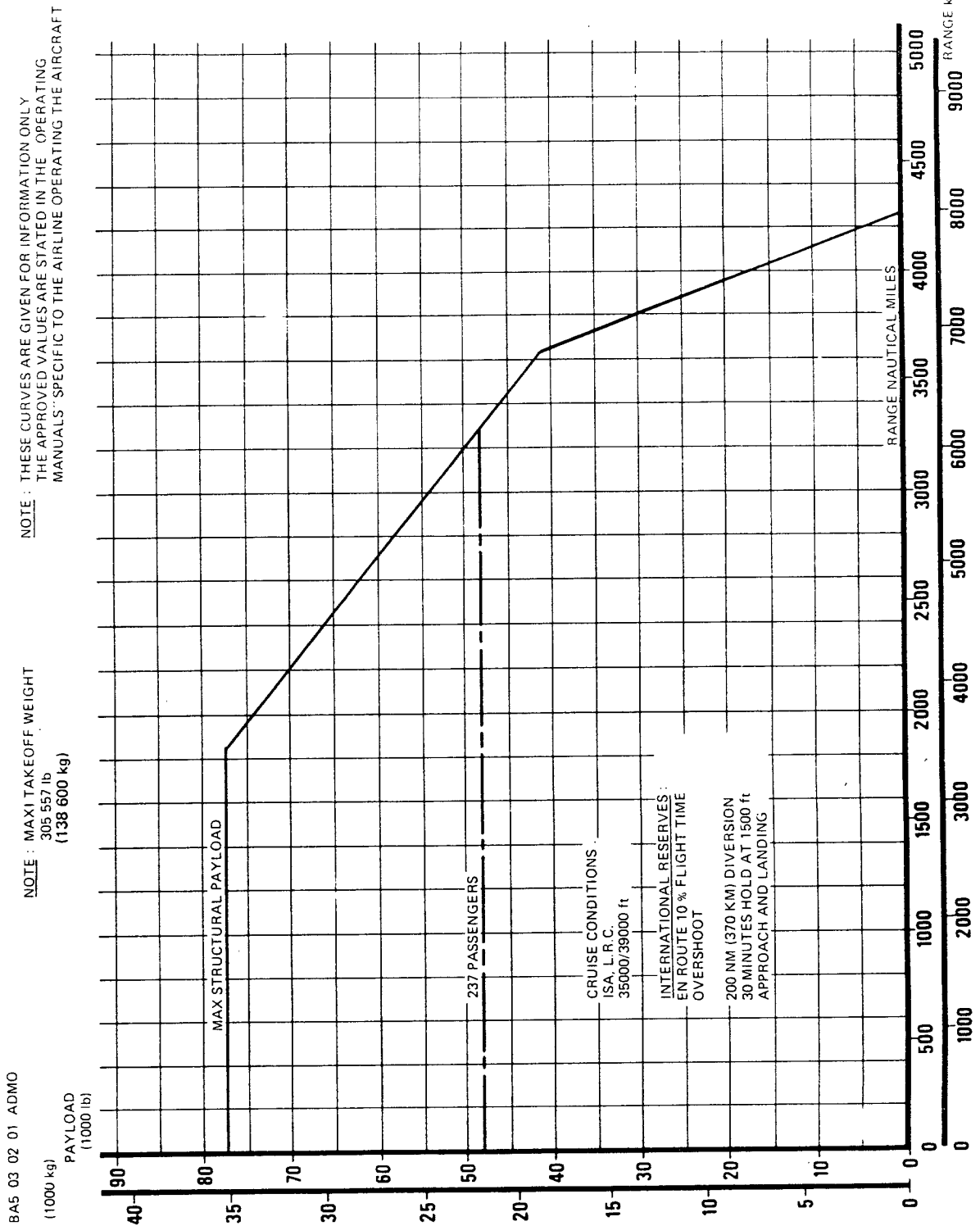

3.2 PAYLOAD RANGE
3.2.1 PAYLOAD RANGE LONG RANGE CRUISE
GE - CF6 - 80 A3 ENGINE
MODEL 200 - 138.6 T

N

BA5 03 02 01 AEMO

NOTE : MAXI TAKEOFF WEIGHT
305 557 lb
(138 600 kg)

NOTE : THESE CURVES ARE GIVEN FOR INFORMATION ONLY
THE APPROVED VALUES ARE STATED IN THE "OPERATING
MANUALS" SPECIFIC TO THE AIRLINE OPERATING THE AIRCRAFT

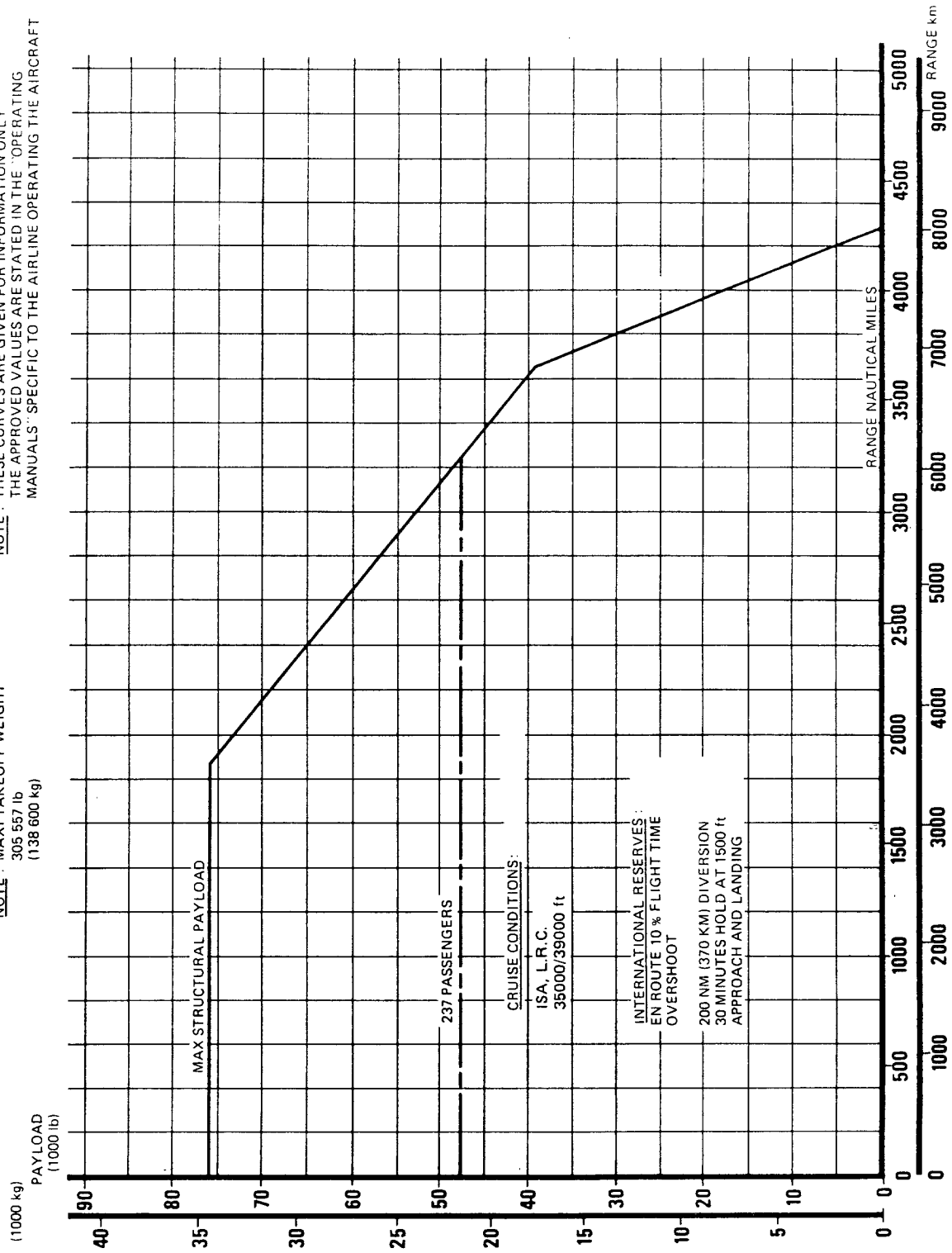

3.2 PAYLOAD RANGE
3.2.1 PAYLOAD RANGE LONG RANGE CRUISE
ISA CONDITIONS

PW - JT9D - 7R4 ENGINE
MODEL 200 - 138.6 T

BA5 03 02 01 AFMO
 NOTE : MAXI TAKEOFF WEIGHT
 313 053 lb
 (142 000 kg)
 NOTE : THESE CURVES ARE GIVEN FOR INFORMATION ONLY
 THE APPROVED VALUES ARE STATED IN THE "OPERATING
 MANUALS" SPECIFIC TO THE AIRLINE OPERATING THE AIRCRAFT

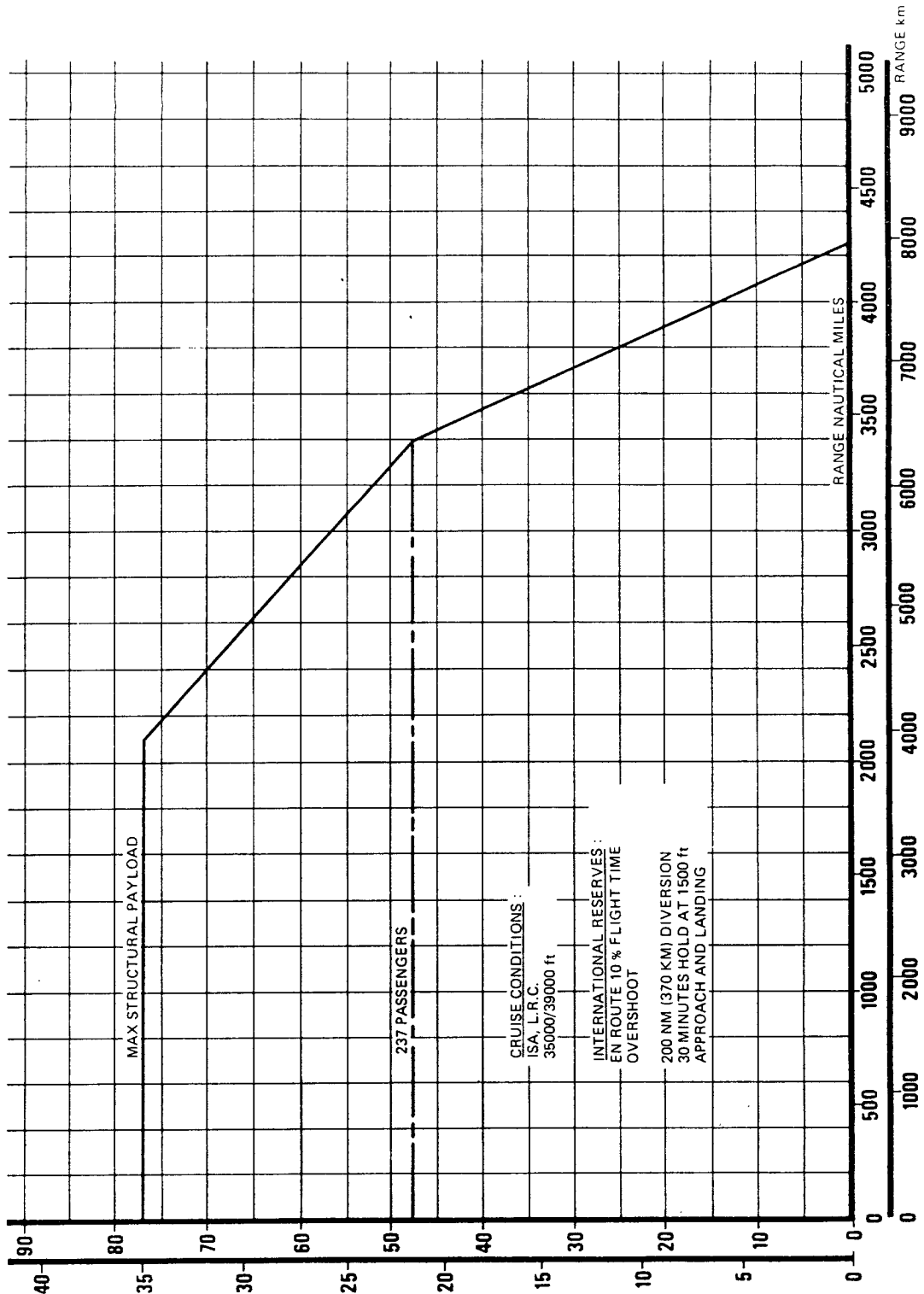

3.2 PAYLOAD RANGE
 3.2.1 PAYLOAD RANGE LONG RANGE CRUISE
 GE - CF6 - 80 A3 ENGINE
 MODEL 200 - 142 T

BA5 03 02 01 AGMO
 (1000 kg)
 PAYLOAD (1000 lb)
 NOTE : MAXI TAKEOFF WEIGHT 313 053 lb (142 000 kg)
 NOTE : THESE CURVES ARE GIVEN FOR INFORMATION ONLY THE APPROVED VALUES ARE STATED IN THE "OPERATING MANUALS" SPECIFIC TO THE AIRLINE OPERATING THE AIRCRAFT.

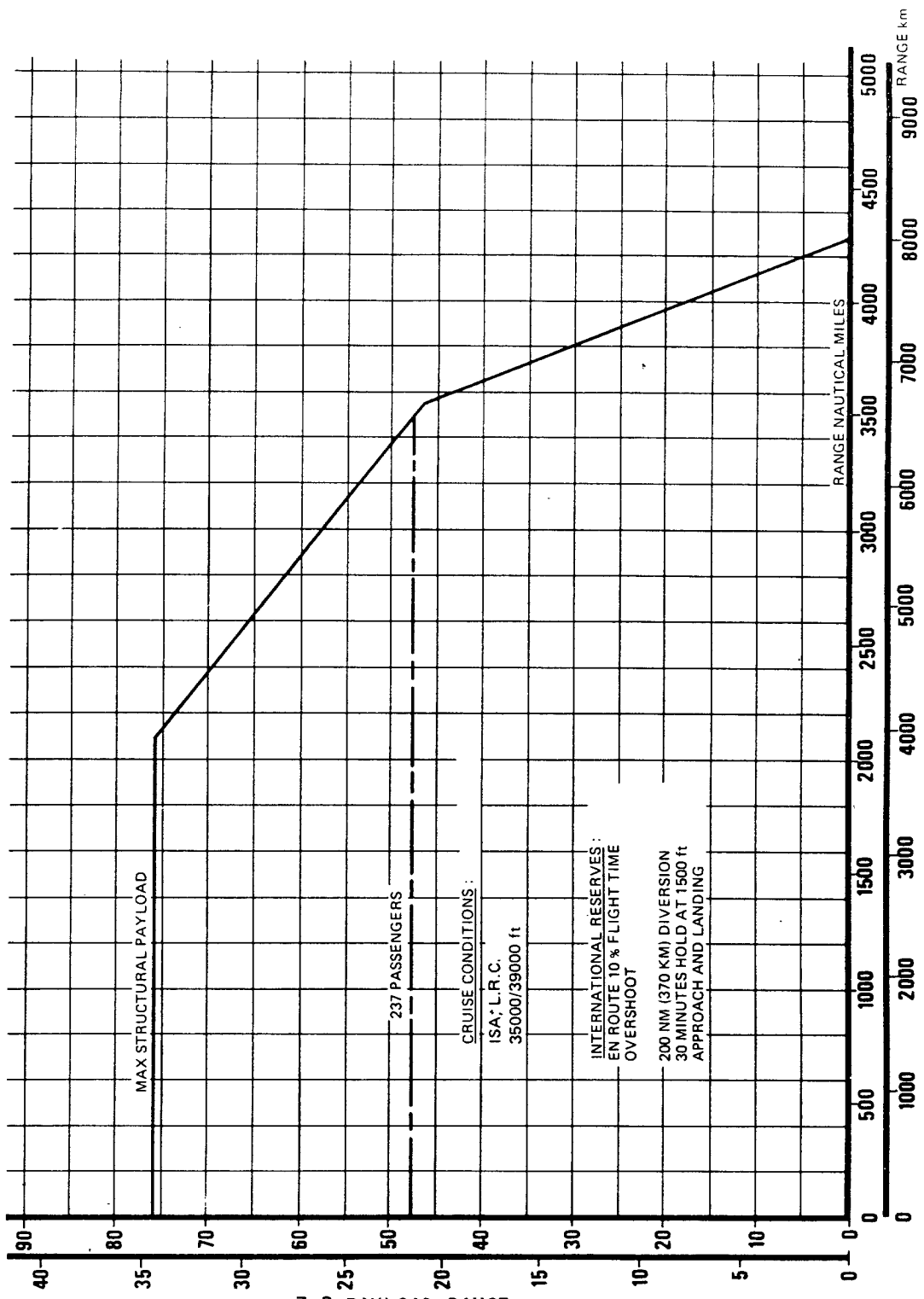

3.2 PAYLOAD RANGE
 3.2.1 PAYLOAD RANGE LONG RANGE CRUISE
 ISA CONDITIONS
 PW - JT9D - 7R4 ENGINE
 MODEL 200 - 142 T

FRANCE IN FRANCE

BA5 03 02 01 AHMO

NOTE: MAXI TAKEOFF WEIGHT
330 690 lb
(150 000 kg)

NOTE: THESE CURVES ARE GIVEN FOR INFORMATION ONLY.
THE APPROVED VALUES ARE STATED IN THE "OPERATING
MANUALS" SPECIFIC TO THE AIRLINE OPERATING THE AIRCRAFT.

NOTE: MAXI TAKEOFF WEIGHT
330 690 lb
(150 000 kg)

PAYLOAD
(1000 kg)
(1000 lb)

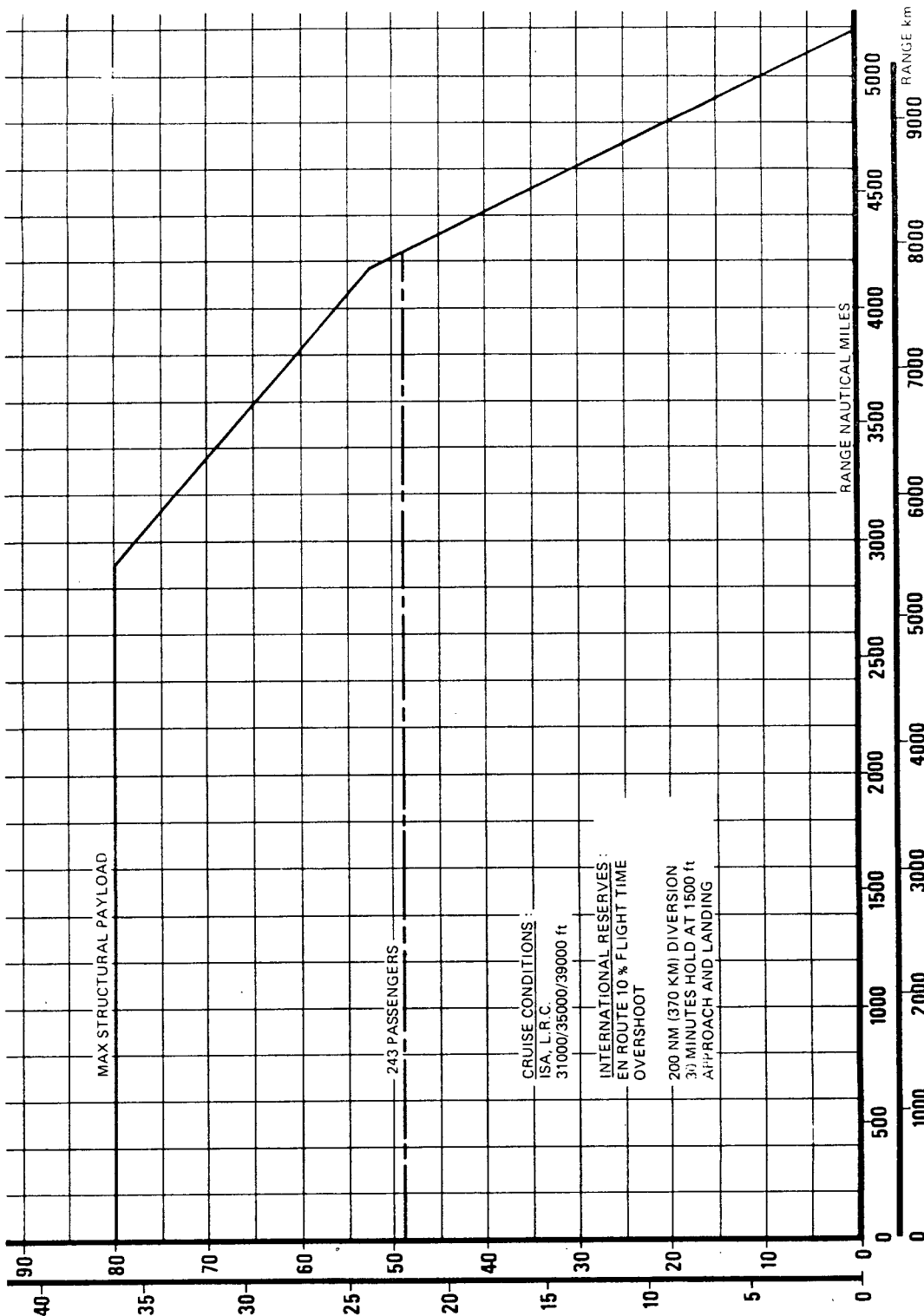

3.2 PAYLOAD RANGE
3.2.1 PAYLOAD RANGE LONG RANGE CRUISE
ISA CONDITIONS
GE - CF6 - 80 C2 ENGINE
MODEL 300 - 150 T

BA5 03 02 01 AJMO
 NOTE : MAXI TAKEOFF WEIGHT
 330 690 lb
 (150 000 kg)
 NOTE : THESE CURVES ARE GIVEN FOR INFORMATION ONLY
 THE APPROVED VALUES ARE STATED IN THE "OPERATING
 MANUALS" SPECIFIC TO THE AIRLINE OPERATING THE AIRCRAFT.

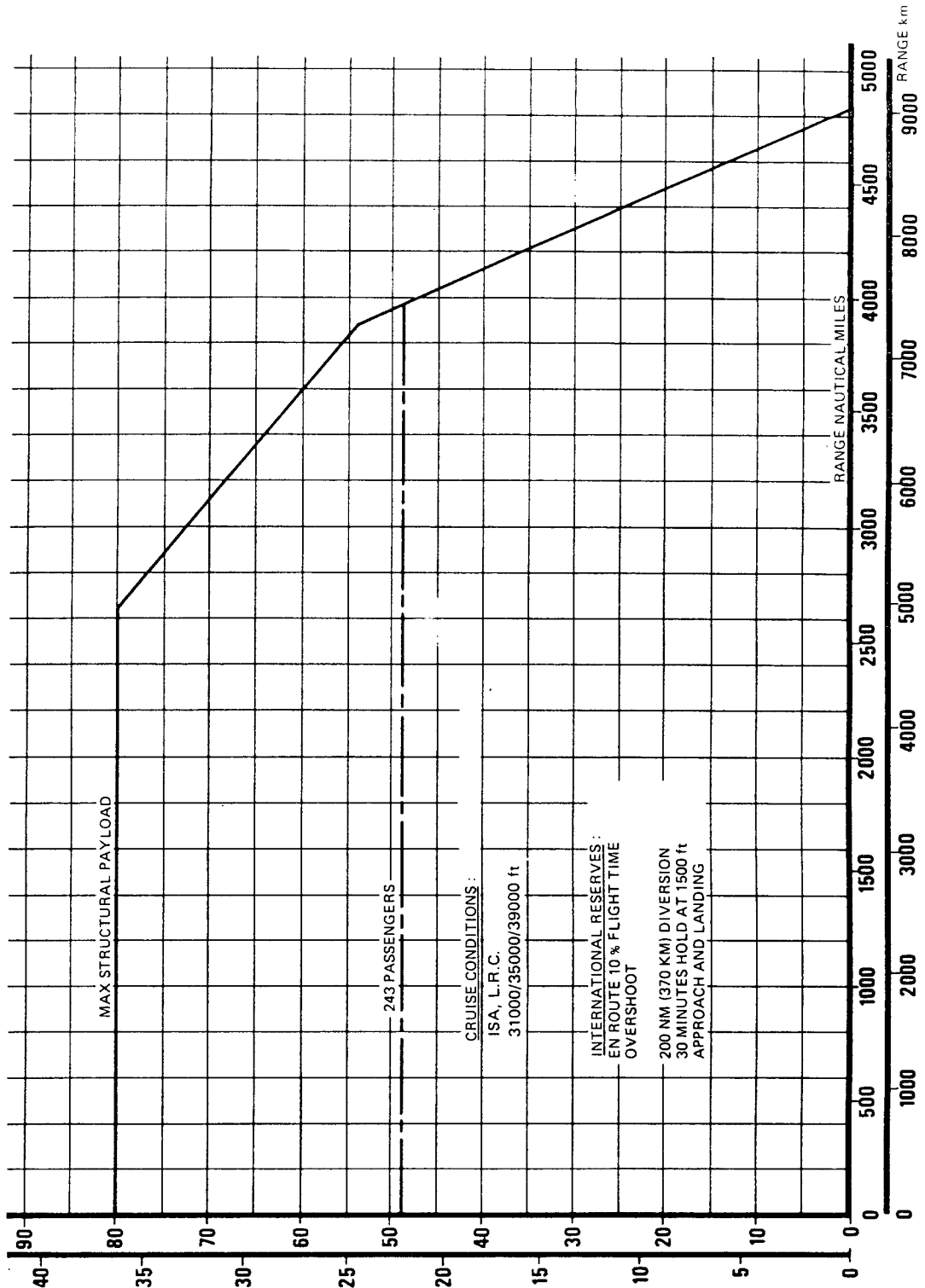

3.2 PAYLOAD RANGE
 3.2.1 PAYLOAD RANGE LONG RANGE CRUISE
 ISA CONDITIONS
 PW - JT9D - 7R4 ENGINE
 MODEL 300 - 150 T

Printed in France

BAS 03 02 01 AKMO

NOTE : MAXI TAKEOFF WEIGHT
337 300 lb
(153 000 kg)

NOTE : THESE CURVES ARE GIVEN FOR INFORMATION ONLY
THE APPROVED VALUES ARE STATED IN THE "OPERATING
MANUALS" SPECIFIC TO THE AIRLINE OPERATING THE AIRCRAFT.

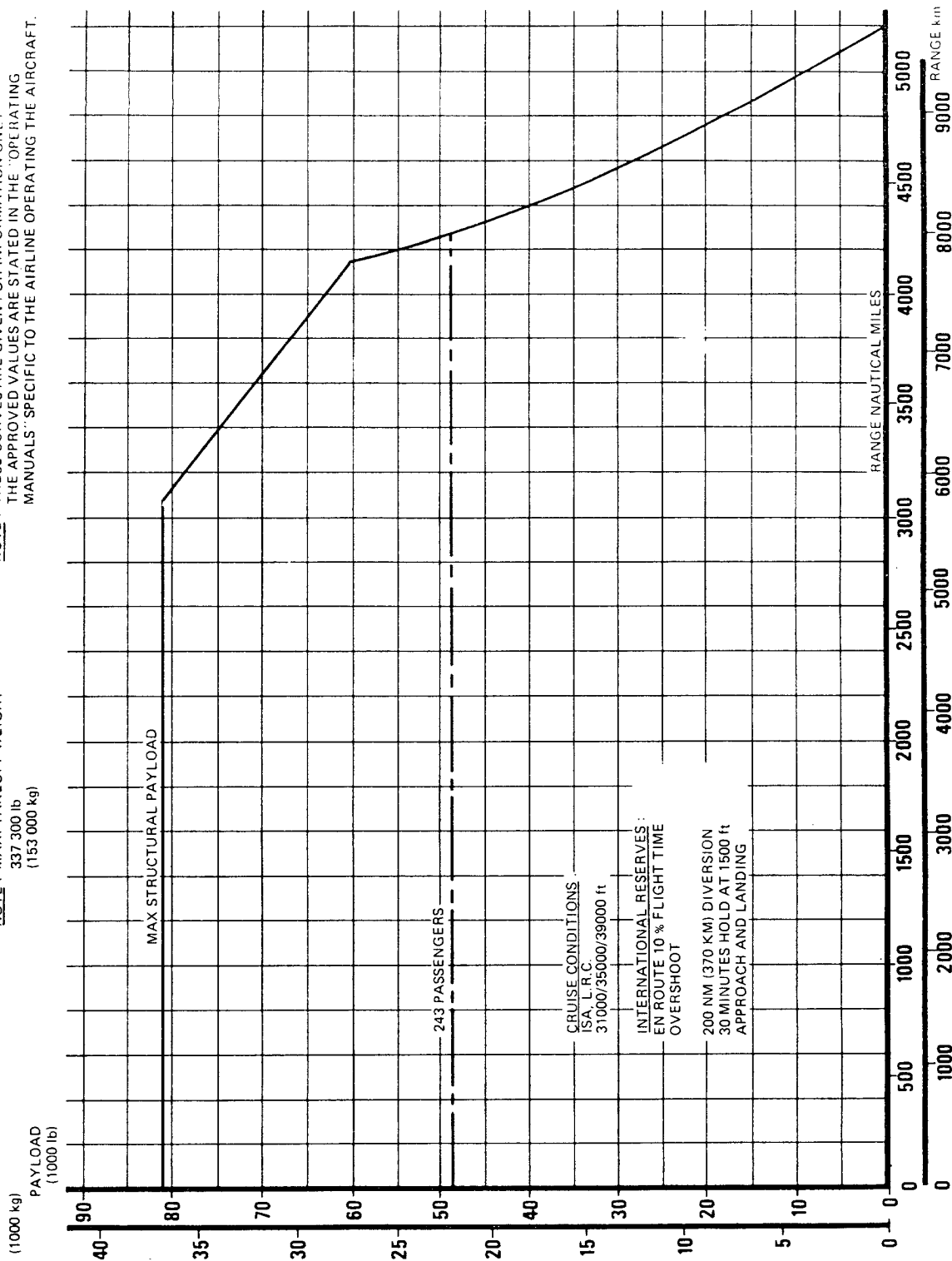

3.2 PAYLOAD RANGE
3.2.1 PAYLOAD RANGE LONG RANGE CRUISE
ISA CONDITIONS
GE - CF6 - 80 C2 ENGINE
MODEL 300 - 153 T

N

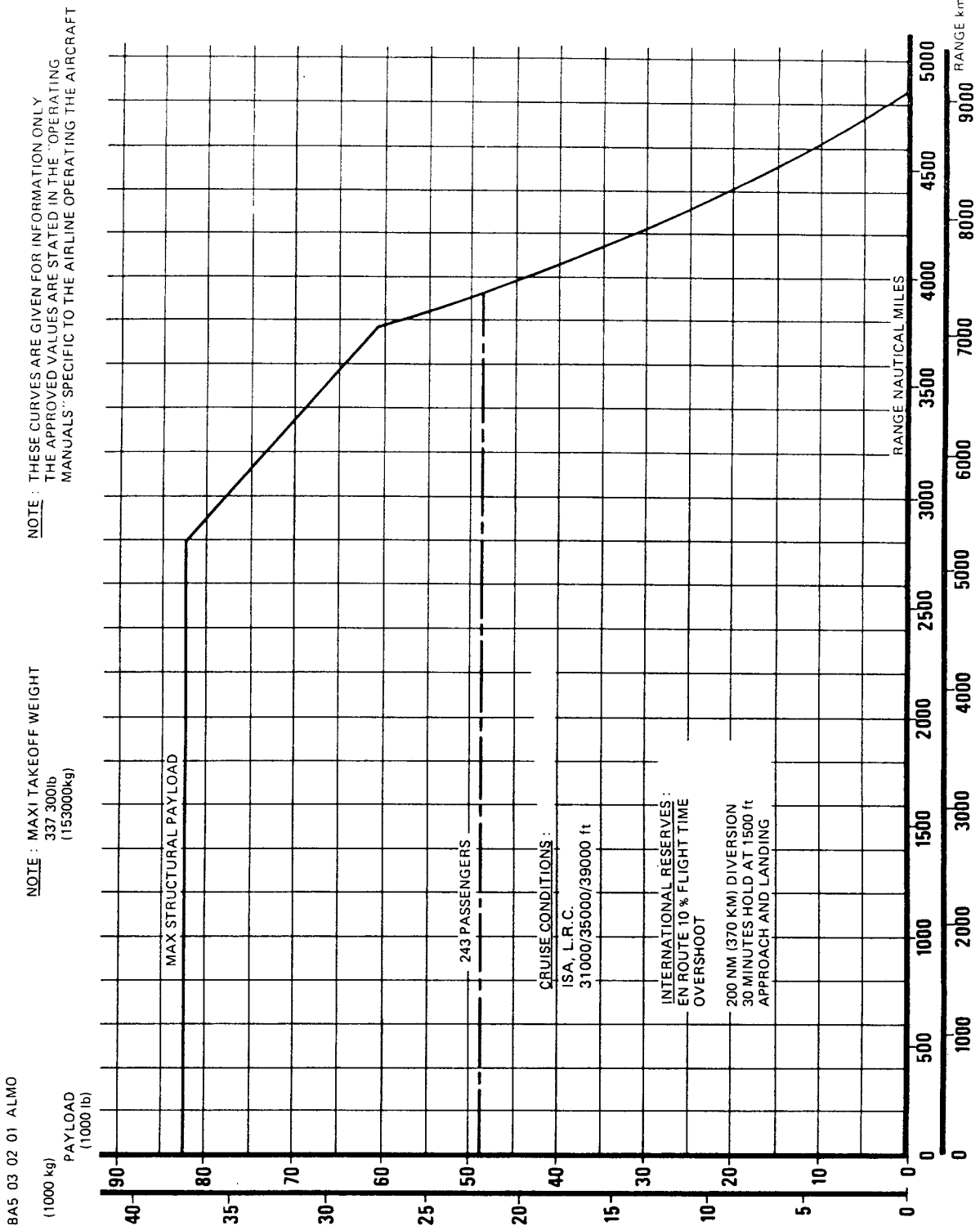

BA5 03 02 01 ALMO

3.2 PAYLOAD RANGE
3.2.1 PAYLOAD RANGE LONG RANGE CRUISE
ISA CONDITIONS
PW - JT9D - 7R4 ENGINE
MODEL 300 - 153 T



AIRPLANE CHARACTERISTICS FOR AIRPORT PLANNING

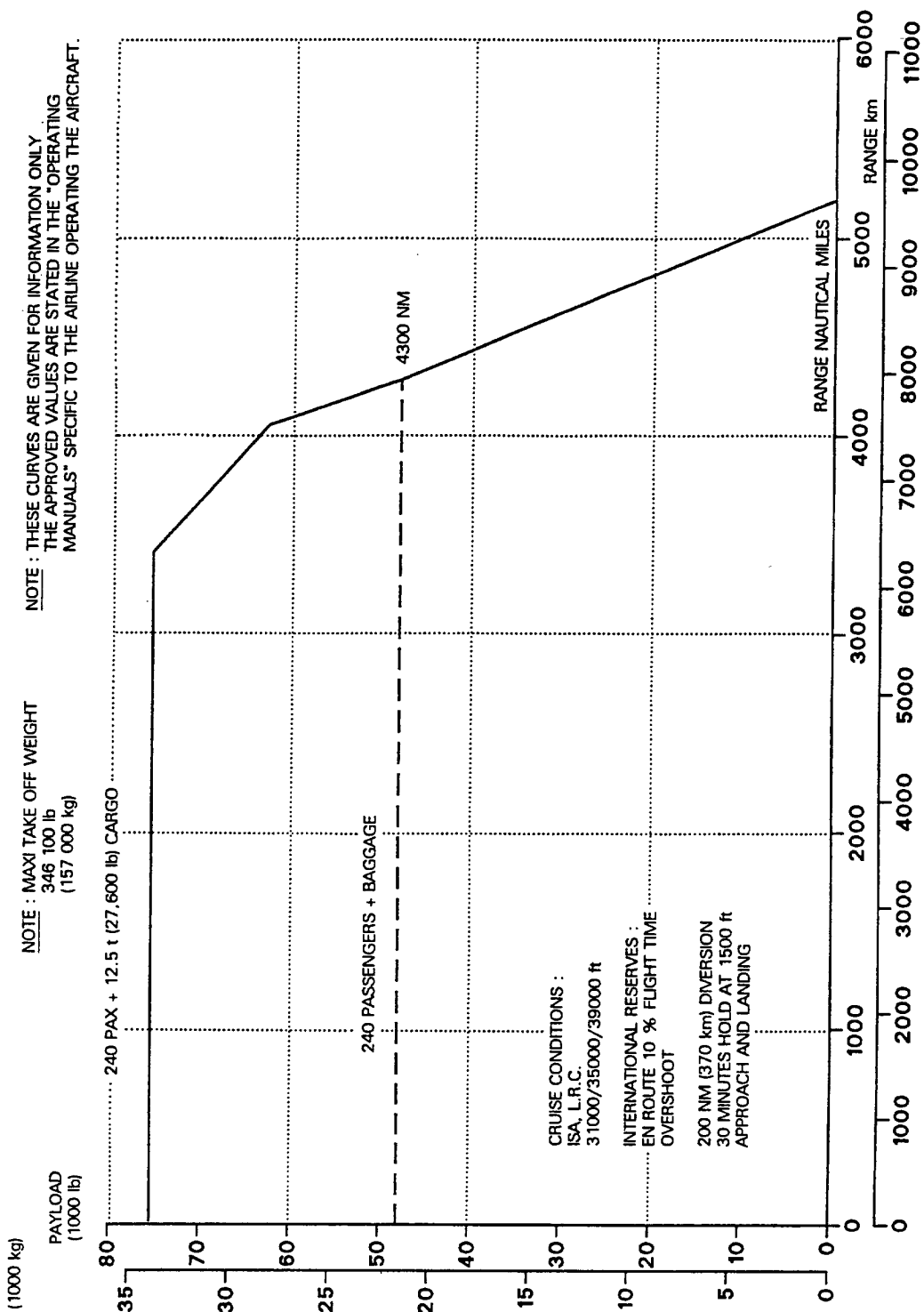

3.2 PAYLOAD RANGE
3.2.1 PAYLOAD RANGE LONG RANGE CRUISE
 ISA CONDITIONS
 GE - CF6 - 80 C2 ENGINE
 MODEL 300 - 157 T



AIRPLANE CHARACTERISTICS FOR AIRPORT PLANNING

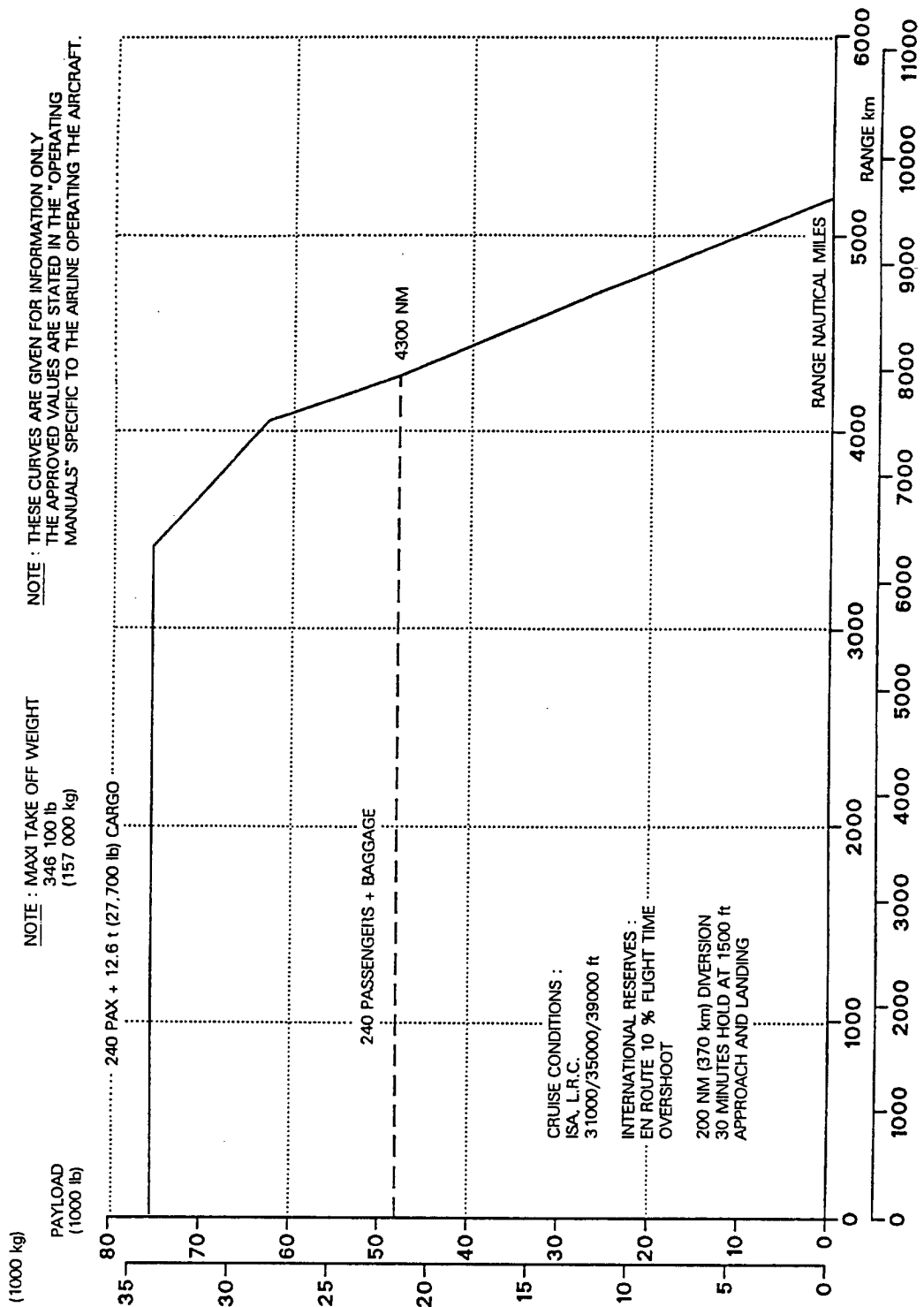

3.2 PAYLOAD RANGE
3.2.1 PAYLOAD RANGE LONG RANGE CRUISE
ISA CONDITIONS
PW ENGINE
MODEL 300 - 157 T

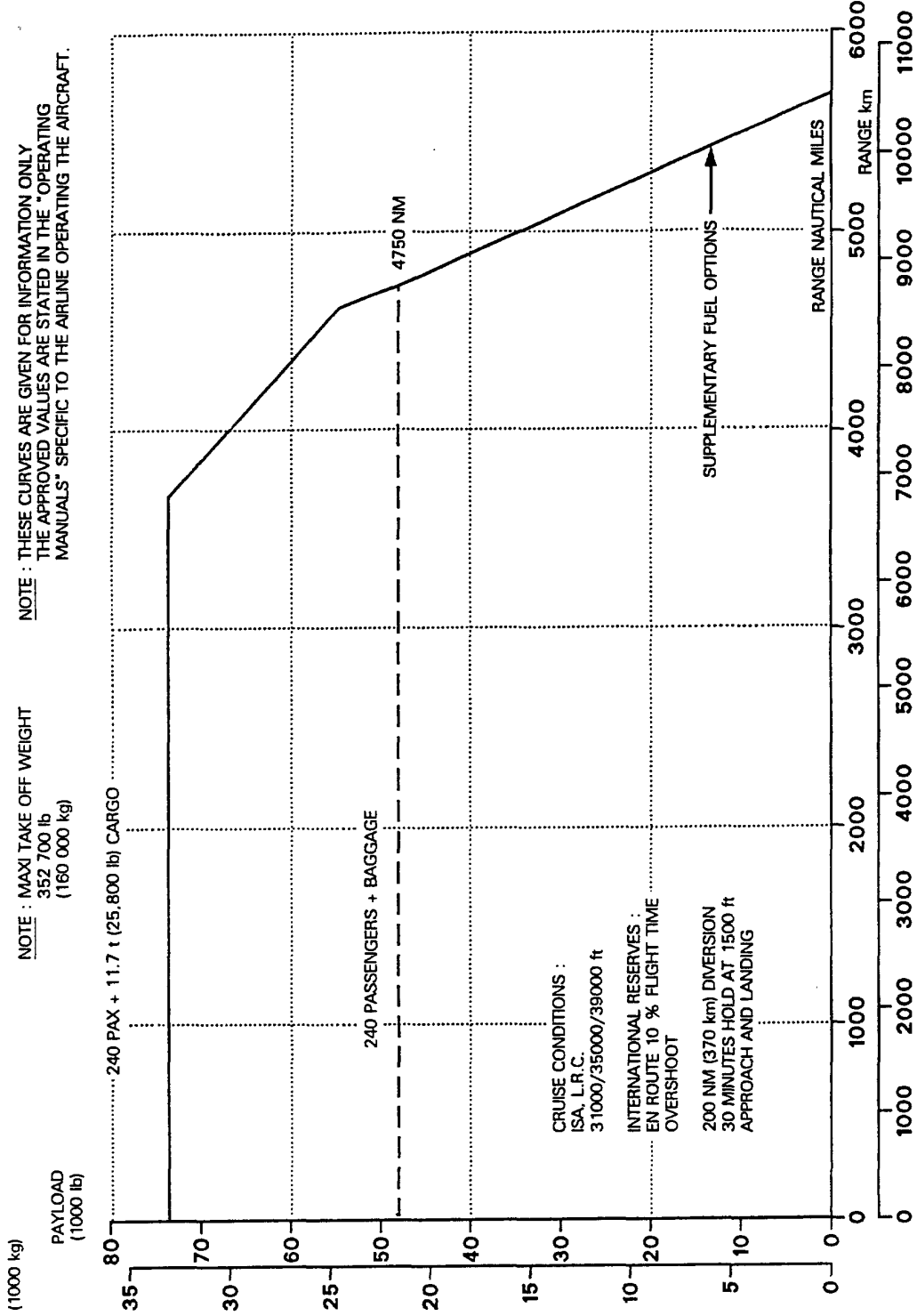

3.2 PAYLOAD RANGE
3.2.1 PAYLOAD RANGE LONG RANGE CRUISE
ISA CONDITIONS
GE - CF6 - 80 C2 ENGINE
MODEL 300 - 160 T

AIRPLANE CHARACTERISTICS FOR AIRPORT PLANNING

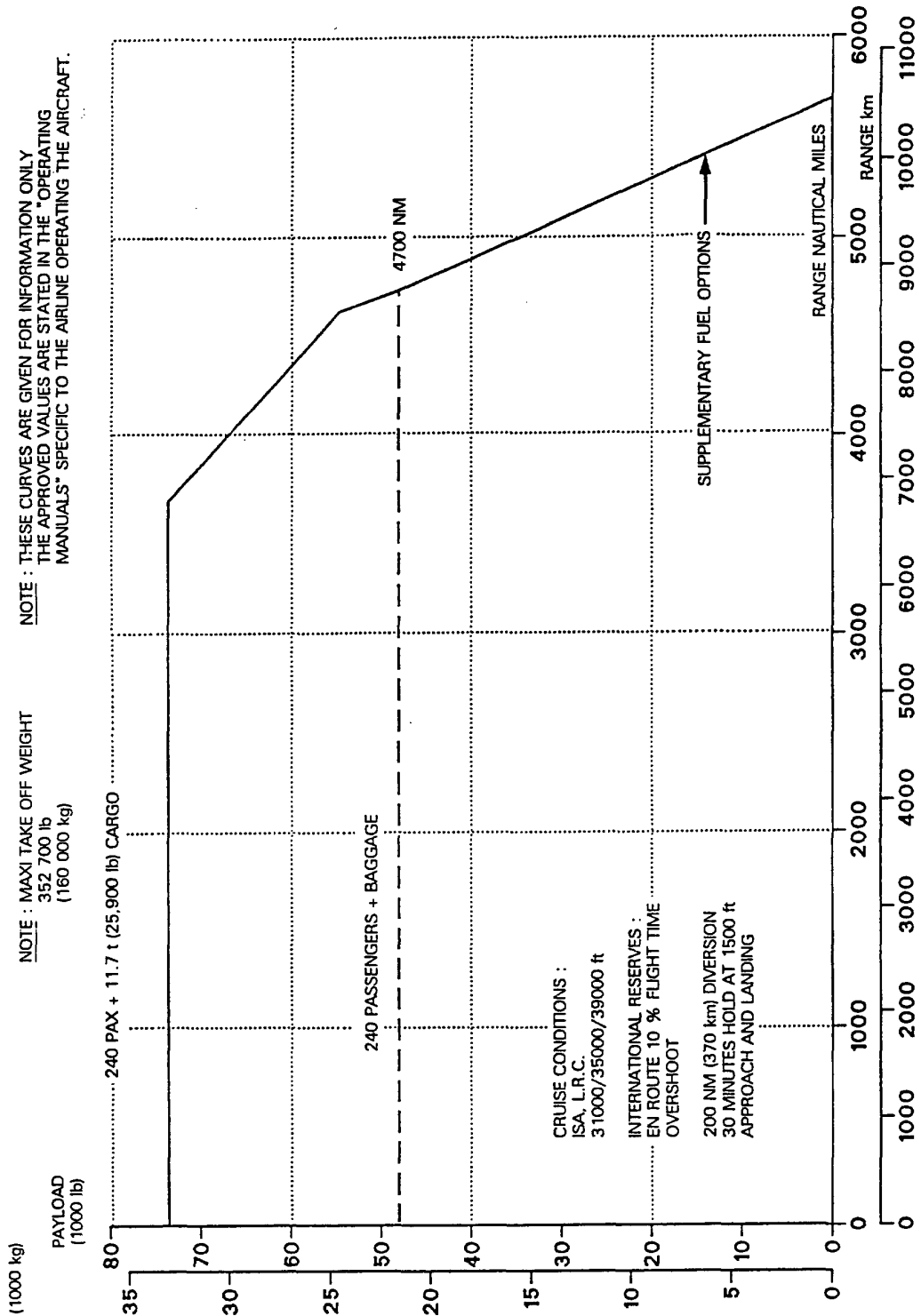

3.2 PAYLOAD RANGE
3.2.1 PAYLOAD RANGE LONG RANGE CRUISE
ISA CONDITIONS
PW ENGINE
MODEL 300 - 160 T



AIRPLANE CHARACTERISTICS FOR AIRPORT PLANNING

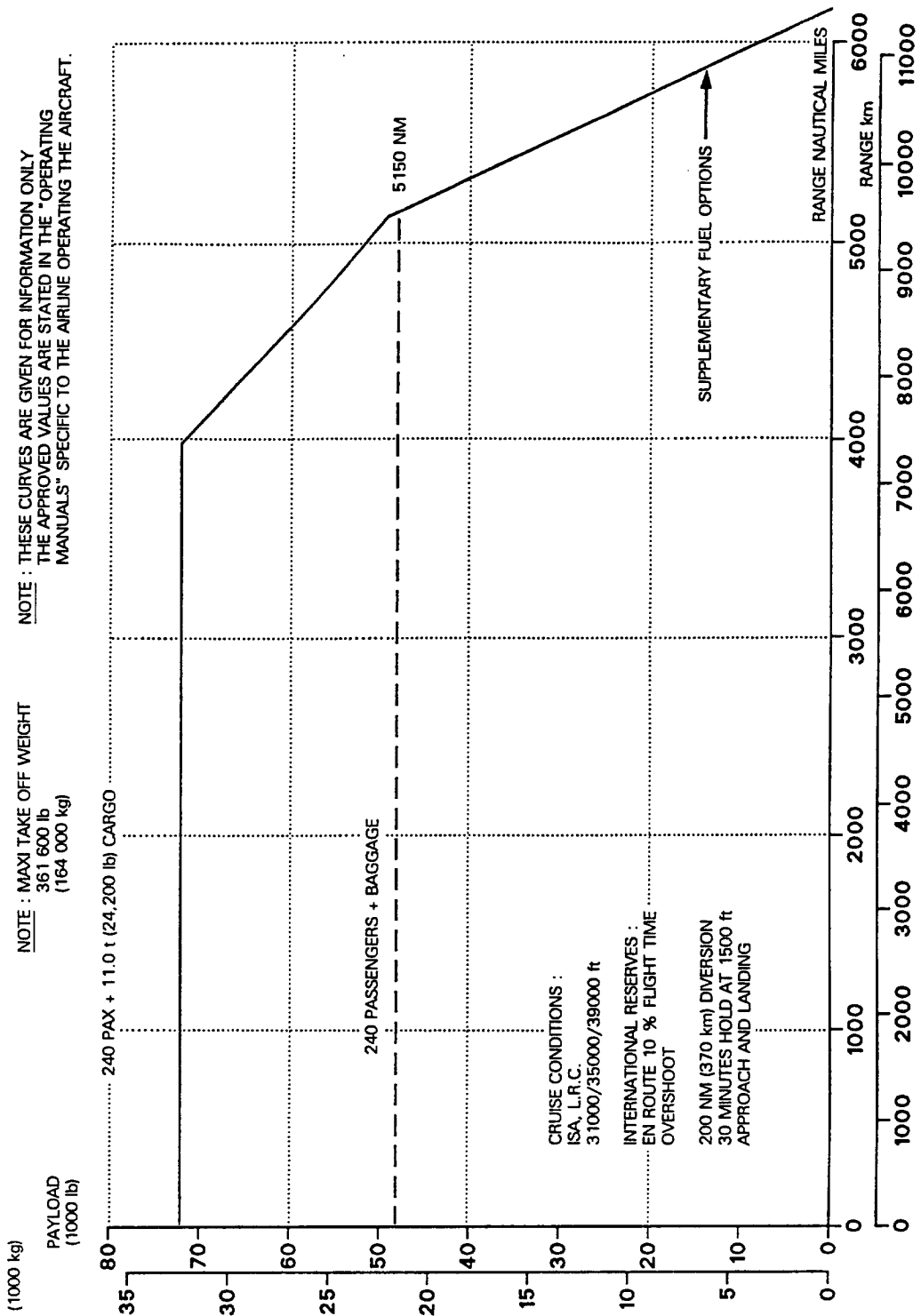

3.2 PAYLOAD RANGE
3.2.1 PAYLOAD RANGE LONG RANGE CRUISE
ISA CONDITIONS
GE - CF6 - 80 C2 ENGINE
MODEL 300 - 164 T



AIRPLANE CHARACTERISTICS FOR AIRPORT PLANNING

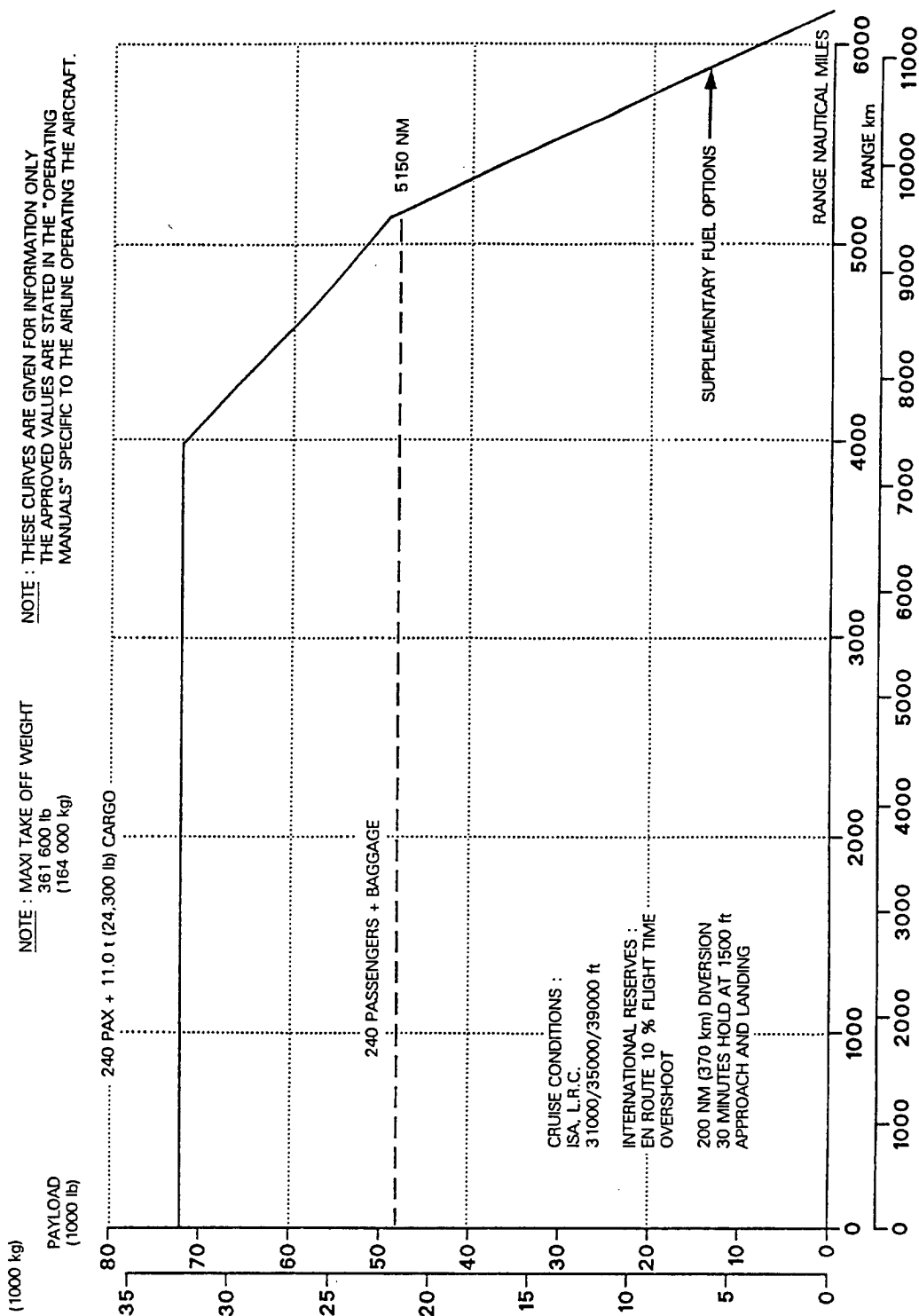

3.2 PAYLOAD RANGE
3.2.1 PAYLOAD RANGE LONG RANGE CRUISE
ISA CONDITIONS
PW ENGINE
MODEL 300 - 164 T

Printed in France

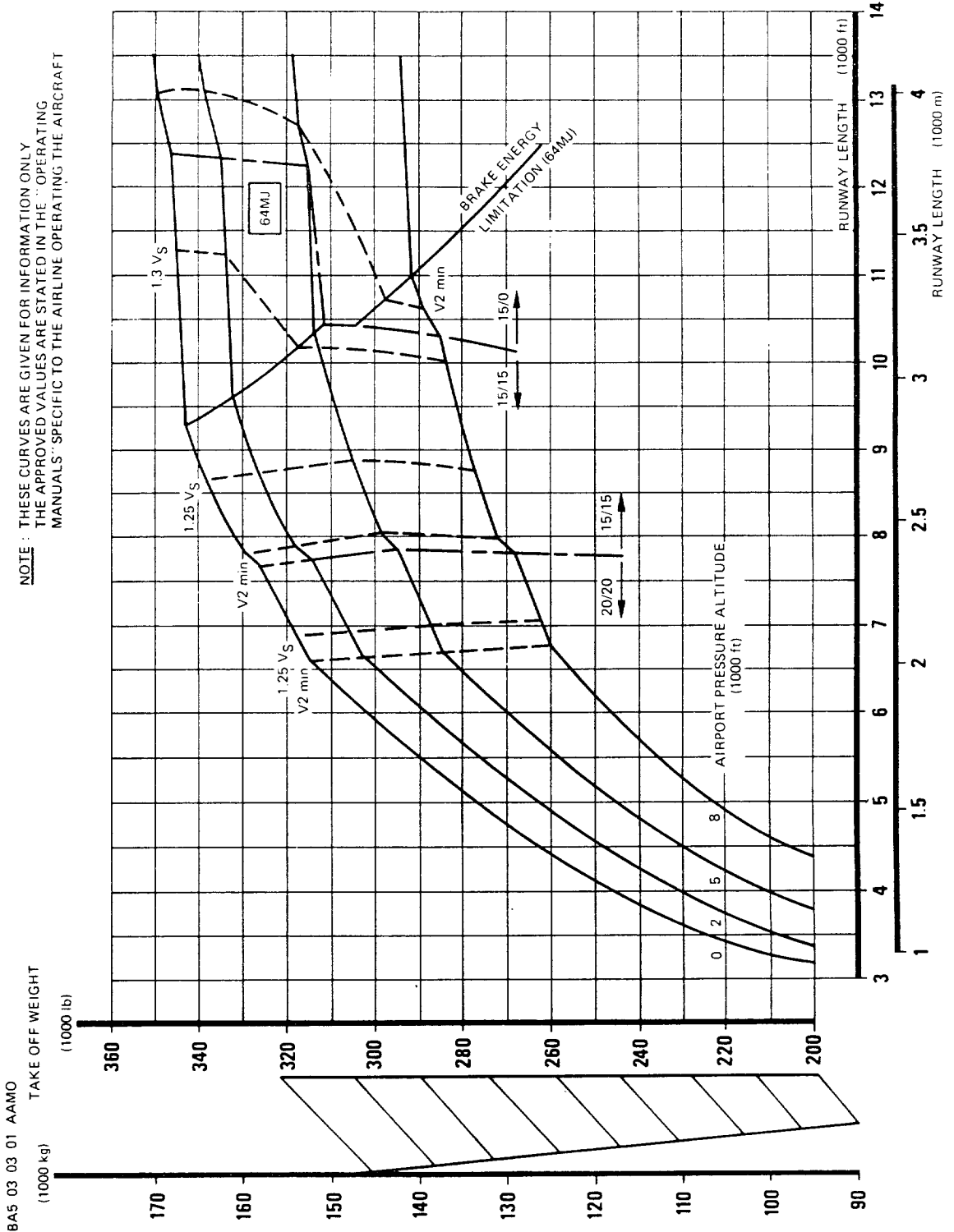

3.3 F.A.R. TAKEOFF RUNWAY LENGTH REQUIREMENTS
3.3.1 ISA CONDITIONS
GE - CF6 - 80 A3 ENGINE
MODEL 200

R

NOTE : THESE CURVES ARE GIVEN FOR INFORMATION ONLY
 THE APPROVED VALUES ARE STATED IN THE "OPERATING
 MANUALS" SPECIFIC TO THE AIRLINE OPERATING THE AIRCRAFT

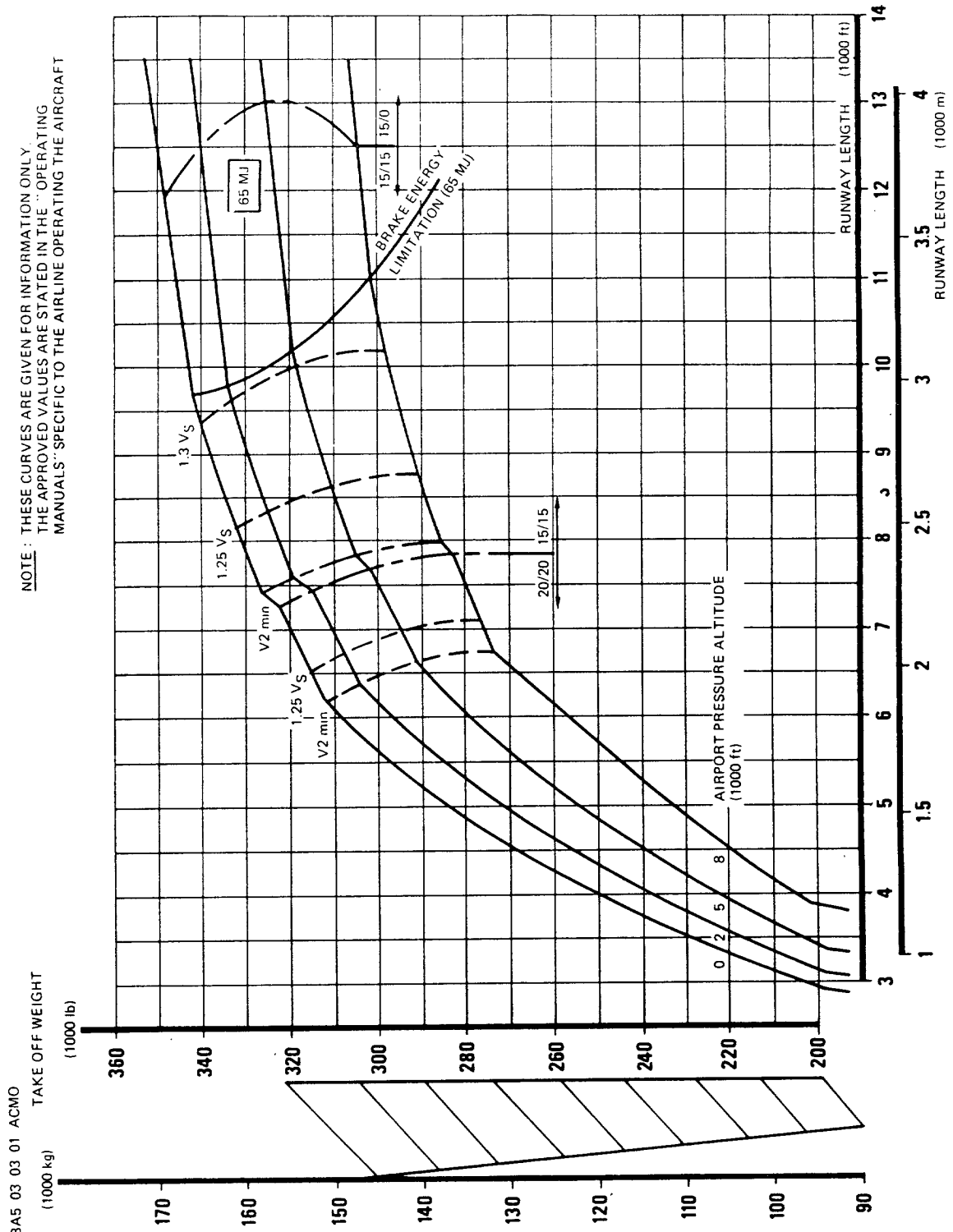

3.3 F.A.R. TAKEOFF RUNWAY LENGTH REQUIREMENTS
 3.3.1 ISA CONDITIONS
 PW - JT9D - 7R4 ENGINE
 MODEL 200



AIRPLANE CHARACTERISTICS FOR AIRPORT PLANNING

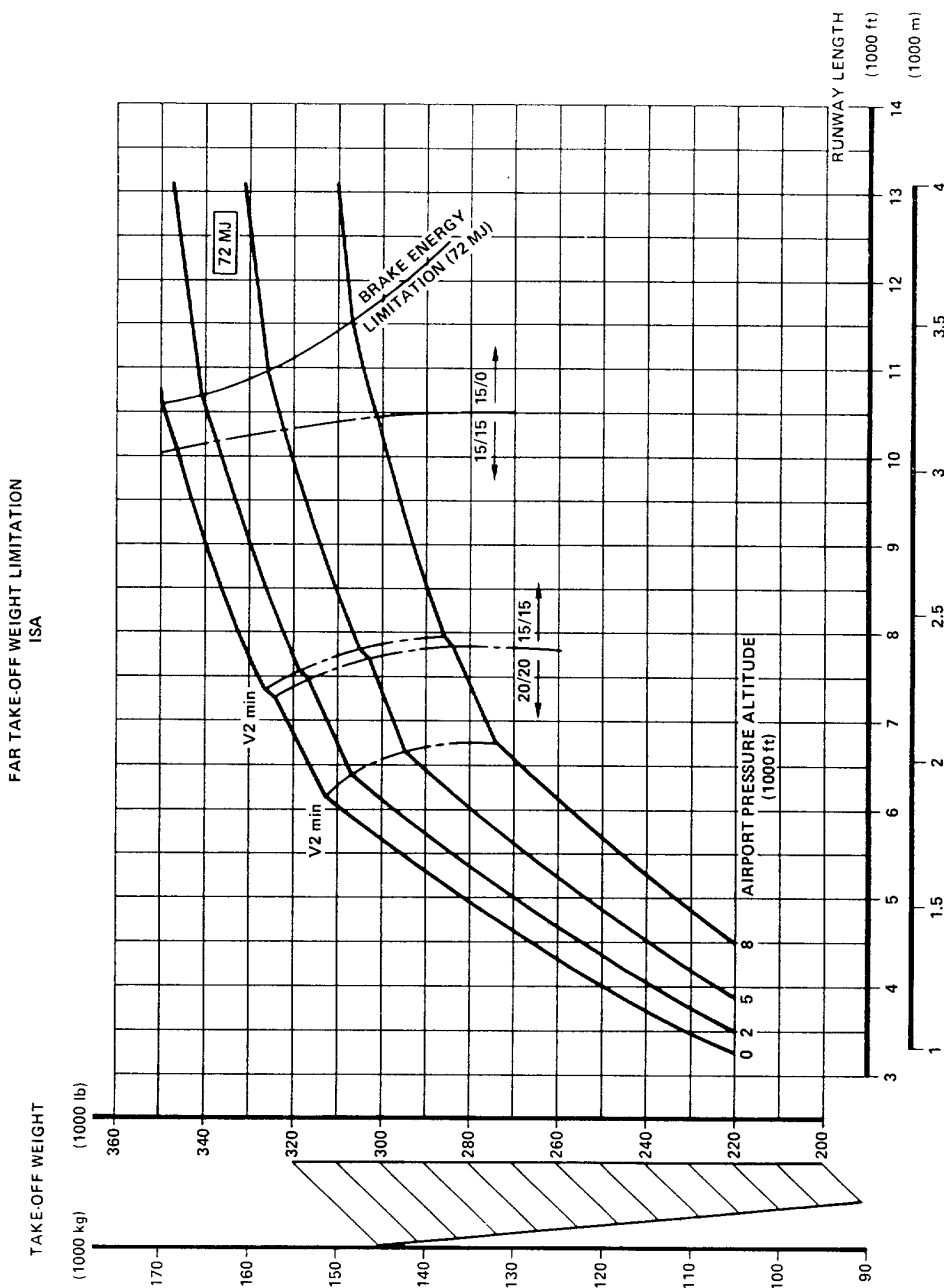

BA5 03 03 01 0 AEM0

3.3 FAR TAKE-OFF RUNWAY LENGTH REQUIREMENTS

3.3.1 ISA CONDITIONS
PW - JT9D - 7R4 ENGINE
MODEL 300

Chapter 3.3.1
Page 3
Oct 87

Printed in France

N



AIRPLANE CHARACTERISTICS FOR AIRPORT PLANNING

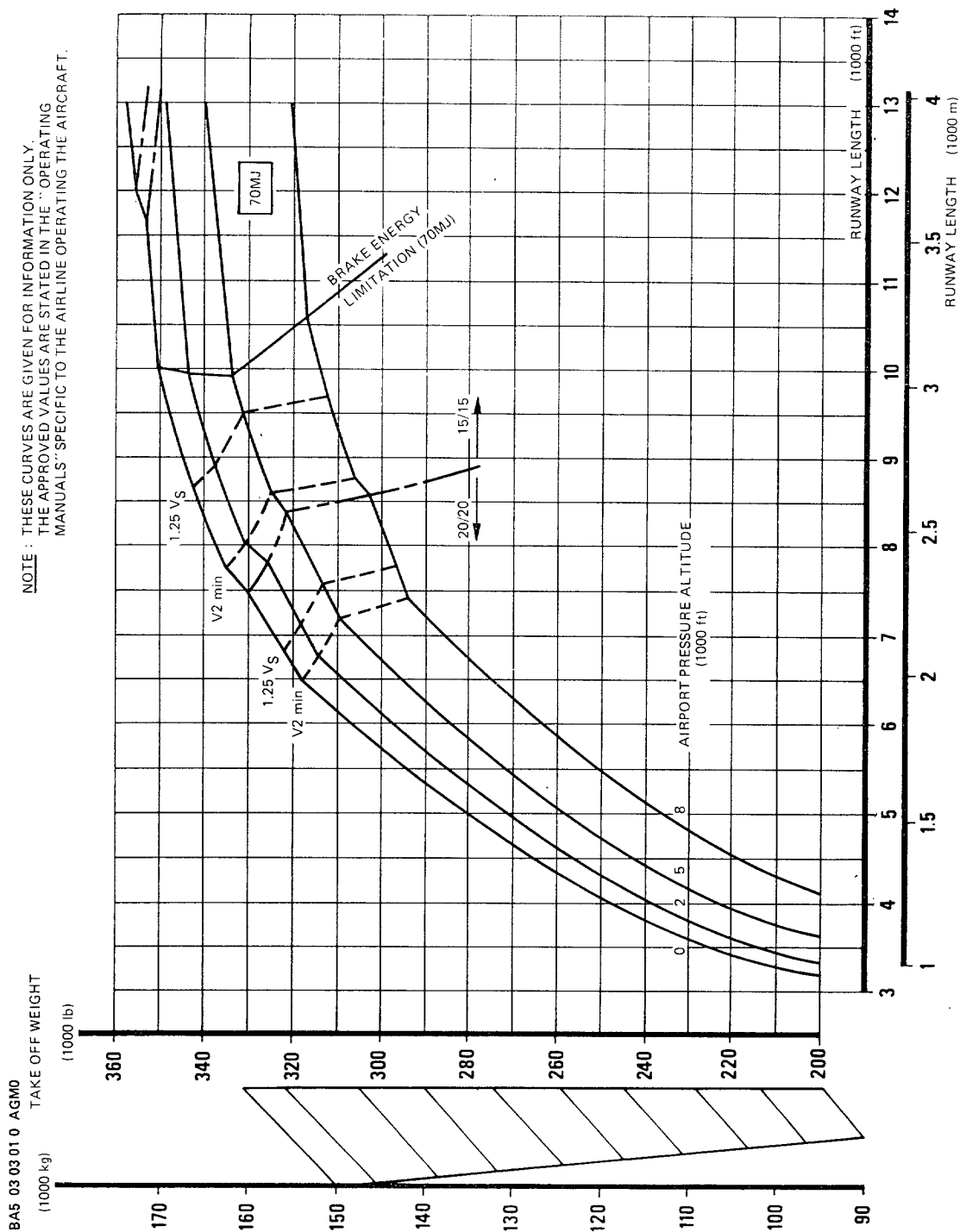

3.3 FAR TAKE-OFF RUNWAY LENGTH REQUIREMENTS

3.3.1 ISA CONDITIONS
GE - CF6 - 80 C2 ENGINE
MODEL 300



AIRPLANE CHARACTERISTICS FOR AIRPORT PLANNING

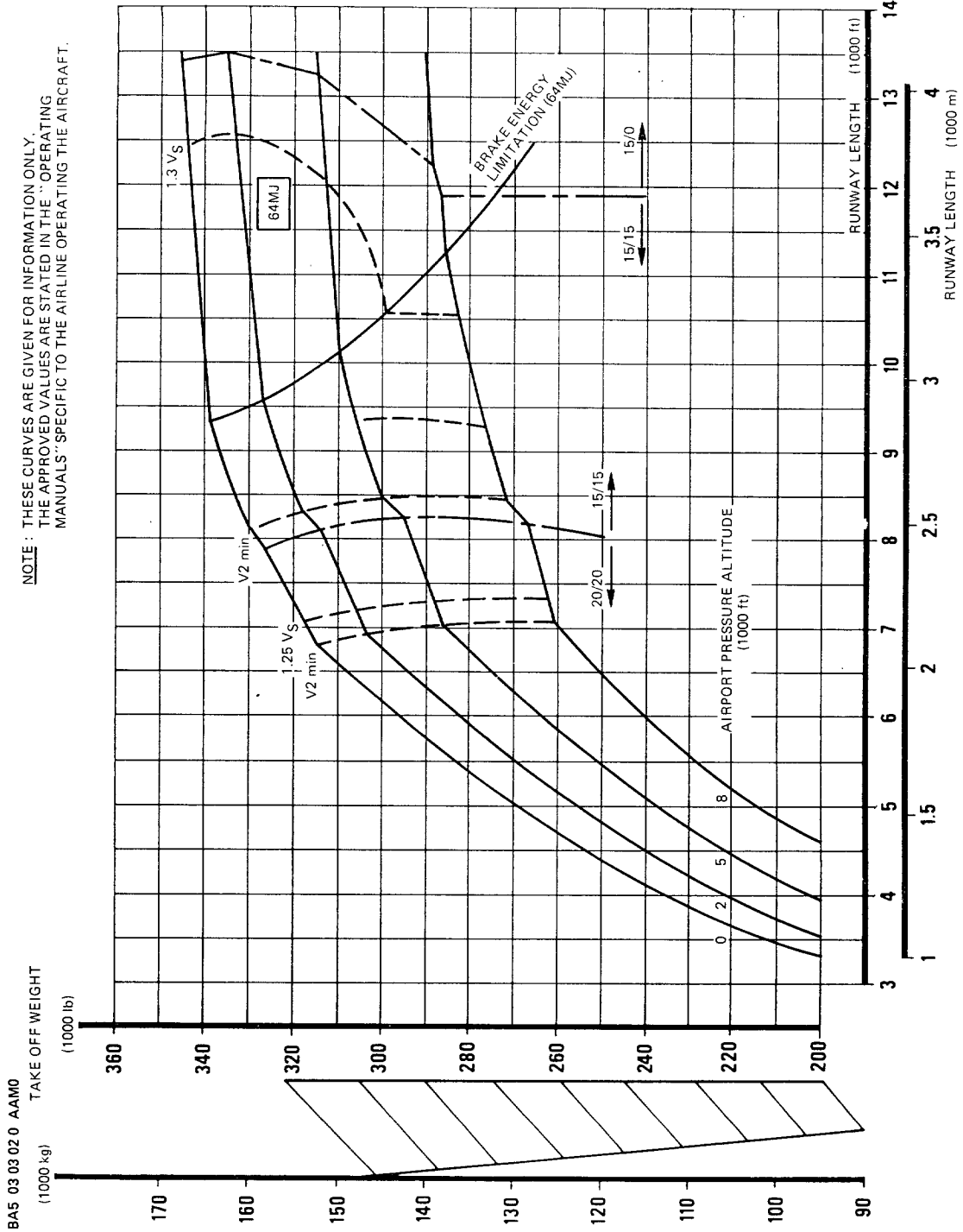

3.3 FAR TAKE-OFF RUNWAY LENGTH REQUIREMENTS

3.3.2 ISA + 15°C (59°F)

GE - CF6 - 80 A3 ENGINE

MODEL 200

Chapter 3.3.2

Page 1

Oct 87

R

Printed in France



AIRPLANE CHARACTERISTICS FOR AIRPORT PLANNING

NOTE: THESE CURVES ARE GIVEN FOR INFORMATION ONLY.
THE APPROVED VALUES ARE STATED IN THE "OPERATING
MANUALS" SPECIFIC TO THE AIRLINE OPERATING THE AIRCRAFT.

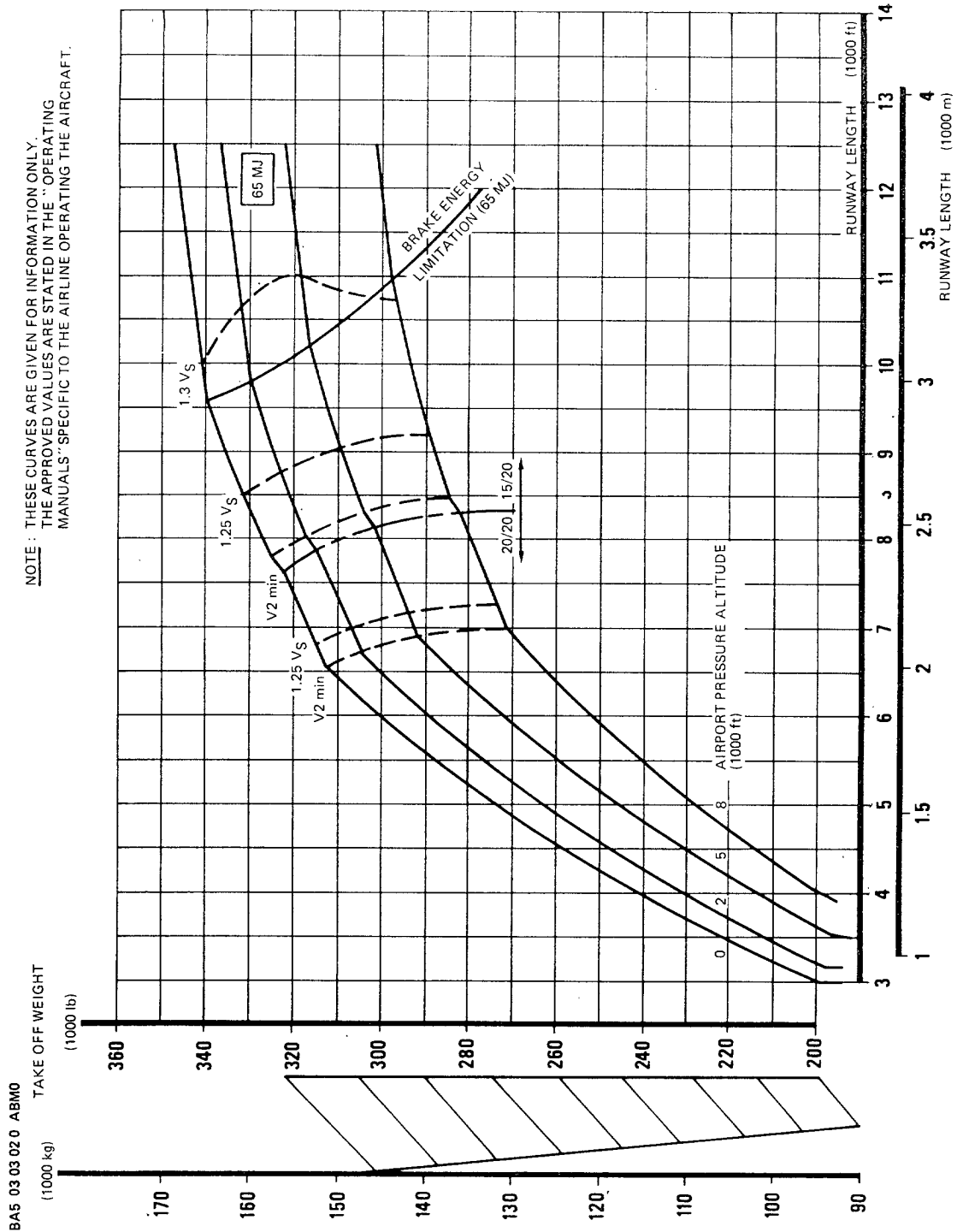

3.3 FAR TAKE-OFF RUNWAY LENGTH REQUIREMENTS
 3.3.2 ISA + 15°C (59°F) CONDITIONS
 PW - JT9D - 7R4 ENGINE
 MODEL 200

Chapter 3.3.2
 Page 2
 Oct 87



AIRPLANE CHARACTERISTICS FOR AIRPORT PLANNING

NOTE : THESE CURVES ARE GIVEN FOR INFORMATION ONLY.
THE APPROVED VALUES ARE STATED IN THE "OPERATING
MANUALS" SPECIFIC TO THE AIRLINE OPERATING THE AIRCRAFT.

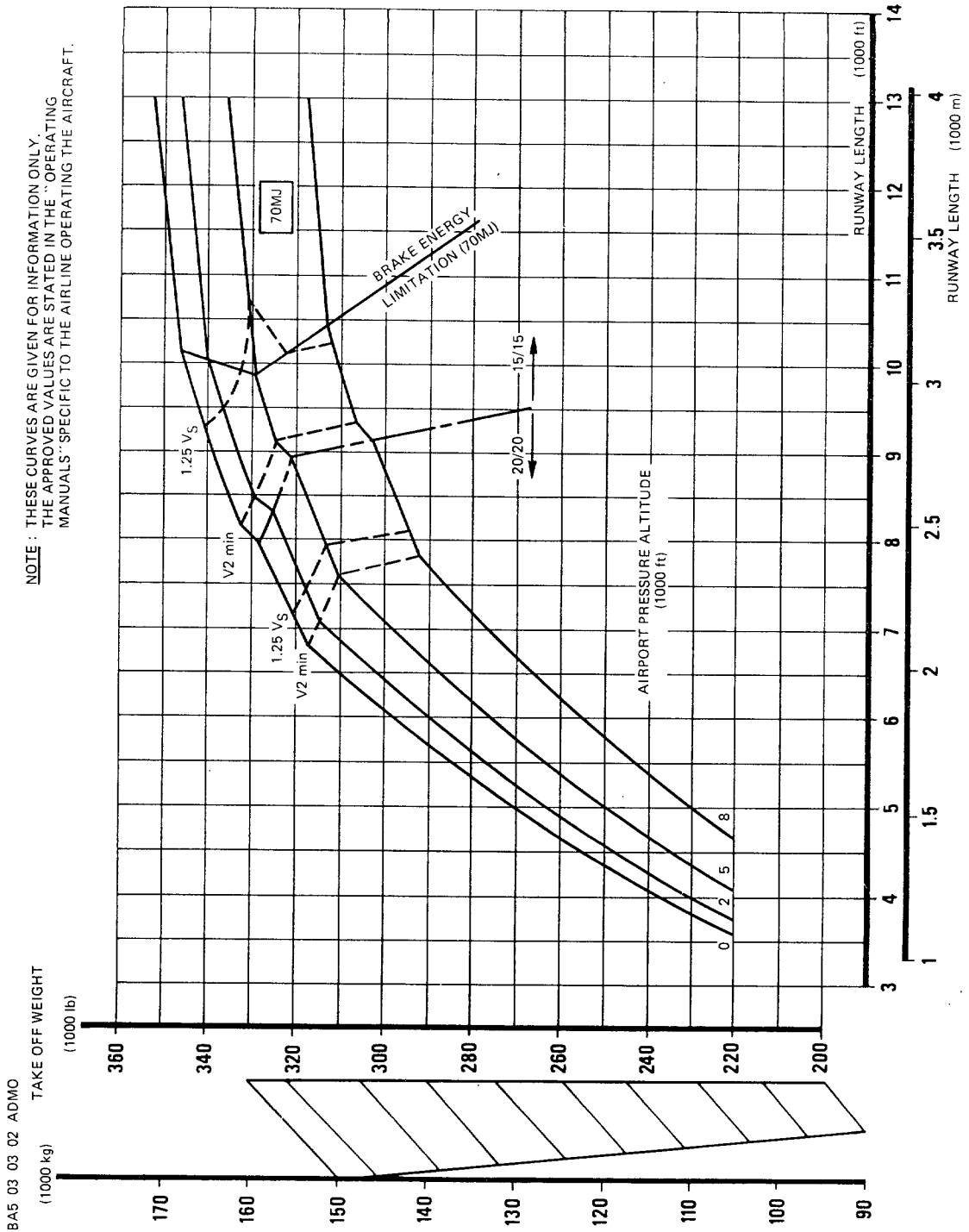

3.3 FAR TAKE-OFF RUNWAY LENGTH REQUIREMENTS
 3.3.2 ISA + 15°C (59°F) CONDITIONS
 GE - CF6 - 80 C2 ENGINE
 MODEL 300



AIRPLANE CHARACTERISTICS FOR AIRPORT PLANNING

BA5 03 03 02 0 AEMO

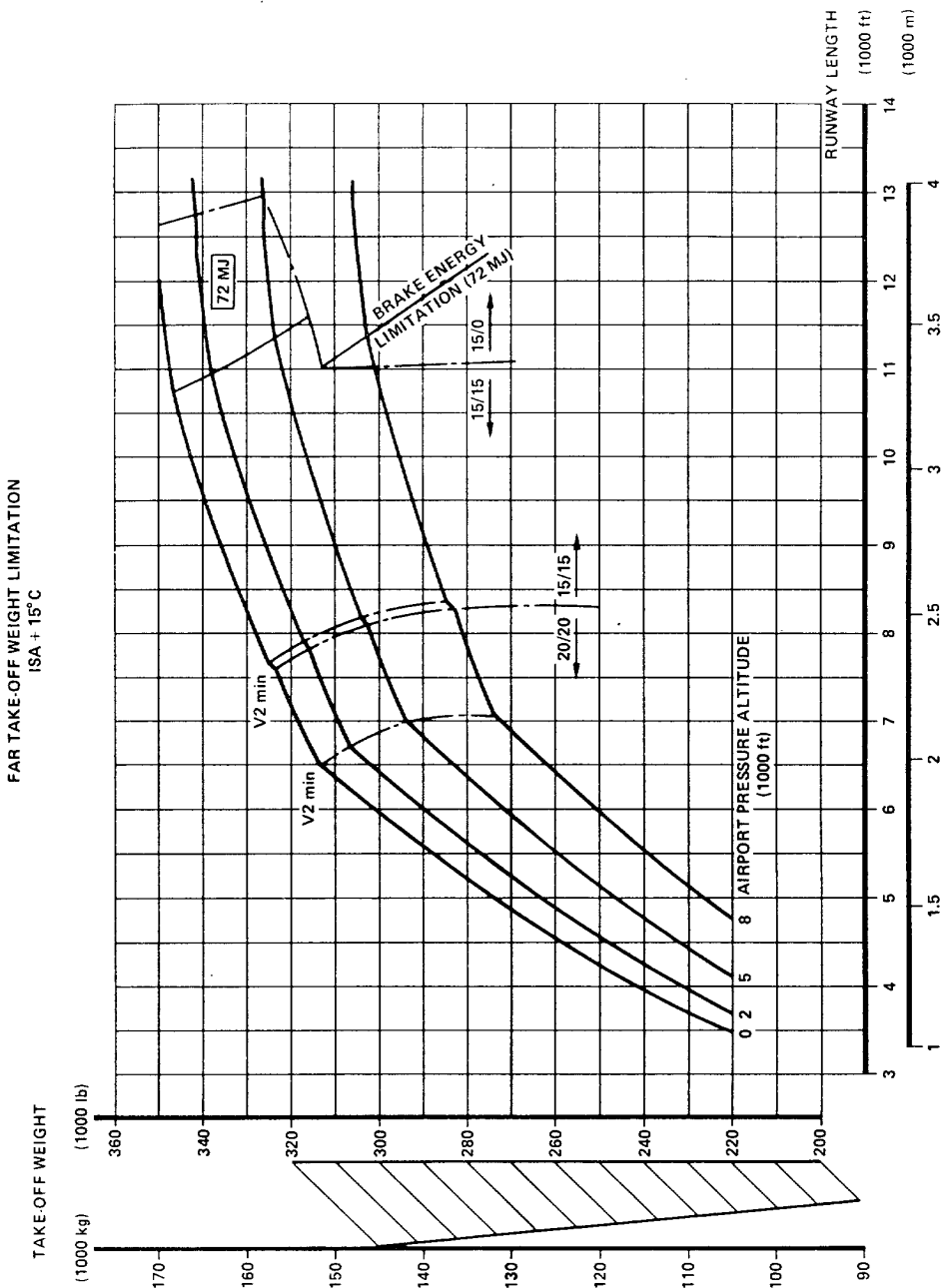

3.3 FAR TAKE-OFF RUNWAY LENGTH REQUIREMENTS
3.3.2 ISA + 15°C (59°F) CONDITIONS
 PW - JT9D - 7R4 ENGINE
 MODEL 300

Printed in France

Printed in France

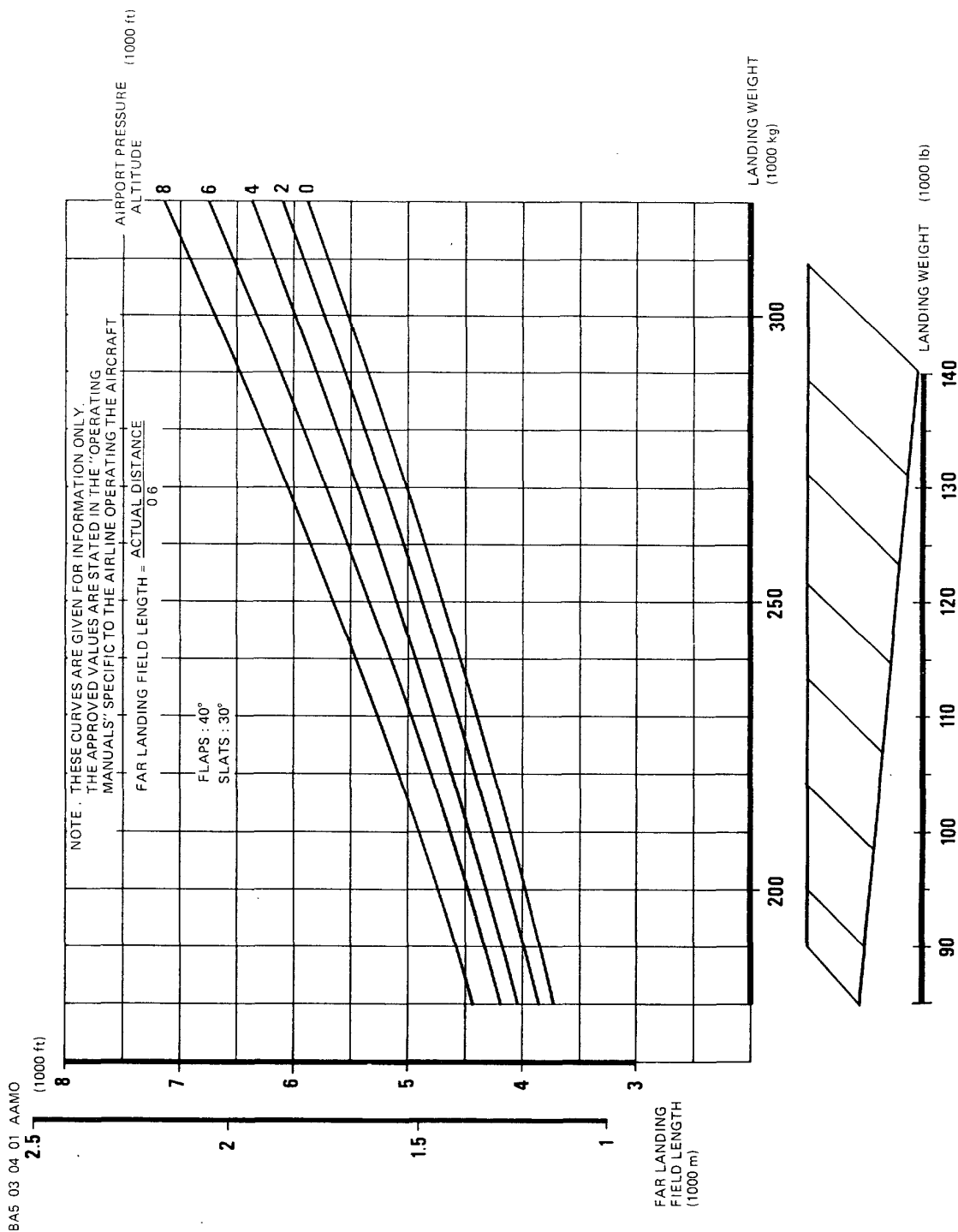

3.4 F.A.R. LANDING RUNWAY REQUIREMENTS
3.4.1 ALL AMBIENT TEMPERATURES
 GE ENGINES
 MODEL 200 AND 300

N

Printed in France



AIRPLANE CHARACTERISTICS FOR AIRPORT PLANNING

FAR LANDING FIELD LENGTH
ALL AMBIENT TEMPERATURES

$$\text{FAR LANDING FIELD LENGTH} = \frac{\text{ACTUAL DISTANCE}}{0.6}$$

FAR LANDING
FIELD LENGTH

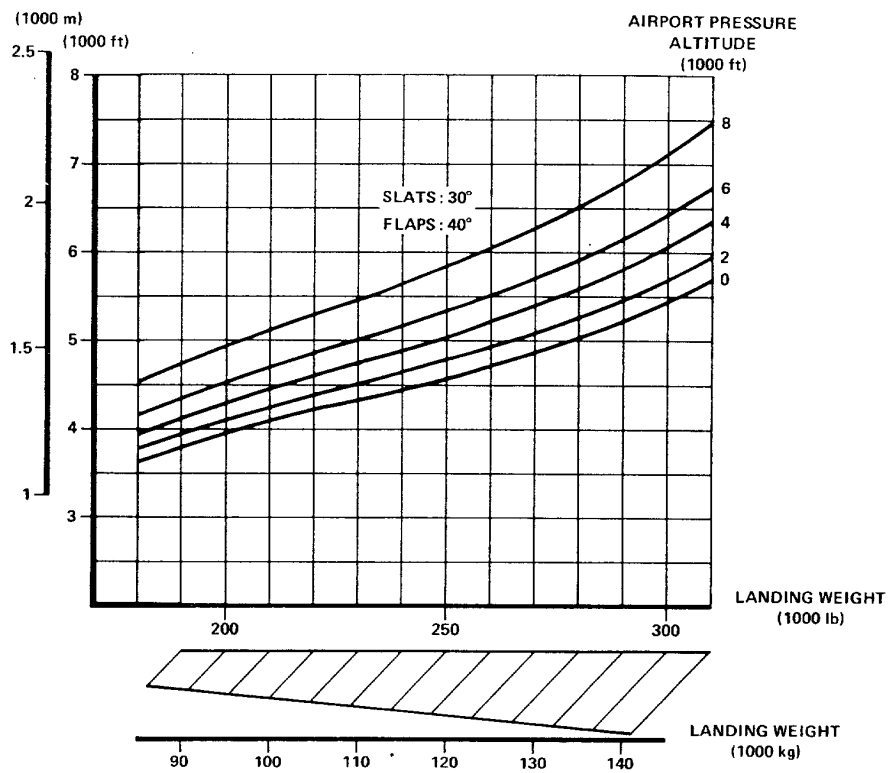

BA5 03 04 01 0 ACM0

3.4 FAR LANDING RUNWAY REQUIREMENTS 3.4.1 ALL AMBIENT TEMPERATURES PW ENGINES MODEL 200 AND 300

Chapter 3.4.1
Page 2
Oct 87

R

Printed in France



AIRPLANE CHARACTERISTICS FOR AIRPORT PLANNING

FINAL APPROACH SPEED (1.3 V_s)
AT 50 ft
LANDING GEAR DOWN

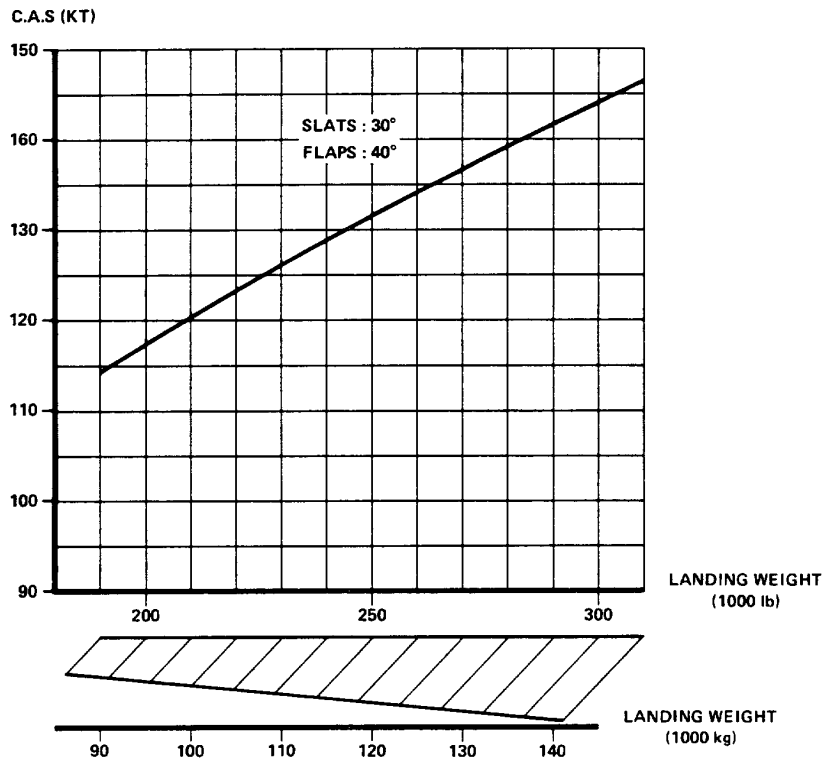

BA5 03 05 01 0 AAM0

3.5 FINAL APPROACH SPEED 3.5.1 FINAL APPROACH SPEED GE AND PW ENGINES MODEL 200 AND 300

Chapter 3.5.1
Page 1
Nov 94

- 4.0 GROUND MANEUVERING
- 4.1 General Information
- 4.2 Turning Radii, no Slip Angle
- 4.3 Minimum Turning Radii
- 4.4 Visibility from Flight Compartment in Static Position
- 4.5 Runway and Taxiway Turn Paths
 - 4.5.1 More than 90° Turn Runway to Taxiway Turn
 - 4.5.2 90° Turn-Runway to Taxiway
 - 4.5.3 90° Turn-Taxiway to Taxiway
- 4.6 Runway Holding Bay (Apron)

4.1 GENERAL INFORMATION

This section provides airplane turning capability and maneuvering characteristics.

For ease of presentation, this data has been determined from the theoretical limits imposed by the geometry of the aircraft, and where noted, provides for a normal allowance for tire slippage. As such, it reflects the turning capability of the aircraft in favorable operating circumstances. This data should only be used as guidelines for the method of determination of such parameters and for the maneuvering characteristics of this aircraft type.

In the ground operating mode, varying airline practices may demand that more conservative turning procedures be adopted to avoid excessive tire wear and reduce possible maintenance problems. Airline operating techniques will vary in the level of performance, over a wide range of operating circumstances throughout the world. Variations from standard aircraft operating patterns may be necessary to satisfy physical constraints within the maneuvering area, such as adverse grades, limited area or high risk of jet blast damage. For these reasons, ground maneuvering requirements should be coordinated with the using airlines prior to layout planning.

NOTE :
 ACTUAL OPERATING DATA MAY
 BE GREATER THAN VALUES SHOWN
 SINCE TIRE SLIPPAGE IS NOT
 CONSIDERED IN THESE CALCULATIONS

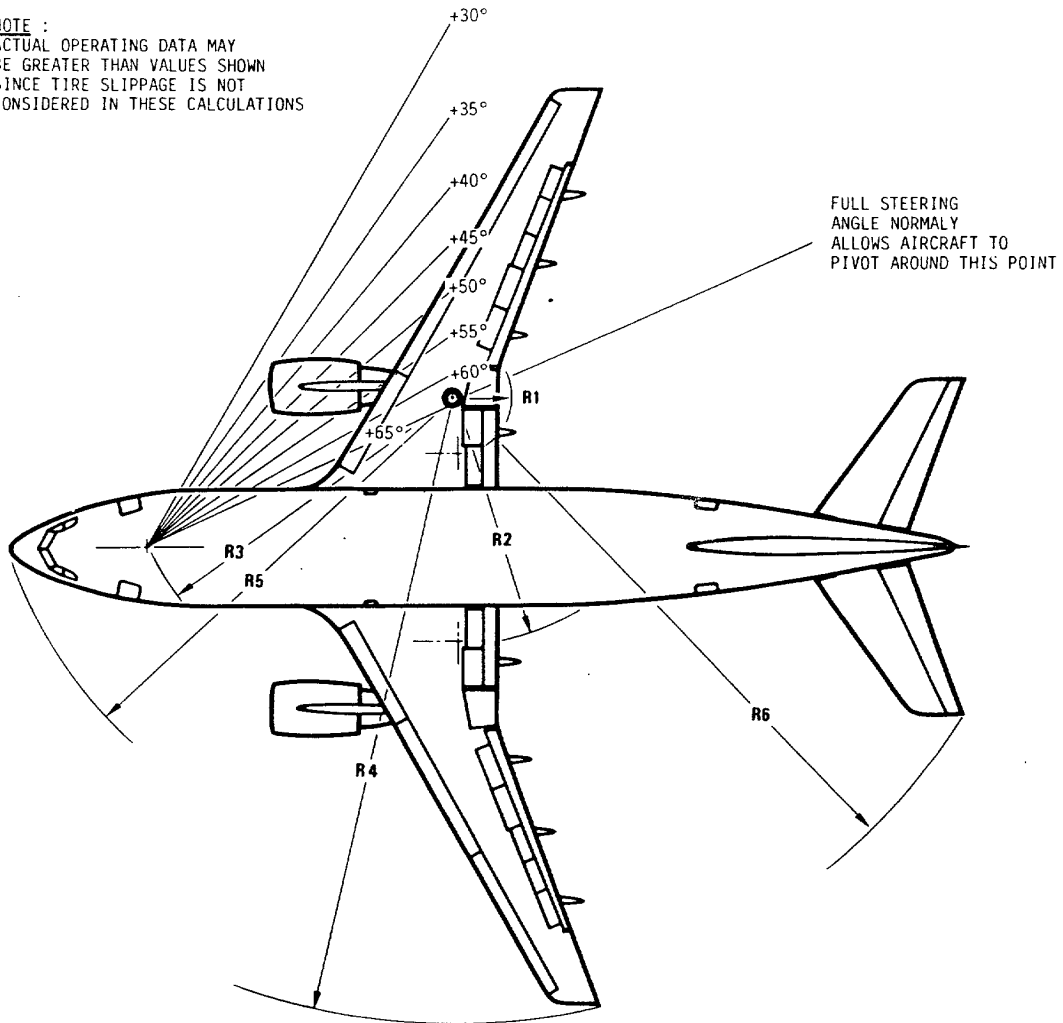

BA5 04 02 00 AAM0

STEERING ANGLE (°)	R1		R2		R3		R4		R5		R6	
	ft	m	ft	m	ft	m	ft	m	ft	m	ft	m
30	71.30	21.73	102.79	31.33	100.50	30.63	160.61	48.95	112.83	34.39	139.34	42.47
35	56.01	17.07	87.50	26.67	87.60	26.70	145.51	44.35	101.51	30.94	127.17	38.76
40	44.13	13.45	75.63	23.05	78.19	23.83	133.77	40.77	93.51	28.50	118.21	36.03
45	34.48	10.51	65.98	20.11	71.07	21.66	124.28	37.88	87.67	26.72	111.30	33.94
50	26.41	8.05	57.91	17.65	65.59	19.99	116.34	35.46	83.27	25.38	105.94	32.29
55	19.42	5.92	50.92	15.52	61.35	18.70	109.49	33.37	79.99	24.38	101.55	30.95
60	13.26	4.04	44.75	13.64	58.01	17.68	103.45	31.53	77.46	23.61	97.91	29.84
65	7.68	2.34	39.18	11.94	55.45	16.90	98.04	29.88	75.56	23.03	94.85	28.91

4.2 TURNING RADII NO SLIP ANGLE.

R

Printed in France

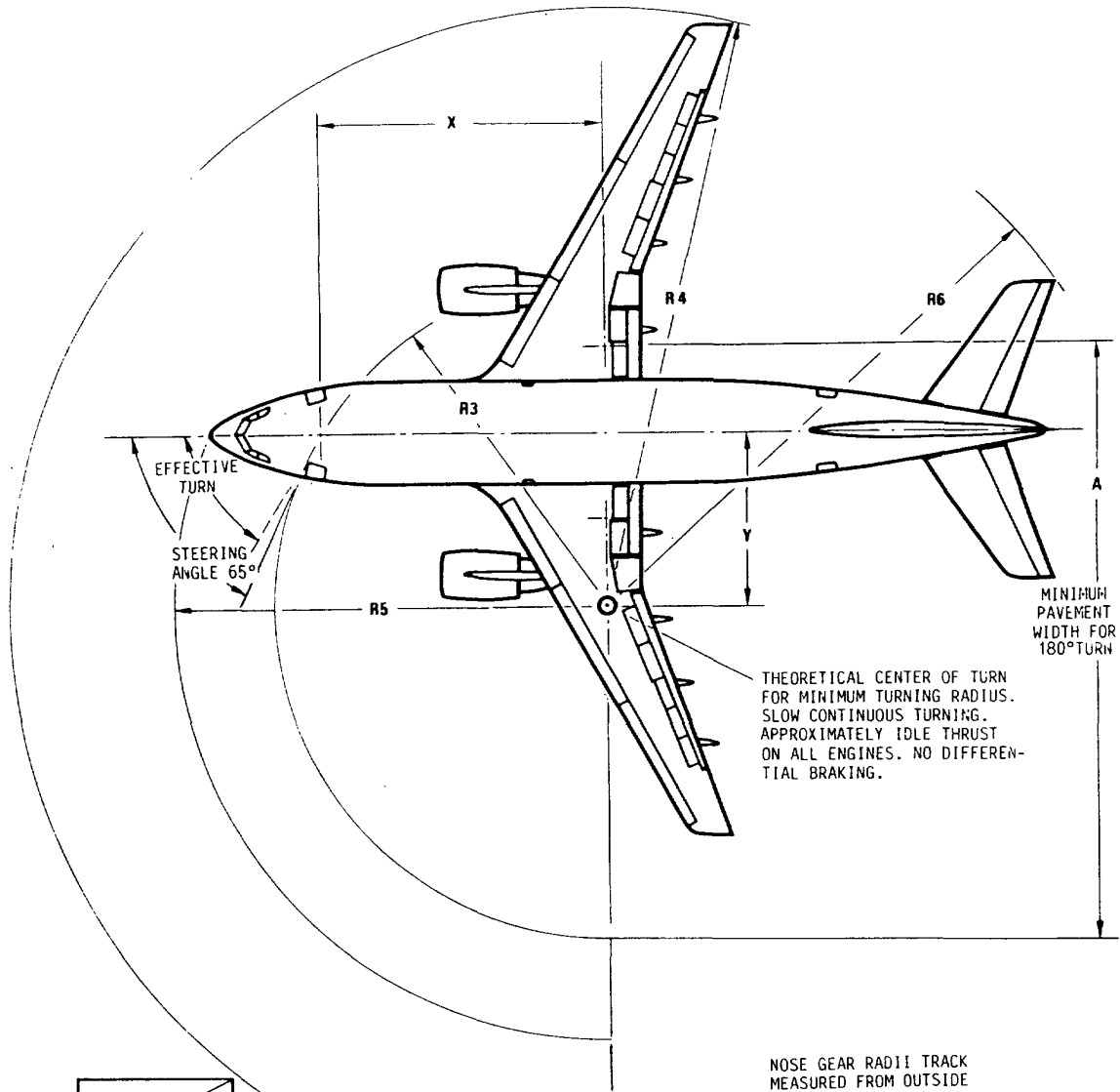

FEET	METERS
------	--------

NOSE GEAR RADI TRACK MEASURED FROM OUTSIDE FACE OF TIRE

A/C C.G.	EFFECTIVE TURN ANGLE	X	Y	A	R3	R4	R5	R6
FWD 18%	60°2	50.89 15.51	28.77 8.77	105.42 32.13	58.63 17.87	103.25 31.47	77.37 23.58	97.77 29.80
AFT 35%	55°8	50.89 15.51	34.15 10.41	113.69 34.65	61.52 18.75	108.50 33.07	79.53 24.24	100.92 30.76
AFT 38%	53°	50.89 15.51	37.86 11.54	116.51 35.51	62.90 19.17	112.11 34.17	81.17 24.74	103.19 31.45

BA5' 04 03 00 AAMO

4.3 MINIMUM TURNING RADII

R

A310

AIRPLANE CHARACTERISTICS

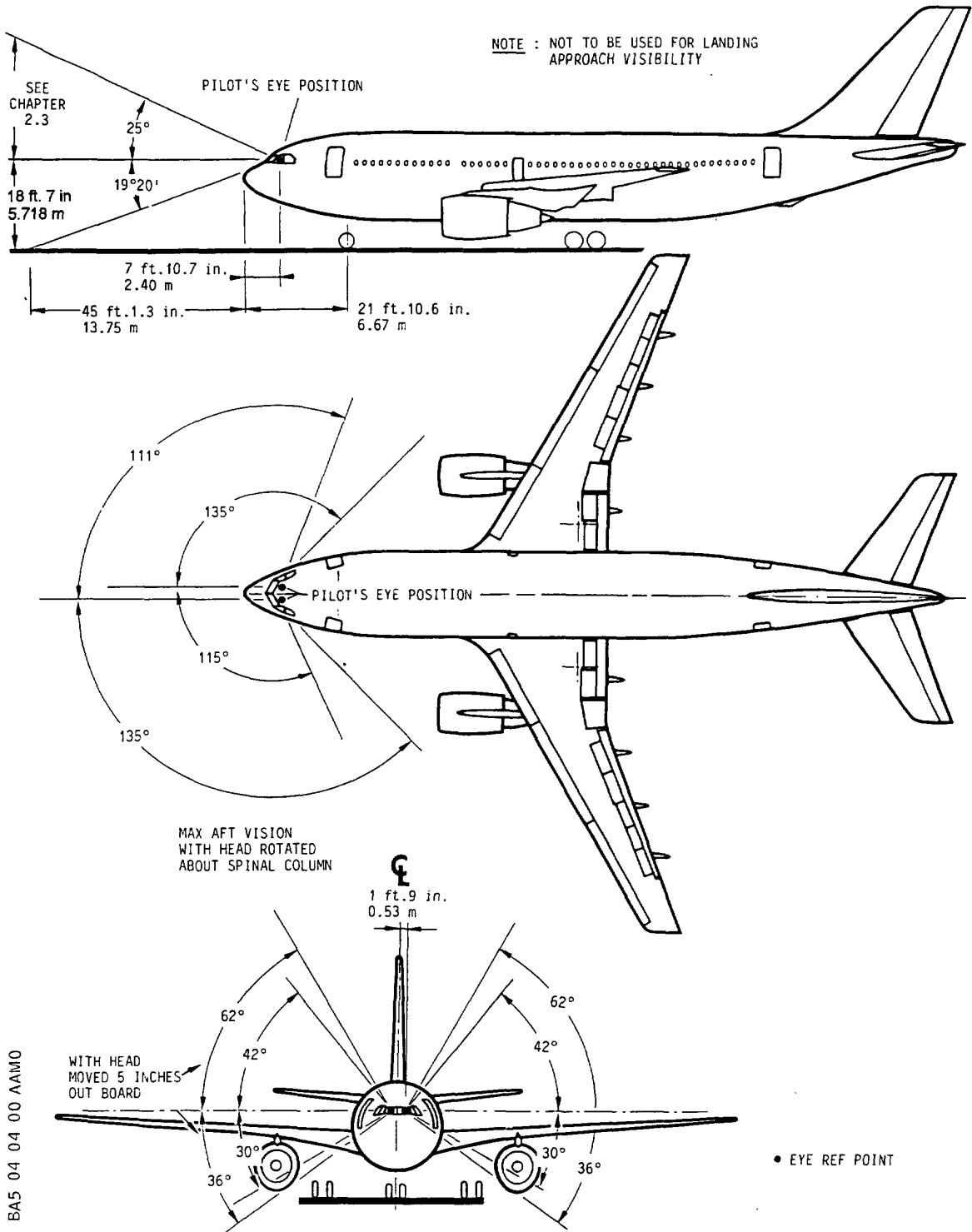

BA5 04 04 00 AAM0

4.4 VISIBILITY FROM FLIGHT COMPARTMENT IN STATIC POSITION

Chapter 4.4.0
Page 1
Nov 94

Printed in France

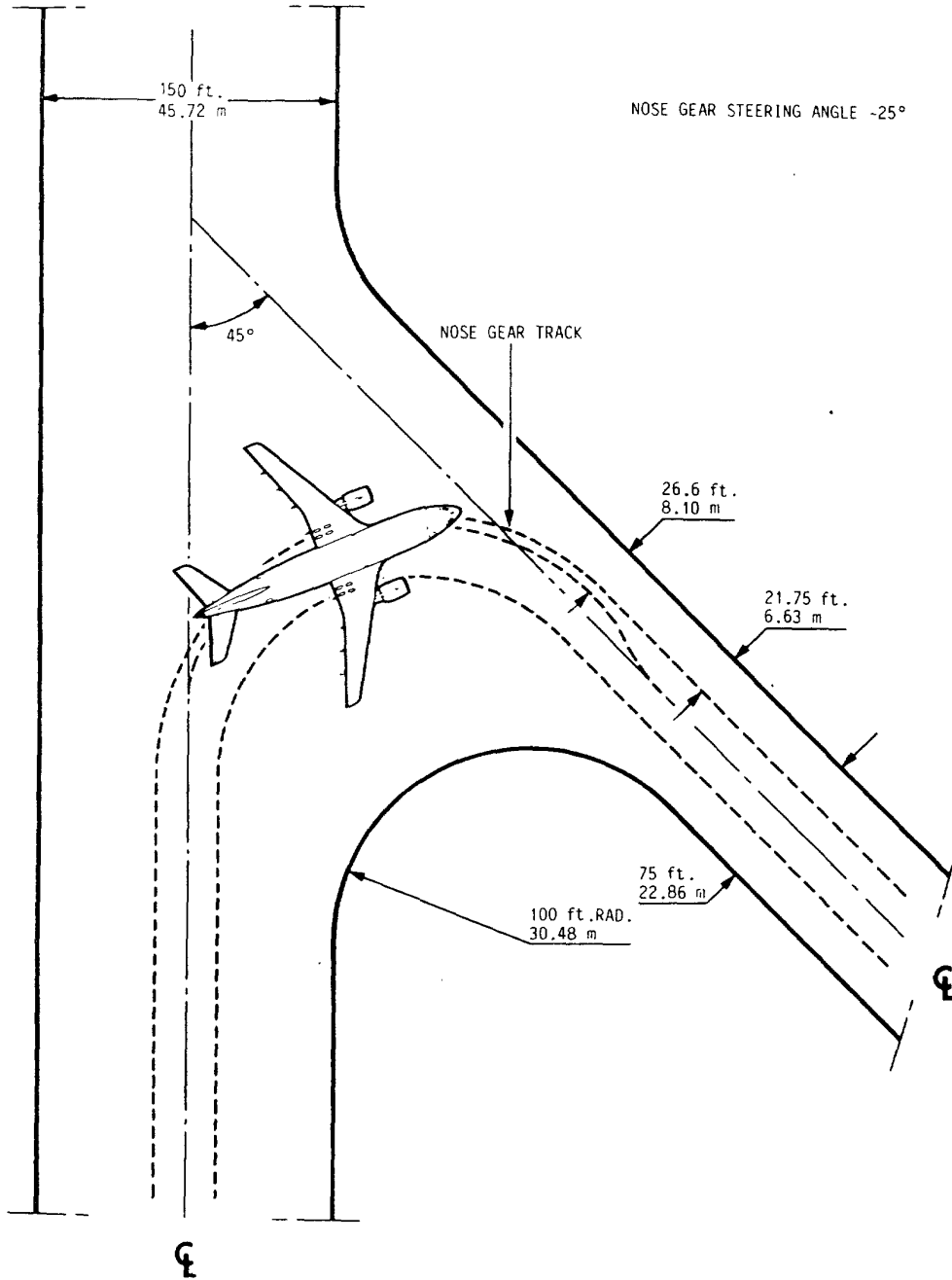

BA5 04 05 01 AAMO

NOTE : COORDINATE WITH USING AIRLINE FOR SPECIFIC PLANNED OPERATING PROCEDURE

4.5 RUNWAY AND TAXIWAY TURN PATHS
4.5.1 MORE THAN 90° TURN RUNWAY TO TAXIWAY TURN

R

Printed in France

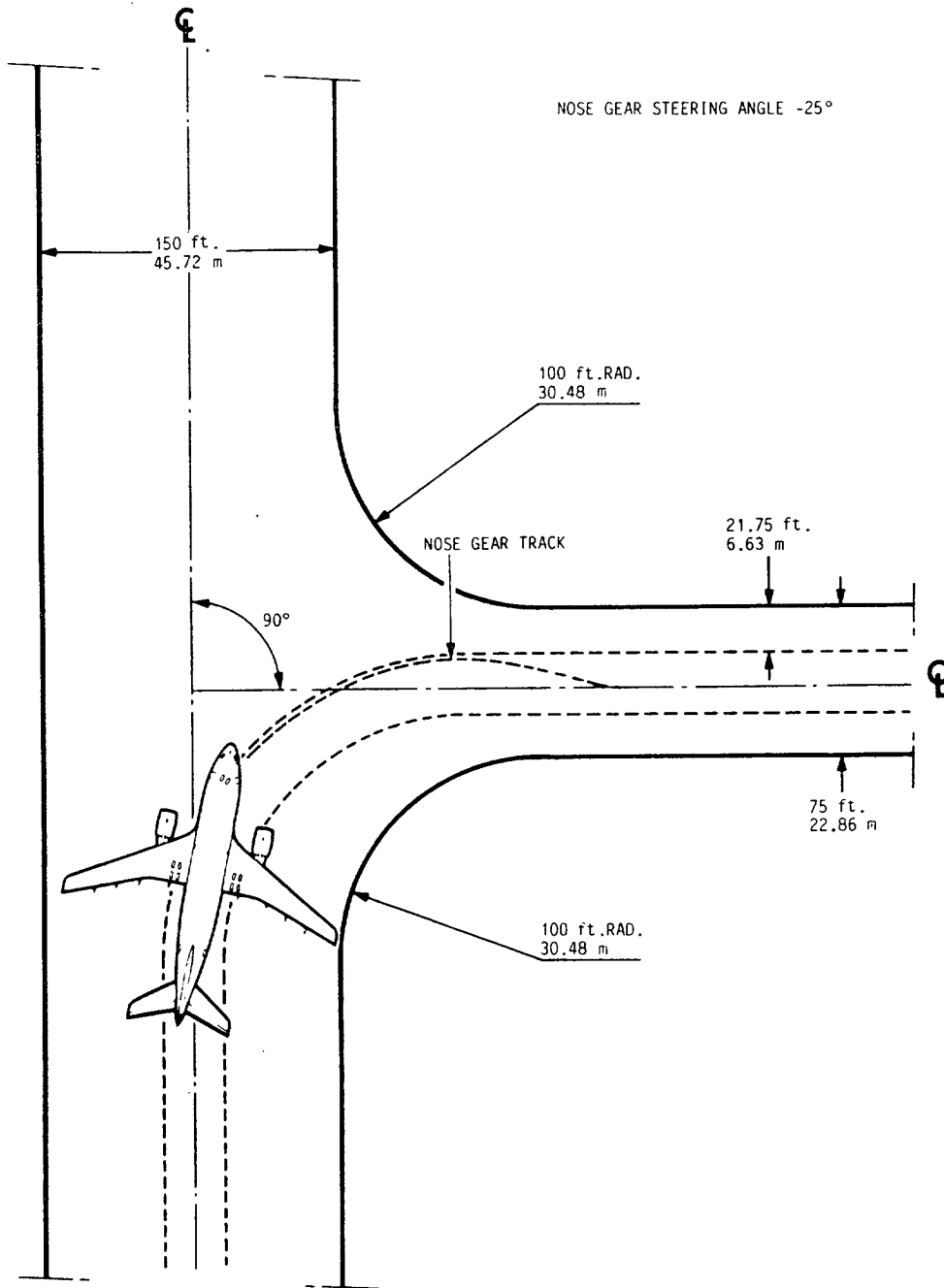

NOTE : COORDINATE WITH USING AIRLINE FOR SPECIFIC PLANNED OPERATING PROCEDURE

4.5 RUNWAY AND TAXIWAY TURN PATHS
4.5.2 90° TURN RUNWAY TO TAXIWAY

BA5 04 05 02 AAM0

R

Printed in France

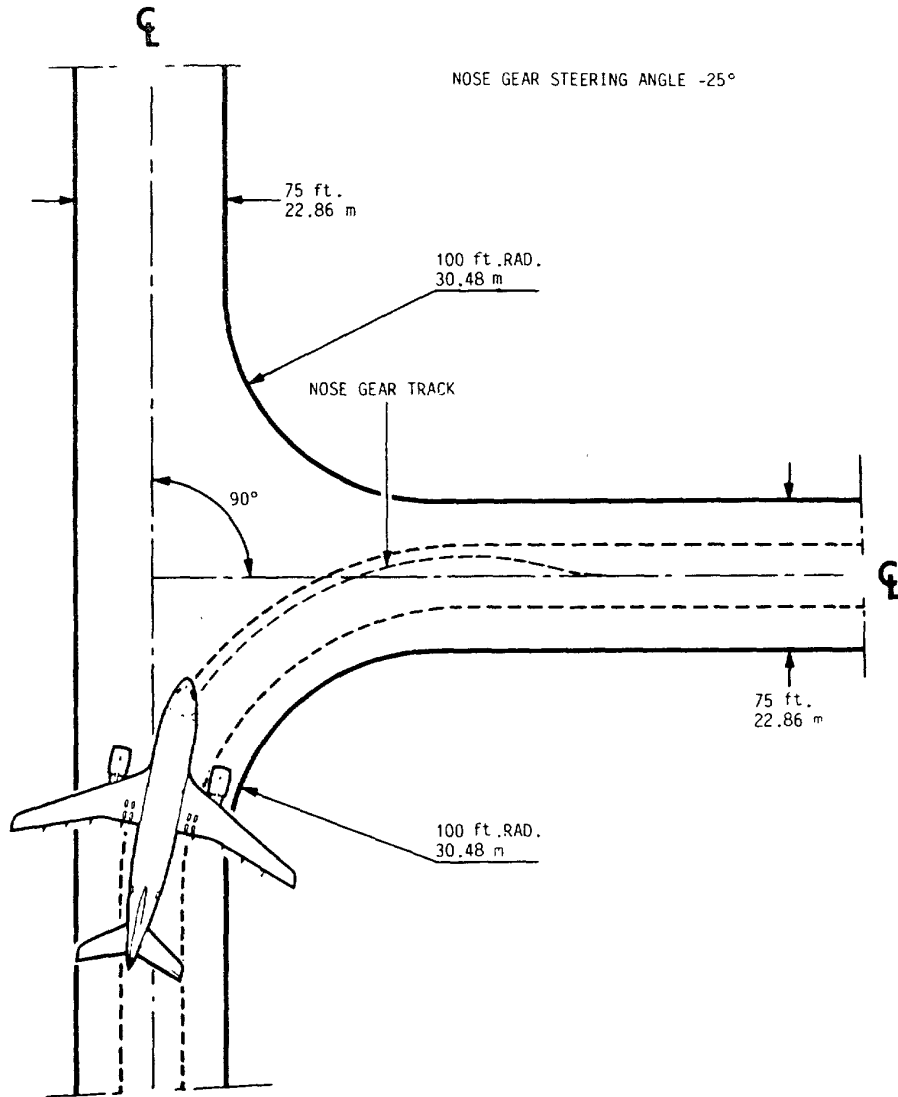

NOTE : COORDINATE WITH USING AIRLINE FOR SPECIFIC PLANNED OPERATING PROCEDURE

4.5 RUNWAY AND TAXIWAY TURN PATHS
4.5.3 90° TURN-TAXIWAY TO TAXIWAY

BA5 04 05 03 AAM0

R

Printed in France

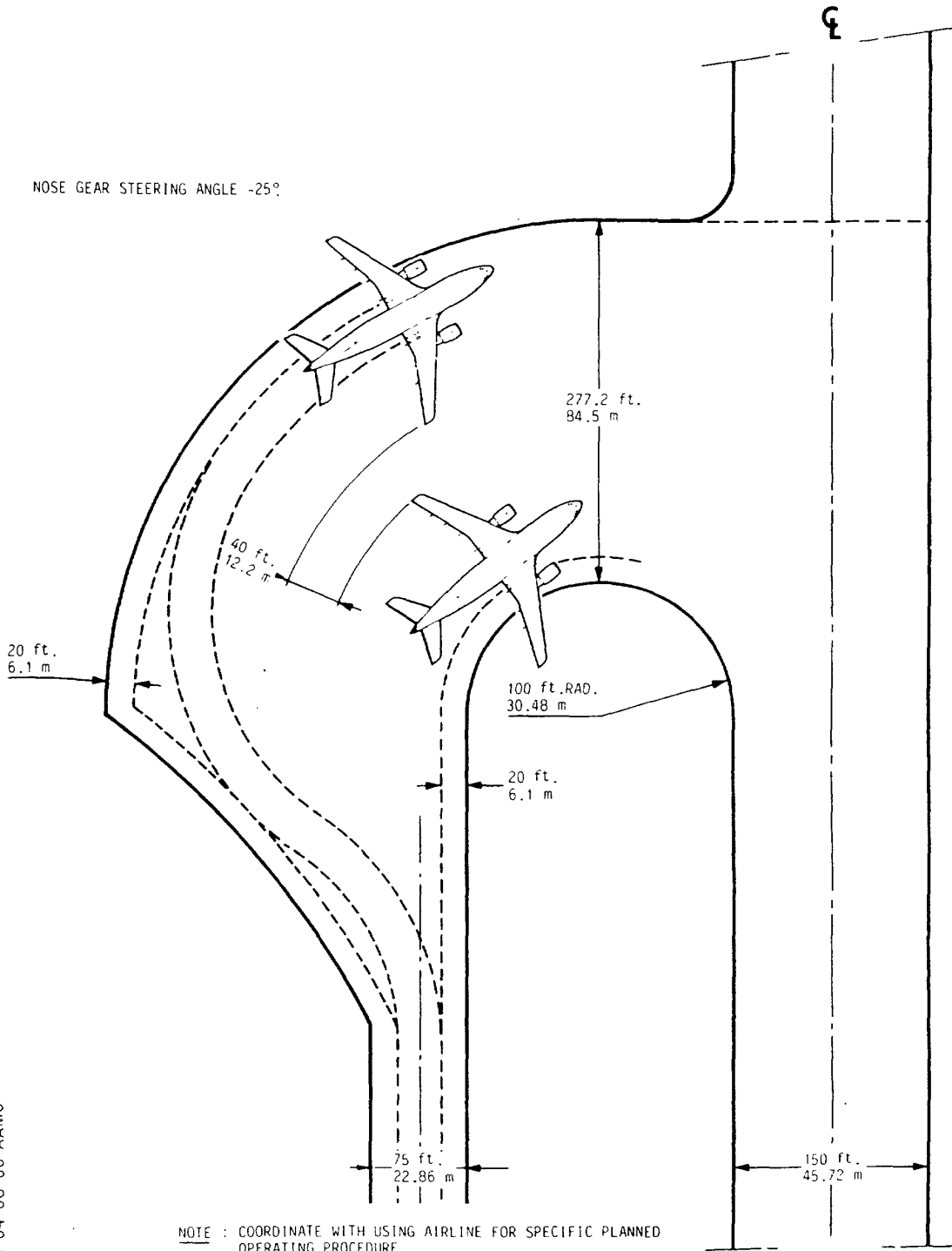

4.6 RUNWAY HOLDING BAY (APRON)

BA5 04 06 00 AAM0

R



AIRPLANE CHARACTERISTICS FOR AIRPORT PLANNING

- R 5.0 TERMINAL SERVICING
 - 5.1 Airplane Servicing Arrangements - Typical
 - R 5.1.1 Symbols Used On Servicing Diagrams
 - R 5.1.2 Open Apron Free Standing - Passenger's Stairways
 - R 5.1.3 Open Apron Free Standing - Cargo Loading
 - 5.2.1 Turnaround Station (30 Minutes)
 - 5.2.2 Turnaround Station (45 Minutes)
 - 5.2.3 Turnaround Station (90 Minutes)
- R 5.3 Terminal Operations - En route Station
 - 5.4 Ground Service Connections
 - 5.4.1 Symbols Used On Ground Service Connections Diagrams
 - 5.4.2 Ground Service Connections Layout
 - 5.4.3 Hydraulic System
 - 5.4.4 Electrical System
 - 5.4.5 Oxygen System
 - 5.4.6 Fuel System
 - 5.4.7 Pneumatic System
 - 5.4.8 Potable Water System
 - 5.4.9 Oil System
 - 5.4.10 Toilet System
 - 5.5 Engine Starting Pneumatic Requirements
 - 5.5.1 Ambient Temperature -40°C (-40°F)
 - 5.5.2 Ambient Temperature $+15^{\circ}\text{C}$ ($+60^{\circ}\text{F}$)
 - 5.5.3 Ambient Temperature $+38^{\circ}\text{C}$ ($+100^{\circ}\text{F}$)
 - 5.6 Ground Pneumatic Power Requirements
 - 5.6.1 Heating
 - 5.6.2 Cooling
 - 5.7 Preconditioned Airflow Requirements
- N 5.8 Ground Towing Requirements
 - R 5.8.1 Ground Towing Requirements - Towbar Design

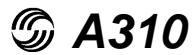

AIRPLANE CHARACTERISTICS FOR AIRPORT PLANNING

This section provides typical ramp layouts, showing the various GSE items in position during typical turnaround scenarios. These ramp layouts show typical arrangements only. Each operator will have its own specific requirements/regulations for the positioning and operation on the ramp.

For each ramp layout, the associated typical turnaround time is given in a Chart in section 5.2.1 for the passenger aircraft.

AS	-	AIR STARTING UNIT
BL	-	BULK LOADER
D	-	DOLLY
F	-	FUEL TANKER
GC	-	GROUND AIR PRECONDITIONING UNIT
GL	-	GROUND LOADER
GPU	-	ELECTRICAL GROUND POWER UNIT
GS	-	GALLEY SERVICE TRUCK
P	-	PASSENGER LOADING BRIDGE
ST	-	STAIRWAY
T	-	TRANSPORTER
TS	-	TOILET SERVICE TRUCK
UL	-	UPPERDECK LOADER
W	-	WATER SERVICE TRUSK

Airplane Servicing Arrangements
Symbols Used On Servicing Diagrams
Model A310

AIRPLANE CHARACTERISTICS FOR AIRPORT PLANNING

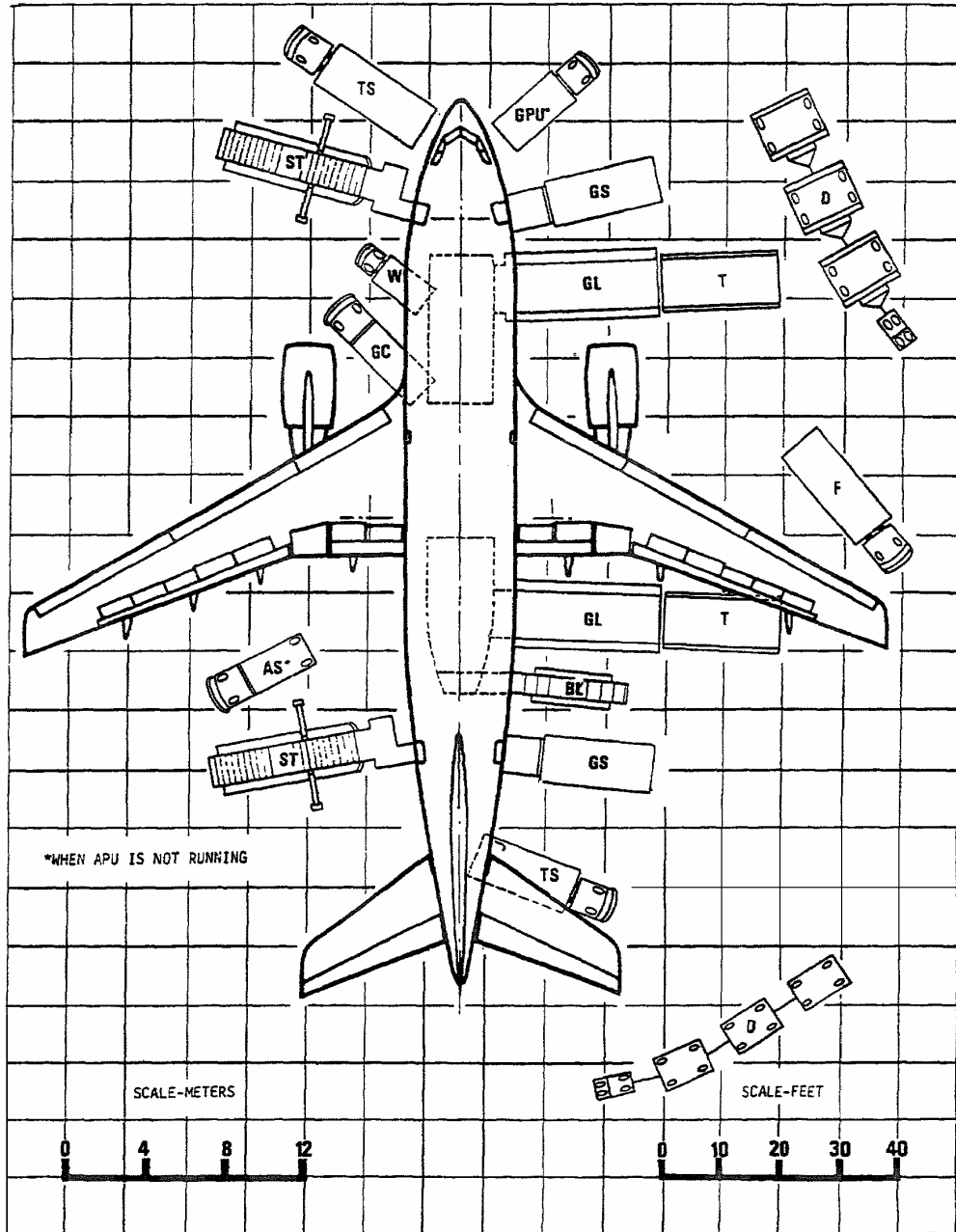

BA5 05 01 00 5 AAM0 00

Airplane Servicing Arrangements - Typical
Open Apron Free Standing - Passenger's Stairways
Model 200 and 300

AIRPLANE CHARACTERISTICS FOR AIRPORT PLANNING

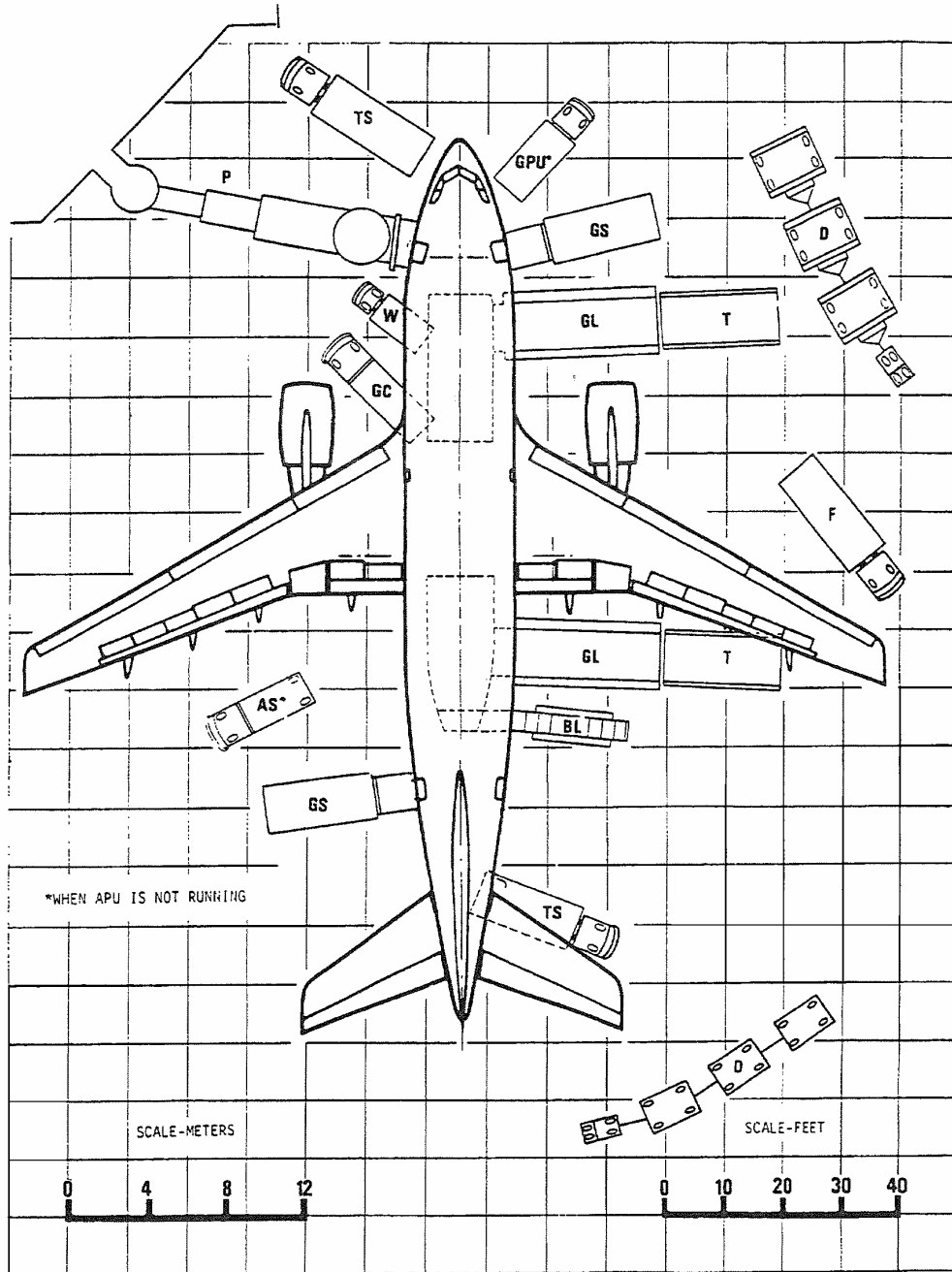

BA5 05 01 00 5 ABMD 00

Airplane Servicing Arrangements - Typical
Open Apron Free Standing - Passenger's Loading Bridge
Model 200 and 300

AIRPLANE CHARACTERISTICS FOR AIRPORT PLANNING

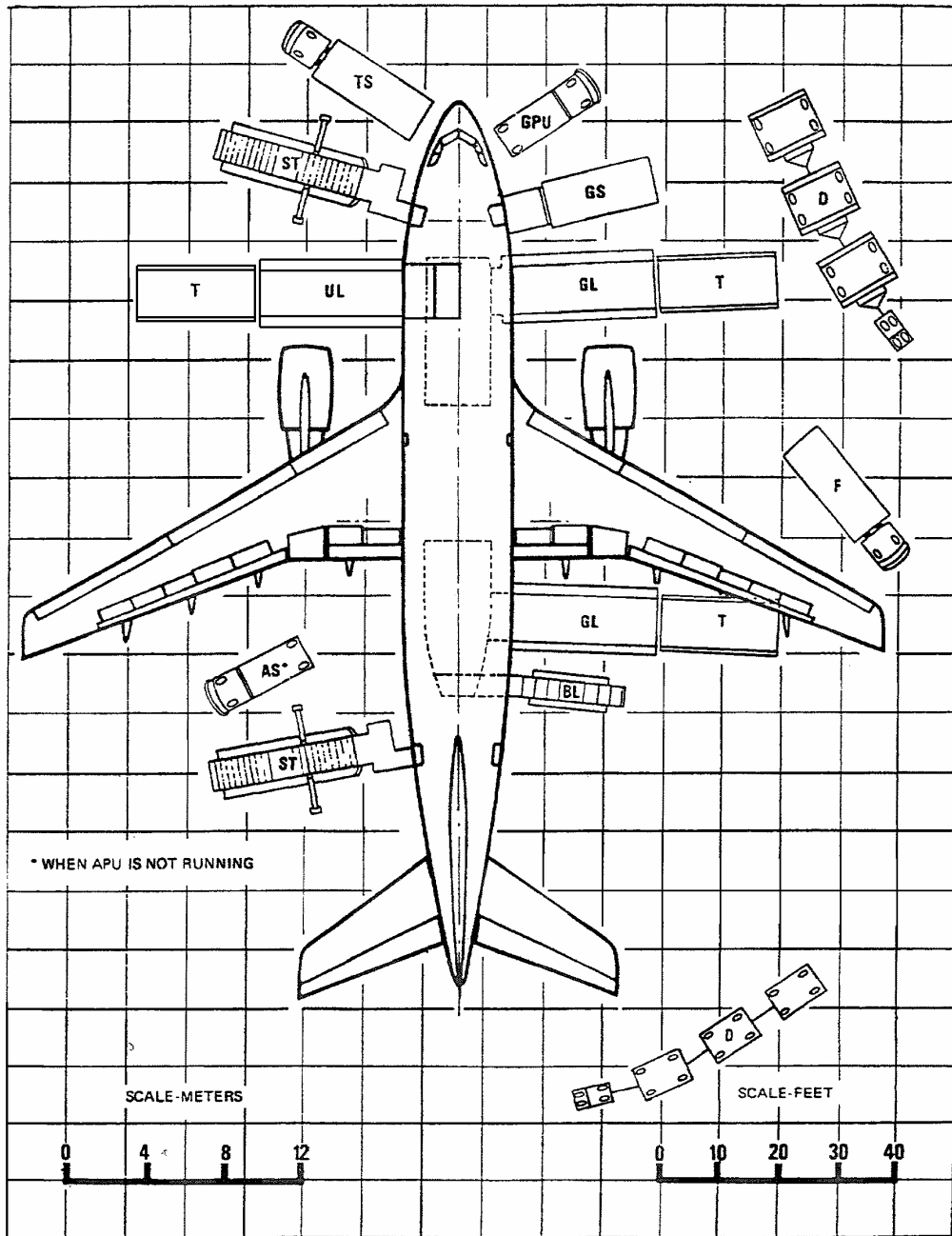

BA5 05 01 00 5 ACM0 00

**Airplane Servicing Arrangements - Typical
Open Apron Free Standing - Cargo Loading
Model 200 C**



AIRPLANE CHARACTERISTICS FOR AIRPORT PLANNING

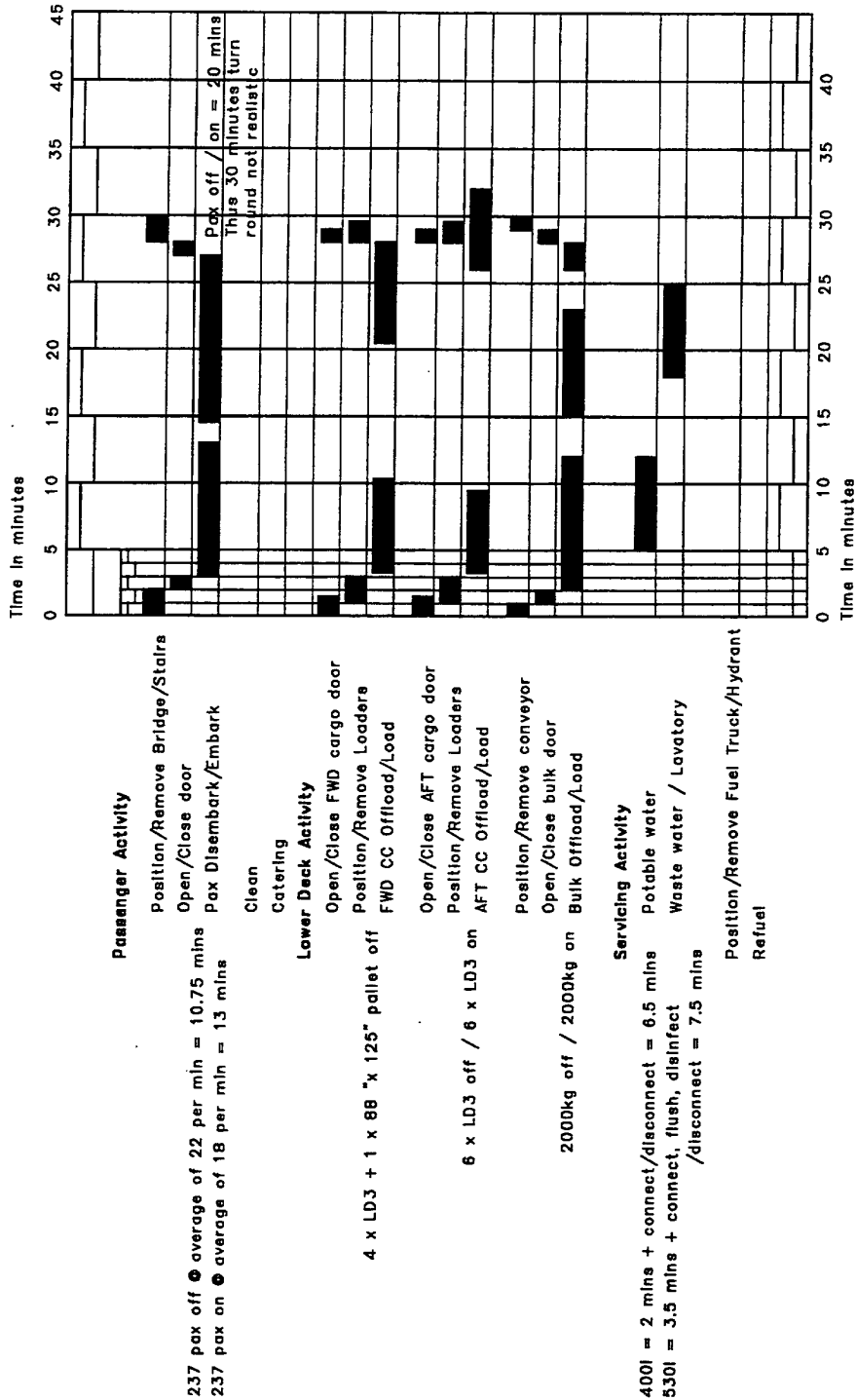

BA5 05 02 01 0 AAMO

5.2 TERMINAL OPERATIONS

5.2.1 TURNAROUND STATION 30 MINUTES

Model 200 and 300

AIRPLANE CHARACTERISTICS FOR AIRPORT PLANNING

BA5 05 02 02 0 AAMO

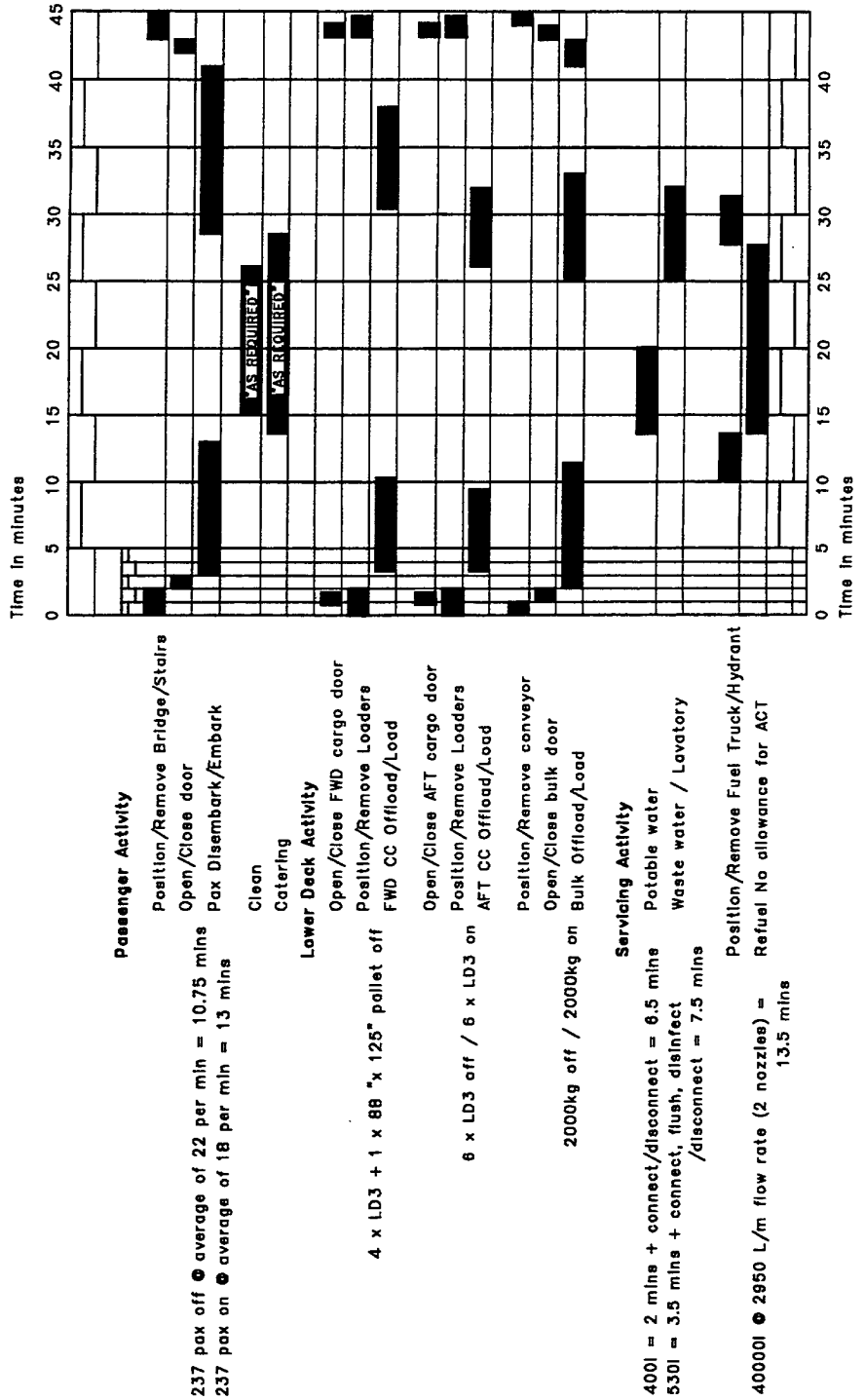

**5.2 TERMINAL OPERATIONS
 5.2.2 TURNAROUND STATION 45 MINUTES
 MODEL 200 AND 300**



AIRPLANE CHARACTERISTICS FOR AIRPORT PLANNING

BA5 05 02 03 0 AAMO

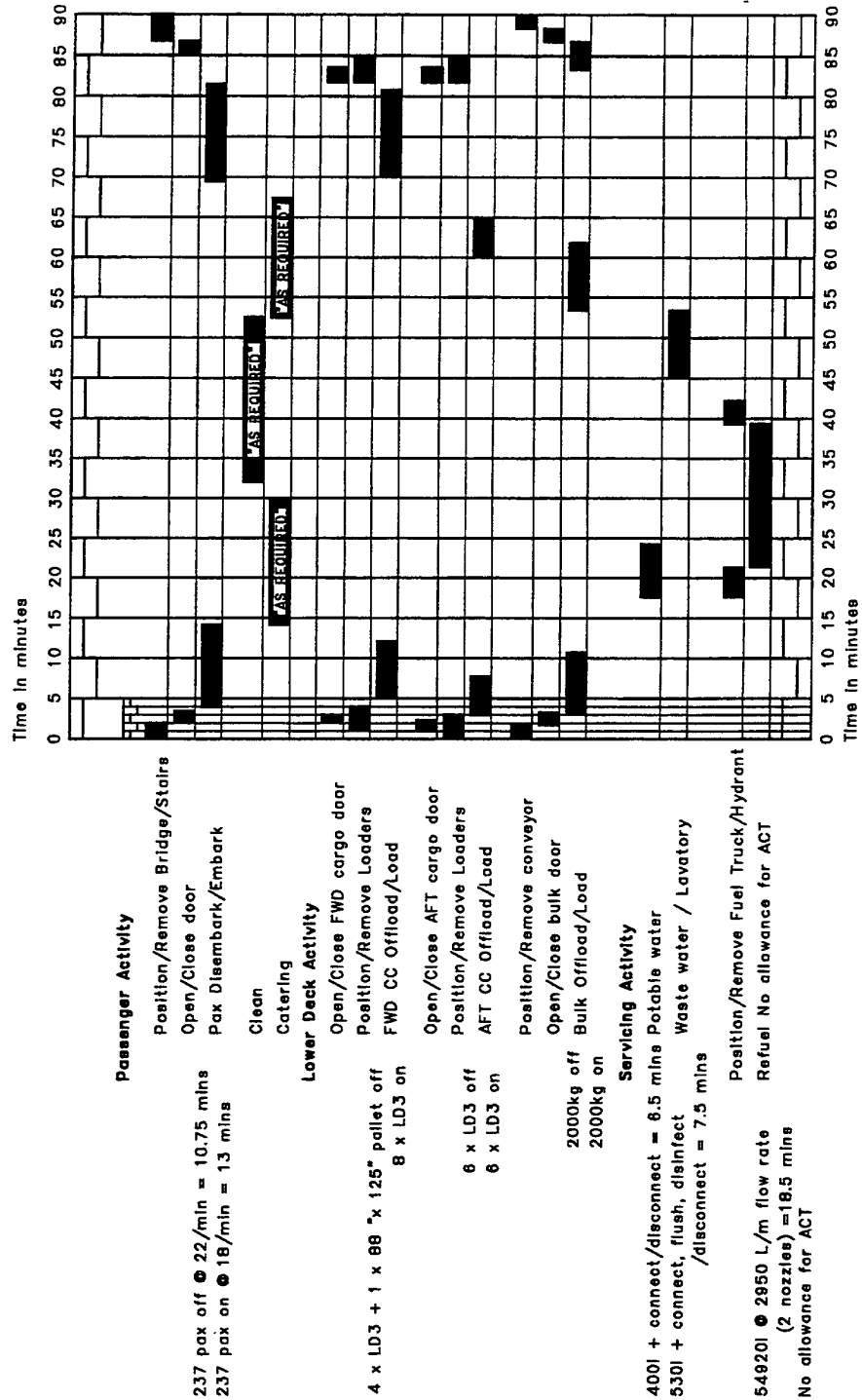

5.2 TERMINAL OPERATIONS

5.2.3 TURNAROUND STATION 90 MINUTES

MODEL 200 AND 300

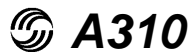

AIRPLANE CHARACTERISTICS FOR AIRPORT PLANNING

5.3 Terminal Operations - En Route Station

This section provides a chart showing typical activities for home-base turnaround. This data is provided to show the general scope and type of activities involved in ramp operations during the turnaround of an aircraft. Varying Airline practices and operating circumstances may result in different sequences and different time intervals to do the activities shown.

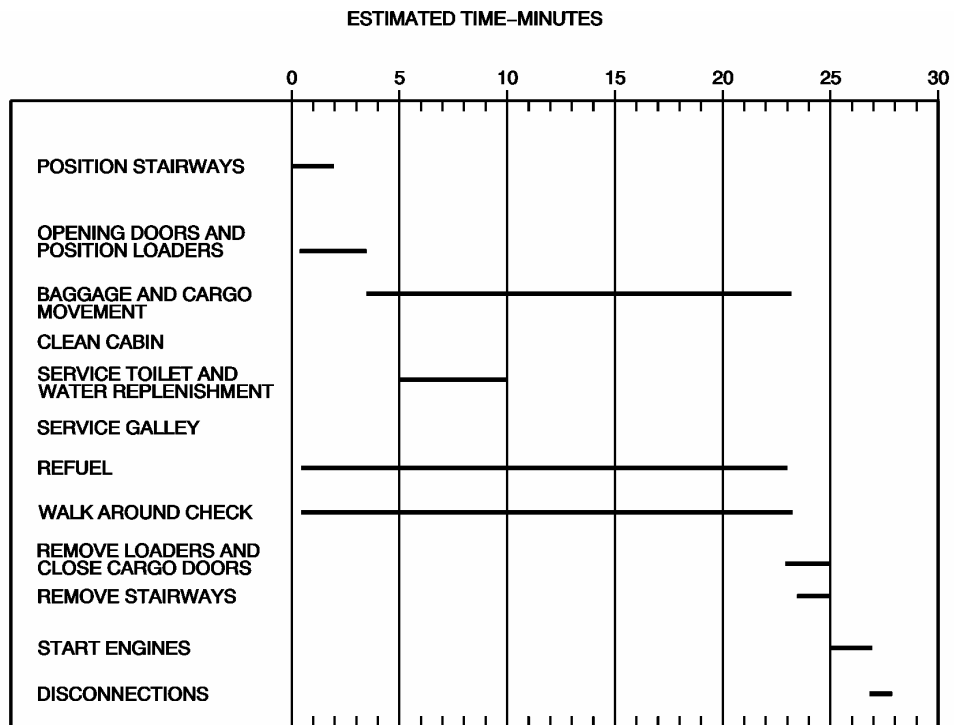

ALL FREIGHT CONTAINERIZED
 - 21 STANDARD M SIZE ULDS ON MD
 - 4 STANDARD M SIZE ULDS IN FWD LDCC
 - 10 STANDARD K SIZE ULDS IN AFT LDCC

100% UNLOADING/LOADING

APU RUNNING

NOTE : IF THE AIRCRAFT IS FITTED WITH ACT'S THE REFUELING TIME WILL BE LONGER
 (UP TO 65 mn WITH 2 ACT INSTALLED)

BA5 05 03 00 5 AAM0 00

Terminal Operations - En Route Station
 Model A310

Printed in France

A	-	POTABLE WATER FILLING AND DISCHARGING
A1	-	POTABLE WATER DRAINING
D	-	ENGINE AND IDG OIL FILLING
E	-	LAVATORY SERVICING, FORWARD AND AFT
F	-	ELECTRICAL GROUND POWER
G	-	PRECONDITIONING - LP
H	-	GRAVITY FILLING
J	-	HYDRAULIC
L	-	PRESSURE REFUELING
M	-	ENGINE STARTING/HP

BA5 05 04 01 AAMO

R

5.4 GROUND SERVICE CONNECTIONS
5.4.1 SYMBOLS USED ON GROUND
SERVICE CONNECTIONS DIAGRAMS

Printed in France

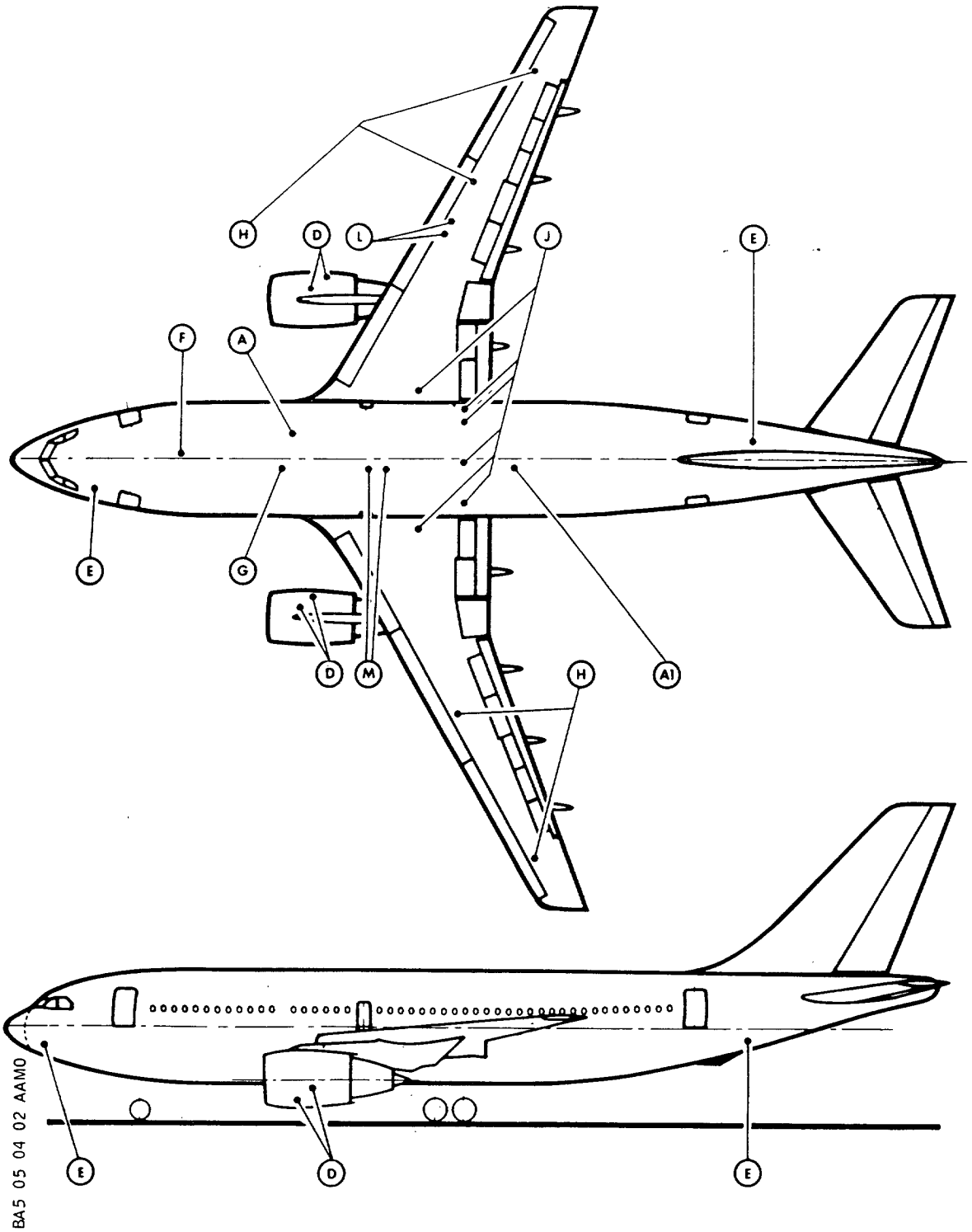

5.4 GROUND SERVICE CONNECTIONS
 5.4.2 GROUND SERVICE CONNECTIONS LAYOUT
 MODEL 200 (ENGINE GE CF6 80 A3)

R

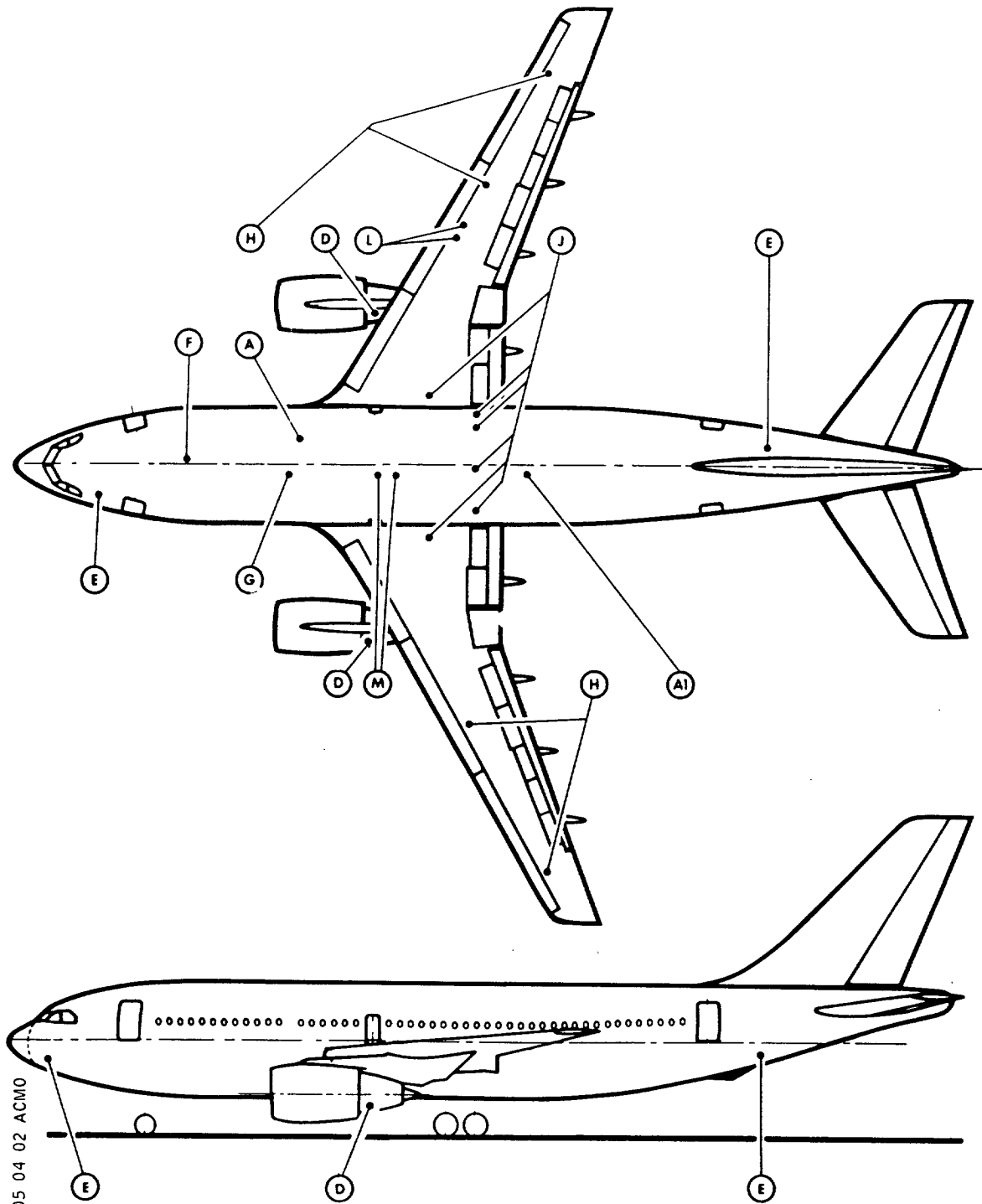

BA5 05 04 02 ACMO

5.4 GROUND SERVICE CONNECTIONS
 5.4.2 GROUND SERVICE CONNECTIONS LAYOUT
 MODEL 200 (ENGINE PW JT9D-7R4)

R

Printed in France

Printed in France

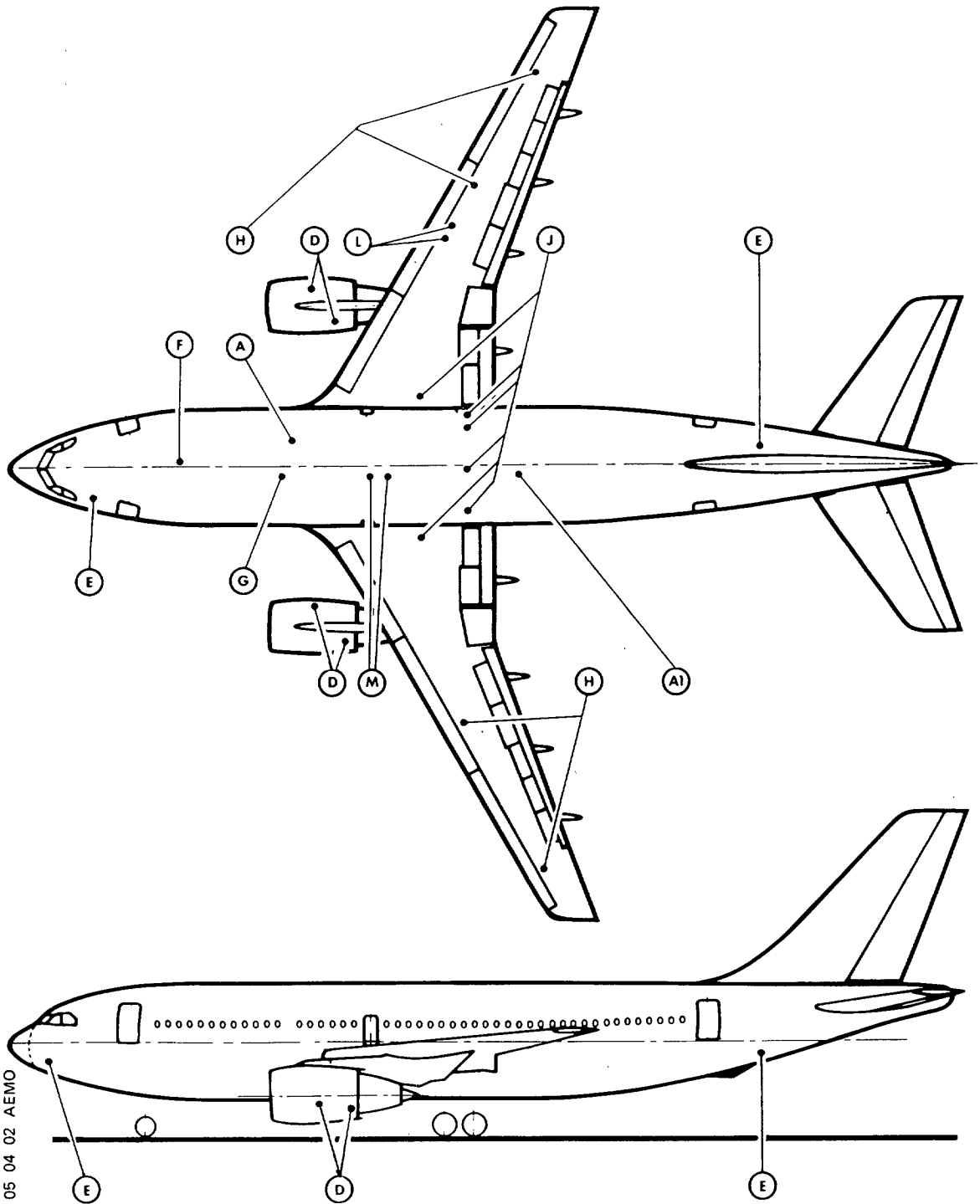

BA5 05 04 02 AEMO

5.4 GROUND SERVICE CONNECTIONS
 5.4.2 GROUND SERVICE CONNECTIONS LAYOUT
 MODEL 300 (ENGINE GE CF6 80 C2)

N

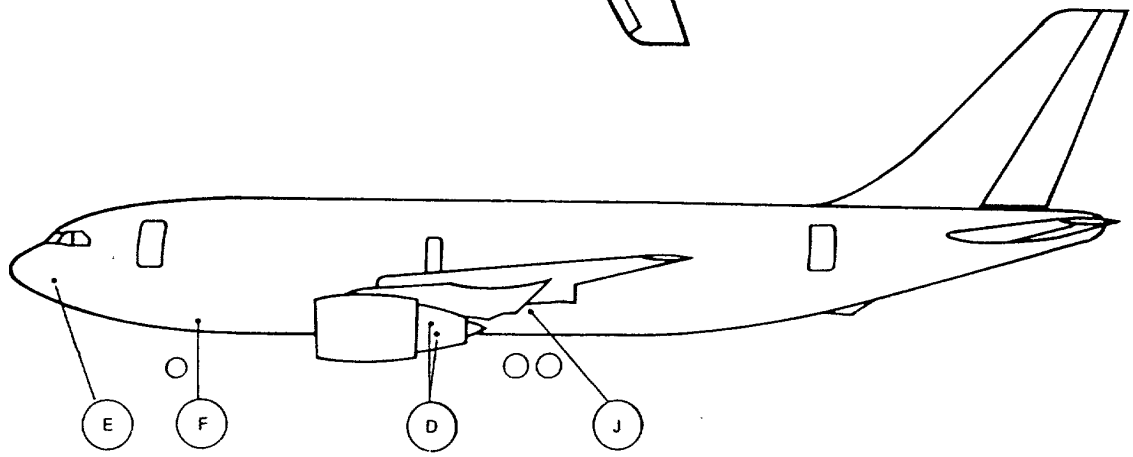
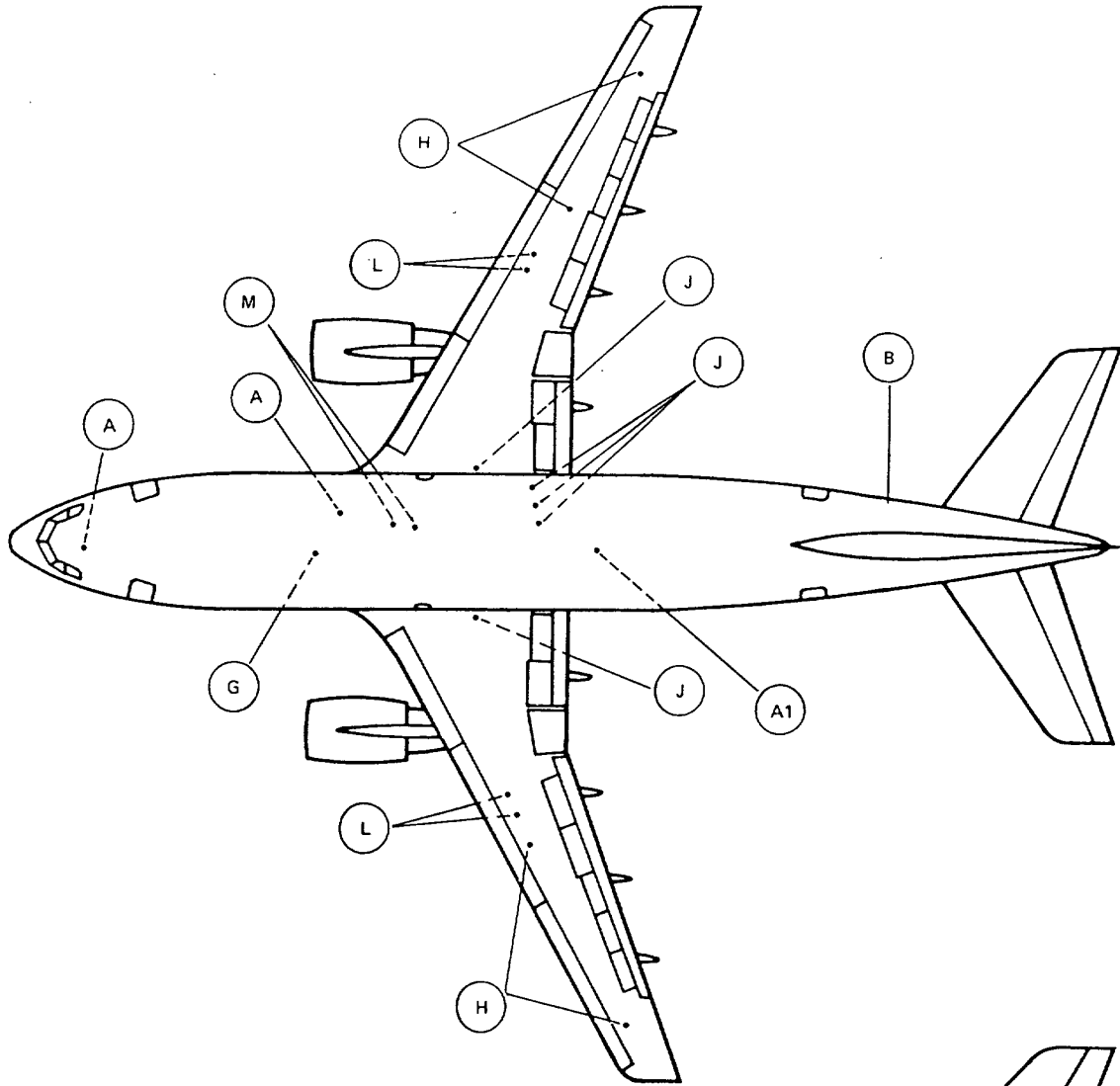

BA5 05 04 02 0 AGMO

5.4 GROUND SERVICE CONNECTIONS
5.4.2 GROUND SERVICE CONNECTIONS LAYOUT
MODEL 300 (ENGINE PW 4000)

HYDRAULIC SYSTEM

Printed in France

- A. Tank pressurization :
One 1/4 in. self sealing connection common to the 3 tanks
- B. Accumulator charging :
One MS28889 - 1 connection for both YELLOW system accumulators

One MS28889 - 1 connection for YELLOW system braking accumulator and GREEN system accumulator

One MS28889 - 1 connection for BLUE system accumulator
- C. Tank filling :
One 1/4 in. self sealing connection common to the 3 tanks
- D. Tank overflow :
One 3/8 in. self sealing connections (one per tank)
- YELLOW

- GREEN

- BLUE
- E. Ground test
Three 1 in. self sealing connections and three 1 - 1/2 in. self sealing connections (one pair per system)
- GREEN

- YELLOW

- BLUE

AFT OF NOSE	DISTANCE <u>Meters</u> (ft - in.)		MEAN HEIGHT FROM GROUND
	FROM AIRPLANE CENTERLINE		
	RH SIDE	LH SIDE	
20.22 (66-4)		3.95 (12-11)	3.50 (11-6)
23.36 (76-8)	1.88 (6-2)		2.84 (9-4)
23.36 (76-8)	1.55 (5-1)		2.84 (9-4)
19.98 (65-7)		3.20 (10-6)	3.65 (12-0)
22.73 (74-7)		2.10 (6-11)	2.94 (9-8)
20.22 (66-4)	3.95 (12-11)		3.50 (11-6)
22.73 (74-7)		2.10 (6-11)	2.94 (9-8)
20.22 (66-4)		3.95 (12-11)	3.50 (11-6)
20.22 (66-4)	3.95 (12-11)		3.50 (11-6)
22.73 (74-7)		2.10 (6-11)	2.94 (9-8)
20.22 (66-4)		3.95 (12-11)	3.50 (11-6)

5.4 GROUND SERVICE CONNECTIONS
5.4.3 HYDRAULIC SYSTEM



AIRPLANE CHARACTERISTICS FOR AIRPORT PLANNING

ELECTRICAL SYSTEM

One standard 6 pin connector
ISO R 461 specification

DISTANCE		Meters (ft - in.)	MEAN HEIGHT FROM GROUND
AFT OF NOSE	AIRPLANE CENTERLINE		
7.28 (23-11)			2.00 (6-7)

Supply:
115/200 Volt, 3-Phase, 400 Hz
Power required: 90 KVA

R Electrical Connectors for Servicing

R Note: For mating connectors contact HUBBEL (FSCM 7H582)

5.4 GROUND SERVICE CONNECTIONS 5.4.4 ELECTRICAL SYSTEM

OXYGEN SYSTEM

NOTE : Internal charging connection provided.

DISTANCE $\frac{\text{Meters}}{\text{(ft - in.)}}$			MEAN HEIGHT FROM GROUND
AFT OF NOSE	FROM AIRPLANE CENTERLINE		
	RH SIDE	LH SIDE	
7.81 (25-8)	2.50 (8-2)		3.60 (11-10)

One service connection
(external charging) 3/8 in.
UNF x 24 TPI
as Option.

Printed in France

FUEL SYSTEM

AFT OF NOSE	DISTANCE <u>Meters</u> (ft - in.)		MEAN HEIGHT FROM GROUND
	FROM AIRPLANE CENTERLINE		
	RH SIDE	LH SIDE	
Two standard 2½ in. connections - ISO R45 Specification	20.50 (67-3)	10.50 (34-7)	4.50 (14-8)
(LH SIDE : OPTION)	20.50 (67-3)	10.50 (34-7)	4.50 (14-8)
Two service connections (gravity feed)	21.50 (70-6)	11.00 (36-0)	4.70 (15-5)
Two service connections (gravity feed)	26.00 (85-4)	19.00 (62-4)	5.05 (16-7)

Flow Rate :
 1475 l/mn (325 Imp. gal/mn) (390 U.S. gal/mn) per connection
 Maximum Pressure :
 50 psig (3.45 bars)

Printed in France

PNEUMATIC SYSTEM

Two standard 3 in. ISO TC20 connections for engine starting and cabin air conditioning.

One standard 8 in. connection (MS33562) for pre-conditioned air.

DISTANCE <u>Meters</u> (ft - in.)			MEAN HEIGHT FROM GROUND
AFT OF NOSE	FROM AIRPLANE CENTERLINE		
	RH SIDE	LH SIDE	
16.45 (54-0)			1.89 (6-2)
16.99 (55-9)			1.89 (6-2)
15.23 (50-0)		0.82 (2-8)	2.27 (7-5)

Printed in France



AIRPLANE CHARACTERISTICS FOR AIRPORT PLANNING

POTABLE WATER SYSTEM

One service panel comprising :

- One standard 3/4 in. quick release filling connection
- One 3/4 in. standard overflow and discharge connection
- One ground pressurization connection

Our standard 3/4 in. quick release filling connection and overflow connection

One draining connection with back-up mechanical control

AFT OF NOSE	Meters		MEAN HEIGHT FROM GROUND
	DISTANCE (ft - in.)		
	FROM AIRPLANE CENTERLINE		
	RH SIDE	LH SIDE	
15.50 (50-10)	1.13 (3-9)		2.48 (8-2)
15.50 (50-10)	1.13 (3-9)		2.48 (8-2)
24.25 (79-7)		1.20 (4-0)	2.20 (7-3)

R Usable capacity : 2 tanks

R - 200 liters (44 Imp.gal) (53 US gal) each

Fill rate :

- Flow : 91 l/mn (20 Imp.gal/mn) (24 US gal/mn)

R - Pressure : 50 psig (3.45 bar)

5.4 Ground Service Connections
5.4.8 Potable Water System



AIRPLANE CHARACTERISTICS FOR AIRPORT PLANNING

OIL SYSTEM

- A. Engine oil replenishment :
One gravity filling cap and
one pressure filling connection per engine

DISTANCE Meters (ft - in.)			MEAN HEIGHT FROM GROUND
AFT OF NOSE	FROM AIRPLANE CENTERLINE		
	RH SIDE	LH SIDE	
17.11 (56-2)	8.80 (28.11)	7.00 (22-11)	1.40 (4-7)

- R Delivery pressure required : 25 psig (1.72 bar)

Tank capacity :

- Full level : 6 US GAL (22.71 liters)
- Usable : 3 US GAL 4.5 US GAL (17.03 liters)

- B. IDG oil replenishment :
One pressure filling connection per engine and one
gravity filling port

16.55 (54-4)	9.00 (29.6)	6.80 (22-4)	1.00 (3-3)
-----------------	----------------	----------------	---------------

- R Delivery pressure required : 25 psig (1.72 bar)

Tank capacity : 2.12 US GAL (8.04 liters)

5.4 GROUND SERVICE CONNECTIONS
5.4.9 ENGINE AND IDG OIL SYSTEM
MODEL 200 (GE CF6-80A3 Engine)

Chapter 5.4.9
Page 1
Nov 94



AIRPLANE CHARACTERISTICS FOR AIRPORT PLANNING

OIL SYSTEM

A. Engine oil replenishment :
 One gravity filling cap and
 one pressure filling connec-
 tion per engine

DISTANCE Meters (ft - in.)			MEAN HEIGHT FROM GROUND
AFT OF NOSE	FROM AIRPLANE CENTERLINE		
	RH SIDE	LH SIDE	
18.01 (59-1)	8.80 (28.11)	7.00 (22-11)	2.00 (6-7)

R Delivery pressure required : 25 psig (1.72 bar)

Tank capacity :
 - Full level : 7.7 US GAL (29.15 liters)
 - Usable : 4.25 US GAL (16.08 liters)

B. IDG oil replenishment :
 One pressure filling connec-
 tion per engine and one
 gravity filling port

16.55 (54-4)	9.00 (29.6)	6.80 (22-4)	1.00 (3-3)
-----------------	----------------	----------------	---------------

R Delivery pressure required : 25 psig (1.72 bar)

Tank capacity : 1.2 US GAL (4.54 liters)

5.4 GROUND SERVICE CONNECTIONS
 5.4.9 ENGINE AND IDG OIL SYSTEM
 MODEL 200 (PW JT9D-7R4 Engine)

Chapter 5.4.9
 Page 2
 Nov 94

OIL SYSTEM

A. Engine oil replenishment :
One gravity filling cap and
one pressure filling connec-
tion per engine

DISTANCE Meters (ft - in.)			MEAN HEIGHT FROM GROUND
AFT OF NOSE	FROM AIRPLANE CENTERLINE		
	RH SIDE	LH SIDE	
17.11 (56-2)	8.80 (28.11)	7.00 (22-11)	1.40 (4-7)

R Delivery pressure required : 25 psig (1.72 bar)

Tank capacity :
- Full level : 6.7 US GAL (25.36 liters)
- Usable : 3.2 US GAL (12.11 liters)

B. IDG oil replenishment :
One pressure filling connec-
tion per engine and one
gravity filling port

16.55 (54-4)	9.00 (29.6)	6.80 (22-4)	1.00 (3-3)
-----------------	----------------	----------------	---------------

R Delivery pressure required : 25 psig (1.72 bar)

Tank capacity : 2.12 US GAL (8.04 liters)

AIRPLANE CHARACTERISTICS FOR AIRPORT PLANNING

TOILET SYSTEM

Service panel comprising :
 One standard 4 in. drain connection
 and two 1 in. flushing connections

 One 1 in. flushing connection

DISTANCE		Meters		MEAN HEIGHT FROM GROUND
		(ft - in.)		
AFT OF NOSE	FROM AIRPLANE CENTERLINE			
	RH SIDE	LH SIDE		
4.40 (14-5)		1.71 (5-7)	3.28 (10-9)	
36.03 (118-0)	0.64 (2-1)		4.26 (13-10)	

R Capacity 2 tanks:

R - Waste : 265 liters (58.2 Imp.gal) (70 US gal) each

R - Chemical fluid : 9.5 liters (2.1 Imp.gal) (2.5 US gal)

5.4 Ground Service Connections
 5.4.10 Toilet System

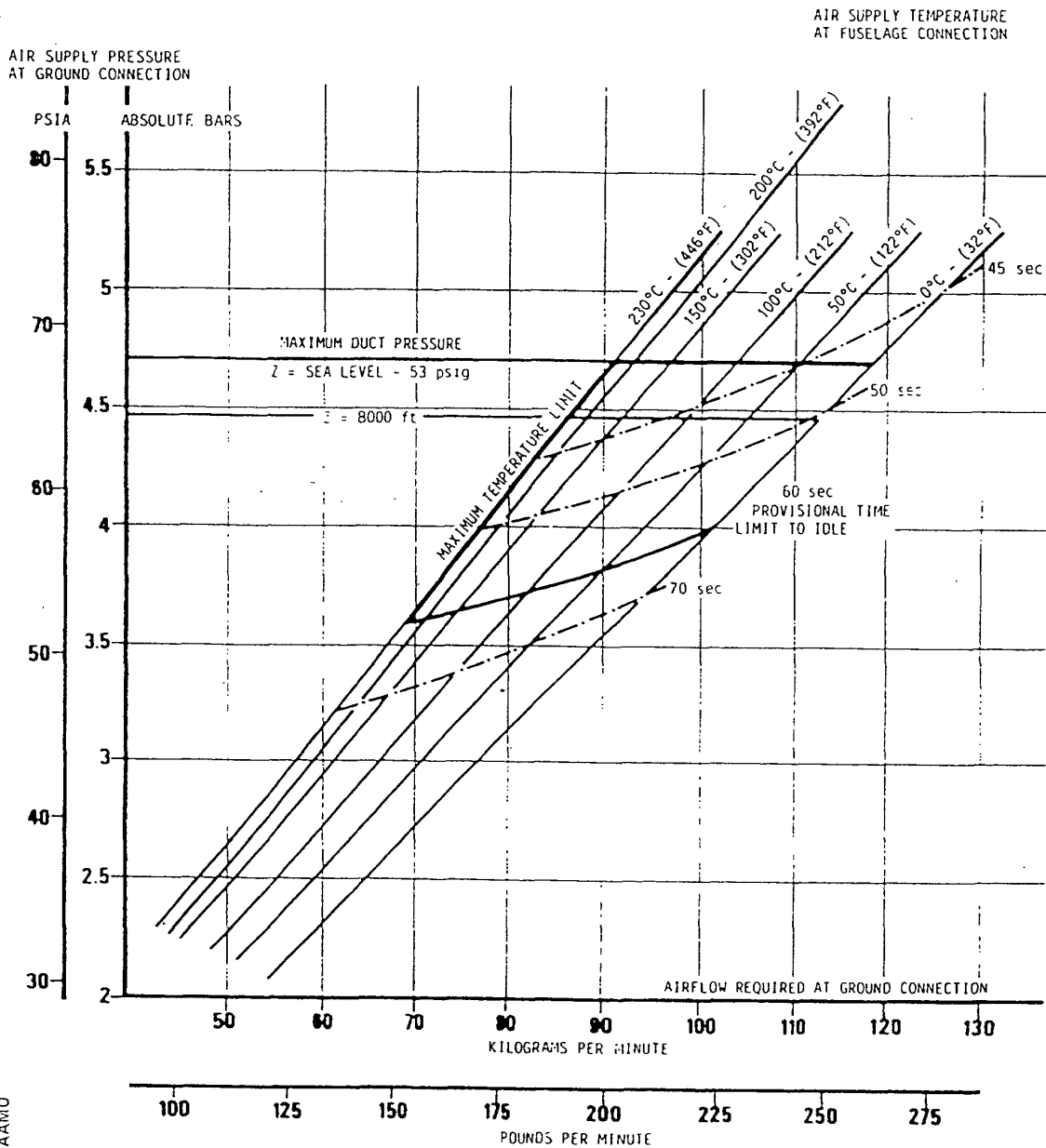

BAS 05 05 01 AAWO

0 TO 8000 ft. ALT
TEMP. AMBIENT : ISA - 40°C (-40°F)

5.5 ENGINE STARTING PNEUMATIC REQUIREMENTS
5.5.1 AMBIENT TEMPERATURE - 40°C (-40°F)
GE CF6 80A3 ENGINE



AIRPLANE CHARACTERISTICS FOR AIRPORT PLANNING

AIR SUPPLY PRESSURE
AT GROUND CONNECTION

PSIA, ABSOLUTE BARS

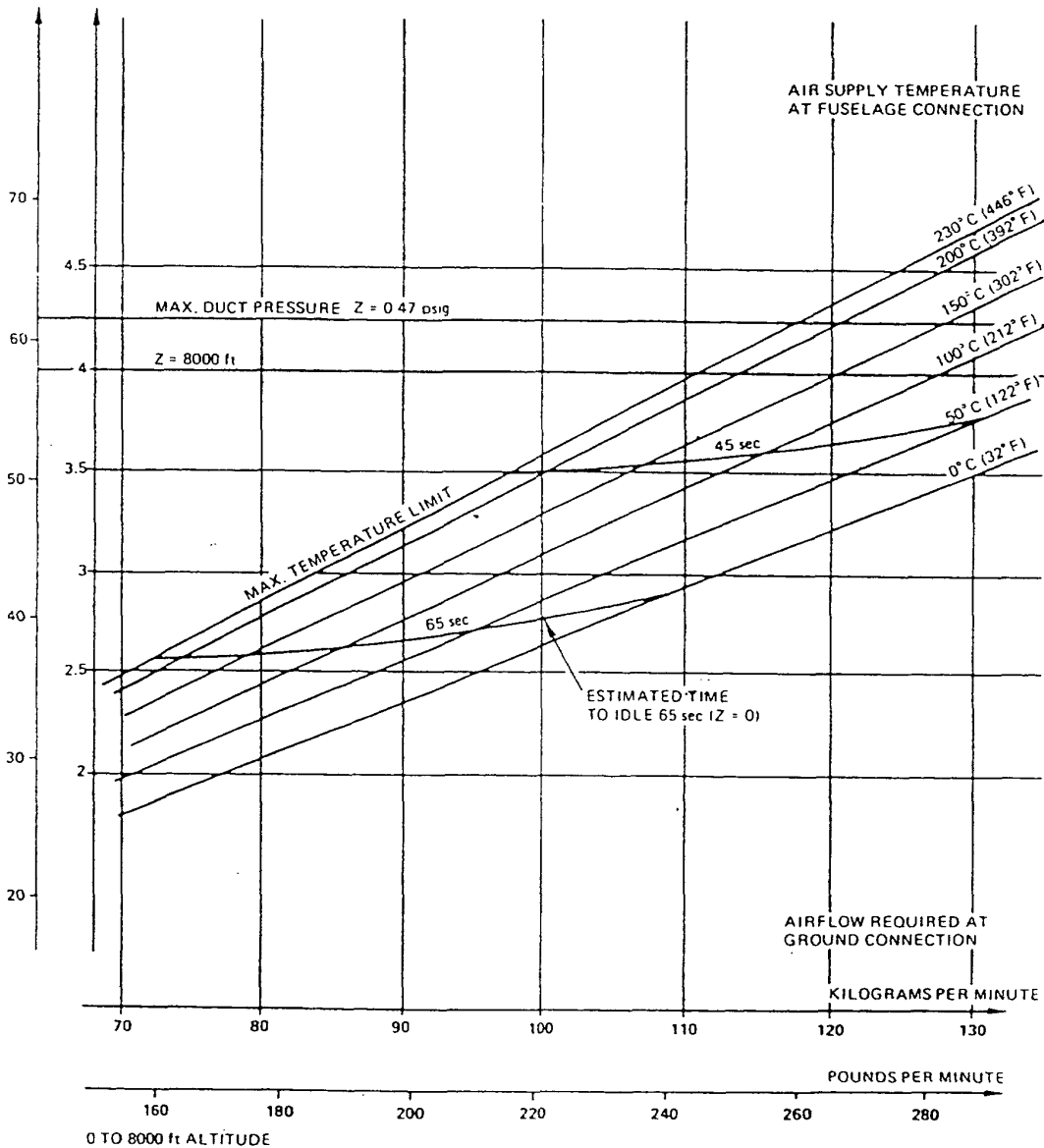

BA5 05 05 03 ACMO

5.5 ENGINE STARTING PNEUMATIC REQUIREMENTS 5.5.1 AMBIENT TEMPERATURE : - 40 °C (- 40°F) PW JT9D 7R4 AND PW 4000 ENGINE

Chapter 5.5.1
Page 2
Aug 88

R

Printed in France



AIRPLANE CHARACTERISTICS FOR AIRPORT PLANNING

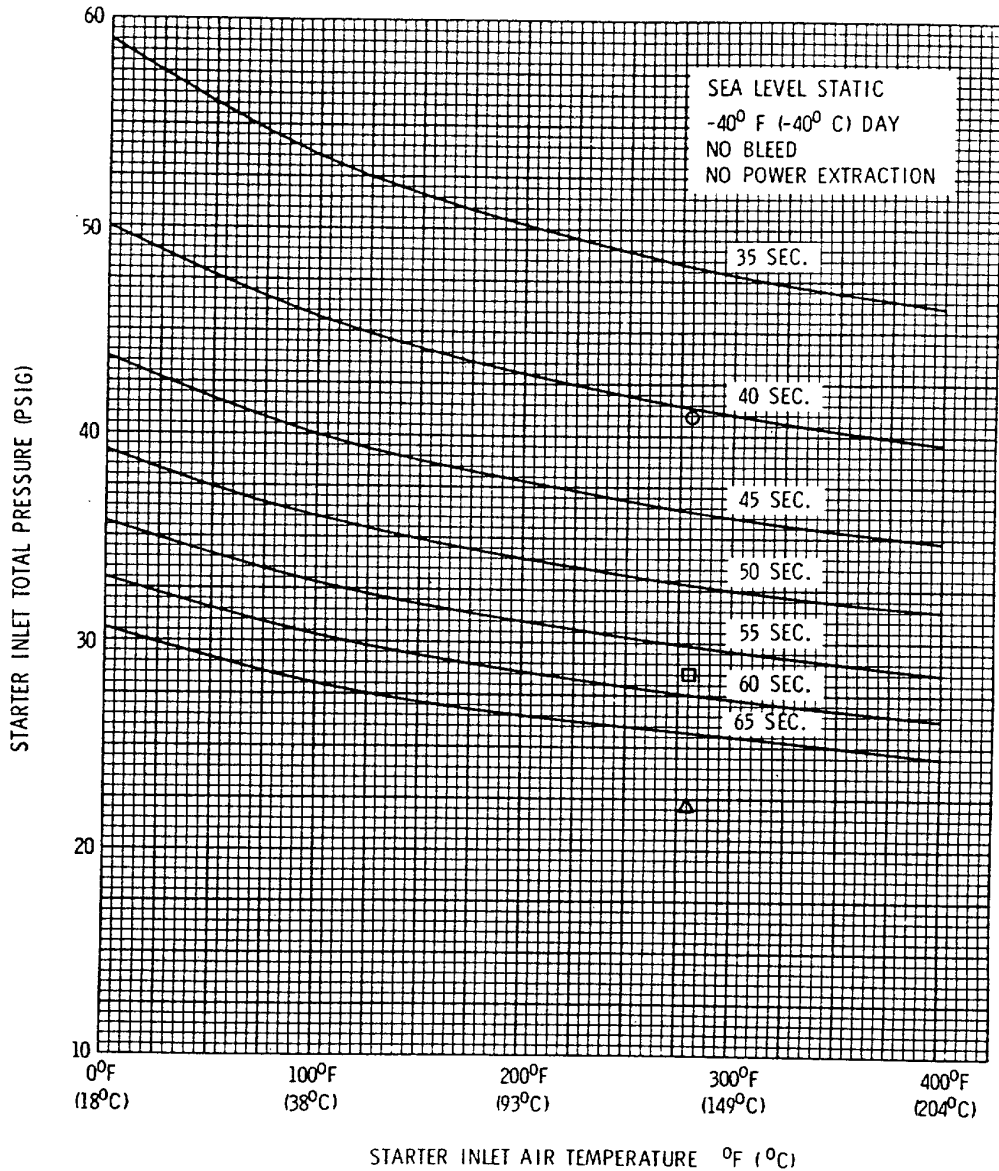

BA5 05 05 01 0 AEMO

CF8-8126-00-AZA

5.5 ENGINE STARTING PNEUMATIC REQUIREMENTS
5.5.1 AMBIENT TEMPERATURE : -40°C (-40°F)
GE-CF6-80C2 ENGINE

Chapter 5.5.1
Page 3
Oct 87

Printed in France

N

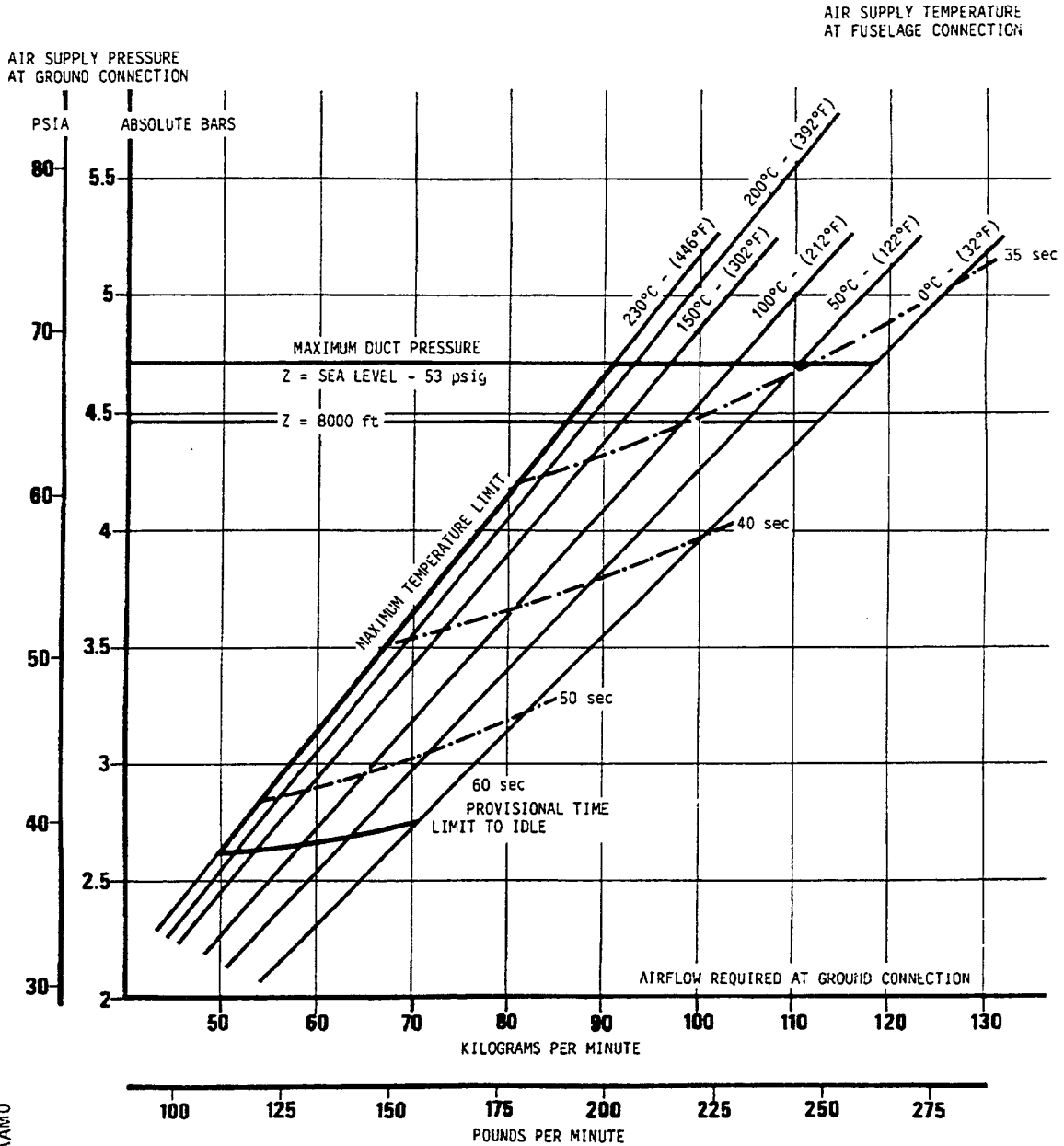

BA5 05 05 02 AAM0

0 TO 8000 ft. ALT
TEMP. AMBIENT : ISA + 15°C (+ 60°F)

5.5 ENGINE STARTING PNEUMATIC REQUIREMENTS
5.5.2 AMBIENT TEMPERATURE + 15°C (+ 60°F)

GE CF6 80A3 ENGINE



AIRPLANE CHARACTERISTICS FOR AIRPORT PLANNING

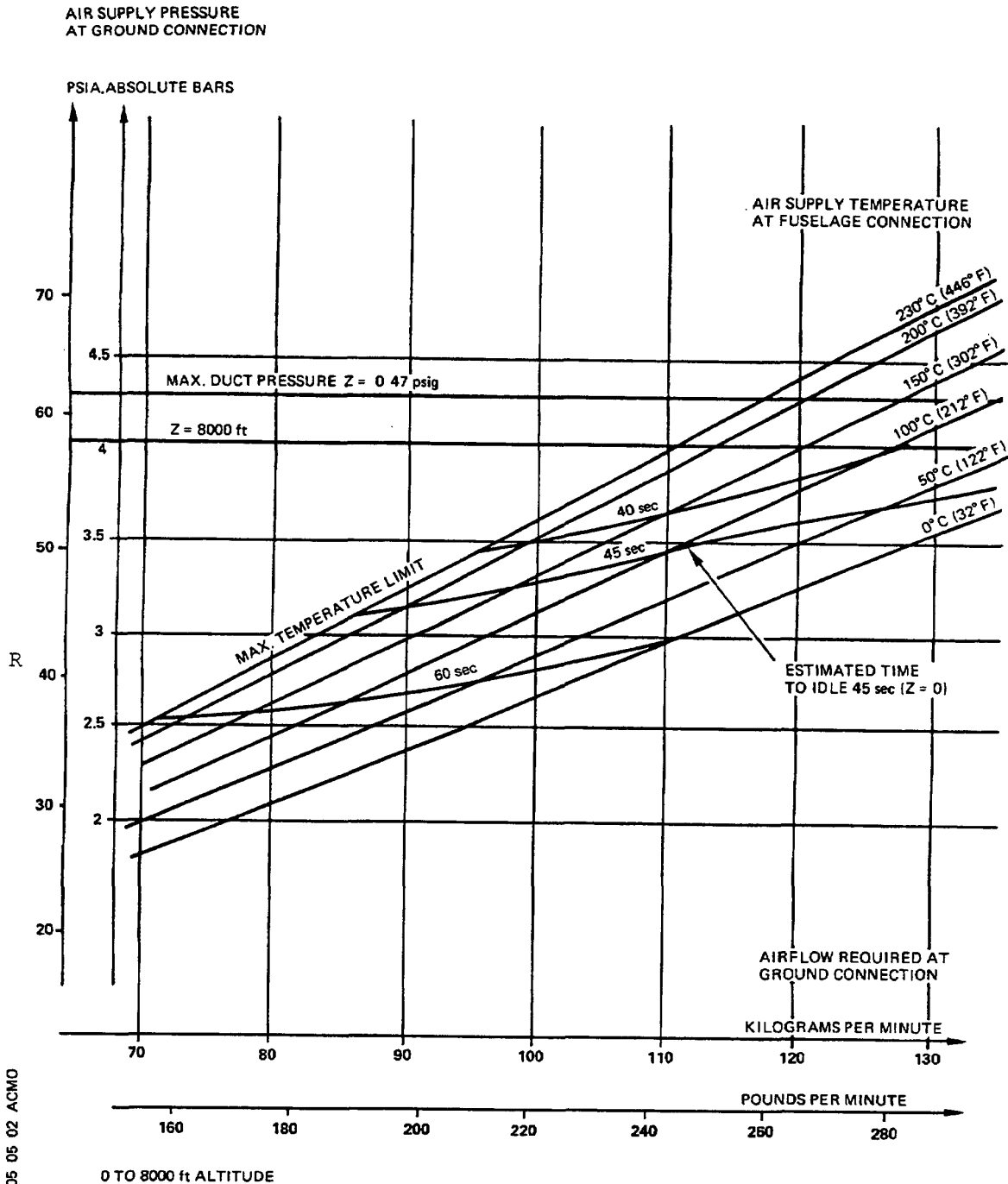

BAS 05 05 02 ACMO

0 TO 8000 ft ALTITUDE

5.5 ENGINE STARTING PNEUMATIC REQUIREMENTS
5.5.2 AMBIENT TEMPERATURE : +15°C (+60°F)
PW JT9D 7R4 AND PW4000 ENGINE

Chapter 5.5.2
Page 2
May 01/98



AIRPLANE CHARACTERISTICS FOR AIRPORT PLANNING

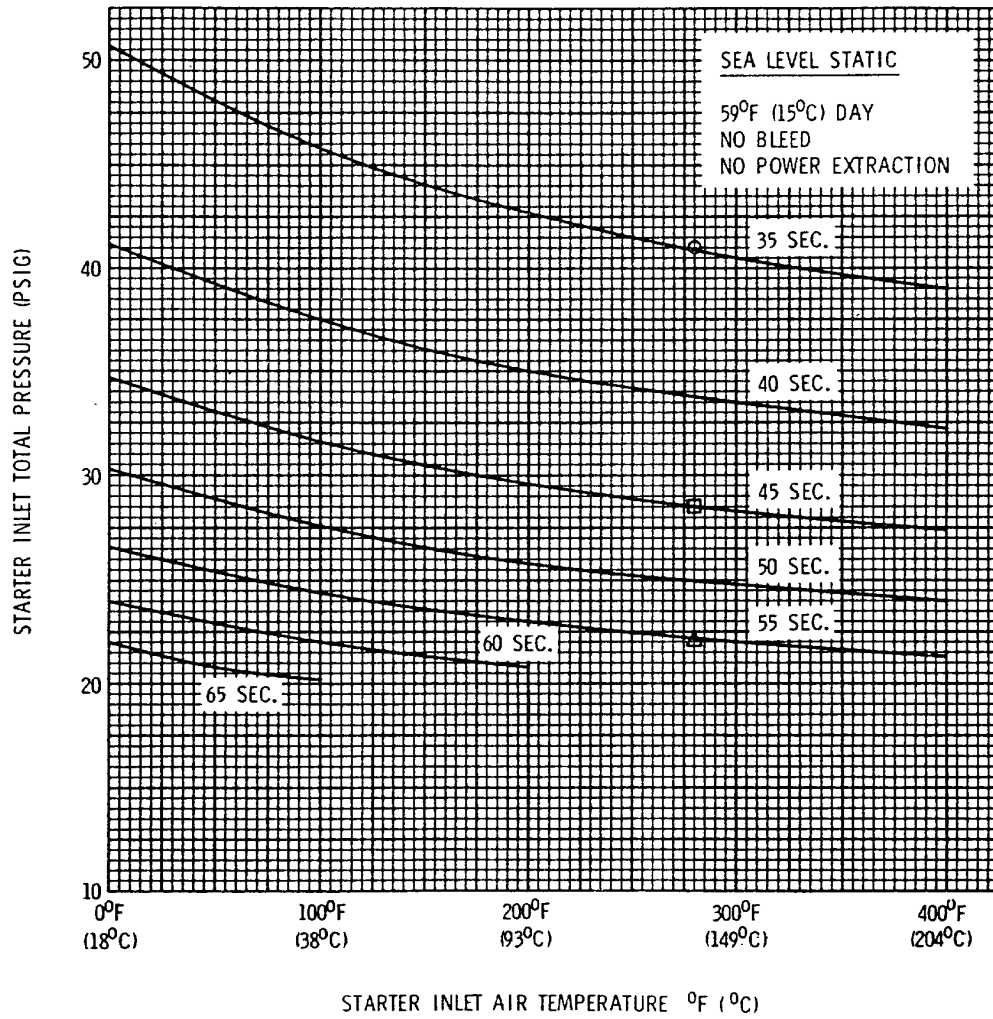

BA5 05 05 020 AEMO

CF8-8127-00-A2A

5.5 ENGINE STARTING PNEUMATIC REQUIREMENTS
5.5.2 AMBIENT TEMPERATURE : +15°C (+60°F)
GE-CF6-80C2 ENGINE

Chapter 5.5.2
Page 3
Oct 87

Printed in France

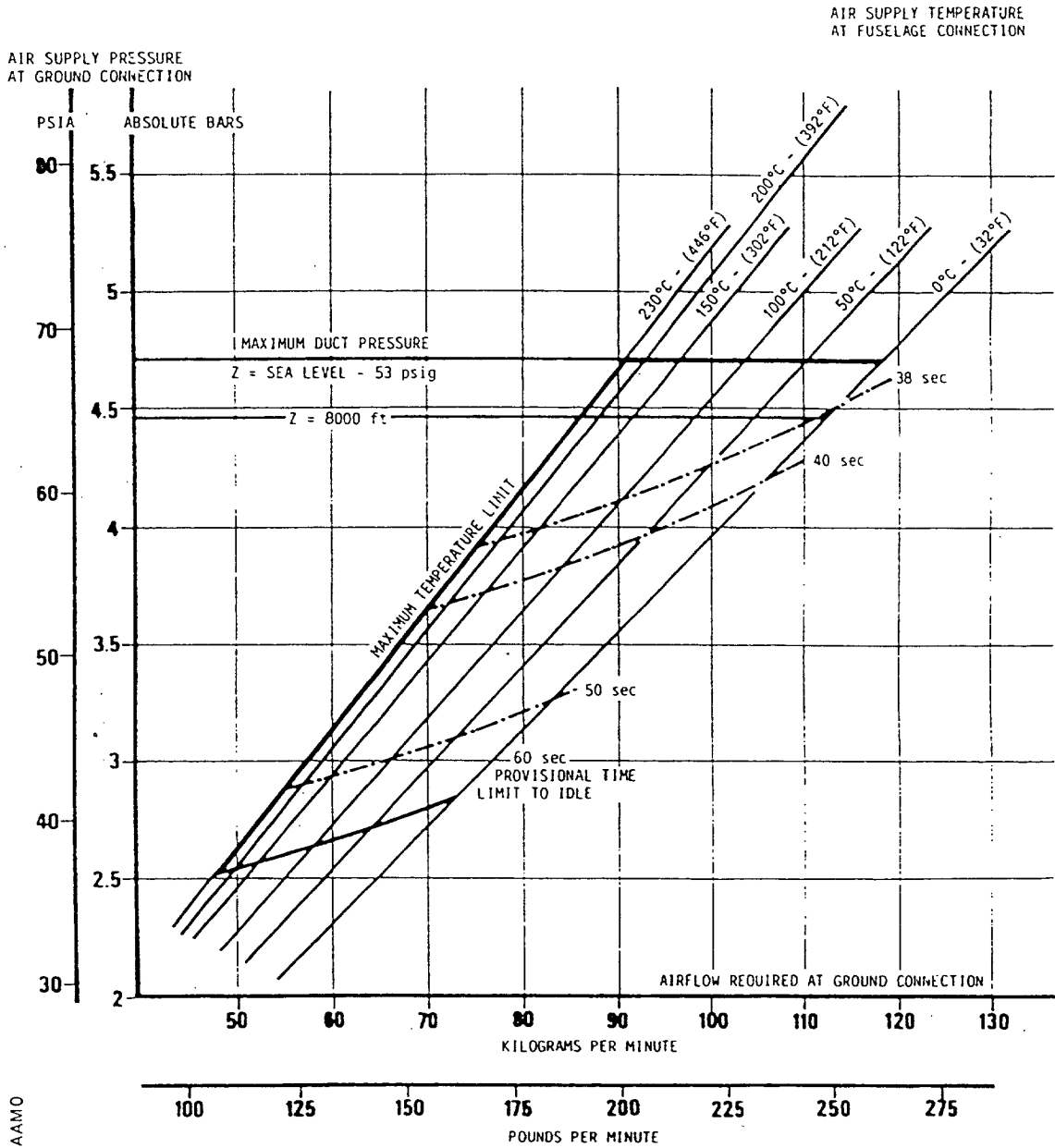

BA5 05 05 03 AAMO

0 TO 8000 ft. ALT
TEMP. AMBIENT : ISA + 37.8°C (+100°F)

5.5 ENGINE STARTING PNEUMATIC REQUIREMENTS
5.5.3 AMBIENT TEMPERATURE + 37.8°C (+ 100°F)
GE CF6 80A3 ENGINE



AIRPLANE CHARACTERISTICS FOR AIRPORT PLANNING

AIR SUPPLY PRESSURE
AT GROUND CONNECTION

PSIA, ABSOLUTE BARS

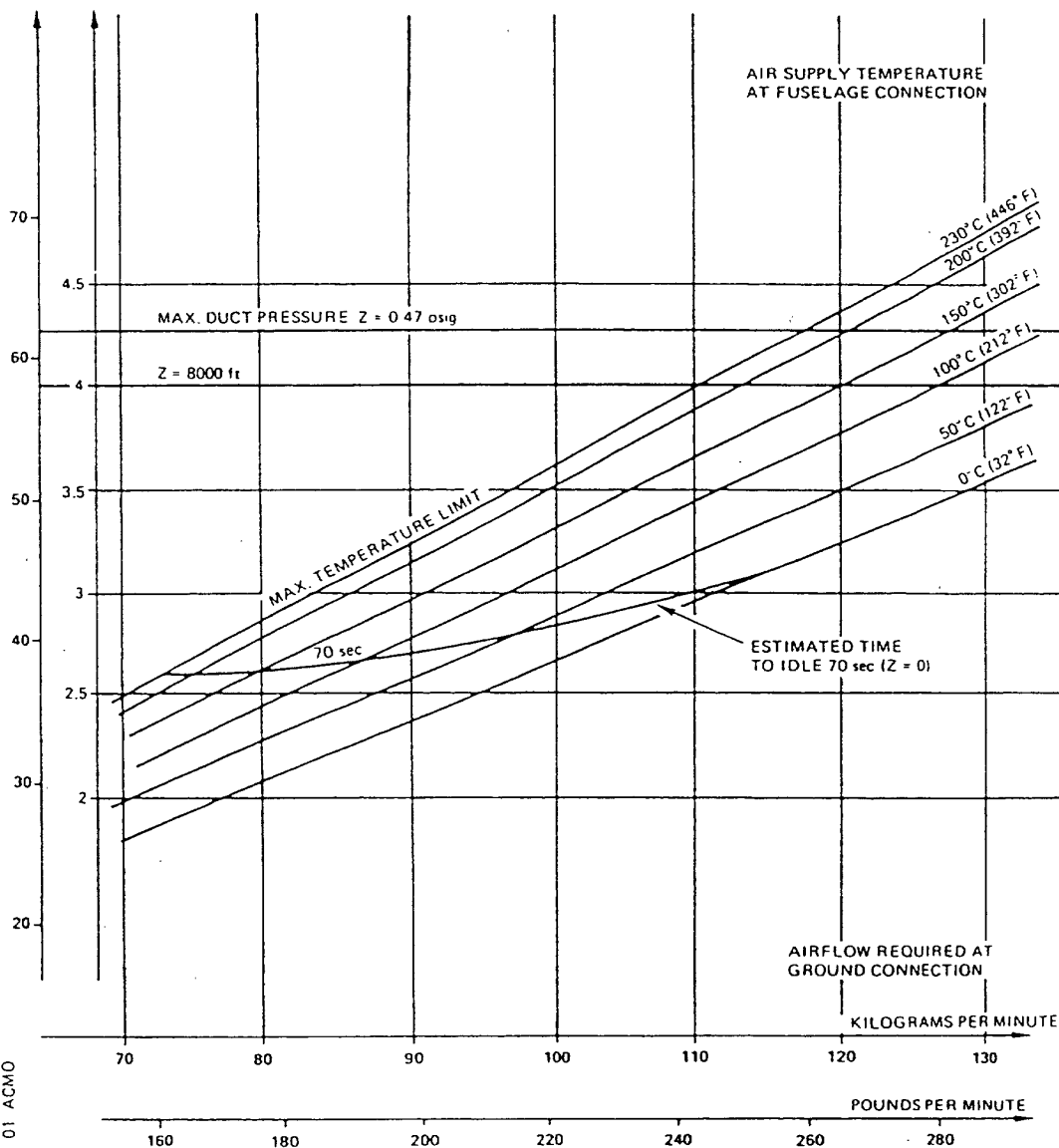

BA5 05 01 ACMO

0 TO 8000 ft ALTITUDE

5.5 ENGINE STARTING PNEUMATIC REQUIREMENTS

5.5.3 AMBIENT TEMPERATURE : + 40 °C (+104°F)

PW JT9D 7R4 AND PW4000 ENGINE

Chapter 5.5.3
Page 2
Aug 88

R

Printed in france



AIRPLANE CHARACTERISTICS FOR AIRPORT PLANNING

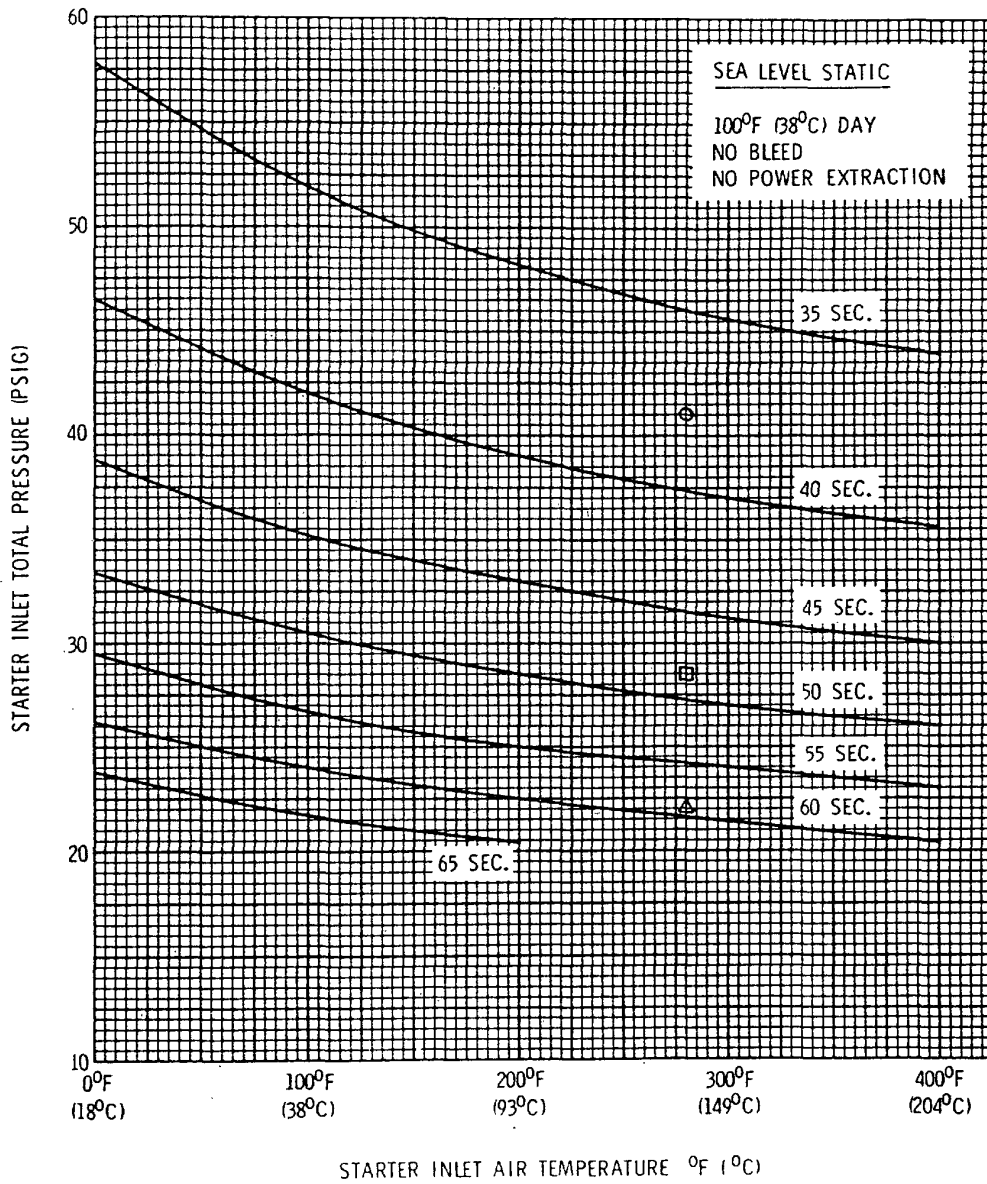

BA5 05 05 03 0 AEMD

CF8-8128-00-A2A

5.5 ENGINE STARTING PNEUMATIC REQUIREMENTS
5.5.3 AMBIENT TEMPERATURE : +38°C (+100°F)
GE-CF6-80C2 ENGINE

Chapter 5.5.3
Page 3
Oct 87

N

Printed in France

8A5 05 06 01 AAM0

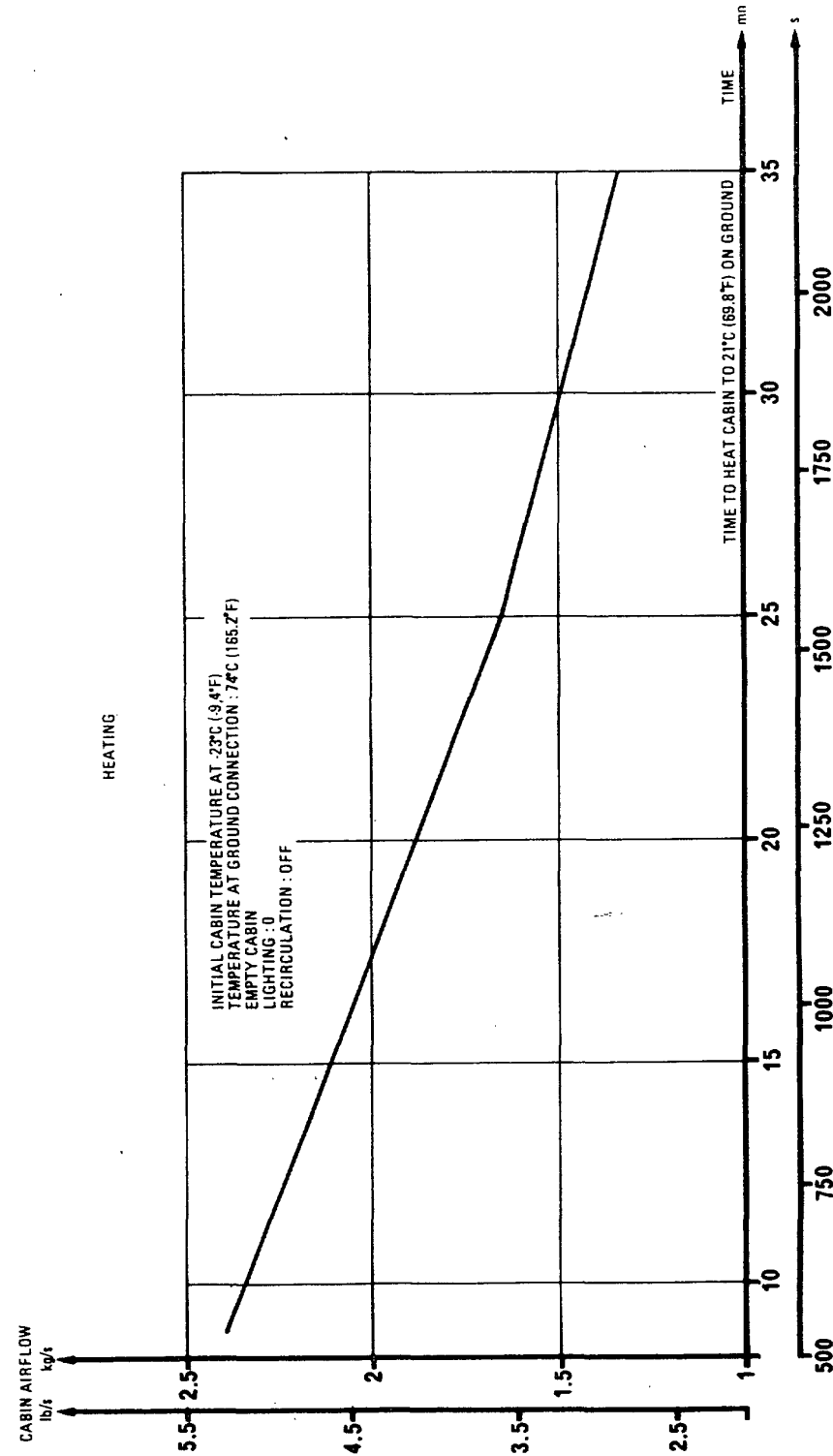

R 5.6 GROUND PNEUMATIC POWER REQUIREMENTS
5.6.1 HEATING

Printed in France

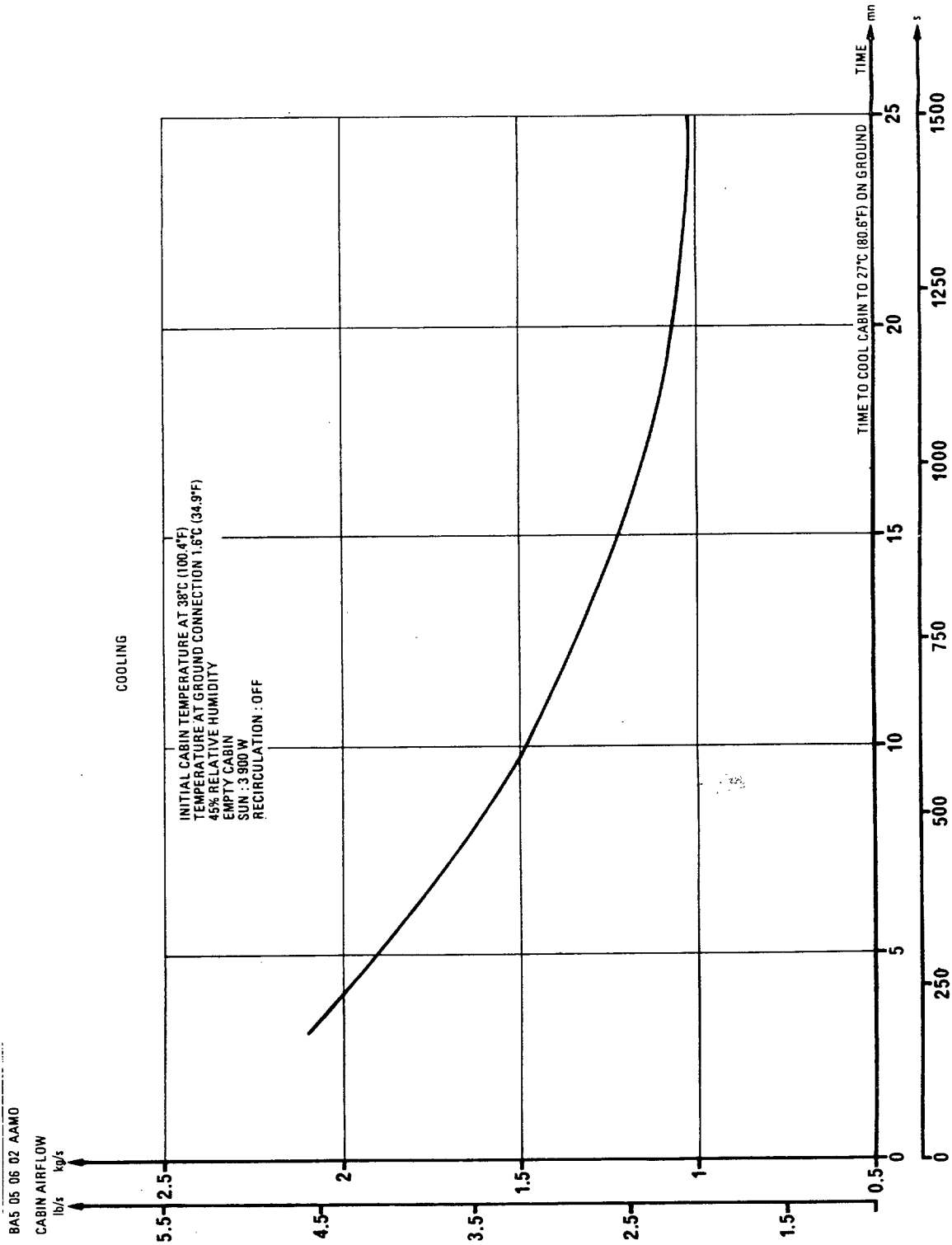

5.6 GROUND PNEUMATIC POWER REQUIREMENTS
 5.6.2 COOLING

R

Printed in France

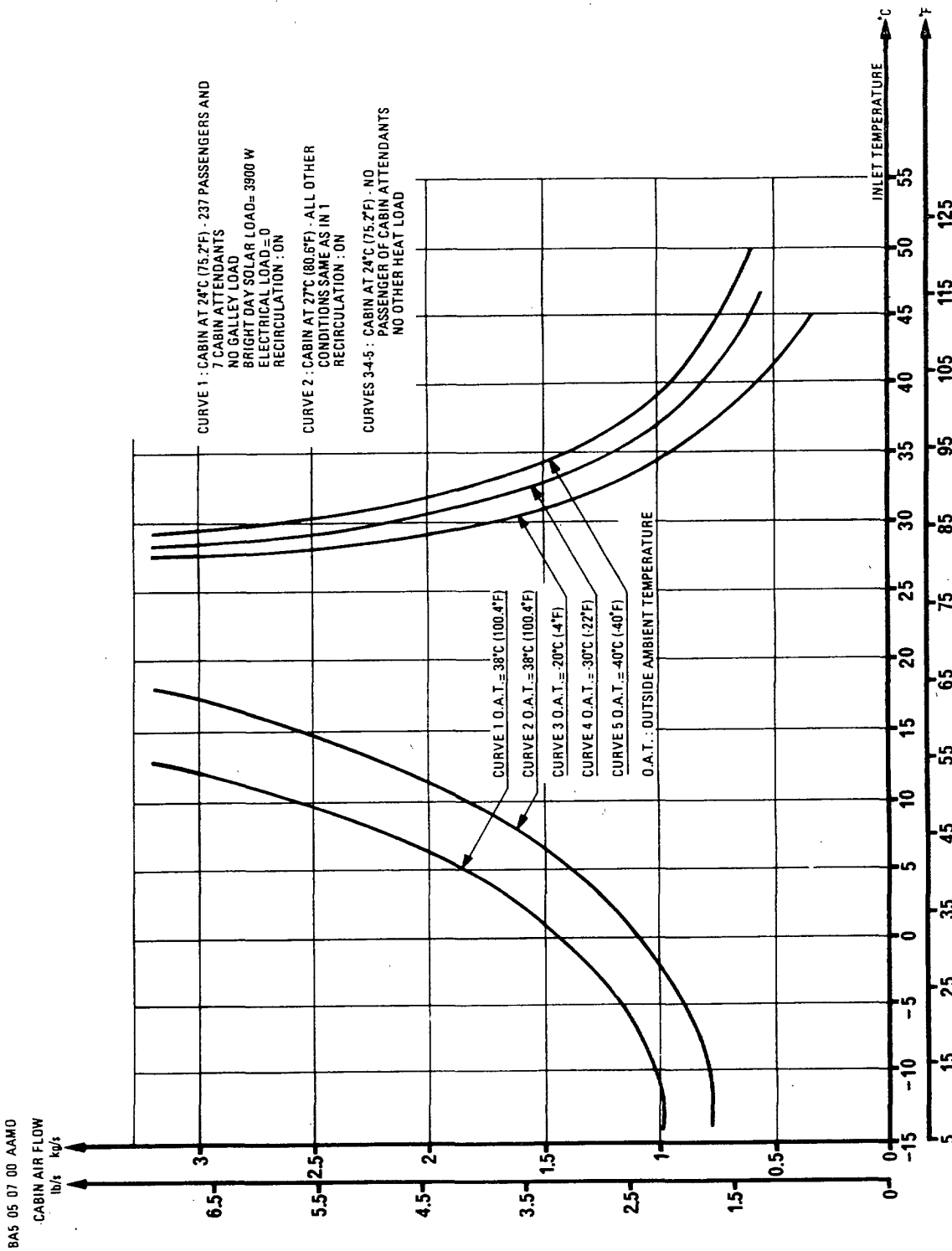

5.7 PRECONDITIONED AIRFLOW REQUIREMENTS

R



AIRPLANE CHARACTERISTICS FOR AIRPORT PLANNING

5-8 Ground Towing Requirements

This section provides information on aircraft Towing.

The A310 is designed with means for conventional towing or towbarless towing. Information on towbar less towing can be found in SIL 09-002 and chapter 9 of the Aircraft Maintenance Manual.

1. Ground Towing

It is possible to tow or push the aircraft, at maximum ramp weight with engines at zero or up to idle thrust, using a towbar attached to the nose gear leg. Two towbar fittings are installed, one at the front of the leg and one at the back.

The body gears have attachment points for towing or debogging (for details refer to chapter 7 of the Aircraft Recovery Manual).

A. The first part of this section shows the chart to determine the draw bar pull and tow tractor mass requirements as function of the following physical characteristics :

- Aircraft weight
- Slope
- Number of engines at idle

The chart is based on the A310 engine type with the biggest idle thrust.

The chart is therefore valid for all A310 models.

B. The second part of this section supplies guidelines for the towbar.

NOTE : Information on aircraft towing procedures and corresponding aircraft limitations are given in chapter 9 of the Aircraft Maintenance Manual.

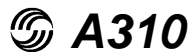

AIRPLANE CHARACTERISTICS FOR AIRPORT PLANNING

NOTE: UNUSUAL BREAKAWAY CONDITIONS NOT REFLECTED.
ESTIMATED FOR RUBBER TIRED TOW VEHICLES.
COEFFICIENTS OF FRICTION (μ) APPROXIMATE.

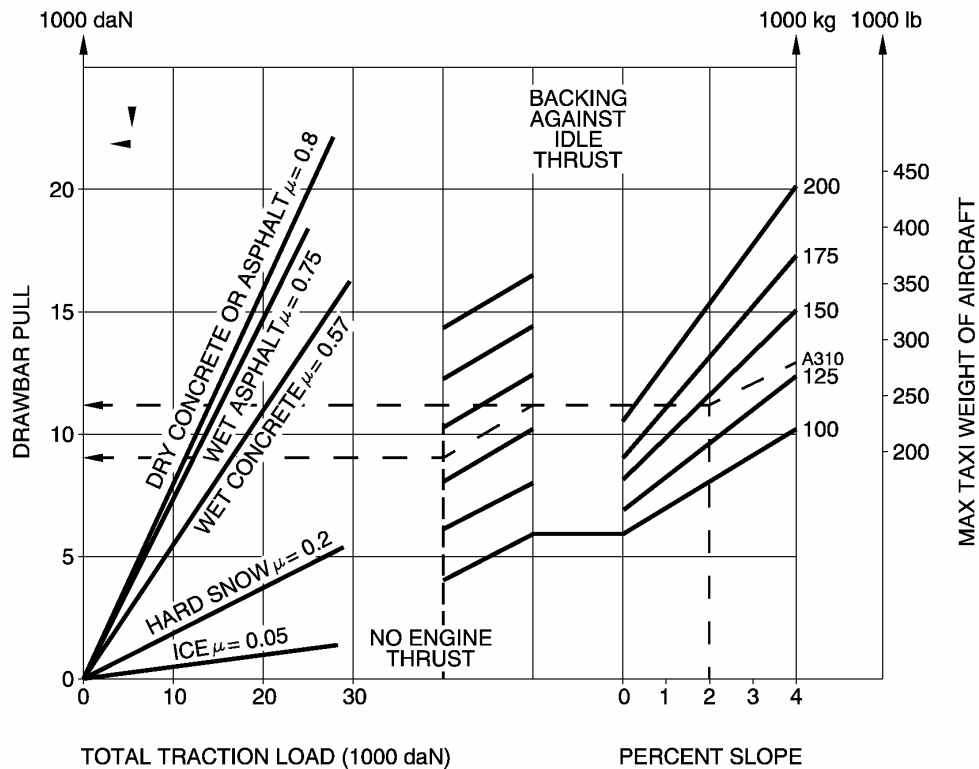

IN EXAMPLE A: THE GRAPH REPRESENTS AN A310 AIRPLANE WEIGHING 132900 kg (293000 lb) BEING PUSHED REARWARD ON WET CONCRETE UP A 2% SLOPE, WITH ENGINES IDLING.

SUCH CONDITIONS REQUIRE A 11000 daN (24700 lbf) DRAWBAR PULL AND A MINIMUM 19000 daN (42700 lbf) LOAD ON THE TRACTION WHEELS.

IN EXAMPLE B: THE GRAPH REPRESENTS AN A310 AIRPLANE WEIGHING 132900 kg (293000 lb) BEING PULLED FORWARD ON WET CONCRETE UP A 2% SLOPE, WITH ENGINES STOPPED.

SUCH CONDITIONS REQUIRE A 9000 daN (20200 lbf) DRAWBAR PULL AND A MINIMUM 15000 daN (33700 lbf) LOAD ON THE TRACTION WHEELS.

BA5 05 08 00 5 A-AM0 00

Ground Towing Requirements

Chapter 5.8
Page 2
DEC 01/09

N

Printed in France

AIRPLANE CHARACTERISTICS FOR AIRPORT PLANNING

2. Towbar design guidelines

The aircraft towbar shall respect the following norms :

- SAE AS 1614, "Main Line Aircraft Tow Bar Attach Fitting Interface",
- SAE ARP1915 Revision C, "Aircraft Tow Bar",
- ISO 8267-1, "Aircraft - Tow bar attachment fitting - Interface requirements - Part 1 : Main line aircraft",
- ISO 9667, "Aircraft ground support equipment - Tow bars"
- IATA Airport Handling Manual AHM 958, "Functional Specification for an Aircraft Towbar"

A conventional type tow bar is required which should be equipped with a damping system to protect the nose gear against jerks and with towing shear pins :

- A traction shear pin calibrated at 14670 daN (33000 lbf),
- A torsion pin calibrated at 1750 m.daN (12907 lbf.in).

The towing head is designed according to SAE/AS 1614 (issue C) cat. II.

There is a variety of shear pin arrangements and the values of the shear pins depend on them. We hereafter show two arrangements classically used on towbars.

AIRPLANE CHARACTERISTICS FOR AIRPORT PLANNING

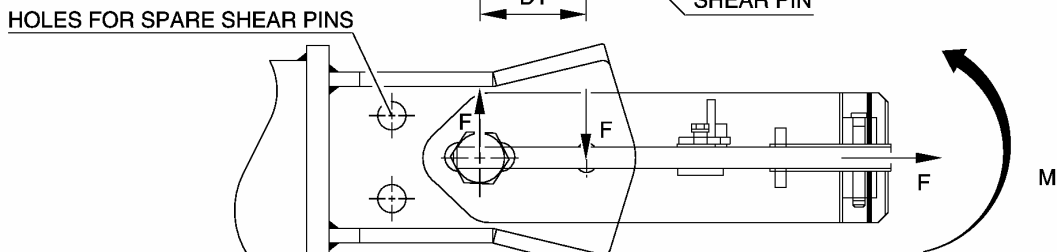
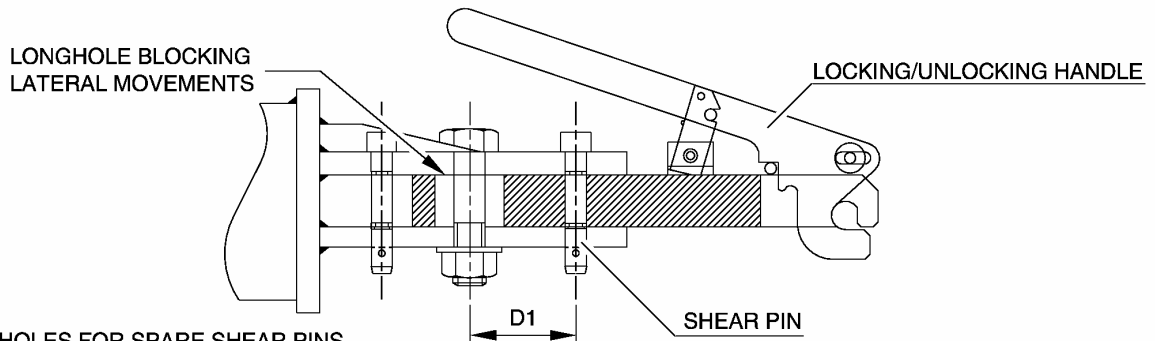
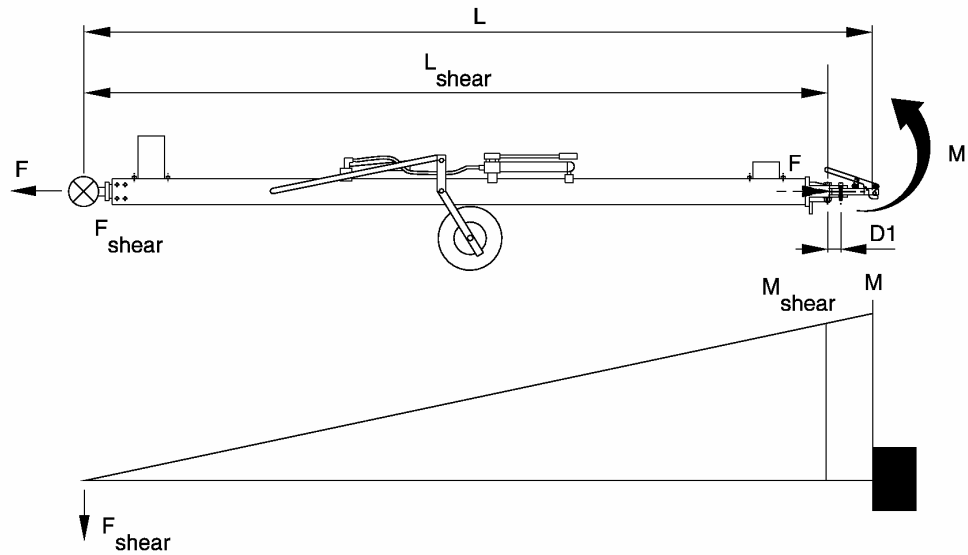

$$\begin{aligned}
 M &= F_{\text{shear}} \times L & \rightarrow & F_{\text{shear}} = M / L \\
 M_{\text{shear}} &= F_{\text{shear}} \times L_{\text{shear}} & \rightarrow & M_{\text{shear}} = (M/L) \times L_{\text{shear}} \\
 M_{\text{shear}} &= F \times D1 \quad (M_{\text{shear}} < M) & & \\
 D1 &= (M/L) \times L_{\text{shear}} / F & \rightarrow & D1 = (M \times L_{\text{shear}}) / (F \times L)
 \end{aligned}$$

BA5 05 08 01 5 AAM0 00

**Ground Towing Requirements
Typical Tow Bar Configuration 1**

AIRPLANE CHARACTERISTICS FOR AIRPORT PLANNING

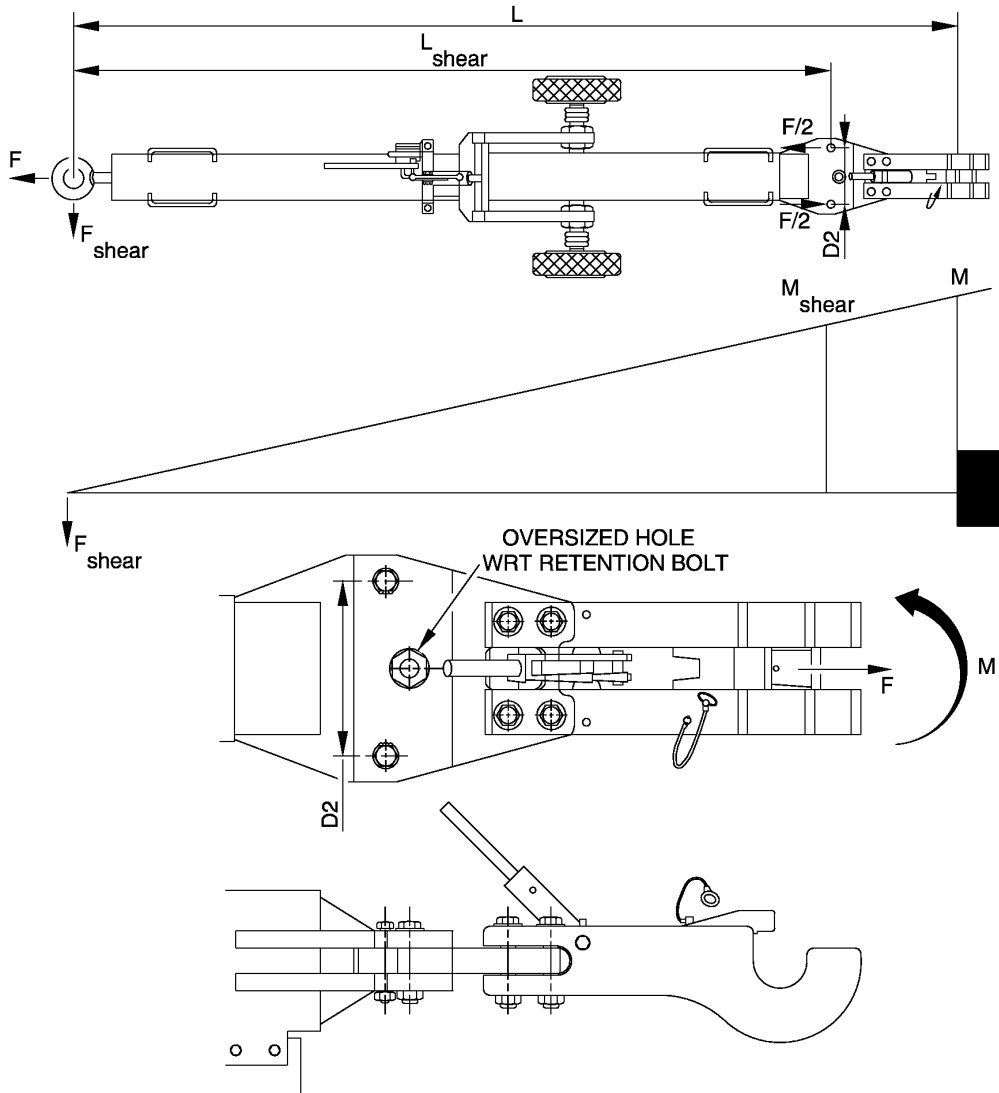

$$M = F_{\text{shear}} \times L \quad \rightarrow \quad F_{\text{shear}} = M / L$$

$$M_{\text{shear}} = F_{\text{shear}} \times L_{\text{shear}} \quad \rightarrow \quad M_{\text{shear}} = (M / L) \times L_{\text{shear}}$$

$$M_{\text{shear}} = F/2 \times D2 \quad (M_{\text{shear}} < M)$$

$$D2 = (2 \times M_{\text{shear}}) / F \quad \rightarrow \quad D2 = (2 \times M \times L_{\text{shear}}) / (F \times L)$$

F [daN]	M [m x daN]	D1 [mm]	D2 [mm]
14670	1750	104.2	222.2

RESULTS FOR A TOWBAR LENGTH OF $L_{\text{shear}}/L = 0.90$

BA5 05 08 01 5 AEM0 00

**Ground Towing Requirements
Typical Tow Bar Configuration 2**

AIRPLANE CHARACTERISTICS FOR AIRPORT PLANNING

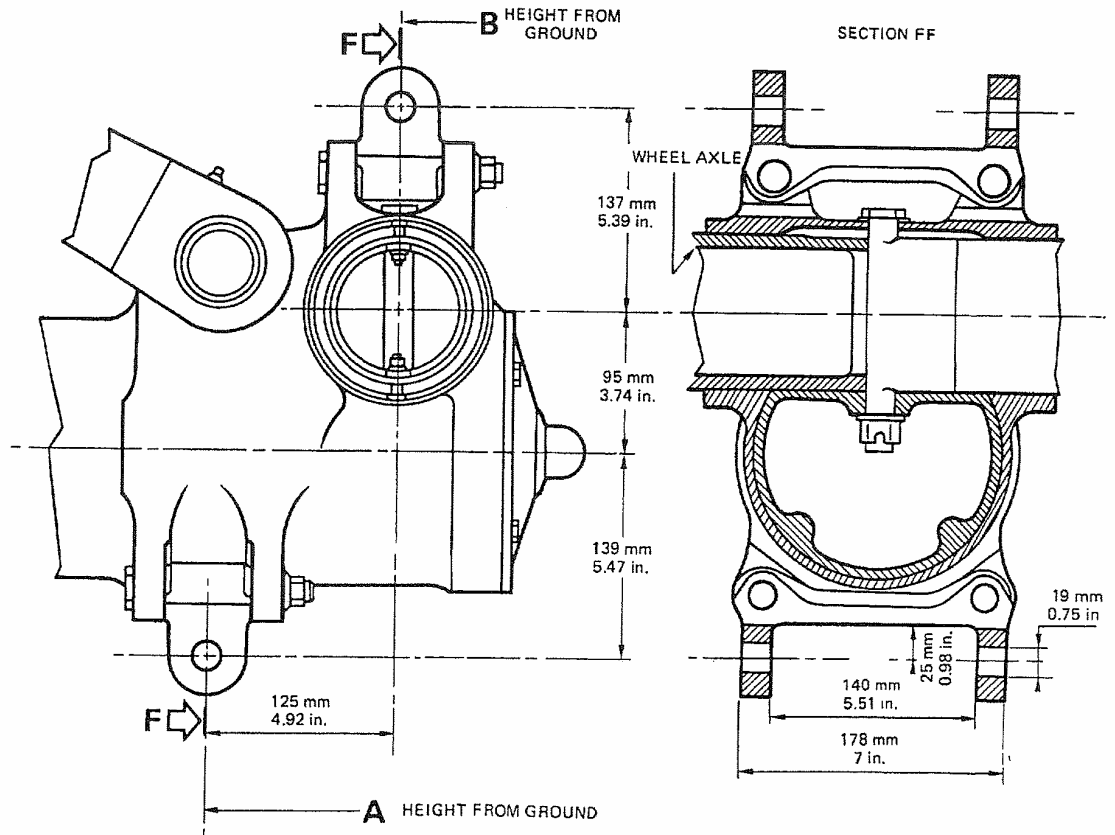

	HEIGHT FROM GROUND					
	OPERATING WEIGHT EMPTY		MAXIMUM RAMP WEIGHT			
	CG 25%		CG 18%		CG 34%	
	mm	in.	mm	in.	mm	in.
A	591	23.27	558	21.97	588	23.15
B	466	18.35	433	17.05	463	18.23

NOTE : DIMENSIONS IN THE TABLE ABOVE ARE APPROXIMATE AND WILL VARY TIRE TYPE AND CONDITIONS

CA5 05 08 00 5 ADM0 00

**Ground Towing Requirements
Nose Gear Towing Fittings**



AIRPLANE CHARACTERISTICS FOR AIRPORT PLANNING

- 6.0 OPERATING CONDITIONS
- 6.1 Jet Engine Exhaust Velocities and Temperatures
 - 6.1.1 Exhaust Velocity Contours - Breakaway Power
 - 6.1.2 Exhaust Temperature Contours - Breakaway Power
 - 6.1.3 Exhaust Velocity Contours - Take-off Power
 - 6.1.4 Exhaust Temperature Contours - Take-off Power
 - 6.1.5 Exhaust Velocity Contours - Idle Power
 - 6.1.6 Exhaust Temperature Contours - Idle Power
- 6.2 Airport and Community Noise
 - 6.2.1 Noise Data
- 6.3 Danger Areas of the Engines
 - 6.3.1 Danger Areas of the Engines - Ground Idle
 - 6.3.2 Danger Areas of the Engines - Take-off
 - 6.3.3 Danger Areas of the Engines - Acoustic Protection Areas

- R - Definition of Breakaway Power
- R Breakaway Power means the minimum power necessary for the aircraft to be able
- R to start moving.

Printed in France

BA5 06 01 01 AAMO

ALL VELOCITY VALUES ARE STATUTE MILES PER HOUR.
 NOTE : GROUND IDLE POWER - SEA LEVEL STATIC, ZERO WIND,
 STANDARD DAY, ZERO RAMP GRADIENT ENGINE TYPE.

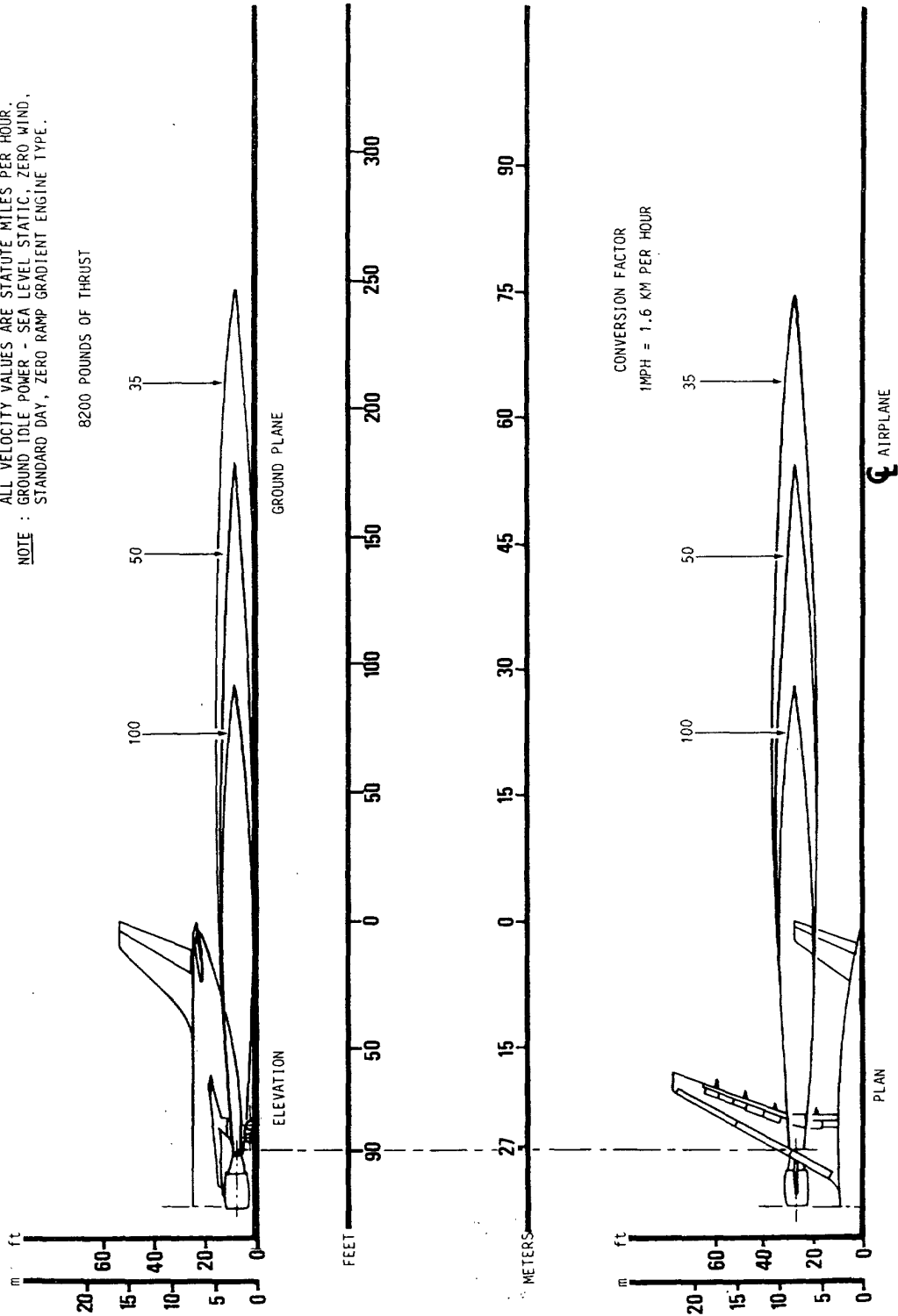

6.1 JET ENGINE EXHAUST VELOCITIES AND TEMPERATURES
 6.1.1 EXHAUST VELOCITY CONTOURS
 BREAKAWAY POWER (GE CF6 80A3 ENGINE)
 MODEL 200

R

BA5 06 01 01 ACMO

ALL VELOCITY VALUES ARE IN STATUTE MILES PER HOUR.
 NOTE : BREAKAWAY POWER - SEA LEVEL STATIC, ZERO WIND
 STANDARD DAY, ZERO RAMP GRADIENT ENGINE TYPE.

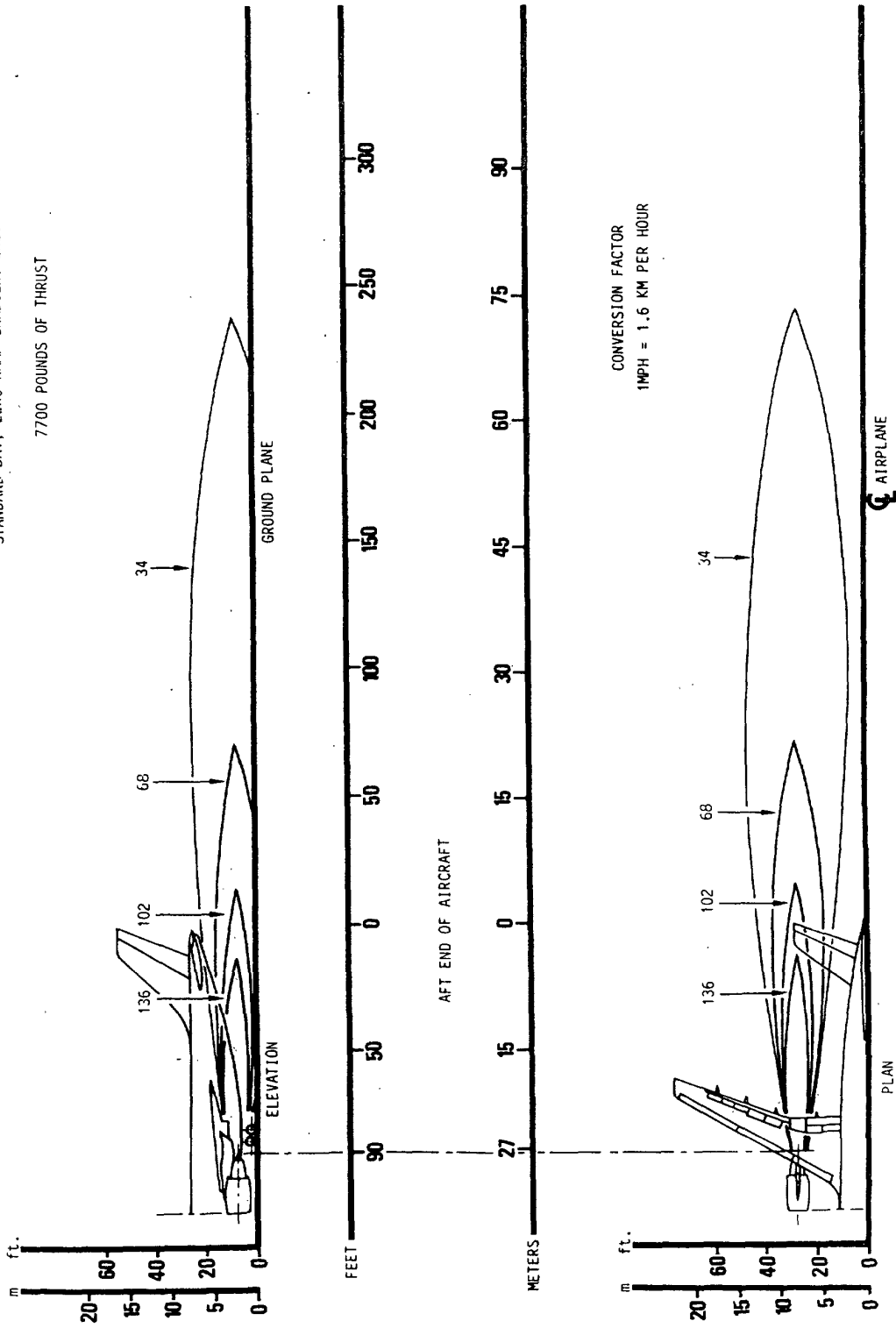

6.1 JET ENGINE EXHAUST VELOCITIES AND TEMPERATURES
 6.1.1 EXHAUST VELOCITY CONTOURS
 BREAKAWAY POWER (PWJT9D-7R4 ENGINE)
 MODEL 200

R

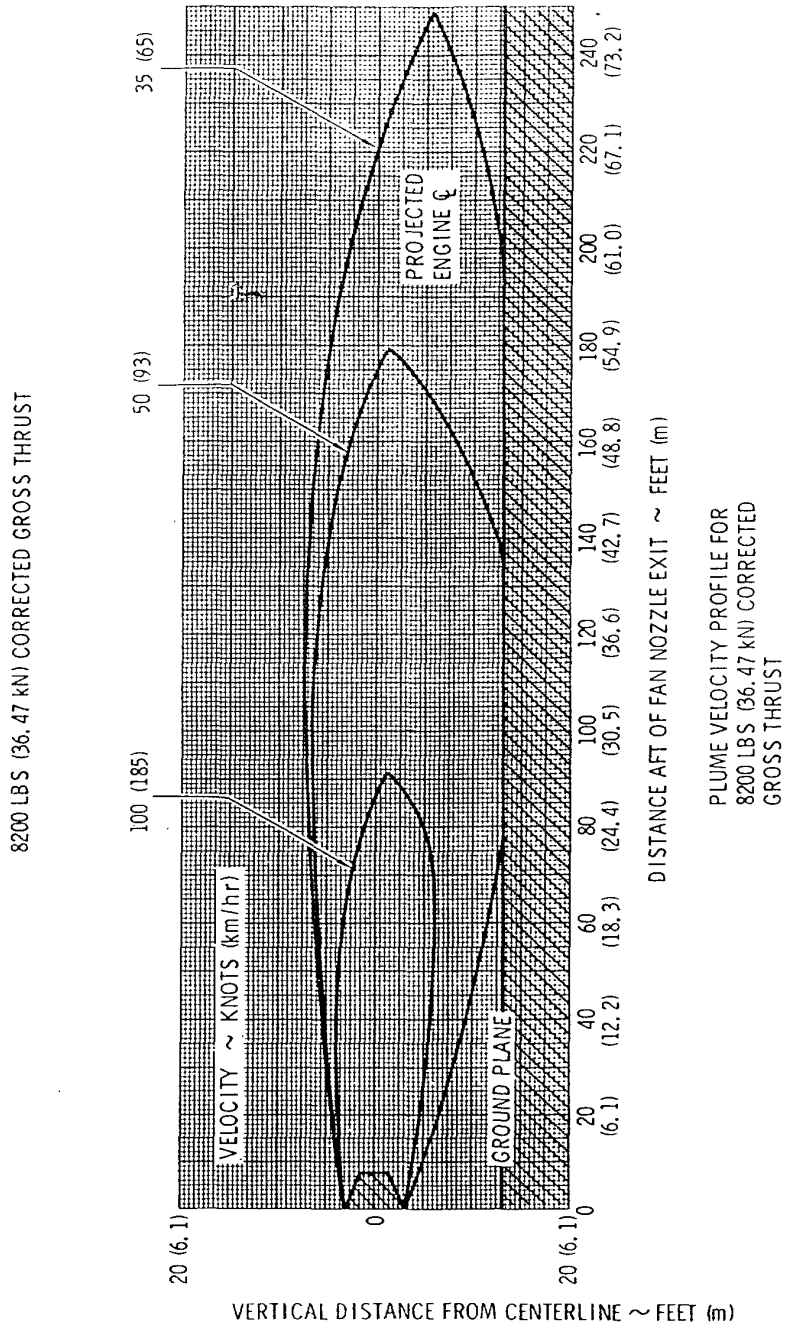

BA5 06 01 01 0 AEMO

CF8 8026.1 A2A

6.1 JET ENGINE EXHAUST VELOCITIES AND TEMPERATURES
6.1.1 EXHAUST VELOCITY CONTOURS BREAK AWAY POWER
(GE CF6-80C2 ENGINE) MODEL
(Sheet 1 of 3)

8200 LBS (36.47 kN) CORRECTED GROSS THRUST

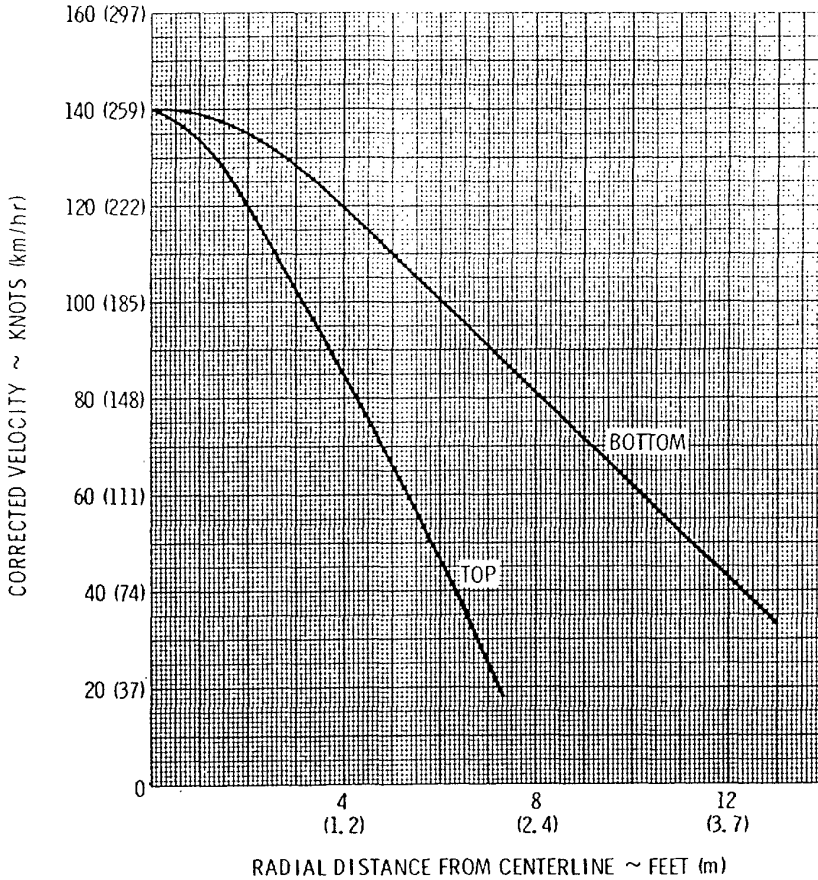

VELOCITY RADIAL VARIATIONS
61 FEET (18.59) AFT OF FAN NOZZLE EXIT

BAS 06 01 01 0 AGMO

CF8-8052-0-A2A

6.1 JET ENGINE EXHAUST VELOCITIES AND TEMPERATURES
6.1.1 EXHAUST VELOCITY CONTOURS BREAK AWAY POWER
(GE CF6-80C2 ENGINE) MODEL 300
(Sheet 2 of 3)

Chapter 6.1.1
Page 4
Oct 87

N

Printed in France



AIRPLANE CHARACTERISTICS FOR AIRPORT PLANNING

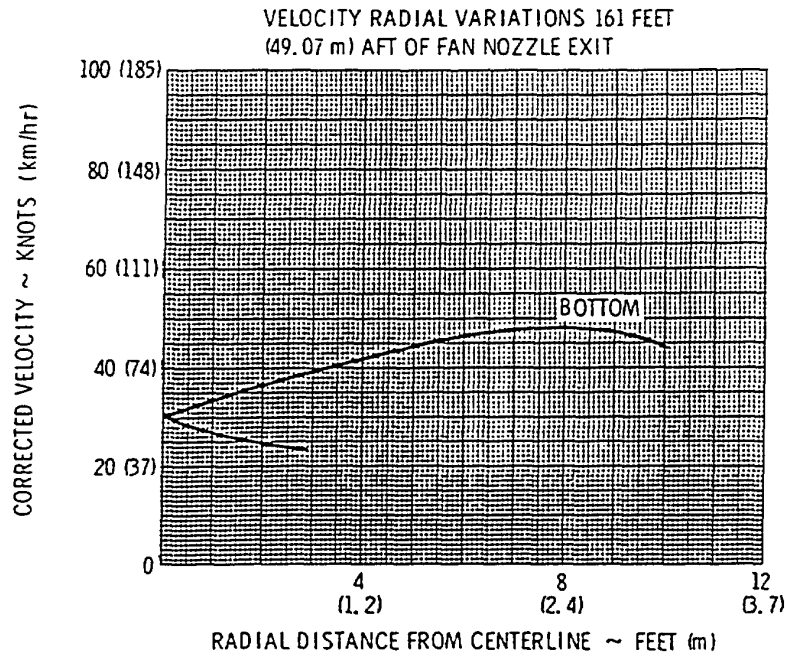
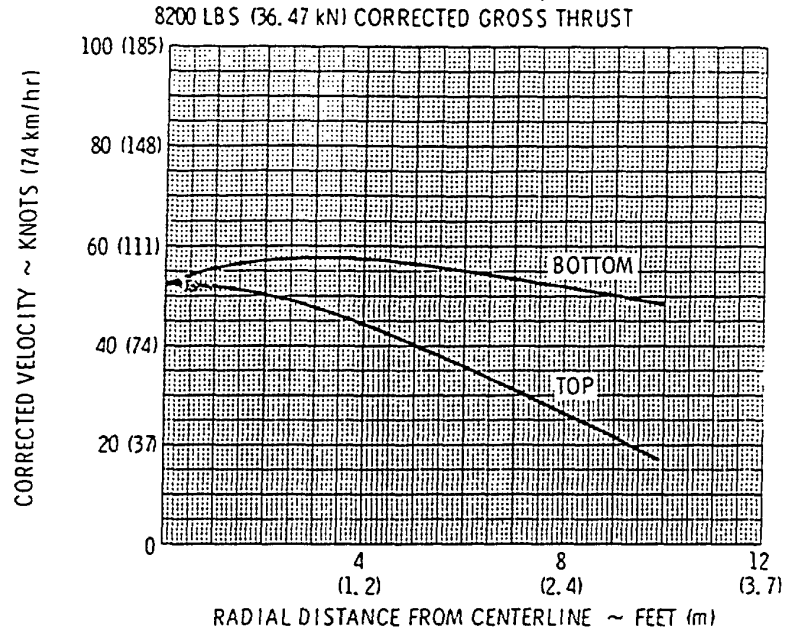

VELOCITY RADIAL VARIATIONS 200 FEET (60.96 m) AFT OF FAN NOZZLE EXIT

DA5 06 01 010 AJMD

CF8-8060-0-A2A

6.1 JET ENGINE EXHAUST VELOCITIES AND TEMPERATURES 6.1.1 EXHAUST VELOCITY CONTOURS BREAK AWAY POWER (GE CF6-80C2 ENGINE) MODEL 300 (Sheet 3 of 3)

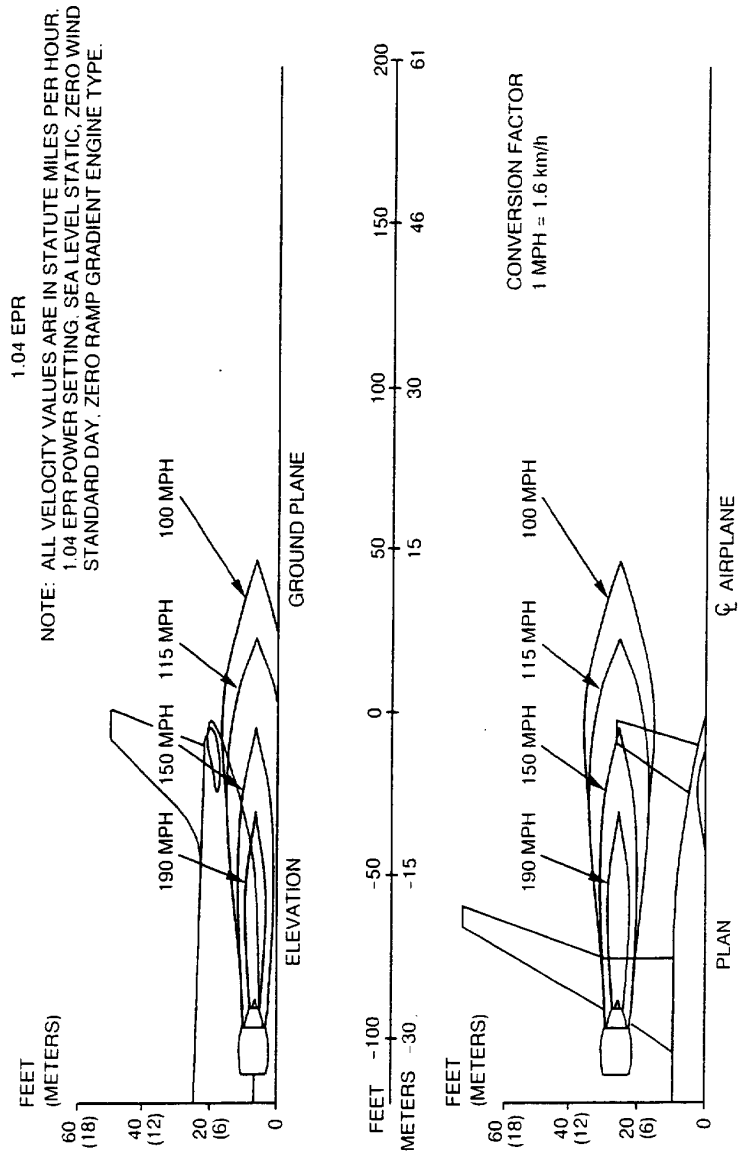

6.1 JET ENGINE EXHAUST VELOCITIES AND TEMPERATURES
6.1.1 EXHAUST VELOCITY CONTOURS BREAKAWAY
1.04 EPR (PW 4000 ENGINE)

Printed in France

BA5 06 01 02 AAM0

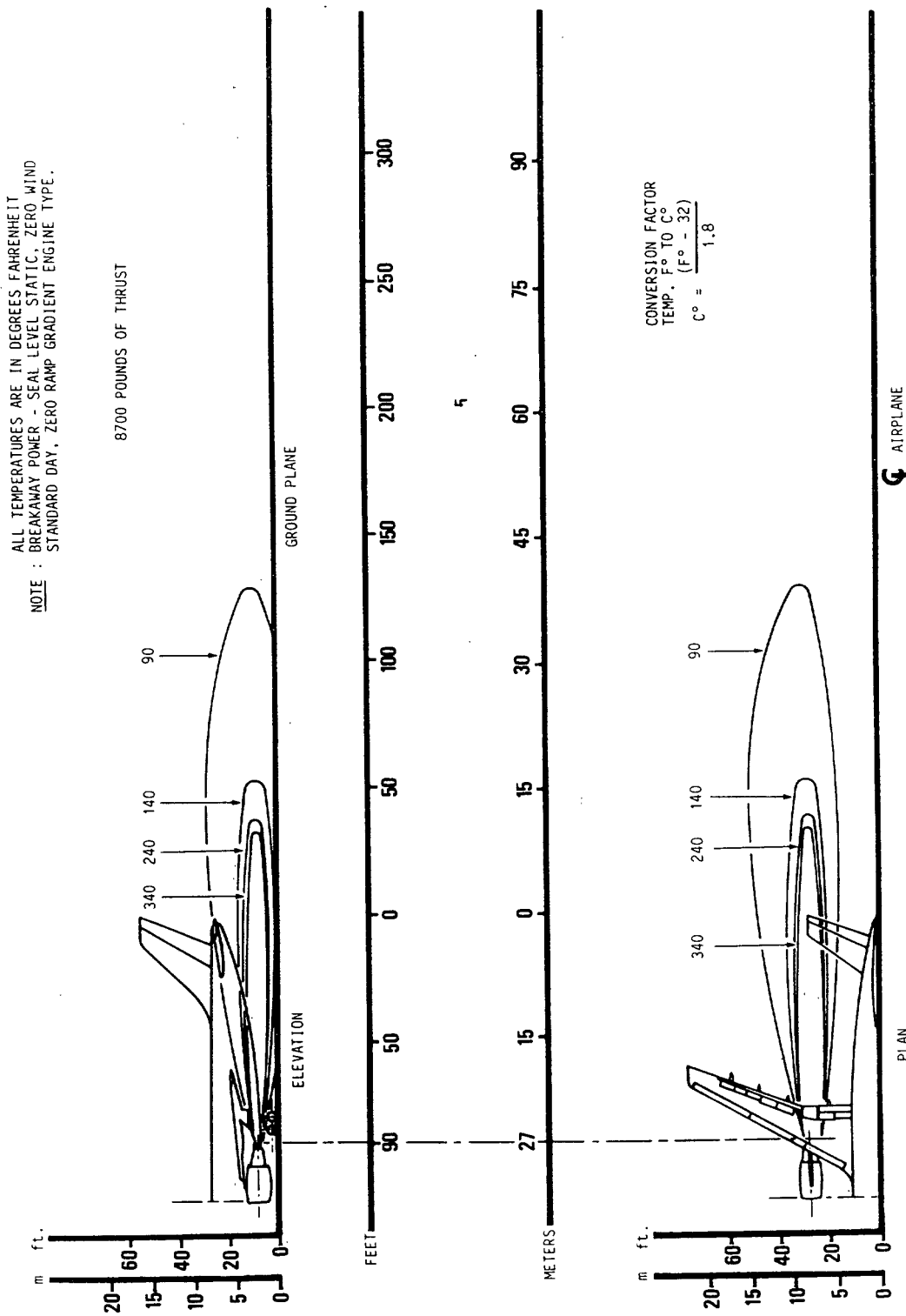

6.1 JET ENGINE EXHAUST VELOCITIES AND TEMPERATURES
6.1.2 EXHAUST TEMPERATURES CONTOURS
BREAKAWAY POWER (GE CF6 80A3 ENGINE)
MODEL 200

R

BA5 06 01 02 ACM0

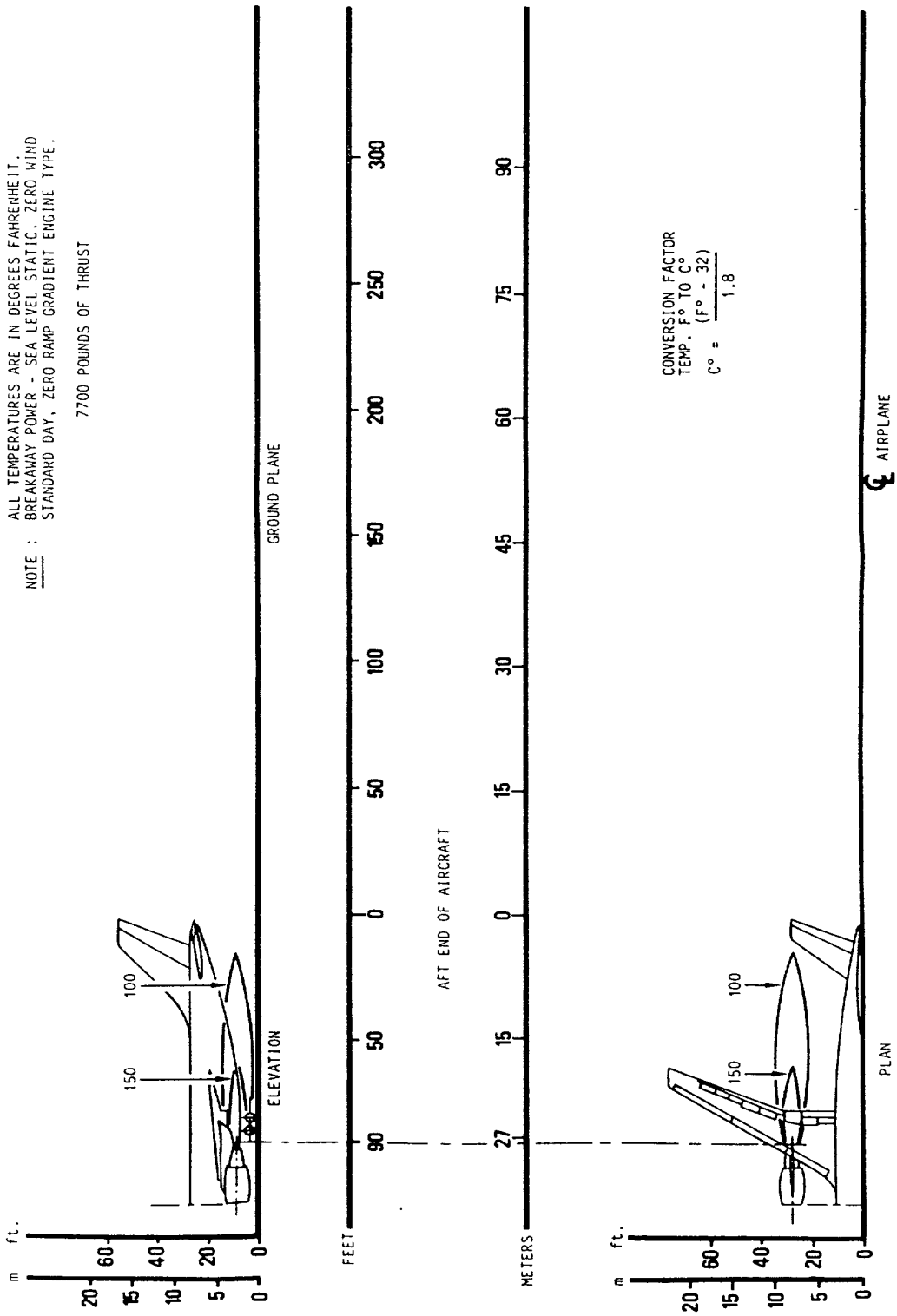

6.1 JET ENGINE EXHAUST VELOCITIES AND TEMPERATURES
 6.1.2 EXHAUST TEMPERATURE CONTOURS
 BREAKAWAY POWER (PW JT9D-7R4 ENGINE)
 MODEL 200



AIRPLANE CHARACTERISTICS FOR AIRPORT PLANNING

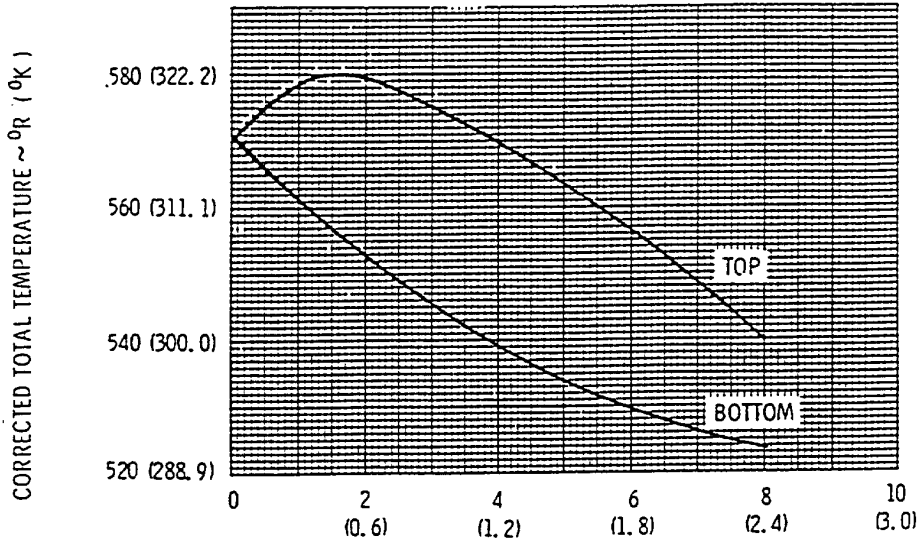

CORRECTED TOTAL TEMPERATURE RADIAL VARIATIONS
61 FEET (18.59) AFT OF THE FAN NOZZLE EXIT

VERTICAL DISTANCE FROM CENTERLINE ~ FEET (m)

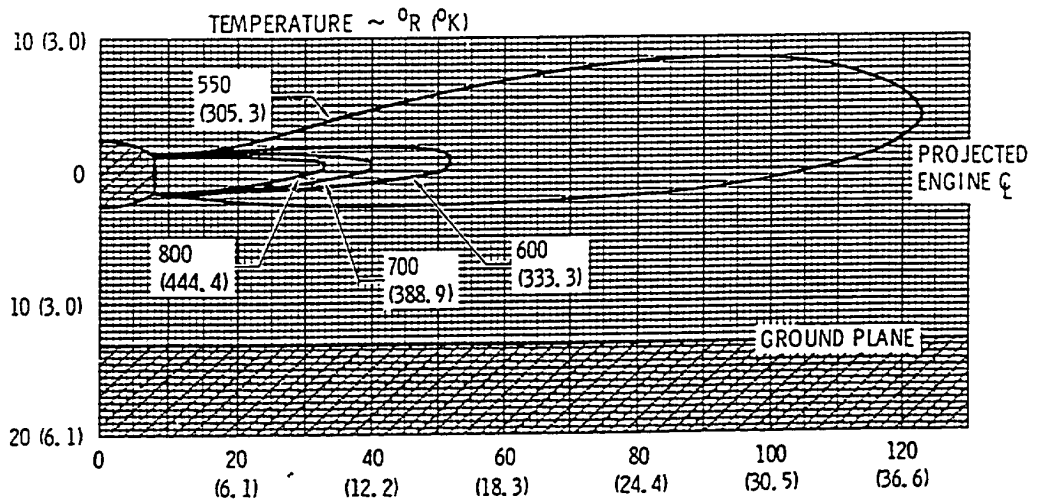

PLUME CORRECTED TOTAL TEMPERATURE PROFILE FOR
8700 LB. (38.70 KN) CORRECTED GROSS THRUST

CF8-8038-0-A2A

0A5 06 01 02 0 AEMO

6.1 JET ENGINE EXHAUST VELOCITIES AND TEMPERATURES
6.1.2 EXHAUST TEMPERATURE CONTOURS BREAK AWAY POWER
(GE CF6-80C2 ENGINE)
MODEL 300

Chapter 6.1.2
Page 3
Oct 87

Printed in France

N

1.04 EPR

NOTE: ALL TEMPERATURES ARE IN DEGREES FAHRENHEIT.
1.04 EPR POWER SETTING, SEA LEVEL STATIC, ZERO WIND
STANDARD DAY, ZERO RAMP GRADIENT ENGINE TYPE.

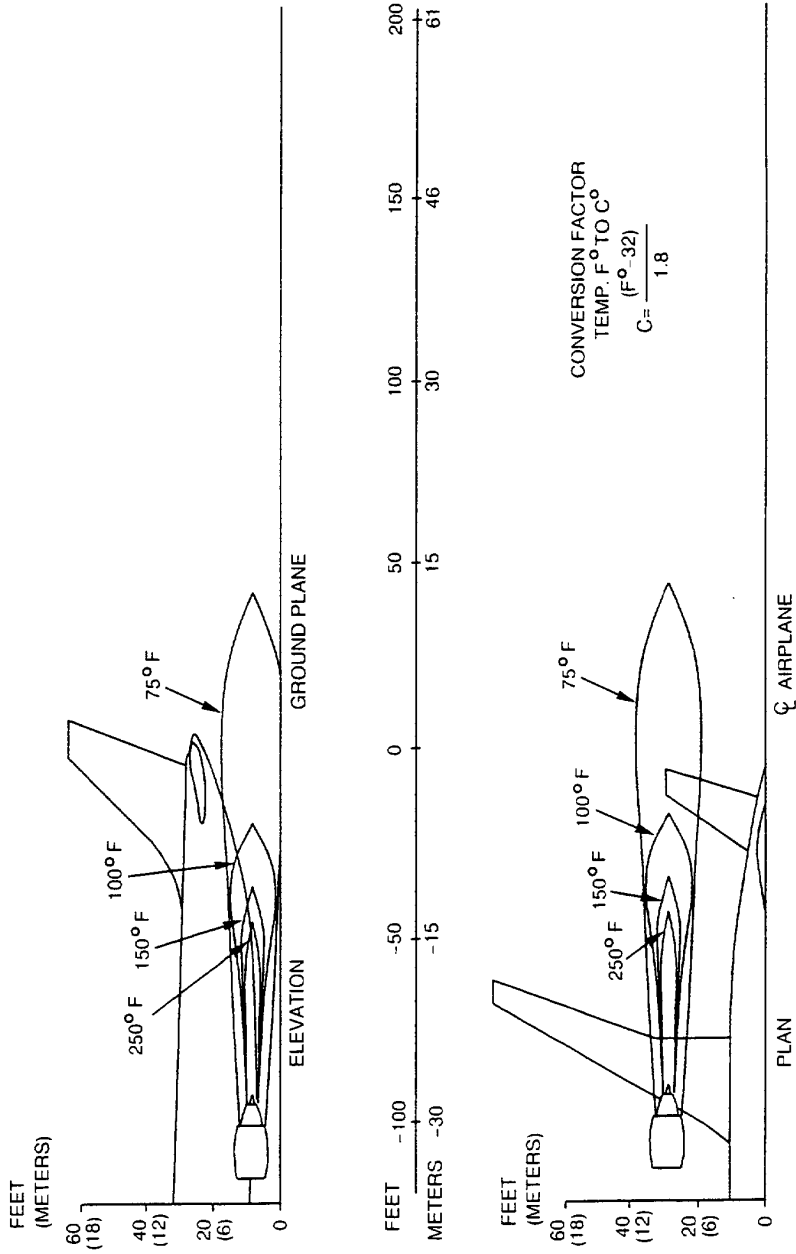

6.1 JET ENGINE EXHAUST VELOCITIES AND TEMPERATURES 6.1.2 EXHAUST TEMPERATURE CONTOURS BREAKAWAY 1.04 EPR (PW 4000 ENGINE)

Printed in France

BA5 06 01 03 AAM0

R

ALL VELOCITY VALUES ARE STATUTE MILES PER HOUR.
 NOTE : GROUND IDLE POWER - SEA LEVEL STATIC, ZERO WIND,
 STANDARD DAY, ZERO RAMP GRADIENT ENGINE TYPE.

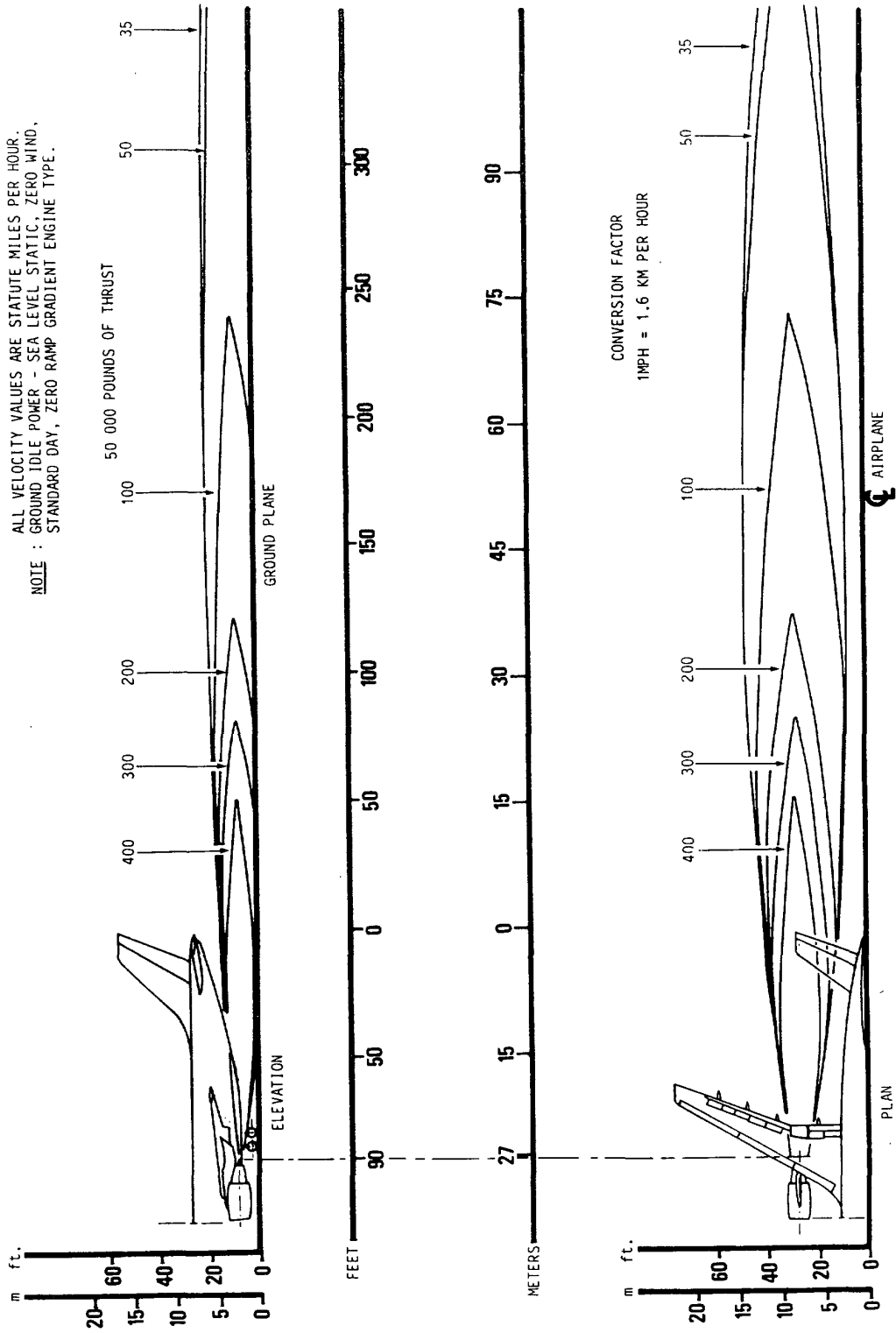

6.1 JET ENGINE EXHAUST VELOCITIES AND TEMPERATURES
 6.1.3 EXHAUST VELOCITY CONTOURS-TAKEOFF POWER
 (GE CF6 80A3 ENGINE)
 MODEL 200

BA5 06 01 03 ACMO

NOTE : ALL VELOCITY VALUES ARE IN STATUTE MILES PER HOUR.
 TAKEOFF POWER - SEA LEVEL STATIC, ZERO WIND
 STANDARD DAY, ZERO RAMP GRADIENT ENGINE TYPE.

45 520 POUNDS OF THRUST

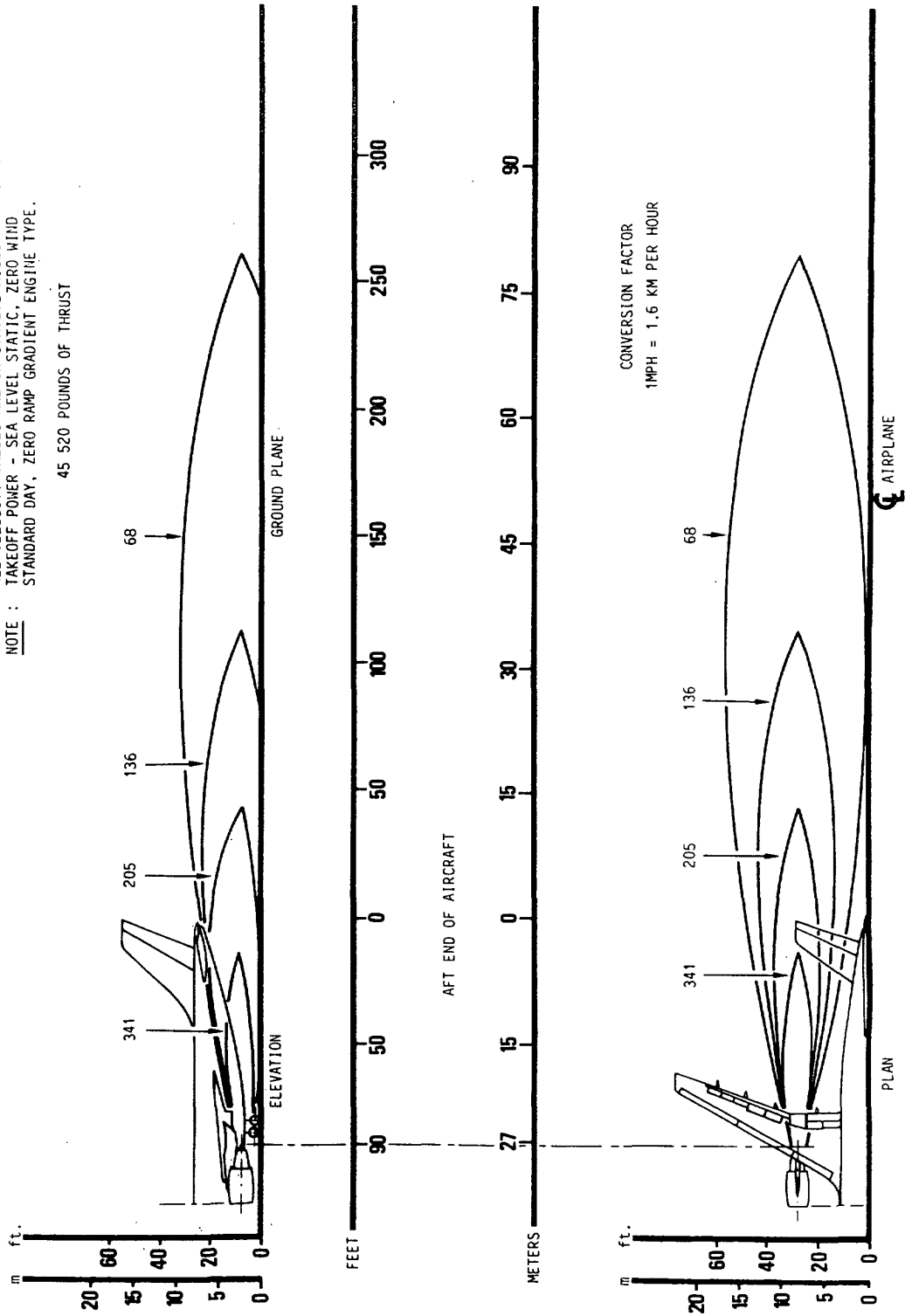

6.1 JET ENGINE EXHAUST VELOCITIES AND TEMPERATURES
 6.1.3 EXHAUST VELOCITY CONTOURS-TAKEOFF POWER
 (PW JT9D-7R4 ENGINE)
 MODEL 200

R

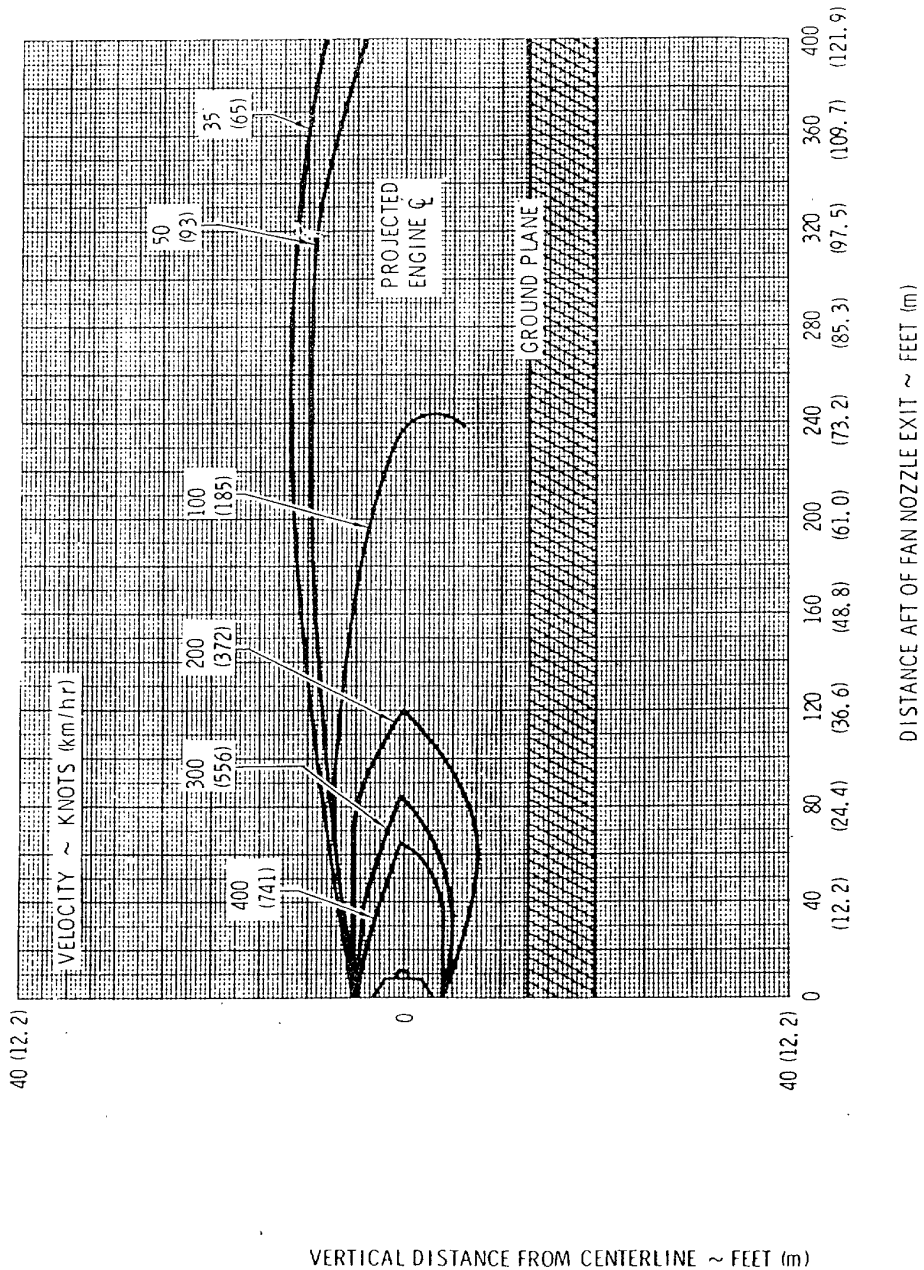

BA5 06 01 03 0 AEMO

6.1 JET ENGINE EXHAUST VELOCITIES AND TEMPERATURES
 6.1.3 EXHAUST VELOCITY CONTOURS-TAKE-OFF POWER
 (GE CF6-80C2 ENGINE)

MODEL 300

Printed in France

BA5 06 01 03 0 AGM0

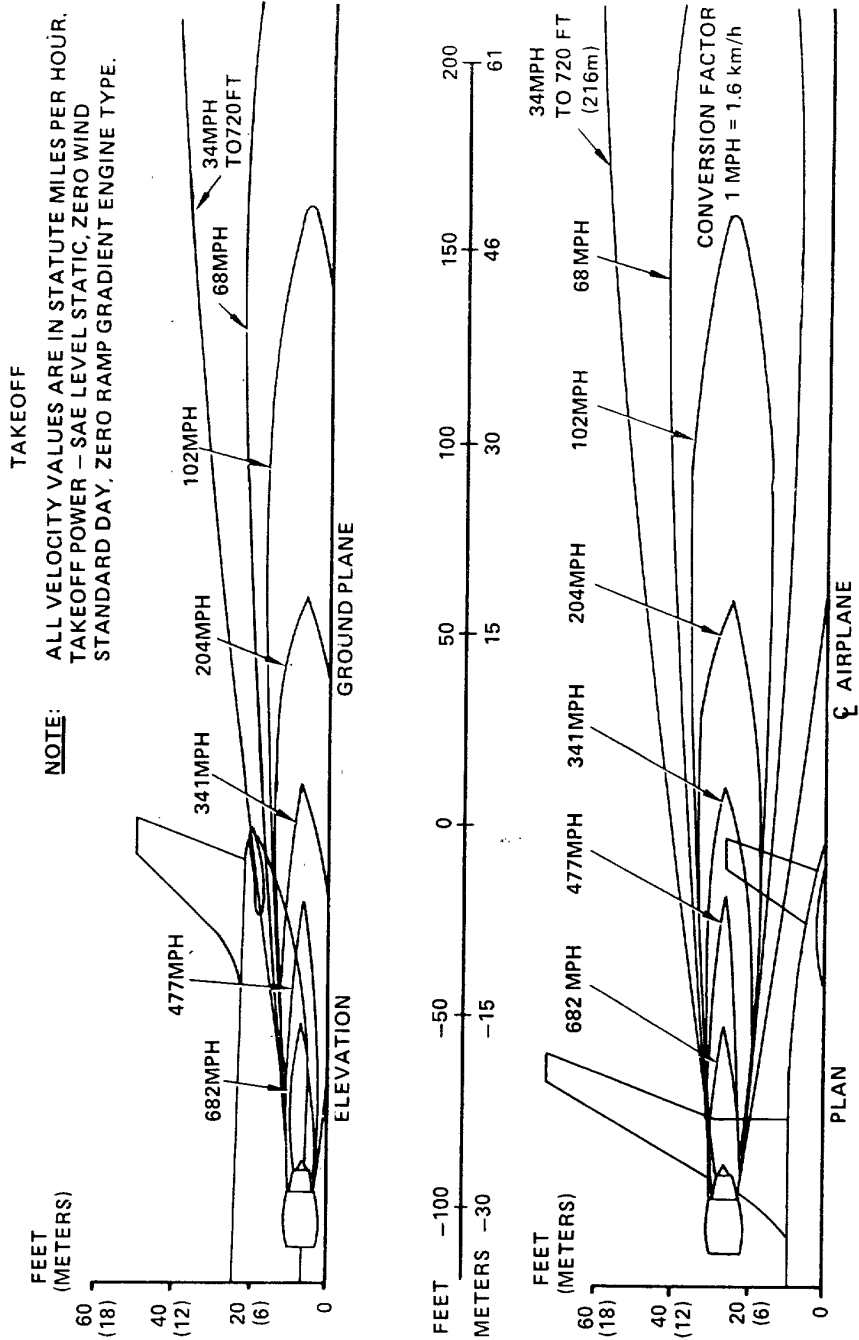

L-A1122
1086

6.1 JET ENGINE EXHAUST VELOCITIES AND TEMPERATURES
6.1.3 EXHAUST VELOCITY CONTOURS-TAKE-OFF
(PW 4000 ENGINE)

Printed in France

BA5 05 01 04 AAM0

ALL TEMPERATURES ARE IN DEGREES FAHRENHEIT
 NOTE : BREAKAWAY POWER - SEAL LEVEL STATIC, ZERO WIND,
 STANDARD DAY, ZERO RAMP GRADIENT ENGINE TYPE.

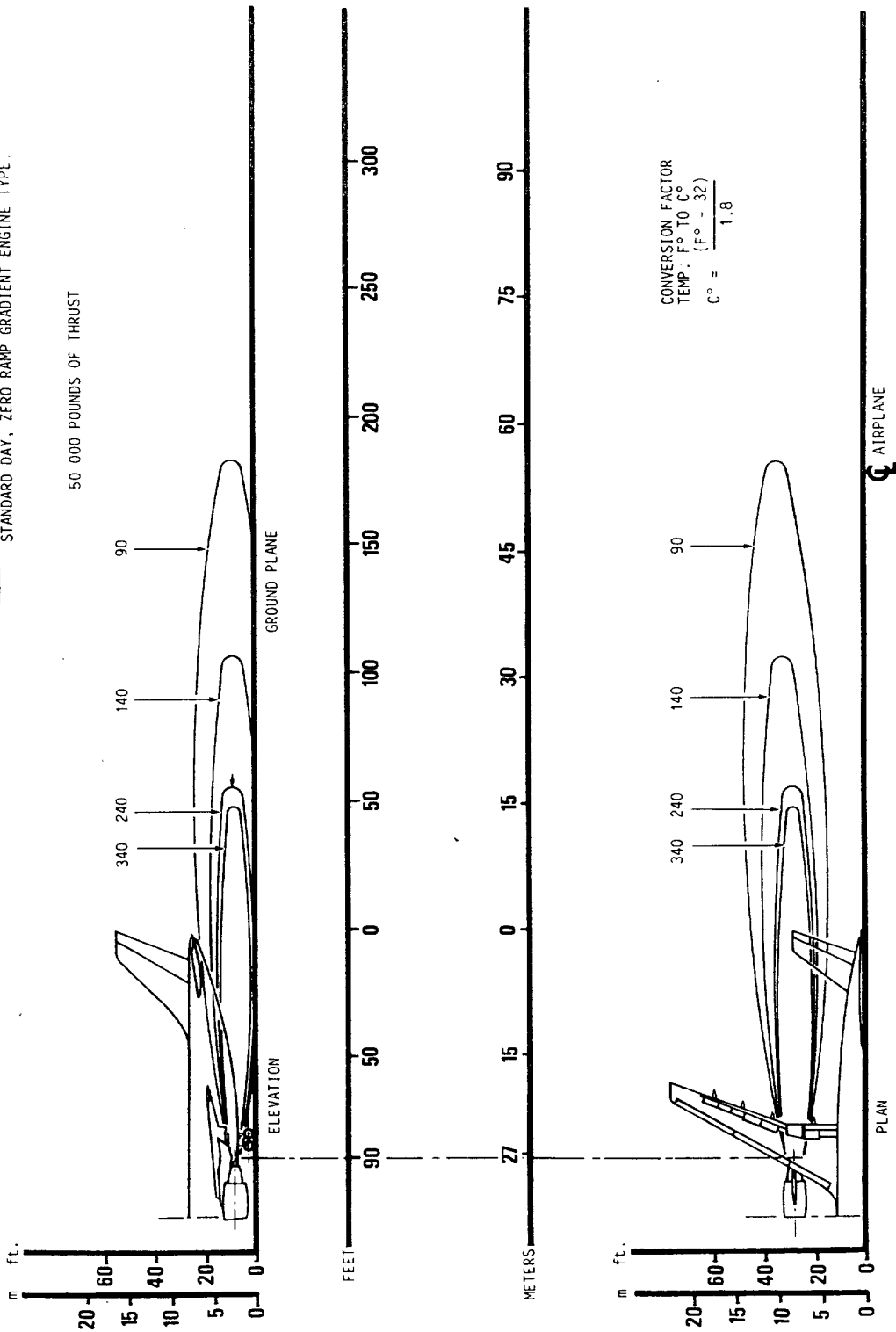

6.1 JET ENGINE EXHAUST VELOCITIES AND TEMPERATURES
 6.1.4 EXHAUST TEMPERATURE CONTOURS TAKEOFF POWER
 (GE CF6 80A3 ENGINE)
 MODEL 200

BA5 06 01 04 ACMO

R

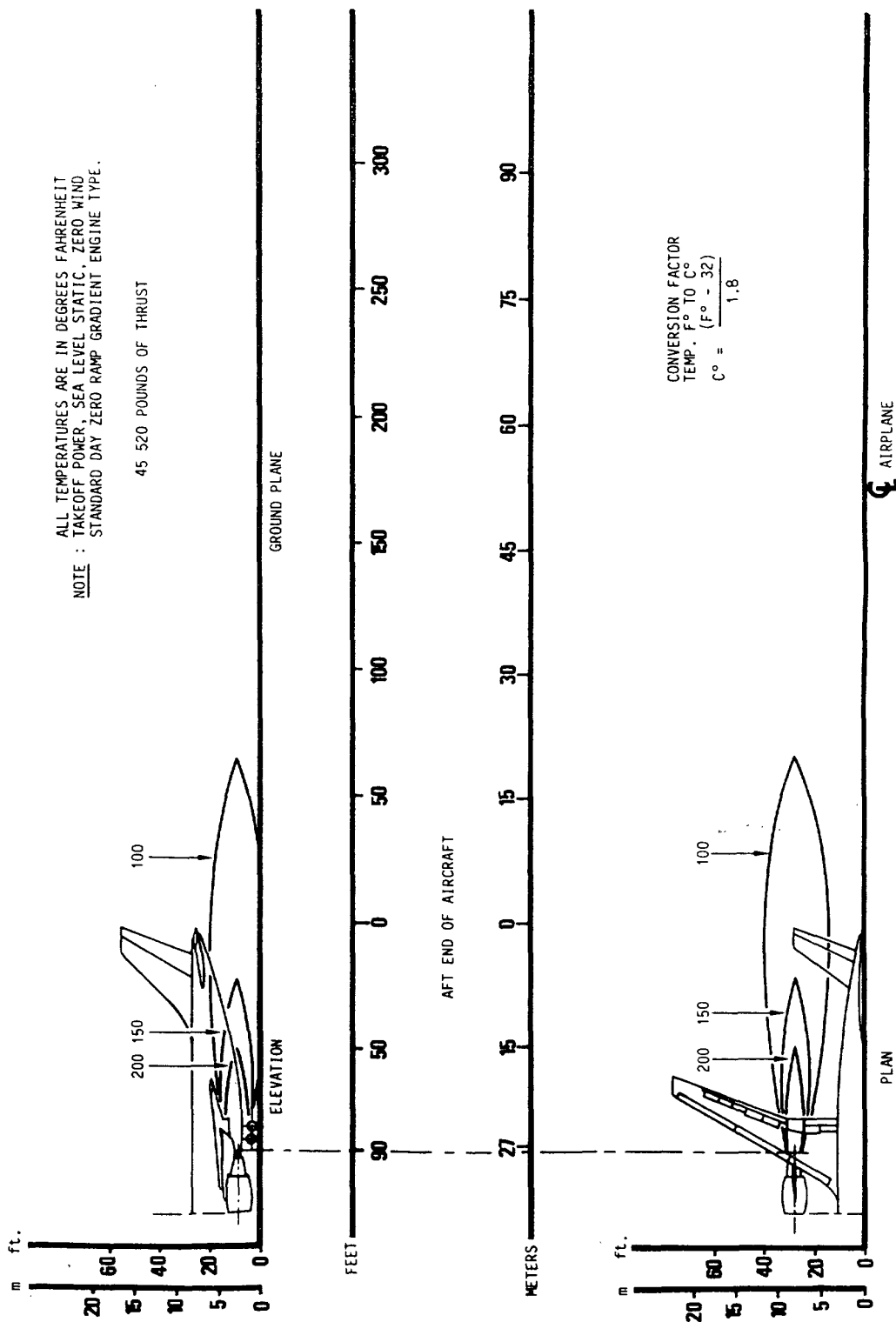

6.1 JET ENGINE EXHAUST VELOCITIES AND TEMPERATURES
6.1.4 EXHAUST TEMPERATURE CONTOUR
TAKEOFF POWER (PW JT9D-7R4 ENGINE)
MODEL 200

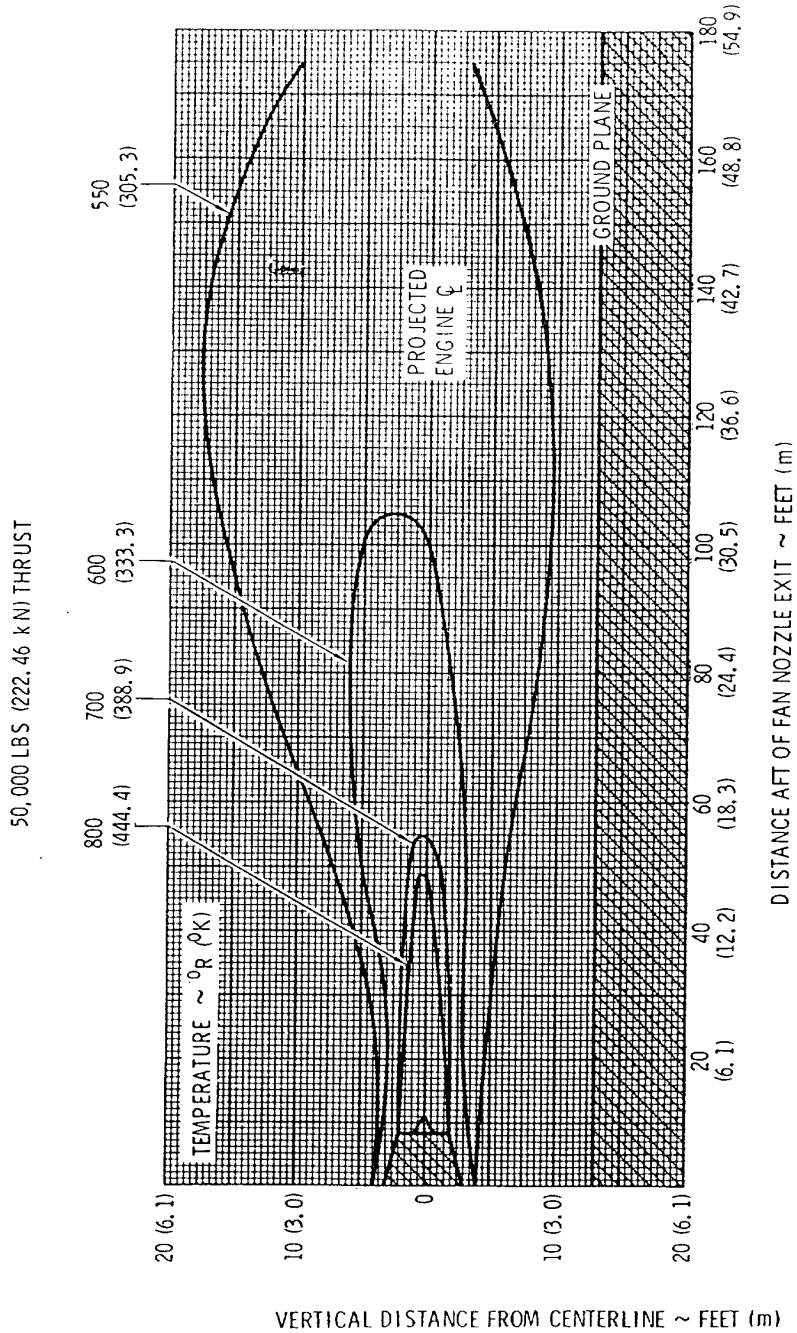

BA5 06 01 04.0 AEMO

6.1 JET ENGINE EXHAUST VELOCITIES AND TEMPERATURES
 6.1.4 EXHAUST TEMPERATURE CONTOURS-TAKE-OFF POWER
 (GE CF6-80C2 ENGINE)
 MODEL 300

Chapter 6.1.4
 Page 3
 Oct 87

Printed in France

CF6-8034-0-A2A

BA5 06 01 04 0 AGMO

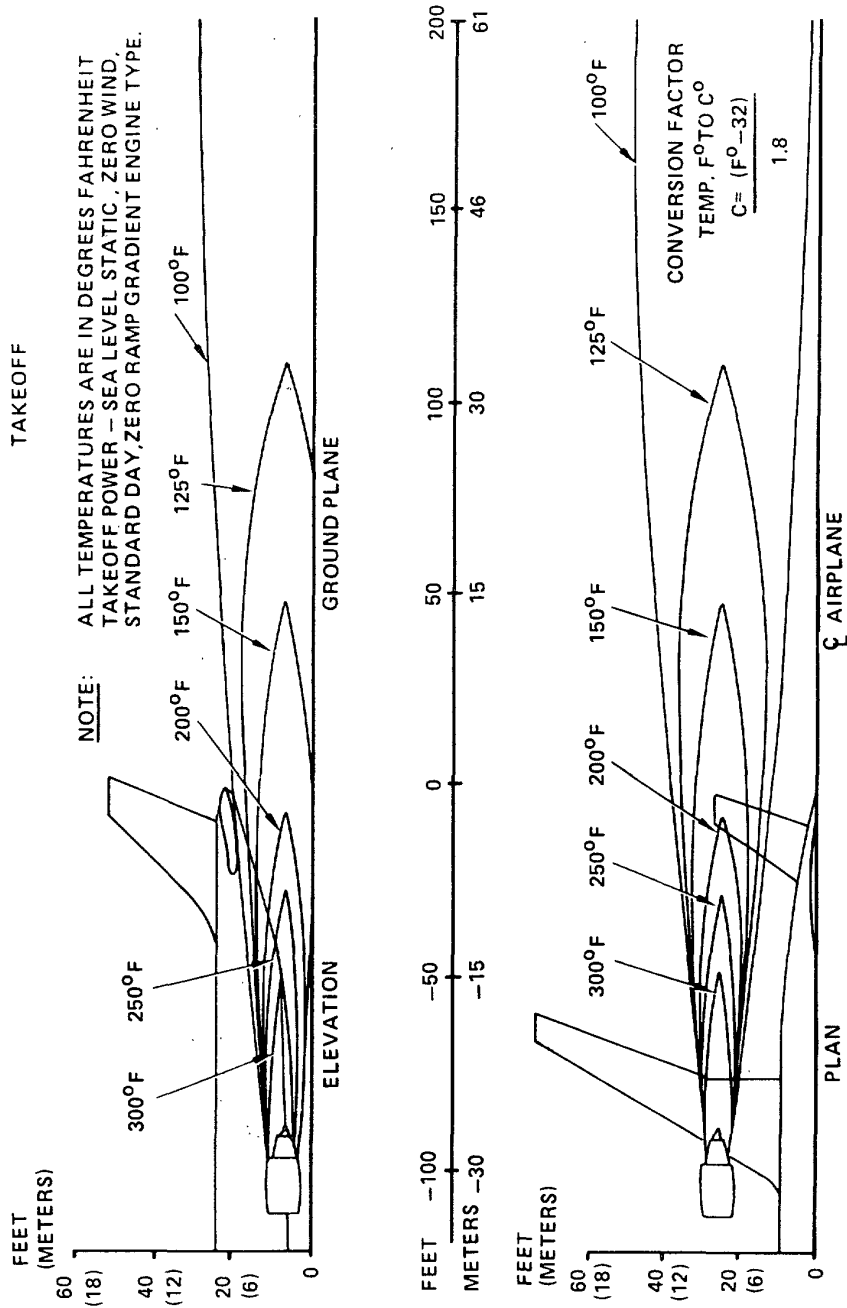

L-A1131
1086

6.1 JET ENGINE EXHAUST VELOCITIES AND TEMPERATURES
6.1.4 EXHAUST TEMPERATURE CONTOURS-TAKE-OFF
(PW 4000 ENGINE)

Printed in France

BA5 06 01 05 AAM0

NOTE : ALL VELOCITY VALUES ARE STATUTE MILES PER HOUR.
 : GROUND, IDLE POWER - SEA LEVEL STATIC, ZERO WIND,
 STANDARD DAY, ZERO RAMP GRADIENT ENGINE TYPE.

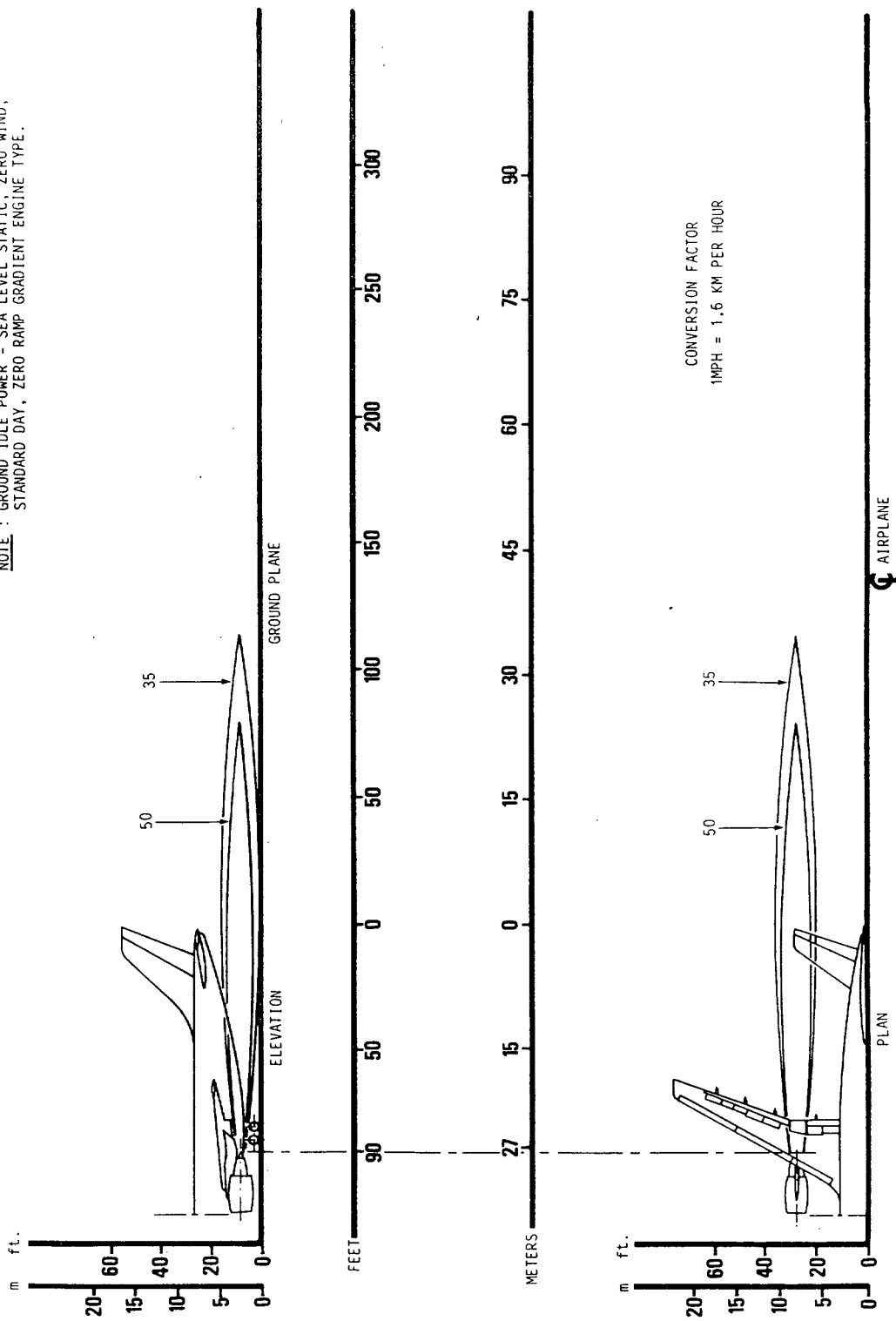

6.1 JET ENGINE EXHAUST VELOCITIES AND TEMPERATURES
 6.1.5 EXHAUST VELOCITY CONTOURS-IDLE POWER
 (GE CF6 80A3 ENGINE)
 MODEL 200

BA5 06 01 05 ACMO

NOTE : ALL VELOCITY VALUES ARE IN STATUTE MILES PER HOUR.
GROUND IDLE POWER, SEA LEVEL STATIC, ZERO WIND
STANDARD DAY, ZERO RAMP GRADIENT ENGINE TYPE.

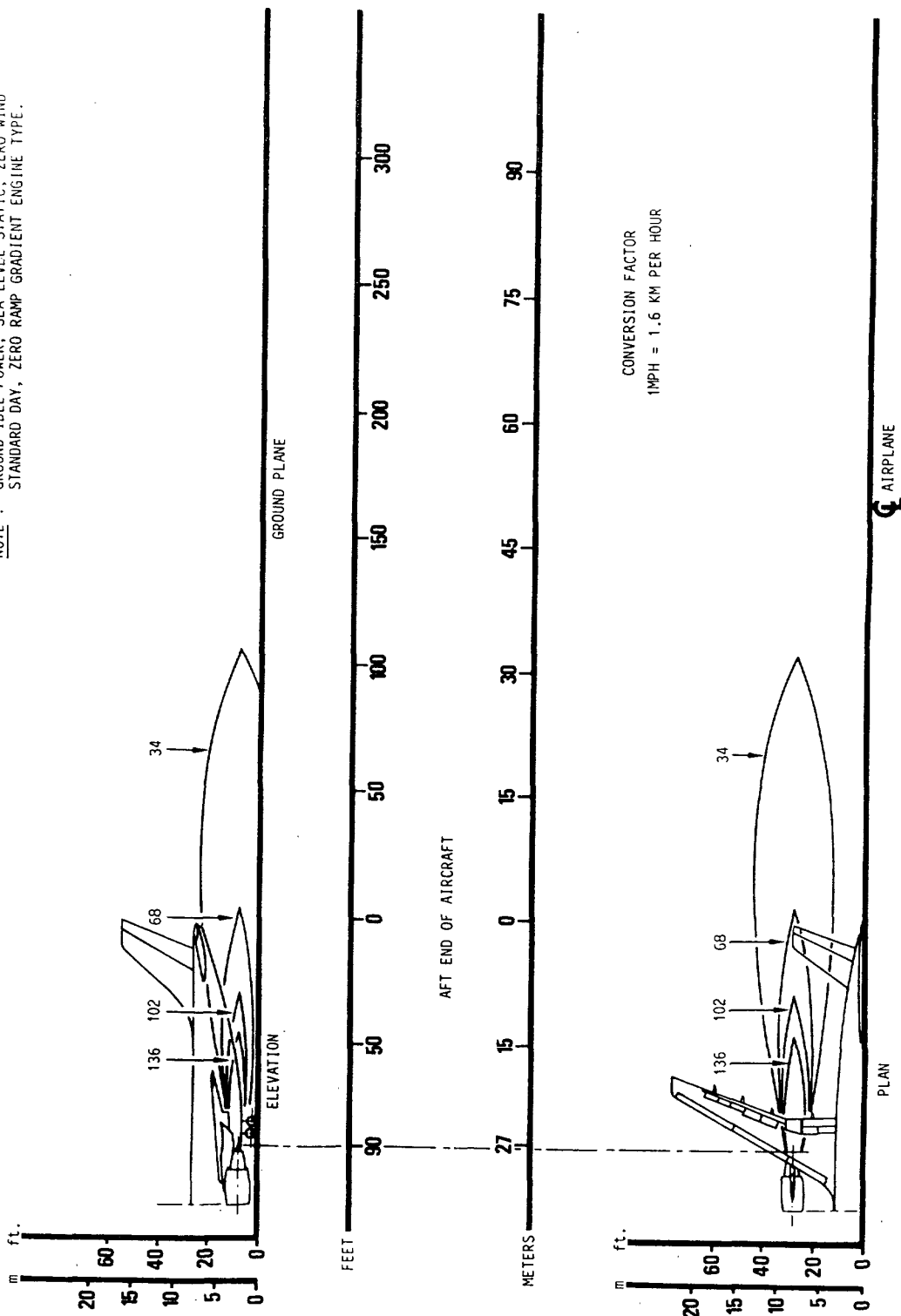

6.1 JET ENGINE EXHAUST VELOCITIES AND TEMPERATURES
6.1.5 EXHAUST VELOCITY CONTOURS - IDLE POWER
(PW JT9D-7R4 ENGINE)
MODEL 200

R

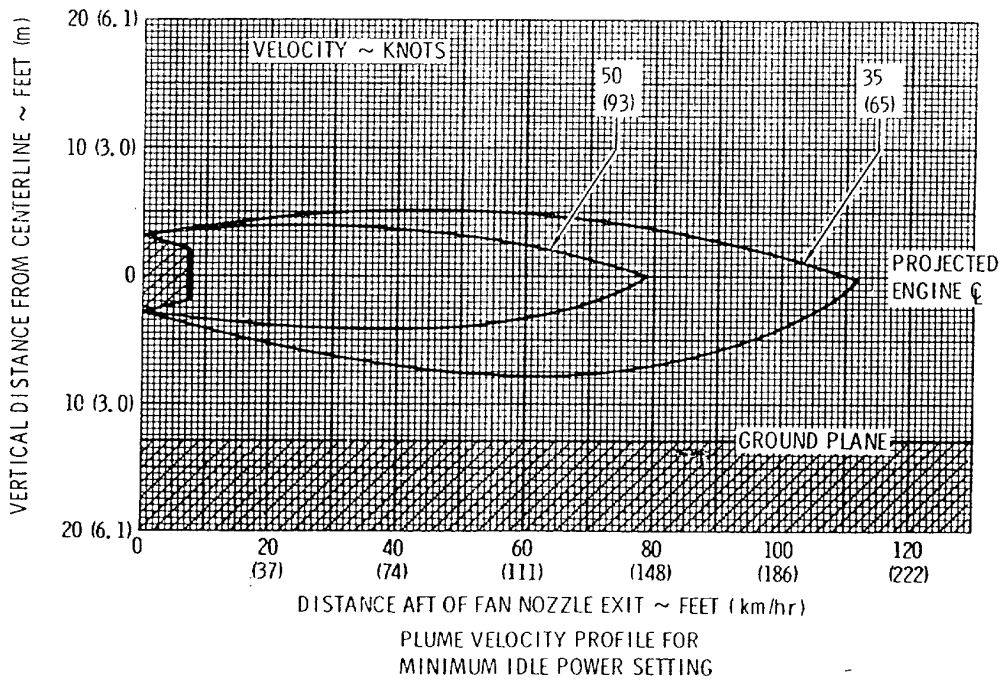
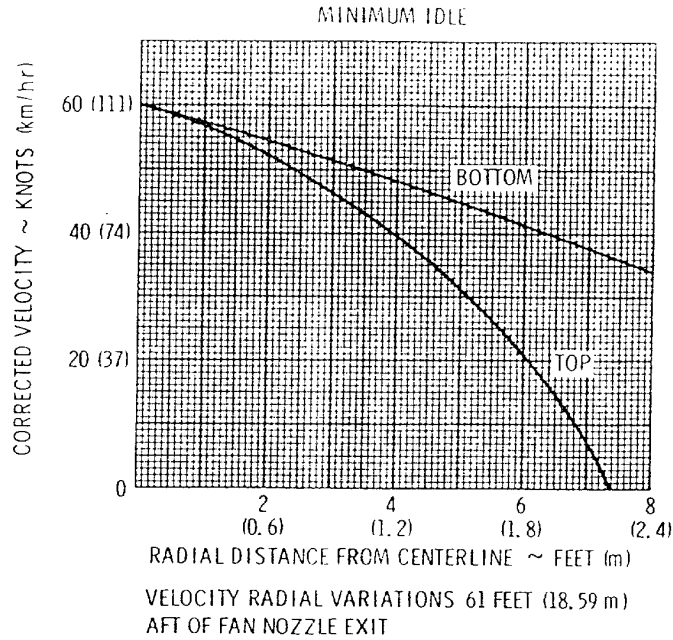

CF8-8033-0-A2A

BA5 06 01 05 0 AEMO

6.1 JET ENGINE EXHAUST VELOCITIES AND TEMPERATURES
 6.1.5 EXHAUST VELOCITY CONTOURS—IDLE POWER
 (GE CF6-80C2 ENGINE)
 MODEL 300

BA5 06 01 05 0 AGM0

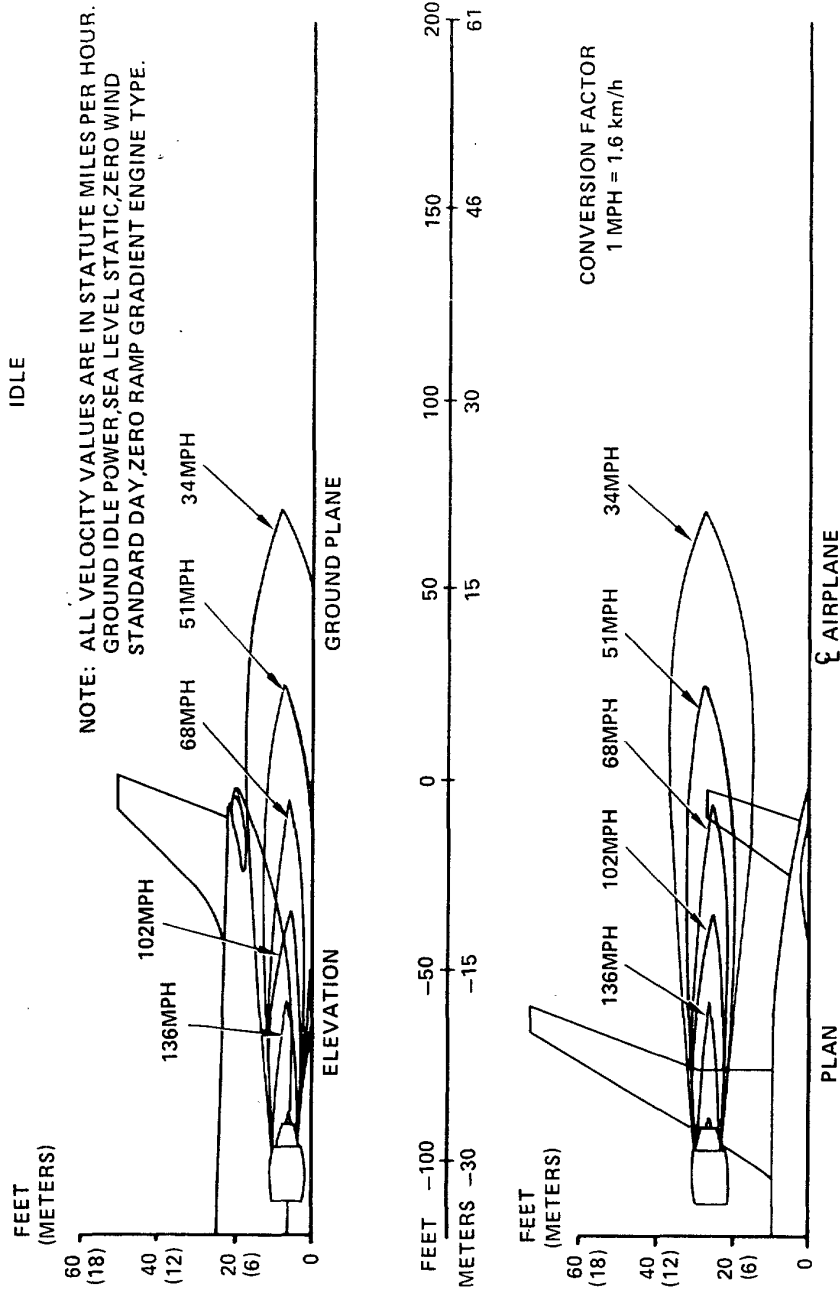

L-A1114

6.1 JET ENGINE EXHAUST VELOCITIES AND TEMPERATURES
6.1.5 EXHAUST VELOCITY CONTOURS-IDLE
(PW 4000 ENGINE)

Printed in France

BA5 06 01 06 AAMO

R

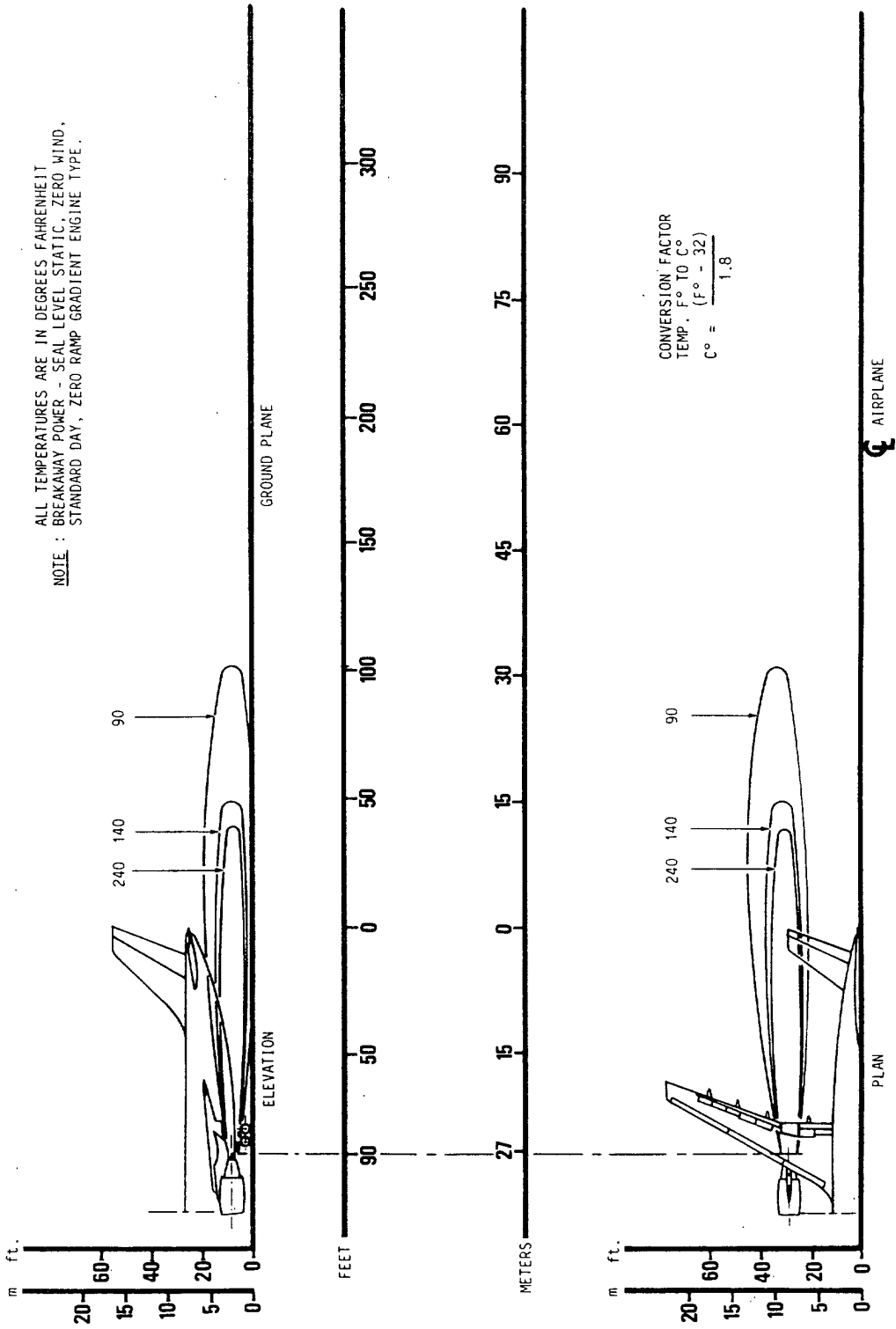

6.1 JET ENGINE EXHAUST VELOCITIES AND TEMPERATURES
 6.1.6 EXHAUST TEMPERATURE CONTOURS - IDLE POWER
 (GE CF6 80A3 ENGINE)
 MODEL 200

ALL TEMPERATURES ARE IN DEGREES FAHRENHEIT
 NOTE : GROUND, IDLE POWER, - SEA LEVEL STATIC, ZERO WIND,
 STANDARD DAY, ZERO RAMP GRADIENT ENGINE TYPE.

BA 5 06 01 06 ACMO

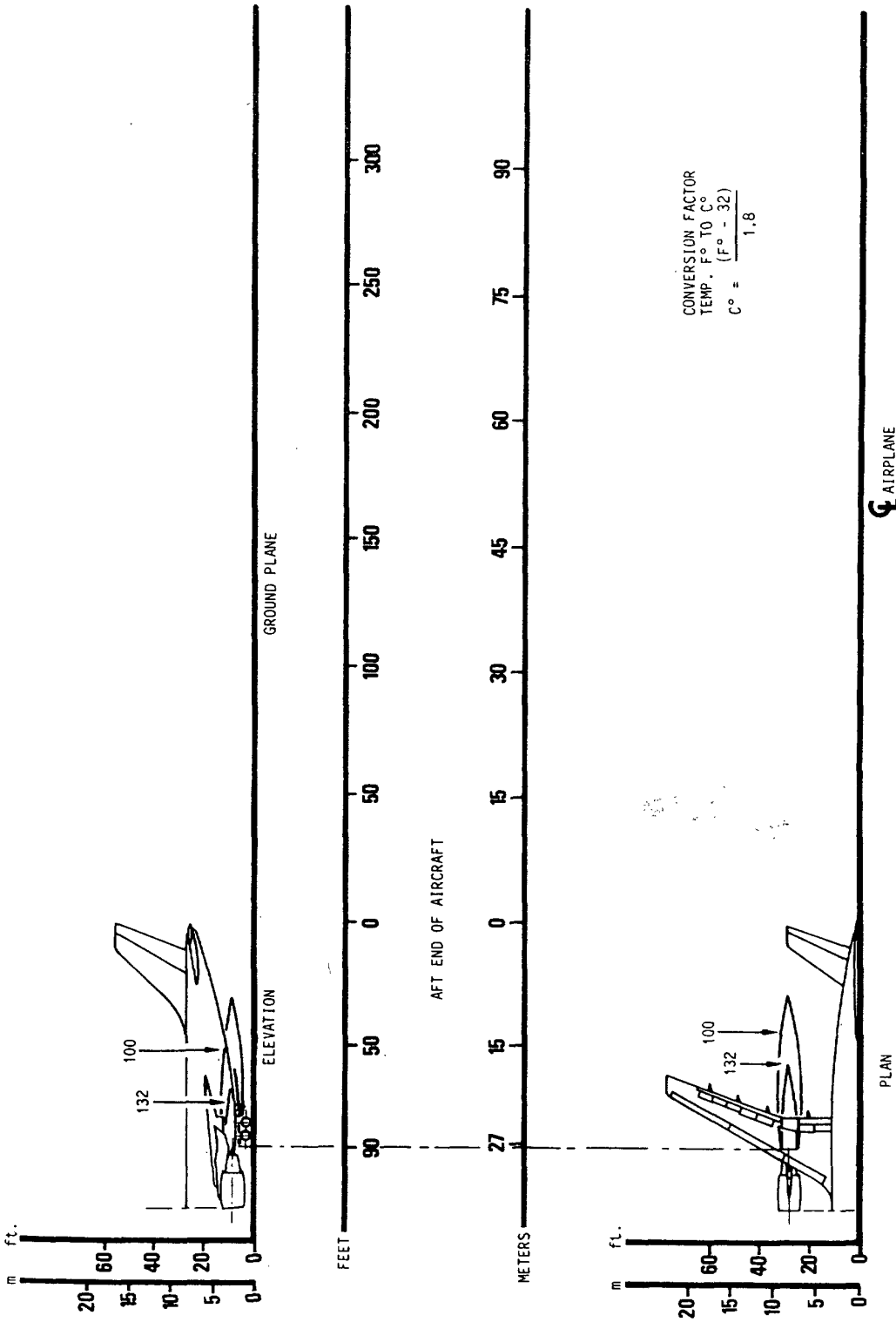

6.1 JET ENGINE EXHAUST VELOCITIES AND TEMPERATURES
 6.1.6 EXHAUST TEMPERATURE CONTOURS - IDLE POWER
 (PW JT9D-7R4 ENGINE)
 MODEL 200

R

CORRECTED TOTAL TEMPERATURE
RADIAL VARIATIONS 61 FEET (18.59 m)
AFT OF THE FAN NOZZLE EXIT

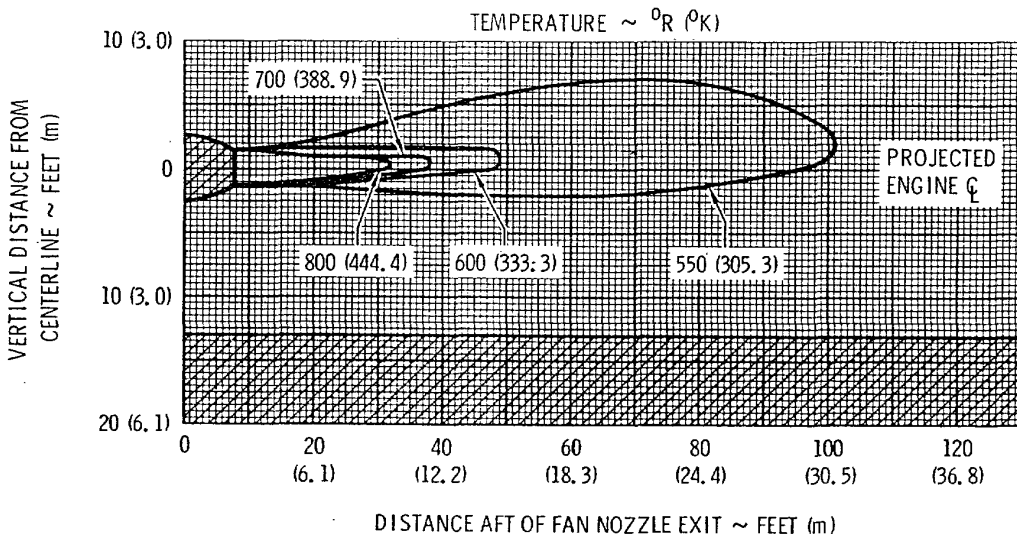
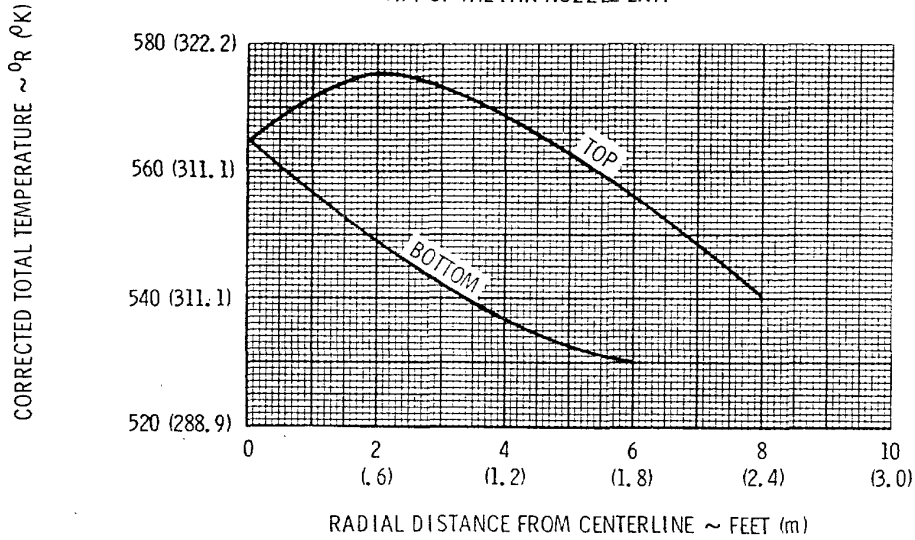

PLUME CORRECTED TOTAL
TEMPERATURE PROFILE FOR
MINIMUM IDLE POWER SETTING

CF8-8041-0-A2A

6.1 JET ENGINE EXHAUST VELOCITIES AND TEMPERATURES
6.1.6 EXHAUST TEMPERATURE CONTOURS—IDLE POWER
(GE CF6-80C2 ENGINE)

MODEL 300

Chapter 6.1.6

Page 3

Oct 87

Printed in France

BA5 06 01 06 0 AEMO

N

BA5 06 01 06 0 AGMO

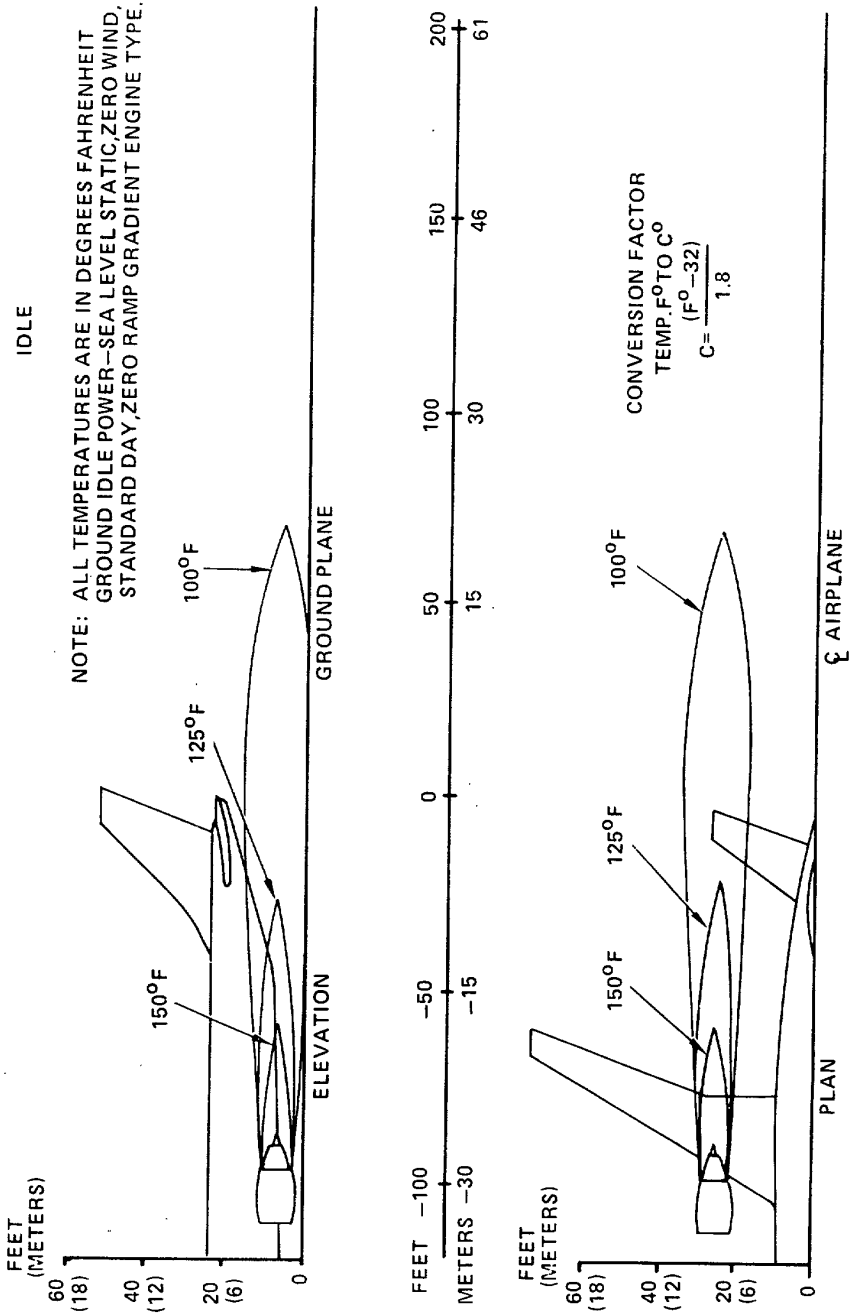

6.1 JET ENGINE EXHAUST VELOCITIES AND TEMPERATURES
6.1.6 EXHAUST TEMPERATURE CONTOURS—IDLE
(PW 4000 ENGINE)

6.2 AIRPORT AND COMMUNITY NOISE

Table 6.2.1 provides data concerning engine maintenance run-up noise to permit evaluation of possible attenuation requirements.

ESTIMATED PROVISIONAL VALUES

OCTAVE BAND CENTER FREQUENCY	OCTAVE BAND SPL, dB (20 μ Pa)		
	45° TO EXHAUST	40° TO EXHAUST	50° TO EXHAUST
63 Hz	103.1	105.9	100.3
125 Hz	109.2	111.5	106.9
250 Hz	106.1	107.7	104.6
500 Hz	103.5	104.3	102.7
1000 Hz	99.2	99.8	98.7
2000 Hz	96.3	95.7	96.9
4000 Hz	92.8	92.7	93.0
8000 Hz	90.2	89.5	90.9

Printed in France.

GROUND STATIC
 TAKEOFF POWER
 100 METERS RADIUS
 45° LEVELS ARE AVERAGE OF 40° AND 50° LEVELS

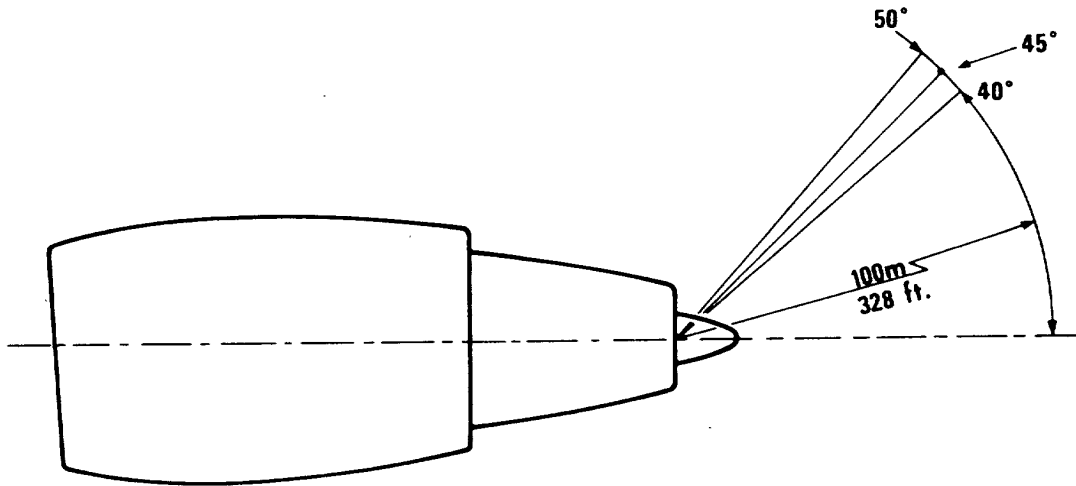

BA5 06 02 01 AAMO

6.2 AIRPORT AND COMMUNITY NOISE
 6.2.1 NOISE DATA
 MODEL 200 (GE CF6 80A3 ENGINE)

R

AIRBUS  INDUSTRIE **A 310 AIRPLANE CHARACTERISTICS**

ESTIMATED PROVISIONAL VALUES

OCTAVE BAND CENTER FREQUENCY	OCTAVE BAND SPL, dB (20 μ Pa)		
	45° TO EXHAUST	40° TO EXHAUST	50° TO EXHAUST
63 Hz	101.3	105.1	101.5
125 Hz	99.5	101.2	99.7
250 Hz	103.9	105.9	103.8
500 Hz	98.6	99.1	98.8
1000 Hz	94.1	94.1	94.3
2000 Hz	92.3	91.6	92.6
4000 Hz	92.0	88.1	91.1
8000 Hz	91.2	88.5	91.4

GROUND STATIC

TAKEOFF POWER

100 METERS RADIUS

45° LEVELS ARE AVERAGE OF 40° AND 50° LEVELS

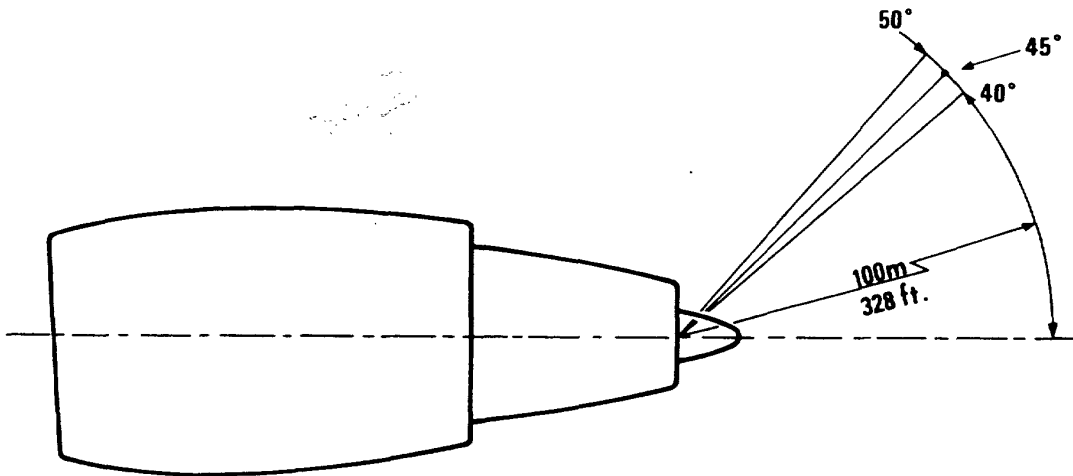

BA5 06 02 01 ACMO

6.2 AIRPORT AND COMMUNITY NOISE
6.2.1 NOISE DATA
MODEL 200 (PW JT9D - 7R4 ENGINE)

Printed in France

AIRPLANE CHARACTERISTICS FOR AIRPORT PLANNING

ESTIMATED PROVISIONAL VALUES

OCTAVE BAND CENTER FREQUENCY	OCTAVE BAND SPL dB (20 μ PA)		
	45° TO EXHAUST	40° TO EXHAUST	50° TO EXHAUST
63 Hz	108.2	110.5	106.3
125 Hz	109.4	110.9	108.1
250 Hz	107.2	107.7	106.7
500 Hz	103.4	103.3	103.4
1000 Hz	100.0	99.9	100.2
2000 Hz	98.7	98.3	102.5
4000 Hz	96.2	95.9	98.2
8000 Hz	97.9	96.7	100.1

GROUND STATIC
 TAKE OFF POWER
 100 METERS RADIUS
 45° LEVELS AVERAGE OF 40° AND 50° LEVELS

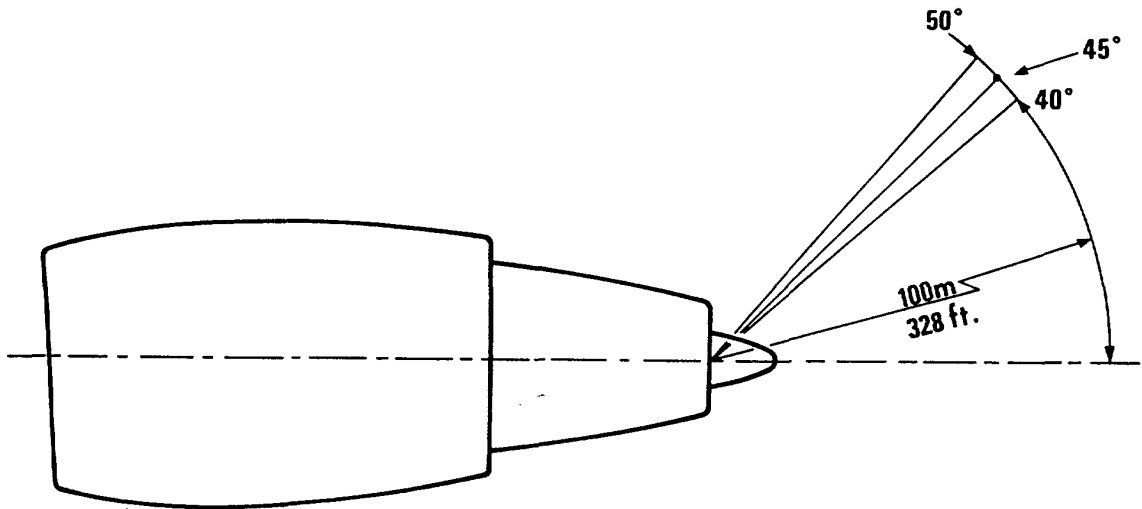

BA5 06 02 01 0 AEMO

6.2 AIRPORT AND COMMUNITY NOISE
 6.2.1 NOISE DATA
 MODEL 300 (PW 4000 SERIE ENGINE)

Chapter 6.2.1
 Page 3
 Oct 31/89

N

AIRPLANE CHARACTERISTICS FOR AIRPORT PLANNING

ESTIMATED PROVISIONAL VALUES

OCTAVE BAND CENTER FREQUENCY	OCTAVE BAND SPL, dB (20 μ PA)		
	45° TO EXHAUST	40° TO EXHAUST	50° TO EXHAUST
63 Hz	107.9	110.1	105.7
125 Hz	108.7	110.3	107.1
250 Hz	106.4	107.2	105.7
500 Hz	102.5	102.6	102.4
1000 Hz	96.5	96.1	96.8
2000 Hz	90.6	89.7	91.5
4000 Hz	95.2	93.9	96.5
8000 Hz	91.6	90.8	92.5

GROUND STATIC
 TAKEOFF POWER
 100 METERS RADIUS
 ISA + 10° C AND 70° HR
 SEA LEVEL

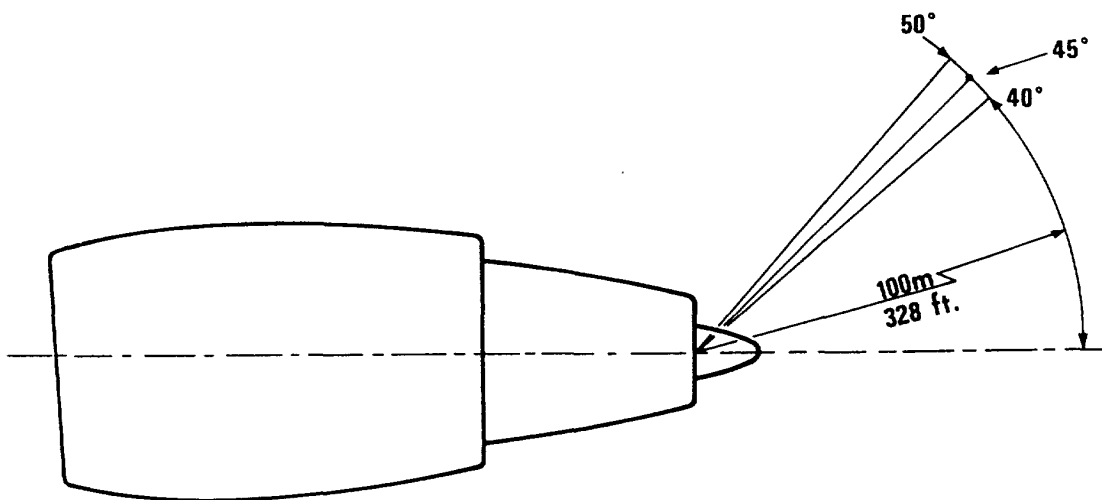





BA5 06 02 01 1 AGMO

6.2 AIRPORT AND COMMUNITY NOISE
 6.2.1 NOISE DATA
 MODEL 300 (GE CF6-80C2 SERIE ENGINE)

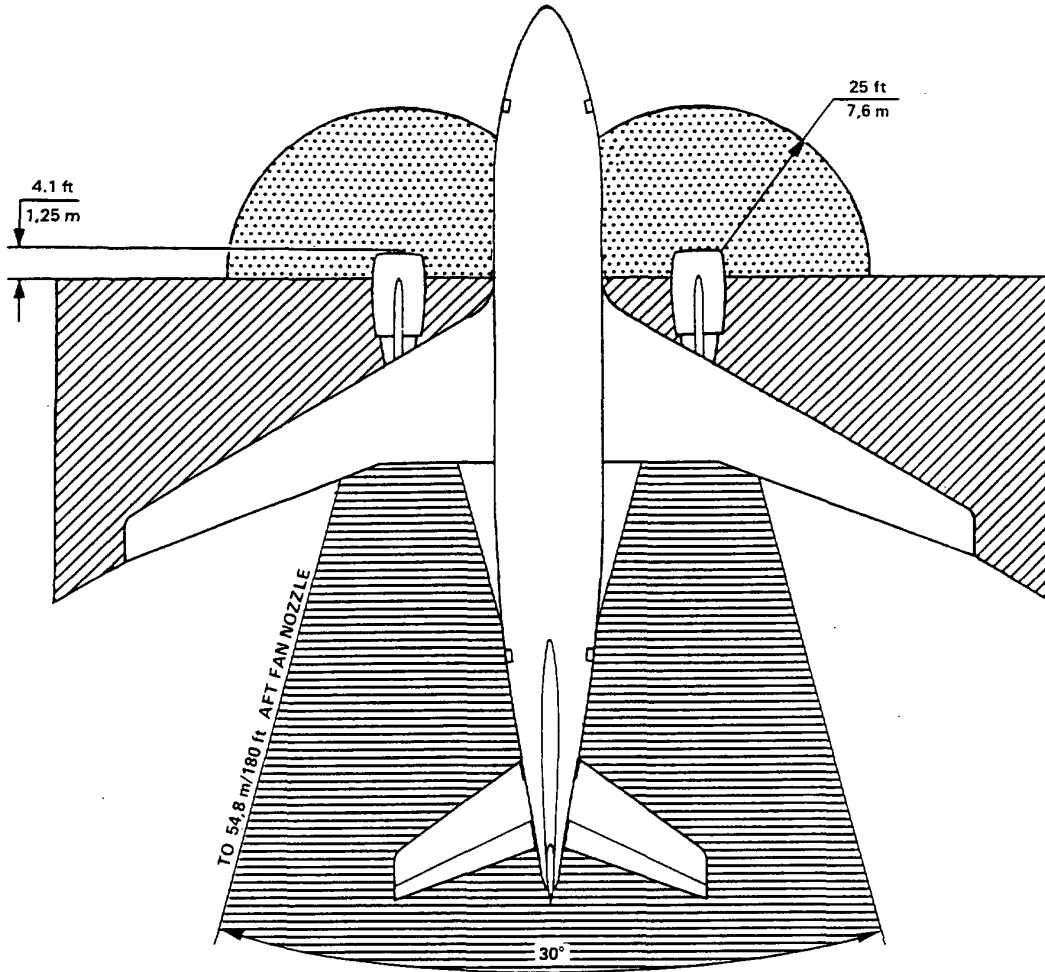
Chapter 6.2.1
 Page 4
 Oct 90

N



-  INTAKE SUCTION DANGER AREA GROUND IDLE
-  ENTRY CORRIDOR
-  SET WAKE AREA

BA5 06 03 01 AAMO

6.3 DANGER AREAS OF THE ENGINES
6.3.1 DANGER AREAS OF THE ENGINES
GROUND IDLE (GE CF6 80 ENGINE)

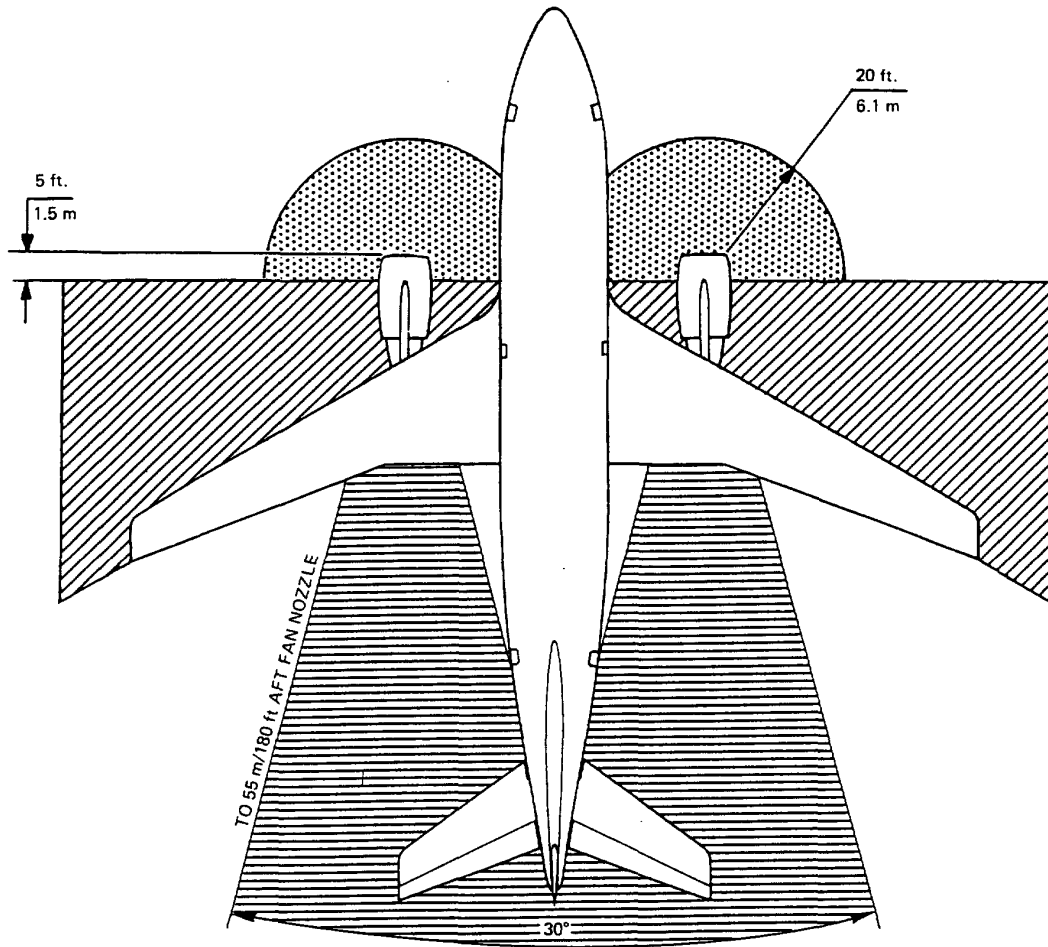

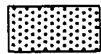
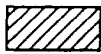
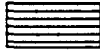
-  INLET SUCTION DANGER AREA GROUND IDLE
-  ENTRY CORRIDOR
-  EXHAUST WAKE DANGER

BA5 06 03 01 ACMO

6.3 DANGER AREAS OF THE ENGINES
6.3.1 DANGER AREAS OF THE ENGINES
GROUND IDLE (JT9D-7R4 ENGINE)

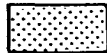
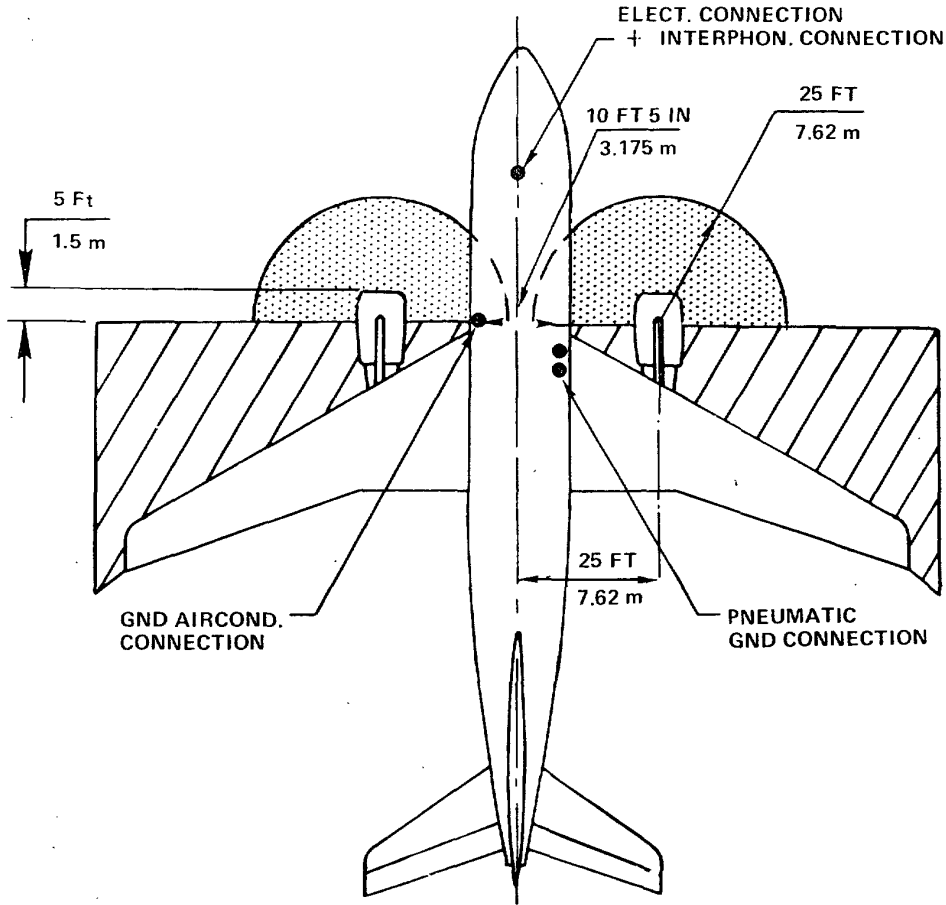

INLET SUCTION DANGER AREA GROUND IDLE



ENTRY CORRIDOR

L-A1138

BA5 06 03 01 0 AEMO

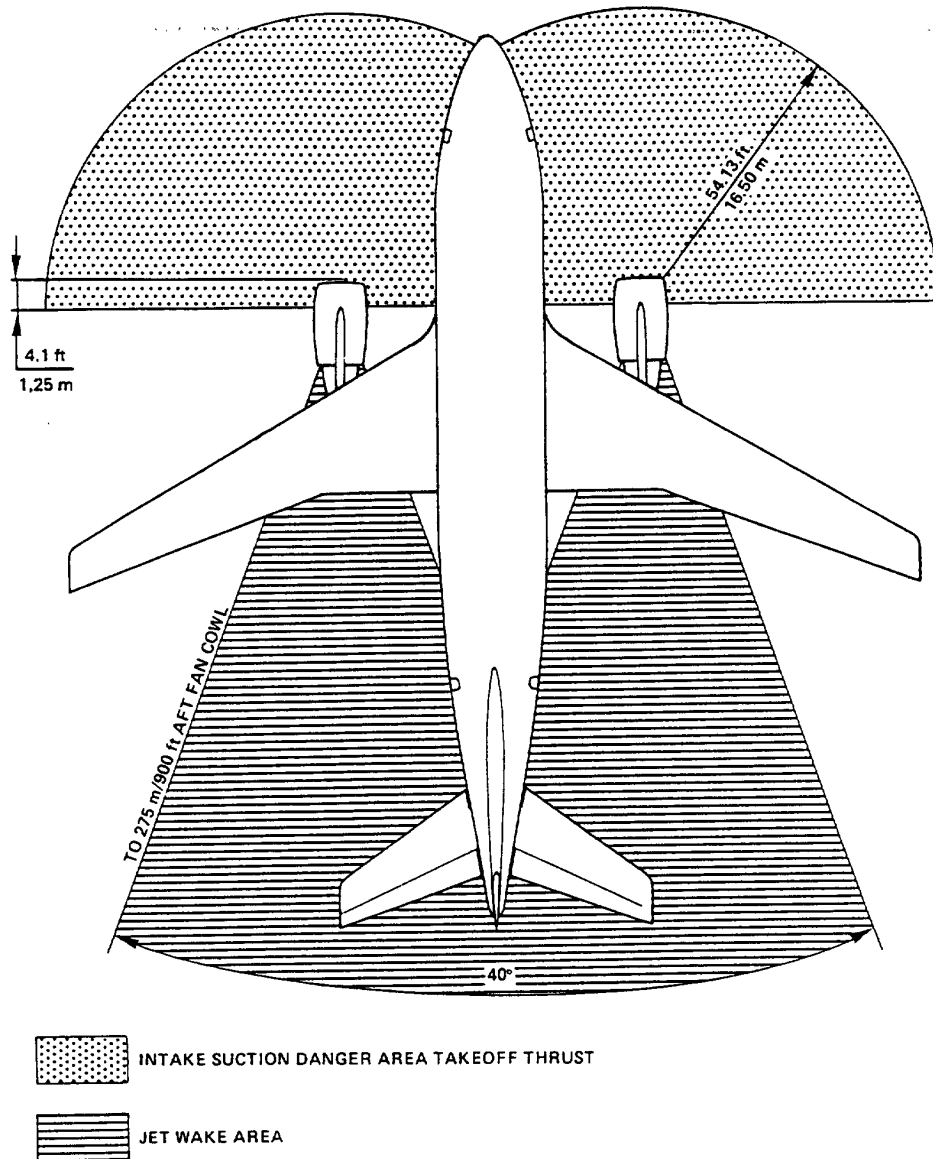

6.3 DANGER AREAS OF THE ENGINES
 6.3.1 DANGER AREAS OF THE ENGINES
 GROUND IDLE
 (PW 4000 ENGINE)

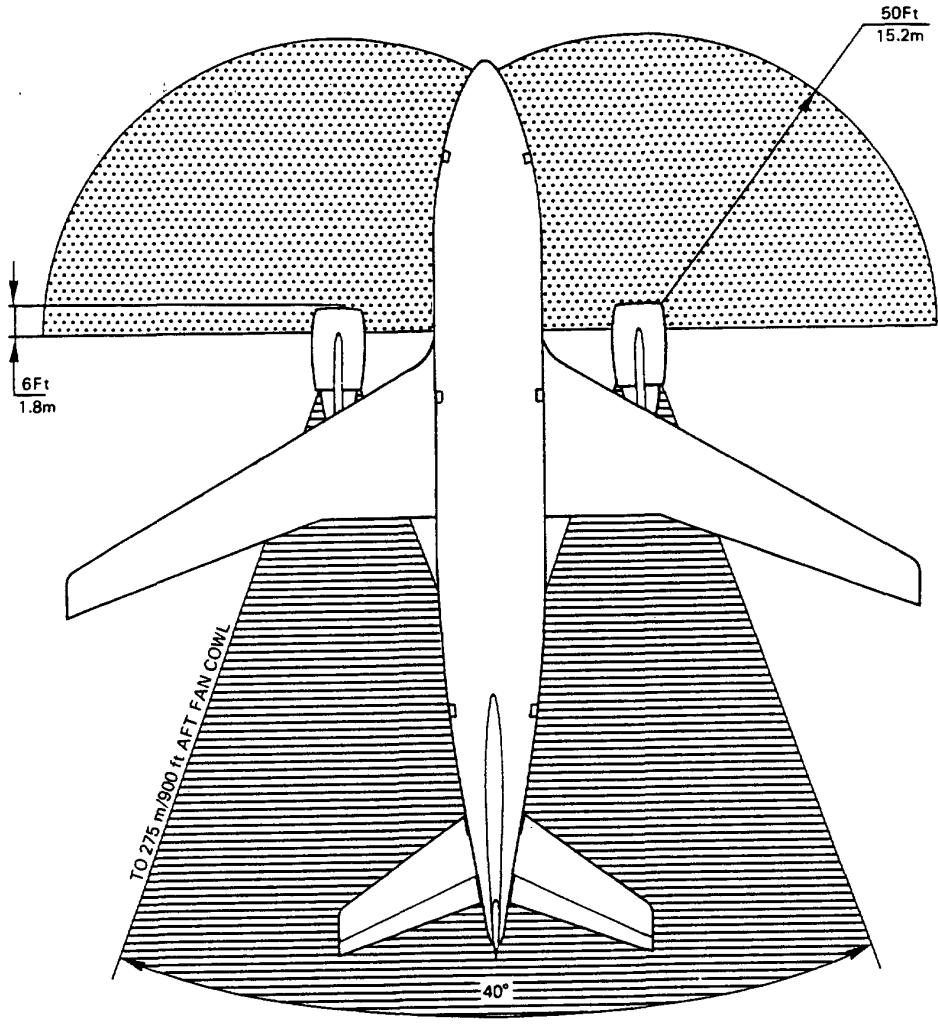

BA5 06 03 02 AAMO

6.3 DANGER AREAS OF THE ENGINES
6.3.2 DANGER AREAS OF THE ENGINES (TAKEOFF)
(GE CF6-80 ENGINE)



-  INLET SUCTION DANGER AREA TAKE OFF THRUST
-  EXHAUST WAKE DANGER

BA5 06 03 02 ACMD

6.3 DANGER AREAS OF THE ENGINES
6.3.2 DANGER AREAS OF THE ENGINES (TAKEOFF)
(JT9D-7R4 ENGINE)

Chapter 6.3.2
 Page 2
 Apr 86

R

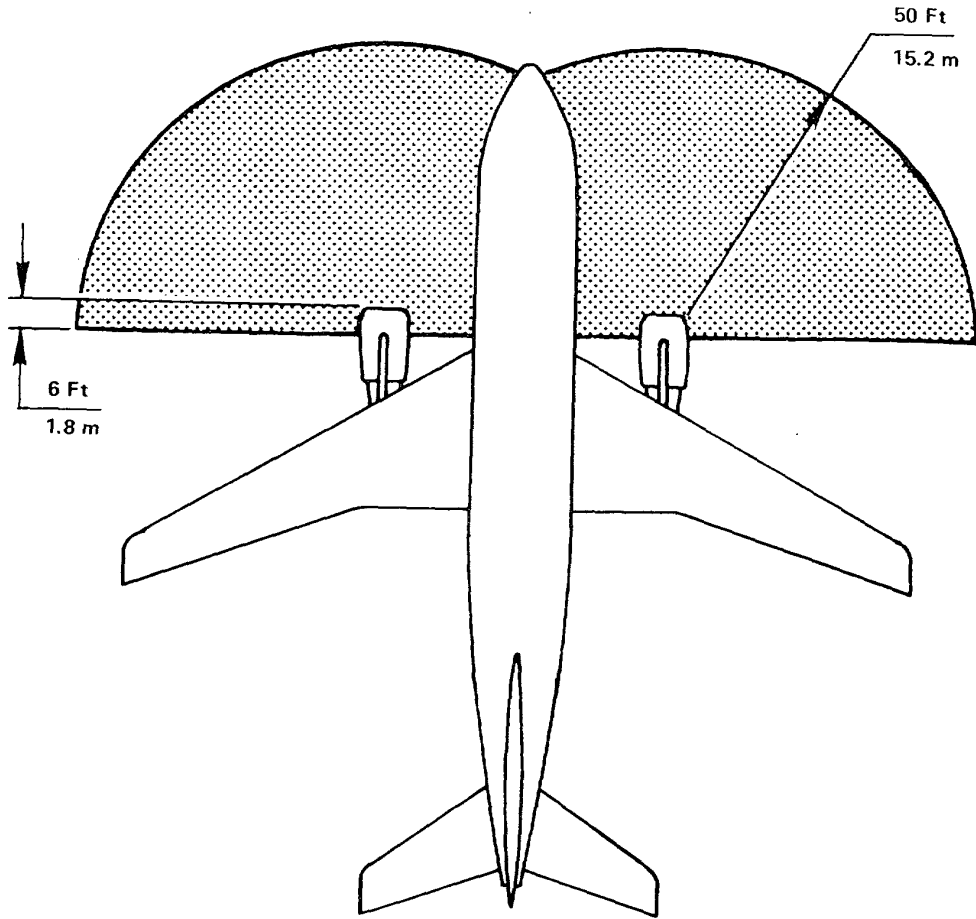

INLET SUCTION DANGER AREA TAKE-OFF THRUST

BAS 06 03 02 0 AEMO

L-A1139

6.3 DANGER AREAS OF THE ENGINES
6.3.2 DANGER AREAS OF THE ENGINES
TAKE-OFF
(PW 4000 ENGINE)

Chapter 6.3.2
Page 3
Oct 87

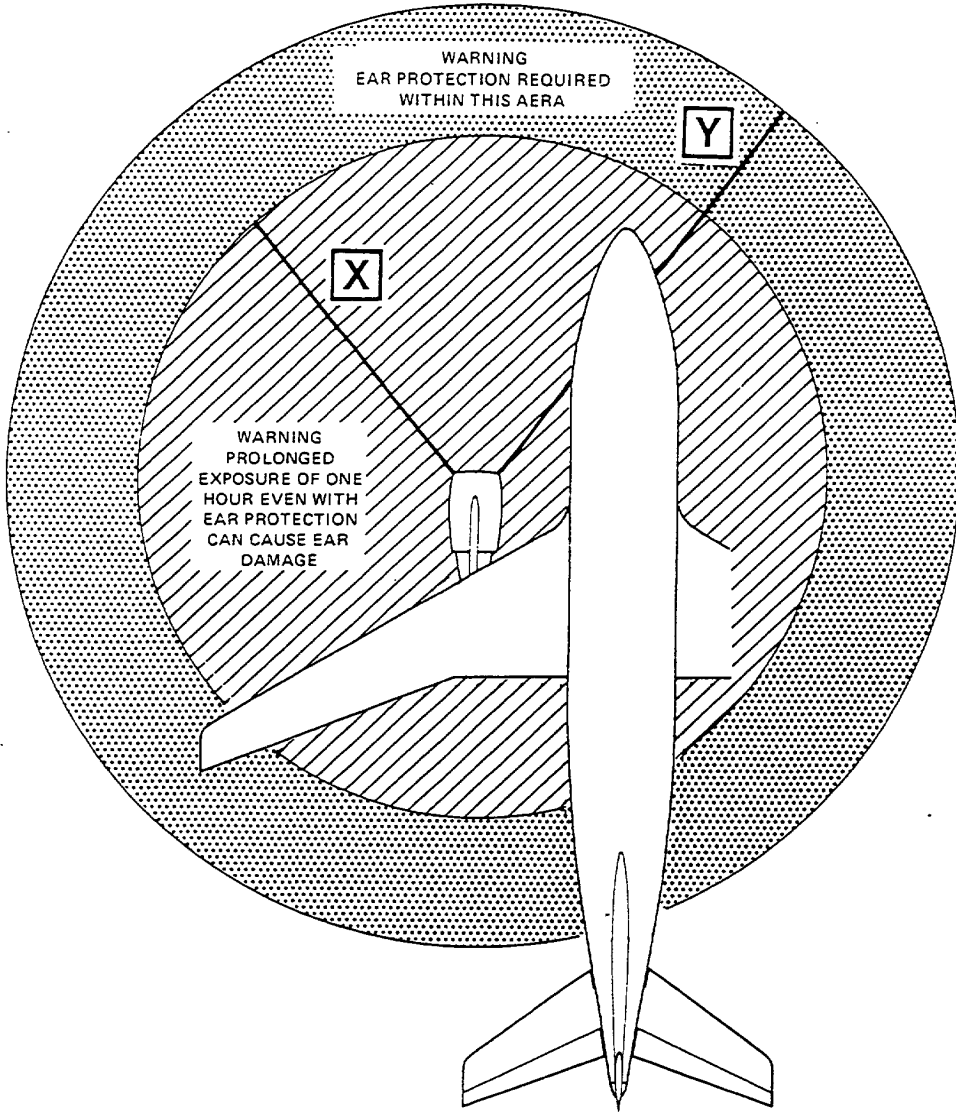

POWER SETTING	RADIUS X	RADIUS Y
GROUND IDLE	75 Ft (23 m)	100 Ft (30 m)
BREAK AWAY	90 Ft (27 m)	115 Ft (35 m)
TAKE-OFF	125 Ft (38 m)	200 Ft (60 m)

BA5 06 03 03 0 AAM0

6.3 DANGER AREAS OF THE ENGINES
6.3.3 ACOUSTIC PROTECTION AREAS
(PW ENGINES)

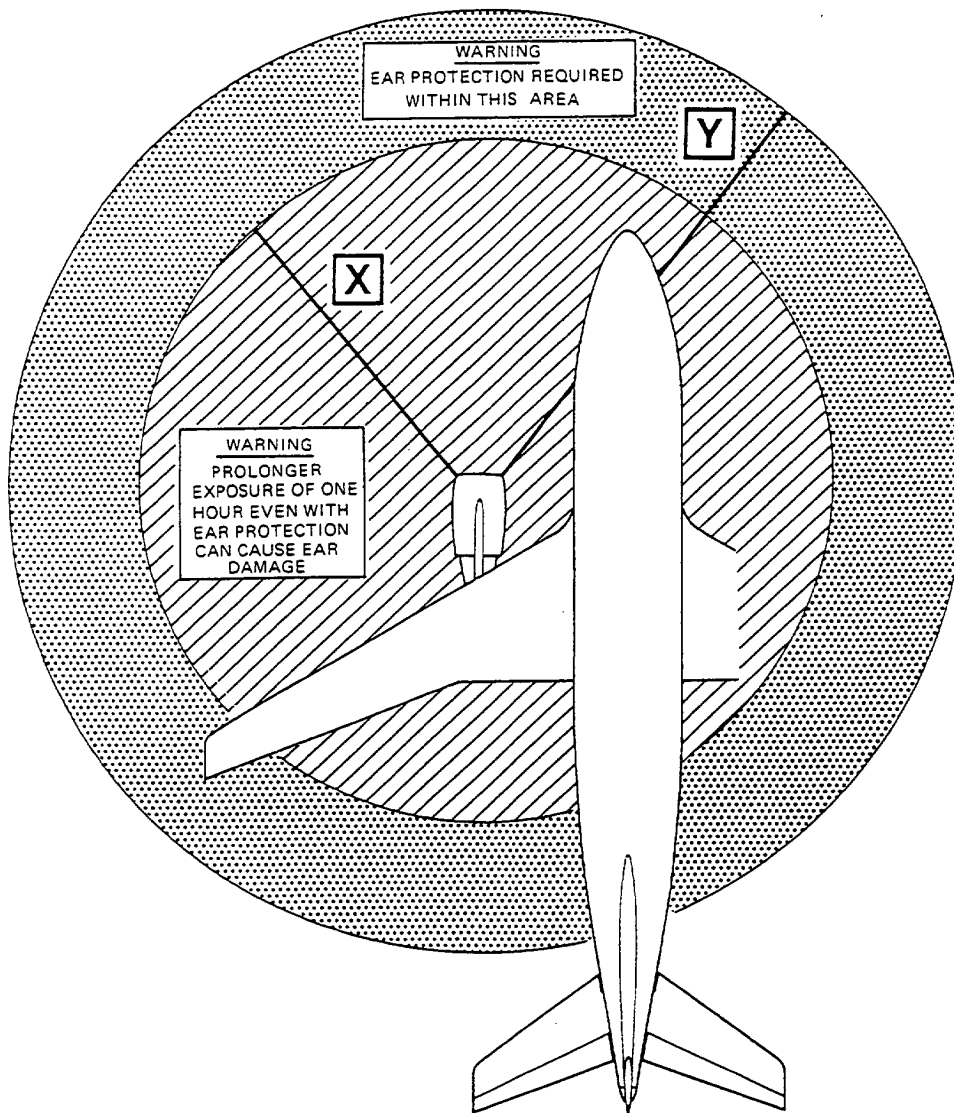

POWER SETTING	RADIUS X	RADIUS Y
GROUND IDLE	23m (75 ft.)	30m (100. ft)
BREAK AWAY	30m (100 ft.)	46m (150 ft.)
TAKE - OFF	30m (100 ft.)	61m (200 ft.)

NOTE : BASED ON UNINSTALLED ENGINE

6.3 DANGER AREAS OF THE ENGINES 6.3.3 ACOUSTIC PROTECTION AREAS (GE CF6-80 ENGINE)

AIRPLANE CHARACTERISTICS FOR AIRPORT PLANNING

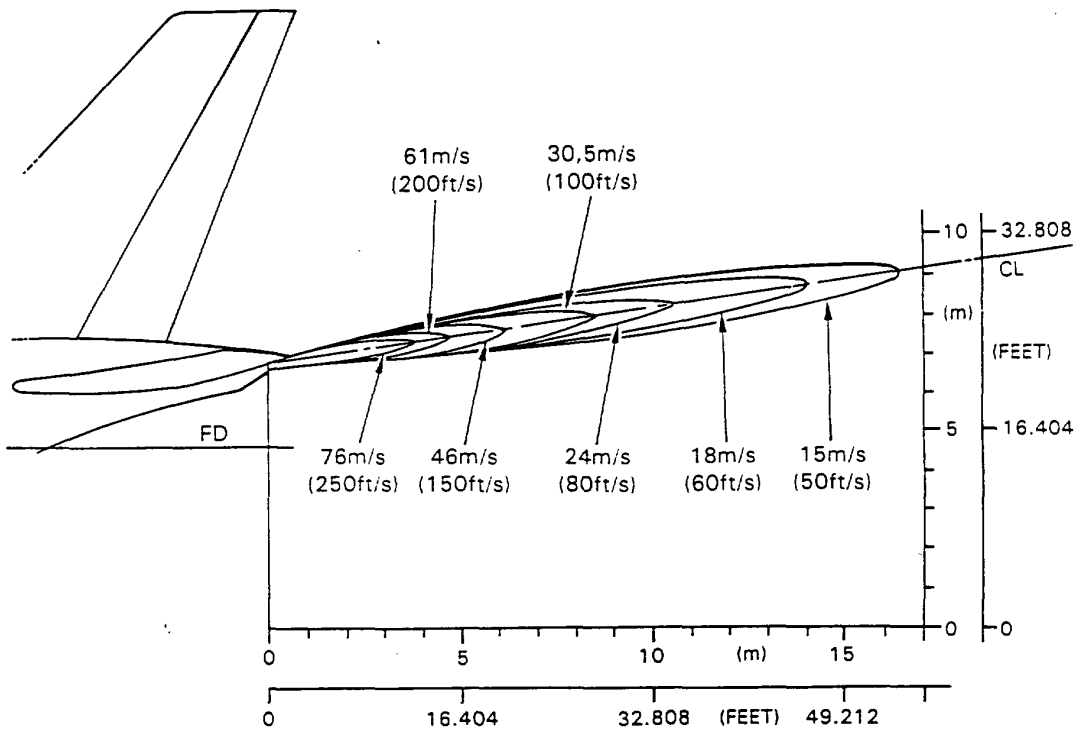
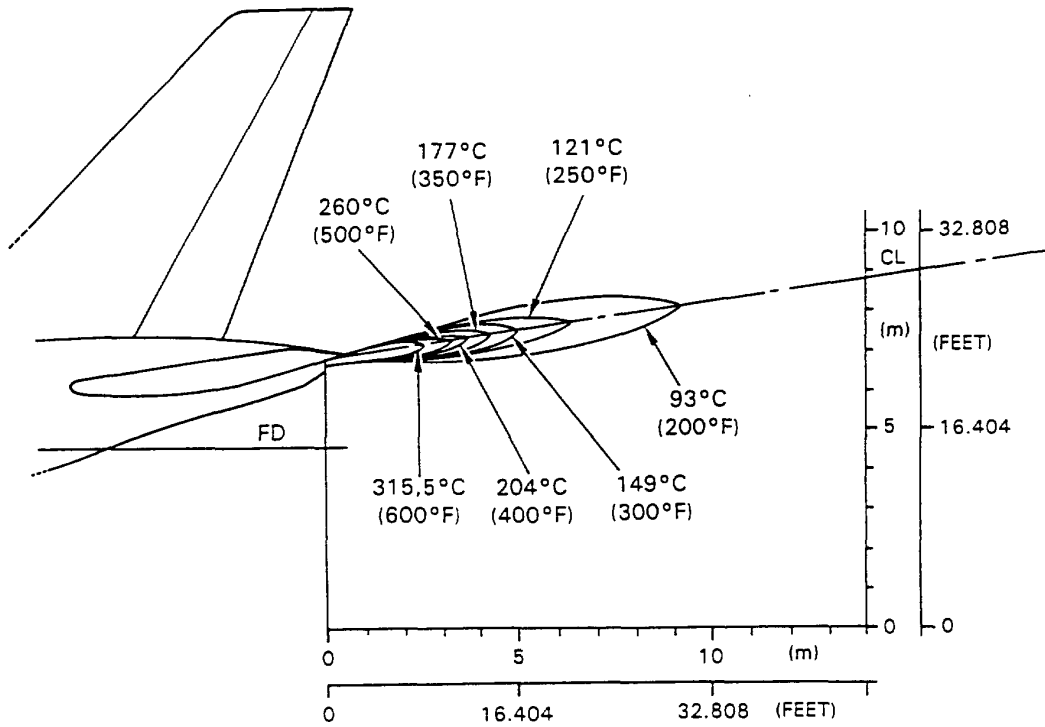

**APU - Exhaust Gas temperature & Velocity
DECAY - APU**

AIRPLANE CHARACTERISTICS FOR AIRPORT PLANNING**7.0 PAVEMENT DATA****7.1 General Information****7.2 Landing Gear Footprint****7.3 Maximum Pavement Loads****7.4 LG Loading on Pavement****7.4.1 LG Loading on Pavement****7.5 Flexible Pavement Requirements U.S. Army****7.5.1 Flexible Pavement Requirements****7.6 Flexible Pavement Requirements LCN****7.6.1 Flexible Pavement Requirements LCN****7.7 Rigid Pavement Requirements PCA****7.7.1 Rigid Pavement Requirements PCA****7.8 Rigid Pavement Requirements LCN****7.8.1 Radius of Relative Stiffness - Inches****7.8.2 Rigid Pavement Requirements LCN****7.8.3 Radius of Relative Stiffness - Other values****7.8.4 Radius of Relative Stiffness - Other values****7.9 ACN-PCN Reporting System****7.9.1 ACN Number Flexible Pavement****7.9.2 ACN Number Rigid Pavement**



AIRPLANE CHARACTERISTICS FOR AIRPORT PLANNING

PAVEMENT DATA

7.1 General Information

1. General Information

-A310-200 Models - A310-300 Models

A brief description of the pavement charts that follow will help in airport planning.

To aid in the interpolation between the discrete values shown, each airplane configuration is shown with a minimum range of five loads on the main landing gear.

All curves on the charts represent data at a constant specified tire pressure with :

- the airplane loaded to the maximum ramp weight.
- the CG at its maximum permissible aft position.

Pavement requirements for commercial airplanes are derived from the static analysis of loads imposed on the main landing gear struts.

Section 7.2, presents basic data on the landing gear footprint configuration, maximum ramp weights and tire sizes and pressures.

Section 7.3, shows maximum vertical and horizontal pavement loads for certain critical conditions at the tire-ground interfaces.

Section 7.4.1 contains charts to find these loads throughout the stability limits of the airplane at rest on the pavement.

These main landing gear loads are used as the point of entry to the pavement design charts which follow, interpolating load values where necessary.

Section 7.5.1 uses procedures in Instruction Report No. S-77-1 "Procedures for Development of CBR Design Curves", dated June 1977 to show flexible pavement design curves.

The report was prepared by the U.S. Army Corps Engineers Waterways Experiment Station, Soils and Pavement Laboratory, Vicksburg, Mississippi.

Section 7.5.1 & 7.9.1 uses the new load repetition factor according to the ICAO letter Reference AN 4/20.1-EB/07/26.

AIRPLANE CHARACTERISTICS FOR AIRPORT PLANNING

The line showing 10 000 coverages is used to calculate Aircraft Classification Number (ACN).

2. Flexible Pavement

The procedure that follows is used to develop flexible pavement design curves such as shown in Section 7.5.1.

- A. With the scale for pavement thickness at the bottom and the scale for CBR at the top, an arbitrary line is drawn representing 10 000 coverages.
- B. Incremental values of the weight on the main landing gear are then plotted.
- C. Annual departure line are drawn based on the load lines of the weight on the main landing gear that is shown on the graph.

Section 7.7.1 gives the rigid pavement design curves that have been prepared with the use of the Westergaard Equation. This is in general accordance with the procedures outlined in the Portland Cement Association publications, "Design of Concrete Airport Pavement", 1973 and "Computer Program for Airport Pavement Design", (Program PDILB), 1967 both by Robert G. Packard.

3. Rigid Pavement

The procedure that follows is used to develop rigid pavement design curves such as those shown in Section 7.7.1.

- A. With the scale for pavement thickness on the left and the scale for allowable working stress on the right, an arbitrary line load line is drawn. This represents the main landing gear maximum weight to be shown.
- B. All values of the subgrade modulus (k values) are then plotted.
- C. Additional load lines for the incremental values of weight on the main landing gear are drawn on the basis of the curve for $k = 80 \text{ MN/m}^3$ already shown on the graph.

All Load Classification Number (LCN) curves shown in Section 7.6.1 and Section 7.8.2 have been developed from a computer program based on data provided in International Civil Aviation Organisation (ICAO) document 7920-AN/865/2, Aerodrome Manual, Part 2, "Aerodrome Physical Characteristics", Second Edition, 1965.

AIRPLANE CHARACTERISTICS FOR AIRPORT PLANNING

The flexible pavement charts in Section 7.6.1 show LCN against equivalent single wheel load, and equivalent single wheel load against pavement thickness.

The rigid pavement charts in Section 7.8.2 show LCN against equivalent single wheel load, and equivalent single wheel load against radius of relative stiffness.

Section 7.9 provides ACN data prepared according to the ACN/PCN system as referenced in ICAO Annex 14, "Aerodromes", Volume 1 "Aerodrome Design and Operations".

Fourth Edition July 2004, incorporating Amendments 1 to 6.

The ACN/PCN system provides a standardized international airplane/pavement rating system replacing the various S, T, TT, LCN, AUW, ISWL, etc., rating systems used throughout the world.

ACN is the Aircraft Classification Number and PCN is the corresponding Pavement Classification Number.

An aircraft having an ACN equal to or less than the PCN can operate without restriction on the pavement.

Numerically the ACN is two times the derived single wheel load expressed in thousands of kilograms.

The derived single wheel load is defined as the load on a single tire inflated to 1.25 Mpa (181 psi) that would have the same pavement requirements as the aircraft.

Computationally the ACN/PCN system uses PCA program PDILB for rigid pavements and S-77-1 for flexible pavements to calculate ACN values. The Airport Authority must decide on the method of pavement analysis and the results of their evaluation shown as follows :

PCN			
PAVEMENT TYPE	SUBGRADE CATEGORY	TIRE PRESSURE CATEGORY	EVALUATION METHOD
R - Rigid F - Flexible	A - High B - Medium C - Low D - Ultra Low	W - No Limit X - To 1.5 Mpa (217 psi) Y - To 1 Mpa (145 psi) Z - To 0.5 Mpa (73 psi)	T - Technical U - Using Aircraft

AIRPLANE CHARACTERISTICS FOR AIRPORT PLANNING

Section 7.9.1 shows the aircraft ACN values for flexible pavements.

The four subgrade categories are :

A	High Strength	CBR 15
B	Medium Strength	CBR 10
C	Low Strength	CBR 6
D	Ultra Low Strength	CBR 3

Section 7.9.2 shows the aircraft ACN for rigid pavements.

The four subgrade categories are :

A	High Strength	Subgrade k = 150 MN/m ³ (550 pci)
B	Medium Strength	Subgrade k = 80 MN/m ³ (300 pci)
C	Low Strength	Subgrade k = 40 MN/m ³ (150 pci)
D	Ultra Low Strength	Subgrade k = 20 MN/m ³ (75 pci)

AIRPLANE CHARACTERISTICS FOR AIRPORT PLANNING

MAXIMUM RAMP WEIGHT	132 900 kg (293 000 lb)	
PERCENTAGE OF WEIGHT ON MAIN GEAR GROUP	See Section 7-4-1 MRW 132 900 kg	
NOSE GEAR TIRE SIZE	40 x 14 -16 or 40 x 14 R16	
NOSE GEAR TIRE PRESSURE	10 bar (145 psi)	
WING GEAR TIRE SIZE	46 x 16 - 20 or 46 x 17 R20	49 x 17 - 20
WING GEAR TIRE PRESSURE	12.3 bar (178 psi)	10.2 bar (148 psi)

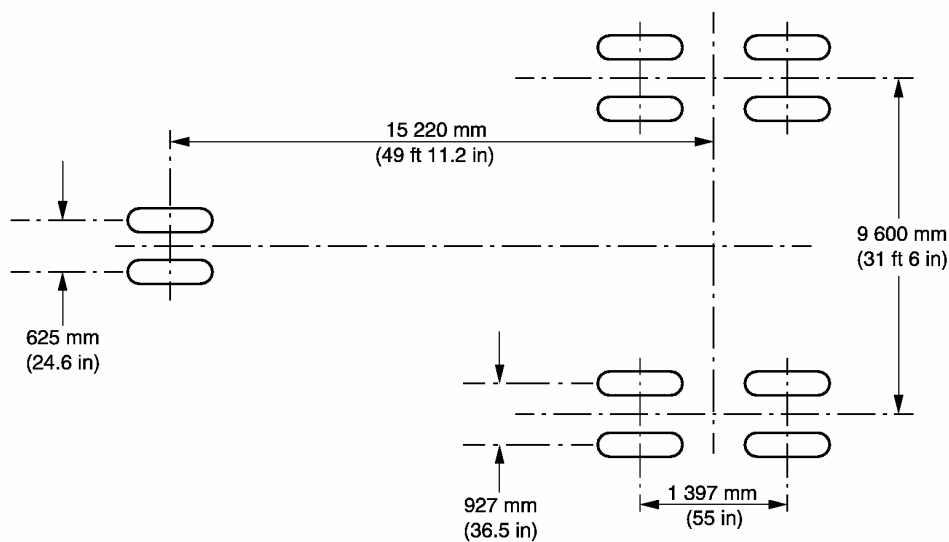

NOTE: DIMENSIONS IN MILLIMETERS
(FEET AND INCHES IN BRACKETS).

BA5 07 02 00 1 AAM0 01

Landing Gear Footprint
A310-200 Models - MRW 132 900 kg

AIRPLANE CHARACTERISTICS FOR AIRPORT PLANNING

MAXIMUM RAMP WEIGHT	139 500 kg (307 550 lb)	
PERCENTAGE OF WEIGHT ON MAIN GEAR GROUP	See Section 7-4-1 MRW 139 500 kg	
NOSE GEAR TIRE SIZE	40 x 14 -16 or 40 x 14 R16	
NOSE GEAR TIRE PRESSURE	10.3 bar (149 psi)	
WING GEAR TIRE SIZE	46 x 16 - 20 or 46 x 17 R20	49 x 17 - 20
WING GEAR TIRE PRESSURE	13 bar (189 psi)	10.8 bar (157 psi)

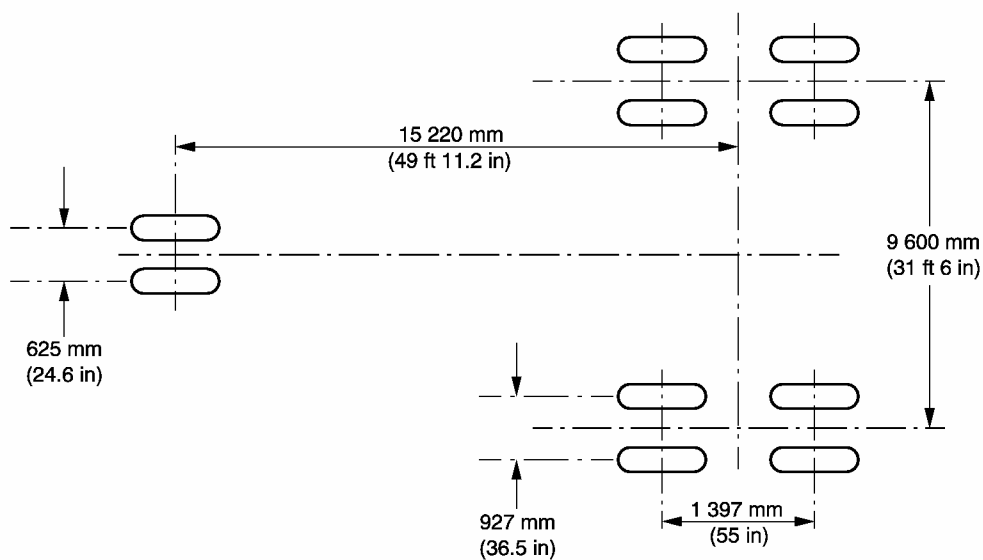

NOTE: DIMENSIONS IN MILLIMETERS
(FEET AND INCHES IN BRACKETS).

BA5 07 02 00 1 ACIM0 00

Landing Gear Footprint
A310-200 Models - MRW 139 500 kg

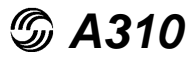

AIRPLANE CHARACTERISTICS FOR AIRPORT PLANNING

MAXIMUM RAMP WEIGHT	142 900 kg (315 050 lb)	
PERCENTAGE OF WEIGHT ON MAIN GEAR GROUP	See Section 7-4-1 MRW 142 900 kg	
NOSE GEAR TIRE SIZE	40 x 14 -16 or 40 x 14 R16	
NOSE GEAR TIRE PRESSURE	11 bar (160 psi)	
WING GEAR TIRE SIZE	46 x 16 - 20 or 46 x 17 R20	49 x 17 - 20
WING GEAR TIRE PRESSURE	13.3 bar (193 psi)	11 bar (160 psi)

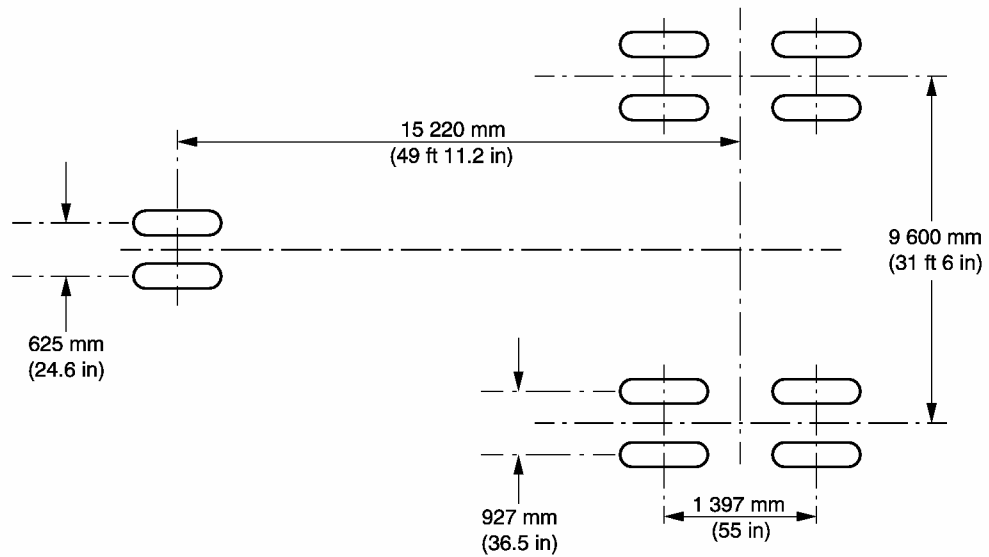

NOTE: DIMENSIONS IN MILLIMETERS
(FEET AND INCHES IN BRACKETS).

BA5 07 02 00 1 AEM0 00

Landing Gear Footprint
A310-200 Models - MRW 142 900 kg

Chapter 7.2
Page 3
DEC 01/09

N



AIRPLANE CHARACTERISTICS FOR AIRPORT PLANNING

MAXIMUM RAMP WEIGHT	139 500 kg (307 550 lb)	
PERCENTAGE OF WEIGHT ON MAIN GEAR GROUP	See Section 7-4-1 MRW 139 500 kg	
NOSE GEAR TIRE SIZE	40 x 14 -16 or 40 x 14 R16	
NOSE GEAR TIRE PRESSURE	11.3 bar (164 psi)	
WING GEAR TIRE SIZE	46 x 16 - 20 or 46 x 17 R20	49 x 17 - 20
WING GEAR TIRE PRESSURE	13.2 bar (191 psi)	11 bar (160 psi)

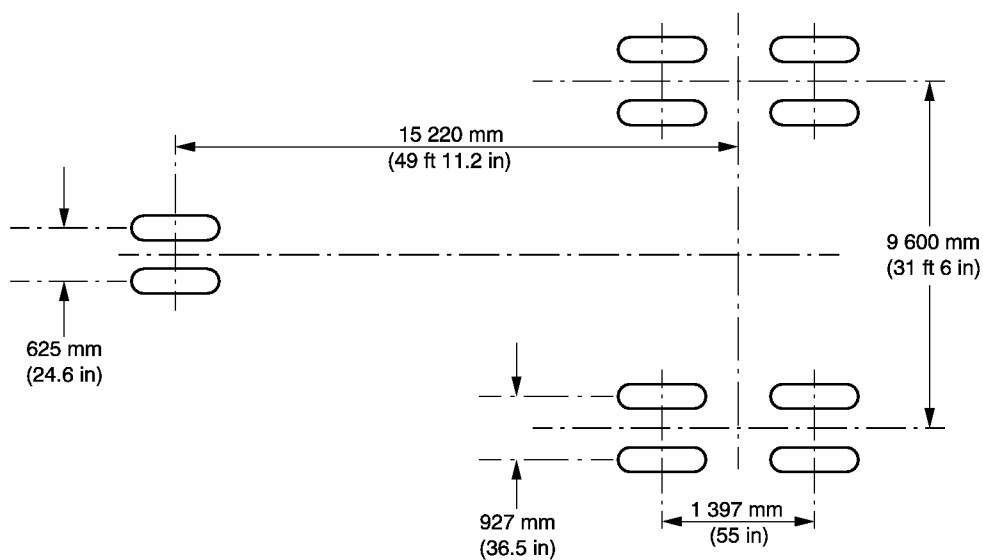

NOTE: DIMENSIONS IN MILLIMETERS
(FEET AND INCHES IN BRACKETS).

BA5 07 02 00 1 AGM0 00

Landing Gear Footprint
A310-300 Models - MRW 139 500 kg

Chapter 7.2
Page 4
DEC 01/09

AIRPLANE CHARACTERISTICS FOR AIRPORT PLANNING

MAXIMUM RAMP WEIGHT	150 900 kg (332 675 lb)	
PERCENTAGE OF WEIGHT ON MAIN GEAR GROUP	See Section 7-4-1 MRW 150 900 kg	
NOSE GEAR TIRE SIZE	40 x 14 -16 or 40 x 14 R16	
NOSE GEAR TIRE PRESSURE	11.3 bar (164 psi)	
WING GEAR TIRE SIZE	46 x 16 - 20 or 46 x 17 R20	49 x 17 - 20
WING GEAR TIRE PRESSURE	14.3 bar (207 psi)	11.9 bar (173 psi)

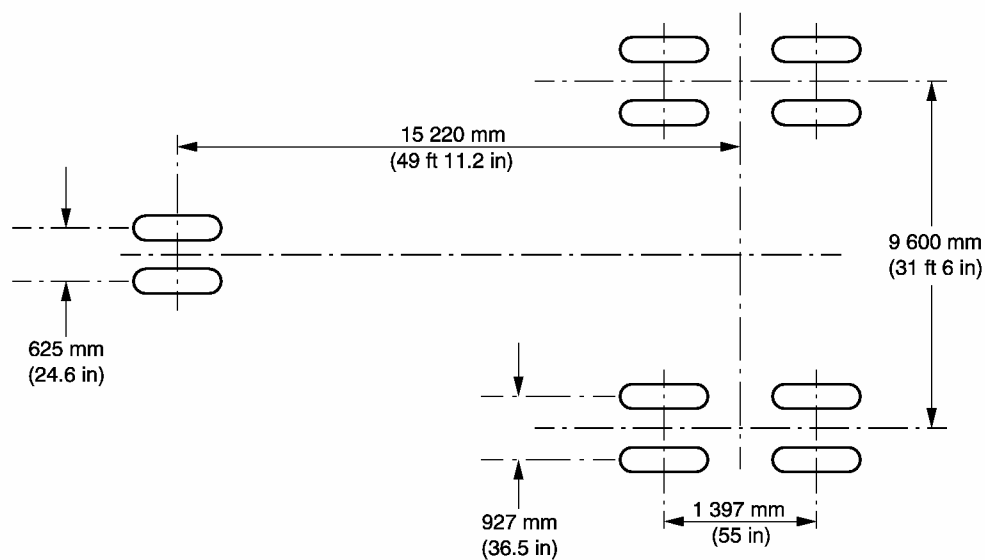

NOTE: DIMENSIONS IN MILLIMETERS
(FEET AND INCHES IN BRACKETS).

BA5 07 02 00 1 AJM0 00

Landing Gear Footprint
A310-300 Models - MRW 150 900 kg

AIRPLANE CHARACTERISTICS FOR AIRPORT PLANNING

MAXIMUM RAMP WEIGHT	153 900 kg (339 300 lb)	
PERCENTAGE OF WEIGHT ON MAIN GEAR GROUP	See Section 7-4-1 MRW 153 900 kg	
NOSE GEAR TIRE SIZE	40 x 14 -16 or 40 x 14 R16	
NOSE GEAR TIRE PRESSURE	11.3 bar (164 psi)	
WING GEAR TIRE SIZE	46 x 16 - 20 or 46 x 17 R20	49 x 17 - 20
WING GEAR TIRE PRESSURE	14.6 bar (212 psi)	12 bar (174 psi)

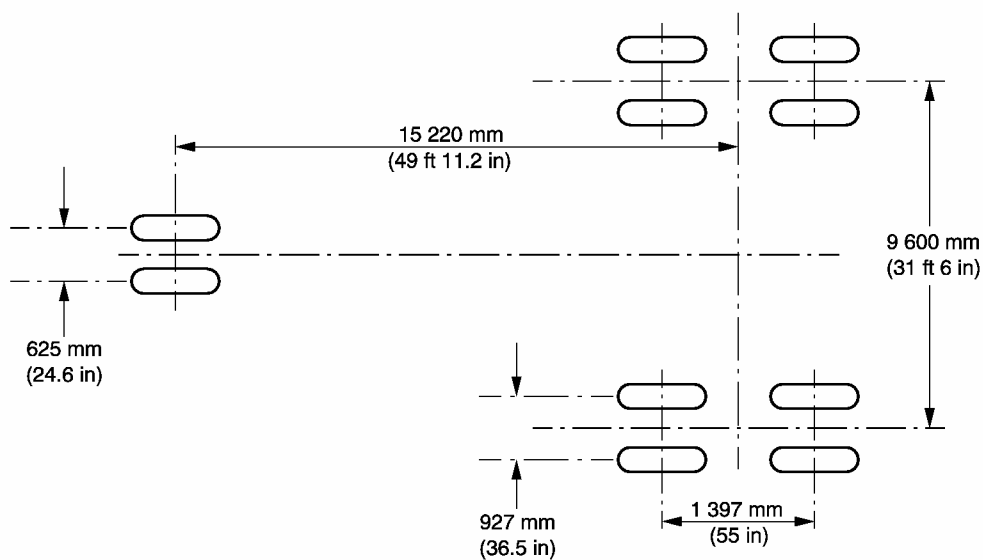

NOTE: DIMENSIONS IN MILLIMETERS
(FEET AND INCHES IN BRACKETS).

BA5 07 02 00 1 ALM0 00

Landing Gear Footprint
A310-300 Models - MRW 153 900 kg

AIRPLANE CHARACTERISTICS FOR AIRPORT PLANNING

MAXIMUM RAMP WEIGHT	157 900 kg (348 100 lb)	
PERCENTAGE OF WEIGHT ON MAIN GEAR GROUP	See Section 7-4-1 MRW 157 900 kg	
NOSE GEAR TIRE SIZE	40 x 14 -16 or 40 x 14 R16	40 x 14 R16 P/N M11701
NOSE GEAR TIRE PRESSURE	11.3 bar (164 psi)	12.3 bar (178 psi)
WING GEAR TIRE SIZE	46 x 16 - 20 or 46 x 17 R20	49 x 17 - 20
WING GEAR TIRE PRESSURE	14.8 bar (215 psi)	12.4 bar (180 psi)

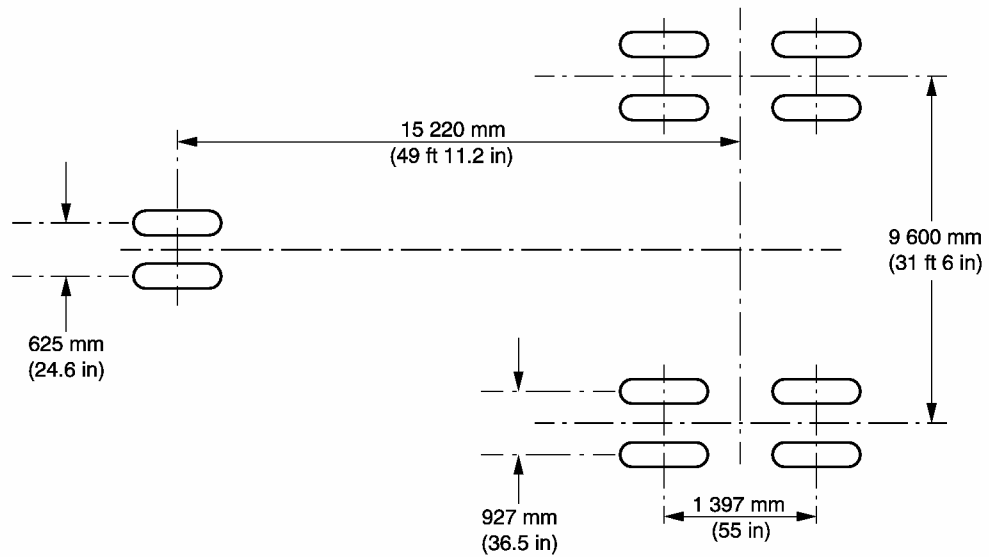

NOTE: DIMENSIONS IN MILLIMETERS
(FEET AND INCHES IN BRACKETS).

BA5 07 02 00 1 ANM0 00

Landing Gear Footprint
A310-300 Models - MRW 157 900 kg

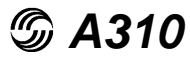

AIRPLANE CHARACTERISTICS FOR AIRPORT PLANNING

MAXIMUM RAMP WEIGHT	160 900 kg (354 725 lb)
PERCENTAGE OF WEIGHT ON MAIN GEAR GROUP	See Section 7-4-1 MRW 160 900 kg
NOSE GEAR TIRE SIZE	40 x 14 -16 or 40 x 14 R16
NOSE GEAR TIRE PRESSURE	11.3 bar (164 psi)
WING GEAR TIRE SIZE	49 x 17 - 20
WING GEAR TIRE PRESSURE	12.6 bar (183 psi)

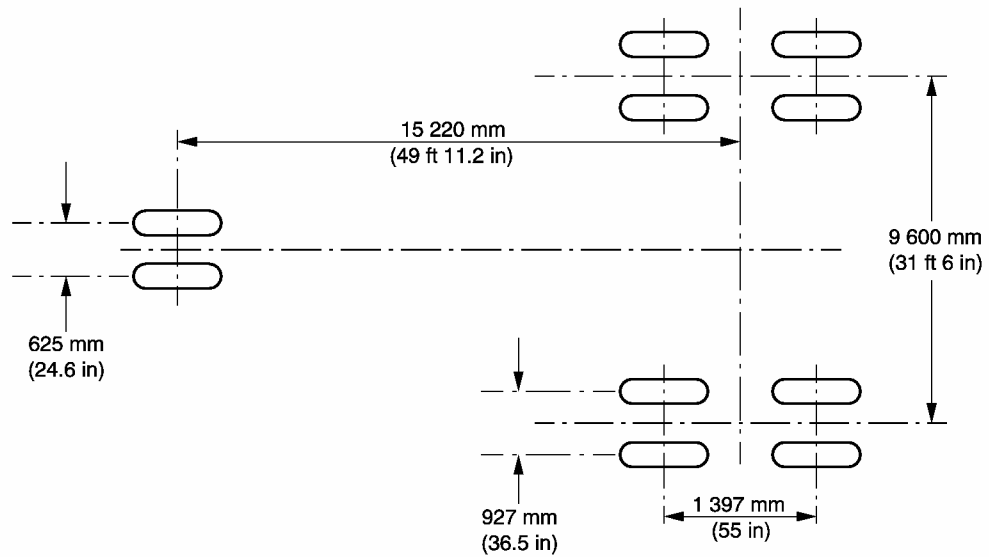

NOTE: DIMENSIONS IN MILLIMETERS
(FEET AND INCHES IN BRACKETS).

BA5 07 02 00 1 AQM0 00

Landing Gear Footprint
A310-300 Models - MRW 160 900 kg

AIRPLANE CHARACTERISTICS FOR AIRPORT PLANNING

MAXIMUM RAMP WEIGHT	164 900 kg (363 550 lb)
PERCENTAGE OF WEIGHT ON MAIN GEAR GROUP	See Section 7-4-1 MRW 164 900 kg
NOSE GEAR TIRE SIZE	40 x 14 -16 or 40 x 14 R16
NOSE GEAR TIRE PRESSURE	11.3 bar (164 psi)
WING GEAR TIRE SIZE	49 x 17 - 20
WING GEAR TIRE PRESSURE	12.9 bar (187 psi)

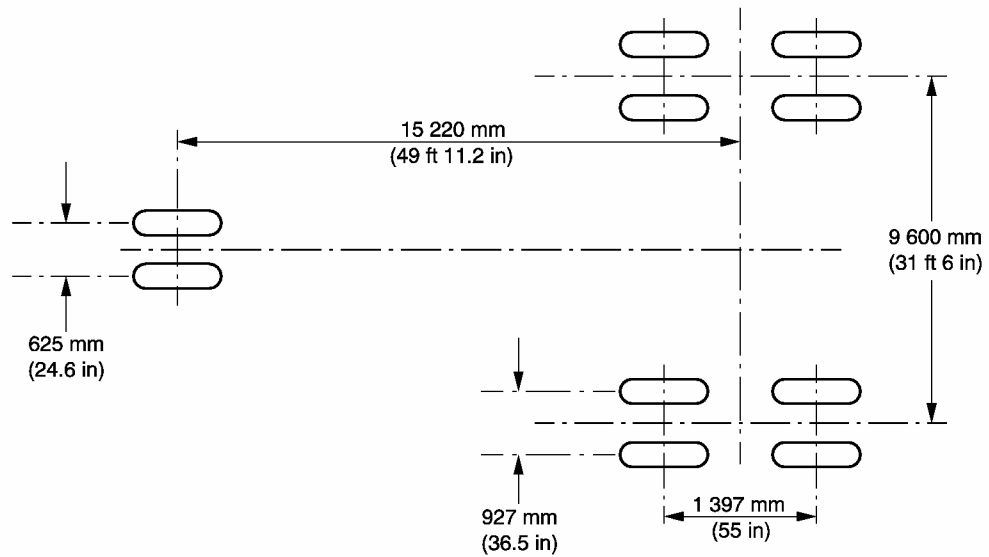

NOTE: DIMENSIONS IN MILLIMETERS
(FEET AND INCHES IN BRACKETS).

BA5 07 02 00 1 ASMD 00

Landing Gear Footprint
A310-300 Models - MRW 164 900 kg

AIRPLANE CHARACTERISTICS FOR AIRPORT PLANNING

BA5 07 03 00 1 AAM0 00

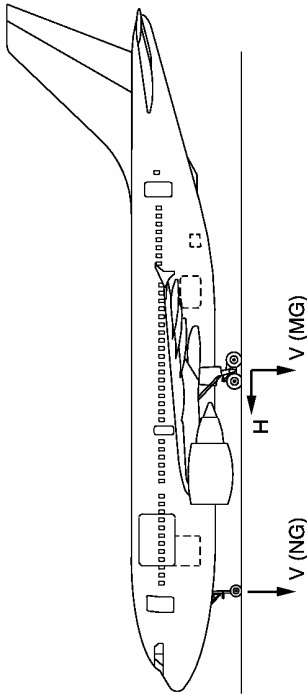

1	2		3		4		5		6			
	MAXIMUM RAMP WEIGHT		STATIC LOAD AT MOST FWD C.G. (1)		STATIC BRAKING @ 10 ft/s ² DECELERATION		STATIC LOAD AT MAX AFT C.G. (2)		STEADY BRAKING @ 10 ft/s ² DECELERATION		AT INSTANTANEOUS BRAKING COEFFICIENT = 0.8	
MODEL	lb	kg	lb	kg	lb	kg	lb	kg	lb	kg	lb	kg
-200	293 000	132 900	38 700	17 560	63 400	28 760	136 675	62 000	45 525	20 650	109 350	49 600
-200	307 550	139 500	40 625	18 430	66 550	30 180	143 475	65 080	47 800	21 680	114 775	52 060
-200	315 050	142 900	41 625	18 880	68 175	30 920	146 975	66 660	48 950	22 210	117 575	53 330

V (NG) MAXIMUM VERTICAL NOSE GEAR GROUND LOAD AT MOST FORWARD CG
 V (MG) MAXIMUM VERTICAL MAIN GEAR GROUND LOAD AT MOST AFT CG
 H MAXIMUM HORIZONTAL GROUND LOAD FROM BRAKING

- (1) MRW = 132 900 kg FWD CG = 18% MAC AT A/C WEIGHT = 132 900 kg
 MRW = 139 500 kg FWD CG = 18% MAC AT A/C WEIGHT = 139 500 kg
 MRW = 142 900 kg FWD CG = 18% MAC AT A/C WEIGHT = 142 900 kg
- (2) MRW = 132 900 kg AFT CG = 35% MAC AT A/C WEIGHT = 132 900 kg
 MRW = 139 500 kg AFT CG = 35% MAC AT A/C WEIGHT = 139 500 kg
 MRW = 142 900 kg AFT CG = 35% MAC AT A/C WEIGHT = 142 900 kg

NOTE: ALL LOADS CALCULATED USING AIRPLANE MAXIMUM RAMP WEIGHT

Maximum Pavement Loads

AIRPLANE CHARACTERISTICS FOR AIRPORT PLANNING

BA5 07 03 00 1 ACM0 00

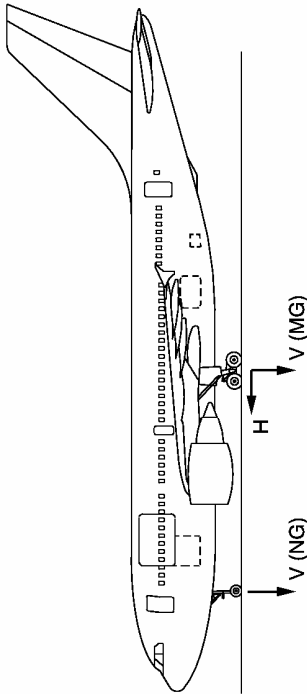

1	2		3		4		5		6			
	MAXIMUM RAMP WEIGHT		STATIC LOAD AT MOST FWD C.G. (1)		STATIC BRAKING @ 10 ft/s ² DECELERATION		STATIC LOAD AT MAX AFT C.G. (2)		STEADY BRAKING @ 10 ft/s ² DECELERATION		AT INSTANTANEOUS BRAKING COEFFICIENT = 0.8	
MODEL	lb	kg	lb	kg	lb	kg	lb	kg	lb	kg	lb	kg
-300	307 550	139 500	40 625	18 430	66 550	30 180	144 775	65 660	47 800	21 680	115 800	52 530
-300	332 675	150 900	43 950	19 940	71 975	32 650	157 100	71 260	51 700	23 450	125 675	57 010
-300	339 300	153 900	44 825	20 330	73 425	33 300	160 225	72 680	52 725	23 920	128 175	58 140

V (NG) MAXIMUM VERTICAL NOSE GEAR GROUND LOAD AT MOST FORWARD CG
 V (MG) MAXIMUM VERTICAL MAIN GEAR GROUND LOAD AT MOST AFT CG
 H MAXIMUM HORIZONTAL GROUND LOAD FROM BRAKING

- (1) MRW = 139 500 kg
 MRW = 150 900 kg
 MRW = 153 900 kg
- (2) MRW = 139 500 kg
 MRW = 150 900 kg
 MRW = 153 900 kg

NOTE: ALL LOADS CALCULATED USING AIRPLANE MAXIMUM RAMP WEIGHT

Maximum Pavement Loads

AIRPLANE CHARACTERISTICS FOR AIRPORT PLANNING

BA5 07 03 00 1 AEM0 00

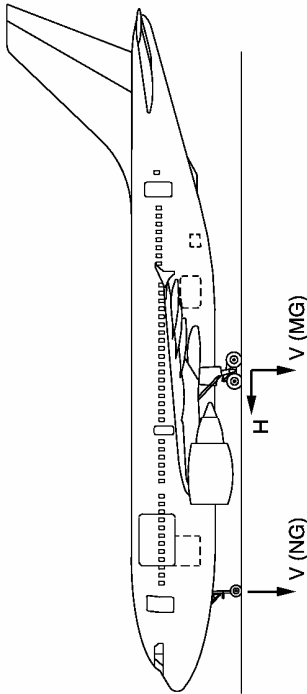

1	2		3		4		5		6			
	MAXIMUM RAMP WEIGHT		STATIC LOAD AT MOST FWD C.G. (1)		STATIC BRAKING @ 10 ft/s ² DECELERATION		VMG (PER STRUT) STATIC LOAD AT MAX AFT C.G. (2)		H (PER STRUT)			
MODEL	lb	kg	lb	kg	lb	kg	lb	kg	lb	kg		
-300	348 100	157 900	46 000	20 860	75 325	34 170	164 400	74 570	54 100	24 540	131 525	59 650
-300	354 725	160 900	45 725	20 740	74 900	33 970	167 525	75 980	55 125	25 000	134 000	60 790
-300	363 550	164 900	45 725	20 740	74 900	33 970	171 675	77 870	56 500	25 630	137 350	62 300

V (NG) MAXIMUM VERTICAL NOSE GEAR GROUND LOAD AT MOST FORWARD CG
 V (MG) MAXIMUM VERTICAL MAIN GEAR GROUND LOAD AT MOST AFT CG
 H MAXIMUM HORIZONTAL GROUND LOAD FROM BRAKING

- (1) MRW = 157 900 kg FWD CG = 18% MAC AT A/C WEIGHT = 157 900 kg
 MRW = 160 900 kg FWD CG = 18% MAC AT A/C WEIGHT = 157 000 kg
 MRW = 164 900 kg FWD CG = 18% MAC AT A/C WEIGHT = 157 000 kg
- (2) MRW = 157 900 kg AFT CG = 38% MAC AT A/C WEIGHT = 157 900 kg
 MRW = 160 900 kg AFT CG = 38% MAC AT A/C WEIGHT = 160 900 kg
 MRW = 164 900 kg AFT CG = 38% MAC AT A/C WEIGHT = 164 900 kg

NOTE: ALL LOADS CALCULATED USING AIRPLANE MAXIMUM RAMP WEIGHT

Maximum Pavement Loads

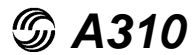

AIRPLANE CHARACTERISTICS FOR AIRPORT PLANNING

7.4 Landing Gear Loading on Pavement

-A310-200 Models

In the typical example shown in Section 7.4.1 with MRW 132 900 kg.

The Gross Aircraft Weight is 110 000 kg (242 500 lb) and the percentage of weight on the Main Gear is 93.3 %.

For these conditions the total weight on the Main Gear Group is 102 603 kg (226 250 lb).

-A310-300 Models

In the typical example shown in Section 7.4.1 with MRW 139 500 kg.

The Gross Aircraft Weight is 125 000 kg (275 575 lb) and the percentage of weight on the Main Gear is 94.14 %.

For these conditions the total weight on the Main Gear Group is 117 680 kg (259 425 lb).

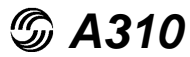

AIRPLANE CHARACTERISTICS FOR AIRPORT PLANNING

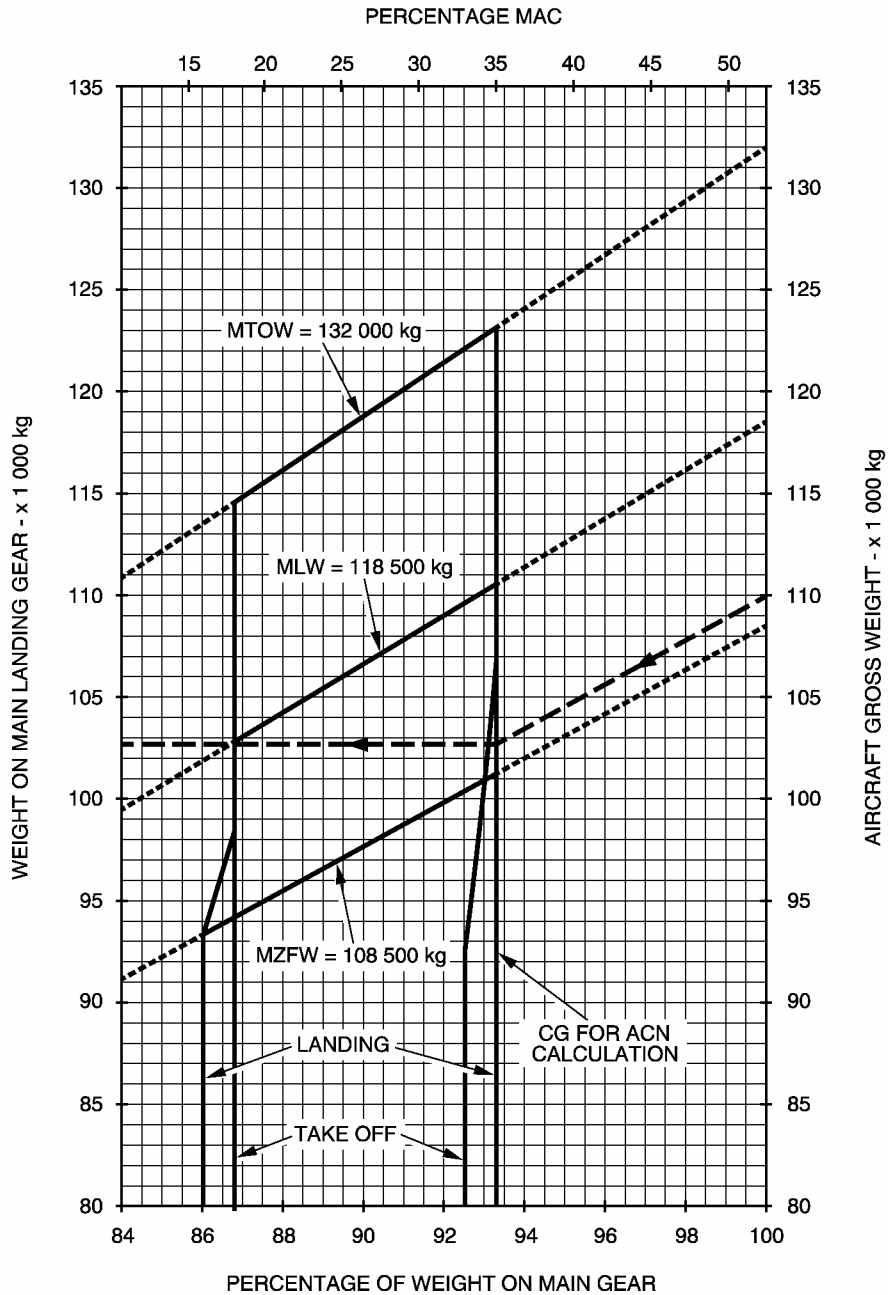

BA5 07 04 01 1 AAM0 00

Landing Gear Loading on Pavement
A310-200 Models - MRW 132 900 kg

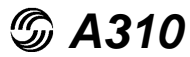

AIRPLANE CHARACTERISTICS FOR AIRPORT PLANNING

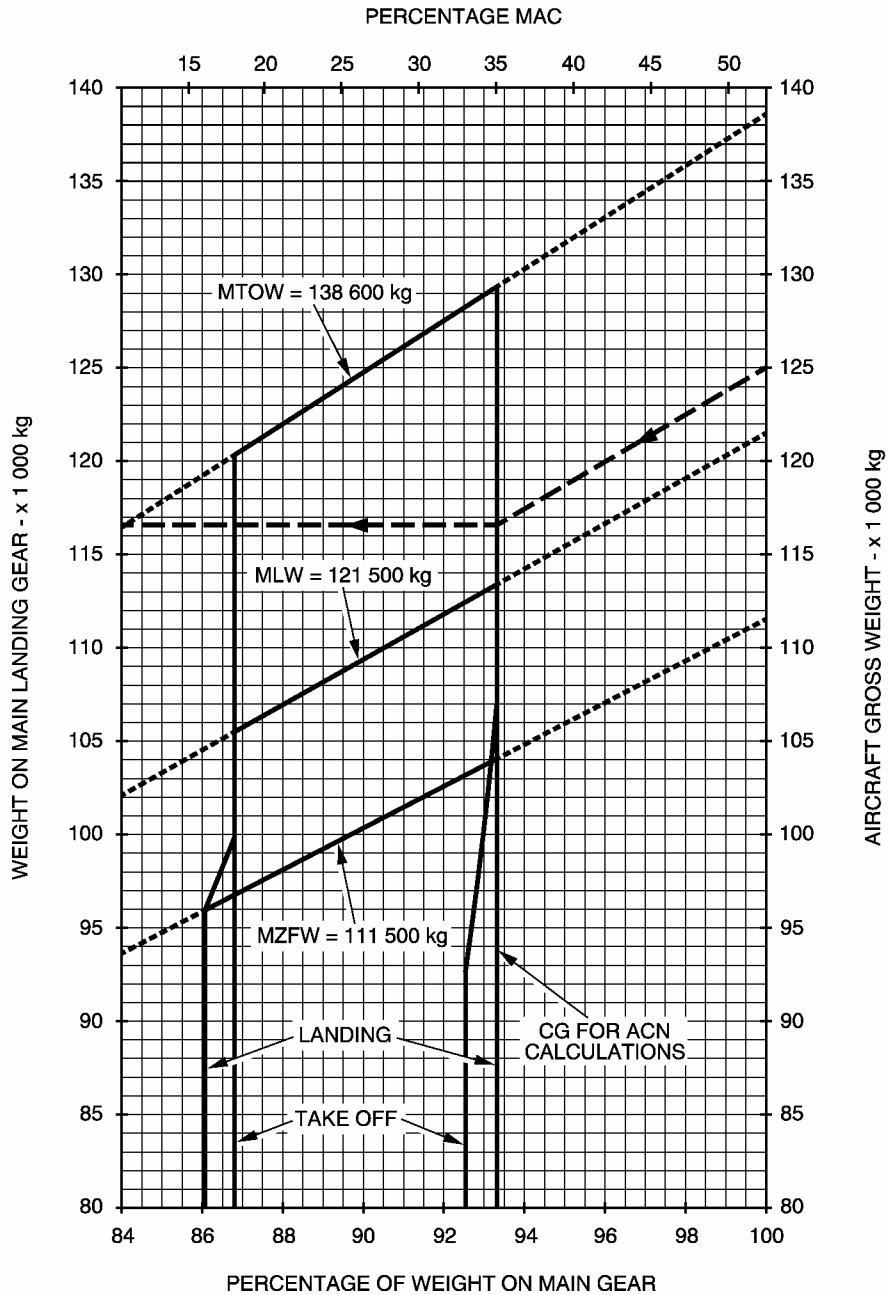

BA5 07 04 01 1 ACMD 00

Landing Gear Loading on Pavement
A310-200 Models - MRW 139 500 kg

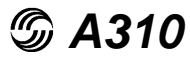

AIRPLANE CHARACTERISTICS FOR AIRPORT PLANNING

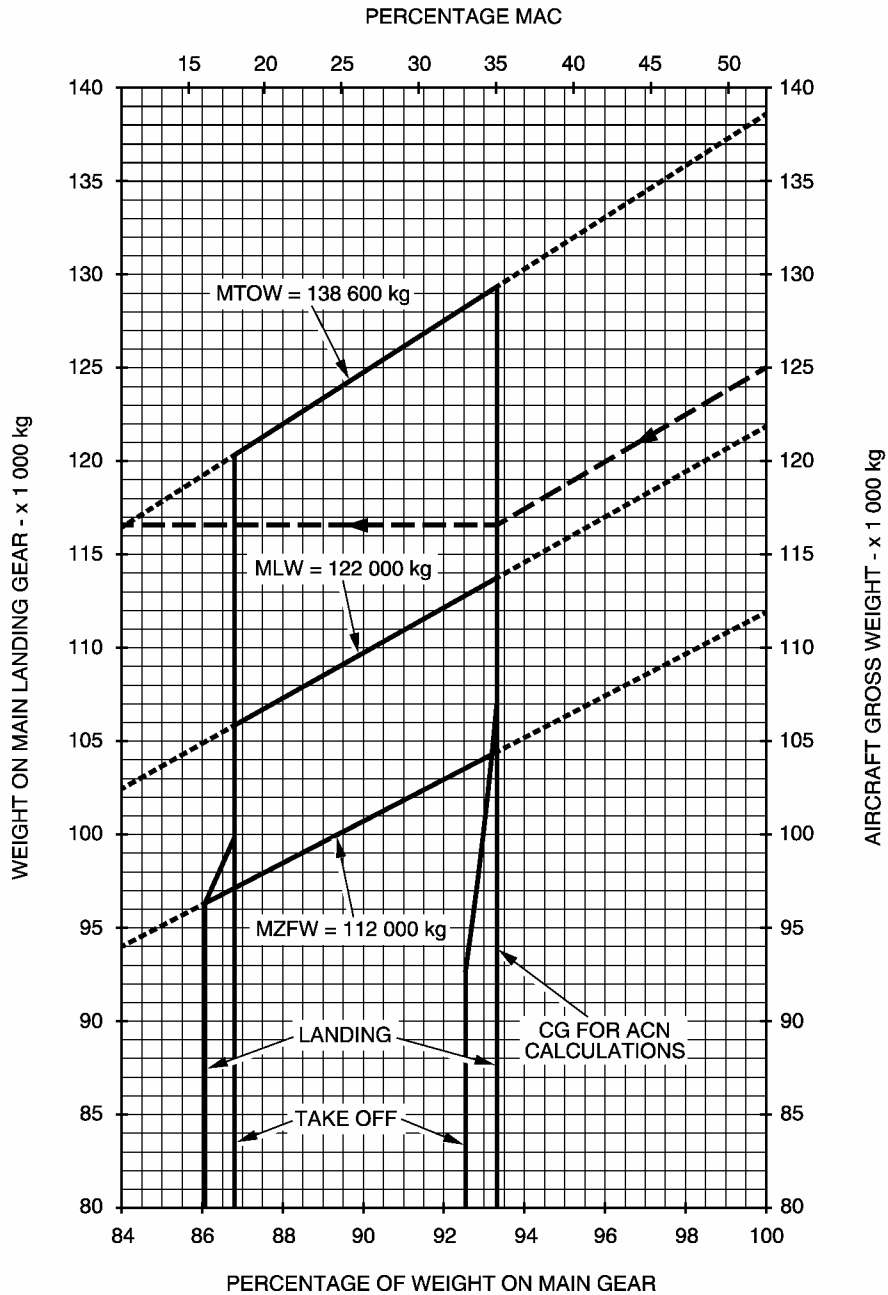

BA5 07 04 01 1 AEM0 00

Landing Gear Loading on Pavement
A310-200 Models - MRW 139 500 kg

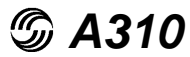

AIRPLANE CHARACTERISTICS FOR AIRPORT PLANNING

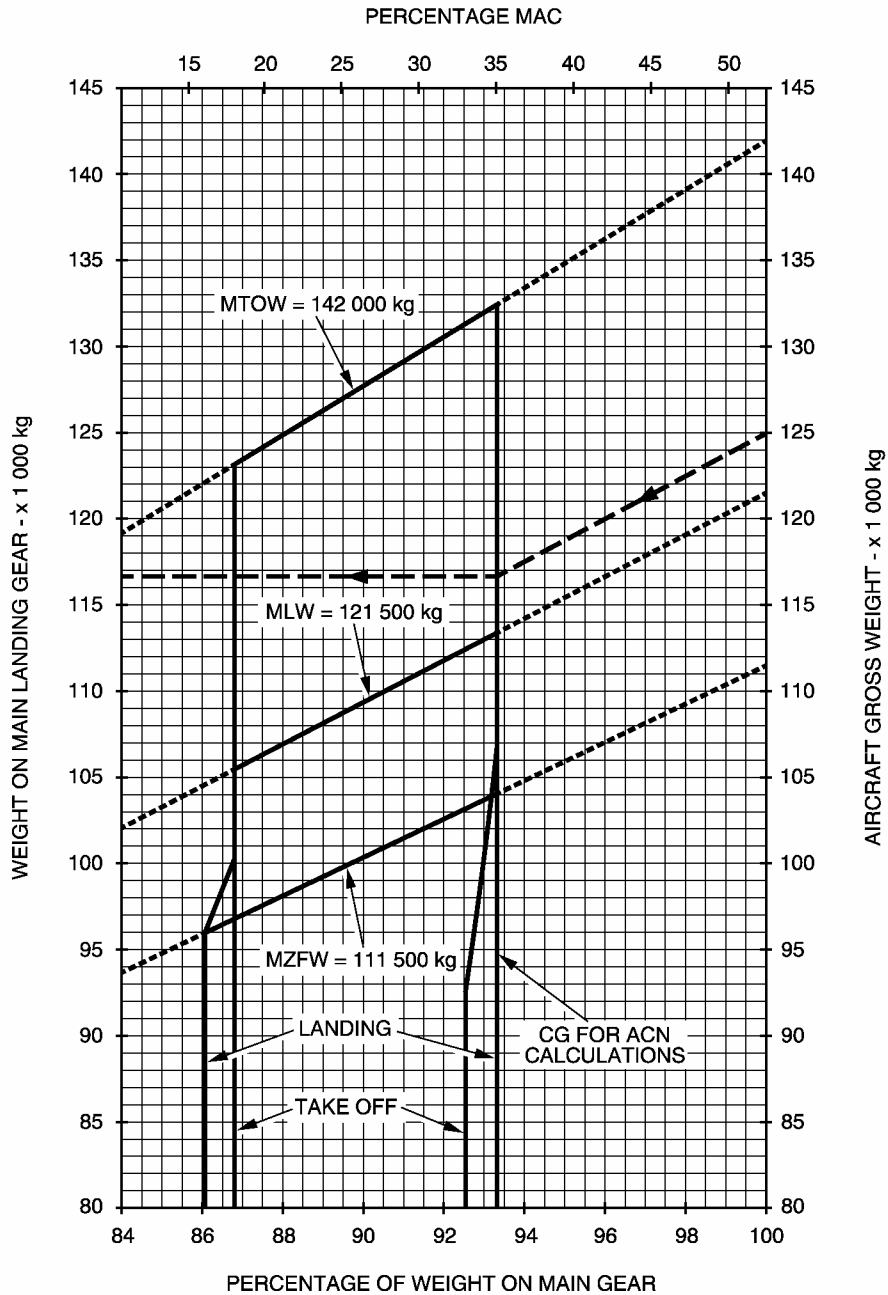

BA5 07 04 01 1 AGM0 00

Landing Gear Loading on Pavement
A310-200 Models - MRW 142 900 kg

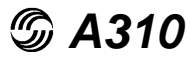

AIRPLANE CHARACTERISTICS FOR AIRPORT PLANNING

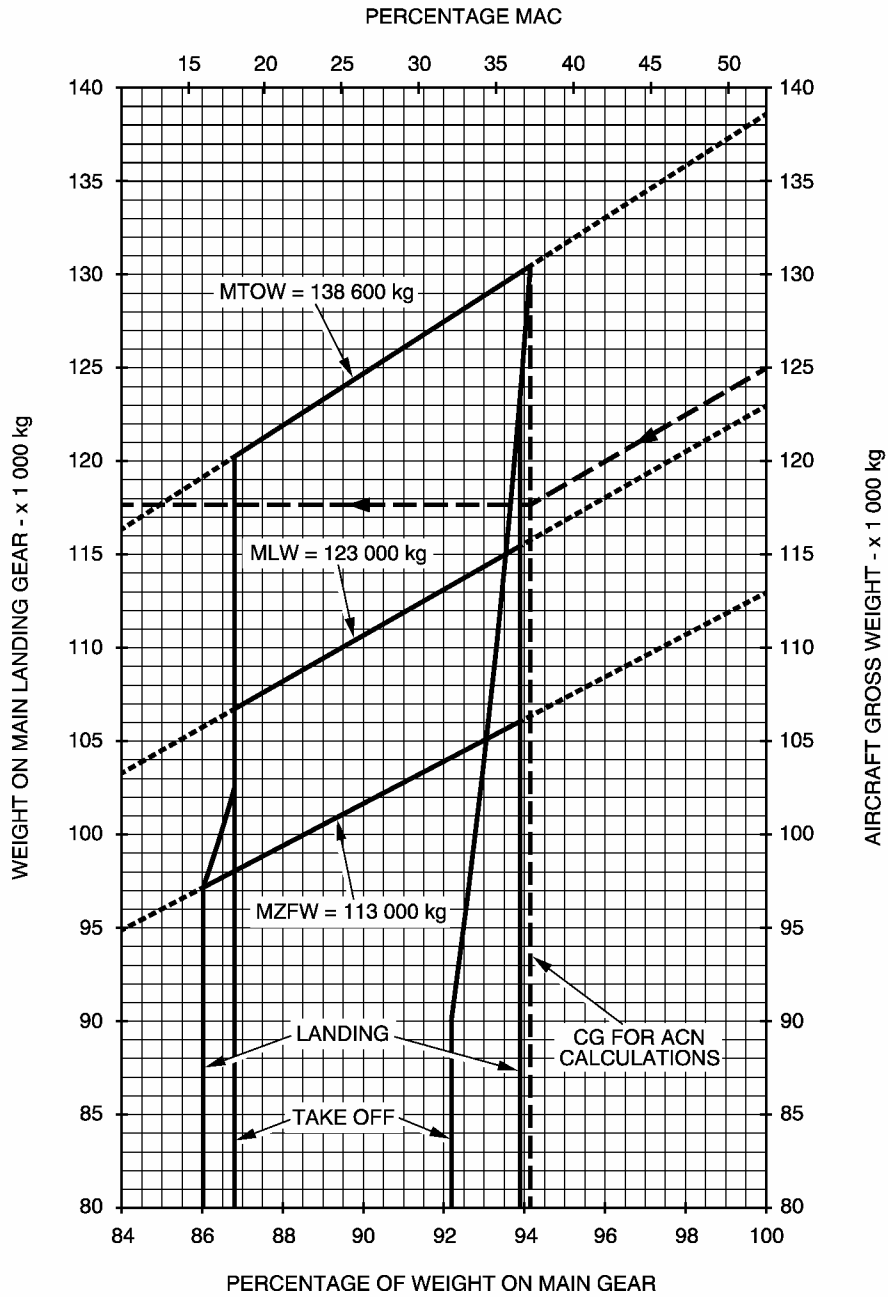

BA5 07 04 01 1 AJM0 00

Landing Gear Loading on Pavement
A310-300 Models - MRW 139 500 kg

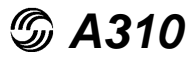

AIRPLANE CHARACTERISTICS FOR AIRPORT PLANNING

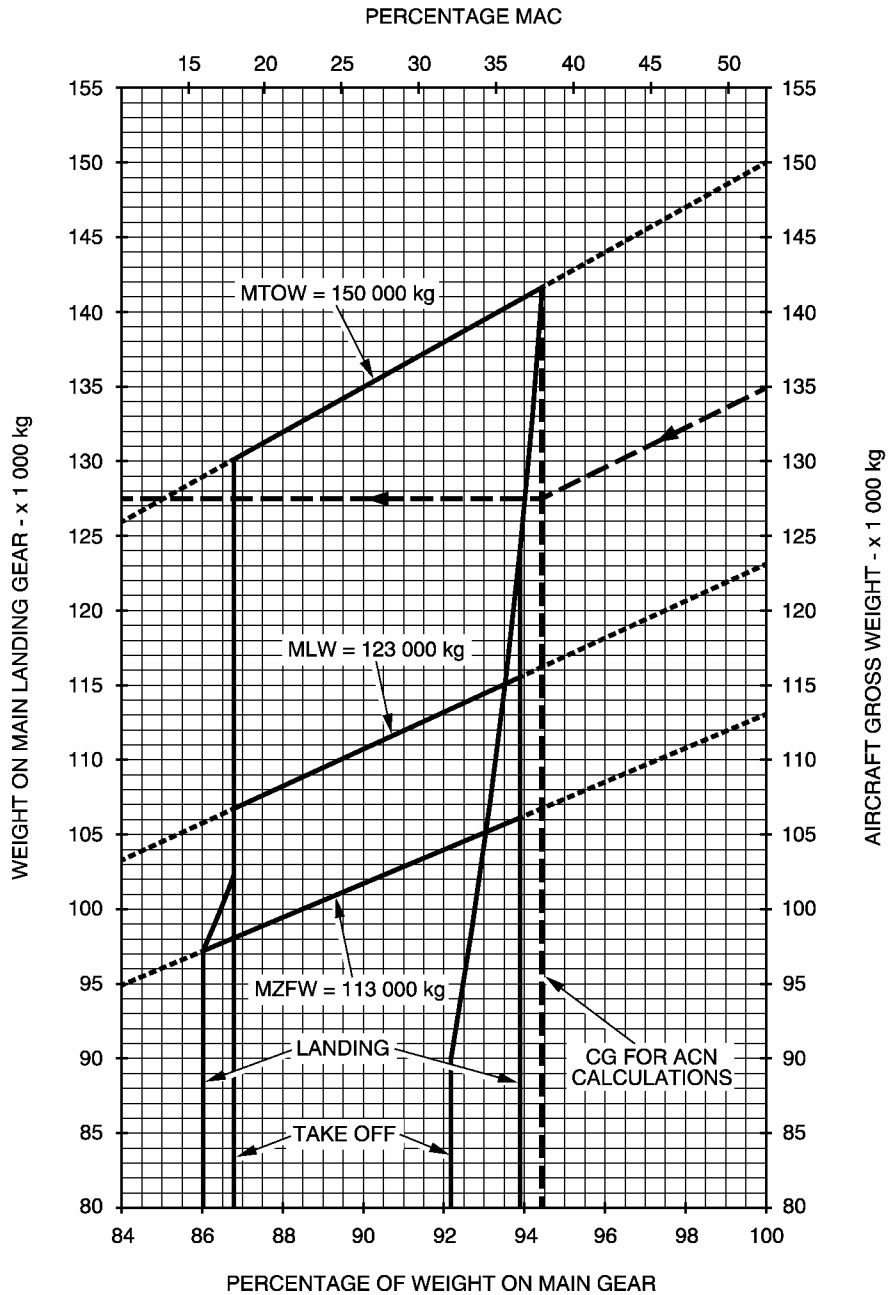

BA5 07 04 01 1 ALM0 00

Landing Gear Loading on Pavement
A310-300 Models - MRW 150 900 kg

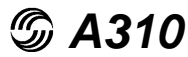

AIRPLANE CHARACTERISTICS FOR AIRPORT PLANNING

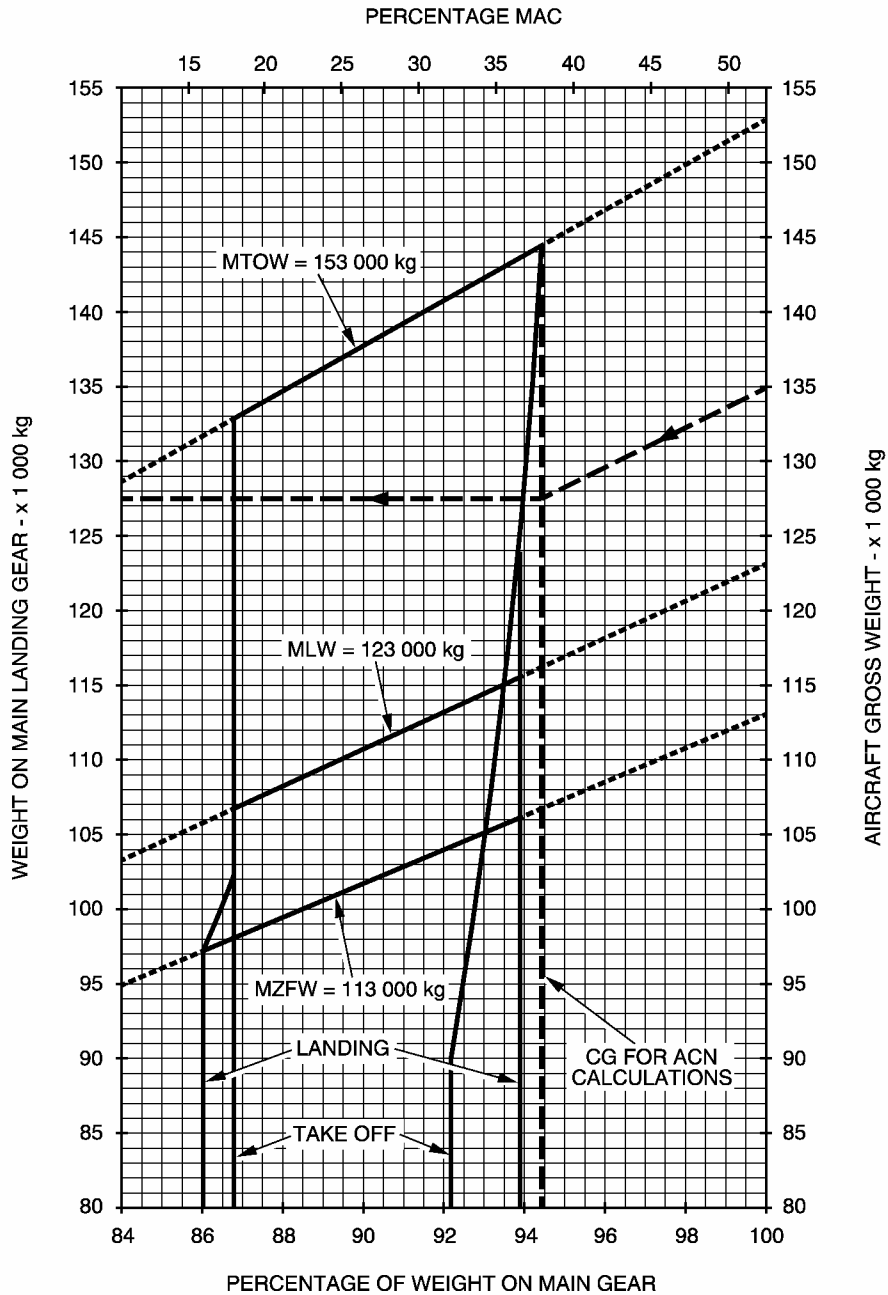

BA5 07 04 01 1 ANMO 00

Landing Gear Loading on Pavement
A310-300 Models - MRW 153 900 kg

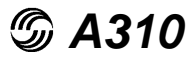

AIRPLANE CHARACTERISTICS FOR AIRPORT PLANNING

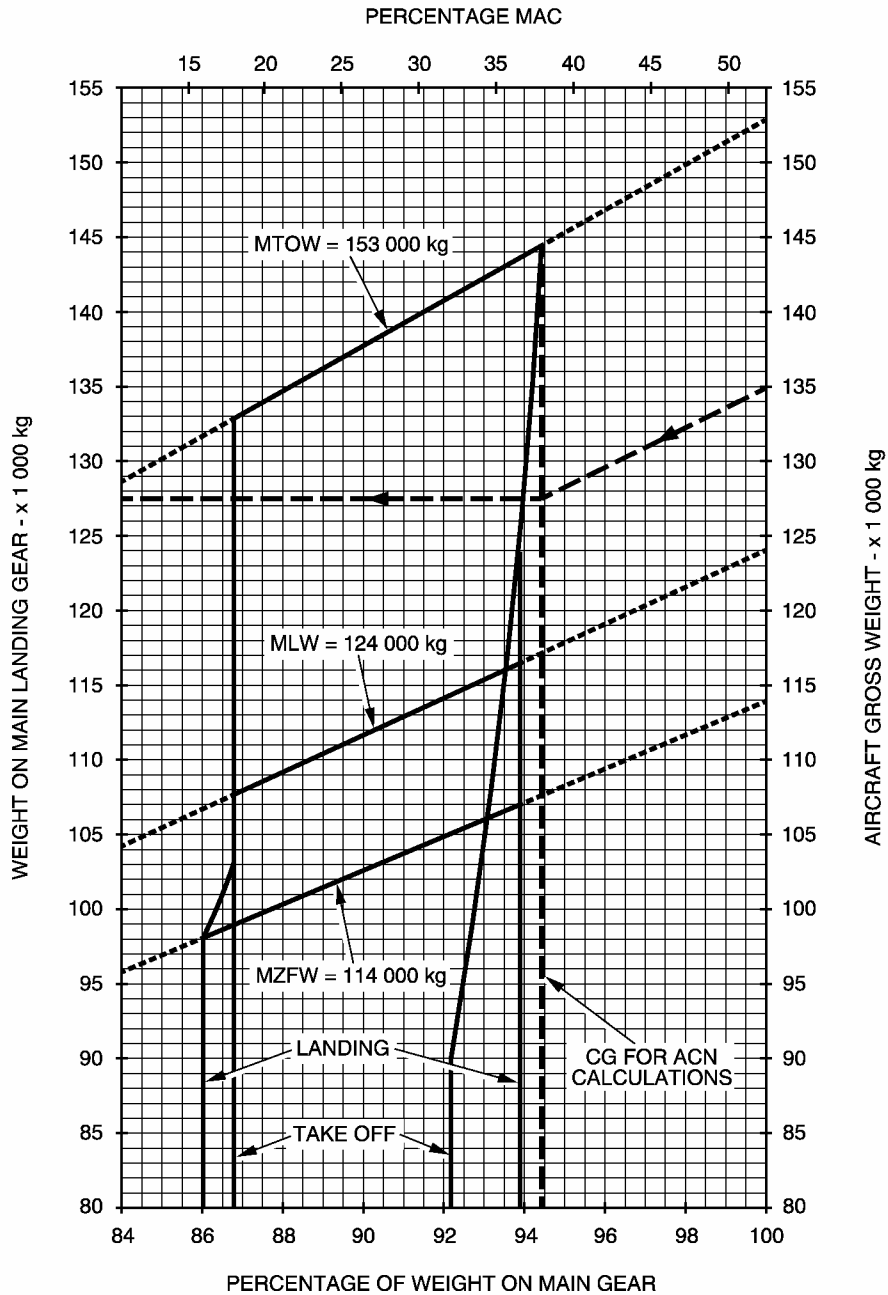

BA5 07 04 01 1 AQM0 00

Landing Gear Loading on Pavement
A310-300 Models - MRW 153 900 kg

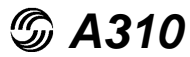

AIRPLANE CHARACTERISTICS FOR AIRPORT PLANNING

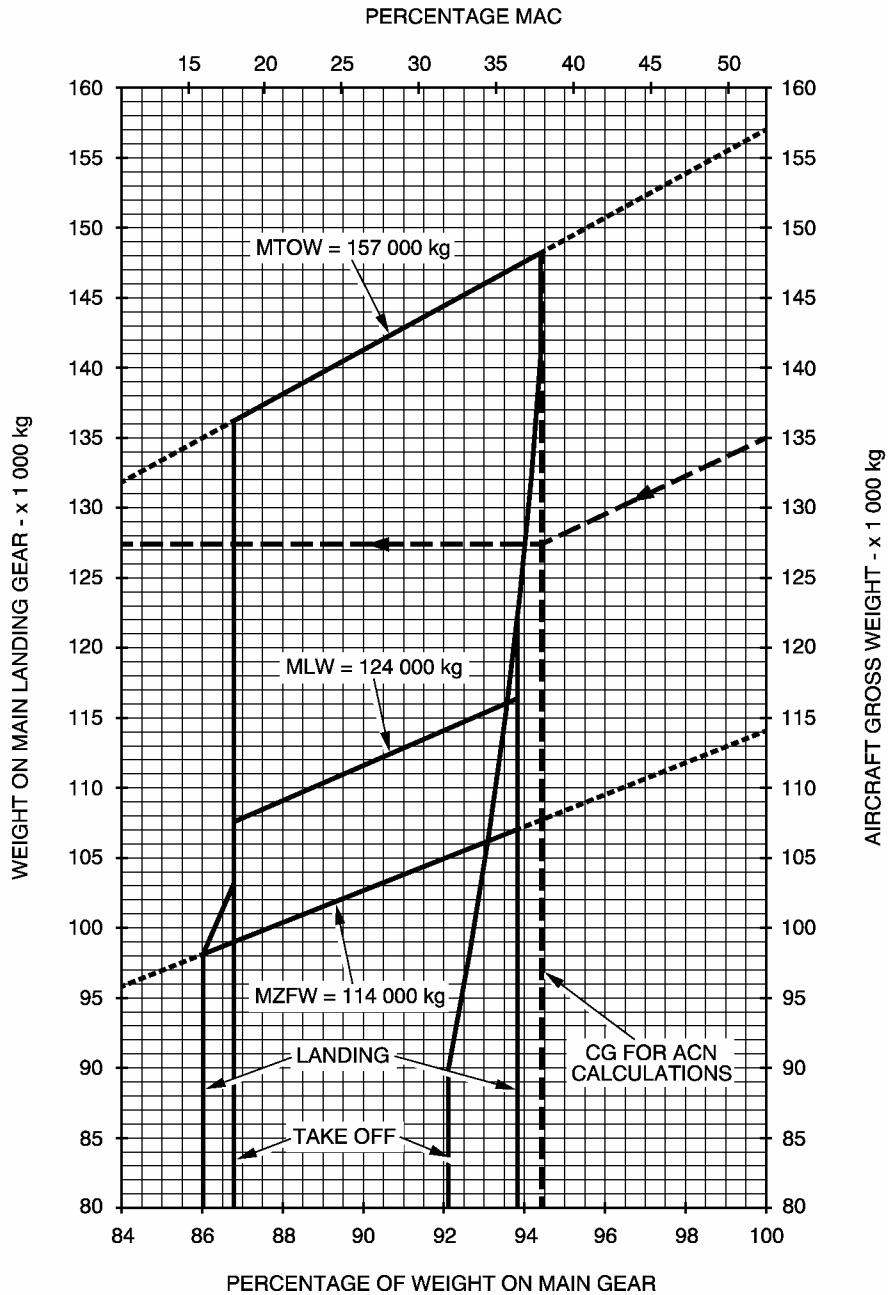

BA5 07 04 01 1 ASMD 00

Landing Gear Loading on Pavement
A310-300 Models - MRW 157 900 kg

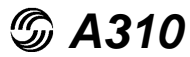

AIRPLANE CHARACTERISTICS FOR AIRPORT PLANNING

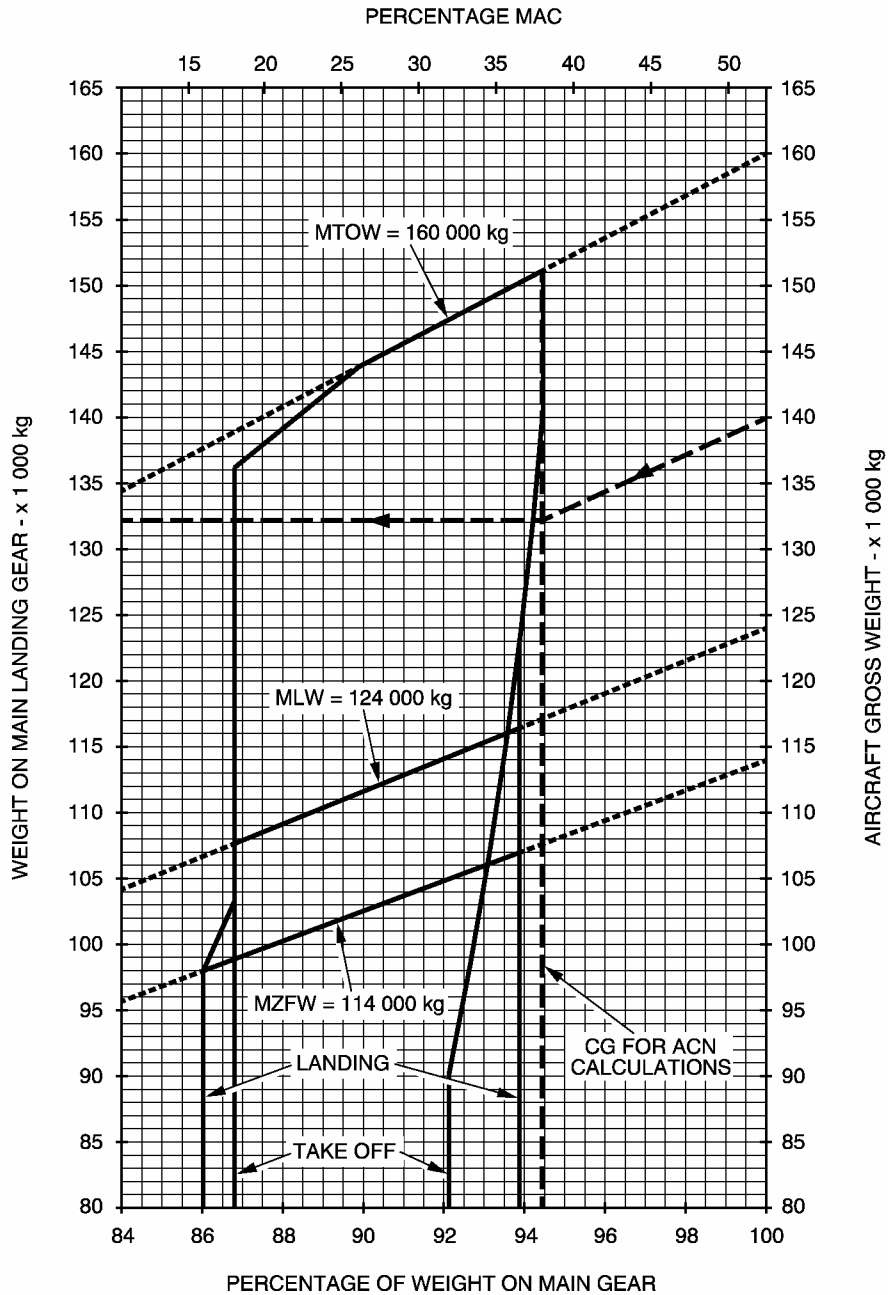

BA5 07 04 01 1 AJUM0 00

Landing Gear Loading on Pavement
A310-300 Models - MRW 160 900 kg

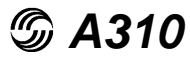

AIRPLANE CHARACTERISTICS FOR AIRPORT PLANNING

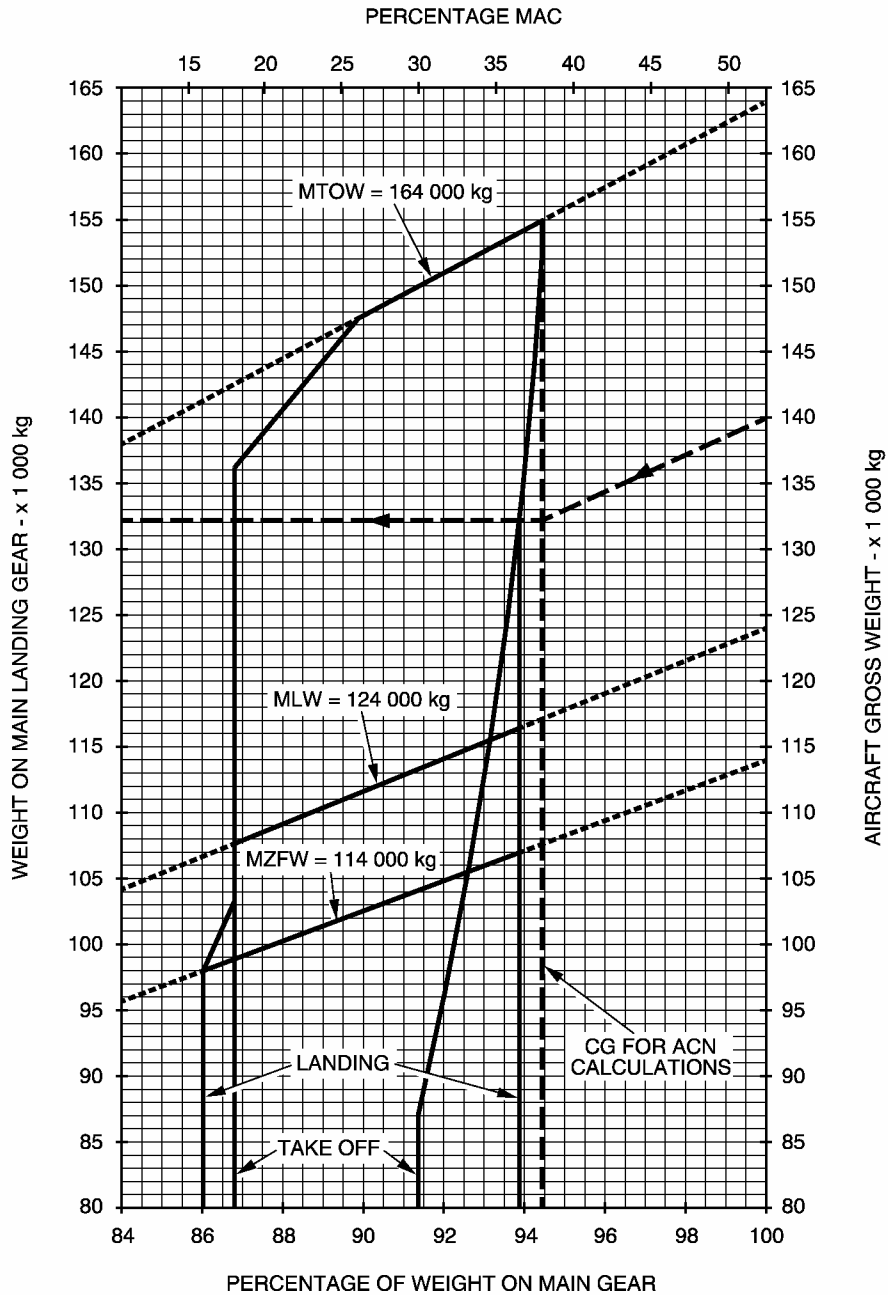

BA5 07 04 01 1 AWM0 00

Landing Gear Loading on Pavement
A310-300 Models - MRW 164 900 kg



AIRPLANE CHARACTERISTICS FOR AIRPORT PLANNING

7.5 Flexible Pavement Requirements - US Army Corps of Engineers Design Method

To find a Flexible Pavement Thickness, the Subgrade Strength (CBR), the Annual Departure Level and the weight on one Main Landing must be known.

-A310-200 Models

In the typical example shown in Section 7.5.1 with MRW 132 900 kg for :

- a CBR value of 10
- an Annual Departure level of 3000
- and the load on one Wing Landing Gear of 40 000 kg (88 175 lb)
- the required Flexible Pavement Thickness is 34 cm (13.5 inches).

The line showing 10 000 Coverages is used to calculate Aircraft Classification Number (ACN).

-A310-300 Models

In the typical example shown in Section 7.5.1 with MRW 139 500 kg for :

- a CBR value of 10
- an Annual Departure level of 3000
- and the load on one Wing Landing Gear of 40 000 kg (88 175 lb)
- the required Flexible Pavement Thickness is 34 cm (13.5 inches).

The line showing 10 000 Coverages is used to calculate Aircraft Classification Number (ACN).

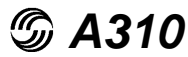

AIRPLANE CHARACTERISTICS FOR AIRPORT PLANNING

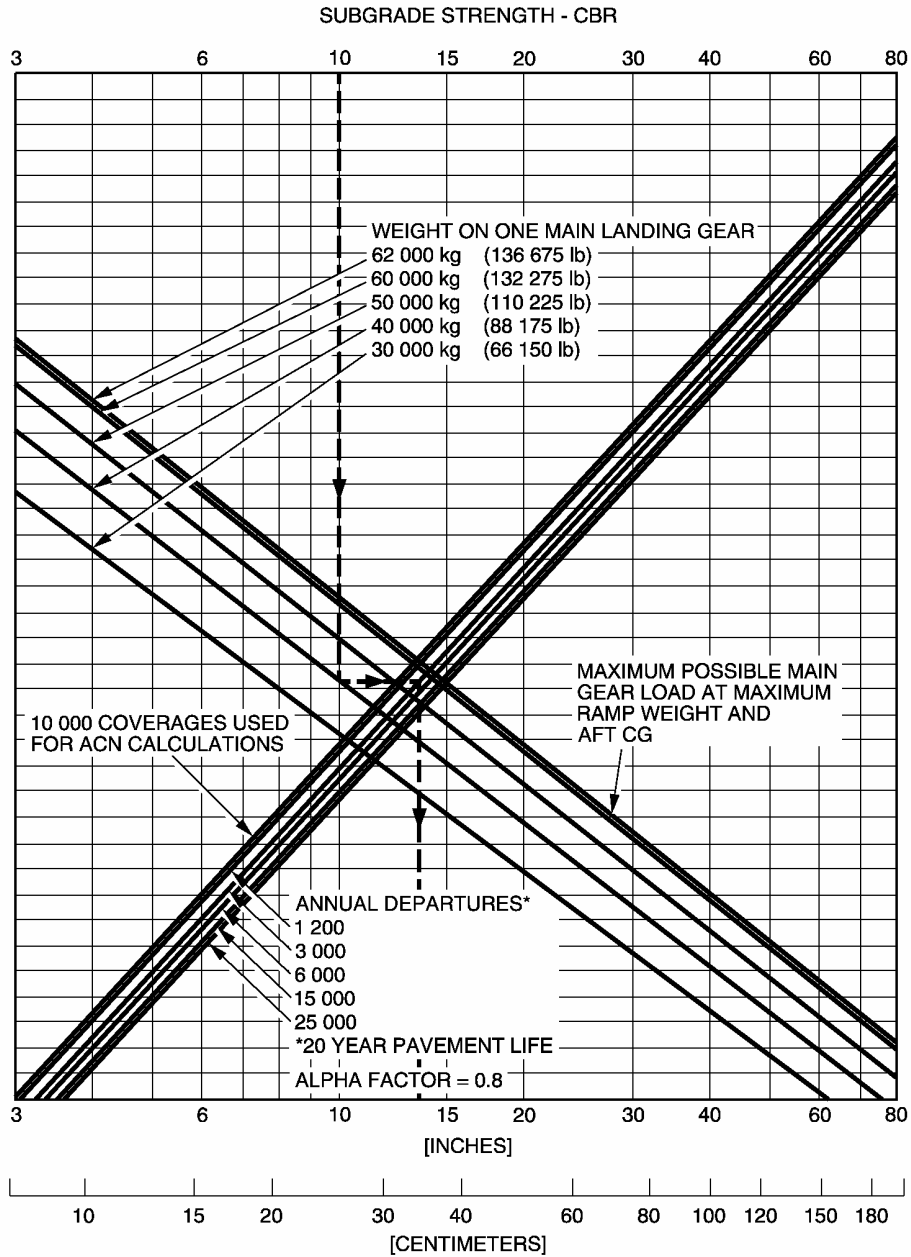

BA5 07 05 01 1 AAM0 00

FLEXIBLE PAVEMENT THICKNESS

46 x 16 - 20 TIRES

TIRE PRESSURE CONSTANT AT 12.3 BAR (178 PSI)

Flexible Pavement Requirements
A310-200 Models - MRW 132 900 kg

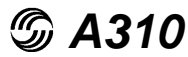

AIRPLANE CHARACTERISTICS FOR AIRPORT PLANNING

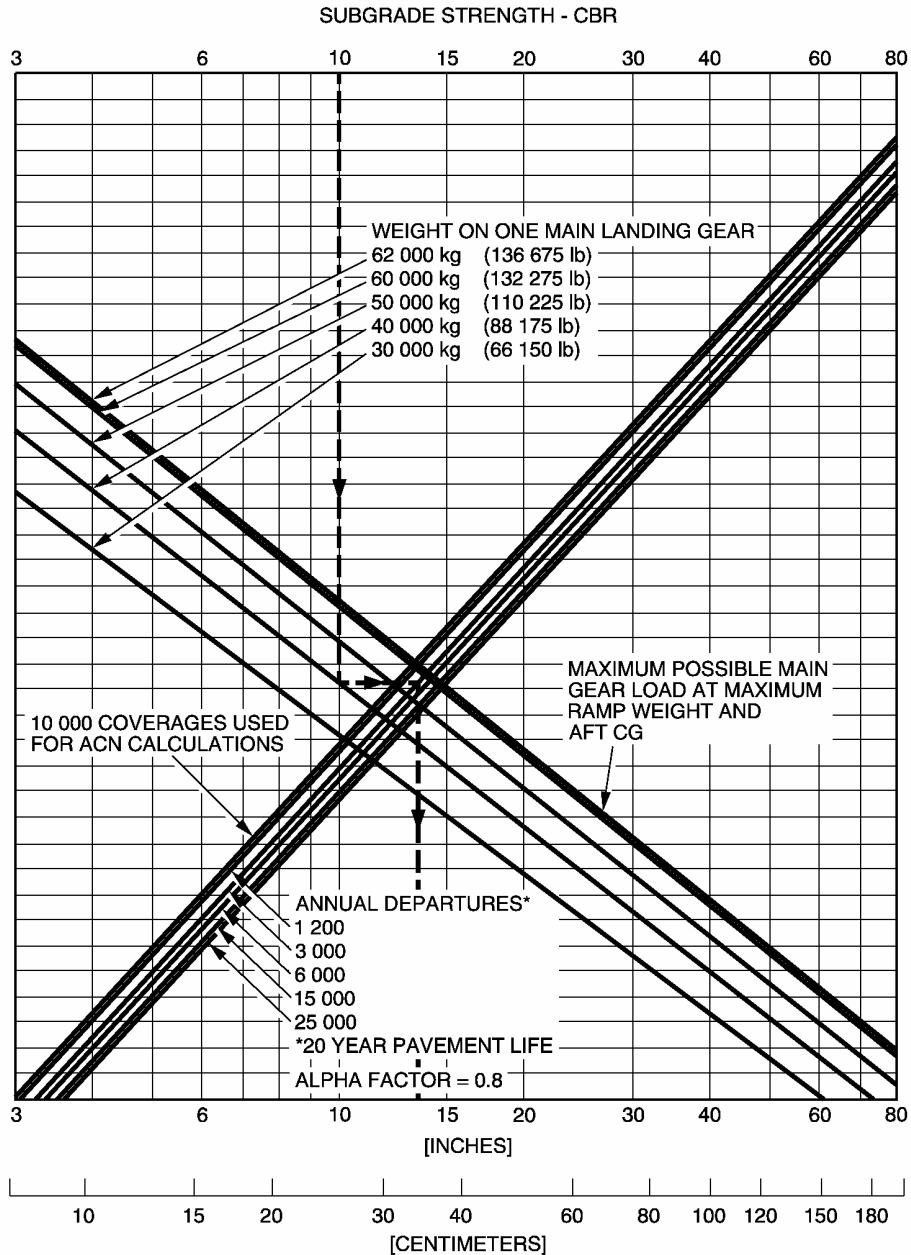

BA5 07 05 01 1 ACM0 00

FLEXIBLE PAVEMENT THICKNESS

49 x 17 - 20 TIRES

TIRE PRESSURE CONSTANT AT 10.2 BAR (148 PSI)

Flexible Pavement Requirements
A310-200 Models - MRW 132 900 kg

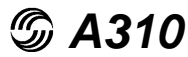

AIRPLANE CHARACTERISTICS FOR AIRPORT PLANNING

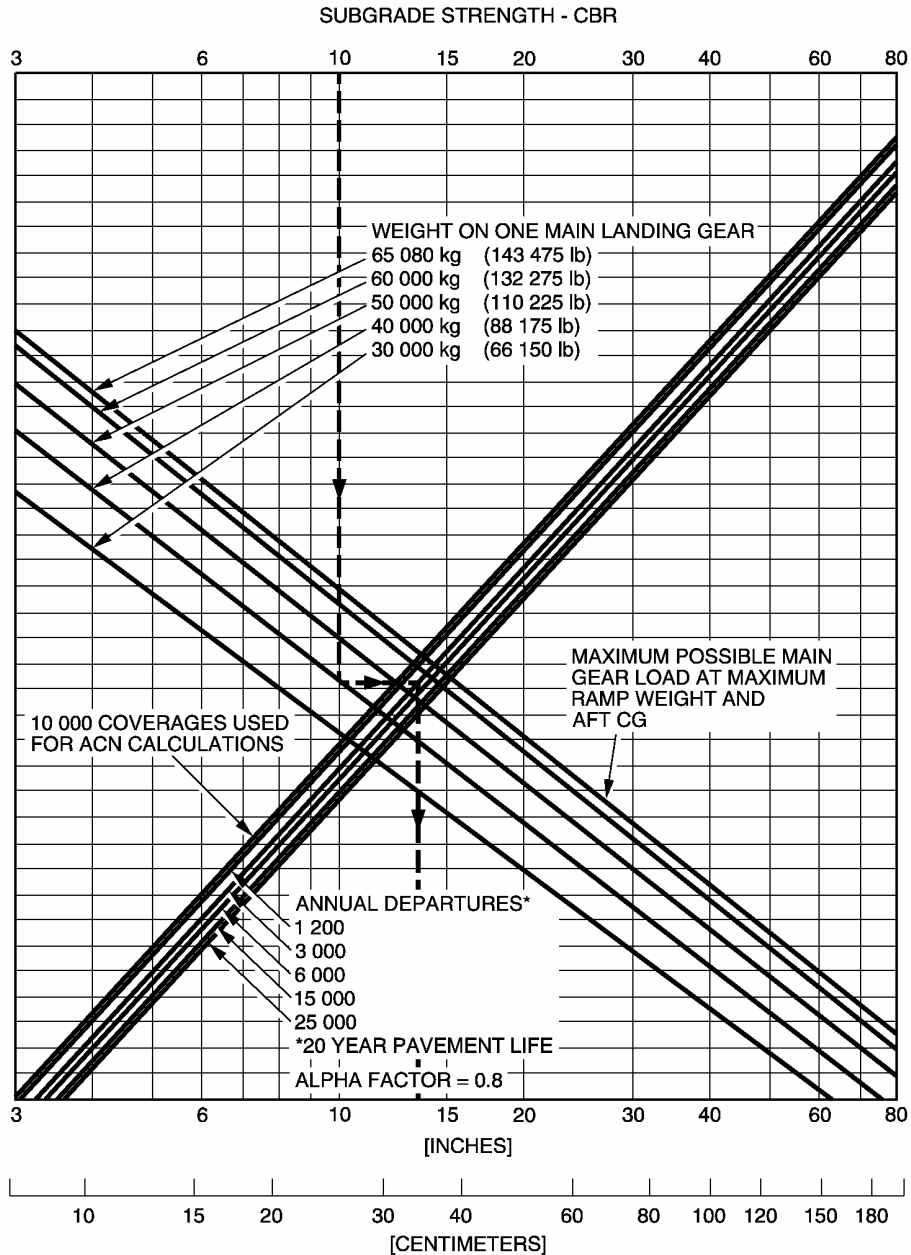

BA5 07 05 01 1 AEM0 00

FLEXIBLE PAVEMENT THICKNESS

46 x 16 - 20 TIRES

TIRE PRESSURE CONSTANT AT 13 BAR (189 PSI)

Flexible Pavement Requirements
A310-200 Models - MRW 139 500 kg

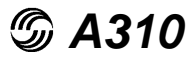

AIRPLANE CHARACTERISTICS FOR AIRPORT PLANNING

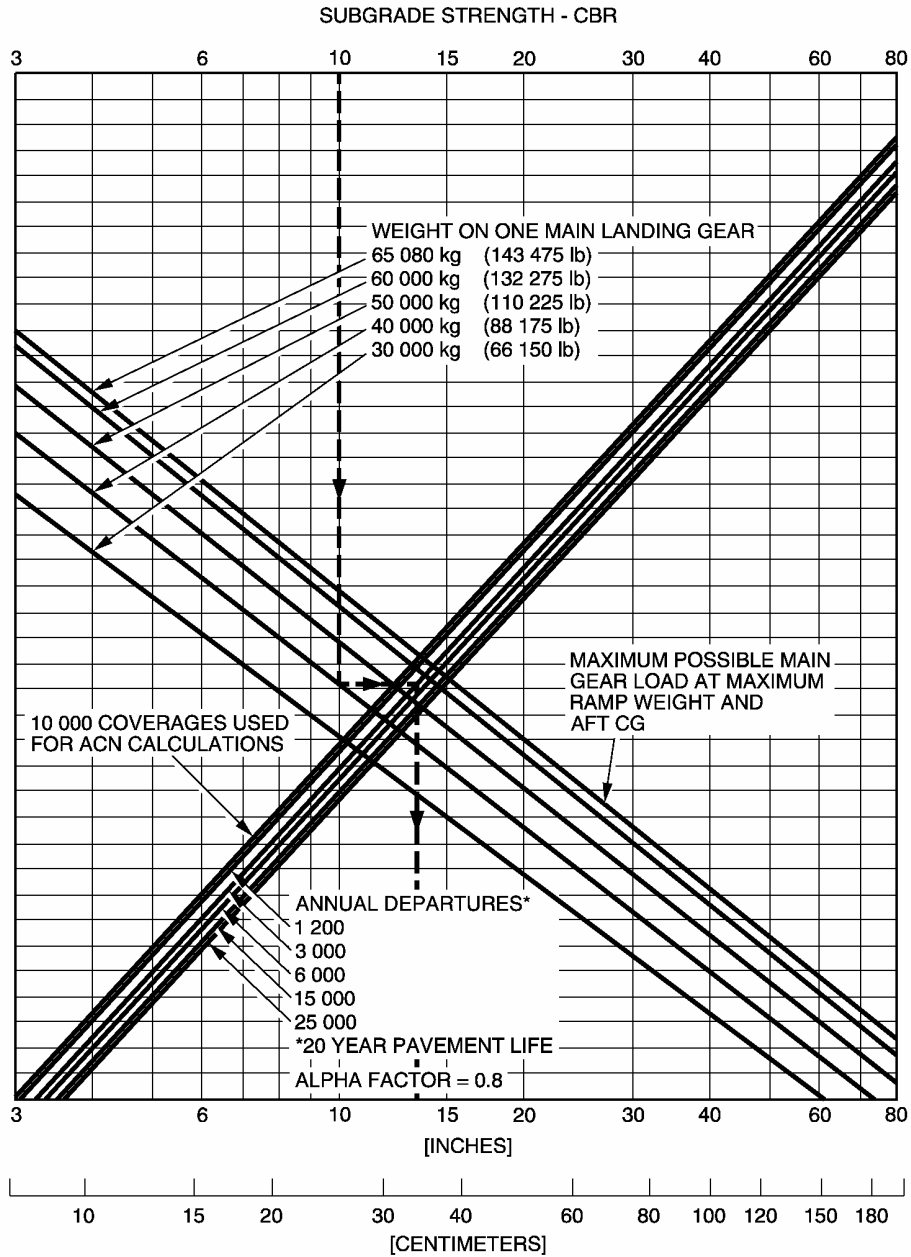

BA5 07 05 01 1 AGM0 00

FLEXIBLE PAVEMENT THICKNESS

49 x 17 - 20 TIRES

TIRE PRESSURE CONSTANT AT 10.8 BAR (157 PSI)

Flexible Pavement Requirements
A310-200 Models - MRW 139 500 kg

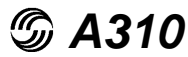

AIRPLANE CHARACTERISTICS FOR AIRPORT PLANNING

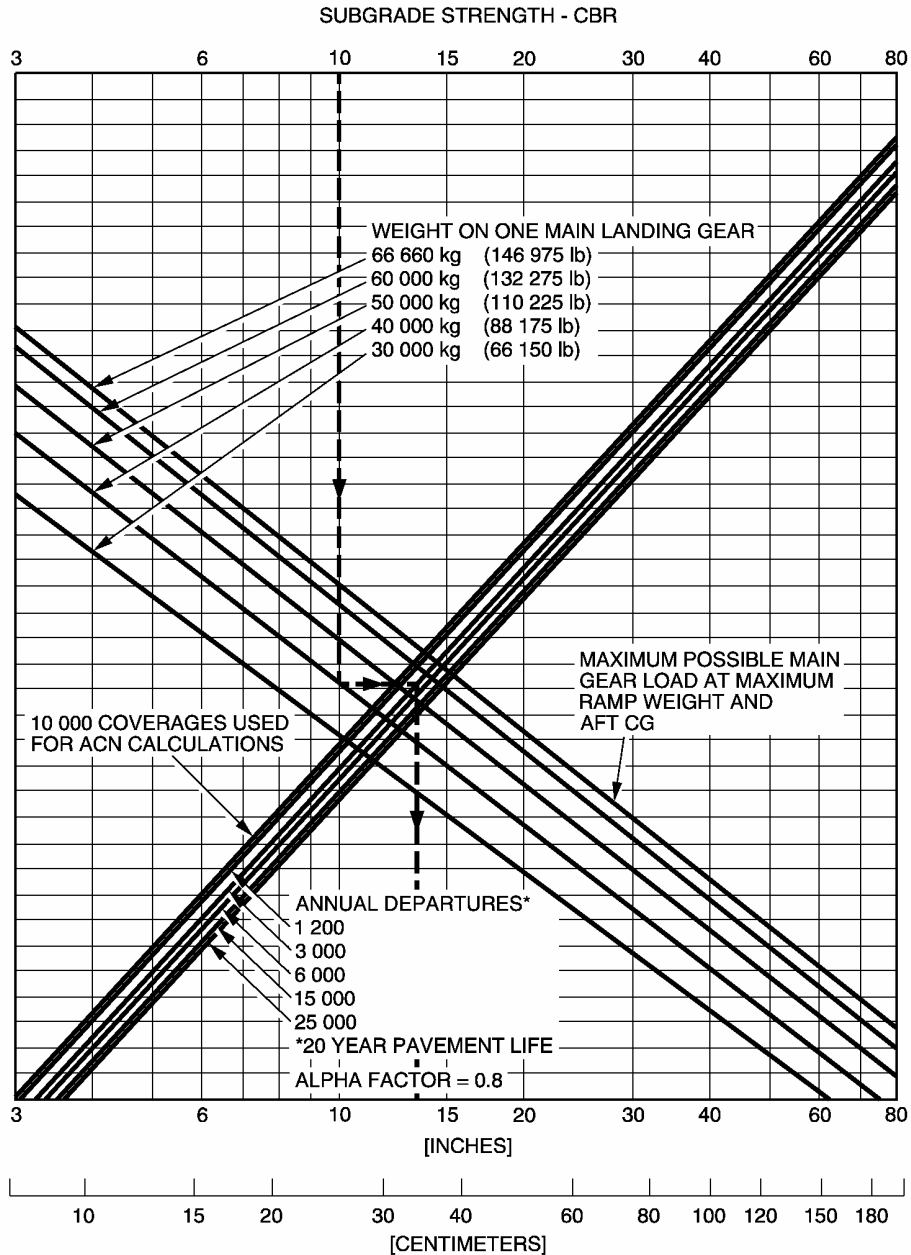

BA5 07 05 01 1 AJM0 00

FLEXIBLE PAVEMENT THICKNESS

46 x 16 - 20 TIRES

TIRE PRESSURE CONSTANT AT 13.3 BAR (193 PSI)

Flexible Pavement Requirements
A310-200 Models - MRW 142 900 kg

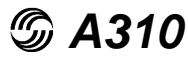

AIRPLANE CHARACTERISTICS FOR AIRPORT PLANNING

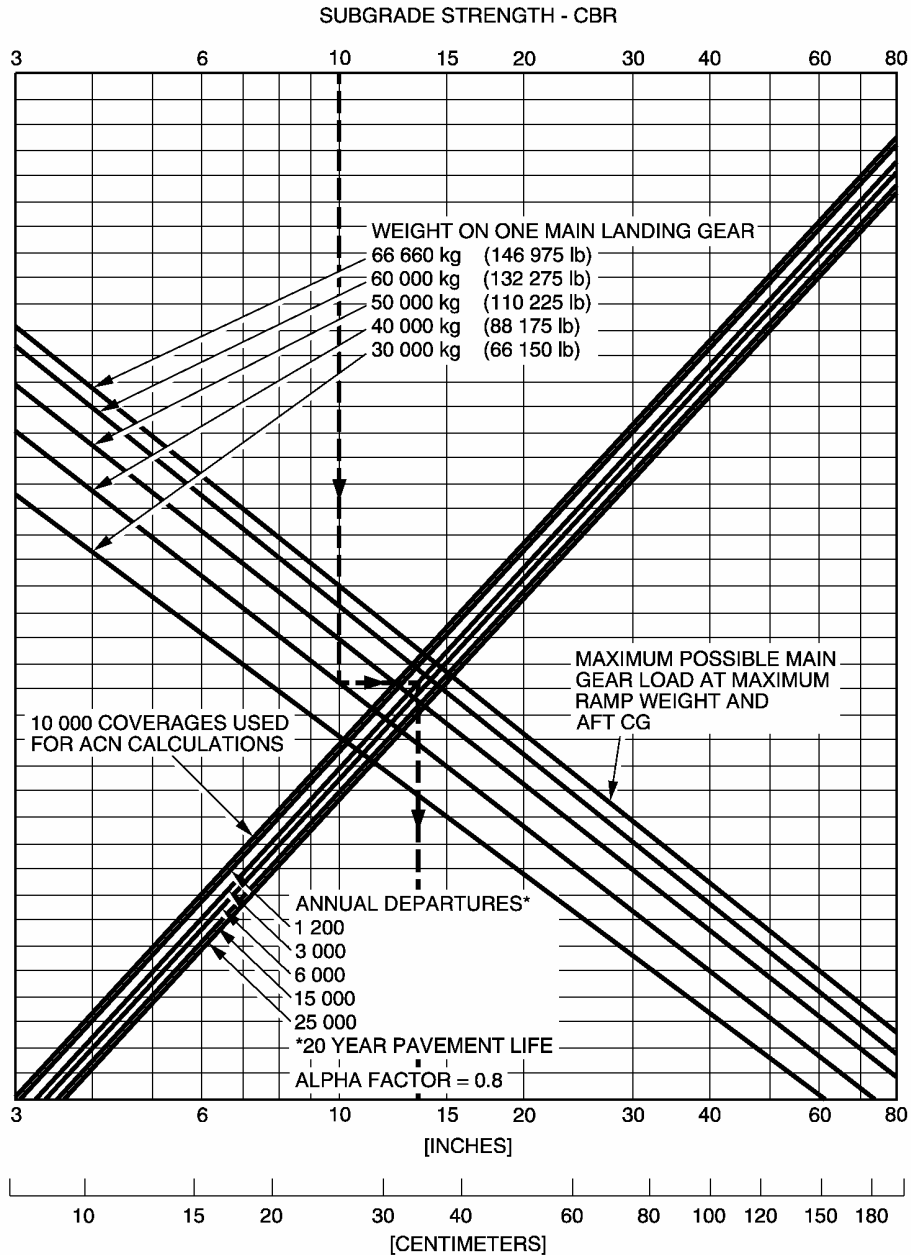

BA5 07 05 01 1 ALM0 00

FLEXIBLE PAVEMENT THICKNESS

49 x 17 - 20 TIRES

TIRE PRESSURE CONSTANT AT 11 BAR (160 PSI)

Flexible Pavement Requirements
A310-200 Models - MRW 142 900 kg

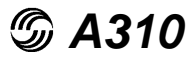

AIRPLANE CHARACTERISTICS FOR AIRPORT PLANNING

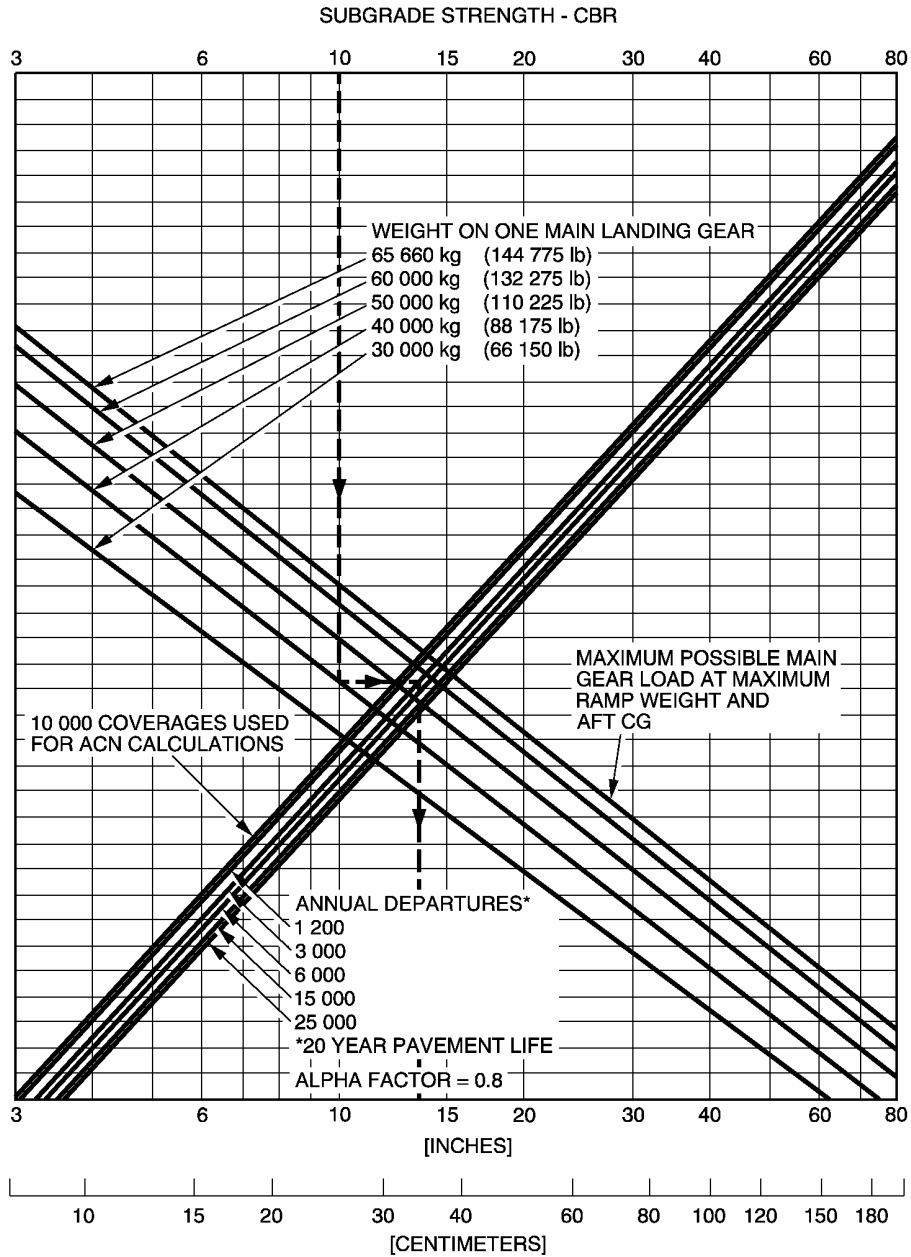

BA5 07 05 01 1 ANM0 00

FLEXIBLE PAVEMENT THICKNESS

46 x 16 - 20 TIRES

TIRE PRESSURE CONSTANT AT 13.2 BAR (191 PSI)

Flexible Pavement Requirements
A310-300 Models - MRW 139 500 kg

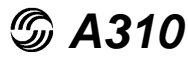

AIRPLANE CHARACTERISTICS FOR AIRPORT PLANNING

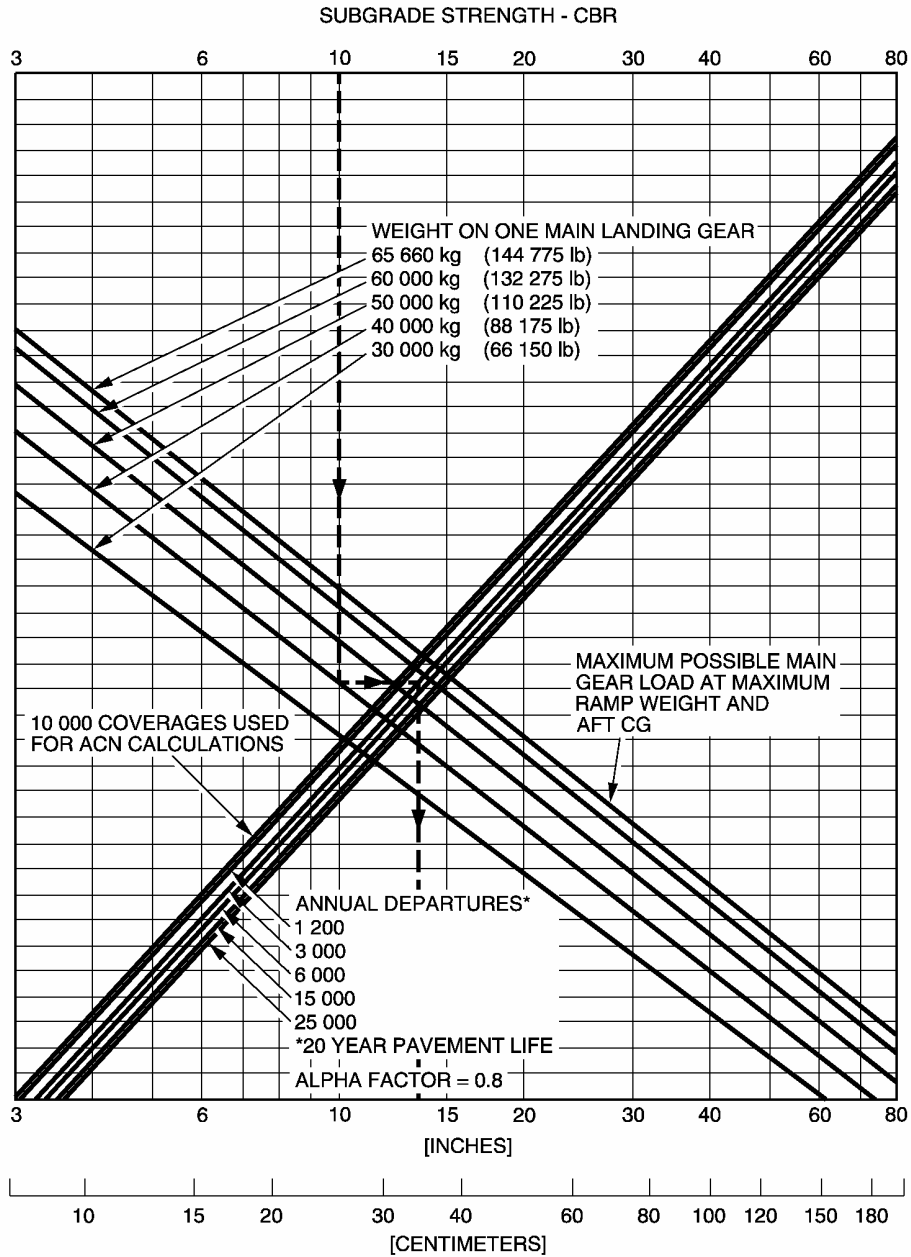

BA5 07 05 01 1 AQM0 00

FLEXIBLE PAVEMENT THICKNESS

49 x 17 - 20 TIRES

TIRE PRESSURE CONSTANT AT 11 BAR (160 PSI)

Flexible Pavement Requirements
A310-300 Models - MRW 139 500 kg

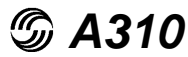

AIRPLANE CHARACTERISTICS FOR AIRPORT PLANNING

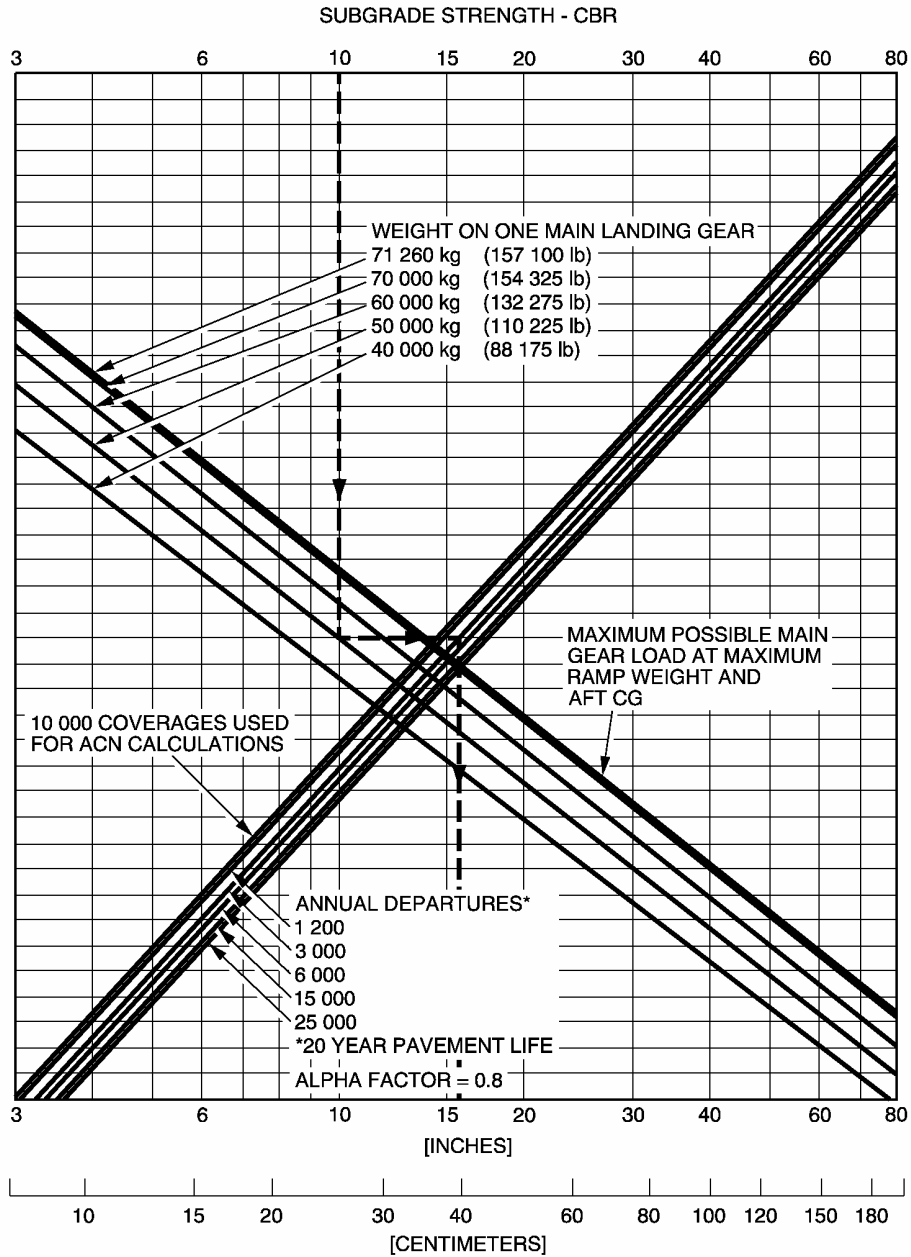

BA5 07 05 01 1 ASM0 00

FLEXIBLE PAVEMENT THICKNESS

46 x 16 - 20 TIRES

TIRE PRESSURE CONSTANT AT 14.3 BAR (207 PSI)

Flexible Pavement Requirements
A310-300 Models - MRW 150 900 kg

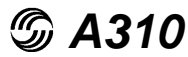

AIRPLANE CHARACTERISTICS FOR AIRPORT PLANNING

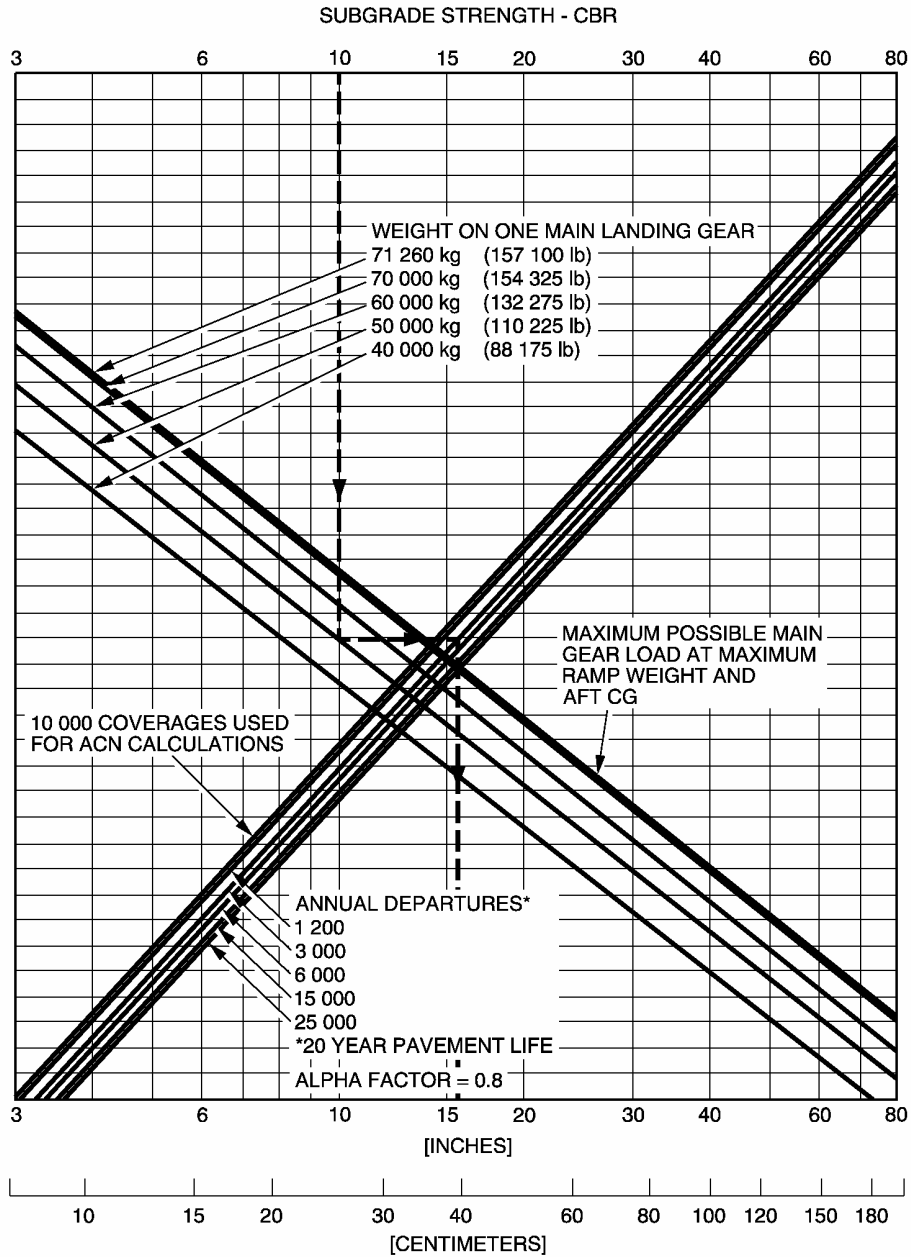

BA5 07 05 01 1 AUM0 00

FLEXIBLE PAVEMENT THICKNESS

49 x 17 - 20 TIRES

TIRE PRESSURE CONSTANT AT 11.9 BAR (173 PSI)

Flexible Pavement Requirements
A310-300 Models - MRW 150 900 kg

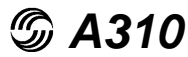

AIRPLANE CHARACTERISTICS FOR AIRPORT PLANNING

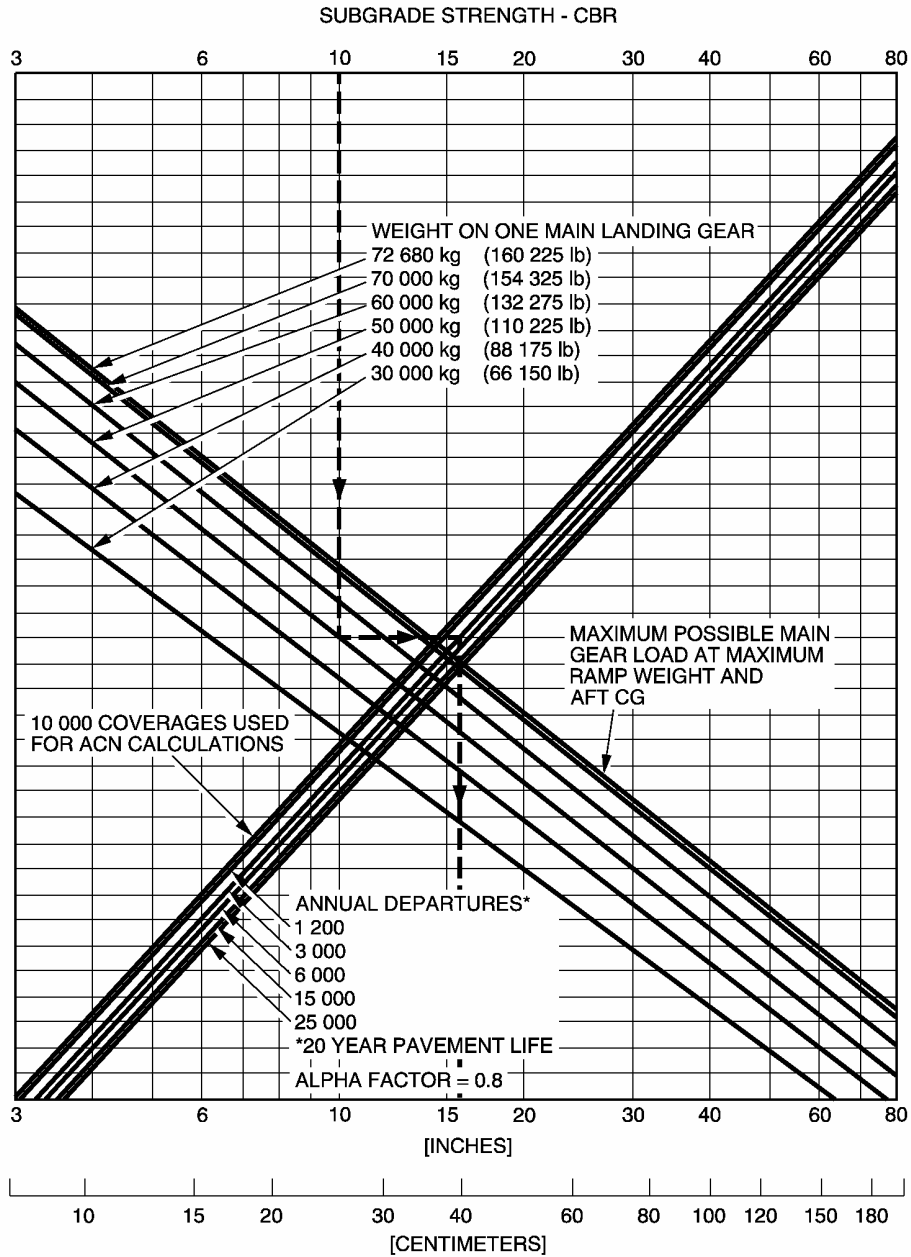

BA5 07 05 01 1 AWM0 00

FLEXIBLE PAVEMENT THICKNESS

46 x 16 - 20 TIRES

TIRE PRESSURE CONSTANT AT 14.6 BAR (212 PSI)

Flexible Pavement Requirements
A310-300 Models - MRW 153 900 kg

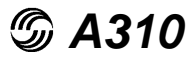

AIRPLANE CHARACTERISTICS FOR AIRPORT PLANNING

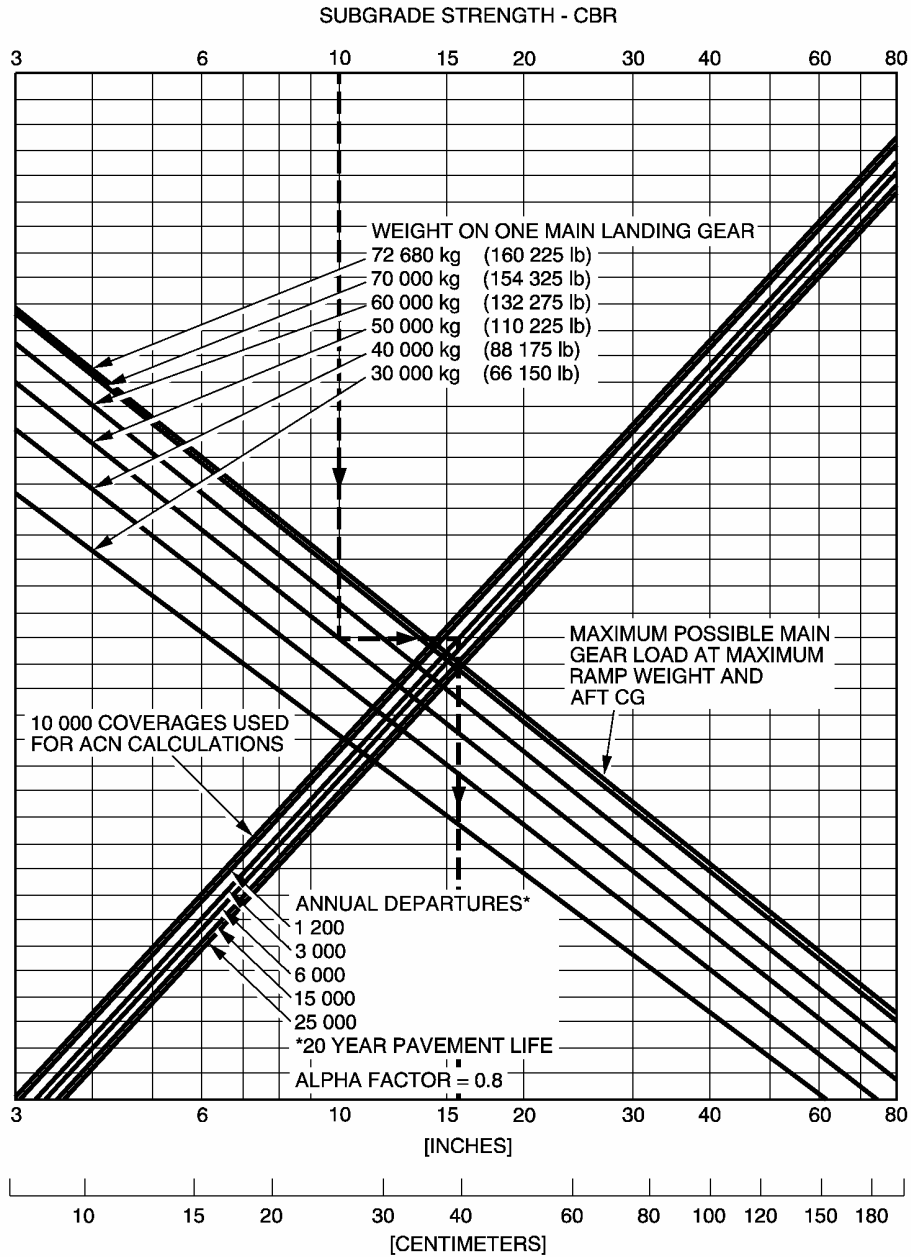

BA5 07 05 01 1 AYM0 00

FLEXIBLE PAVEMENT THICKNESS

49 x 17 - 20 TIRES

TIRE PRESSURE CONSTANT AT 12 BAR (174 PSI)

Flexible Pavement Requirements
A310-300 Models - MRW 153 900 kg

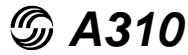

AIRPLANE CHARACTERISTICS FOR AIRPORT PLANNING

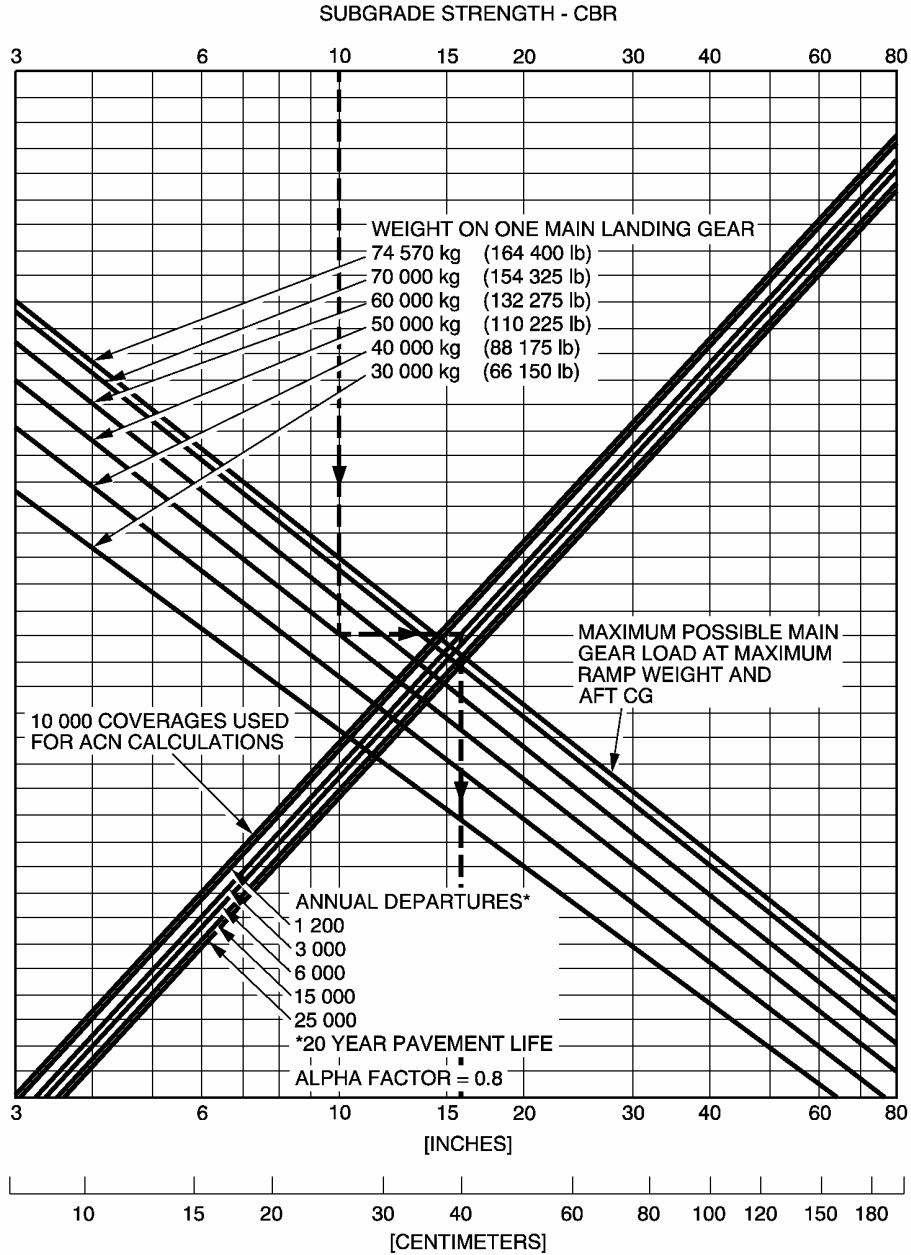

BA5 07 05 01 1 BAM0 00

FLEXIBLE PAVEMENT THICKNESS

46 x 16 - 20 TIRES

TIRE PRESSURE CONSTANT AT 14.8 BAR (215 PSI)

Flexible Pavement Requirements
A310-300 Models - MRW 157 900 kg

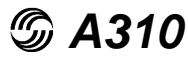

AIRPLANE CHARACTERISTICS FOR AIRPORT PLANNING

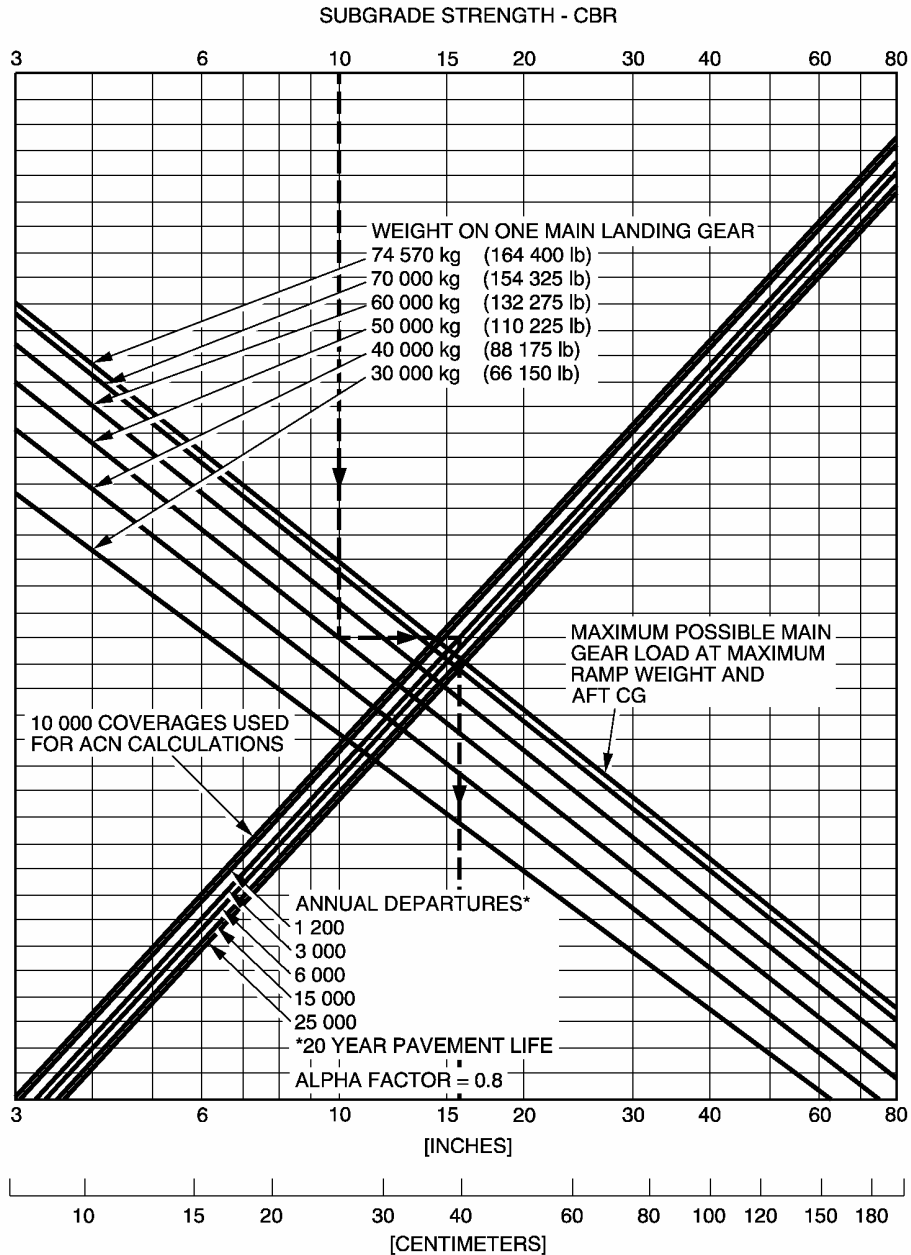

FLEXIBLE PAVEMENT THICKNESS

49 x 17 - 20 TIRES

TIRE PRESSURE CONSTANT AT 12.4 BAR (180 PSI)

Flexible Pavement Requirements
A310-300 Models - MRW 157 900 kg

BA5 07 05 01 1 BCM0 00

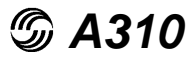

AIRPLANE CHARACTERISTICS FOR AIRPORT PLANNING

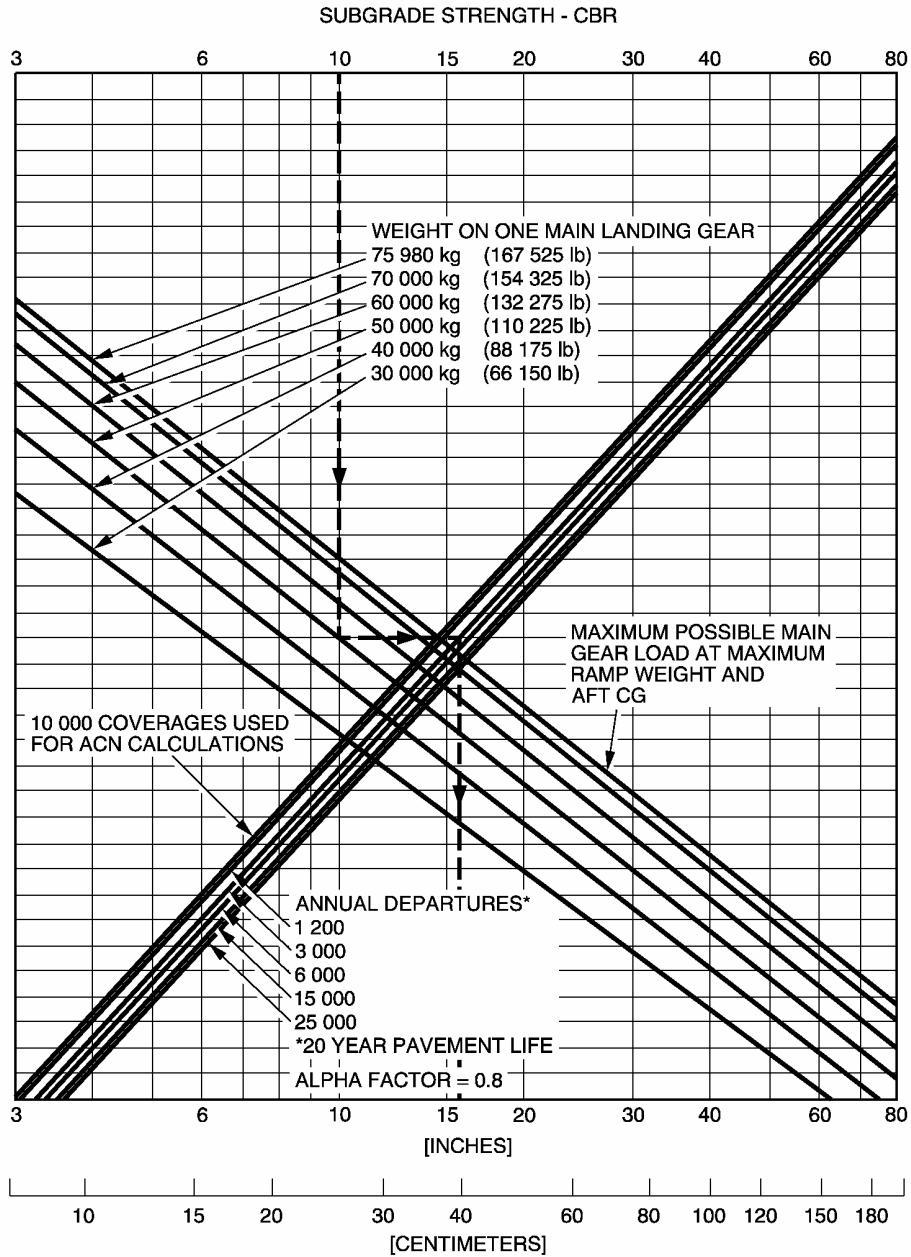

BA5 07 05 01 1 BEM0 00

FLEXIBLE PAVEMENT THICKNESS

49 x 17 - 20 TIRES

TIRE PRESSURE CONSTANT AT 12.6 BAR (183 PSI)

Flexible Pavement Requirements
A310-300 Models - MRW 160 900 kg

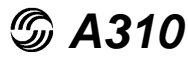

AIRPLANE CHARACTERISTICS FOR AIRPORT PLANNING

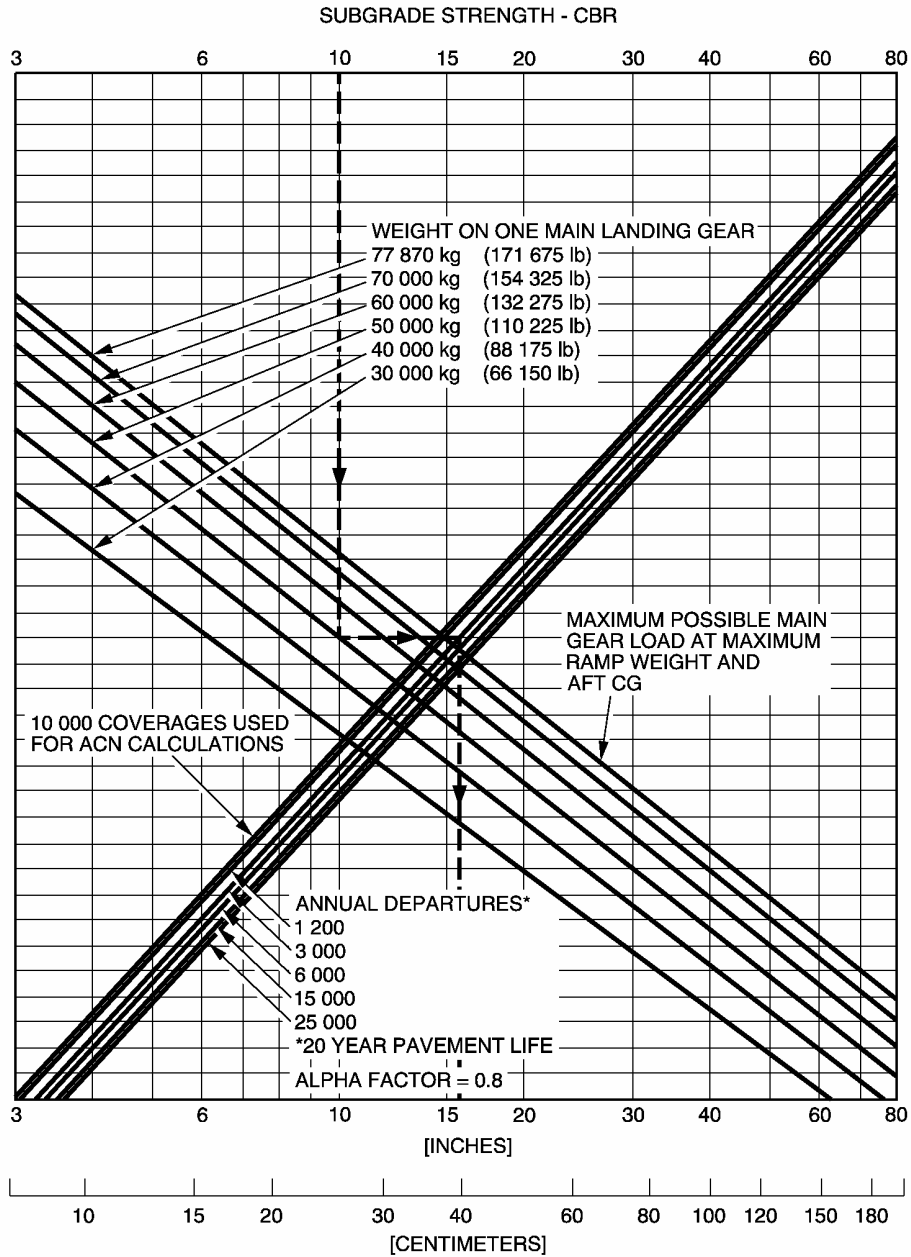

FLEXIBLE PAVEMENT THICKNESS

49 x 17 - 20 TIRES

TIRE PRESSURE CONSTANT AT 12.9 BAR (187 PSI)

Flexible Pavement Requirements
A310-300 Models - MRW 164 900 kg

BA5 07 05 01 1 BGM0 00

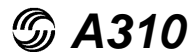

AIRPLANE CHARACTERISTICS FOR AIRPORT PLANNING

7.6 Flexible Pavement Requirements - LCN Conversion

To find the airplane weight that a Flexible Pavement can support, the LCN of the pavement and the thickness (h) must be known.

- A310-200 Models

In the example shown in Section 7.6.1 with MRW 132 900 kg.

The thickness (h) is shown at 762 mm (30 in.) with an LCN of 81.

For these conditions the weight on one Main Landing Gear is 60 000 kg (132 275 lb).

- A310-300 Models

In the example shown in Section 7.6.1 with MRW 139 500 kg.

The thickness (h) is shown at 762 mm (30 in.) with an LCN of 84.

For these conditions the weight on one Main Landing Gear is 60 000 kg (132 275 lb).

AIRPLANE CHARACTERISTICS FOR AIRPORT PLANNING

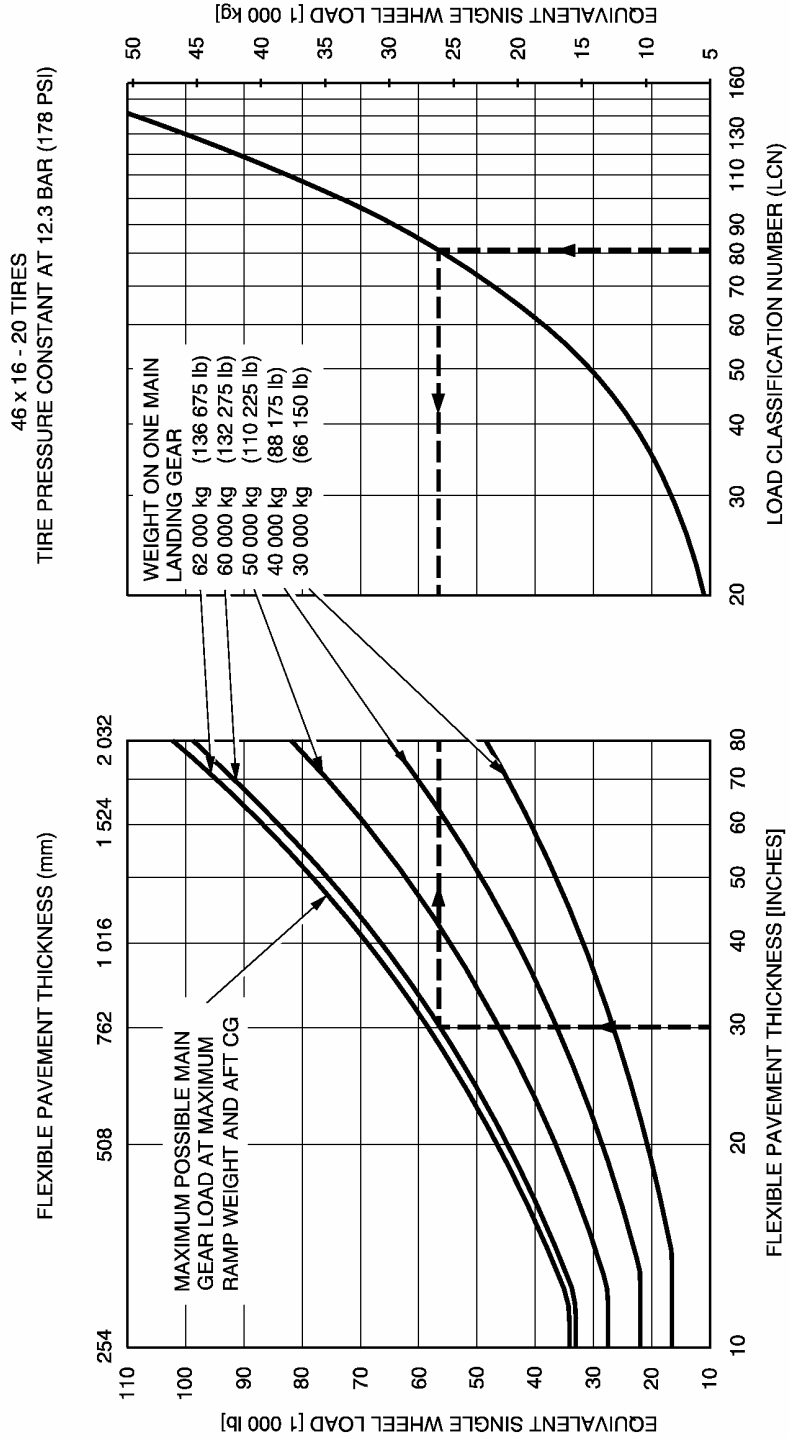

NOTE: EQUIVALENT SINGLE WHEEL LOADS ARE DERIVED BY METHODS SHOWN IN ICAO AERODROME MANUAL PART 2 PAR 4.1.3. Second Edition 1965.

Flexible Pavement Requirements LCN
A310-200 Models - MRW 132 900 kg

BA5 07 06 01 1 AAM0 00

AIRPLANE CHARACTERISTICS FOR AIRPORT PLANNING

BA5 07 06 01 1 ACM0 00

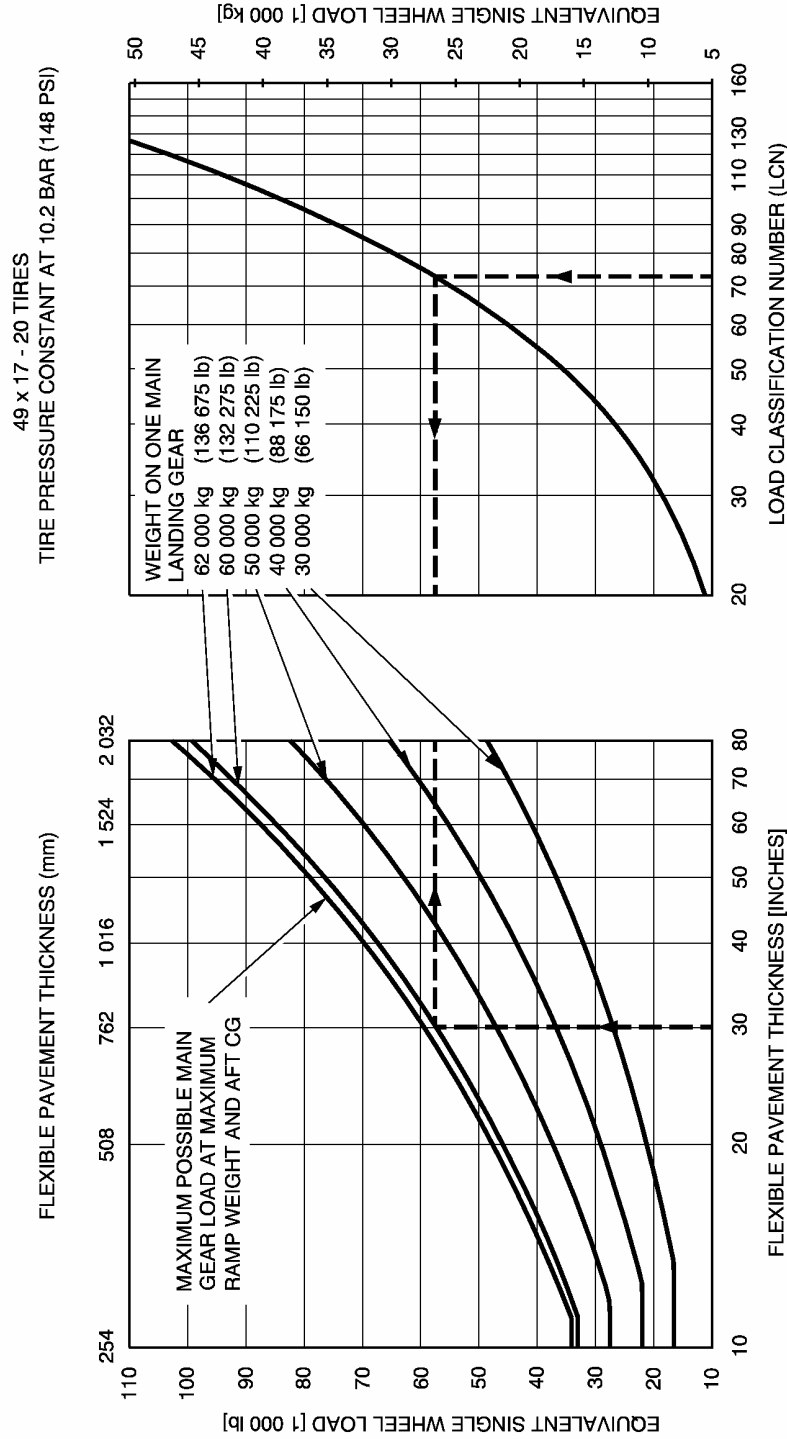

**Flexible Pavement Requirements LCN
A310-200 Models - MRW 132 900 kg**

NOTE: EQUIVALENT SINGLE WHEEL LOADS ARE DERIVED BY METHODS SHOWN IN ICAO AERODROME MANUAL PART 2 PAR 4.1.3. Second Edition 1965.

AIRPLANE CHARACTERISTICS FOR AIRPORT PLANNING

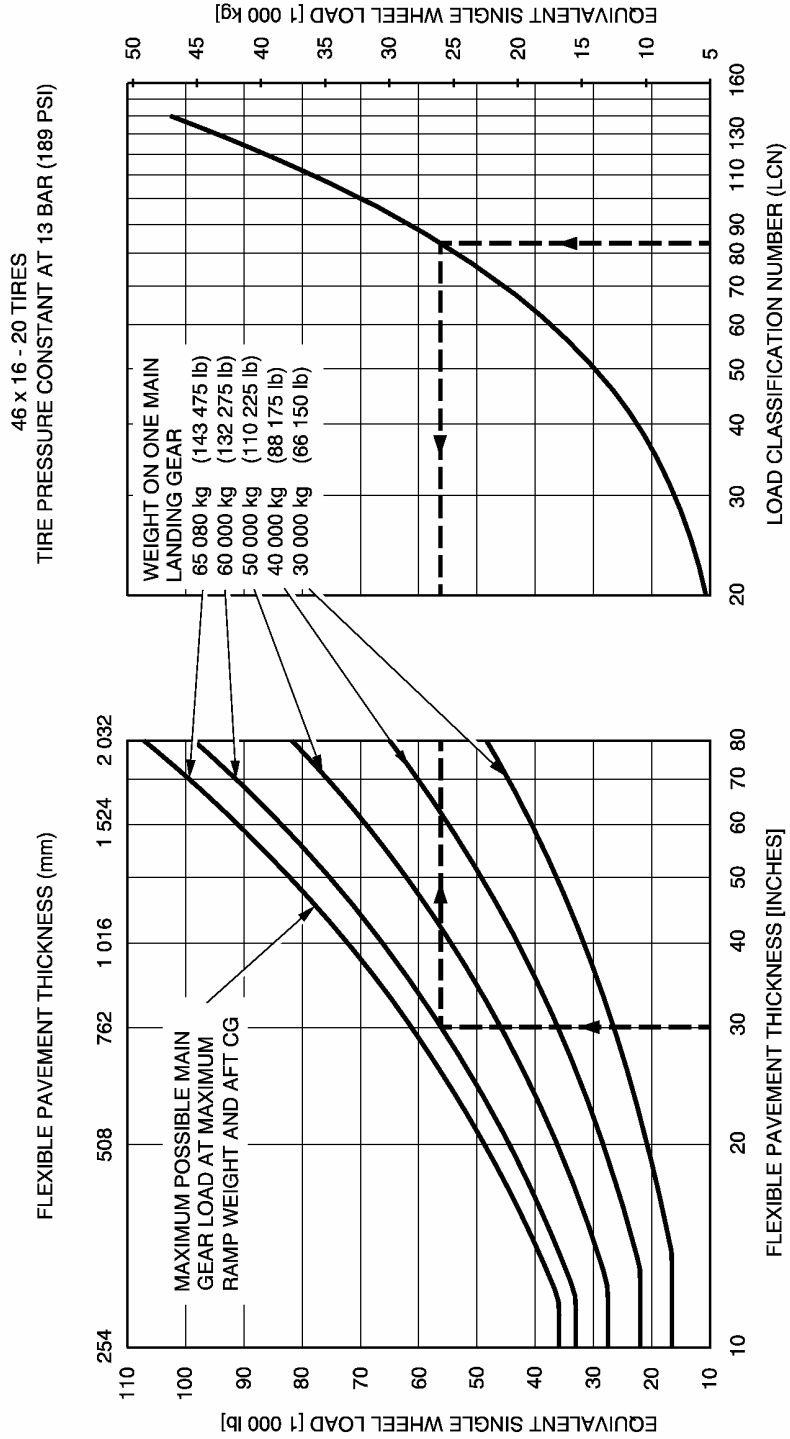

NOTE: EQUIVALENT SINGLE WHEEL LOADS ARE DERIVED BY METHODS SHOWN IN ICAO AERODROME MANUAL PART 2 PAR 4.1.3. Second Edition 1965.

BA5 07 06 01 1 AEM0 00

Flexible Pavement Requirements LCN
A310-200 Models - MRW 139 500 kg

AIRPLANE CHARACTERISTICS FOR AIRPORT PLANNING

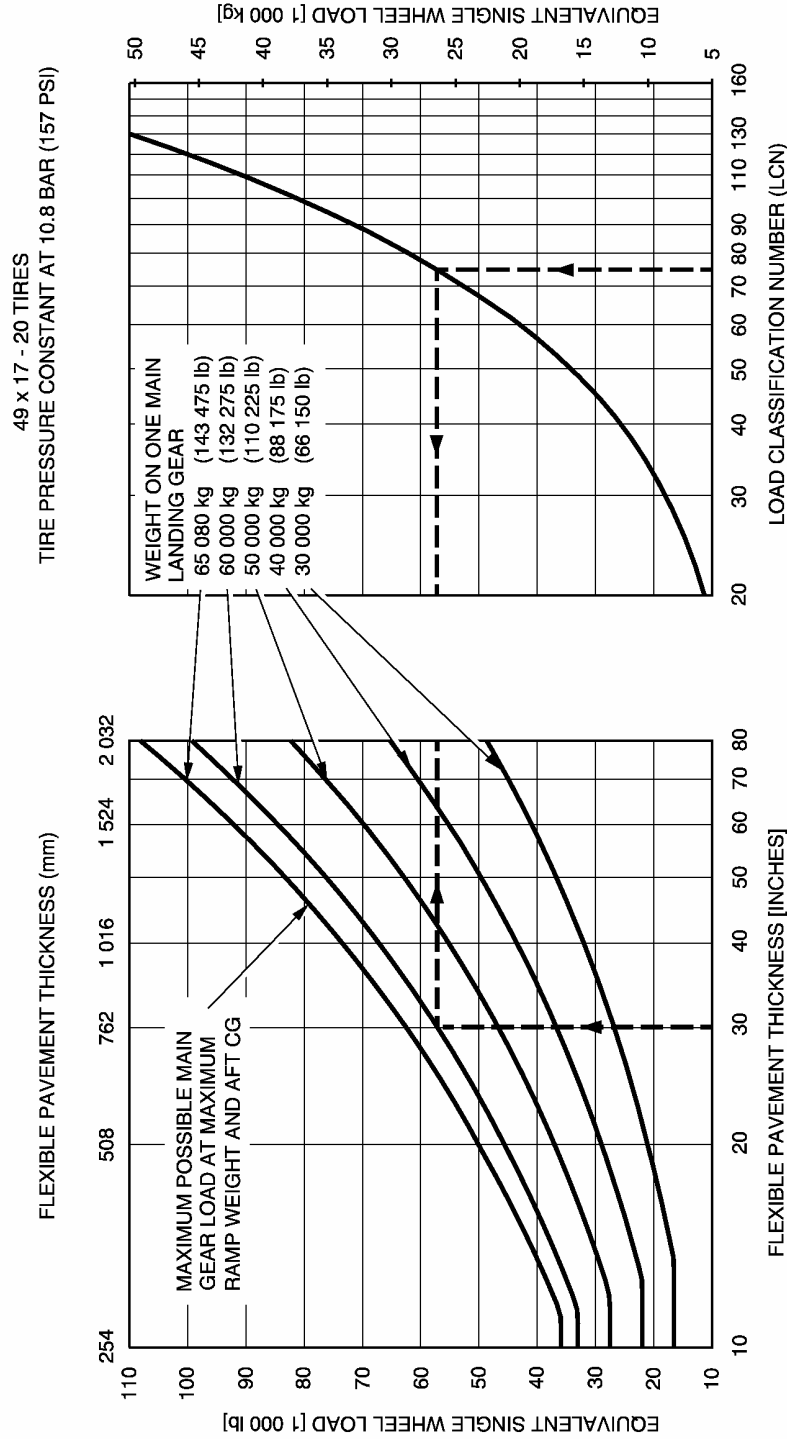

NOTE: EQUIVALENT SINGLE WHEEL LOADS ARE DERIVED BY METHODS SHOWN IN ICAO AERODROME MANUAL PART 2 PAR 4.1.3. Second Edition 1965.

BA5 07 06 01 1 AGM0 00

**Flexible Pavement Requirements LCN
A310-200 Models - MRW 139 500 kg**

AIRPLANE CHARACTERISTICS FOR AIRPORT PLANNING

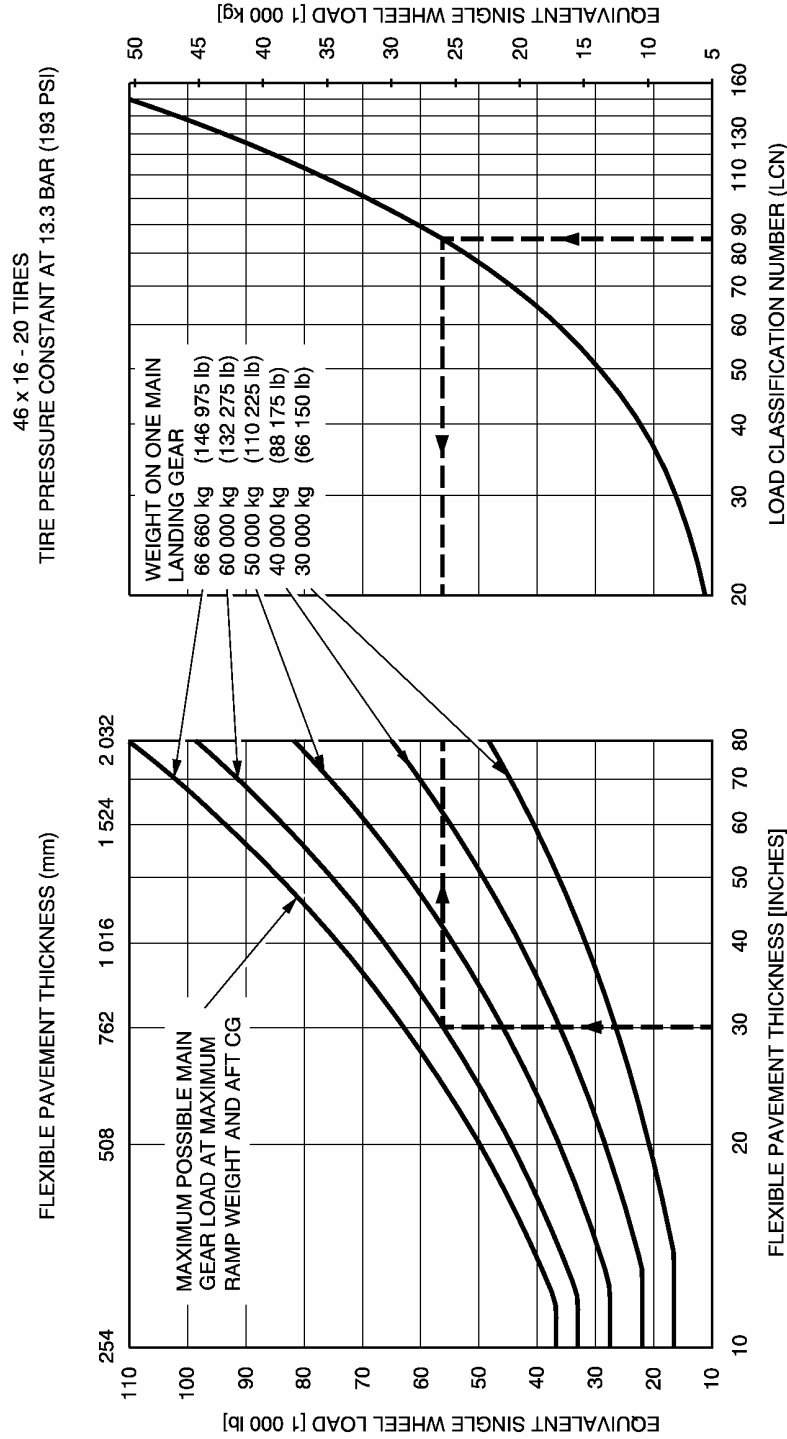

**Flexible Pavement Requirements LCN
A310-200 Models - MRW 142 900 kg**

NOTE: EQUIVALENT SINGLE WHEEL LOADS ARE DERIVED BY METHODS SHOWN IN ICAO AERODROME MANUAL PART 2 PAR 4.1.3. Second Edition 1965.

BA5 07 06 01 1 AJM0 00

AIRPLANE CHARACTERISTICS FOR AIRPORT PLANNING

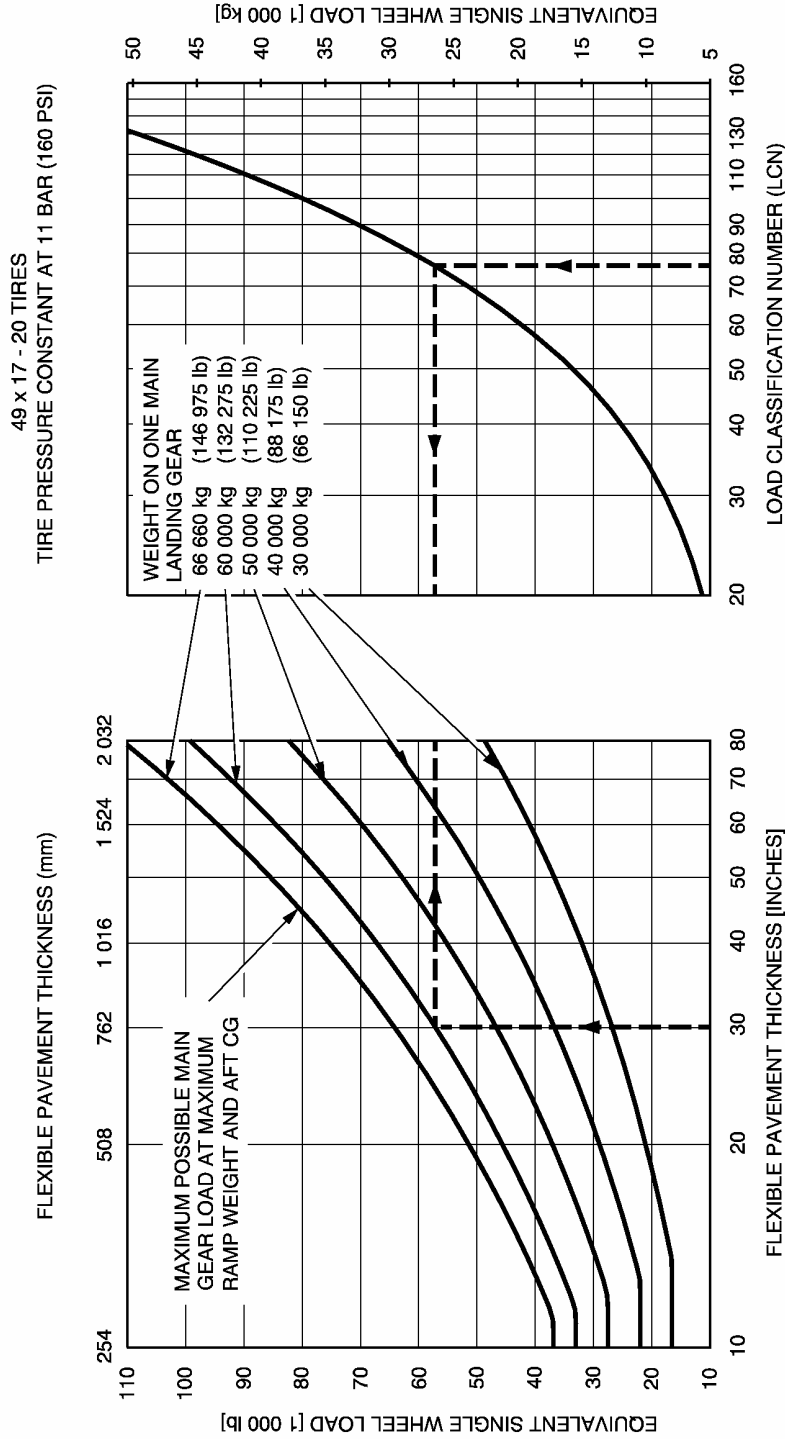

NOTE: EQUIVALENT SINGLE WHEEL LOADS ARE DERIVED BY METHODS SHOWN IN ICAO AERODROME MANUAL PART 2 PAR 4.1.3. Second Edition 1965.

**Flexible Pavement Requirements LCN
A310-200 Models - MRW 142 900 kg**

BA5 07 06 01 1 ALM0 00

AIRPLANE CHARACTERISTICS FOR AIRPORT PLANNING

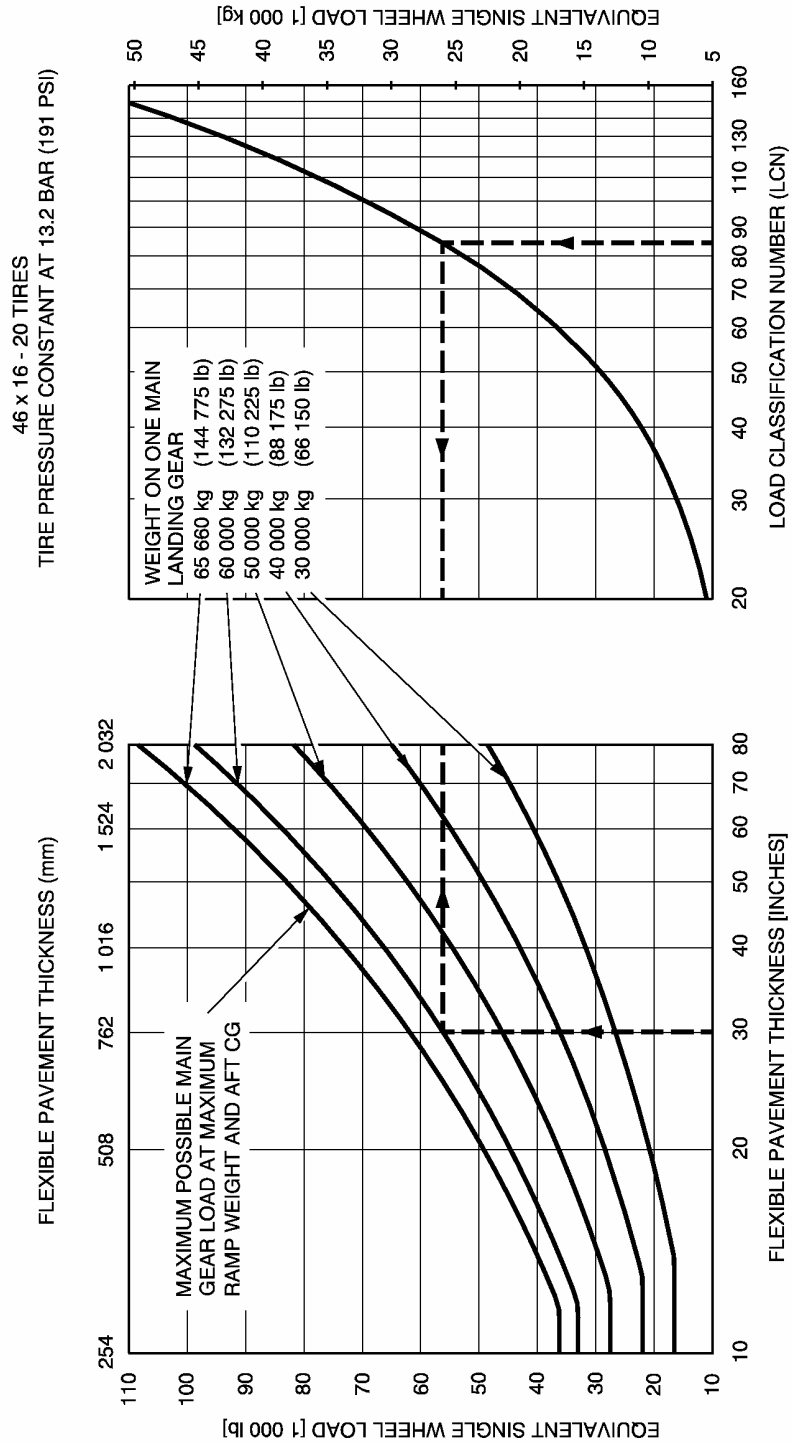

NOTE: EQUIVALENT SINGLE WHEEL LOADS ARE DERIVED BY METHODS SHOWN IN ICAO AERODROME MANUAL PART 2 PAR 4.1.3. Second Edition 1965.

BA5 07.06.01.1 ANIM0 00

AIRPLANE CHARACTERISTICS FOR AIRPORT PLANNING

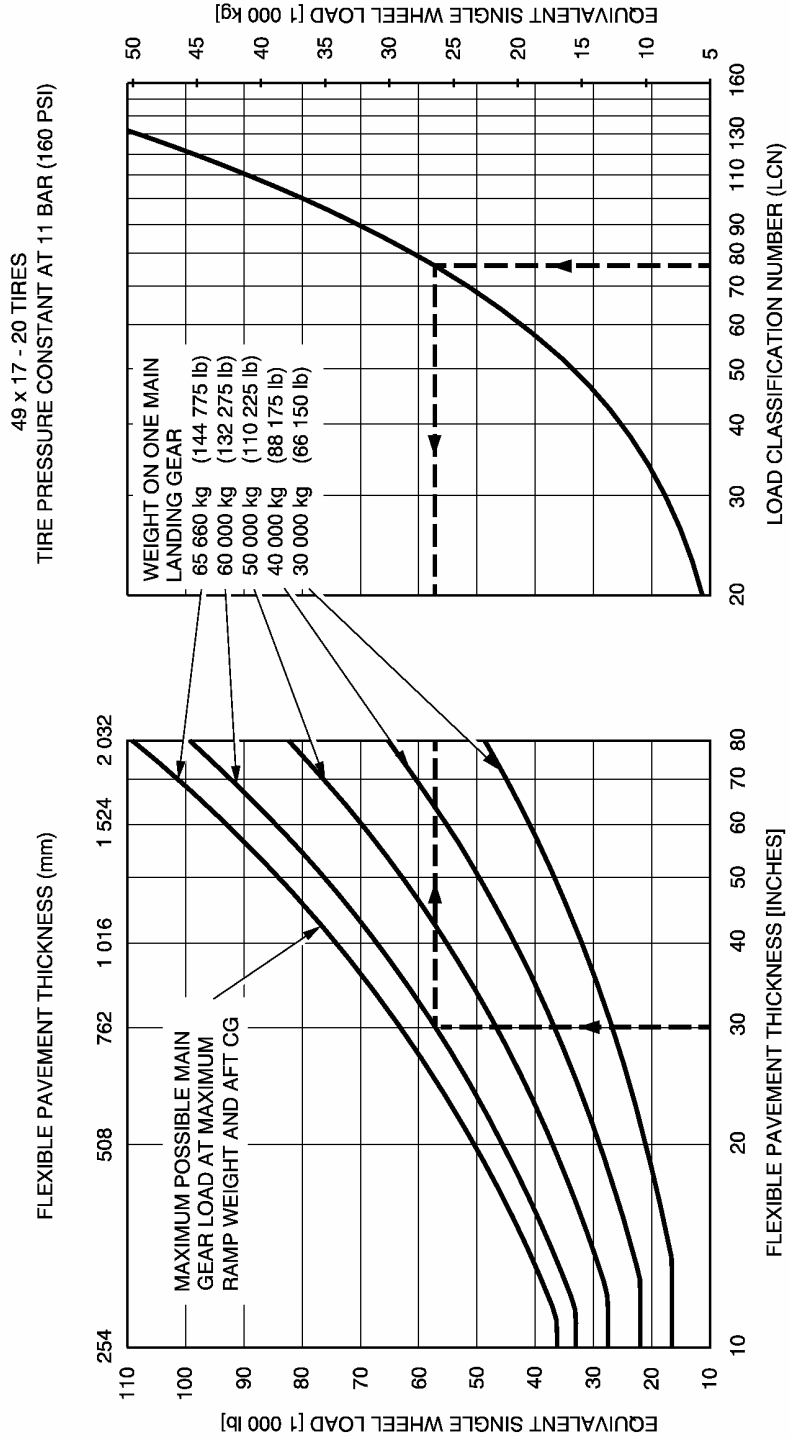

NOTE: EQUIVALENT SINGLE WHEEL LOADS ARE DERIVED BY METHODS SHOWN IN ICAO AERODROME MANUAL PART 2 PAR 4.1.3. Second Edition 1965.

**Flexible Pavement Requirements LCN
A310-300 Models - MRW 139 500 kg**

BA5 07 06 01 1 AQM0 00

AIRPLANE CHARACTERISTICS FOR AIRPORT PLANNING

BA5 07 06 01 1 ASM0 00

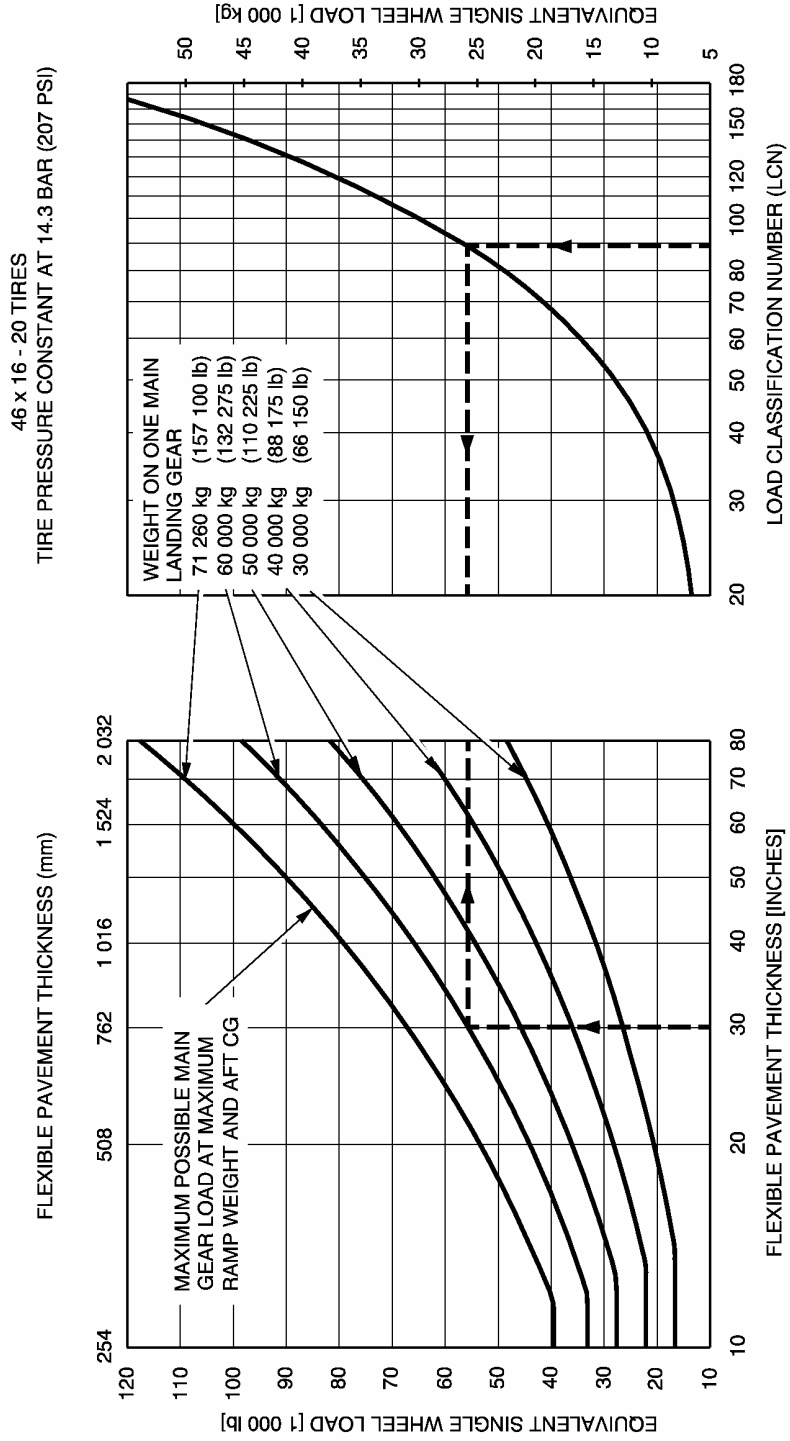

NOTE: EQUIVALENT SINGLE WHEEL LOADS ARE DERIVED BY METHODS SHOWN IN ICAO AERODROME MANUAL PART 2 PAR 4.1.3. Second Edition 1965.

**Flexible Pavement Requirements LCN
A310-300 Models - MRW 150 900 kg**

AIRPLANE CHARACTERISTICS FOR AIRPORT PLANNING

BA5 07 06 01 1 AUM0 00

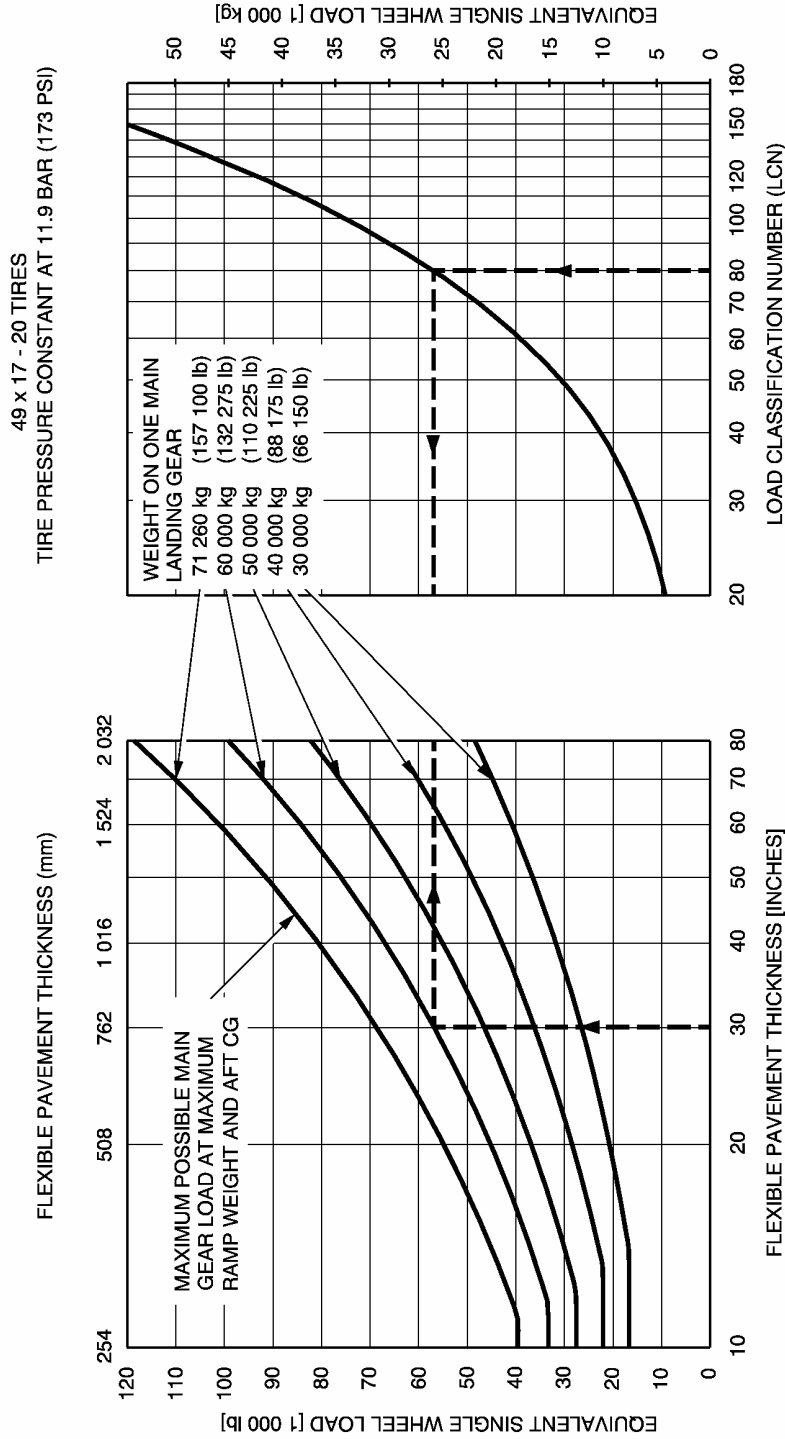

NOTE: EQUIVALENT SINGLE WHEEL LOADS ARE DERIVED BY METHODS SHOWN IN ICAO AERODROME MANUAL PART 2 PAR 4.1.3. Second Edition 1965.

**Flexible Pavement Requirements LCN
A310-300 Models - MRW 150 900 kg**

AIRPLANE CHARACTERISTICS FOR AIRPORT PLANNING

BA5 07 06 01 1 AWM0 00

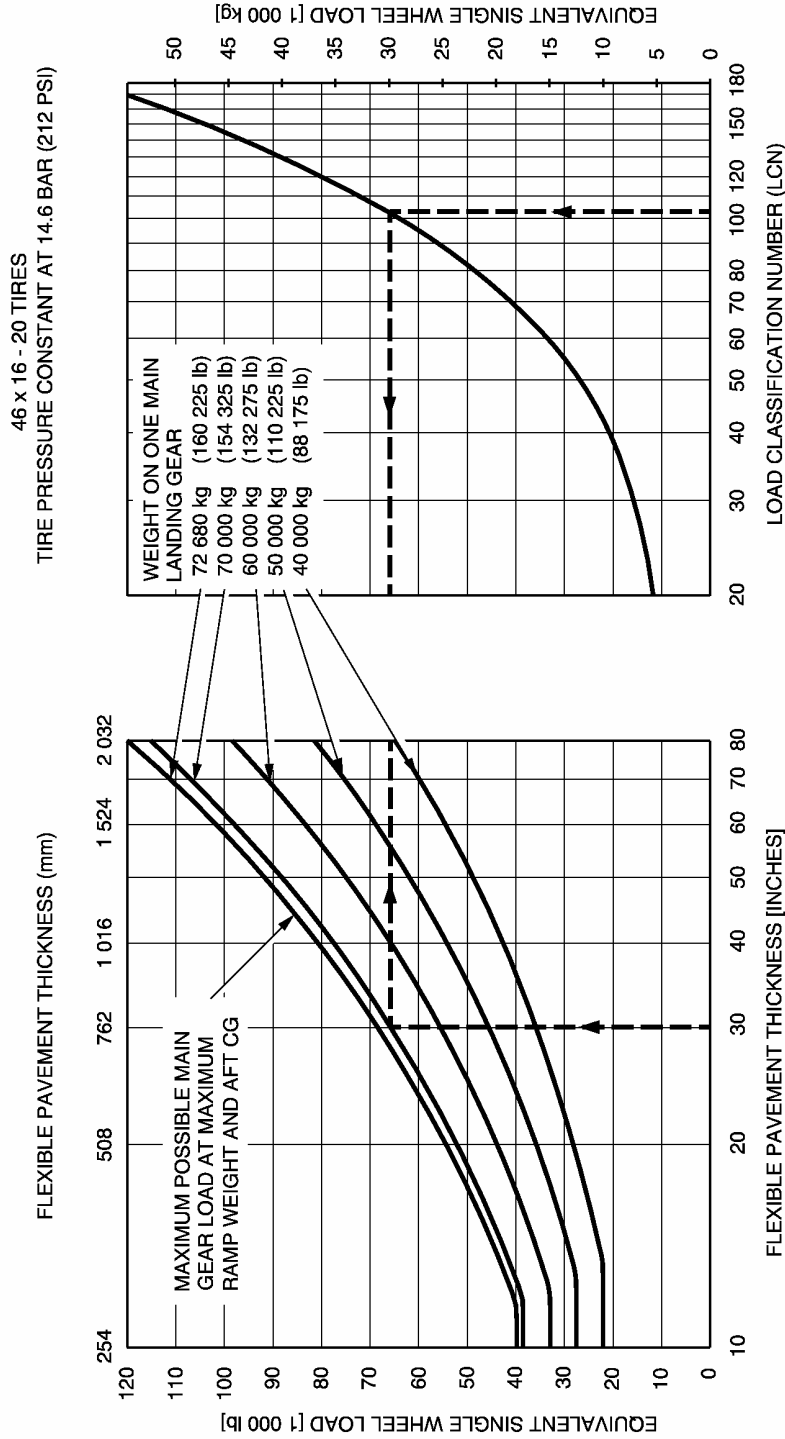

NOTE: EQUIVALENT SINGLE WHEEL LOADS ARE DERIVED BY METHODS SHOWN IN ICAO AERODROME MANUAL PART 2 PAR 4.1.3. Second Edition 1965.

**Flexible Pavement Requirements LCN
A310-300 Models - MRW 153 900 kg**

AIRPLANE CHARACTERISTICS FOR AIRPORT PLANNING

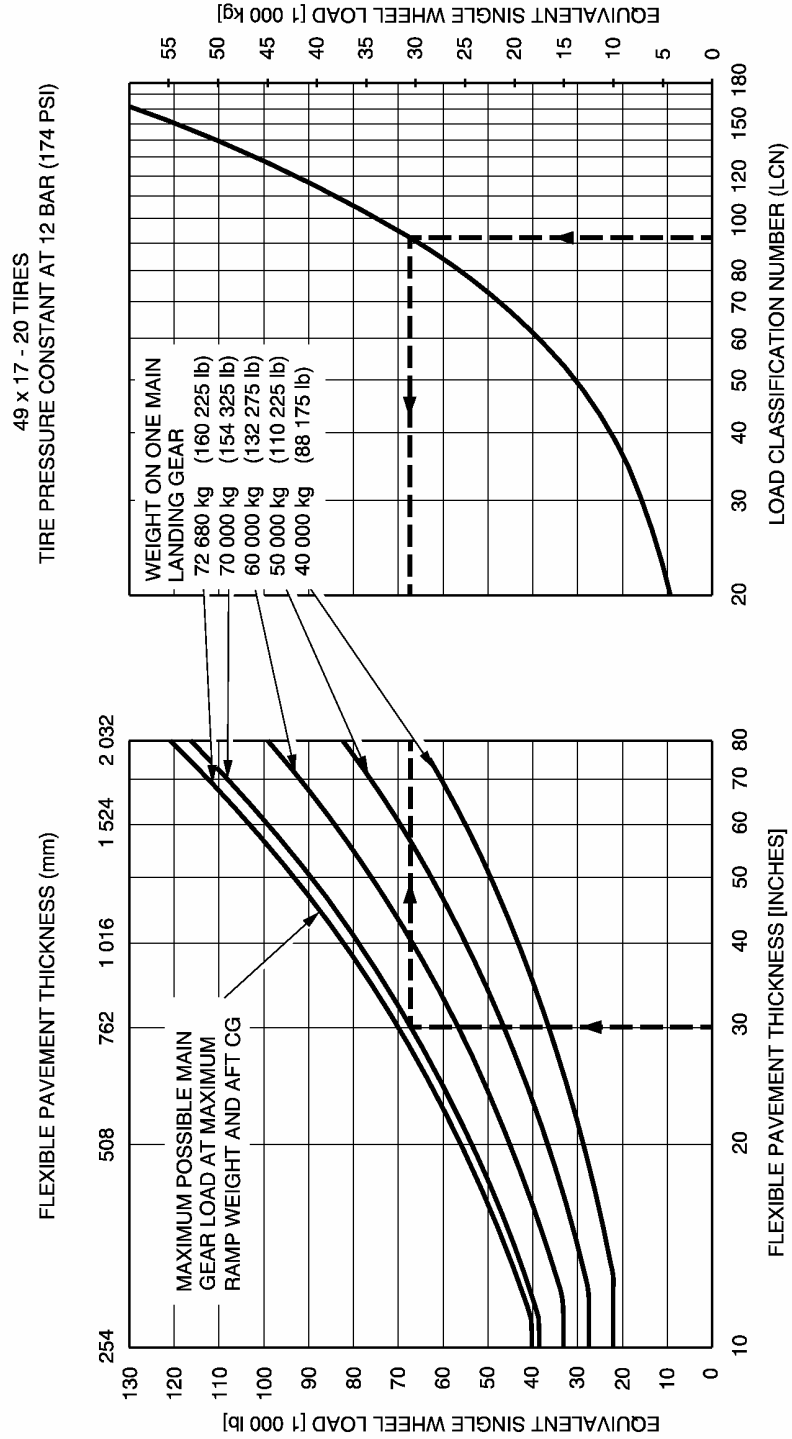

NOTE: EQUIVALENT SINGLE WHEEL LOADS ARE DERIVED BY METHODS SHOWN IN ICAO AERODROME MANUAL PART 2 PAR 4.1.3. Second Edition 1965.

Flexible Pavement Requirements LCN
A310-300 Models - MRW 153 900 kg

BA5 07 06 01 1 AYM0 00

AIRPLANE CHARACTERISTICS FOR AIRPORT PLANNING

BA5 07 06 01 1 BAM0 00

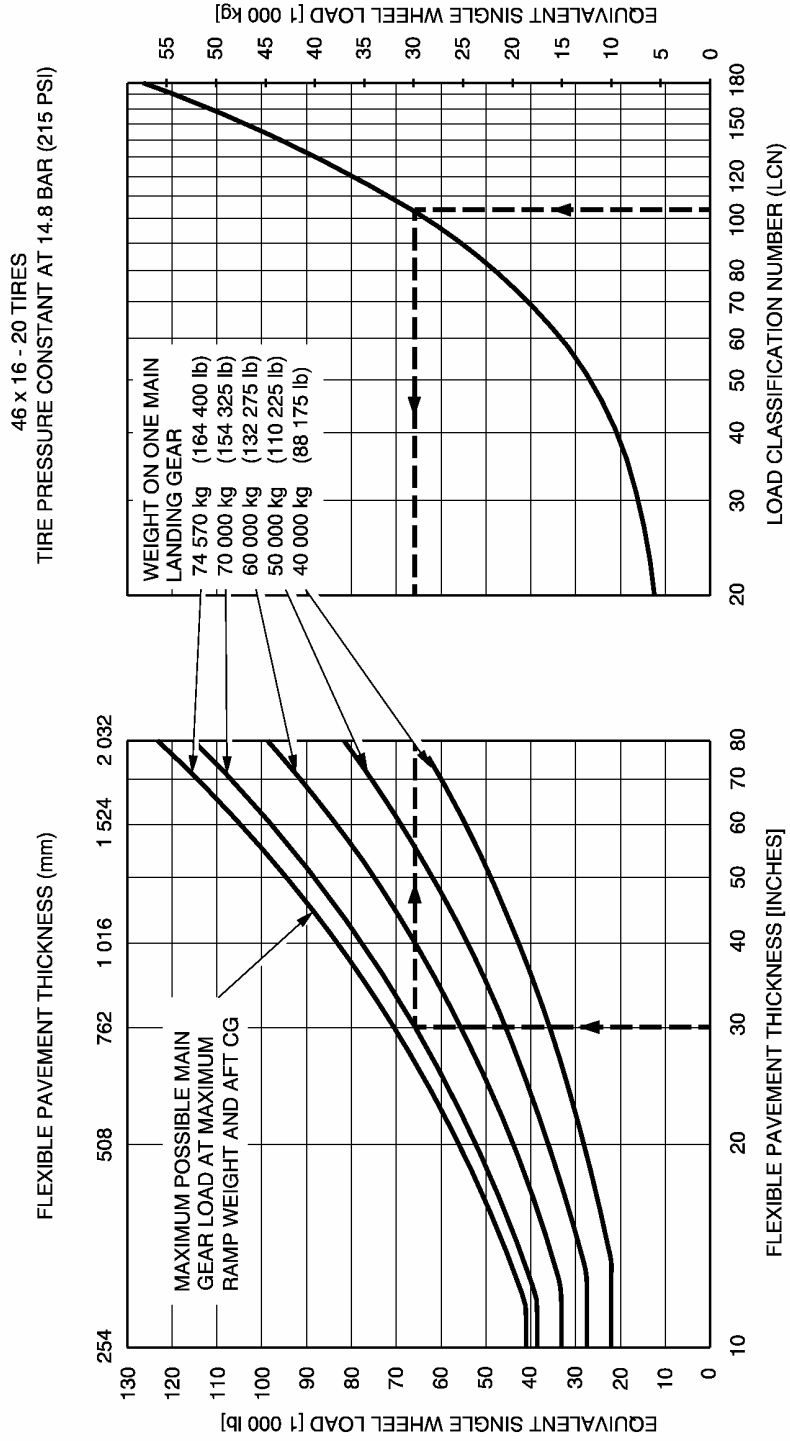

**Flexible Pavement Requirements LCN
A310-300 Models - MRW 157 900 kg**

NOTE: EQUIVALENT SINGLE WHEEL LOADS ARE DERIVED BY METHODS SHOWN IN ICAO AERODROME MANUAL PART 2 PAR 4.1.3. Second Edition 1965.

AIRPLANE CHARACTERISTICS FOR AIRPORT PLANNING

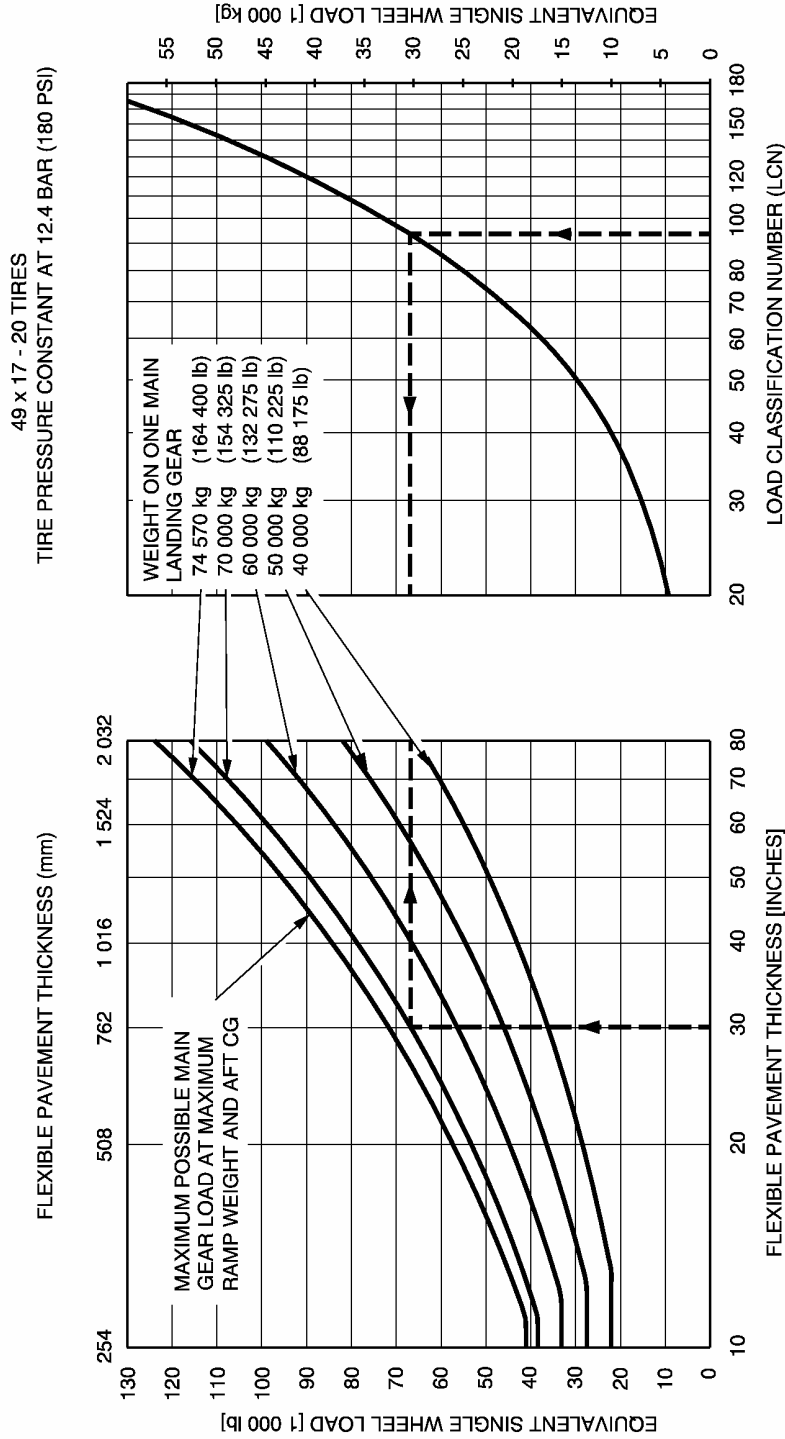

NOTE: EQUIVALENT SINGLE WHEEL LOADS ARE DERIVED BY METHODS SHOWN IN ICAO AERODROME MANUAL PART 2 PAR 4.1.3. Second Edition 1965.

BA5 07 06 01 1 BCM0 00

AIRPLANE CHARACTERISTICS FOR AIRPORT PLANNING

BA5 07 06 01 1 BEM0 00

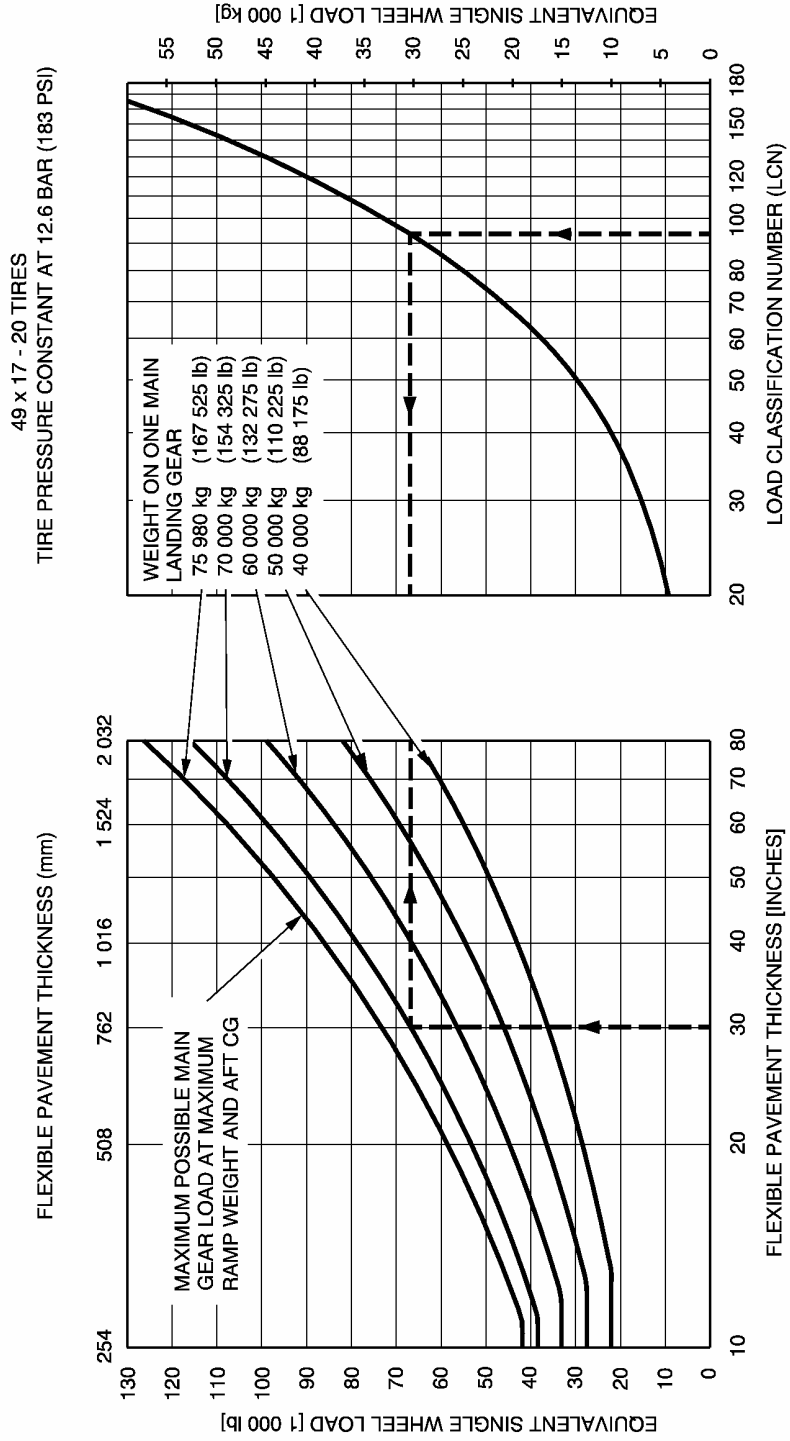

Flexible Pavement Requirements LCN
A310-300 Models - MRW 160 900 kg

NOTE: EQUIVALENT SINGLE WHEEL LOADS ARE DERIVED BY METHODS SHOWN IN ICAO AERODROME MANUAL PART 2 PAR 4.1.3. Second Edition 1965.

AIRPLANE CHARACTERISTICS FOR AIRPORT PLANNING

BA5 07 06 01 1 BGM0 00

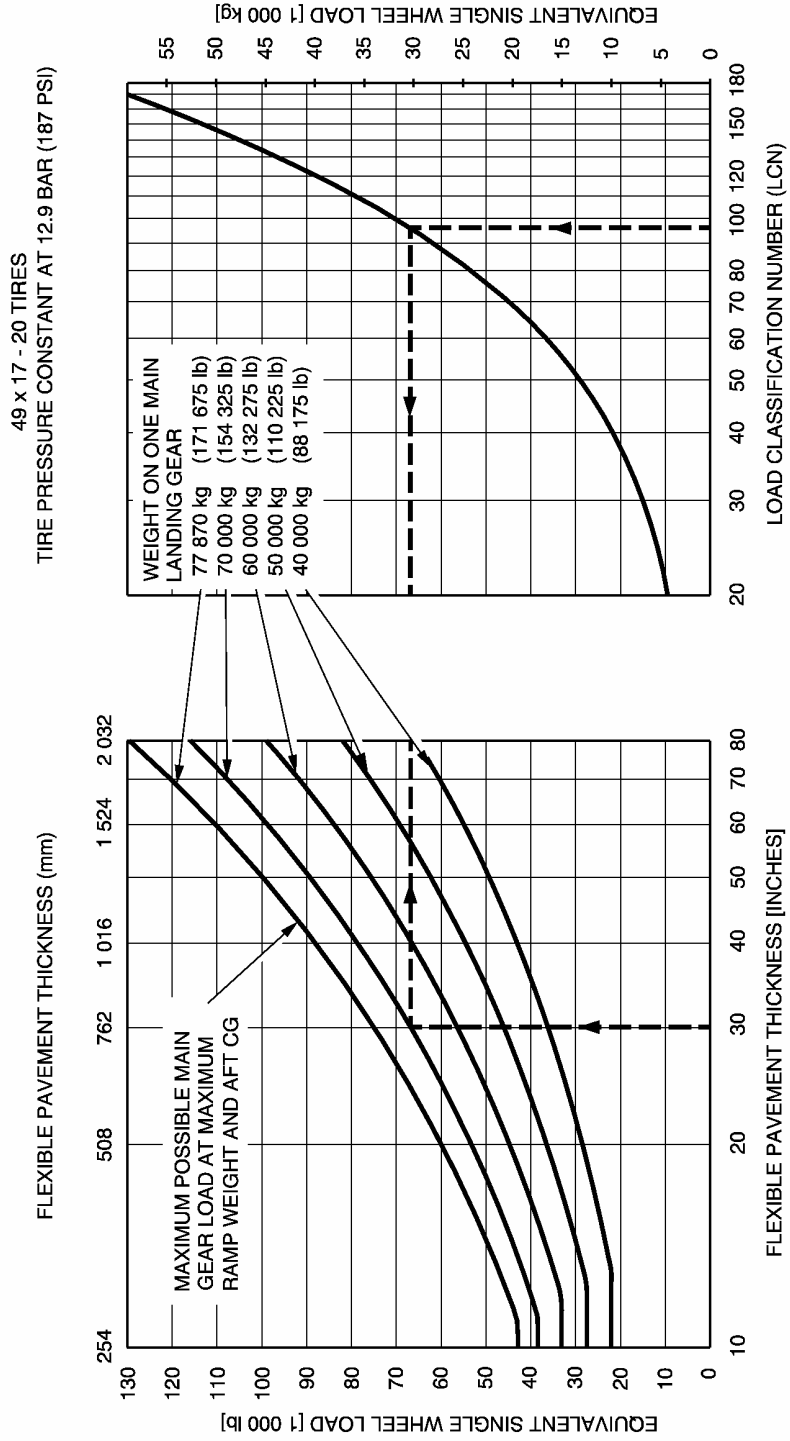

NOTE: EQUIVALENT SINGLE WHEEL LOADS ARE DERIVED BY METHODS SHOWN IN ICAO AERODROME MANUAL PART 2 PAR 4.1.3. Second Edition 1965.

Flexible Pavement Requirements LCN
A310-300 Models - MRW 164 900 kg

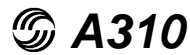

AIRPLANE CHARACTERISTICS FOR AIRPORT PLANNING

7.7 Rigid Pavement Requirements - Portland Cement Association Design Method

To determine a Rigid Pavement Thickness, the Subgrade Modulus (k), the allowable working stress and the weight on one Main Landing Gear must be known.

- A310-200 Models

In the typical example shown in Section 7.7.1 with MRW 132 900 kg for :

- a k value of 150 MN/m³ (K = 550 lbF/in³)
- an allowable working stress of 28 kg/cm² (400 lb/in²)
- the Load on one Wing Landing Gear of 50 000 kg (110 225 lb)
the required Rigid Pavement Thickness is 21.5 cm (8.51 inches).

- A310-300 Models

In the typical example shown in Section 7.7.1 with MRW 139 500 kg for :

- a k value of 150 MN/m³ (K = 550 lbF/in³)
- an allowable working stress of 28 kg/cm² (400 lb/in²)
- the Load on one Wing Landing Gear of 50 000 kg (110 225 lb)
the required Rigid Pavement Thickness is 21.7 cm (8.51 inches).

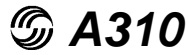

AIRPLANE CHARACTERISTICS FOR AIRPORT PLANNING

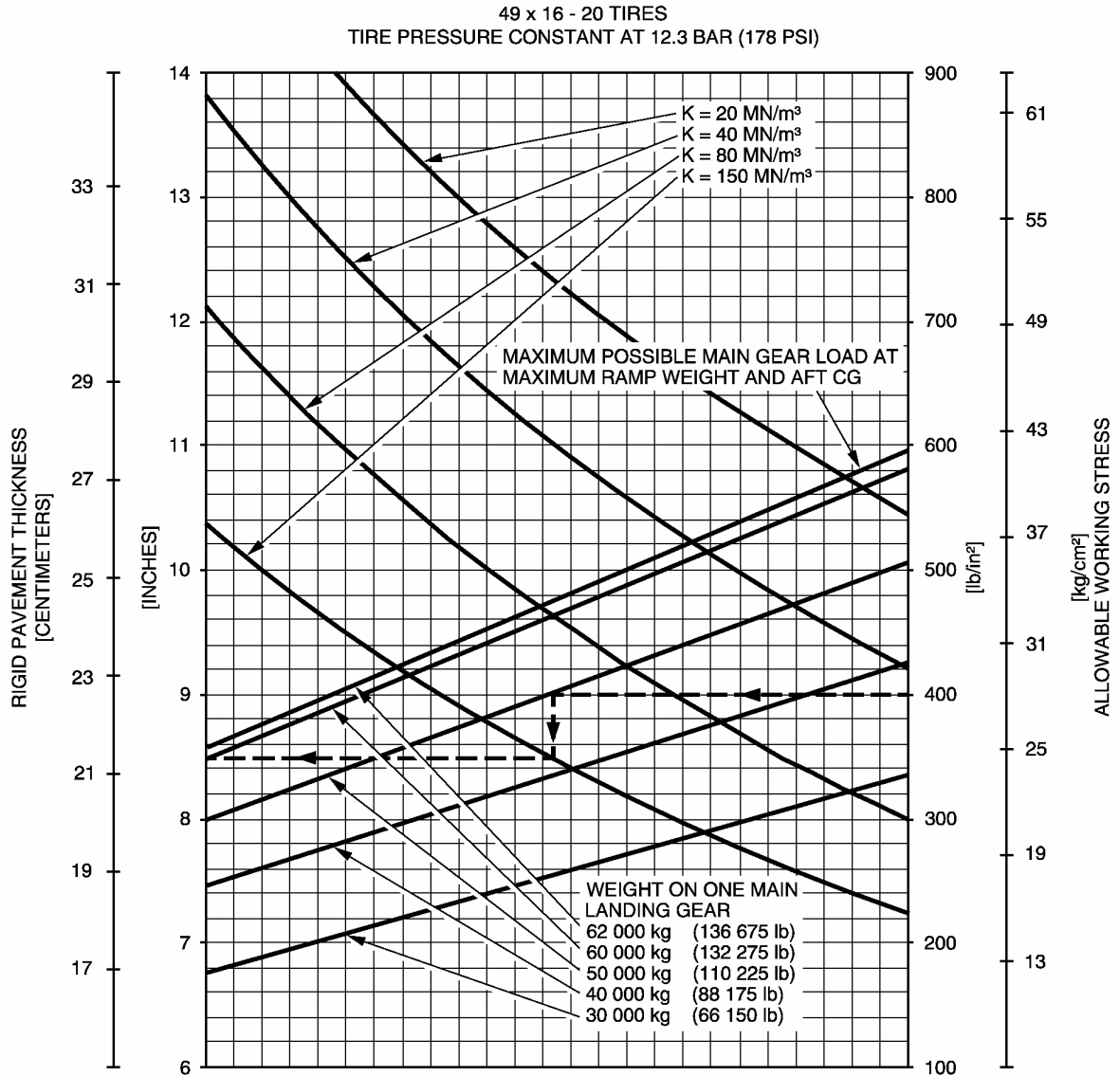

NOTE: THE VALUES OBTAINED BY USING THE MAXIMUM LOAD REFERENCE LINE AND ANY VALUES FOR K ARE EXACT. FOR LOADS LESS THAN MAXIMUM, THE CURVES ARE EXACT FOR $K = 80 \text{ MN/m}^3$ BUT DEVIATE SLIGHTLY FOR ANY OTHER VALUES OF K.

REFERENCE: "DESIGN OF CONCRETE AIRPORT PAVEMENTS" AND "COMPUTER PROGRAM FOR AIRPORT PAVEMENT DESIGN - PROGRAM PDILB" PORTLAND CEMENT ASSOCIATION.

BA5 07 07 01 1 AAM0 00

Rigid Pavement Requirements
A310-200 Models - MRW 132 900 kg

Chapter 7.7.1
Page 1
DEC 01/09

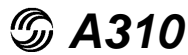

AIRPLANE CHARACTERISTICS FOR AIRPORT PLANNING

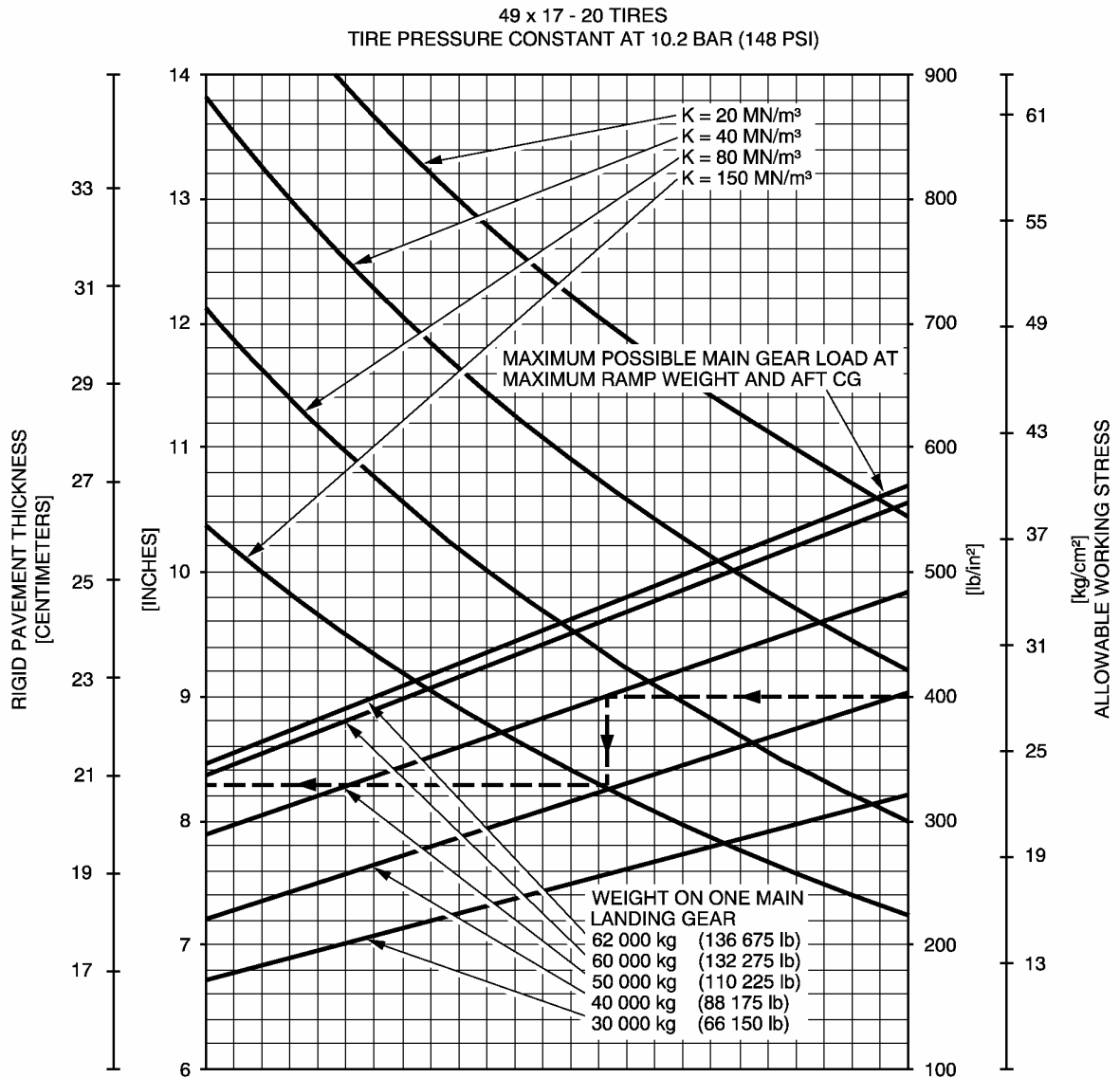

NOTE: THE VALUES OBTAINED BY USING THE MAXIMUM LOAD REFERENCE LINE AND ANY VALUES FOR K ARE EXACT. FOR LOADS LESS THAN MAXIMUM, THE CURVES ARE EXACT FOR K = 80 MN/m³ BUT DEVIATE SLIGHTLY FOR ANY OTHER VALUES OF K.

REFERENCE: "DESIGN OF CONCRETE AIRPORT PAVEMENTS" AND "COMPUTER PROGRAM FOR AIRPORT PAVEMENT DESIGN - PROGRAM PDILB" PORTLAND CEMENT ASSOCIATION.

BA5 07 07 01 1 ACM0 00

Rigid Pavement Requirements
A310-200 Models - MRW 132 900 kg

Chapter 7.7.1
Page 2
DEC 01/09

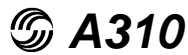

AIRPLANE CHARACTERISTICS FOR AIRPORT PLANNING

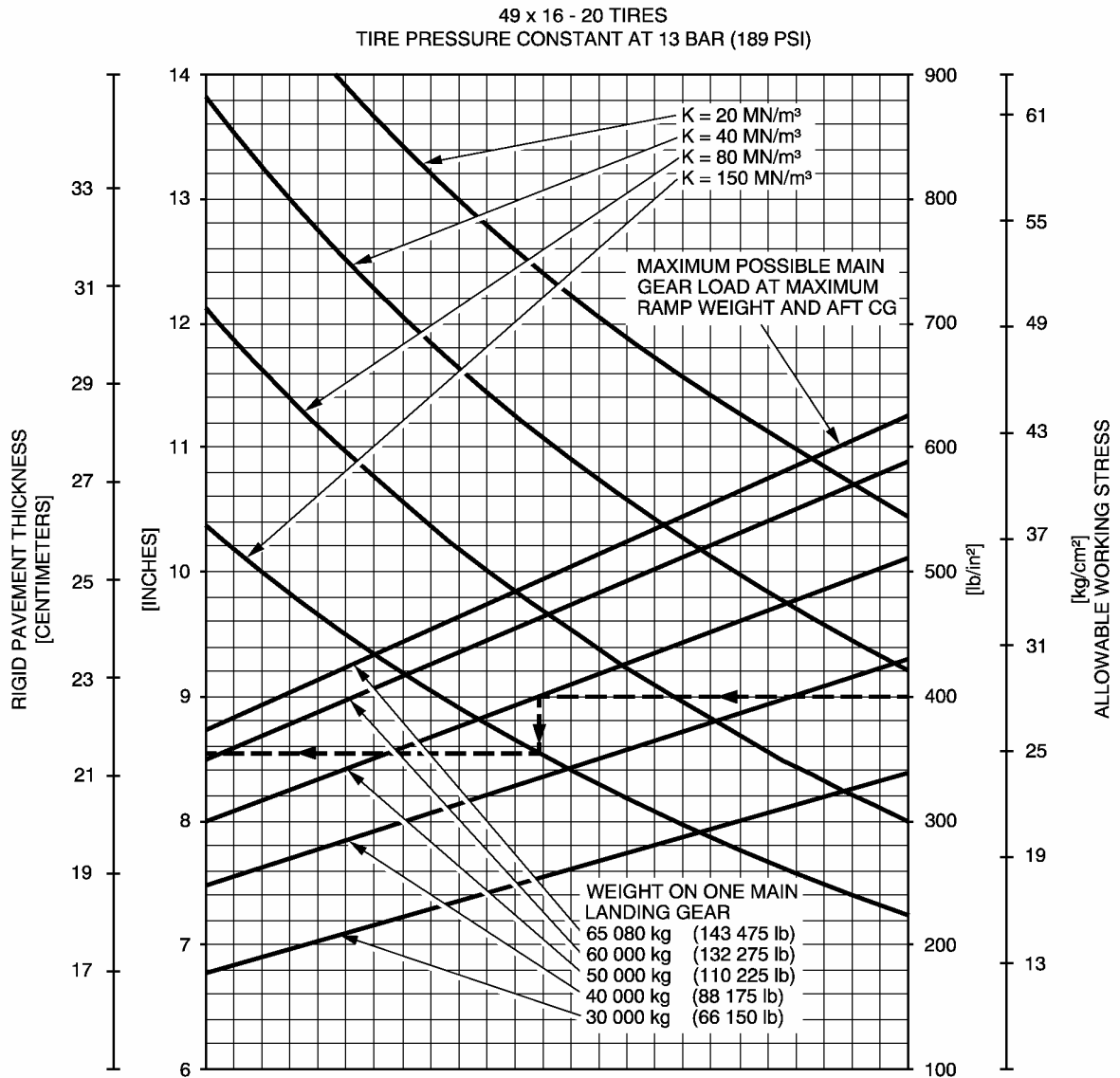

NOTE: THE VALUES OBTAINED BY USING THE MAXIMUM LOAD REFERENCE LINE AND ANY VALUES FOR K ARE EXACT. FOR LOADS LESS THAN MAXIMUM, THE CURVES ARE EXACT FOR K = 80 MN/m³ BUT DEVIATE SLIGHTLY FOR ANY OTHER VALUES OF K.

REFERENCE: "DESIGN OF CONCRETE AIRPORT PAVEMENTS" AND "COMPUTER PROGRAM FOR AIRPORT PAVEMENT DESIGN - PROGRAM PDILB" PORTLAND CEMENT ASSOCIATION.

BA5 07 07 01 1 AEM0 00

Rigid Pavement Requirements
A310-200 Models - MRW 139 500 kg

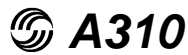

AIRPLANE CHARACTERISTICS FOR AIRPORT PLANNING

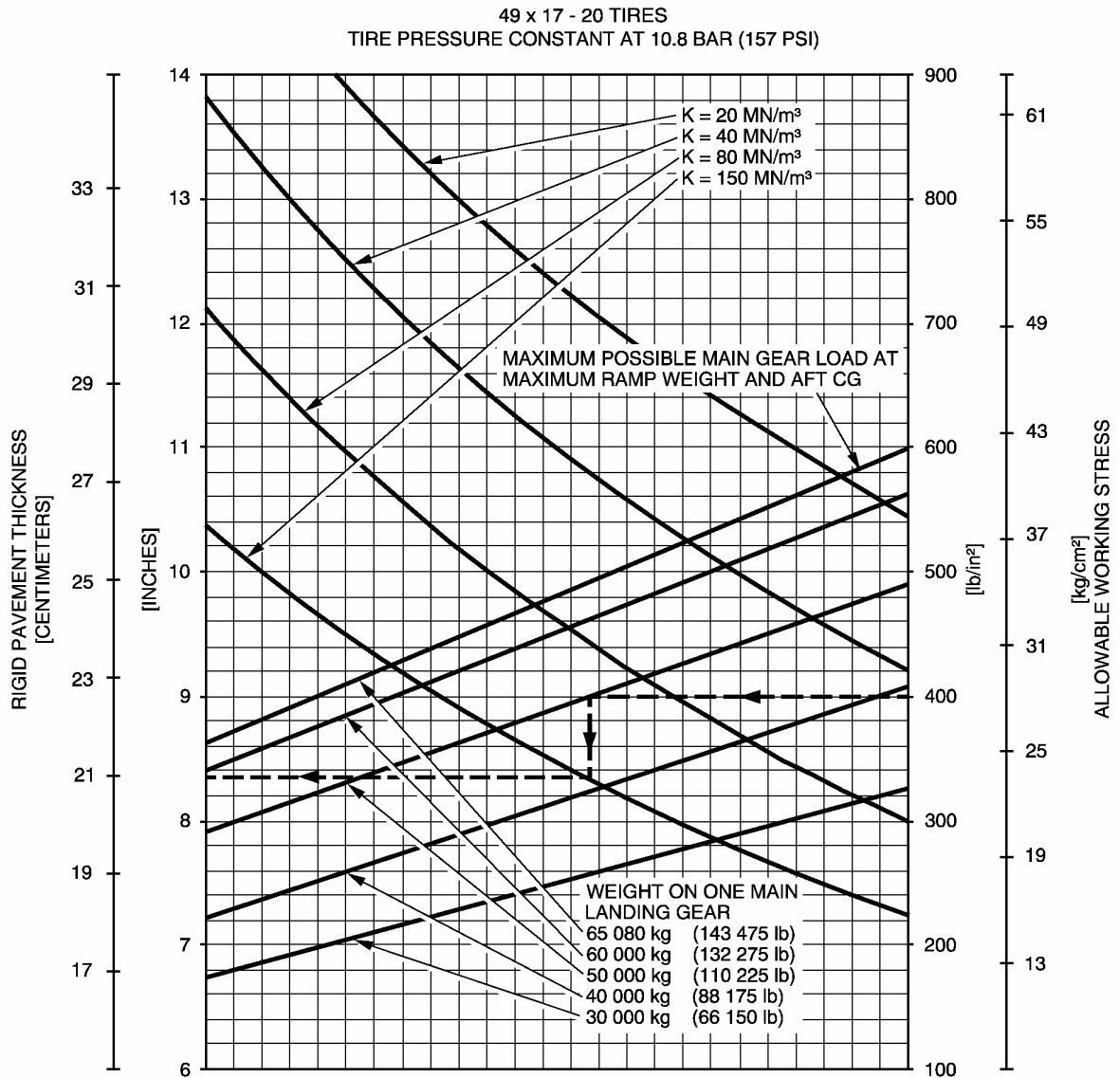

BA5 07 07 01 1 AGM0 00

NOTE: THE VALUES OBTAINED BY USING THE MAXIMUM LOAD REFERENCE LINE AND ANY VALUES FOR K ARE EXACT. FOR LOADS LESS THAN MAXIMUM, THE CURVES ARE EXACT FOR $K = 80 \text{ MN/m}^3$ BUT DEVIATE SLIGHTLY FOR ANY OTHER VALUES OF K.

REFERENCE: "DESIGN OF CONCRETE AIRPORT PAVEMENTS" AND "COMPUTER PROGRAM FOR AIRPORT PAVEMENT DESIGN - PROGRAM PDILB" PORTLAND CEMENT ASSOCIATION.

Rigid Pavement Requirements
A310-200 Models - MRW 139 500 kg

Chapter 7.7.1
Page 4
DEC 01/09

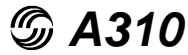

AIRPLANE CHARACTERISTICS FOR AIRPORT PLANNING

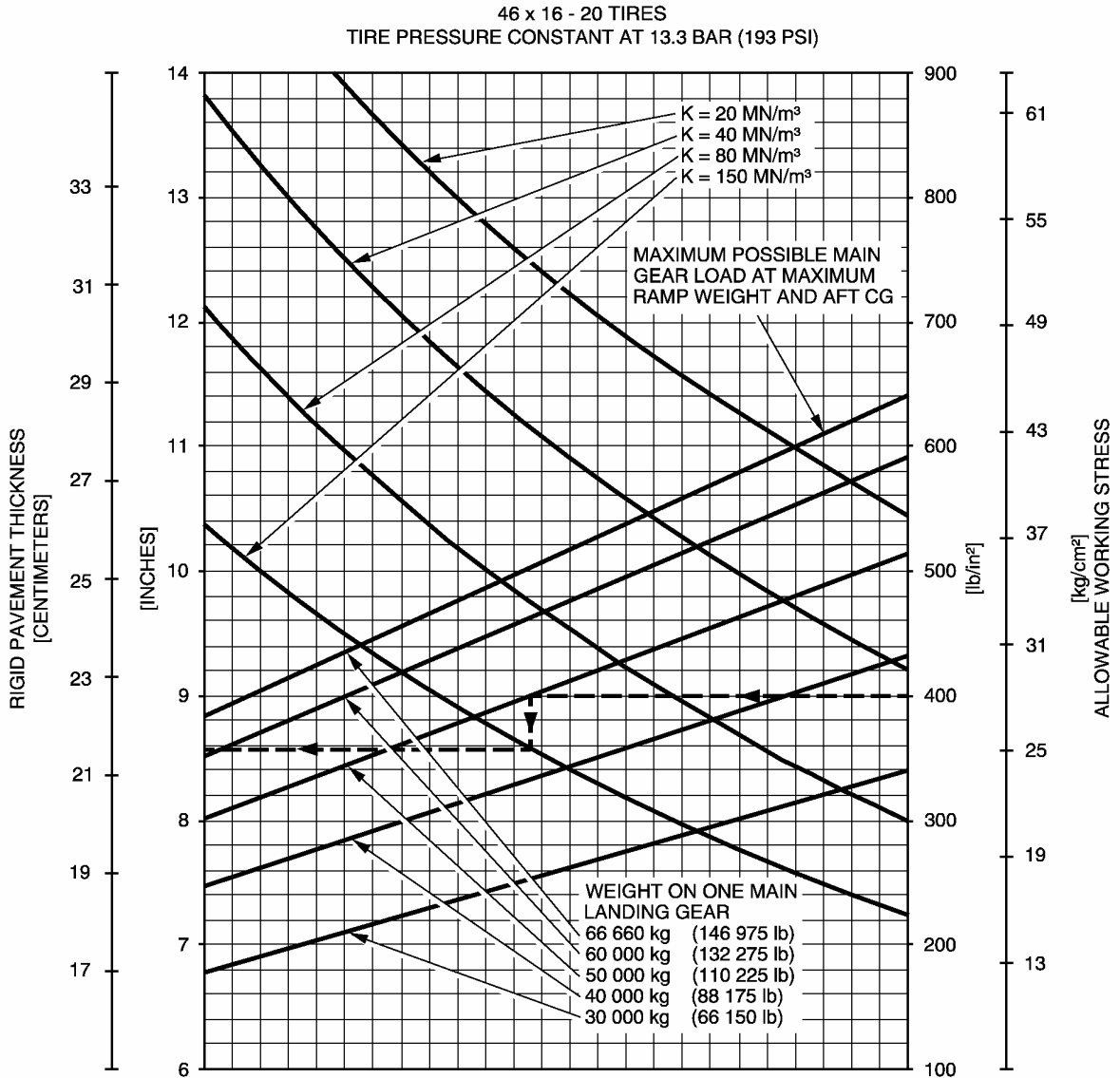

NOTE: THE VALUES OBTAINED BY USING THE MAXIMUM LOAD REFERENCE LINE AND ANY VALUES FOR K ARE EXACT. FOR LOADS LESS THAN MAXIMUM, THE CURVES ARE EXACT FOR $K = 80 \text{ MN/m}^3$ BUT DEVIATE SLIGHTLY FOR ANY OTHER VALUES OF K.

REFERENCE: "DESIGN OF CONCRETE AIRPORT PAVEMENTS" AND "COMPUTER PROGRAM FOR AIRPORT PAVEMENT DESIGN - PROGRAM PDILB" PORTLAND CEMENT ASSOCIATION.

BA5 07 07 01 1 AJM0 00

Rigid Pavement Requirements
A310-200 Models - MRW 142 900 kg

Chapter 7.7.1
Page 5
DEC 01/09

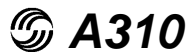

AIRPLANE CHARACTERISTICS FOR AIRPORT PLANNING

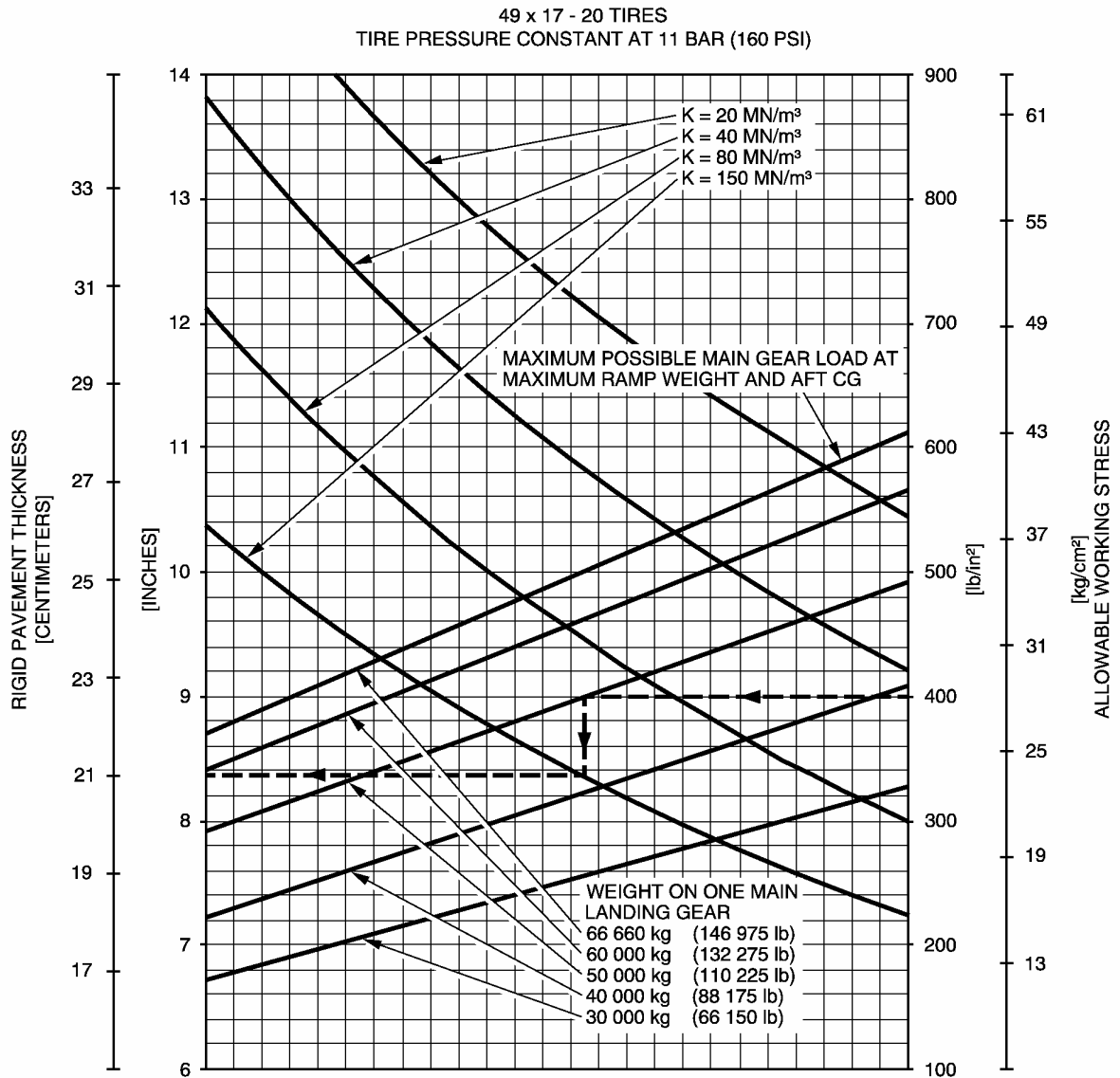

NOTE: THE VALUES OBTAINED BY USING THE MAXIMUM LOAD REFERENCE LINE AND ANY VALUES FOR K ARE EXACT. FOR LOADS LESS THAN MAXIMUM, THE CURVES ARE EXACT FOR $K = 80 \text{ MN/m}^3$ BUT DEVIATE SLIGHTLY FOR ANY OTHER VALUES OF K.

REFERENCE: "DESIGN OF CONCRETE AIRPORT PAVEMENTS" AND "COMPUTER PROGRAM FOR AIRPORT PAVEMENT DESIGN - PROGRAM PDILB" PORTLAND CEMENT ASSOCIATION.

BA5 07 07 01 1 ALM0 00

Rigid Pavement Requirements
A310-200 Models - MRW 142 900 kg

Chapter 7.7.1
Page 6
DEC 01/09

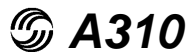

AIRPLANE CHARACTERISTICS FOR AIRPORT PLANNING

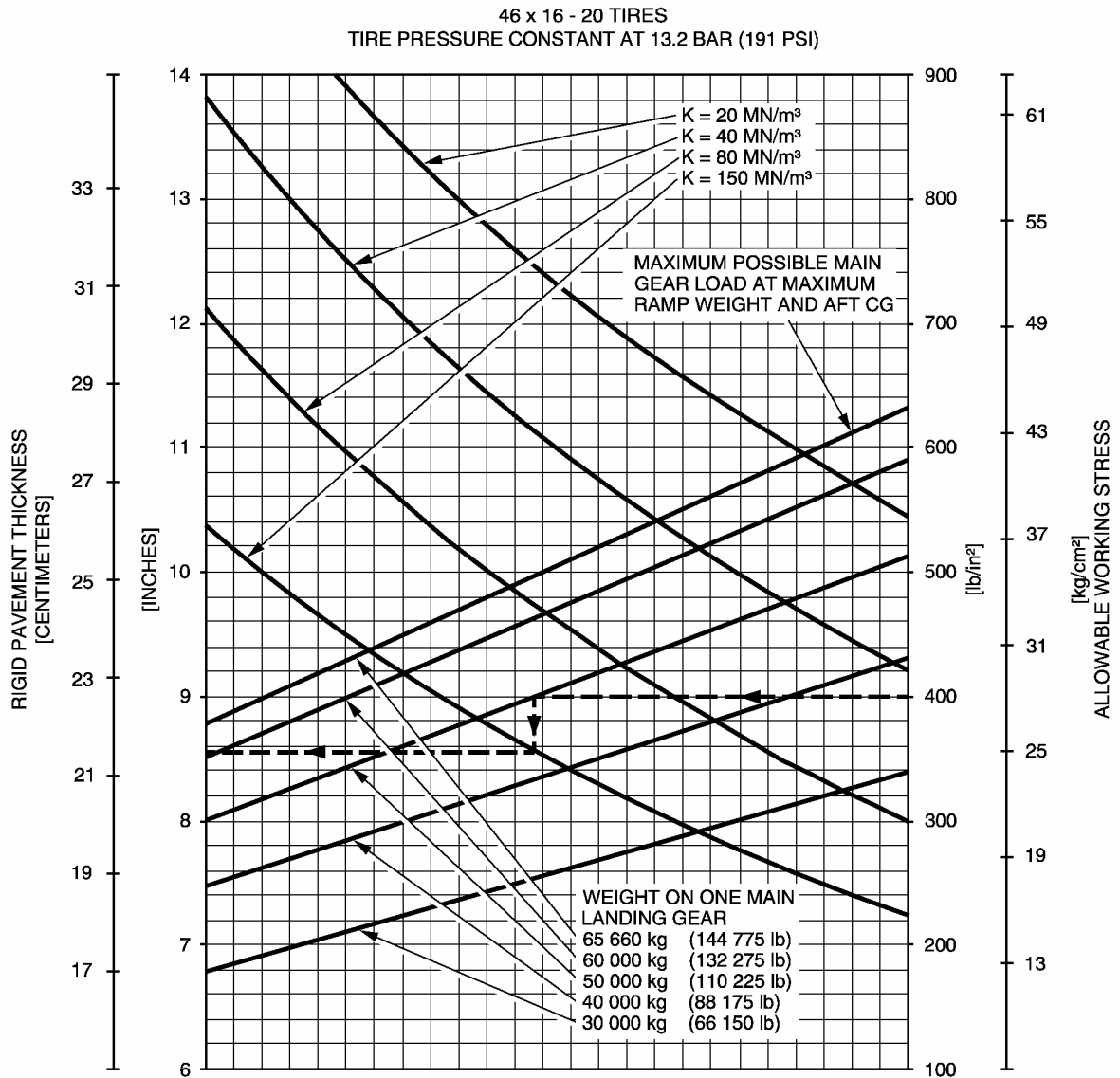

NOTE: THE VALUES OBTAINED BY USING THE MAXIMUM LOAD REFERENCE LINE AND ANY VALUES FOR K ARE EXACT. FOR LOADS LESS THAN MAXIMUM, THE CURVES ARE EXACT FOR K = 80 MN/m³ BUT DEVIATE SLIGHTLY FOR ANY OTHER VALUES OF K.

REFERENCE: "DESIGN OF CONCRETE AIRPORT PAVEMENTS" AND "COMPUTER PROGRAM FOR AIRPORT PAVEMENT DESIGN - PROGRAM PDILB" PORTLAND CEMENT ASSOCIATION.

BA5 07 07 01 1 ANM0 00

Rigid Pavement Requirements
A310-300 Models - MRW 139 500 kg

Chapter 7.7.1
Page 7
DEC 01/09

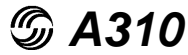

AIRPLANE CHARACTERISTICS FOR AIRPORT PLANNING

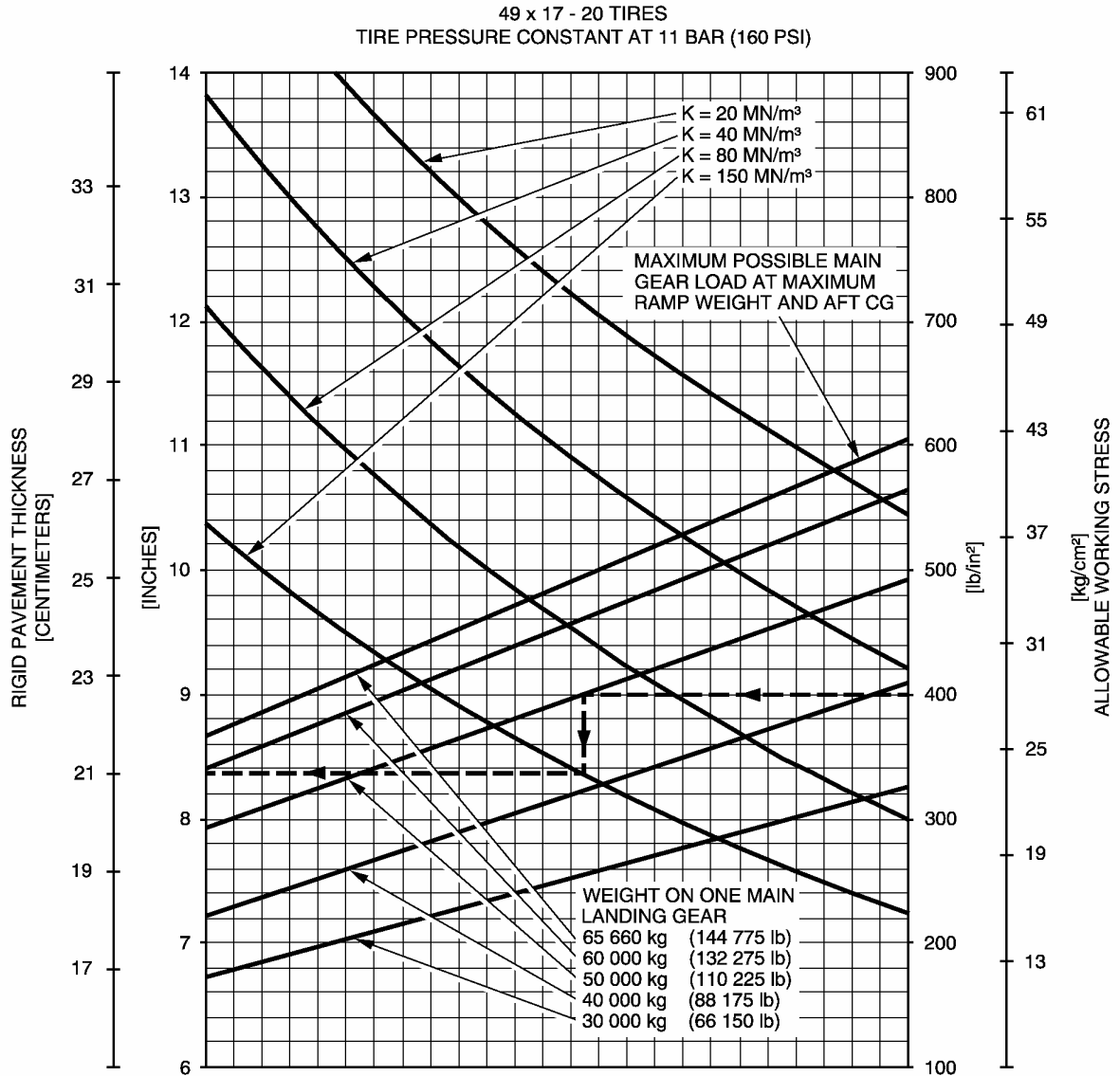

NOTE: THE VALUES OBTAINED BY USING THE MAXIMUM LOAD REFERENCE LINE AND ANY VALUES FOR K ARE EXACT. FOR LOADS LESS THAN MAXIMUM, THE CURVES ARE EXACT FOR K = 80 MN/m³ BUT DEVIATE SLIGHTLY FOR ANY OTHER VALUES OF K.

REFERENCE: "DESIGN OF CONCRETE AIRPORT PAVEMENTS" AND "COMPUTER PROGRAM FOR AIRPORT PAVEMENT DESIGN - PROGRAM PDILB" PORTLAND CEMENT ASSOCIATION.

BA5 07 07 01 1 AQM0 00

Rigid Pavement Requirements
A310-300 Models - MRW 139 500 kg

Chapter 7.7.1
Page 8
DEC 01/09

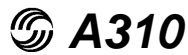

AIRPLANE CHARACTERISTICS FOR AIRPORT PLANNING

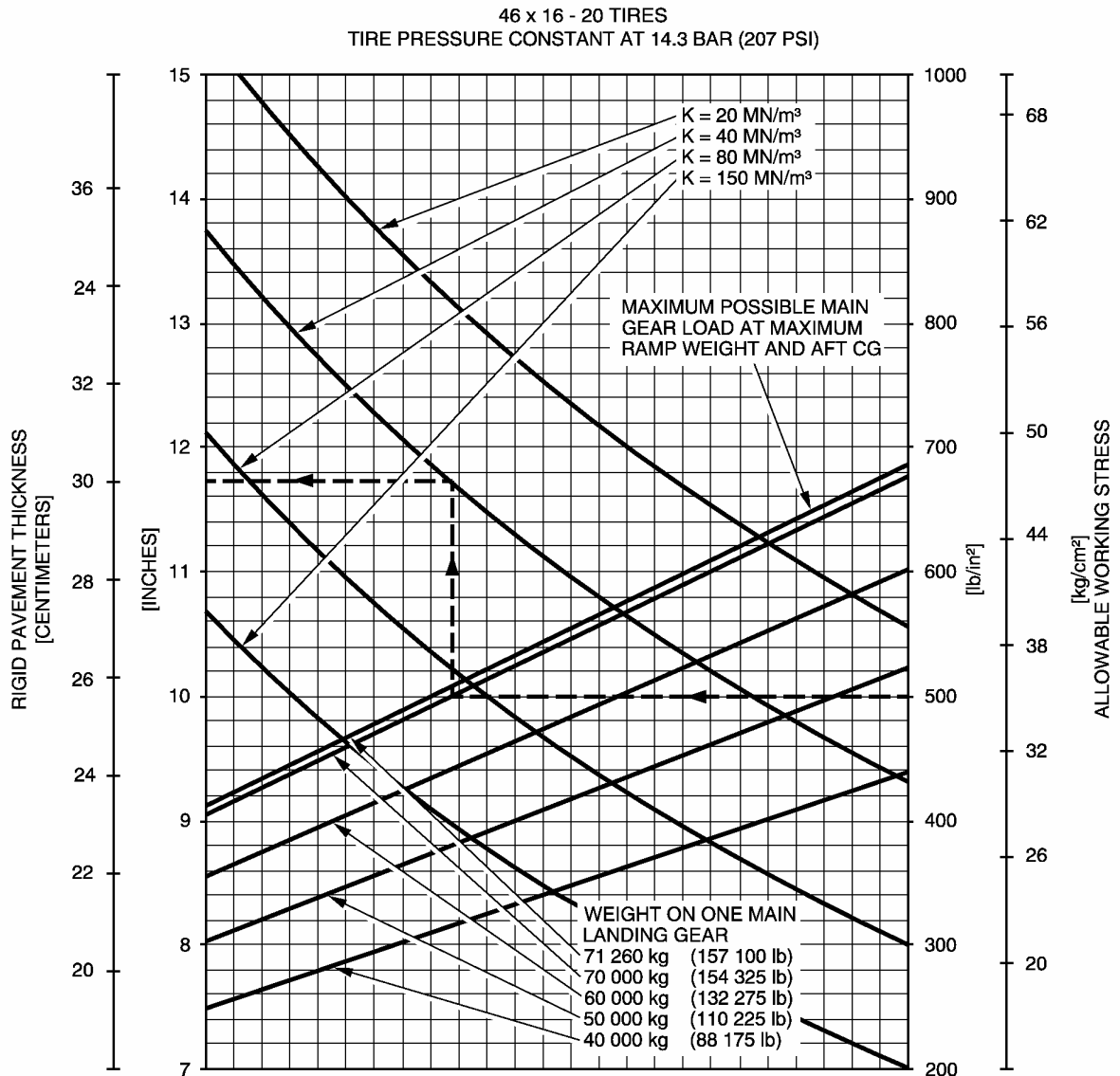

NOTE: THE VALUES OBTAINED BY USING THE MAXIMUM LOAD REFERENCE LINE AND ANY VALUES FOR K ARE EXACT. FOR LOADS LESS THAN MAXIMUM, THE CURVES ARE EXACT FOR $K = 80 \text{ MN/m}^3$ BUT DEVIATE SLIGHTLY FOR ANY OTHER VALUES OF K.

REFERENCE: "DESIGN OF CONCRETE AIRPORT PAVEMENTS" AND "COMPUTER PROGRAM FOR AIRPORT PAVEMENT DESIGN - PROGRAM PDILB" PORTLAND CEMENT ASSOCIATION.

BA5 07 07 01 1 ASM0 00

Rigid Pavement Requirements
A310-300 Models - MRW 150 900 kg

Chapter 7.7.1
Page 9
DEC 01/09

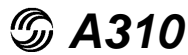

AIRPLANE CHARACTERISTICS FOR AIRPORT PLANNING

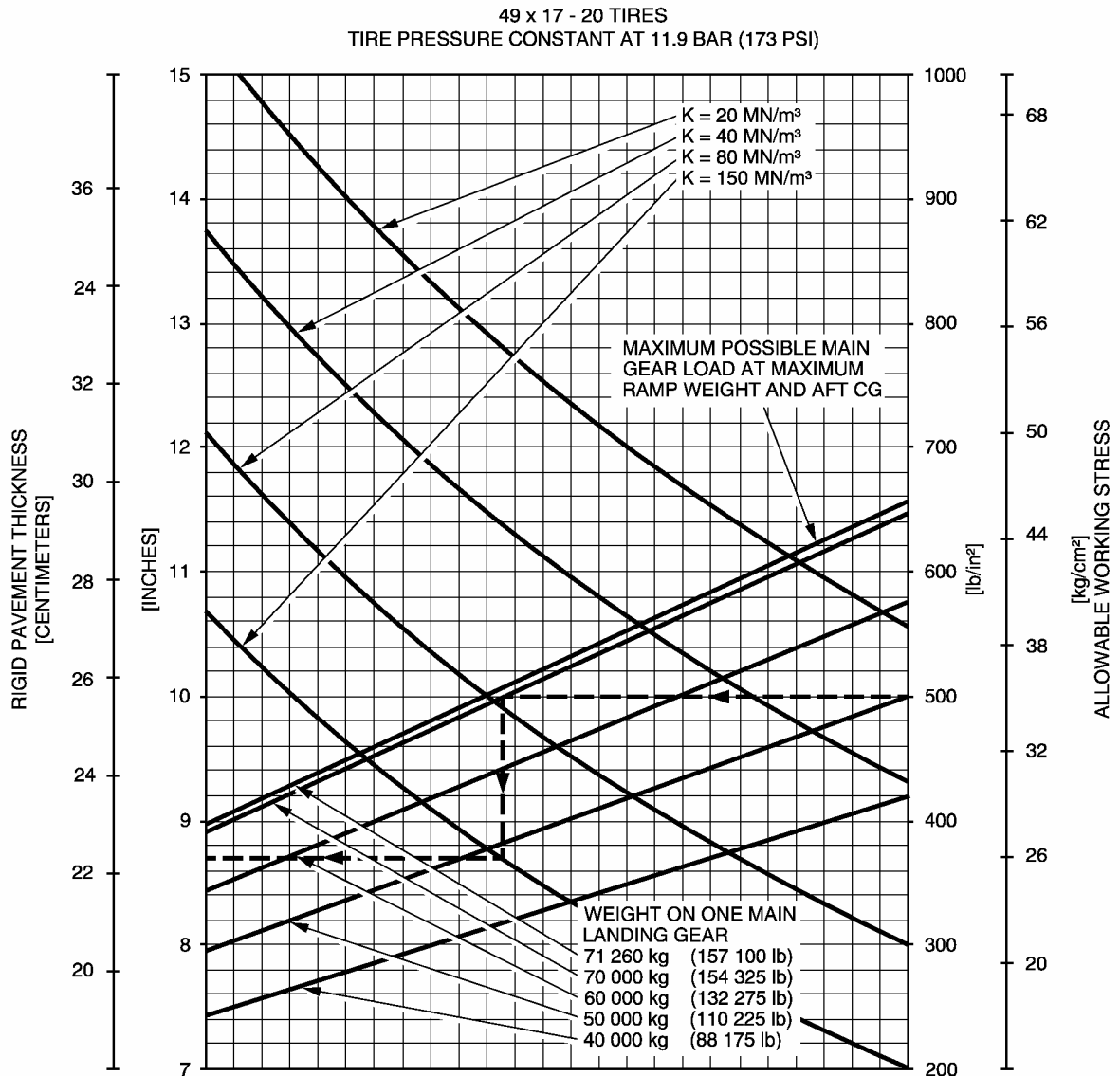

NOTE: THE VALUES OBTAINED BY USING THE MAXIMUM LOAD REFERENCE LINE AND ANY VALUES FOR K ARE EXACT. FOR LOADS LESS THAN MAXIMUM, THE CURVES ARE EXACT FOR K = 80 MN/m³ BUT DEVIATE SLIGHTLY FOR ANY OTHER VALUES OF K.

REFERENCE: "DESIGN OF CONCRETE AIRPORT PAVEMENTS" AND "COMPUTER PROGRAM FOR AIRPORT PAVEMENT DESIGN - PROGRAM PDILB" PORTLAND CEMENT ASSOCIATION.

BA5 07 07 01 1 AUM0 00

Rigid Pavement Requirements
A310-300 Models - MRW 150 900 kg

Chapter 7.7.1
Page 10
DEC 01/09

AIRPLANE CHARACTERISTICS FOR AIRPORT PLANNING

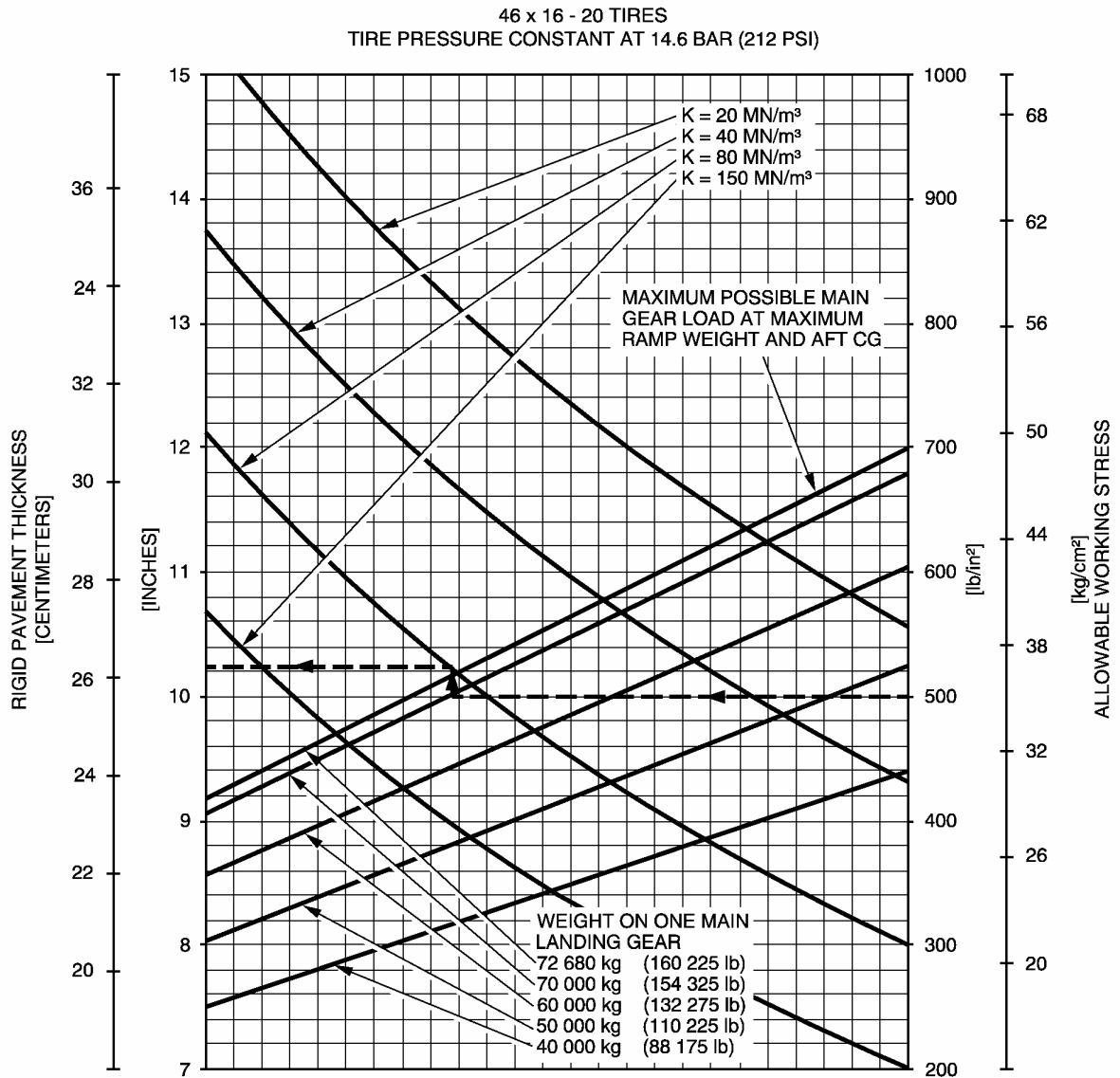

BA5 07 07 01 1 AWM0 00

NOTE: THE VALUES OBTAINED BY USING THE MAXIMUM LOAD REFERENCE LINE AND ANY VALUES FOR K ARE EXACT. FOR LOADS LESS THAN MAXIMUM, THE CURVES ARE EXACT FOR K = 80 MN/m³ BUT DEVIATE SLIGHTLY FOR ANY OTHER VALUES OF K.

REFERENCE: "DESIGN OF CONCRETE AIRPORT PAVEMENTS" AND "COMPUTER PROGRAM FOR AIRPORT PAVEMENT DESIGN - PROGRAM PDILB" PORTLAND CEMENT ASSOCIATION.

**Rigid Pavement Requirements
A310-300 Models - MRW 153 900 kg**

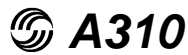

AIRPLANE CHARACTERISTICS FOR AIRPORT PLANNING

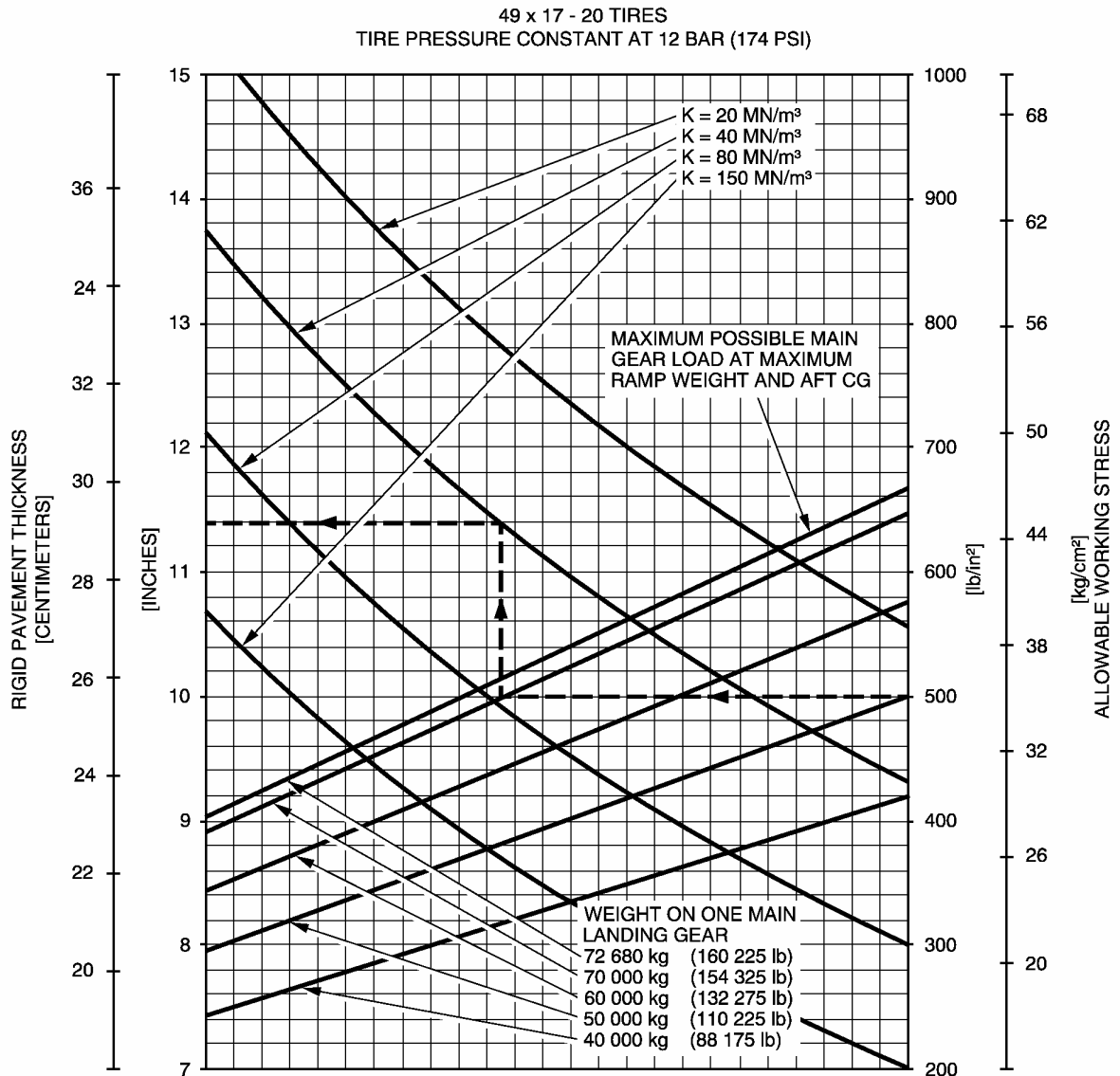

NOTE: THE VALUES OBTAINED BY USING THE MAXIMUM LOAD REFERENCE LINE AND ANY VALUES FOR K ARE EXACT.
FOR LOADS LESS THAN MAXIMUM, THE CURVES ARE EXACT FOR $K = 80 \text{ MN/m}^3$ BUT DEVIATE SLIGHTLY FOR ANY OTHER VALUES OF K.

REFERENCE: "DESIGN OF CONCRETE AIRPORT PAVEMENTS" AND "COMPUTER PROGRAM FOR AIRPORT PAVEMENT DESIGN - PROGRAM PDILB" PORTLAND CEMENT ASSOCIATION.

BA5 07 07 01 1 AYM0 00

Rigid Pavement Requirements
A310-300 Models - MRW 153 900 kg

Chapter 7.7.1
Page 12
DEC 01/09

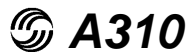

AIRPLANE CHARACTERISTICS FOR AIRPORT PLANNING

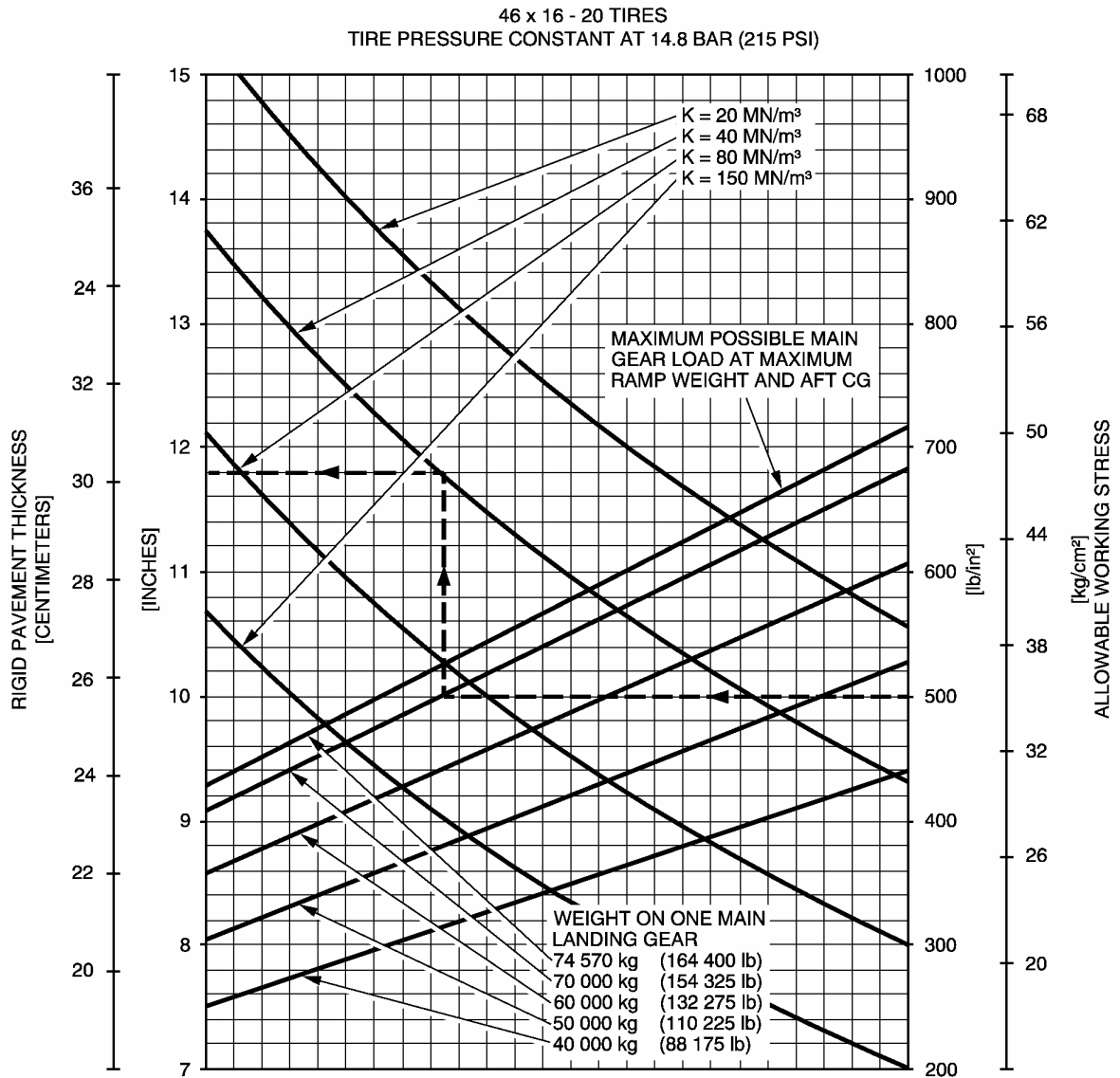

NOTE: THE VALUES OBTAINED BY USING THE MAXIMUM LOAD REFERENCE LINE AND ANY VALUES FOR K ARE EXACT. FOR LOADS LESS THAN MAXIMUM, THE CURVES ARE EXACT FOR K = 80 MN/m³ BUT DEVIATE SLIGHTLY FOR ANY OTHER VALUES OF K.

REFERENCE: "DESIGN OF CONCRETE AIRPORT PAVEMENTS" AND "COMPUTER PROGRAM FOR AIRPORT PAVEMENT DESIGN - PROGRAM PDILB" PORTLAND CEMENT ASSOCIATION.

BA5 07 07 01 1 BAM0 00

Rigid Pavement Requirements
A310-300 Models - MRW 157 900 kg

Chapter 7.7.1
Page 13
DEC 01/09

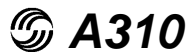

AIRPLANE CHARACTERISTICS FOR AIRPORT PLANNING

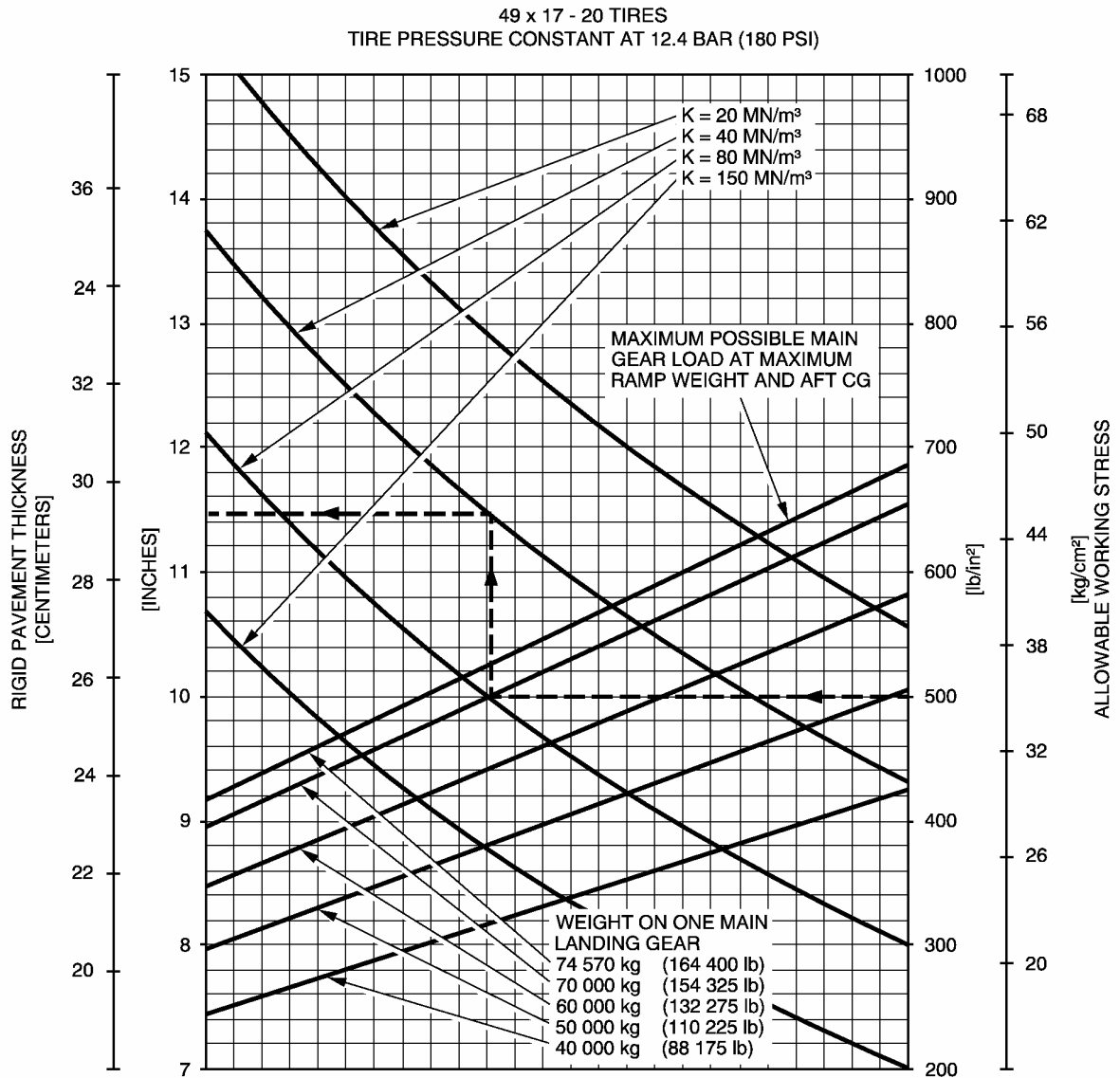

NOTE: THE VALUES OBTAINED BY USING THE MAXIMUM LOAD REFERENCE LINE AND ANY VALUES FOR K ARE EXACT. FOR LOADS LESS THAN MAXIMUM, THE CURVES ARE EXACT FOR $K = 80 \text{ MN/m}^3$ BUT DEVIATE SLIGHTLY FOR ANY OTHER VALUES OF K.

REFERENCE: "DESIGN OF CONCRETE AIRPORT PAVEMENTS" AND "COMPUTER PROGRAM FOR AIRPORT PAVEMENT DESIGN - PROGRAM PDILB" PORTLAND CEMENT ASSOCIATION.

BA5 07 07 01 1 BCM0 00

Rigid Pavement Requirements
A310-300 Models - MRW 157 900 kg

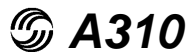

AIRPLANE CHARACTERISTICS FOR AIRPORT PLANNING

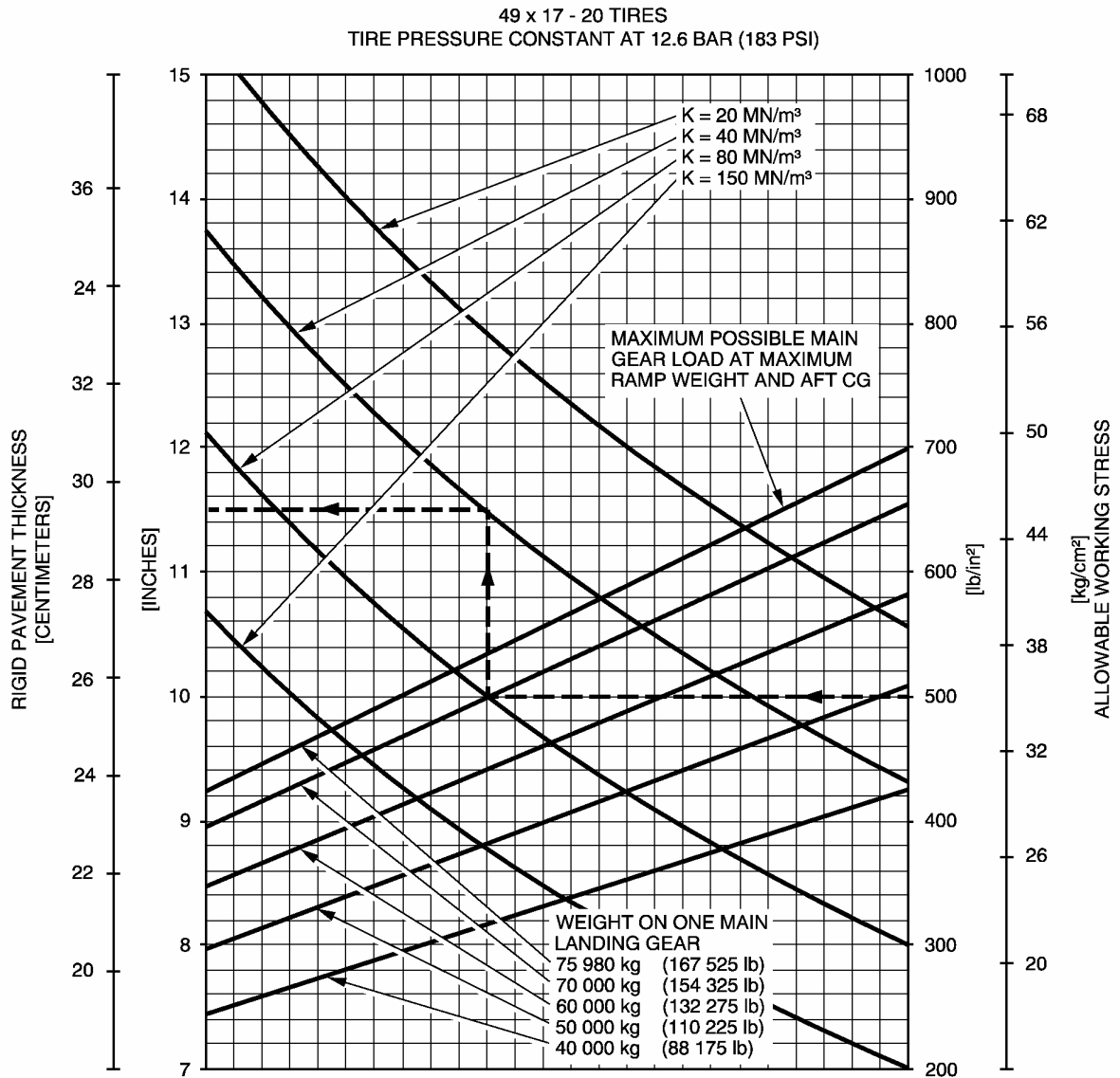

NOTE: THE VALUES OBTAINED BY USING THE MAXIMUM LOAD REFERENCE LINE AND ANY VALUES FOR K ARE EXACT. FOR LOADS LESS THAN MAXIMUM, THE CURVES ARE EXACT FOR $K = 80 \text{ MN/m}^3$ BUT DEVIATE SLIGHTLY FOR ANY OTHER VALUES OF K.

REFERENCE: "DESIGN OF CONCRETE AIRPORT PAVEMENTS" AND "COMPUTER PROGRAM FOR AIRPORT PAVEMENT DESIGN - PROGRAM PDILB" PORTLAND CEMENT ASSOCIATION.

BA5 07 07 01 1 BEM0 00

Rigid Pavement Requirements
A310-300 Models - MRW 160 900 kg

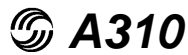

AIRPLANE CHARACTERISTICS FOR AIRPORT PLANNING

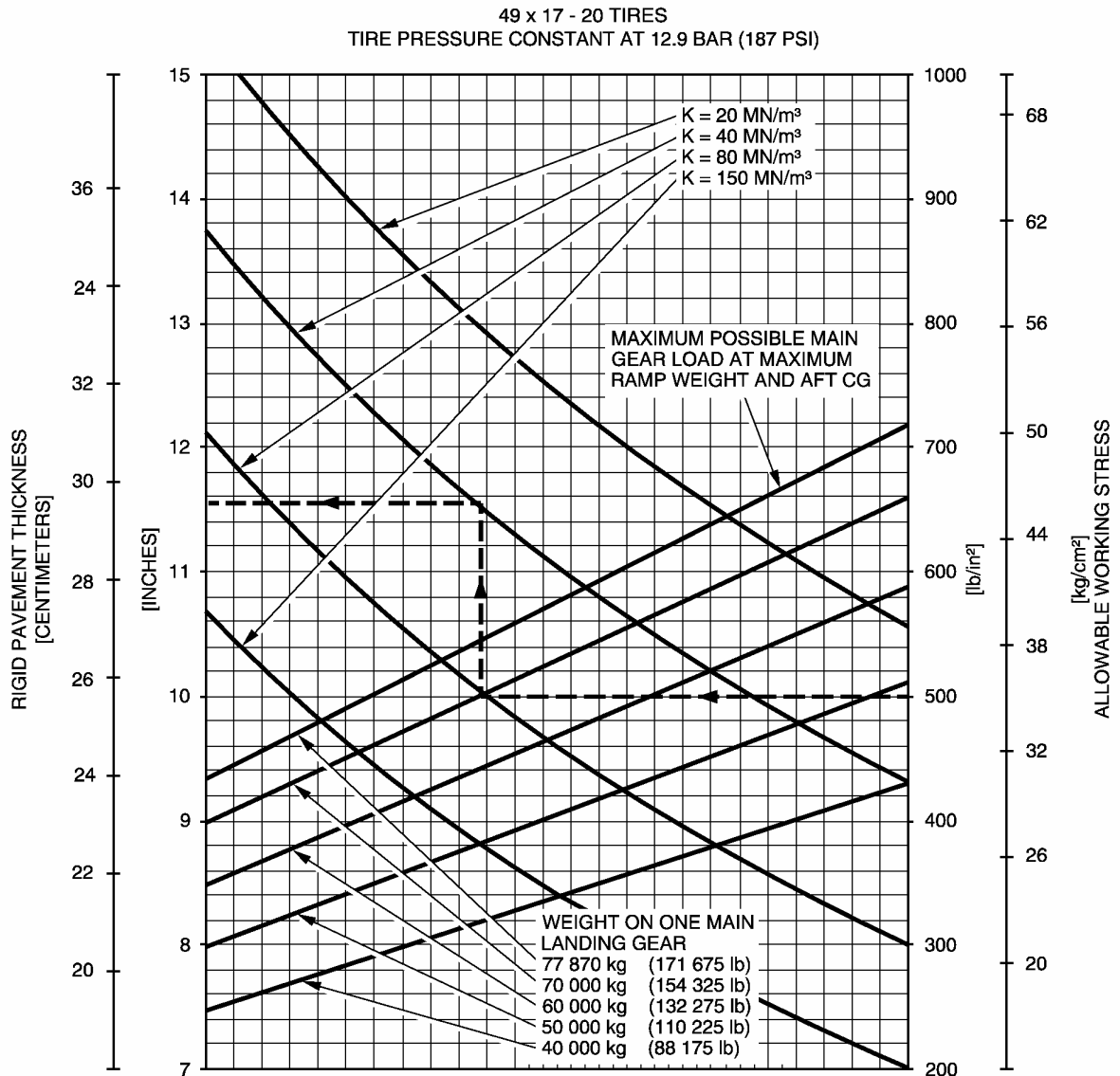

NOTE: THE VALUES OBTAINED BY USING THE MAXIMUM LOAD REFERENCE LINE AND ANY VALUES FOR K ARE EXACT. FOR LOADS LESS THAN MAXIMUM, THE CURVES ARE EXACT FOR $K = 80 \text{ MN/m}^3$ BUT DEVIATE SLIGHTLY FOR ANY OTHER VALUES OF K.

REFERENCE: "DESIGN OF CONCRETE AIRPORT PAVEMENTS" AND "COMPUTER PROGRAM FOR AIRPORT PAVEMENT DESIGN - PROGRAM PDILB" PORTLAND CEMENT ASSOCIATION.

BA5 07 07 01 1 BGM0 00

Rigid Pavement Requirements
A310-300 Models - MRW 164 900 kg

Chapter 7.7.1
Page 16
DEC 01/09

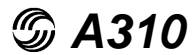

AIRPLANE CHARACTERISTICS FOR AIRPORT PLANNING

7.8 Rigid Pavement Requirements - LCN Conversion

To determine the airplane weight that a Rigid Pavement can support, the LCN of the pavement and the Radius of Relative Stiffness (L) must be known.

- A310-200 Models

In the typical example shown in Section 7.8.2 with MRW 132 900 kg.

The Radius of Relative Stiffness is shown at 1270 mm (50 in.) with an LCN of 93.

For these conditions the weight on one Main Landing Gear is 60 000 kg (132 275 lb).

- A310-300 Models

In the typical example shown in Section 7.8.2 with MRW 139 500 kg.

The Radius of Relative Stiffness is shown at 1270 mm (50 in.) with an LCN of 93.

For these conditions the weight on one Main Landing Gear is 60 000 kg (132 275 lb).



AIRPLANE CHARACTERISTICS FOR AIRPORT PLANNING

RADIUS OF RELATIVE STIFFNESS (L)
VALUES IN INCHES

$$L = 4 \sqrt[4]{\frac{Ed^3}{12(1-\mu^2)k}} = 24.1652 \sqrt[4]{\frac{d^3}{k}}$$

WHERE E = Young's Modulus = 4×10^6 psi
 k = Subgrade Modulus, lbf/in³
 d = Rigid Pavement Thickness, inches
 μ = Poisson's Ratio = 0.15

d	k=75	k=100	k=150	k=200	k=250	k=300	k=350	k=400	k=550
6.0	31.48	29.30	26.47	24.63	23.30	22.26	21.42	20.72	19.13
6.5	33.43	31.11	28.11	26.16	24.74	23.64	22.74	22.00	20.31
7.0	35.34	32.89	29.72	27.65	26.15	24.99	24.04	23.25	21.47
7.5	37.22	34.63	31.29	29.12	27.54	26.32	25.32	24.49	22.61
8.0	39.06	36.35	32.85	30.57	28.91	27.62	26.58	25.70	23.74
8.5	40.88	38.04	34.37	31.99	30.25	28.91	27.81	26.90	24.84
9.0	42.67	39.71	35.88	33.39	31.58	30.17	29.03	28.08	25.93
9.5	44.43	41.35	37.36	34.77	32.89	31.42	30.23	29.24	27.00
10.0	46.18	42.97	38.83	36.14	34.17	32.65	31.42	30.39	28.06
10.5	47.90	44.57	40.28	37.48	35.45	33.87	32.59	31.52	29.11
11.0	49.60	46.16	41.71	38.81	36.71	35.07	33.75	32.64	30.14
11.5	51.28	47.72	43.12	40.13	37.95	36.26	34.89	33.74	31.16
12.0	52.94	49.27	44.52	41.43	39.18	37.44	36.02	34.84	32.17
12.5	54.59	50.80	45.90	42.72	40.40	38.60	37.14	35.92	33.17
13.0	56.22	52.32	47.27	43.99	41.61	39.75	38.25	36.99	34.16
13.5	57.83	53.82	48.63	45.26	42.80	40.89	39.35	38.06	35.14
14.0	59.43	55.31	49.98	46.51	43.98	42.02	40.44	39.11	36.12
14.5	61.02	56.78	51.31	47.75	45.16	43.15	41.51	40.15	37.08
15.0	62.59	58.25	52.63	48.98	46.32	44.26	42.58	41.19	38.03
15.5	64.15	59.70	53.94	50.20	47.47	45.36	43.64	42.21	38.98
16.0	65.69	61.13	55.24	51.41	48.62	46.45	44.70	43.23	39.92
16.5	67.23	62.56	56.53	52.61	49.75	47.54	45.74	44.24	40.85
17.0	68.75	63.98	57.81	53.80	50.88	48.61	46.77	45.24	41.78
17.5	70.26	65.38	59.08	54.98	52.00	49.68	47.80	46.23	42.70
18.0	71.76	66.78	60.34	56.15	53.11	50.74	48.82	47.22	43.61
19.0	74.73	69.54	62.84	58.48	55.31	52.84	50.84	49.17	45.41
20.0	77.66	72.27	65.30	60.77	57.47	54.91	52.84	51.10	47.19
21.0	80.55	74.96	67.74	63.04	59.62	56.96	54.81	53.01	48.95
22.0	83.41	77.63	70.14	65.28	61.73	58.98	56.75	54.89	50.69
23.0	86.24	80.26	72.52	67.49	63.83	60.98	58.68	56.75	52.41
24.0	89.04	82.86	74.87	69.68	65.90	62.96	60.58	58.59	54.11
25.0	91.81	85.44	77.20	71.84	67.95	64.92	62.46	60.41	55.79

BA5 07 08 01 1 AAM0 00

Radius of relative stiffness
(Reference : Portland Cement Association)

AIRPLANE CHARACTERISTICS FOR AIRPORT PLANNING

BA5 07 08 02 1 AAM0 00

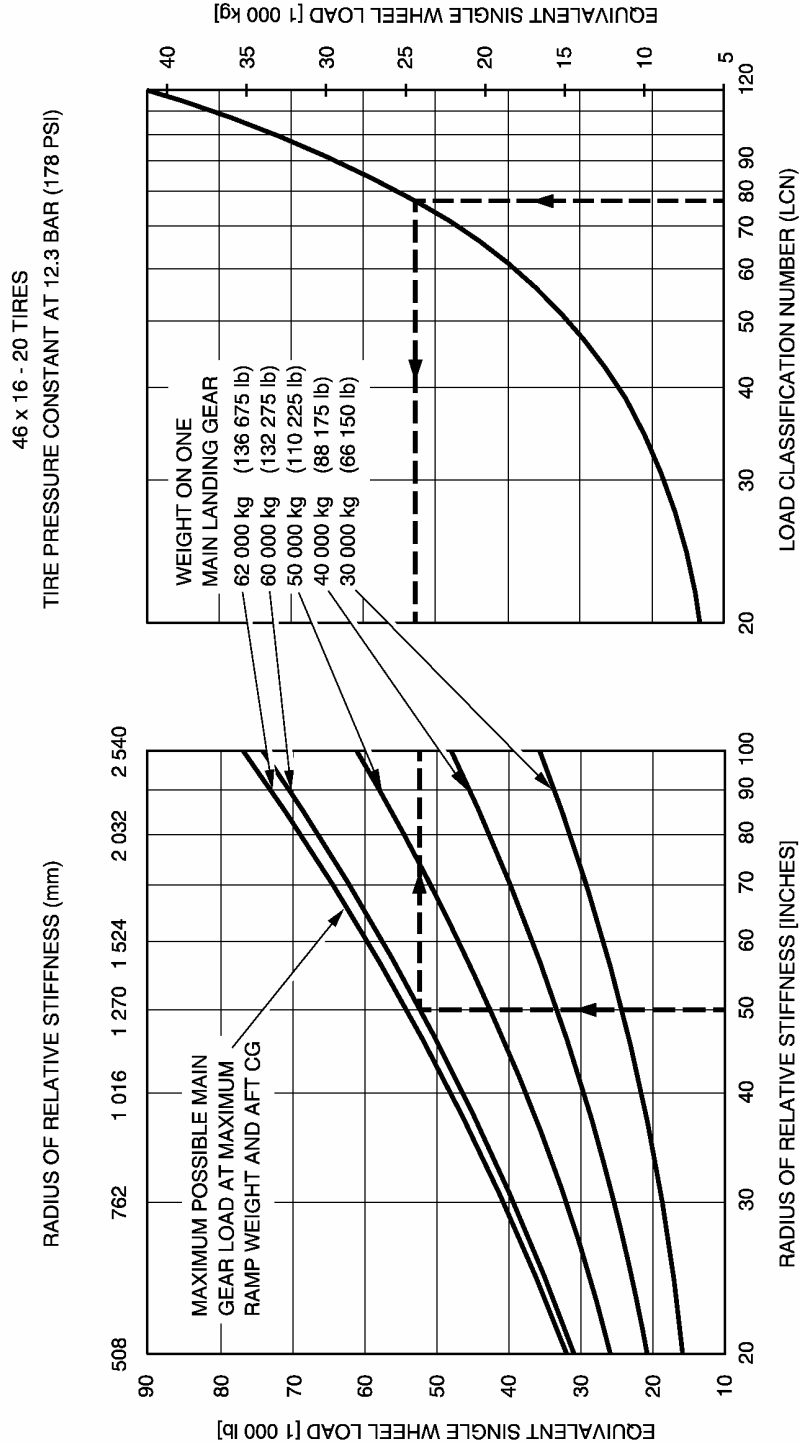

NOTE: EQUIVALENT SINGLE WHEEL LOADS ARE DERIVED BY METHODS SHOWN IN ICAO AERODROME MANUAL PART 2 PAR 4.1.3 Second Edition 1965.

AIRPLANE CHARACTERISTICS FOR AIRPORT PLANNING

BA5 07 08 02 1 ACM0 00

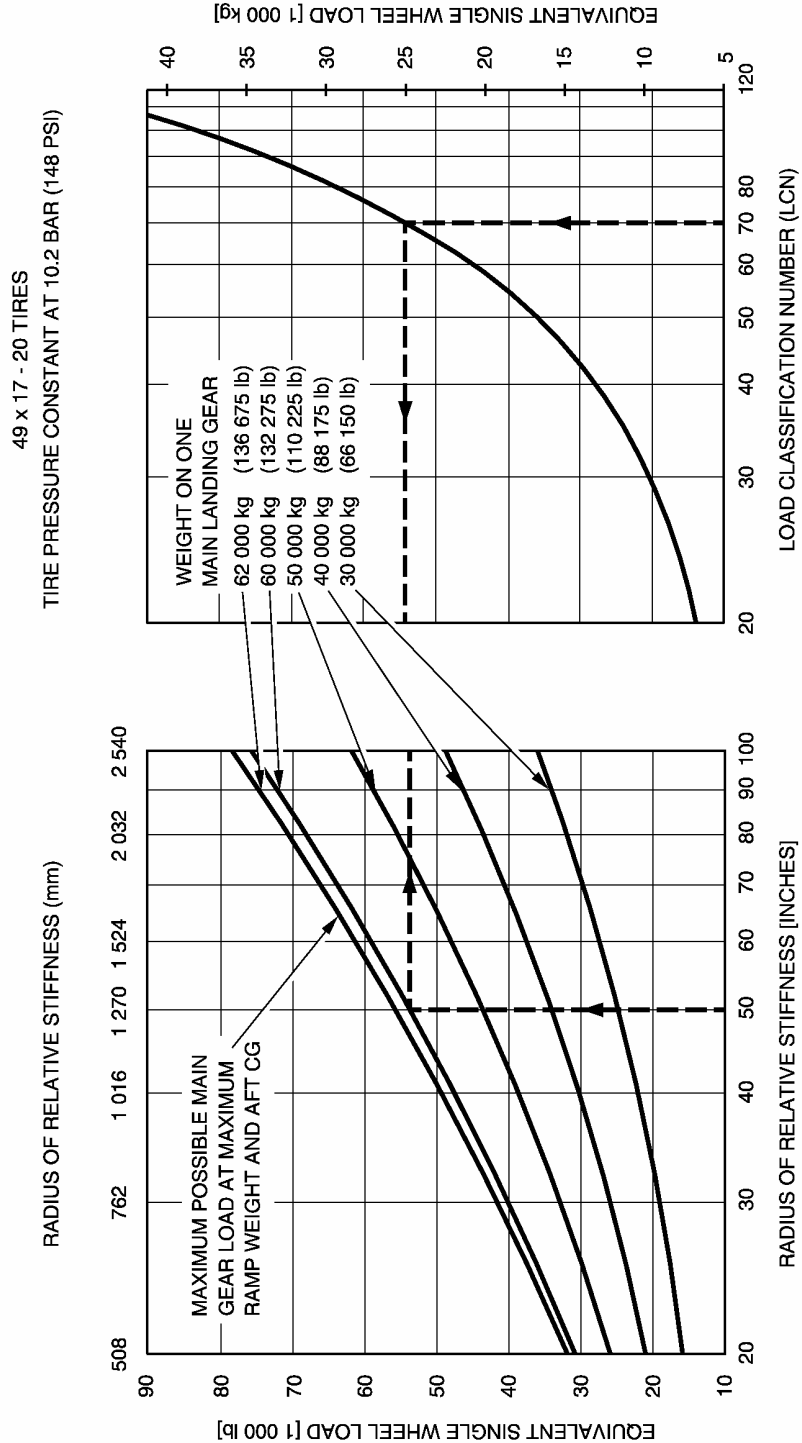

**Rigid Pavement Requirements LCN
A310-200 Models - MRW 132 900 kg**

AIRPLANE CHARACTERISTICS FOR AIRPORT PLANNING

BA5 07 08 02 1 AEM0 00

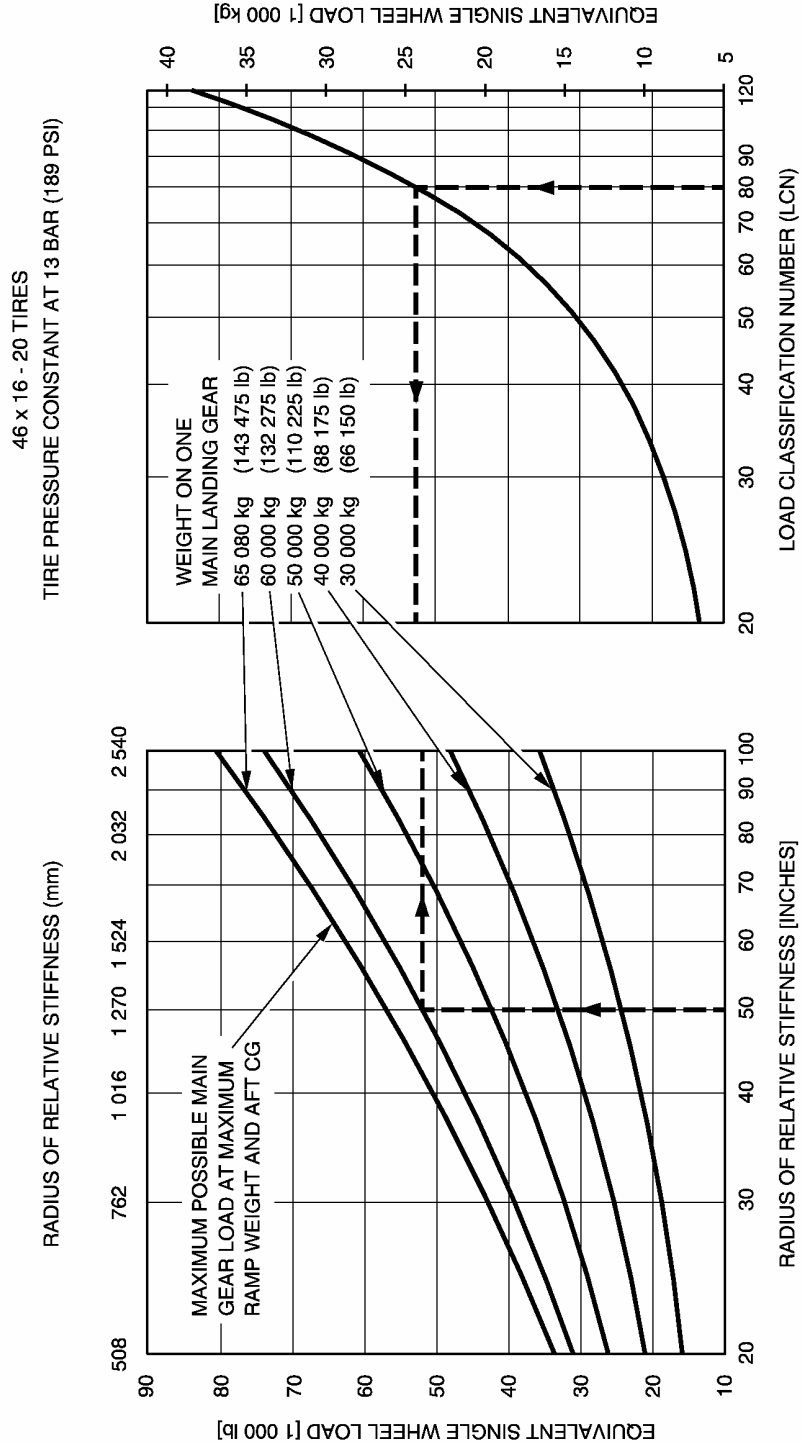

NOTE: EQUIVALENT SINGLE WHEEL LOADS ARE DERIVED BY METHODS SHOWN IN ICAO AERODROME MANUAL PART 2 PAR 4.1.3 Second Edition 1965.

AIRPLANE CHARACTERISTICS FOR AIRPORT PLANNING

BA5 07 08 02 1 AGM0 00

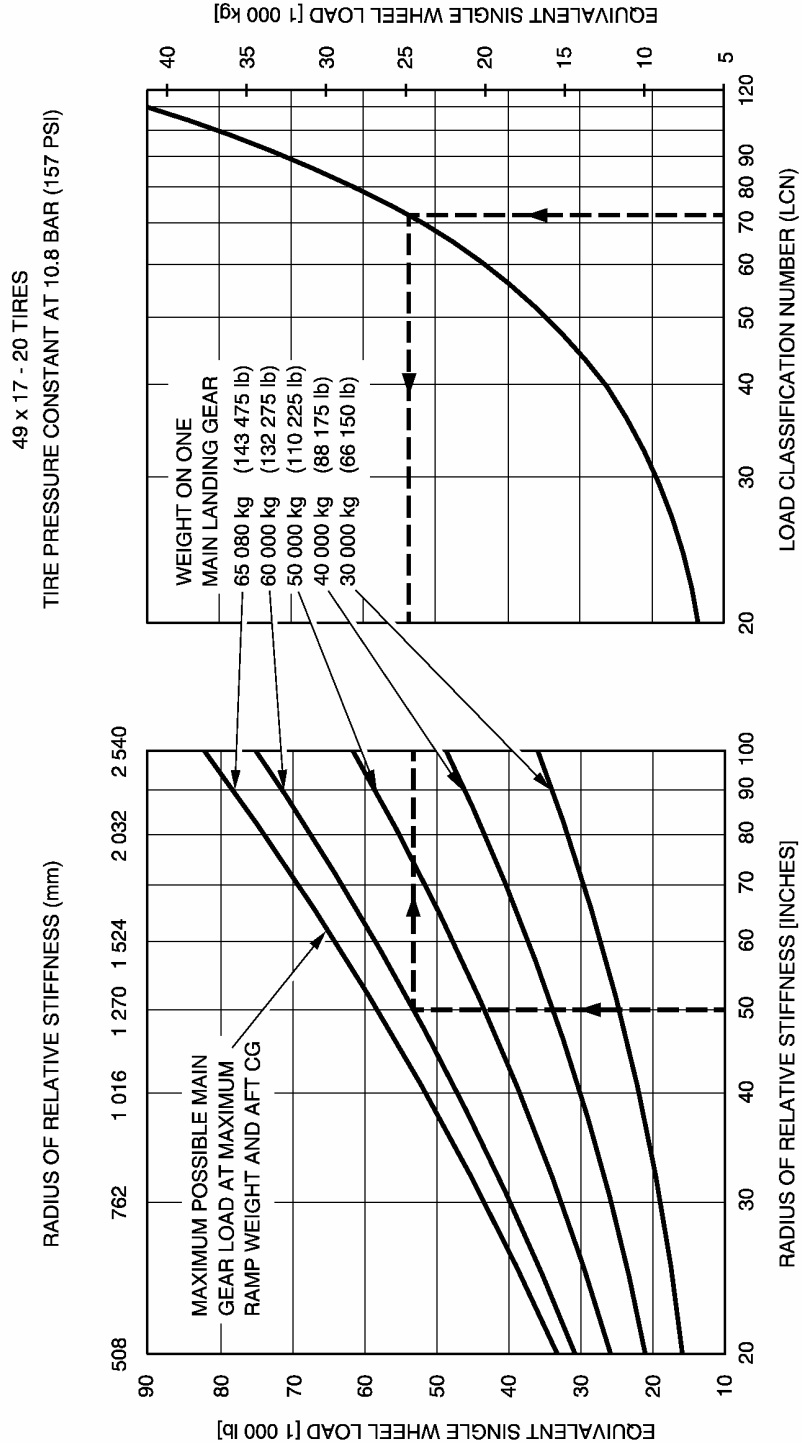

NOTE: EQUIVALENT SINGLE WHEEL LOADS ARE DERIVED BY METHODS SHOWN IN ICAO AERODROME MANUAL PART 2 PAR 4.1.3 Second Edition 1965.

AIRPLANE CHARACTERISTICS FOR AIRPORT PLANNING

BA5 07 08 02 1 AJM0 00

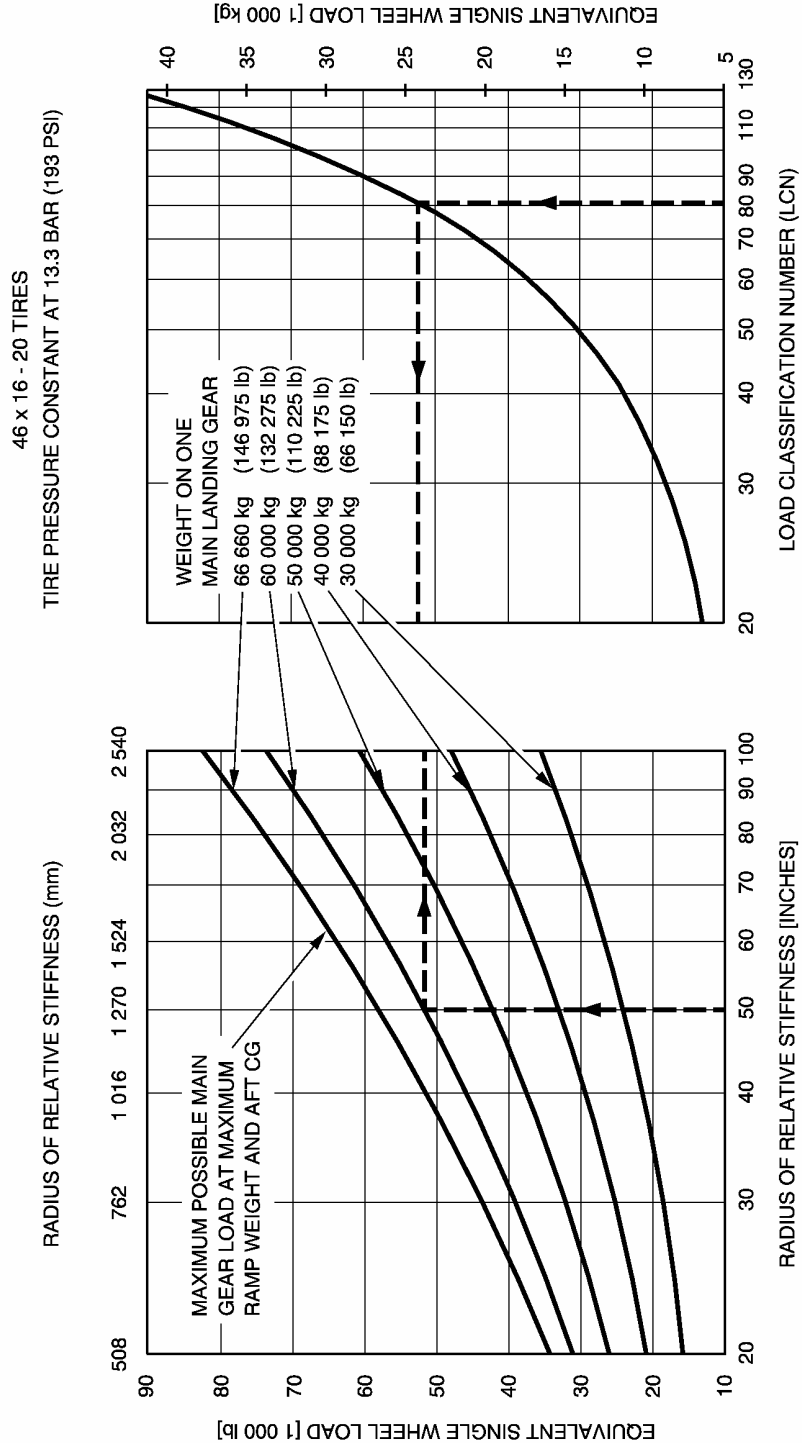

**Rigid Pavement Requirements LCN
A310-200 Models - MRW 142 900 kg**

NOTE: EQUIVALENT SINGLE WHEEL LOADS ARE DERIVED BY METHODS SHOWN IN ICAO AERODROME MANUAL PART 2 PAR 4.1.3 Second Edition 1965.

AIRPLANE CHARACTERISTICS FOR AIRPORT PLANNING

BA5 07 08 02 1 ALM0 00

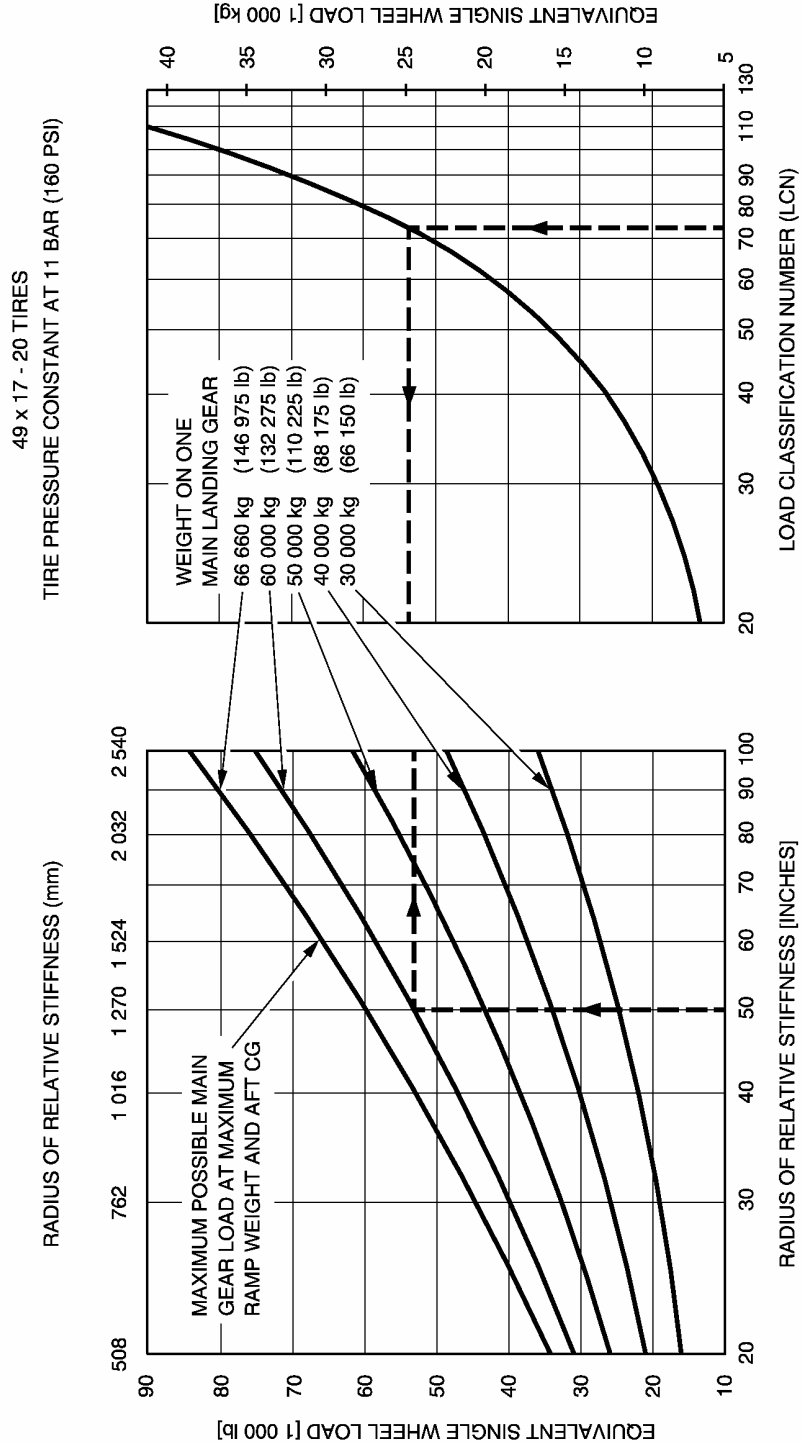

**Rigid Pavement Requirements LCN
A310-200 Models - MRW 142 900 kg**

NOTE: EQUIVALENT SINGLE WHEEL LOADS ARE DERIVED BY METHODS SHOWN IN ICAO AERODROME MANUAL PART 2 PAR 4.1.3 Second Edition 1965.

AIRPLANE CHARACTERISTICS FOR AIRPORT PLANNING

BA5 07 08 02 1 ANM0 00

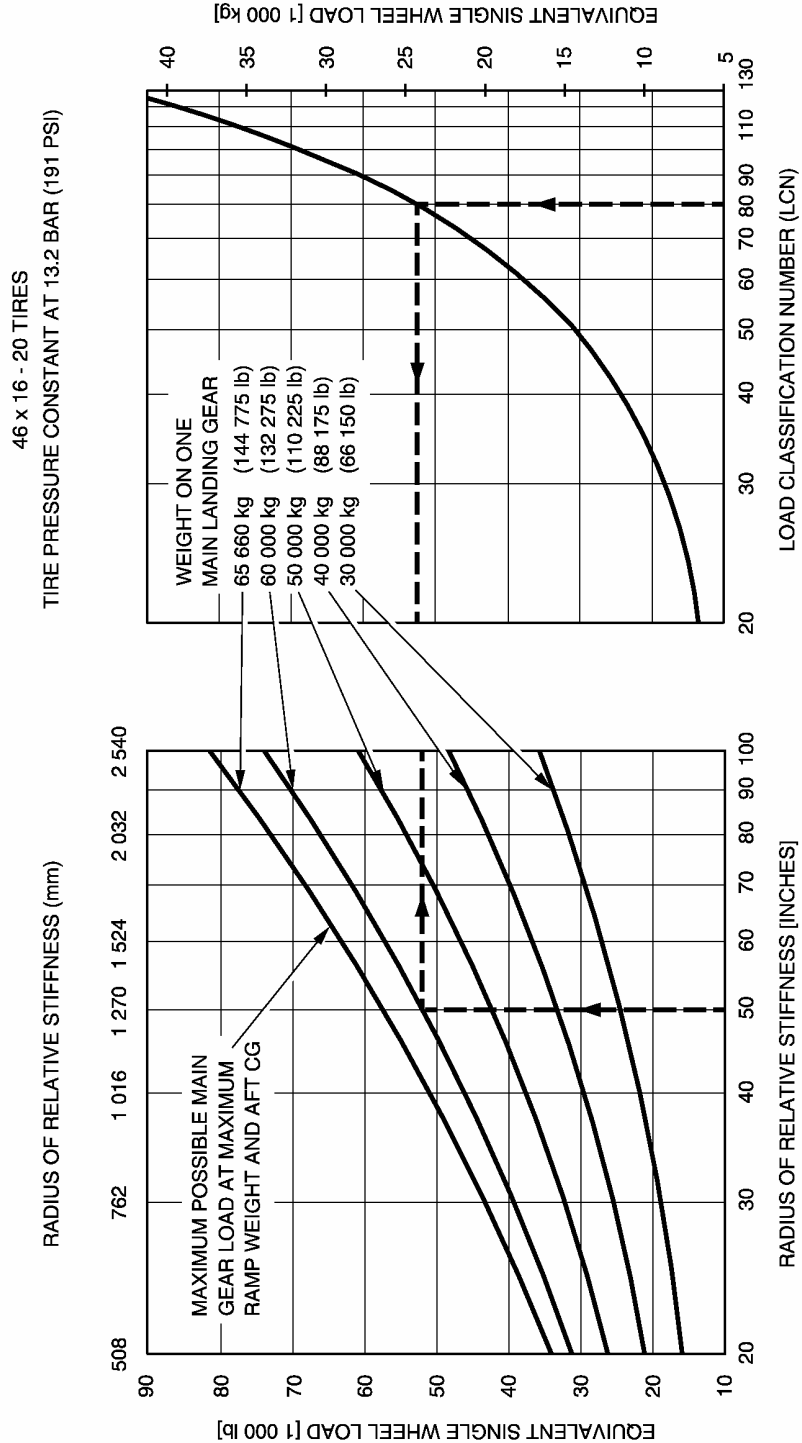

**Rigid Pavement Requirements LCN
A310-300 Models - MRW 139 500 kg**

NOTE: EQUIVALENT SINGLE WHEEL LOADS ARE DERIVED BY METHODS SHOWN IN ICAO AERODROME MANUAL PART 2 PAR 4.1.3 Second Edition 1965.

AIRPLANE CHARACTERISTICS FOR AIRPORT PLANNING

BA5 07 08 02 1 AQM0 00

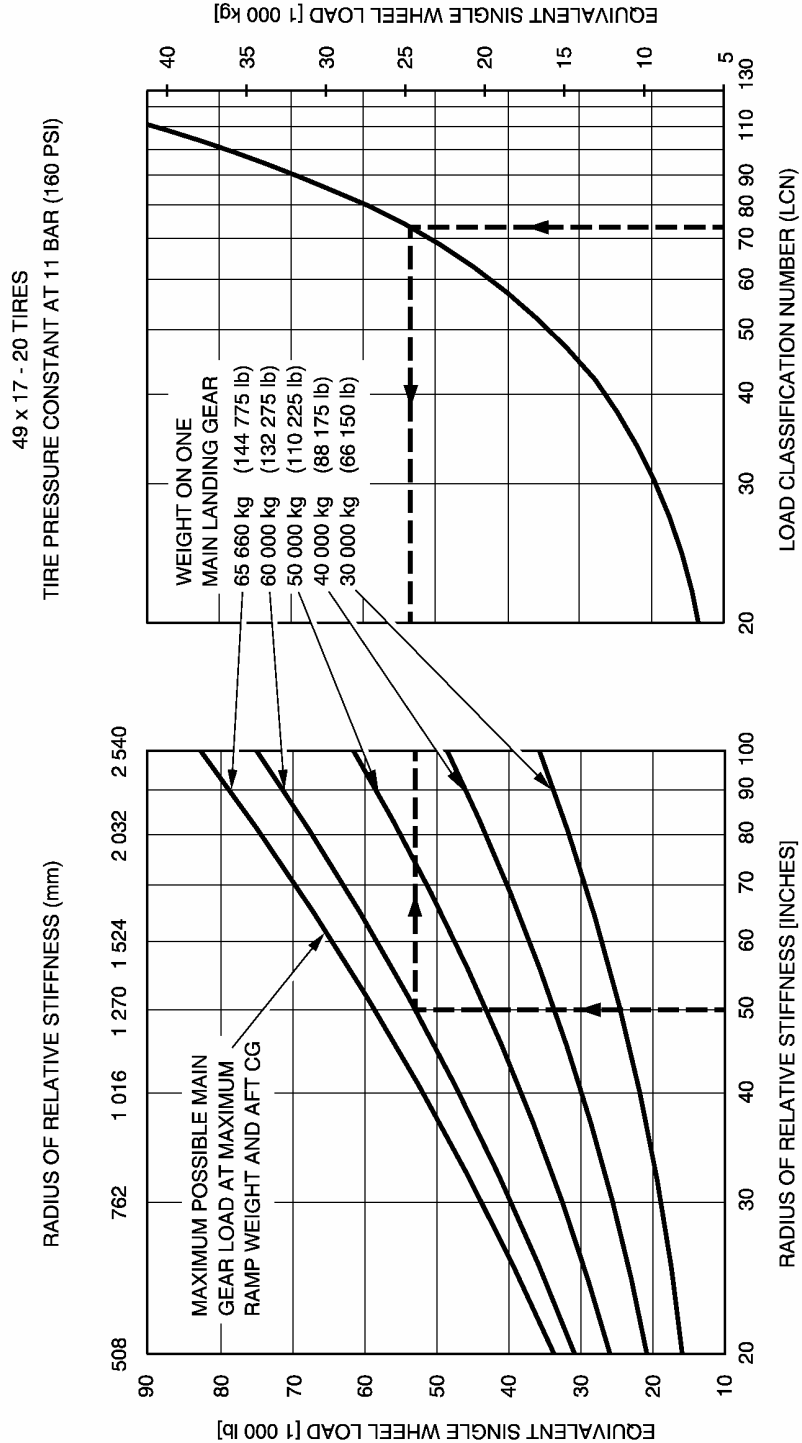

**Rigid Pavement Requirements LCN
A310-300 Models - MRW 139 500 kg**

NOTE: EQUIVALENT SINGLE WHEEL LOADS ARE DERIVED BY METHODS SHOWN IN ICAO AERODROME MANUAL PART 2 PAR 4.1.3 Second Edition 1965.

AIRPLANE CHARACTERISTICS FOR AIRPORT PLANNING

BA5 07 08 02 1 ASM0 00

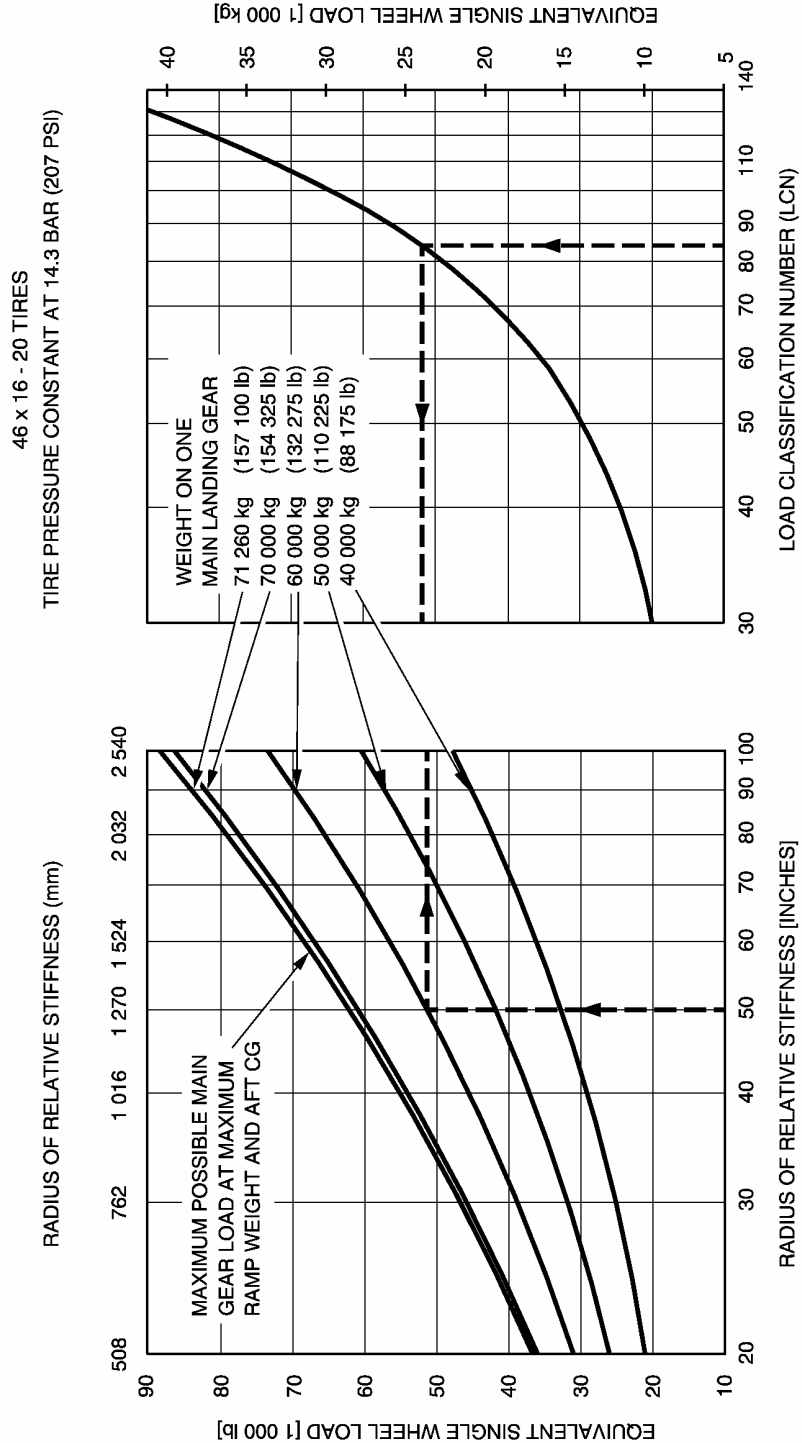

NOTE: EQUIVALENT SINGLE WHEEL LOADS ARE DERIVED BY METHODS SHOWN IN ICAO AERODROME MANUAL PART 2 PAR 4.1.3 Second Edition 1965.

AIRPLANE CHARACTERISTICS FOR AIRPORT PLANNING

BA5 07 08 02 1 AUM0 00

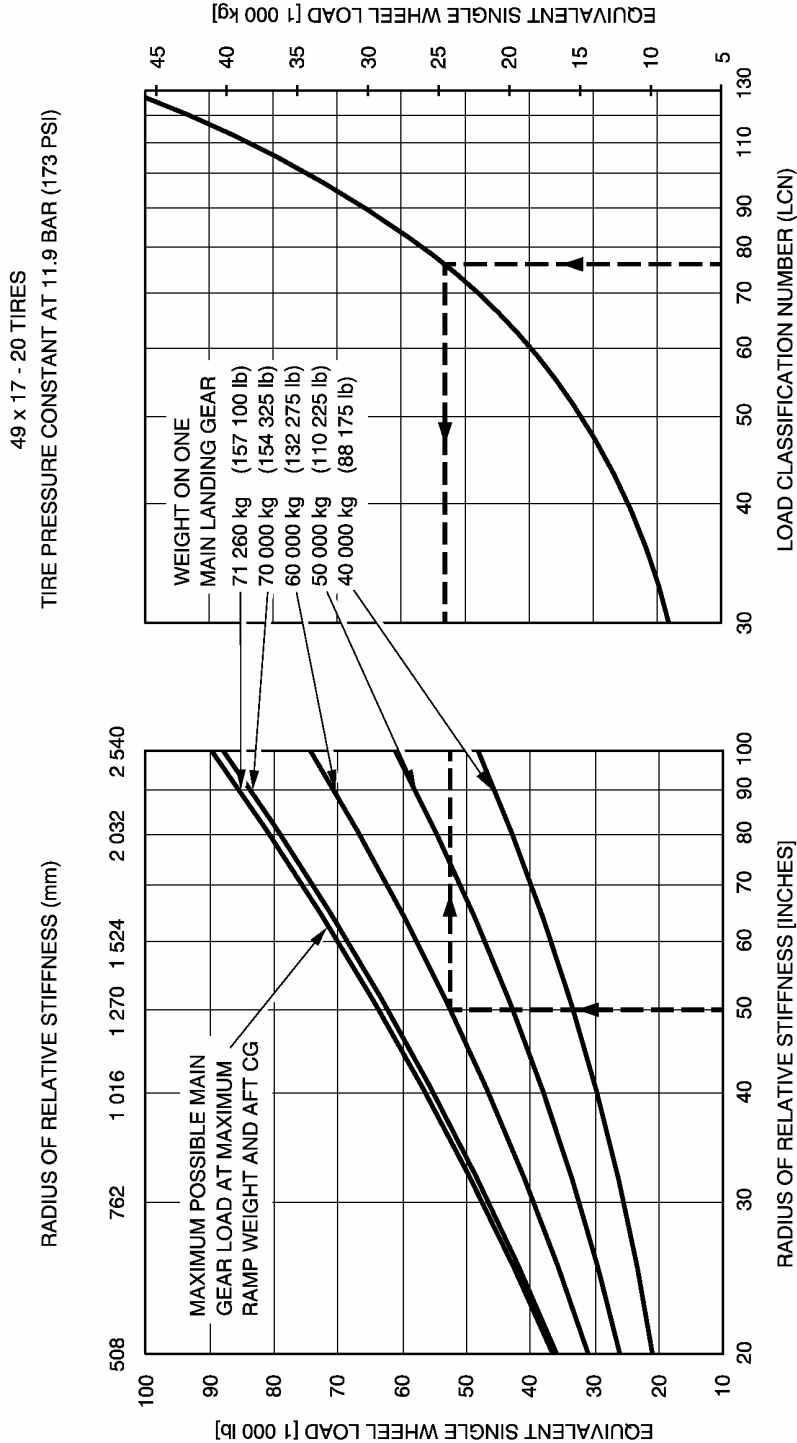

NOTE: EQUIVALENT SINGLE WHEEL LOADS ARE DERIVED BY METHODS SHOWN IN ICAO AERODROME MANUAL PART 2 PAR 4.1.3 Second Edition 1965.

AIRPLANE CHARACTERISTICS FOR AIRPORT PLANNING

BA5 07 08 02 1 AWM0 00

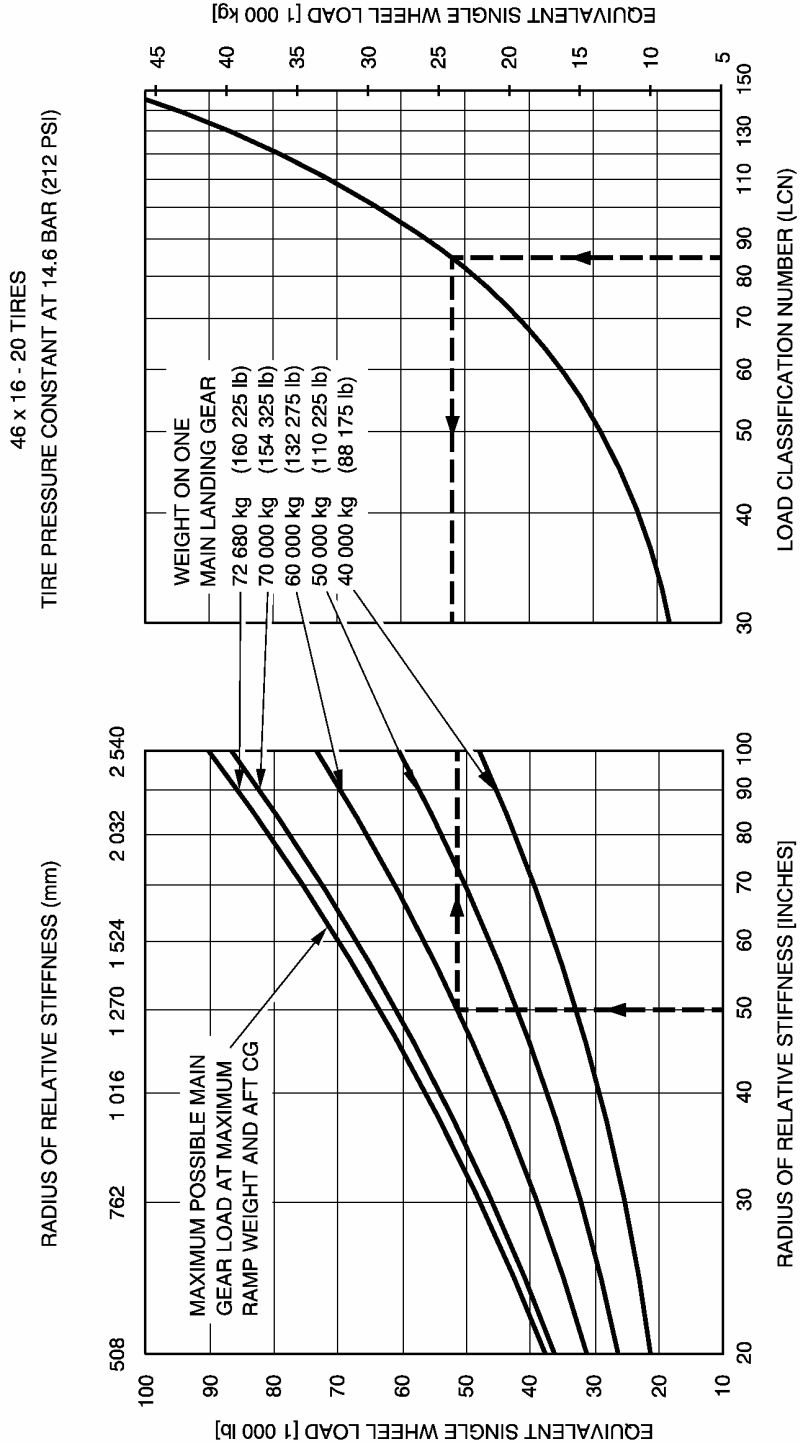

**Rigid Pavement Requirements LCN
A310-300 Models - MRW 153 900 kg**

AIRPLANE CHARACTERISTICS FOR AIRPORT PLANNING

BA5 07 08 02 1 AYM0 00

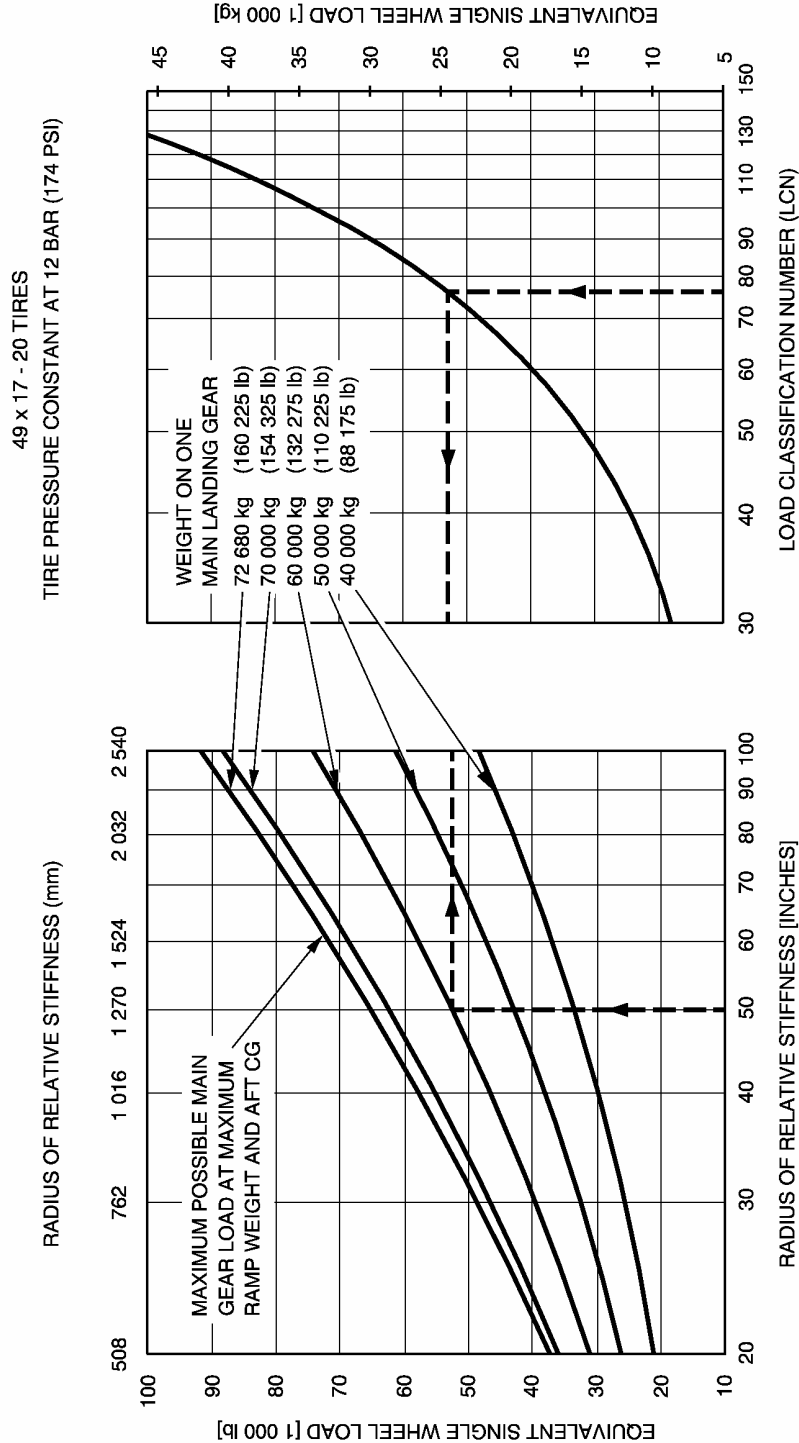

NOTE: EQUIVALENT SINGLE WHEEL LOADS ARE DERIVED BY METHODS SHOWN IN ICAO AERODROME MANUAL PART 2 PAR 4.1.3 Second Edition 1965.

AIRPLANE CHARACTERISTICS FOR AIRPORT PLANNING

BA5 07 08 02 1 BAM0 00

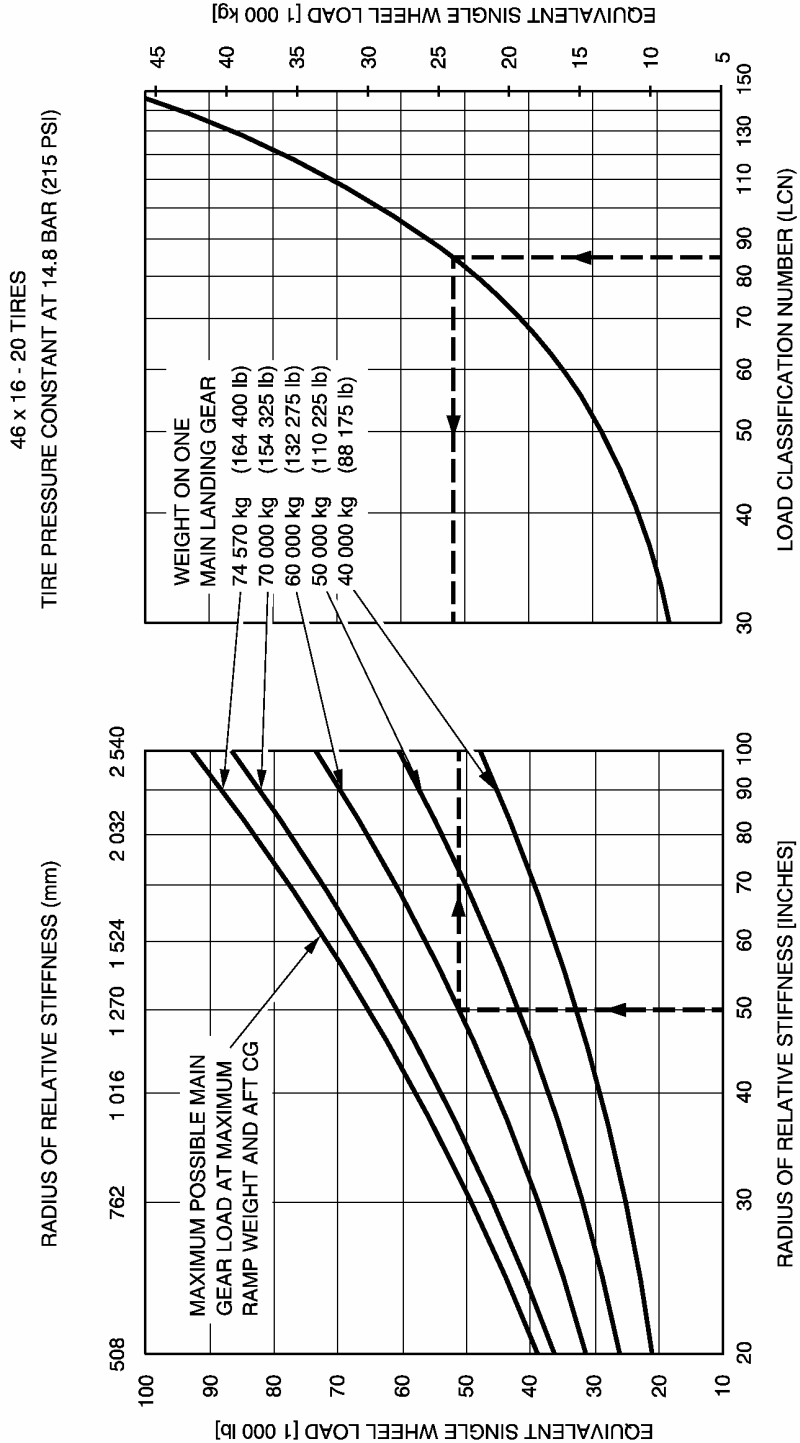

**Rigid Pavement Requirements LCN
A310-300 Models - MRW 157 900 kg**

NOTE: EQUIVALENT SINGLE WHEEL LOADS ARE DERIVED BY METHODS SHOWN IN ICAO AERODROME MANUAL PART 2 PAR 4.1.3 Second Edition 1965.

AIRPLANE CHARACTERISTICS FOR AIRPORT PLANNING

BA5 07 08 02 1 BCM0 00

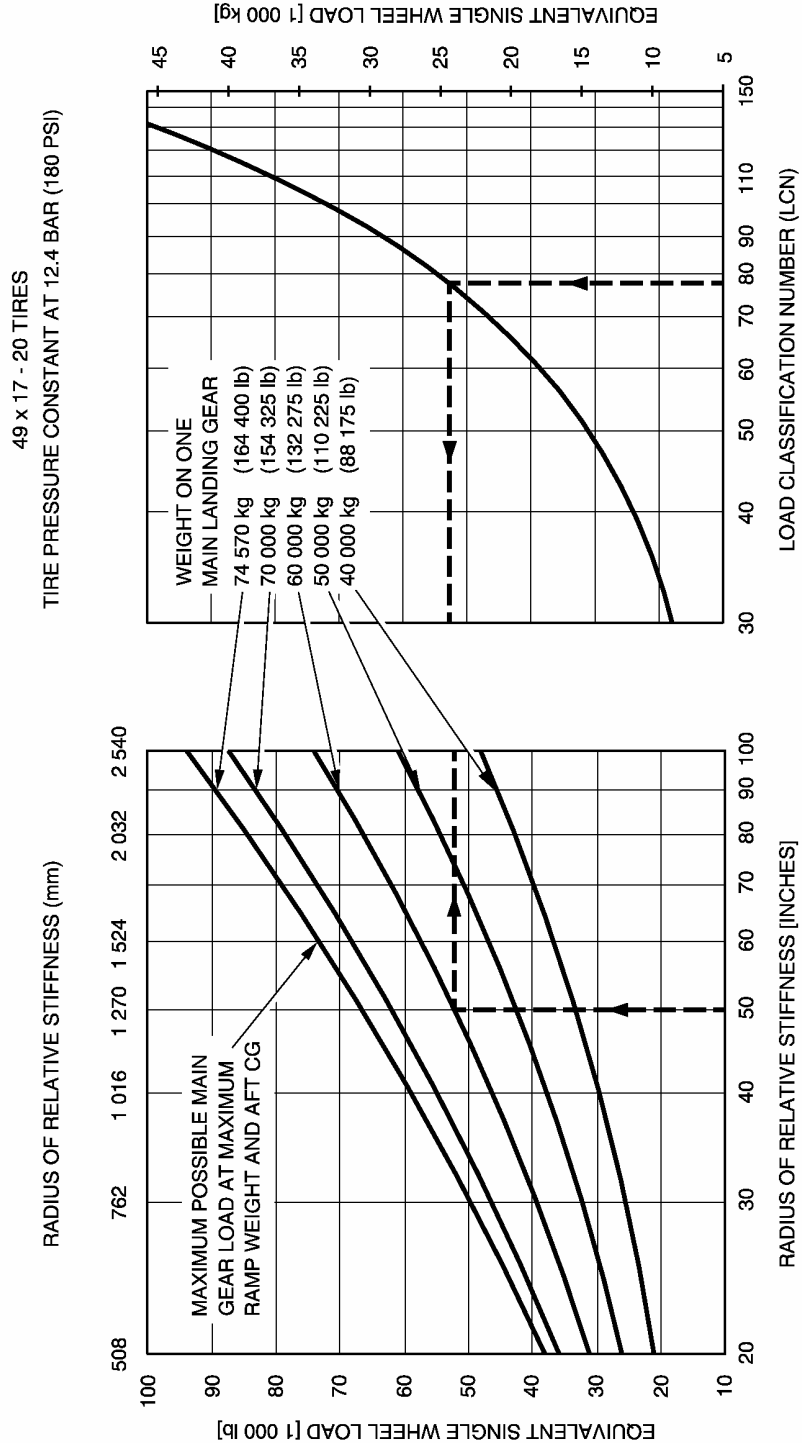

NOTE: EQUIVALENT SINGLE WHEEL LOADS ARE DERIVED BY METHODS SHOWN IN ICAO AERODROME MANUAL PART 2 PAR 4.1.3 Second Edition 1965.

AIRPLANE CHARACTERISTICS FOR AIRPORT PLANNING

BA5 07 08 02 1 BEM0 00

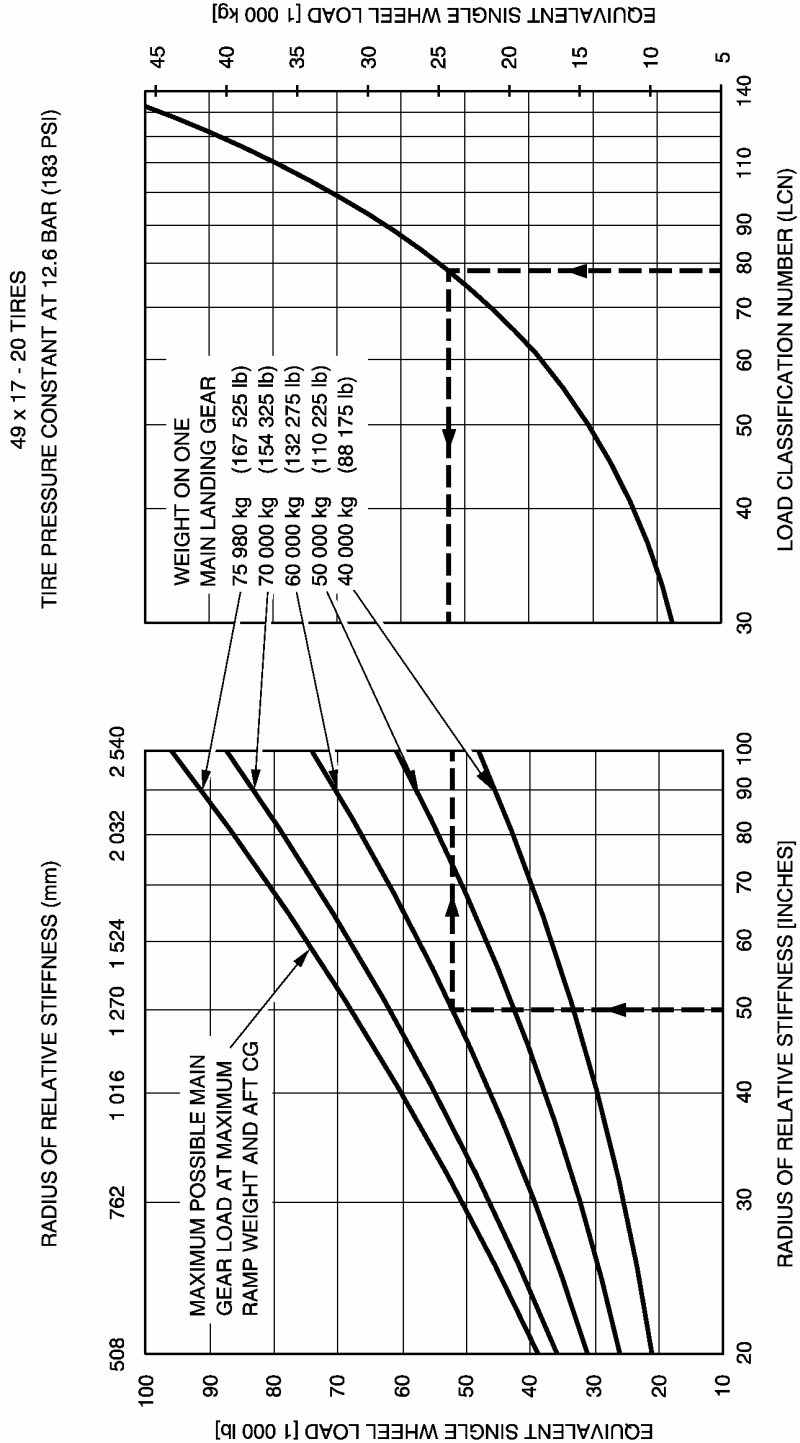

**Rigid Pavement Requirements LCN
A310-300 Models - MRW 160 900 kg**

NOTE: EQUIVALENT SINGLE WHEEL LOADS ARE DERIVED BY METHODS SHOWN IN ICAO AERODROME MANUAL PART 2 PAR 4.1.3 Second Edition 1965.

AIRPLANE CHARACTERISTICS FOR AIRPORT PLANNING

BA5 07 08 02 1 BGM0 00

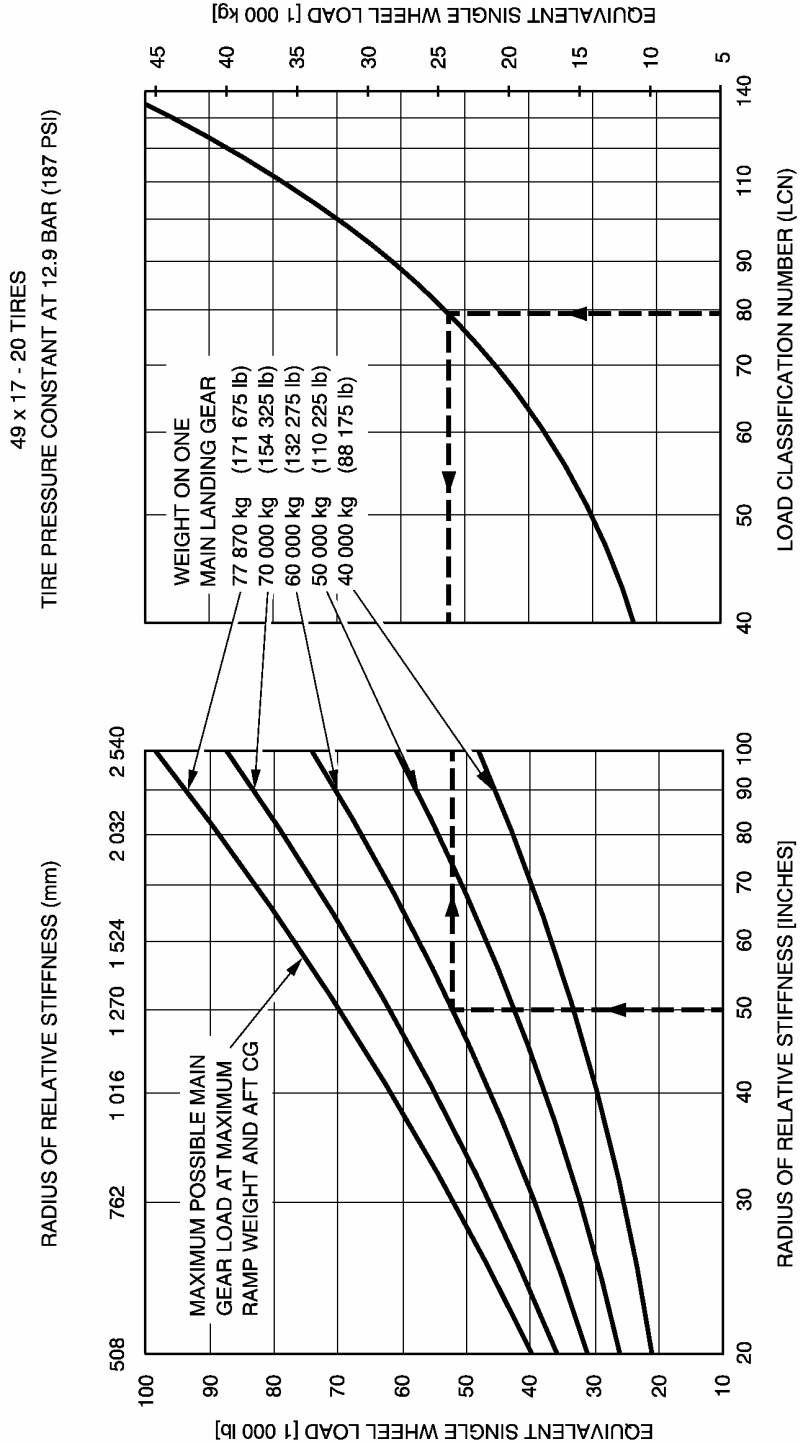

NOTE: EQUIVALENT SINGLE WHEEL LOADS ARE DERIVED BY METHODS SHOWN IN ICAO AERODROME MANUAL PART 2 PAR 4.1.3 Second Edition 1965.

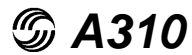

AIRPLANE CHARACTERISTICS FOR AIRPORT PLANNING

7.8.3 Radius of Relative Stiffness (Other values of E and μ)

- A310-200 Models - A310-300 Models

The table "Radius of Relative Stiffness" of Chapter 7.8.1 presents L values based on Young's Modulus (E) of 4 000 000 psi and Poisson's Ratio (μ) of 0.15.

To find L values based on other values of E and μ ,
See Section 7.8.4 "Radius of Relative Stiffness".

For example, to find an L value based on an E of 3 000 000 psi, the "E" factor of 0.931 is multiplied by the L value found in the table "Radius of Relative Stiffness" of Section 7.8.1. "Radius of Relative Stiffness".

The effect of variations of μ on the L value is treated in a similar manner.

AIRPLANE CHARACTERISTICS FOR AIRPORT PLANNING

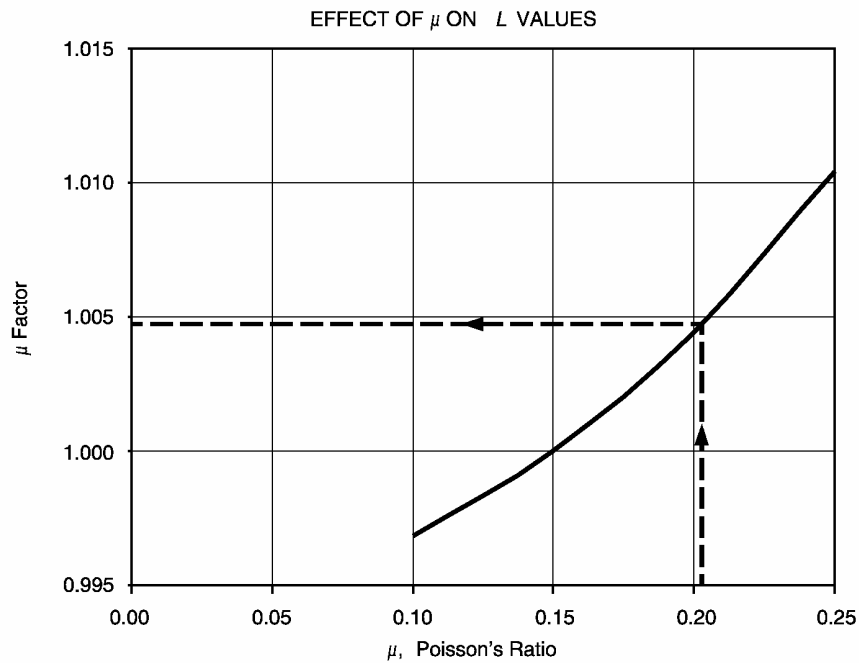
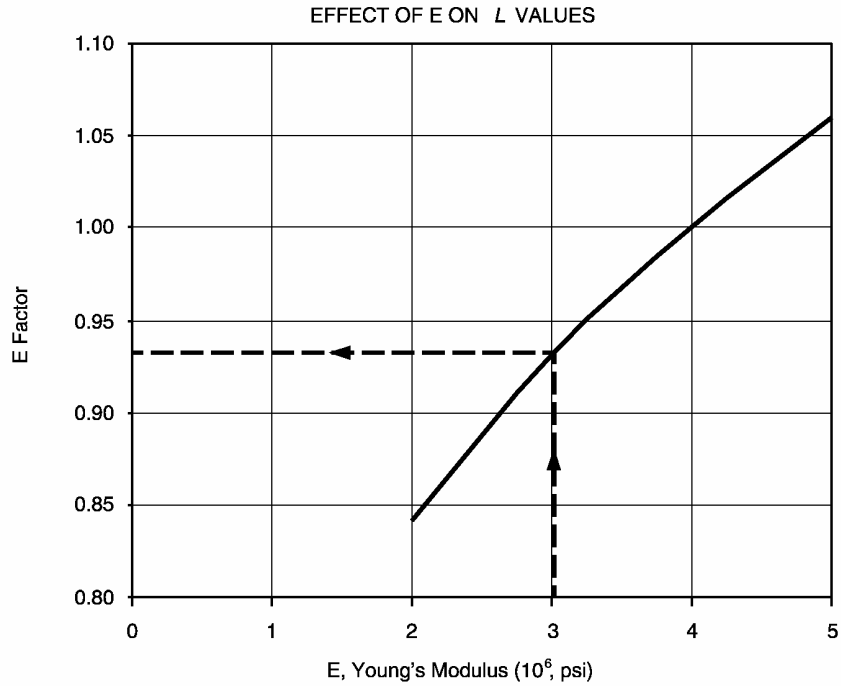

NOTE: BOTH CURVES ON THIS PAGE ARE USED TO ADJUST THE L VALUES OF "RADIUS OF RELATIVE STIFFNESS" IN SECTION 7-8-1.

Radius of relative stiffness
(Effect E and μ on "L" values)

BA5 07 08 04 1 AAM0 00



AIRPLANE CHARACTERISTICS FOR AIRPORT PLANNING

7.9 ACN/PCN Reporting System

- A310-200 Models

To find the ACN of an aircraft on flexible or rigid pavement, the aircraft gross weight and the subgrade strength must be known.

In the example shown in Section 7.9.1 with MRW 132 900 kg.

For an Aircraft Gross Weight of 110 000 kg (242 500 lb) and low subgrade strength (code B), the ACN for the flexible pavement is 29.

In the example shown in Section 7.9.2 with MRW 132 900 kg.

For an Aircraft Gross Weight 110 000 kg (242 500 lb) and low subgrade strength (code B), the ACN for the rigid pavement is 30.

NOTE : An aircraft with an ACN equal to or less than the reported PCN can operate on that pavement, subject to any limitation on the tire pressure.

(Ref. ICAO Aerodrome Design Manual Part 3 Chapter 1 Second Edition 1983).



AIRPLANE CHARACTERISTICS FOR AIRPORT PLANNING

7.9 ACN/PCN Reporting System

- A310-300 Models

To find the ACN of an aircraft on flexible or rigid pavement, the aircraft gross weight and the subgrade strength must be known.

In the example shown in Section 7.9.1 with MRW 135 900 kg.

For an Aircraft Gross Weight of 110 000 kg (242 500 lb) and low subgrade strength (code B), the ACN for the flexible pavement is 29.

In the example shown in Section 7.9.2 with MRW 139 500 kg.

For an Aircraft Gross Weight 110 000 kg (242 500 lb) and low subgrade strength (code B), the ACN for the rigid pavement is 30.

NOTE : An aircraft with an ACN equal to or less than the reported PCN can operate on that pavement, subject to any limitation on the tire pressure.

(Ref. ICAO Aerodrome Design Manual Part 3 Chapter 1 Second Edition 1983).

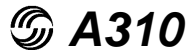

AIRPLANE CHARACTERISTICS FOR AIRPORT PLANNING

BA5 07 09 01 1 AAM0 00

ACN WAS DETERMINED AS REFERENCED IN ICAO AERODROME DESIGN MANUAL PART 3 CHAPTER 1. Second Edition 1983.
CG USED FOR ACN CALCULATIONS: 35% MAC
See Section 7-4-1 MRW 132 900 kg.

46 x 16 - 20 TIRES
TIRE PRESSURE CONSTANT AT 12.3 BAR (178 PSI)

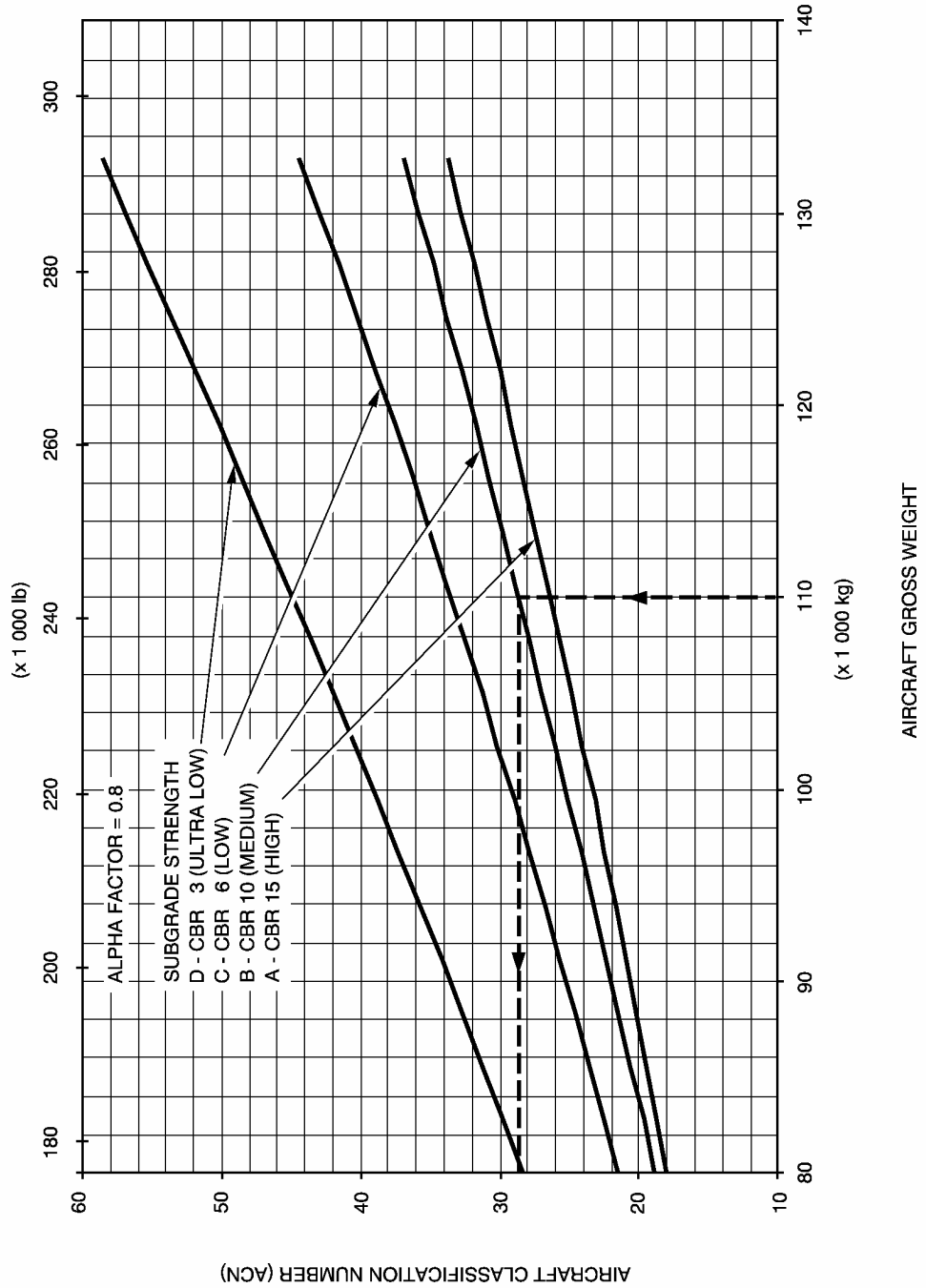

Aircraft Classification Number - Flexible Pavement
A310-200 Models - MRW 132 900 kg

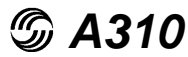

AIRPLANE CHARACTERISTICS FOR AIRPORT PLANNING

BA5 07 09 01 1 ACM0 00

ACN WAS DETERMINED AS REFERENCED IN ICAO AERODROME DESIGN MANUAL PART 3 CHAPTER 1. Second Edition 1983.
CG USED FOR ACN CALCULATIONS: 35% MAC
See Section 7-4-1 MRW 132 900 kg.

49 x 17 - 20 TIRES
TIRE PRESSURE CONSTANT AT 10.2 BAR (148 PSI)

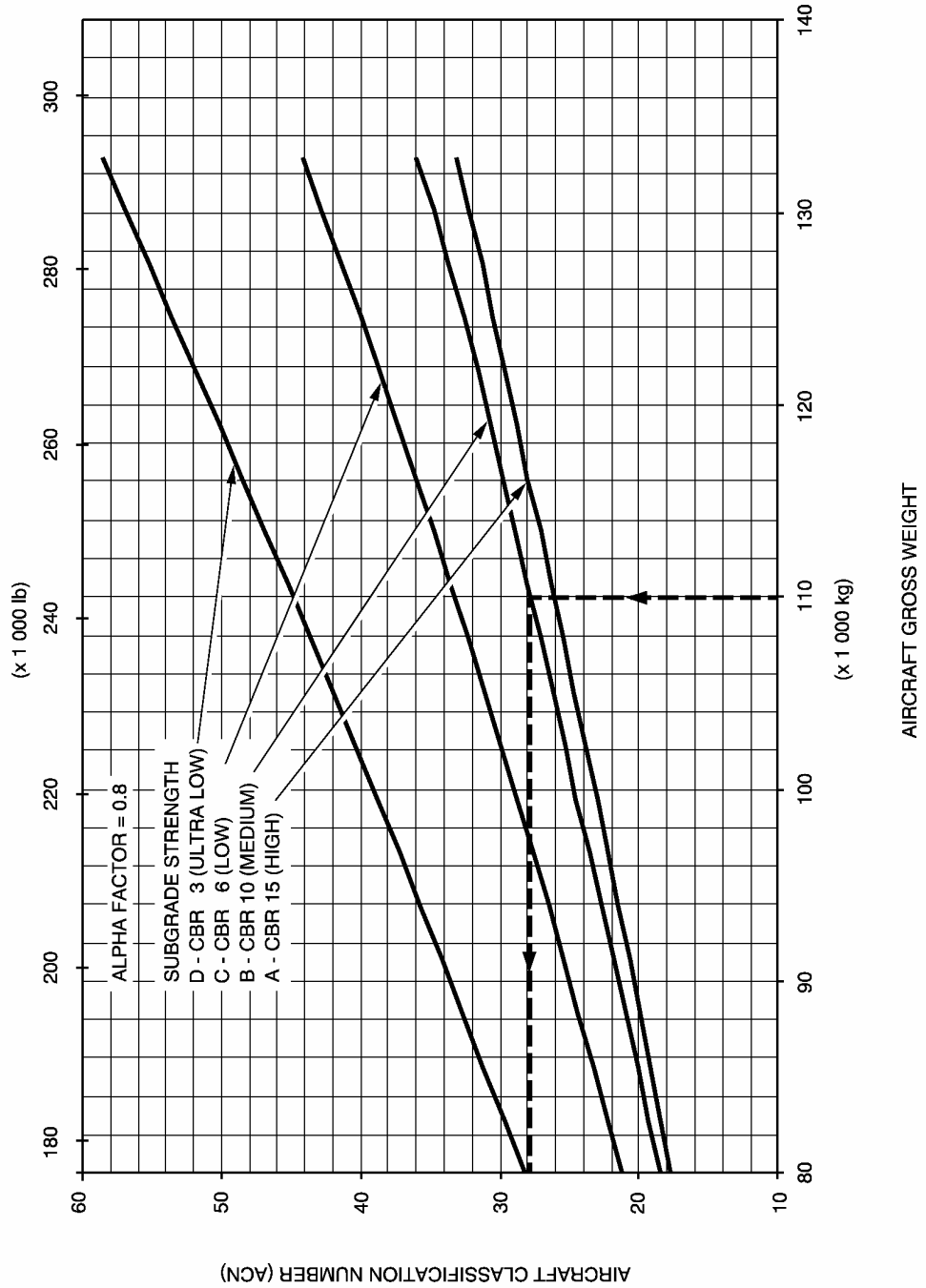

Aircraft Classification Number - Flexible Pavement
A310-200 Models - MRW 132 900 kg

AIRPLANE CHARACTERISTICS FOR AIRPORT PLANNING

BA5 07 09 01 1 AEM0 00

ACN WAS DETERMINED AS REFERENCED IN
ICAO AERODROME DESIGN MANUAL PART 3
CHAPTER 1. Second Edition 1983.
CG USED FOR ACN CALCULATIONS: 35% MAC
See Section 7-4-1 MRW 139 500 kg.

46 x 16 - 20 TIRES
TIRE PRESSURE CONSTANT AT 13 BAR (189 PSI)

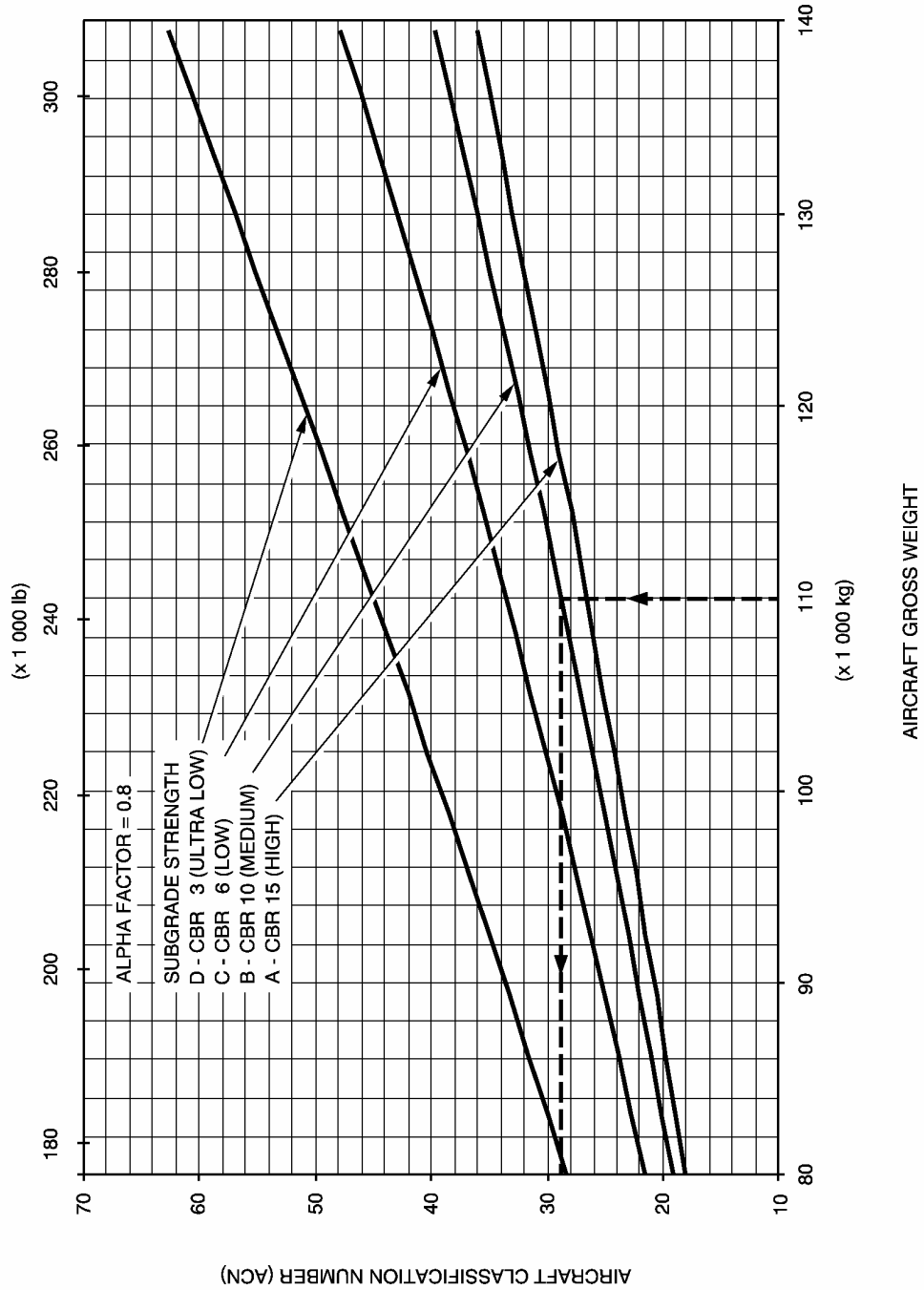

Aircraft Classification Number - Flexible Pavement
A310-200 Models - MRW 139 500 kg

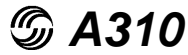

AIRPLANE CHARACTERISTICS FOR AIRPORT PLANNING

BA5 07 09 01 1 AGM0 00

ACN WAS DETERMINED AS REFERENCED IN
ICAO AERODROME DESIGN MANUAL PART 3
CHAPTER 1. Second Edition 1983.
CG USED FOR ACN CALCULATIONS: 35% MAC
See Section 7-4-1 MRW 139 500 kg.

49 x 17 - 20 TIRES
TIRE PRESSURE CONSTANT AT 10.8 BAR (157 PSI)

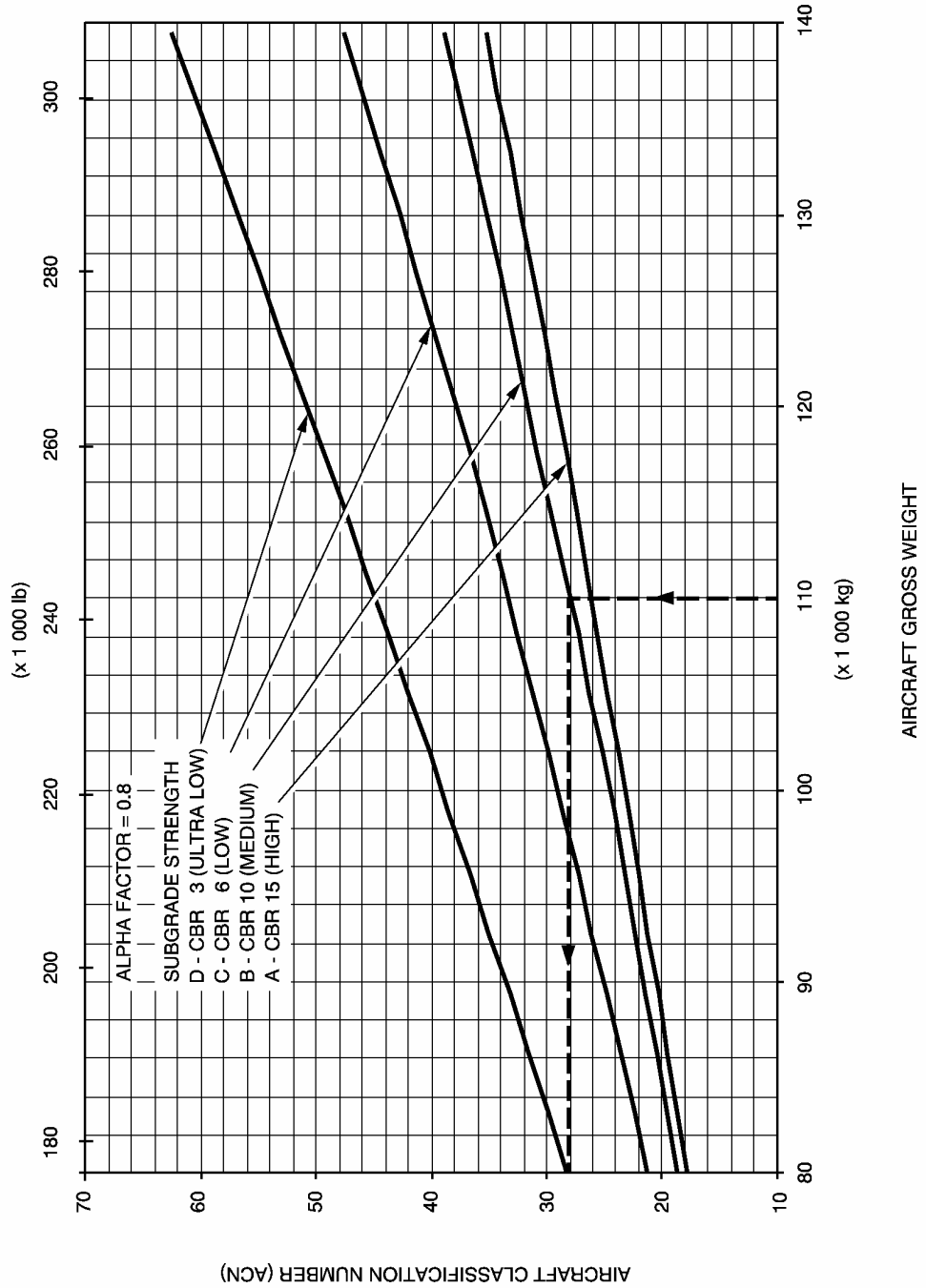

Aircraft Classification Number - Flexible Pavement
A310-200 Models - MRW 139 500 kg

AIRPLANE CHARACTERISTICS FOR AIRPORT PLANNING

BA5 07 09 01 1 AJM0 00

ACN WAS DETERMINED AS REFERENCED IN
ICAO AERODROME DESIGN MANUAL PART 3
CHAPTER 1. Second Edition 1983.
CG USED FOR ACN CALCULATIONS: 35% MAC
See Section 7-4-1 MRW 142 900 kg.

46 x 16 - 20 TIRES
TIRE PRESSURE CONSTANT AT 13.3 BAR (193 PSI)

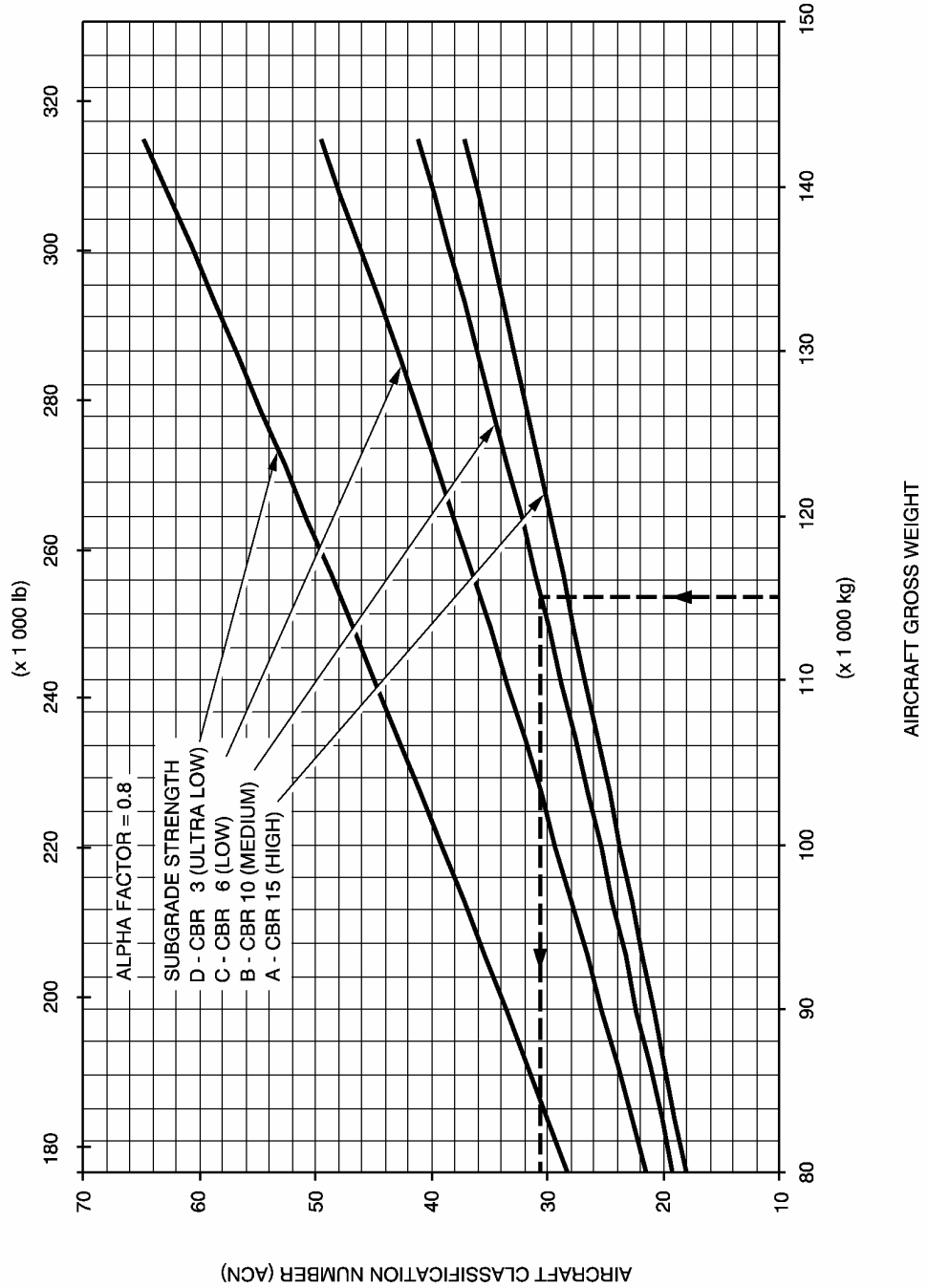

Aircraft Classification Number - Flexible Pavement
A310-200 Models - MRW 142 900 kg

AIRPLANE CHARACTERISTICS FOR AIRPORT PLANNING

BA5 07 09 01 1 ALM0 00

ACN WAS DETERMINED AS REFERENCED IN
ICAO AERODROME DESIGN MANUAL PART 3
CHAPTER 1. Second Edition 1983.
CG USED FOR ACN CALCULATIONS: 35% MAC
See Section 7-4-1 MRW 142 900 kg.

49 x 17 - 20 TIRES
TIRE PRESSURE CONSTANT AT 11 BAR (160 PSI)

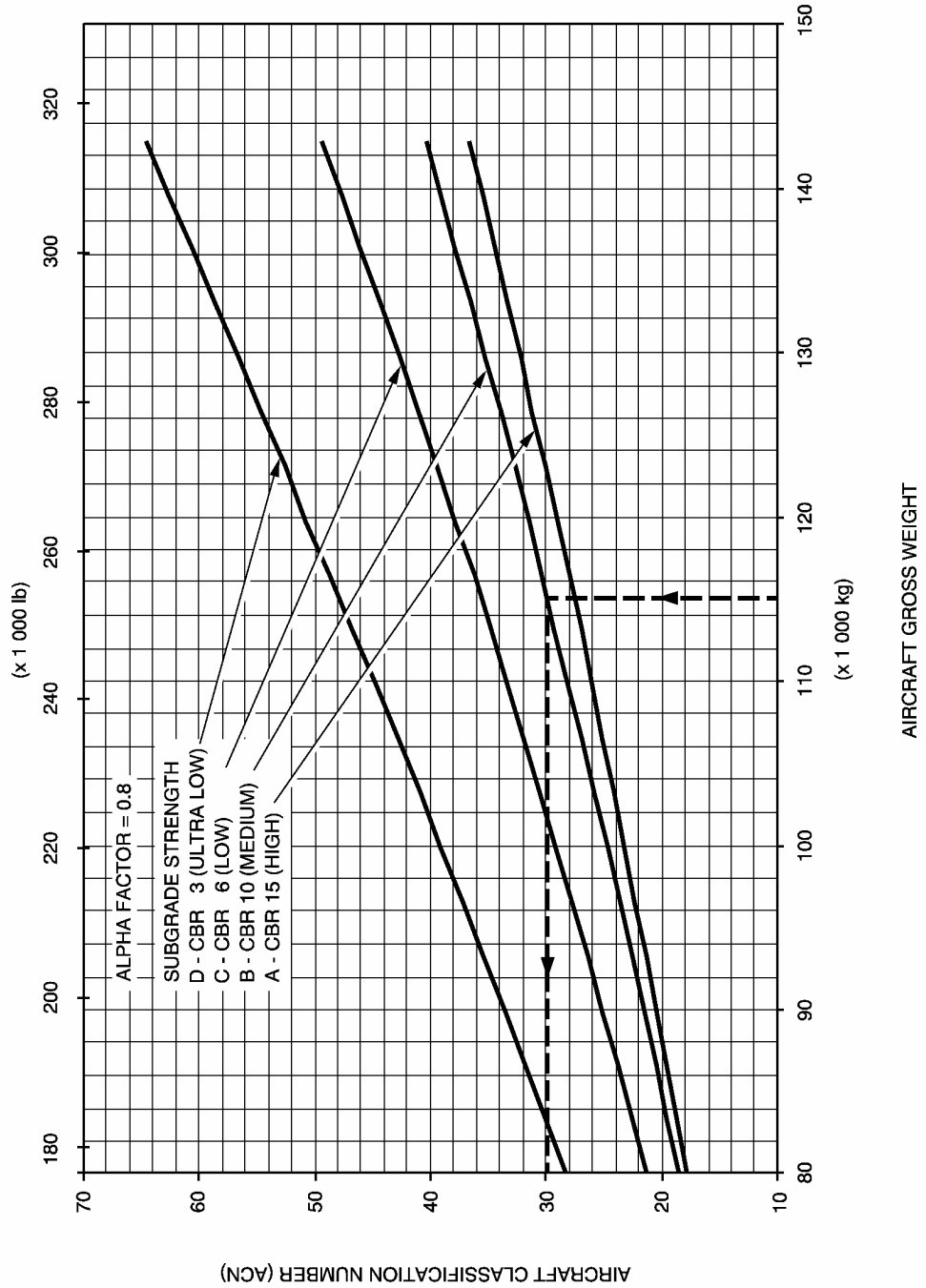

Aircraft Classification Number - Flexible Pavement
A310-200 Models - MRW 142 900 kg

AIRPLANE CHARACTERISTICS FOR AIRPORT PLANNING

BA5 07 09 01 1 ANM0 00

ACN WAS DETERMINED AS REFERENCED IN
ICAO AERODROME DESIGN MANUAL PART 3
CHAPTER 1. Second Edition 1983.
CG USED FOR ACN CALCULATIONS: 37.2% MAC
See Section 7-4-1 MRW 139 500 kg.

46 x 16 - 20 TIRES
TIRE PRESSURE CONSTANT AT 13.2 BAR (191 PSI)

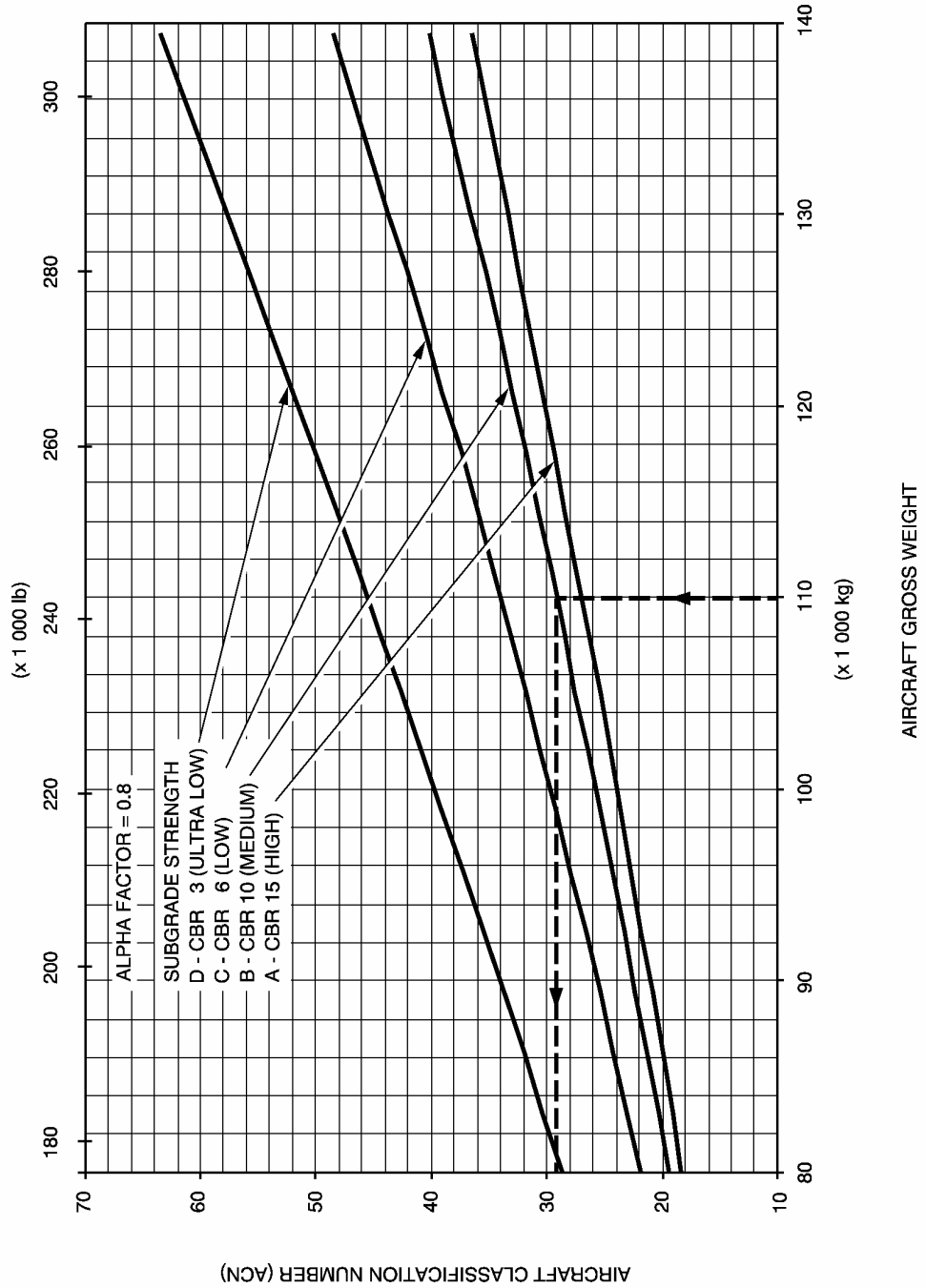

Aircraft Classification Number - Flexible Pavement
A310-300 Models - MRW 139 500 kg

AIRPLANE CHARACTERISTICS FOR AIRPORT PLANNING

BA5 07 09 01 1 AQM0 00

ACN WAS DETERMINED AS REFERENCED IN
 ICAO AERODROME DESIGN MANUAL PART 3
 CHAPTER 1. Second Edition 1983.
 CG USED FOR ACN CALCULATIONS: 37.2% MAC
 See Section 7-4-1 MRW 139 500 kg.

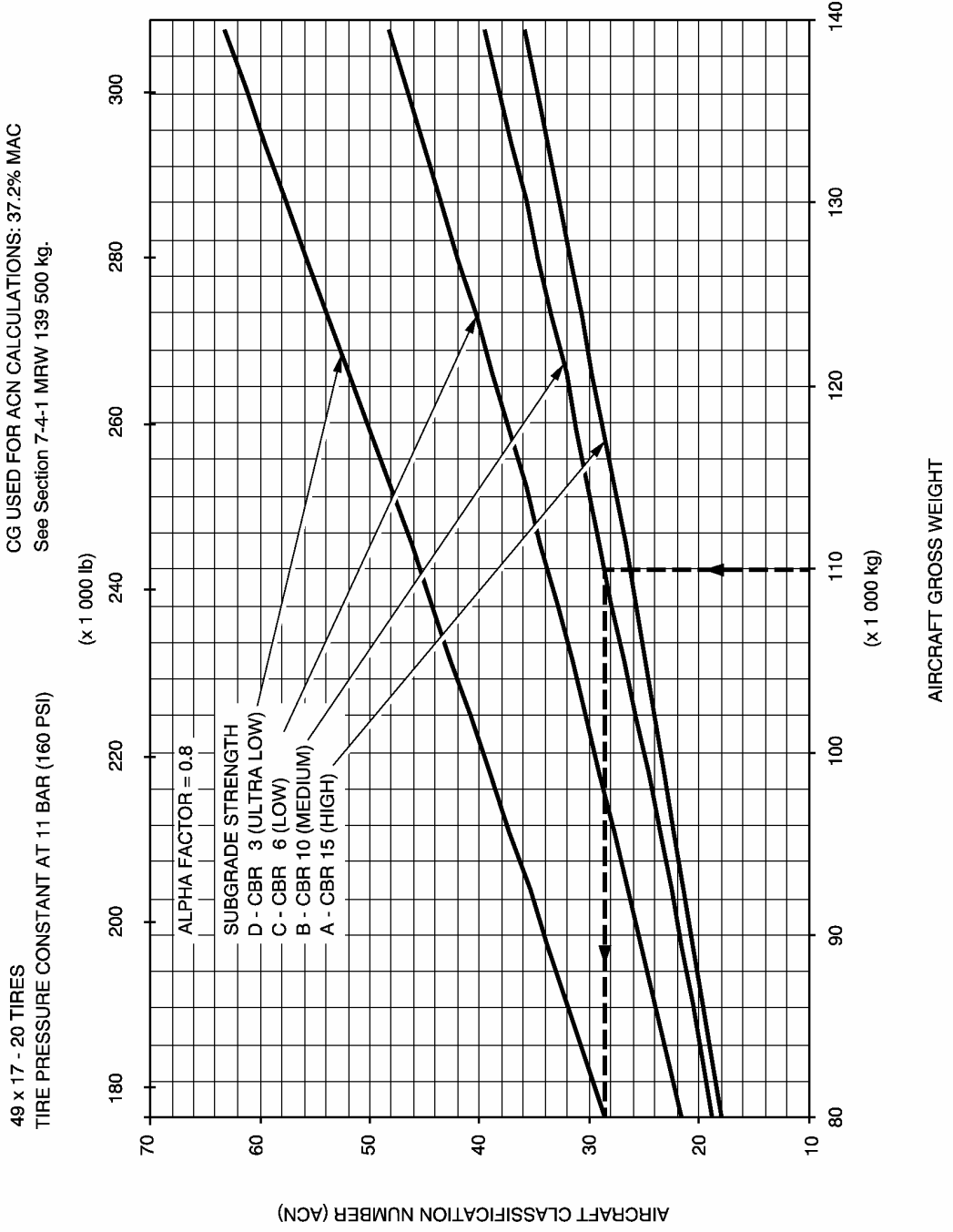

Aircraft Classification Number - Flexible Pavement
 A310-300 Models - MRW 139 500 kg

AIRPLANE CHARACTERISTICS FOR AIRPORT PLANNING

BA5 07 09 01 1 ASM0 00

ACN WAS DETERMINED AS REFERENCED IN
ICAO AERODROME DESIGN MANUAL PART 3
CHAPTER 1. Second Edition 1983.
CG USED FOR ACN CALCULATIONS: 38% MAC
See Section 7-4-1 MRW 150 900 kg.

46 x 16 - 20 TIRES
TIRE PRESSURE CONSTANT AT 14.3 BAR (207 PSI)

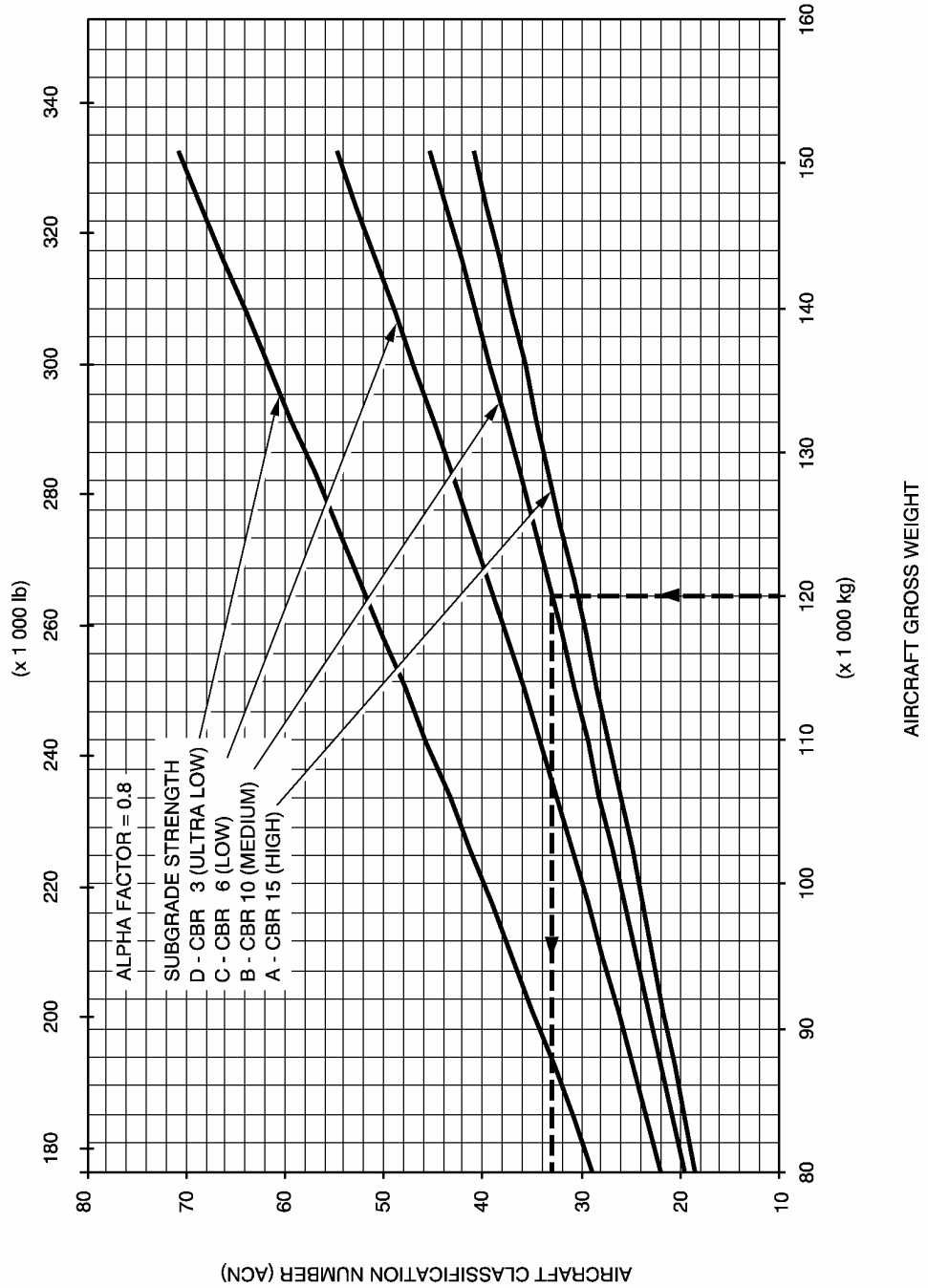

Aircraft Classification Number - Flexible Pavement
A310-300 Models - MRW 150 900 kg

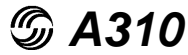

AIRPLANE CHARACTERISTICS FOR AIRPORT PLANNING

BA5 07 09 01 1 AUM0 00

ACN WAS DETERMINED AS REFERENCED IN ICAO AERODROME DESIGN MANUAL PART 3 CHAPTER 1. Second Edition 1983.
CG USED FOR ACN CALCULATIONS: 38% MAC
See Section 7-4-1 MRW 150 900 kg.

49 x 17 - 20 TIRES
TIRE PRESSURE CONSTANT AT 11.9 BAR (173 PSI)

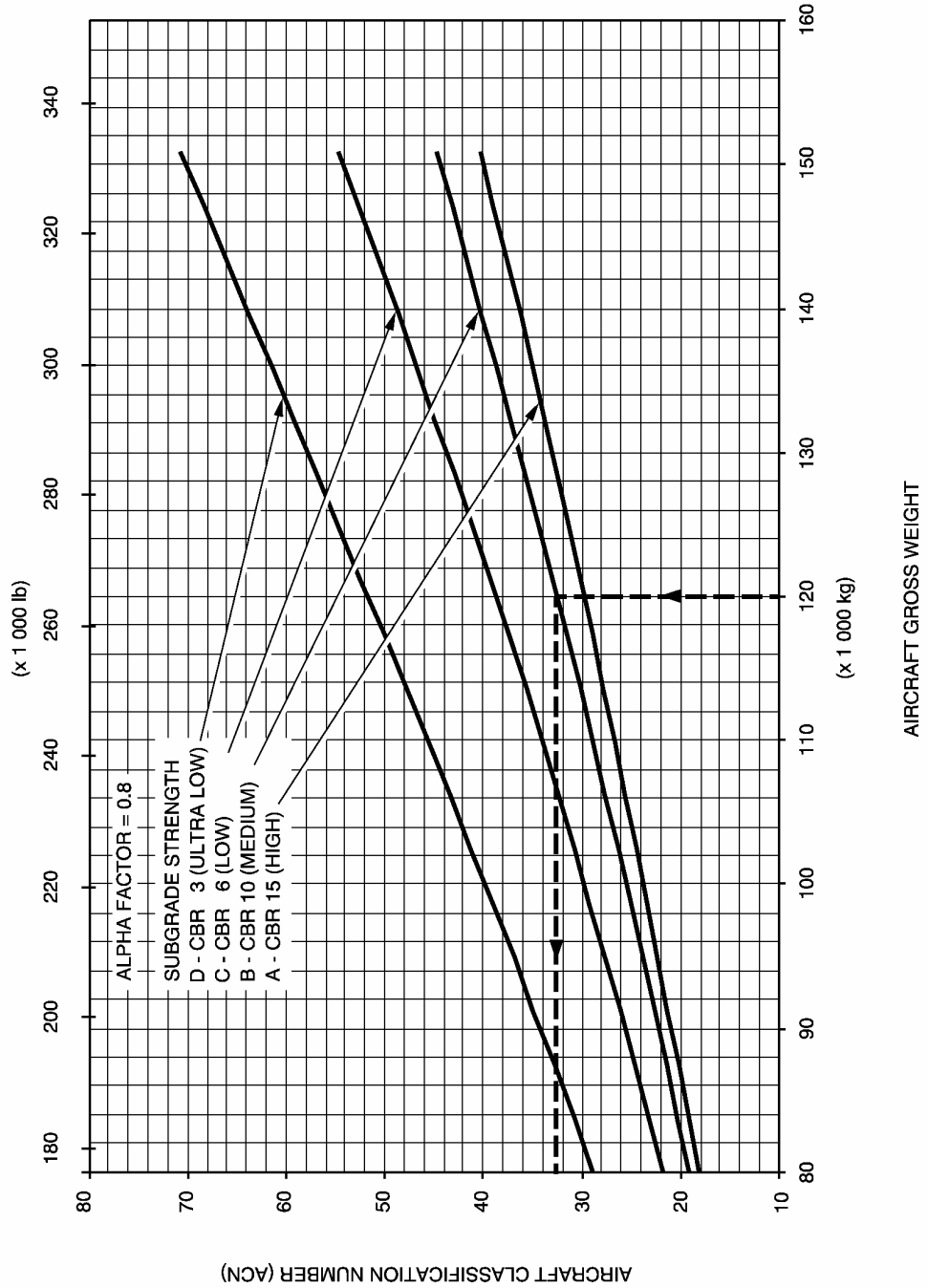

Aircraft Classification Number - Flexible Pavement
A310-300 Models - MRW 150 900 kg

AIRPLANE CHARACTERISTICS FOR AIRPORT PLANNING

BA5 07 09 01 1 AWM0 00

ACN WAS DETERMINED AS REFERENCED IN
ICAO AERODROME DESIGN MANUAL PART 3
CHAPTER 1. Second Edition 1983.
CG USED FOR ACN CALCULATIONS: 38% MAC
See Section 7-4-1 MRW 153 900 kg.

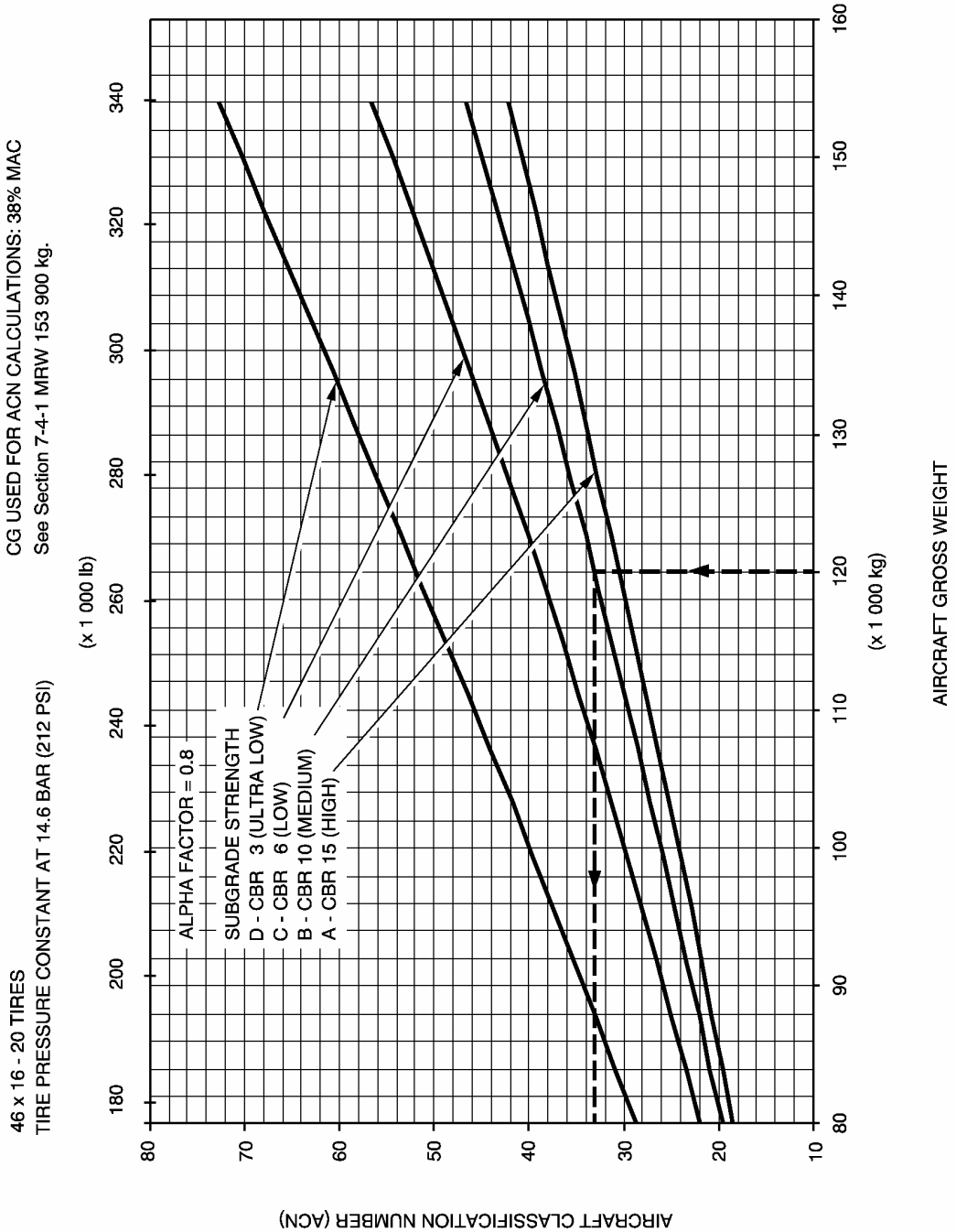

Aircraft Classification Number - Flexible Pavement
A310-300 Models - MRW 153 900 kg

AIRPLANE CHARACTERISTICS FOR AIRPORT PLANNING

BA5 07 09 01 1 AYM0 00

ACN WAS DETERMINED AS REFERENCED IN
ICAO AERODROME DESIGN MANUAL PART 3
CHAPTER 1. Second Edition 1983.

CG USED FOR ACN CALCULATIONS: 38% MAC
See Section 7-4-1 MRW 153 900 kg.

49 x 17 - 20 TIRES
TIRE PRESSURE CONSTANT AT 12 BAR (174 PSI)

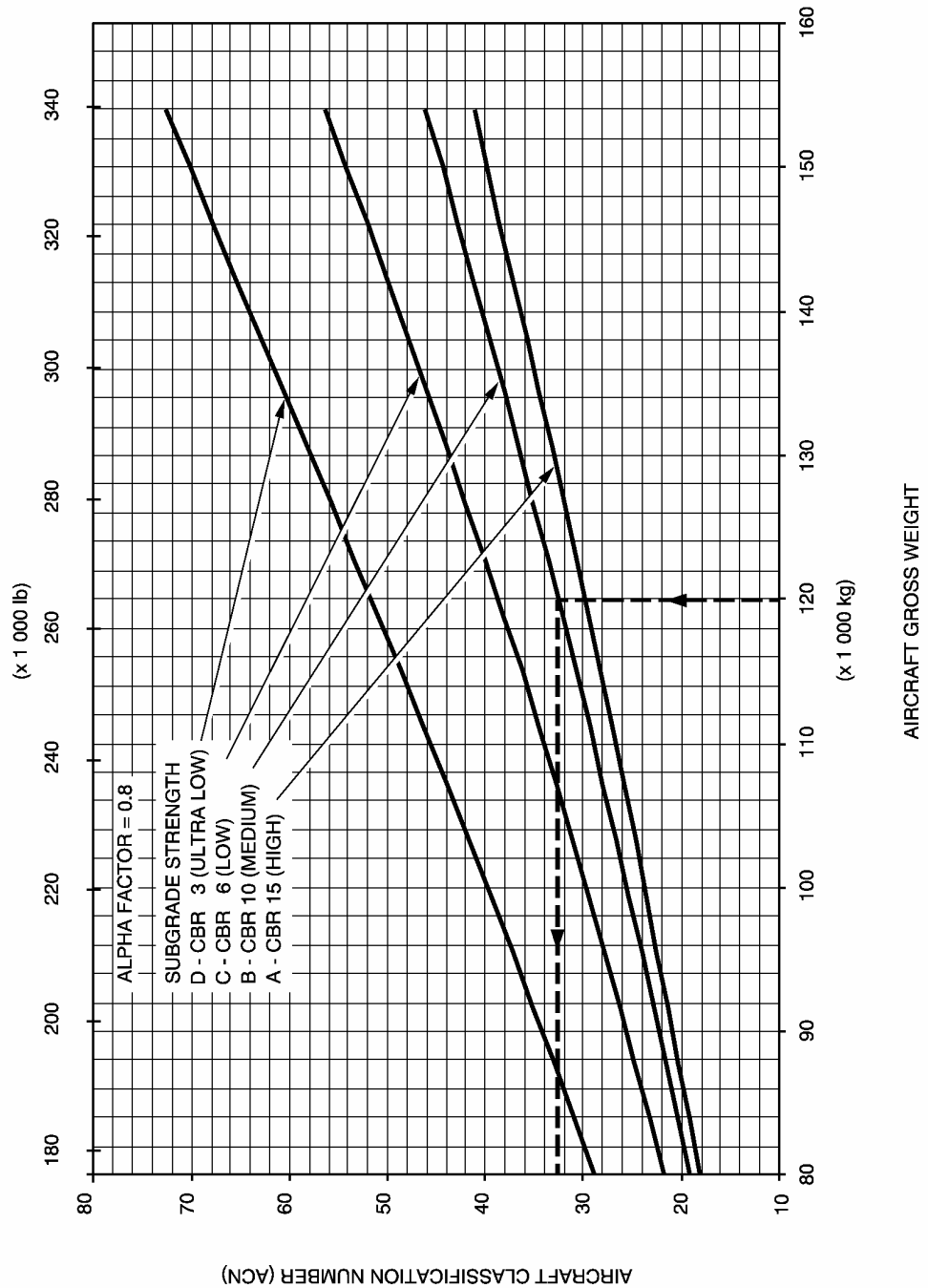

Aircraft Classification Number - Flexible Pavement
A310-300 Models - MRW 153 900 kg

AIRPLANE CHARACTERISTICS FOR AIRPORT PLANNING

BA5 07 09 01 1 BAM0 00

ACN WAS DETERMINED AS REFERENCED IN
ICAO AERODROME DESIGN MANUAL PART 3
CHAPTER 1. Second Edition 1983.
CG USED FOR ACN CALCULATIONS: 38% MAC
See Section 7-4-1 MRW 157 900 kg.

46 x 16 - 20 TIRES
TIRE PRESSURE CONSTANT AT 14.8 BAR (215 PSI)

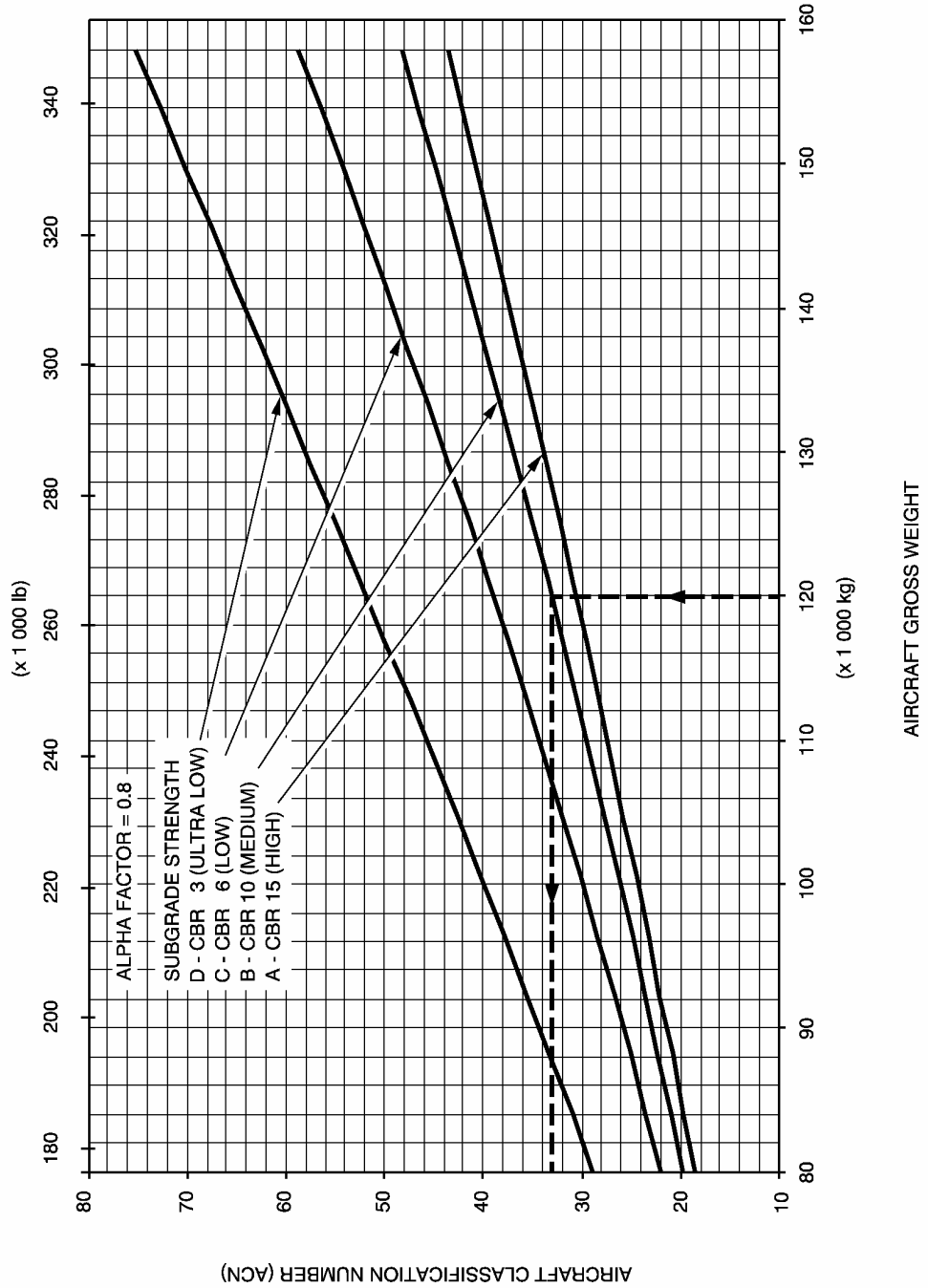

Aircraft Classification Number - Flexible Pavement
A310-300 Models - MRW 157 900 kg

AIRPLANE CHARACTERISTICS FOR AIRPORT PLANNING

BA5 07 09 01 1 BCM0 00

ACN WAS DETERMINED AS REFERENCED IN
ICAO AERODROME DESIGN MANUAL PART 3
CHAPTER 1. Second Edition 1983.
CG USED FOR ACN CALCULATIONS: 38% MAC
See Section 7-4-1 MRW 157 900 kg.

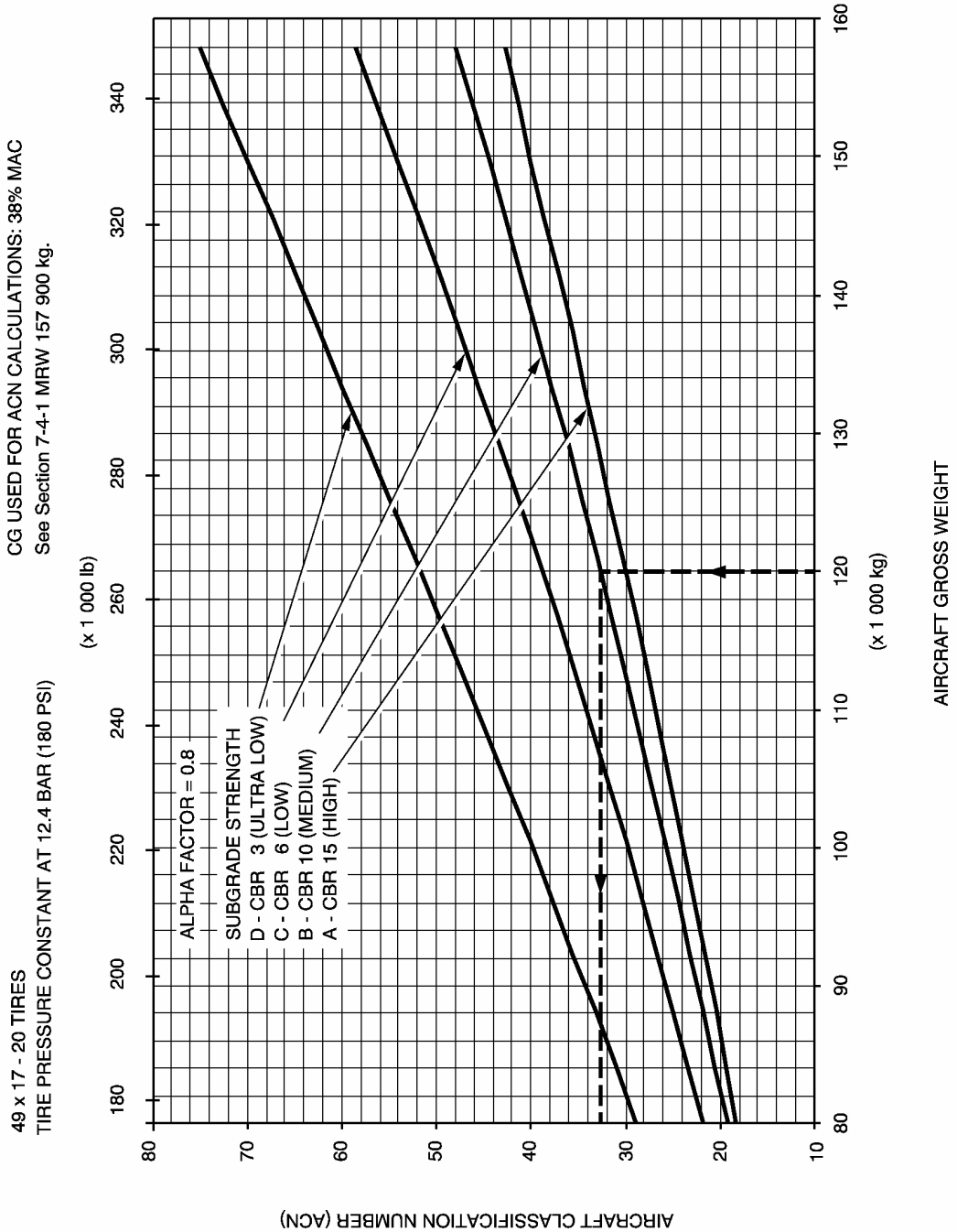

Aircraft Classification Number - Flexible Pavement
A310-300 Models - MRW 157 900 kg

AIRPLANE CHARACTERISTICS FOR AIRPORT PLANNING

BA5 07 09 01 1 BEM0 00

ACN WAS DETERMINED AS REFERENCED IN
ICAO AERODROME DESIGN MANUAL PART 3
CHAPTER 1. Second Edition 1983.
CG USED FOR ACN CALCULATIONS: 38% MAC
See Section 7-4-1 MRW 160 900 kg.

49 x 17 - 20 TIRES
TIRE PRESSURE CONSTANT AT 12.6 BAR (183 PSI)

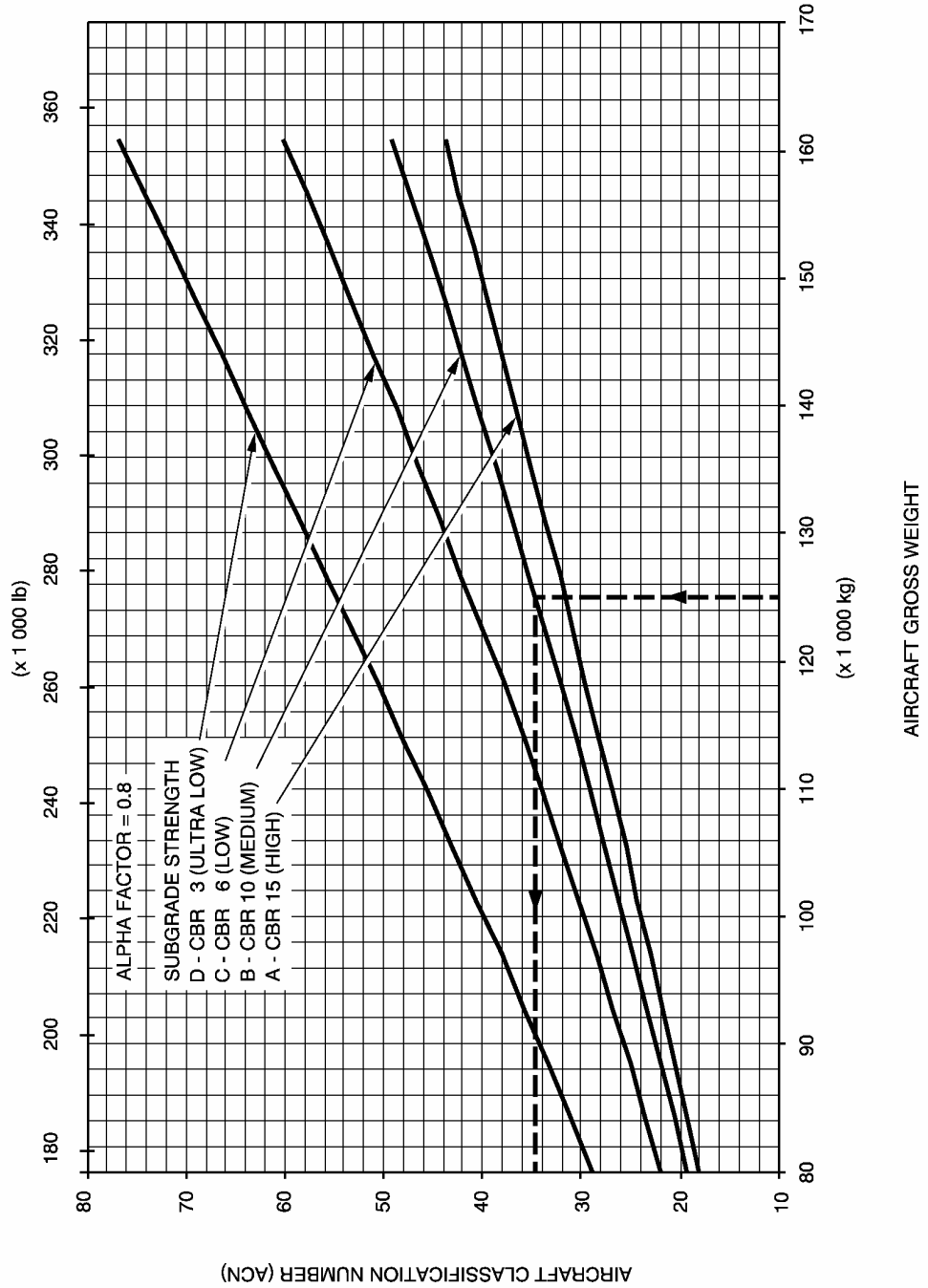

Aircraft Classification Number - Flexible Pavement
A310-300 Models - MRW 160 900 kg

AIRPLANE CHARACTERISTICS FOR AIRPORT PLANNING

BA5 07 09 01 1 BGM0 00

ACN WAS DETERMINED AS REFERENCED IN
ICAO AERODROME DESIGN MANUAL PART 3
CHAPTER 1. Second Edition 1983.
CG USED FOR ACN CALCULATIONS: 38% MAC
See Section 7-4-1 MRW 164 900 kg.

49 x 17 - 20 TIRES
TIRE PRESSURE CONSTANT AT 12.9 BAR (187 PSI)

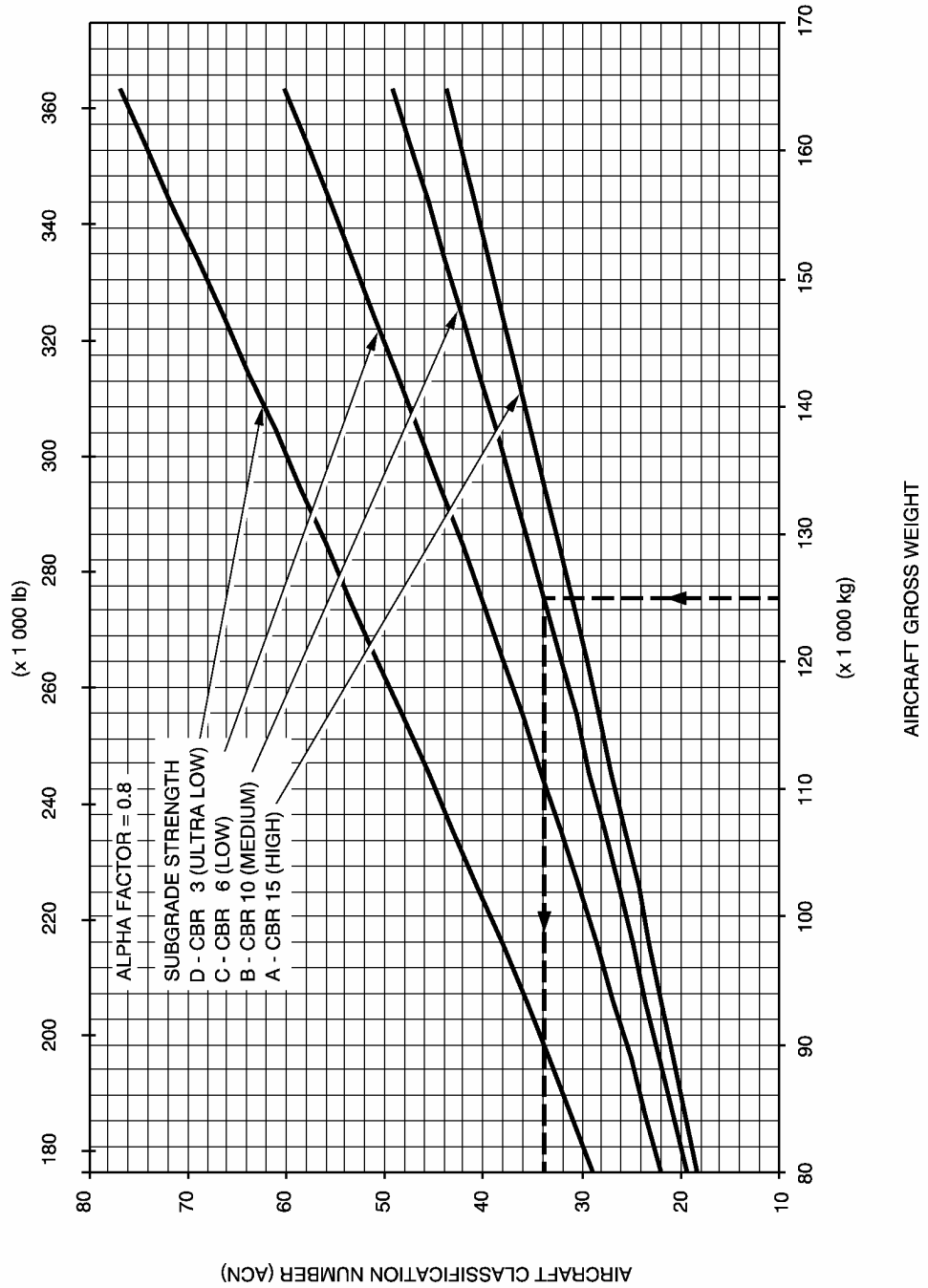

Aircraft Classification Number - Flexible Pavement
A310-300 Models - MRW 164 900 kg

AIRPLANE CHARACTERISTICS FOR AIRPORT PLANNING

BA5 07 09 02 1 AAM0 00

ACN WAS DETERMINED AS REFERENCED IN
ICAO AERODROME DESIGN MANUAL PART 3
CHAPTER 1. Second Edition 1983.
CG USED FOR ACN CALCULATIONS: 35% MAC
See Section 7-4-1 MRW 132 900 kg.

46 x 16 - 20 TIRES
TIRE PRESSURE CONSTANT AT 12.3 BAR (178 PSI)

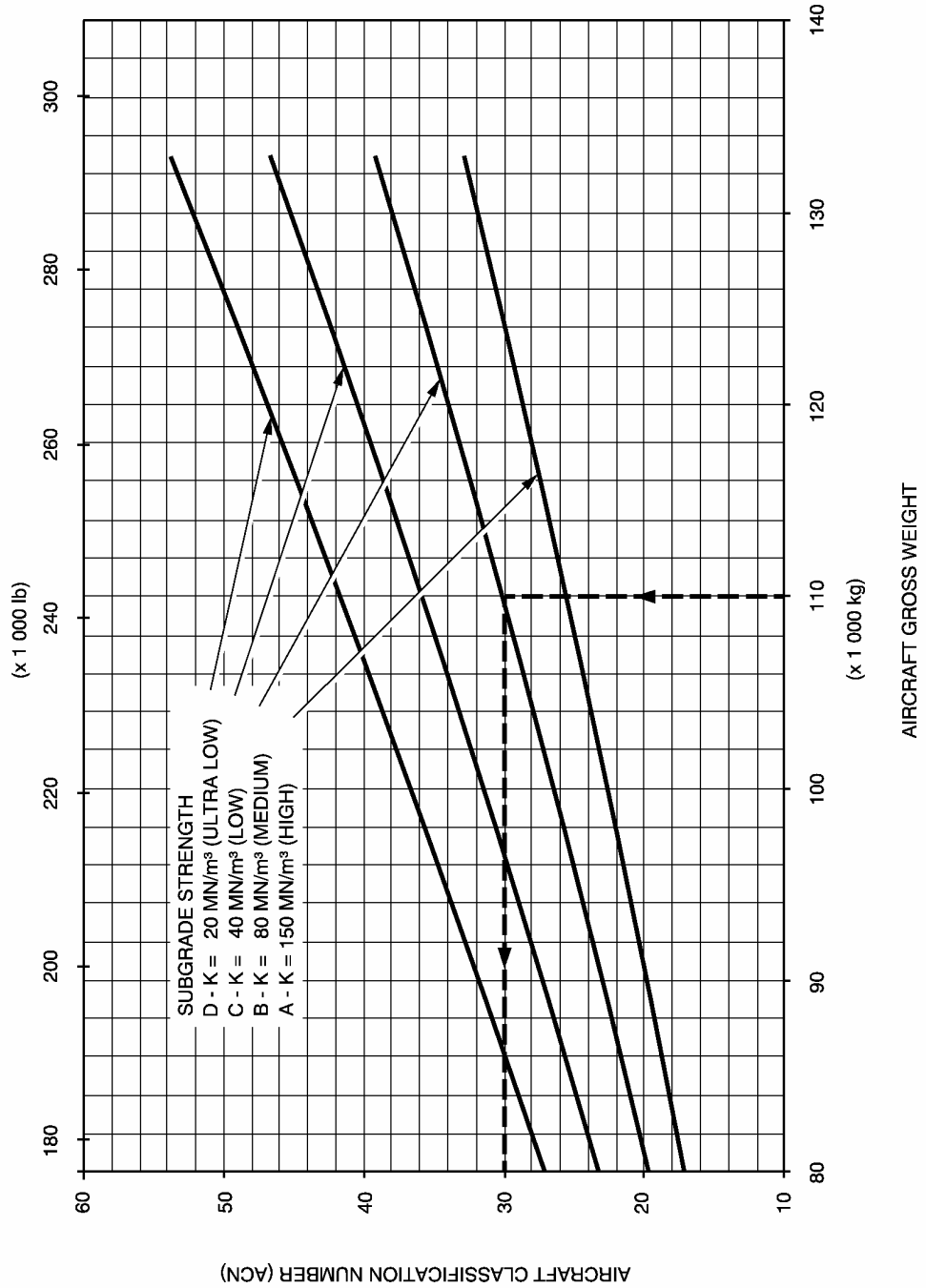

Aircraft Classification Number - Rigid Pavement
A310-200 Models - MRW 132 900 kg

AIRPLANE CHARACTERISTICS FOR AIRPORT PLANNING

BA5 07 09 02 1 ACM0 00

ACN WAS DETERMINED AS REFERENCED IN
ICAO AERODROME DESIGN MANUAL PART 3
CHAPTER 1. Second Edition 1983.
CG USED FOR ACN CALCULATIONS: 35% MAC
See Section 7-4-1 MRW 132 900 kg.

49 x 17 - 20 TIRES
TIRE PRESSURE CONSTANT AT 10.2 BAR (148 PSI)

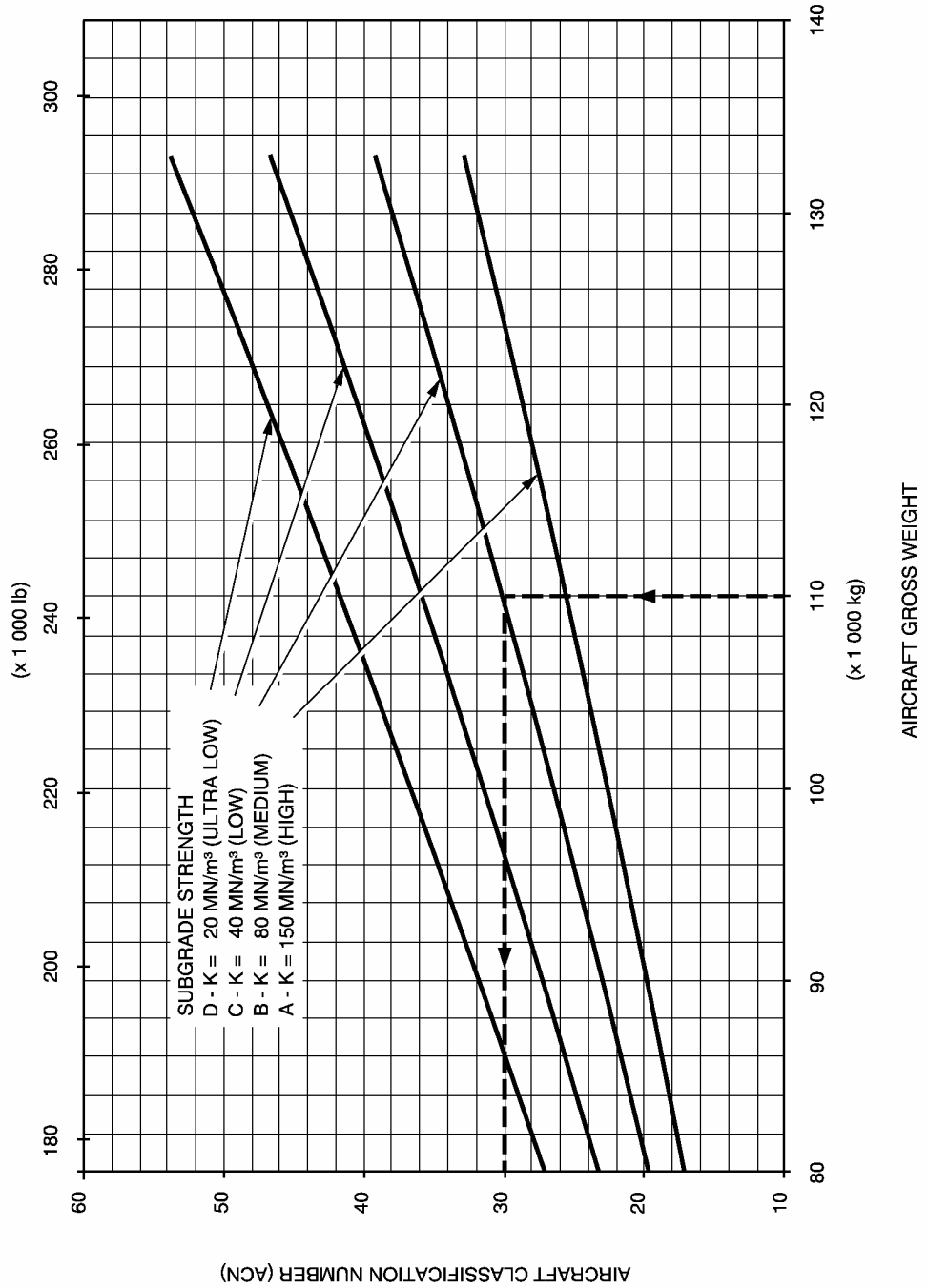

Aircraft Classification Number - Rigid Pavement
A310-200 Models - MRW 132 900 kg

AIRPLANE CHARACTERISTICS FOR AIRPORT PLANNING

BA5 07 09 02 1 AEM0 00

ACN WAS DETERMINED AS REFERENCED IN
ICAO AERODROME DESIGN MANUAL PART 3
CHAPTER 1. Second Edition 1983.
CG USED FOR ACN CALCULATIONS: 35% MAC
See Section 7-4-1 MRW 139 500 kg.

46 x 16 - 20 TIRES
TIRE PRESSURE CONSTANT AT 13 BAR (189 PSI)

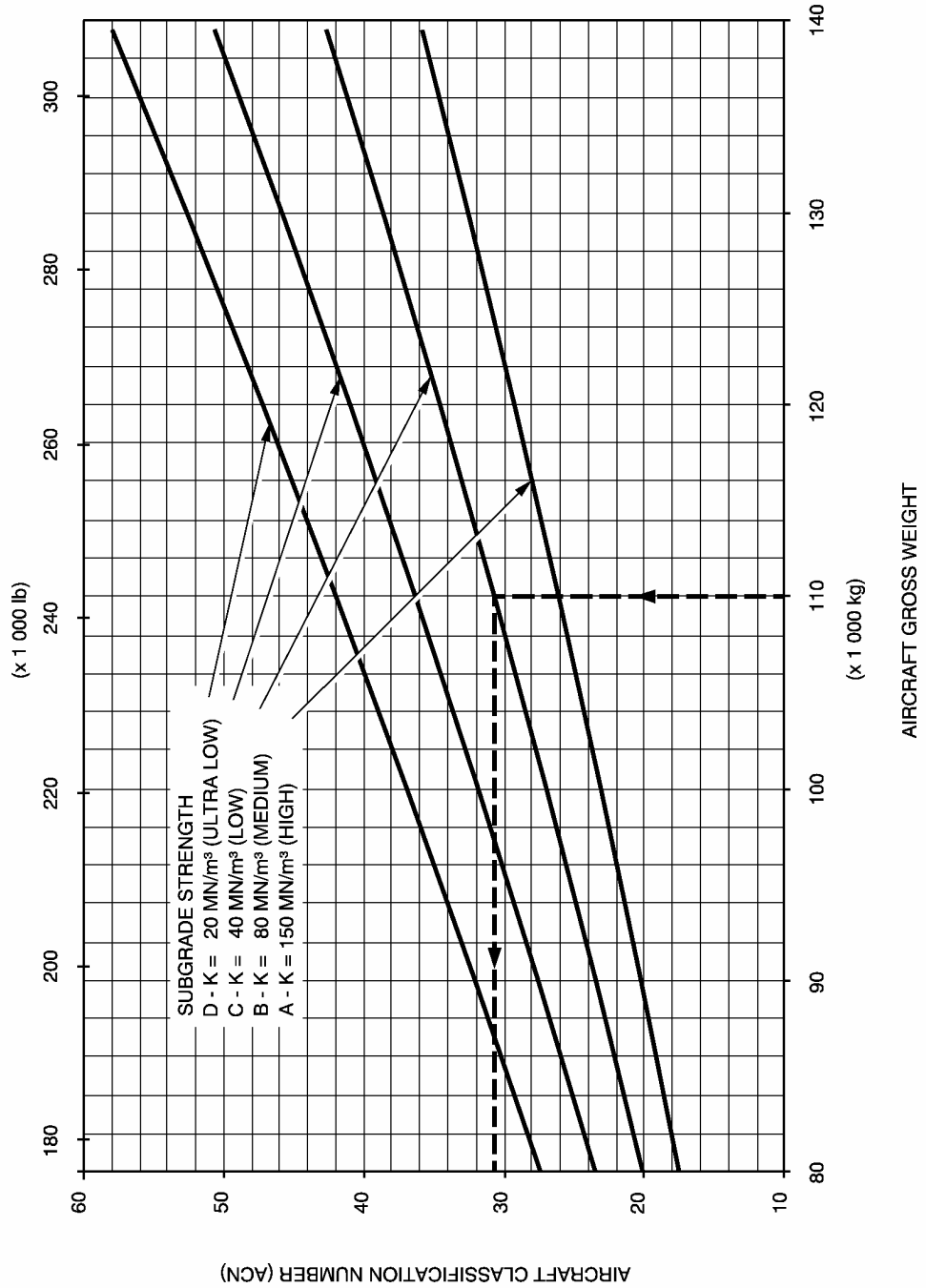

Aircraft Classification Number - Rigid Pavement
A310-200 Models - MRW 139 500 kg

AIRPLANE CHARACTERISTICS FOR AIRPORT PLANNING

BA5 07 09 02 1 AGM0 00

ACN WAS DETERMINED AS REFERENCED IN
ICAO AERODROME DESIGN MANUAL PART 3
CHAPTER 1. Second Edition 1983.
CG USED FOR ACN CALCULATIONS: 35% MAC
See Section 7-4-1 MRW 139 500 kg.

49 x 17 - 20 TIRES
TIRE PRESSURE CONSTANT AT 10.8 BAR (157 PSI)

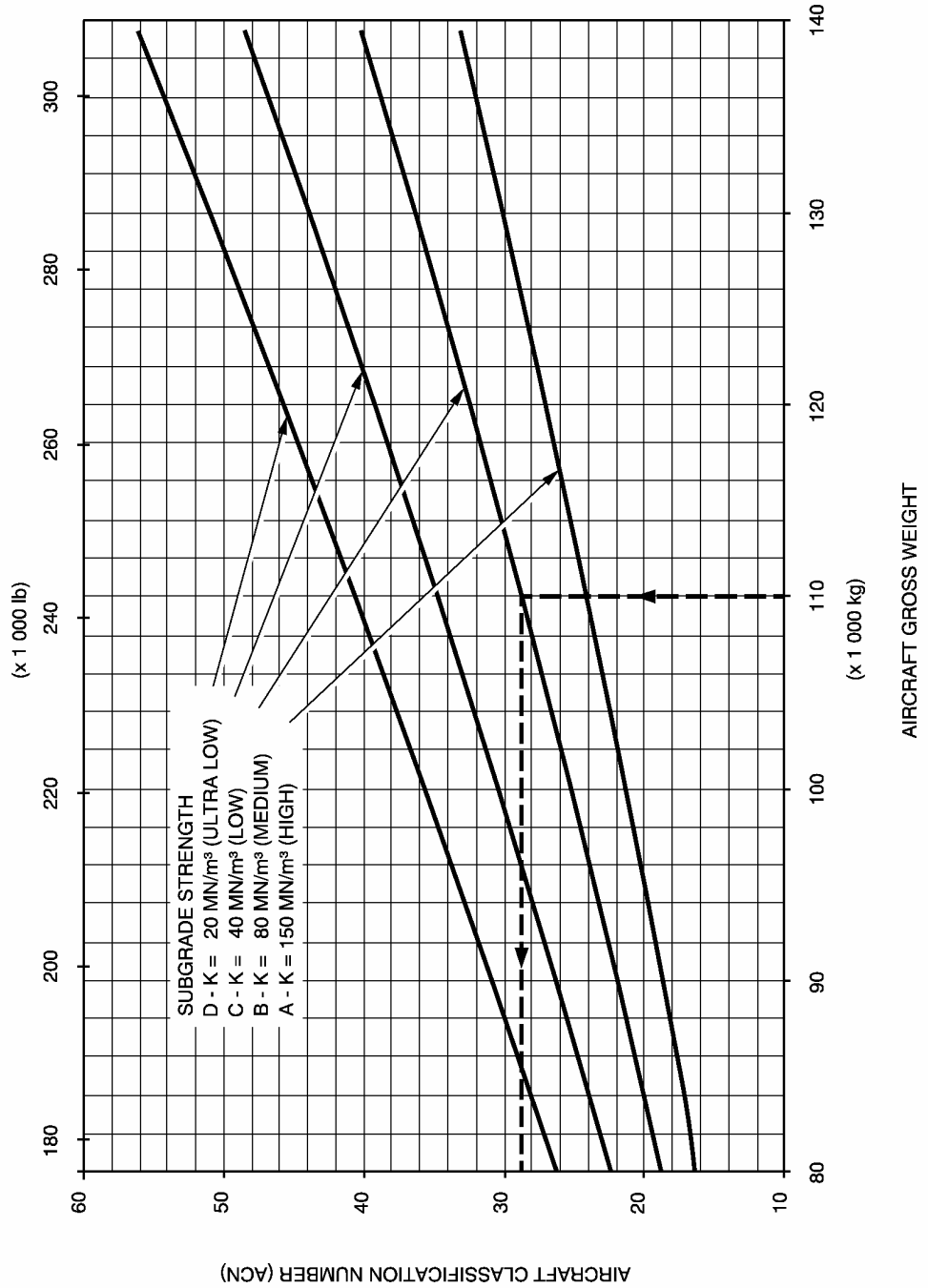

Aircraft Classification Number - Rigid Pavement
A310-200 Models - MRW 139 500 kg

AIRPLANE CHARACTERISTICS FOR AIRPORT PLANNING

BA5 07 09 02 1 AJM0 00

ACN WAS DETERMINED AS REFERENCED IN
ICAO AERODROME DESIGN MANUAL PART 3
CHAPTER 1. Second Edition 1983.
CG USED FOR ACN CALCULATIONS: 35% MAC
See Section 7-4-1 MRW 142 900 kg.

46 x 16 - 20 TIRES
TIRE PRESSURE CONSTANT AT 13.3 BAR (193 PSI)

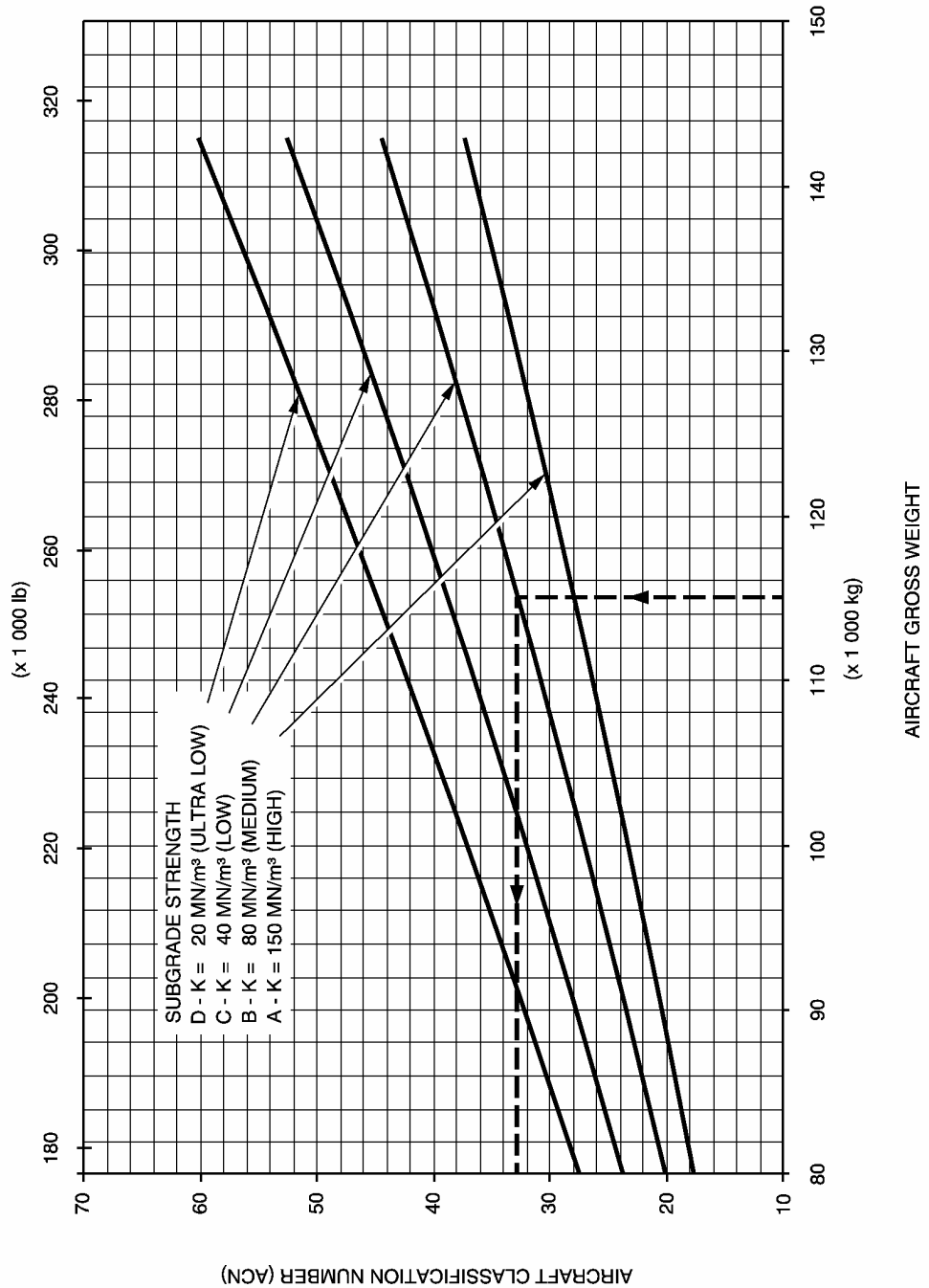

Aircraft Classification Number - Rigid Pavement
A310-200 Models - MRW 142 900 kg

AIRPLANE CHARACTERISTICS FOR AIRPORT PLANNING

BA5 07 09 02 1 ALM0 00

ACN WAS DETERMINED AS REFERENCED IN
ICAO AERODROME DESIGN MANUAL PART 3
CHAPTER 1. Second Edition 1983.
CG USED FOR ACN CALCULATIONS: 35% MAC
See Section 7-4-1 MRW 142 900 kg.

49 x 17 - 20 TIRES
TIRE PRESSURE CONSTANT AT 11 BAR (160 PSI)

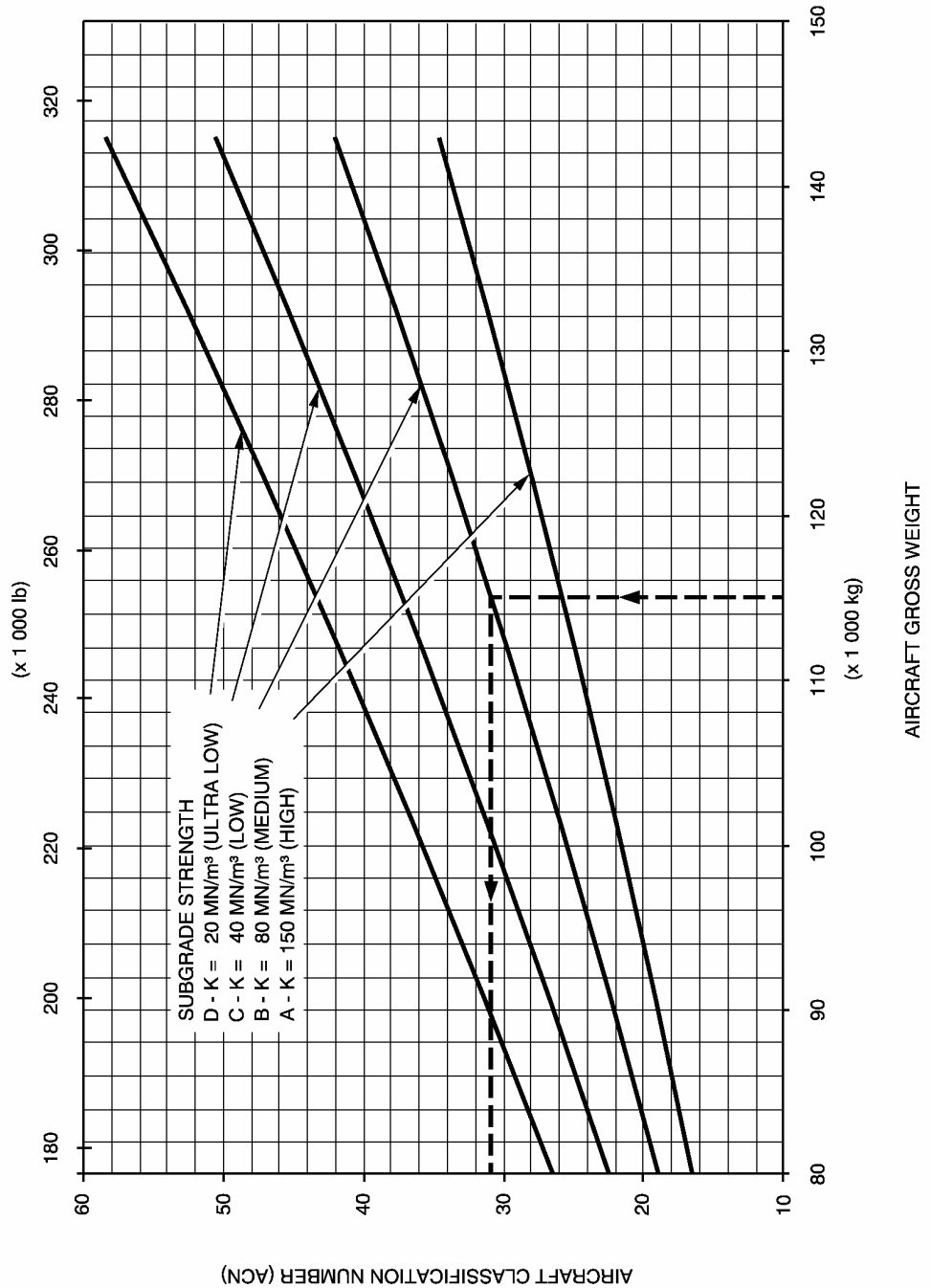

Aircraft Classification Number - Rigid Pavement
A310-200 Models - MRW 142 900 kg

AIRPLANE CHARACTERISTICS FOR AIRPORT PLANNING

BA5 07 09 02 1 ANM0 00

ACN WAS DETERMINED AS REFERENCED IN
ICAO AERODROME DESIGN MANUAL PART 3
CHAPTER 1. Second Edition 1983.
CG USED FOR ACN CALCULATIONS: 37.2% MAC
See Section 7-4-1 MRW 139 500 kg.

46 x 16 - 20 TIRES
TIRE PRESSURE CONSTANT AT 13.2 BAR (191 PSI)

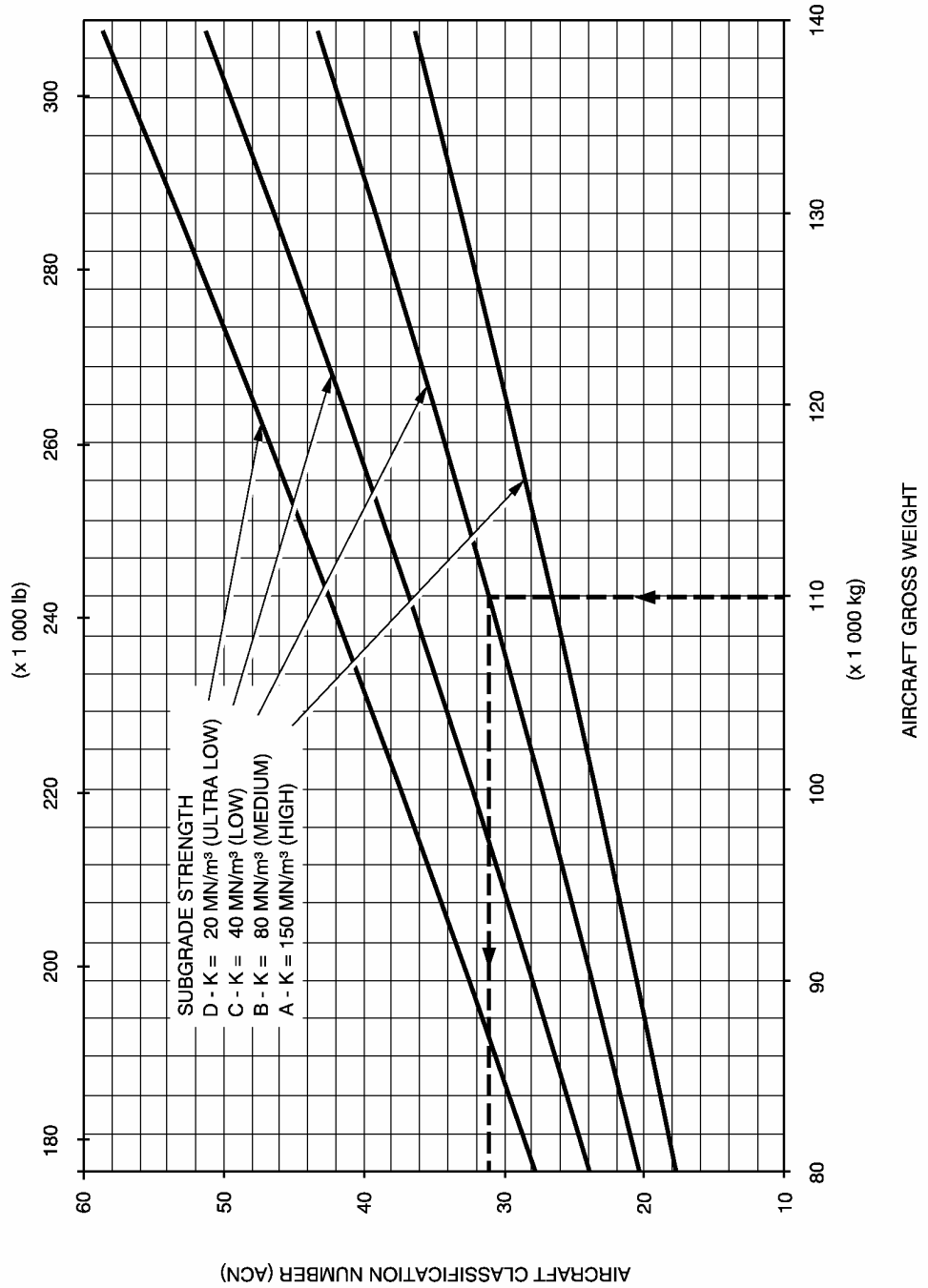

Aircraft Classification Number - Rigid Pavement
A310-300 Models - MRW 139 500 kg

AIRPLANE CHARACTERISTICS FOR AIRPORT PLANNING

BA5 07 09 02 1 AQM0 00

ACN WAS DETERMINED AS REFERENCED IN
ICAO AERODROME DESIGN MANUAL PART 3
CHAPTER 1. Second Edition 1983.
CG USED FOR ACN CALCULATIONS: 37.2% MAC
See Section 7-4-1 MRW 139 500 kg.

49 x 17 - 20 TIRES
TIRE PRESSURE CONSTANT AT 11 BAR (160 PSI)

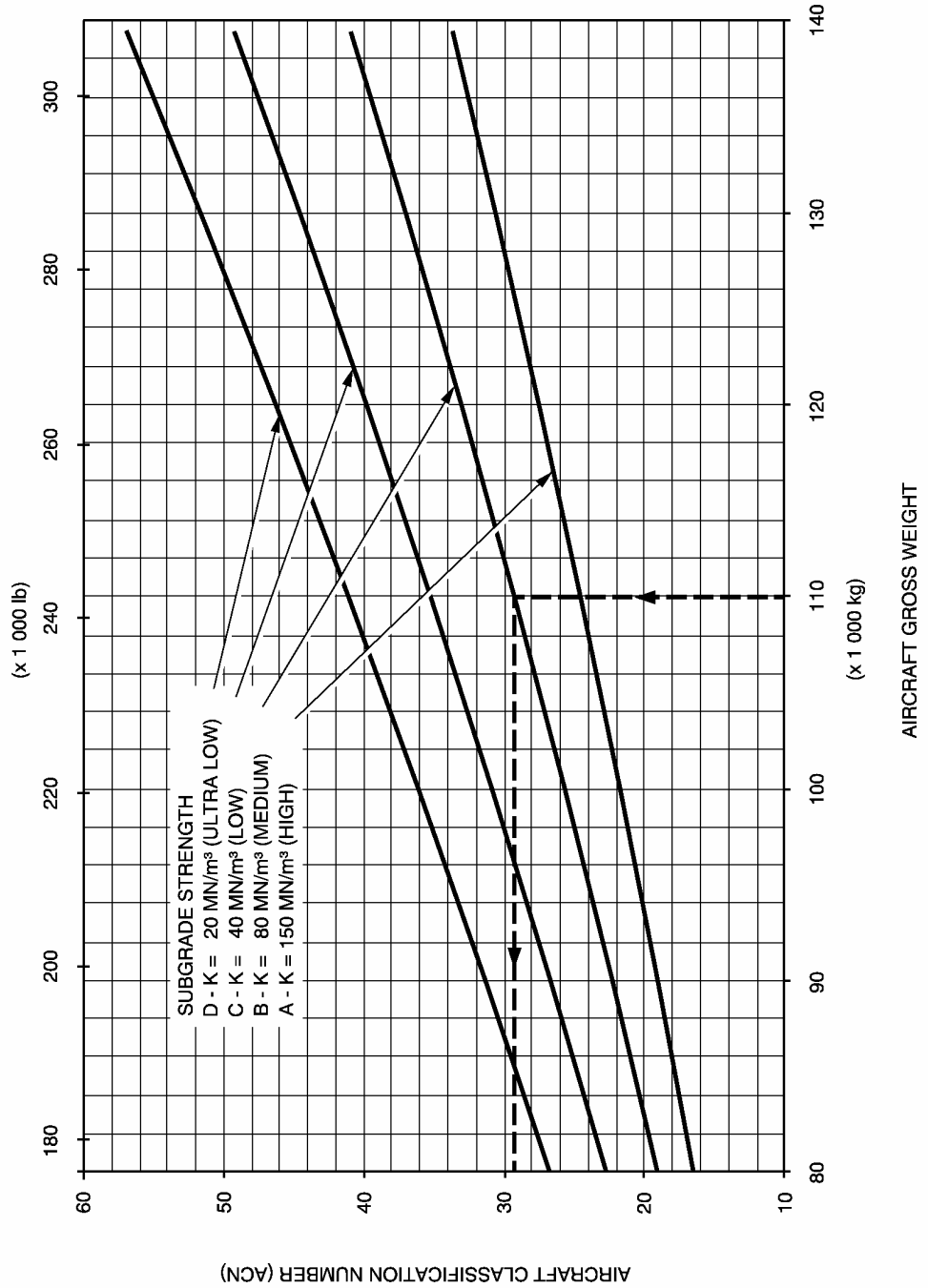

Aircraft Classification Number - Rigid Pavement
A310-300 Models - MRW 139 500 kg

AIRPLANE CHARACTERISTICS FOR AIRPORT PLANNING

BA5 07 09 02 1 ASM0 00

ACN WAS DETERMINED AS REFERENCED IN
ICAO AERODROME DESIGN MANUAL PART 3
CHAPTER 1. Second Edition 1983.
CG USED FOR ACN CALCULATIONS: 38% MAC
See Section 7-4-1 MRW 150 900 kg.

46 x 16 - 20 TIRES
TIRE PRESSURE CONSTANT AT 14.3 BAR (207 PSI)

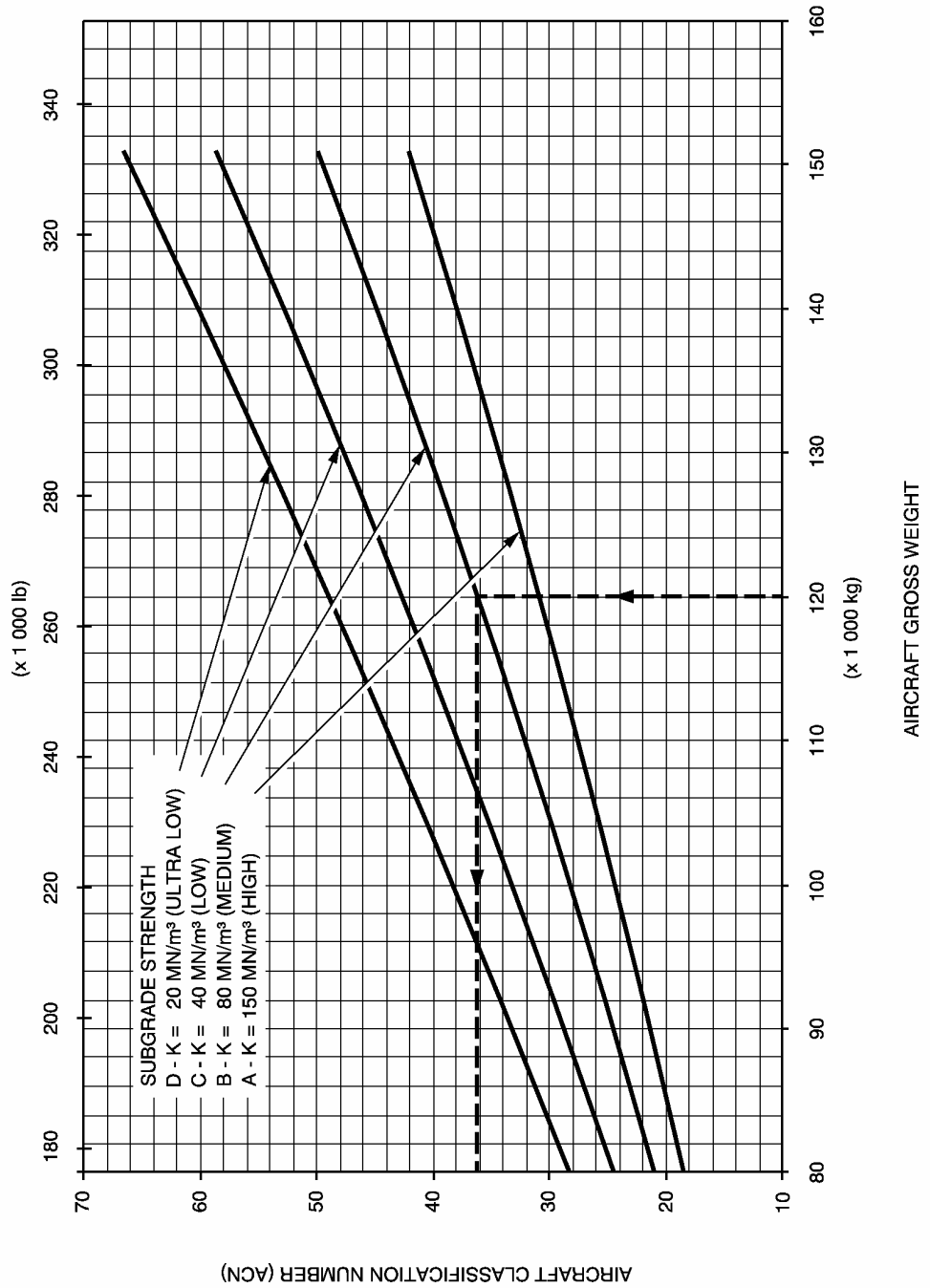

Aircraft Classification Number - Rigid Pavement
A310-300 Models - MRW 150 900 kg

AIRPLANE CHARACTERISTICS FOR AIRPORT PLANNING

BA5 07 09 02 1 AUM0 00

ACN WAS DETERMINED AS REFERENCED IN
ICAO AERODROME DESIGN MANUAL PART 3
CHAPTER 1. Second Edition 1983.
CG USED FOR ACN CALCULATIONS: 38% MAC
See Section 7-4-1 MRW 150 900 kg.

49 x 17 - 20 TIRES
TIRE PRESSURE CONSTANT AT 11.9 BAR (173 PSI)

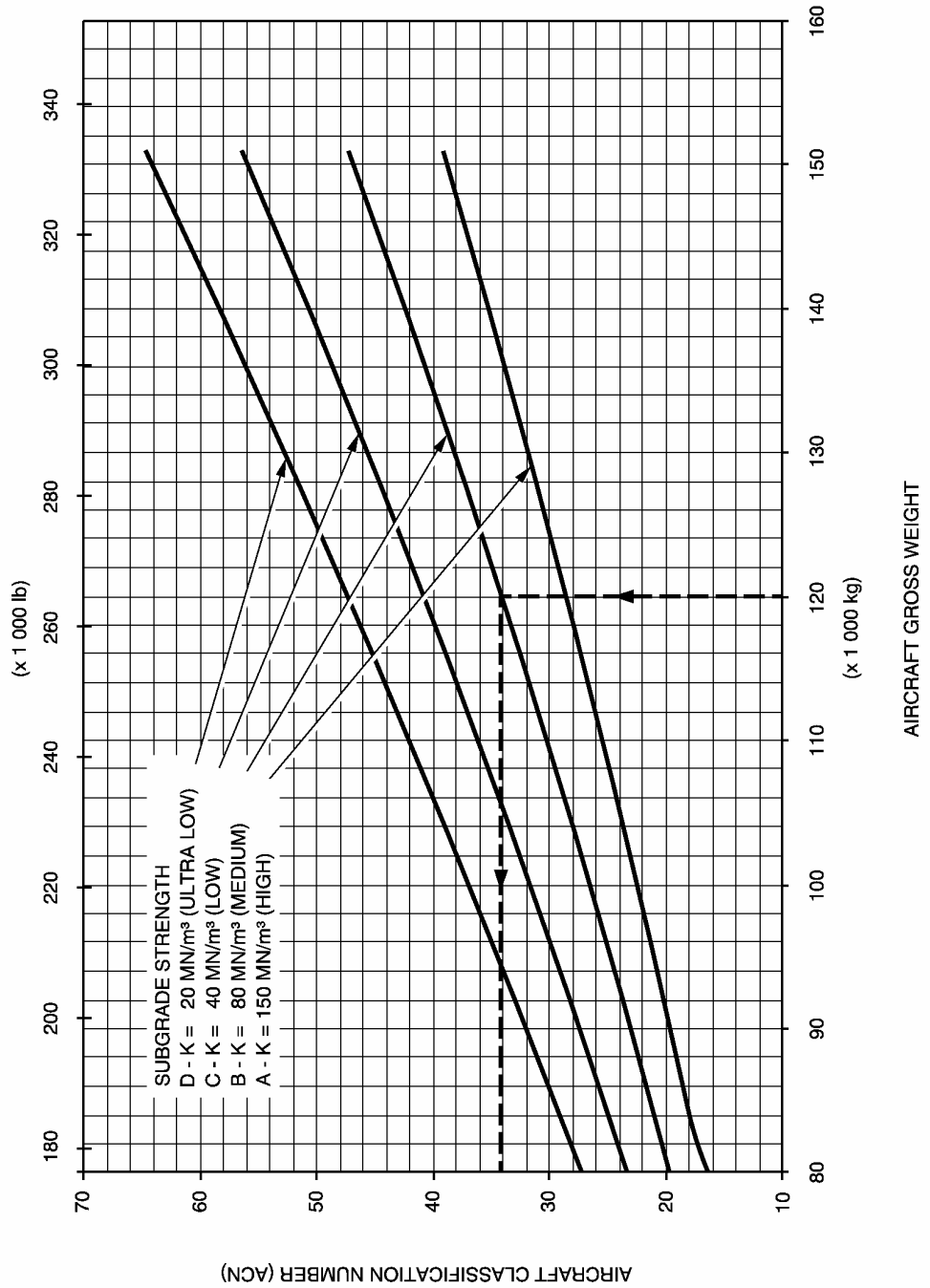

Aircraft Classification Number - Rigid Pavement
A310-300 Models - MRW 150 900 kg

AIRPLANE CHARACTERISTICS FOR AIRPORT PLANNING

BA5 07 09 02 1 AWM0 00

ACN WAS DETERMINED AS REFERENCED IN
ICAO AERODROME DESIGN MANUAL PART 3
CHAPTER 1. Second Edition 1983.
CG USED FOR ACN CALCULATIONS: 38% MAC
See Section 7-4-1 MRW 153 900 kg.

46 x 16 - 20 TIRES
TIRE PRESSURE CONSTANT AT 14.6 BAR (212 PSI)

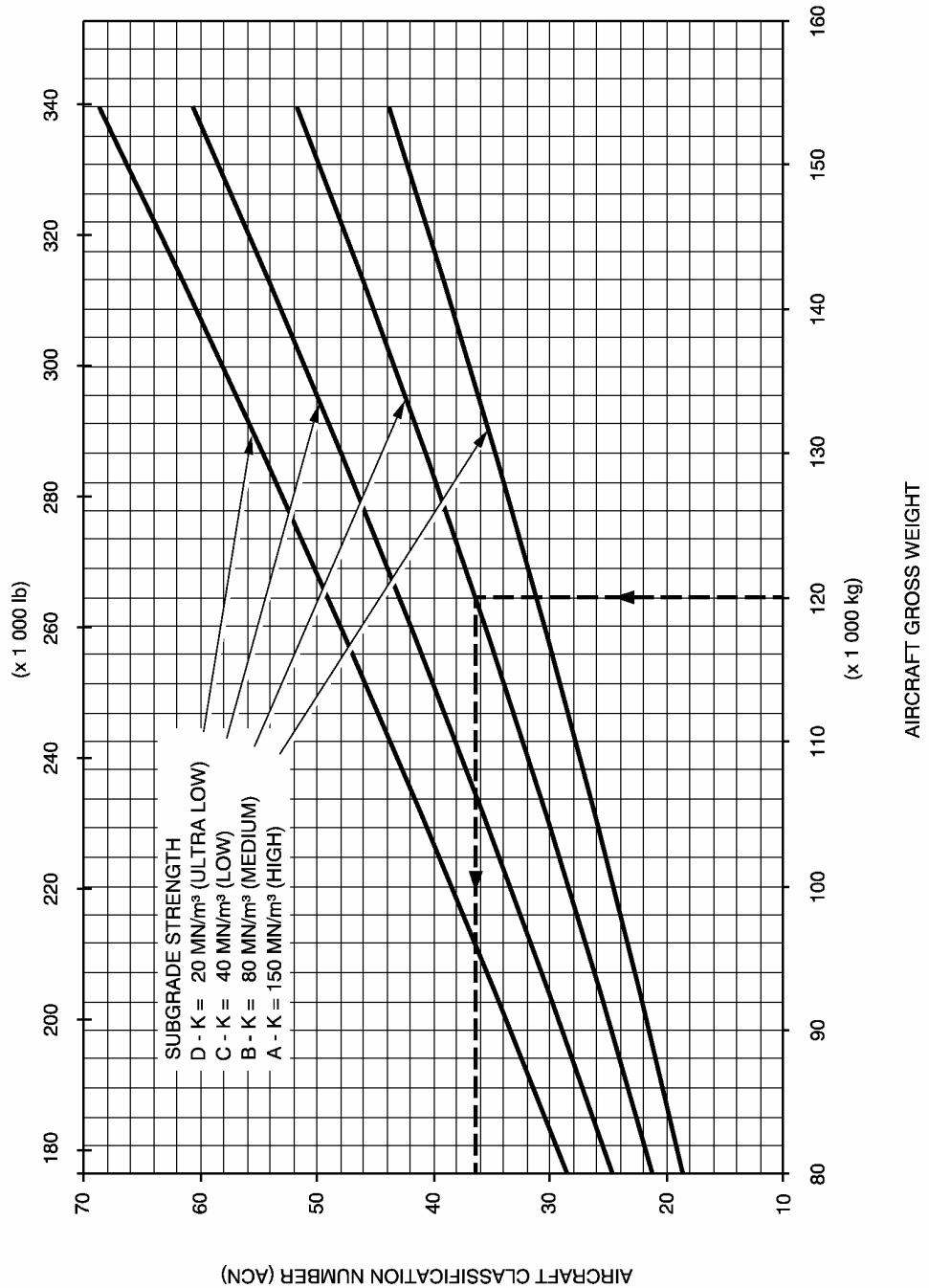

Aircraft Classification Number - Rigid Pavement
A310-300 Models - MRW 153 900 kg

AIRPLANE CHARACTERISTICS FOR AIRPORT PLANNING

BA5 07 09 02 1 AYM0 00

ACN WAS DETERMINED AS REFERENCED IN
ICAO AERODROME DESIGN MANUAL PART 3
CHAPTER 1. Second Edition 1983.
CG USED FOR ACN CALCULATIONS: 38% MAC
See Section 7-4-1 MRW 153 900 kg.

49 x 17 - 20 TIRES
TIRE PRESSURE CONSTANT AT 12 BAR (174 PSI)

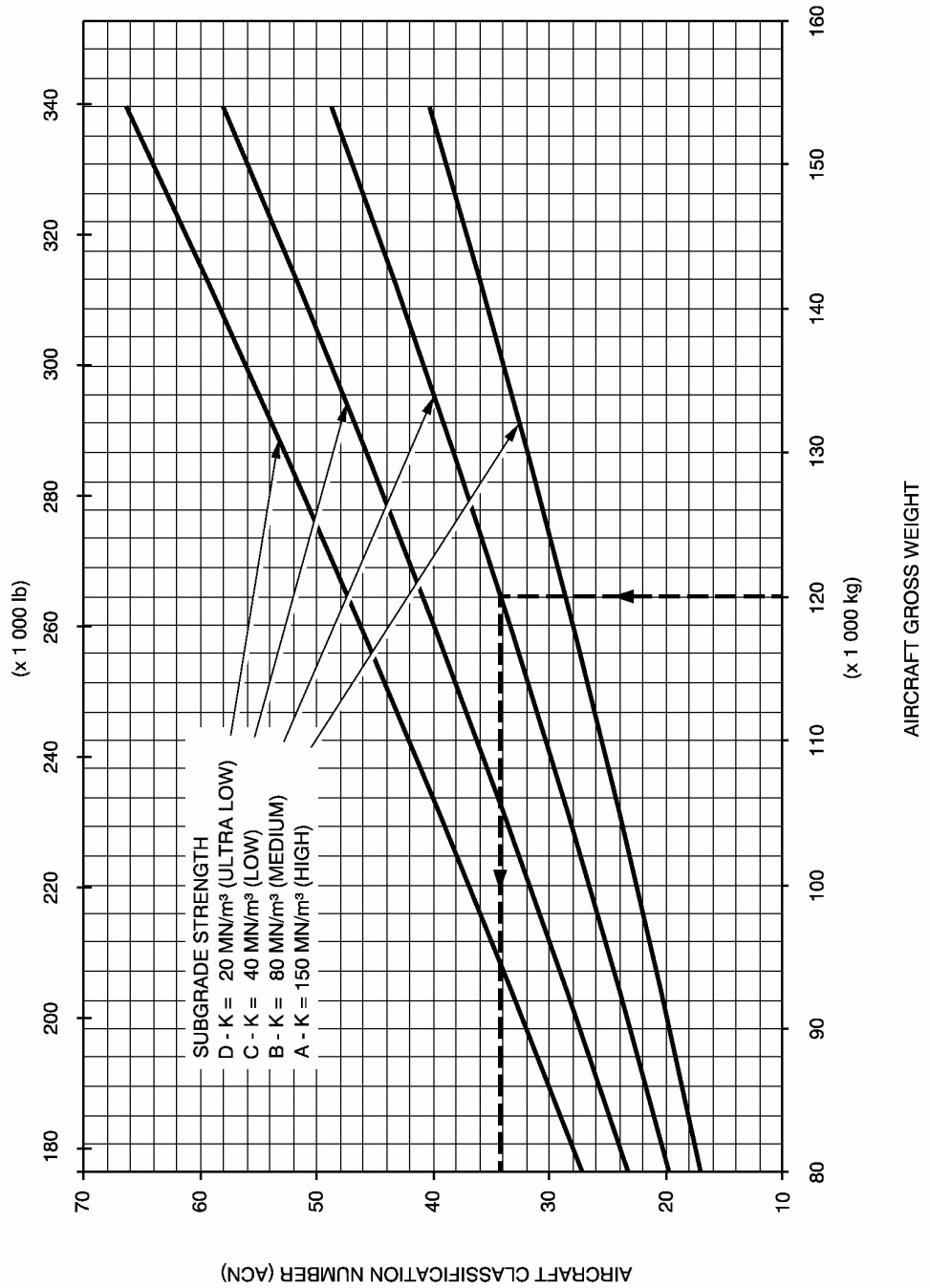

Aircraft Classification Number - Rigid Pavement
A310-300 Models - MRW 153 900 kg

AIRPLANE CHARACTERISTICS FOR AIRPORT PLANNING

BA5 07 09 02 1 BAM0 00

ACN WAS DETERMINED AS REFERENCED IN
ICAO AERODROME DESIGN MANUAL PART 3
CHAPTER 1. Second Edition 1983.
CG USED FOR ACN CALCULATIONS: 38% MAC
See Section 7-4-1 MRW 157 900 kg.

46 x 16 - 20 TIRES
TIRE PRESSURE CONSTANT AT 14.8 BAR (215 PSI)

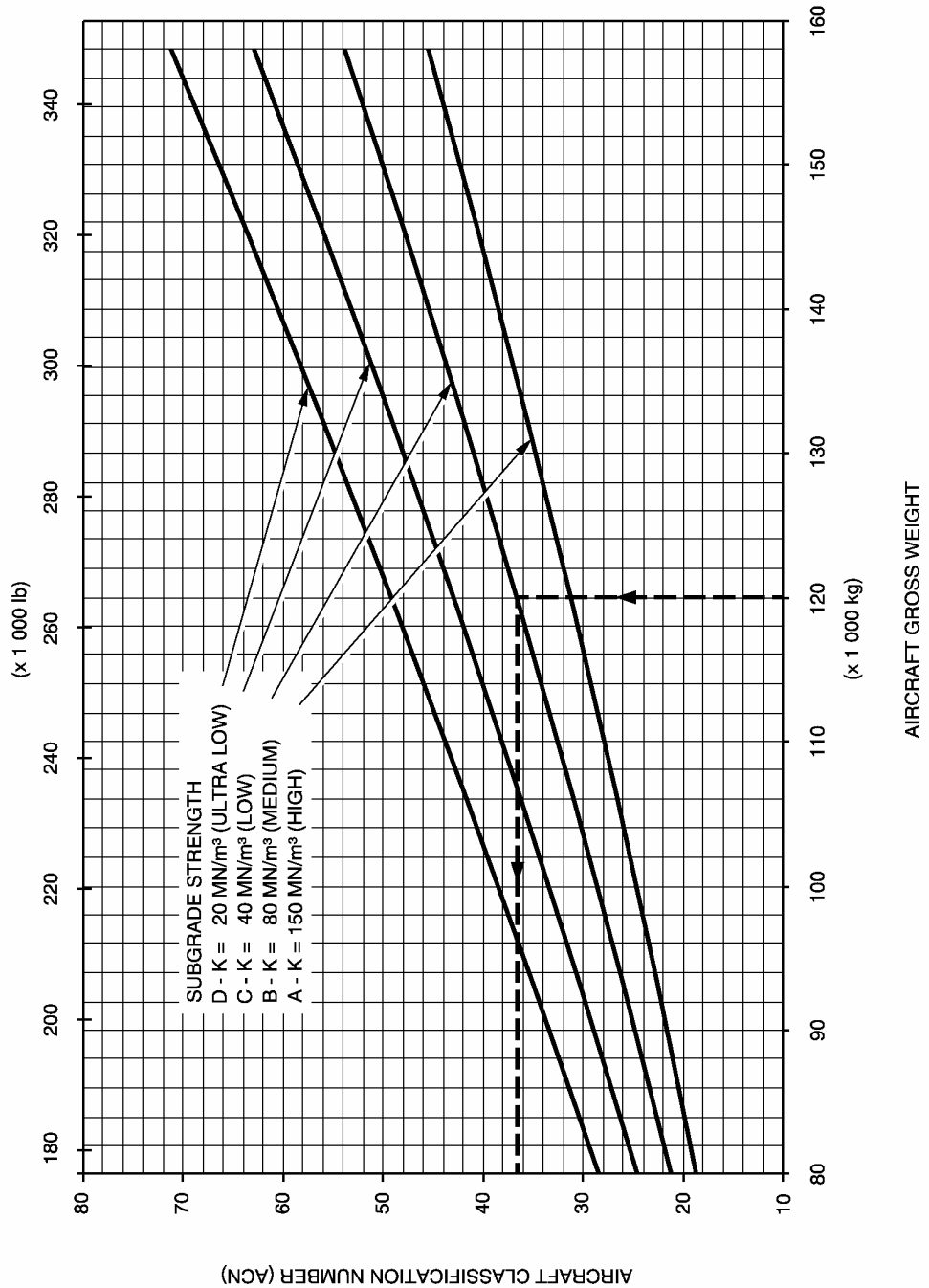

Aircraft Classification Number - Rigid Pavement
A310-300 Models - MRW 157 900 kg

AIRPLANE CHARACTERISTICS FOR AIRPORT PLANNING

BA5 07 09 02 1 BCM0 00

ACN WAS DETERMINED AS REFERENCED IN
ICAO AERODROME DESIGN MANUAL PART 3
CHAPTER 1. Second Edition 1983.
CG USED FOR ACN CALCULATIONS: 38% MAC
See Section 7-4-1 MRW 157 900 kg.

49 x 17 - 20 TIRES
TIRE PRESSURE CONSTANT AT 12.4 BAR (180 PSI)

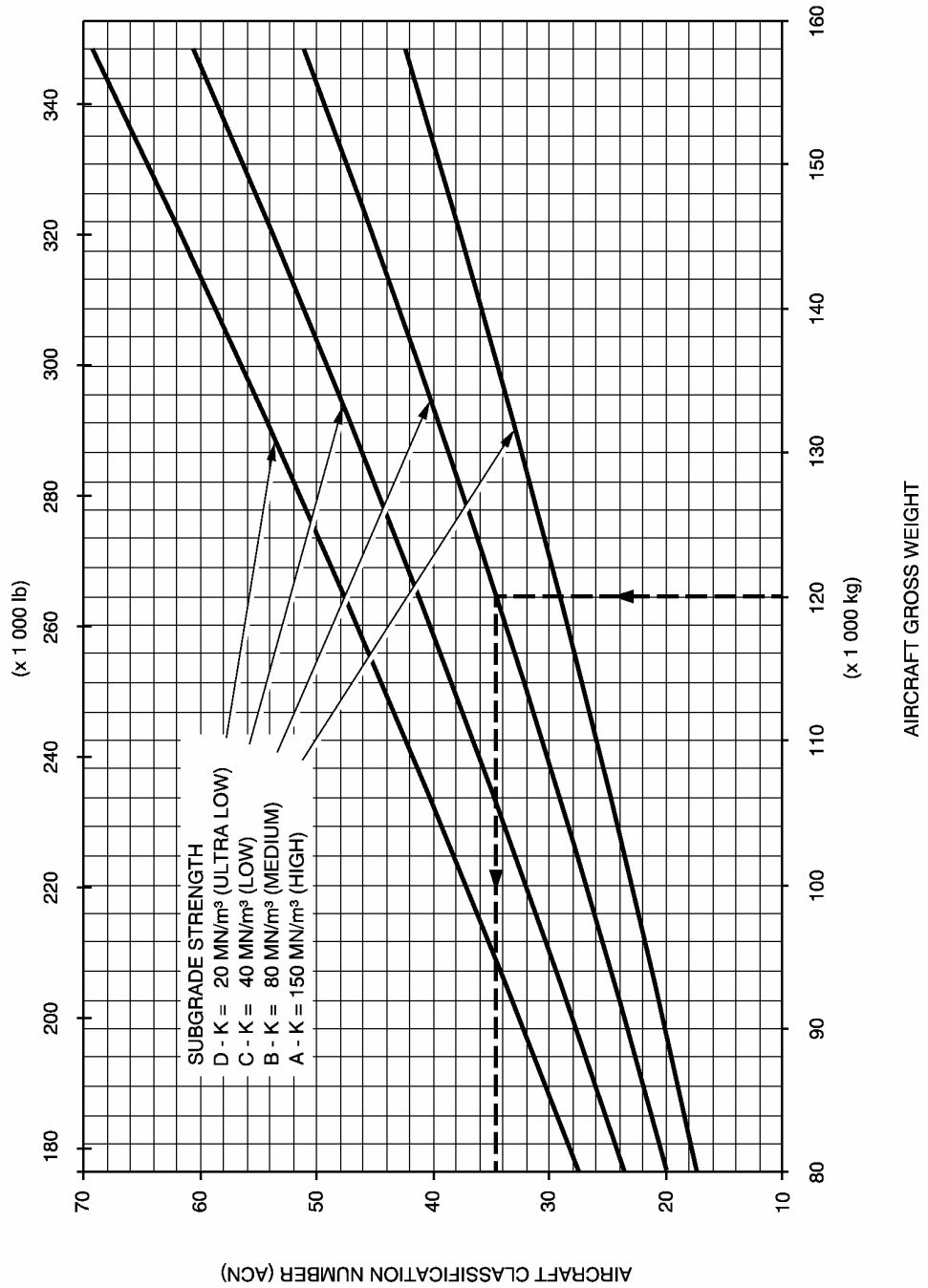

Aircraft Classification Number - Rigid Pavement
A310-300 Models - MRW 157 900 kg

AIRPLANE CHARACTERISTICS FOR AIRPORT PLANNING

BA5 07 09 02 1 BEM0 00

ACN WAS DETERMINED AS REFERENCED IN
ICAO AERODROME DESIGN MANUAL PART 3
CHAPTER 1. Second Edition 1983.
CG USED FOR ACN CALCULATIONS: 38% MAC
See Section 7-4-1 MRW 160 900 kg.

49 x 17 - 20 TIRES
TIRE PRESSURE CONSTANT AT 12.6 BAR (183 PSI)

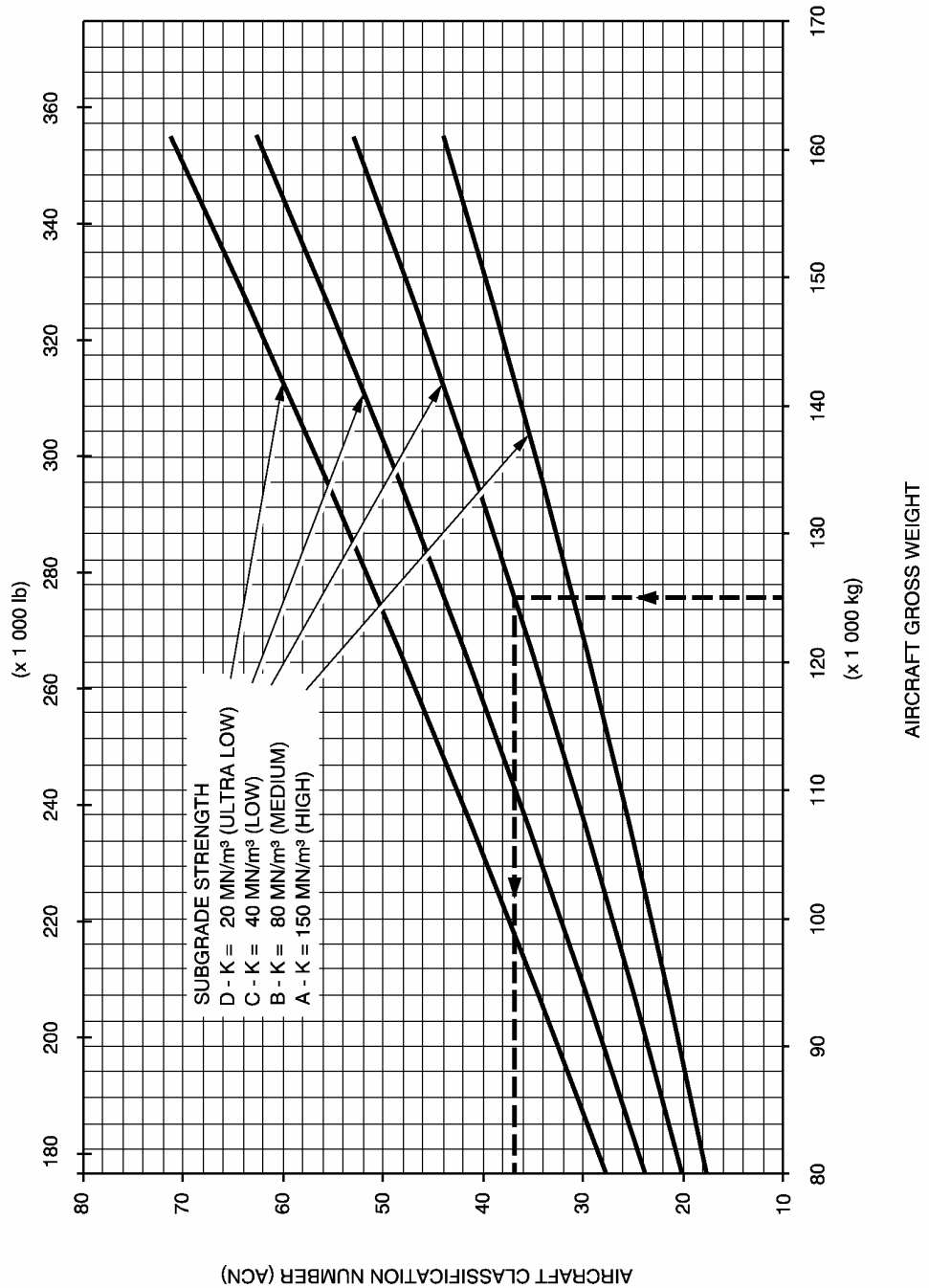

Aircraft Classification Number - Rigid Pavement
A310-300 Models - MRW 160 900 kg

AIRPLANE CHARACTERISTICS FOR AIRPORT PLANNING

BA5 07 09 02 1 BGM0 00

ACN WAS DETERMINED AS REFERENCED IN
ICAO AERODROME DESIGN MANUAL PART 3
CHAPTER 1. Second Edition 1983.

CG USED FOR ACN CALCULATIONS: 38% MAC
See Section 7-4-1 MRW 164 900 kg.

49 x 17 - 20 TIRES
TIRE PRESSURE CONSTANT AT 12.9 BAR (187 PSI)

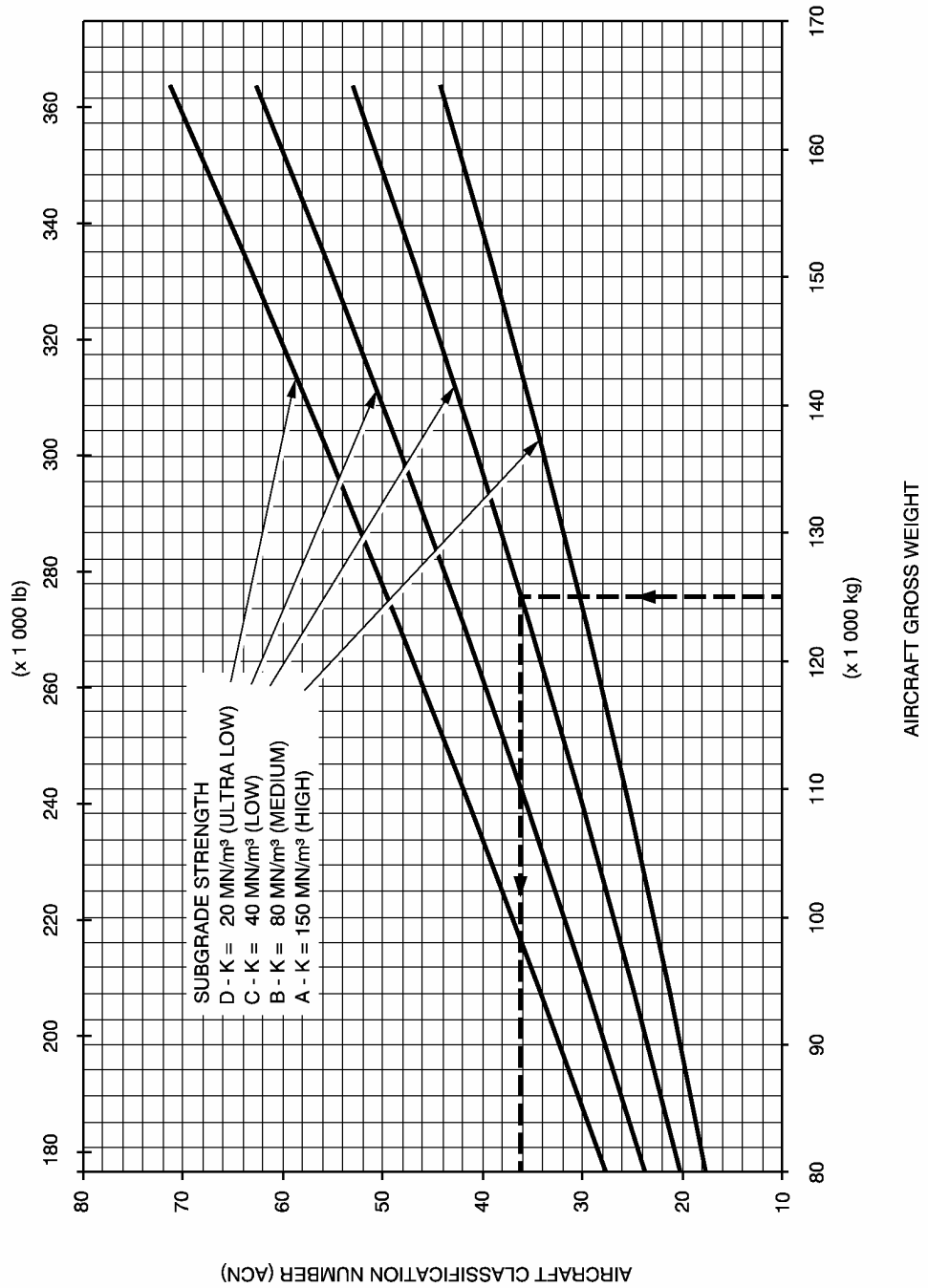

Aircraft Classification Number - Rigid Pavement
A310-300 Models - MRW 164 900 kg

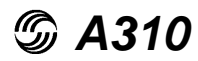

AIRPLANE CHARACTERISTICS FOR AIRPORT PLANNING

R 8.0 DERIVATIVE AIRPLANES

R 8.1.0 Possible Future A310 Derivative Airplane

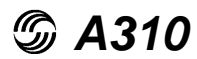

AIRPLANE CHARACTERISTICS FOR AIRPORT PLANNING

8.1.0 Possible Future A310 Derivative Airplane

R No derivative versions of the "A310" are currently planned.

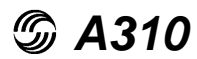

AIRPLANE CHARACTERISTICS FOR AIRPORT PLANNING

R 9.0 SCALED DRAWINGS

R 9.1.1 A310 Scaled Drawing 1 in. = 500 ft.

R 9.2.1 A310 Scaled Drawing 1 cm. = 500 cm.

AIRPLANE CHARACTERISTICS FOR AIRPORT PLANNING

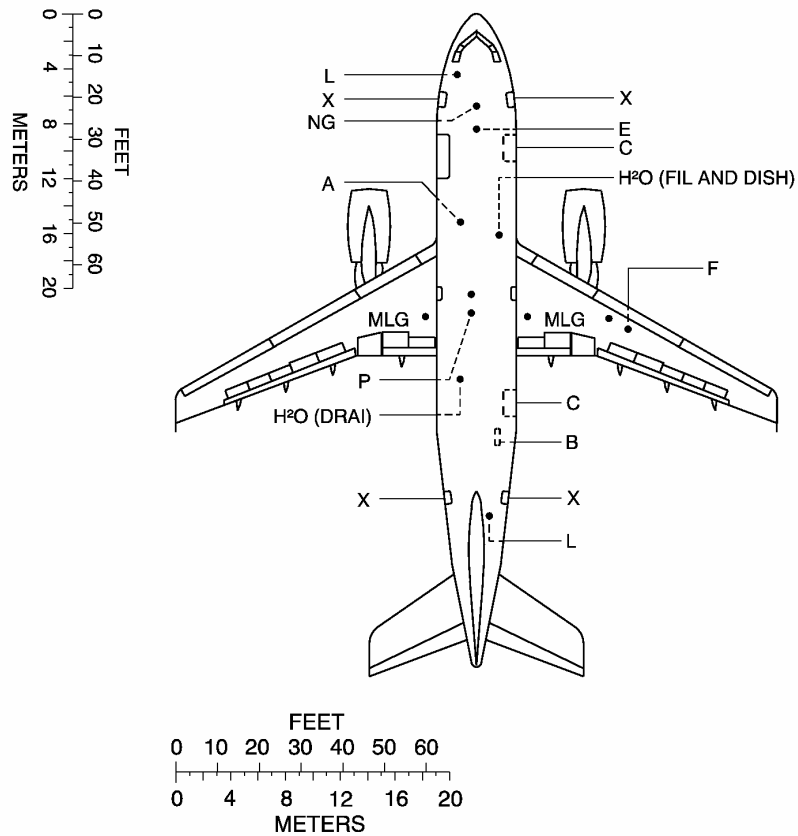

LEGEND :

- A AIR CONDITIONING
- B BULK CARGO COMPT DOOR
- C CARGO COMPT (CONTAINER) DOOR
- E ELECTRICAL
- F FUEL (2 CONNECTIONS)
- H² O (FIL) POTABLE WATER - FILLING AND DISCHARGING
- H² O (DRAI) POTABLE WATER - DRAINING
- L LAVATORY
- MLG MAIN LANDING GEAR
- NG NOSE GEAR
- P PNEUMATIC (2 CONNECTIONS)
- X PASSENGER/CREW DOOR

NOTE : WHEN PRINTING THIS DRAWING, SURE TO ADJUST FOR PROPER SCALING

9.1 Scaled Drawing - 1 in. = 500 ft.

BA5 09 01 01 5 AAM0 00

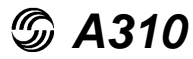

AIRPLANE CHARACTERISTICS FOR AIRPORT PLANNING

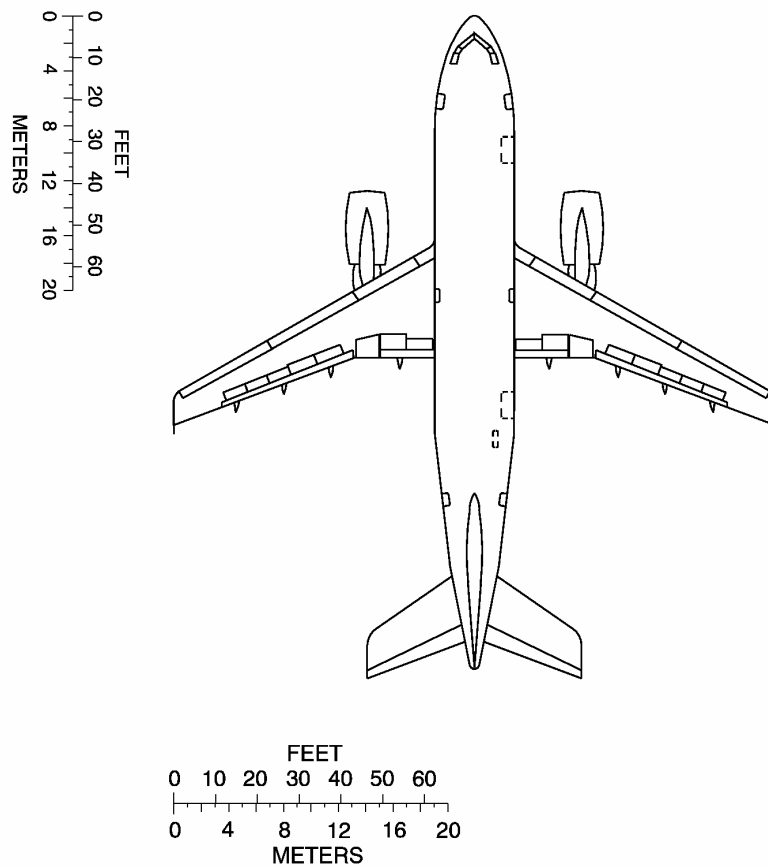

BA5 09 01 01 5 ABM0 00

NOTE : WHEN PRINTING THIS DRAWING, SURE TO ADJUST FOR PROPER SCALING

9.1 Scaled Drawing - 1 in. = 500 ft.

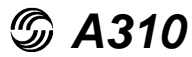

AIRPLANE CHARACTERISTICS FOR AIRPORT PLANNING

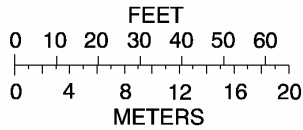
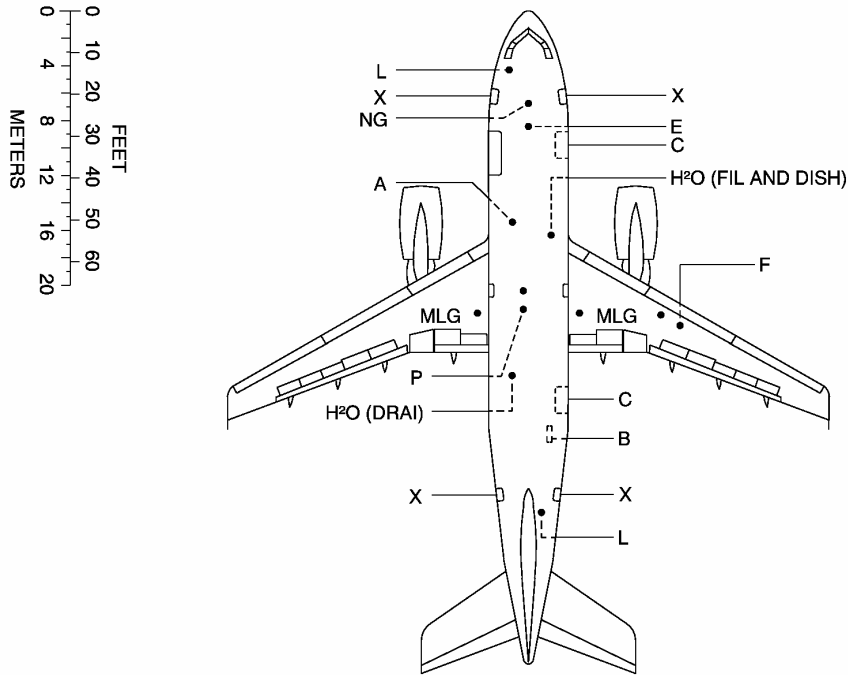

LEGEND :

- A AIR CONDITIONING
- B BULK CARGO COMPT DOOR
- C CARGO COMPT (CONTAINER) DOOR
- E ELECTRICAL
- F FUEL (2 CONNECTIONS)
- H² O (FIL) POTABLE WATER - FILLING AND DISCHARGING
- H² O (DRAI) POTABLE WATER - DRAINING
- L LAVATORY
- MLG MAIN LANDING GEAR
- NG NOSE GEAR
- P PNEUMATIC (2 CONNECTIONS)
- X PASSENGER/CREW DOOR

NOTE : WHEN PRINTING THIS DRAWING, SURE TO ADJUST FOR PROPER SCALING

9.2 Scaled Drawing - 1 cm. = 500 cm.

BA5 09 02 01 5 AAM0 00



AIRPLANE CHARACTERISTICS FOR AIRPORT PLANNING

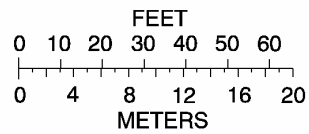
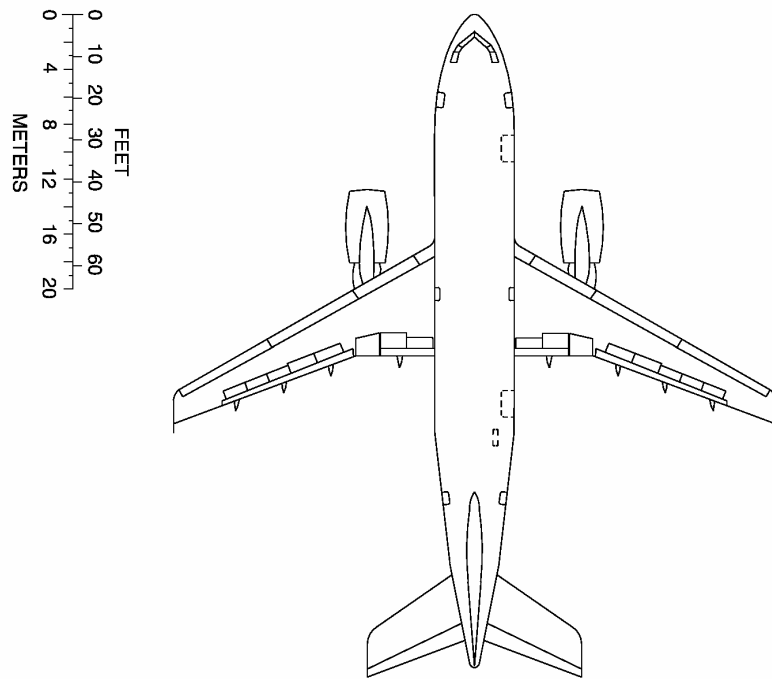

BA5 09 02 01 5 AEM0 00

NOTE : WHEN PRINTING THIS DRAWING, SURE TO ADJUST FOR PROPER SCALING

9.2 Scaled Drawing - 1 cm. = 500 cm.