

THE NATIONAL ARCHIVES of the UNITED STATES COLORING BOOK of PATENTS 2016

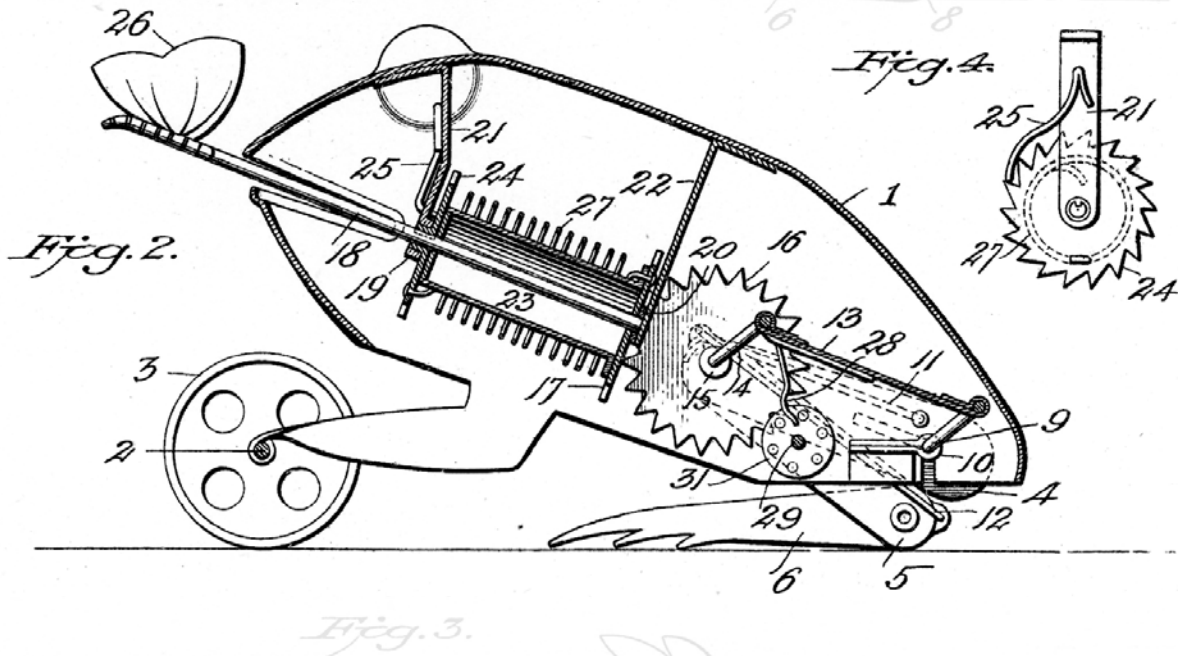

We've chosen some of our favorite patents from our holdings for you to color.

We'd love to see how you color them in—share them with us on Twitter by using the hashtag #ColorOurCollections and tagging @usnatarchives.

These patents came from the Records of the Patent and Trademark Office (Record Group 241). And you can find even more of our fascinating patents online by searching our digital catalog <https://catalog.archives.gov/>.



Illustrations by: *S. Pargent Elliott*

By

Illustrator: *Charles A. Lewis*

J. A. EARL.
CANDLE HOLDER AND DISH FOR BIRTHDAY CAKES.

(Application filed Dec. 17, 1900.)

(No Model.)

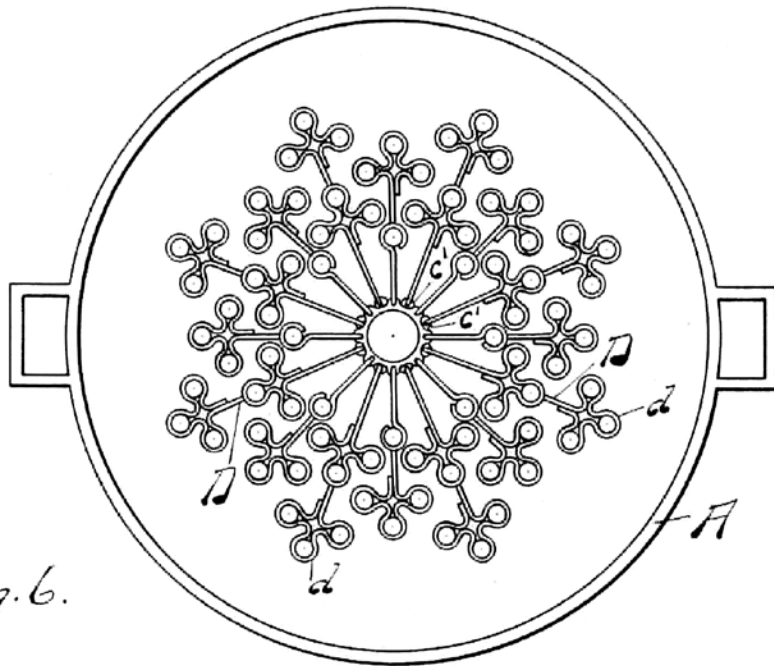

Fig. 2.

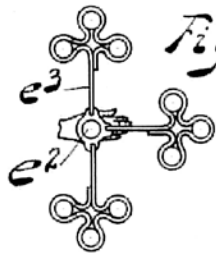

Fig. 6.



Fig. 1.

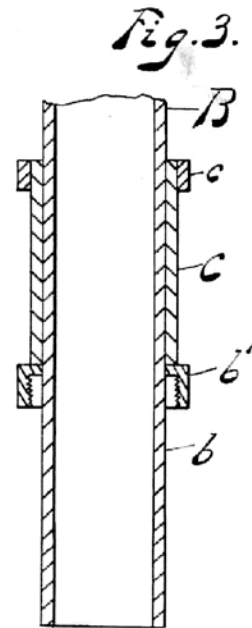

Fig. 3.

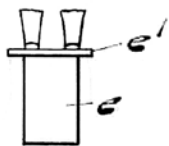

Fig. 7.

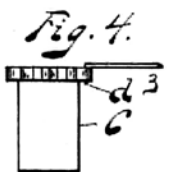

Fig. 4.

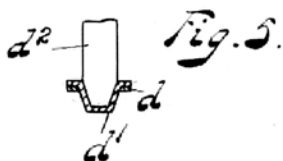
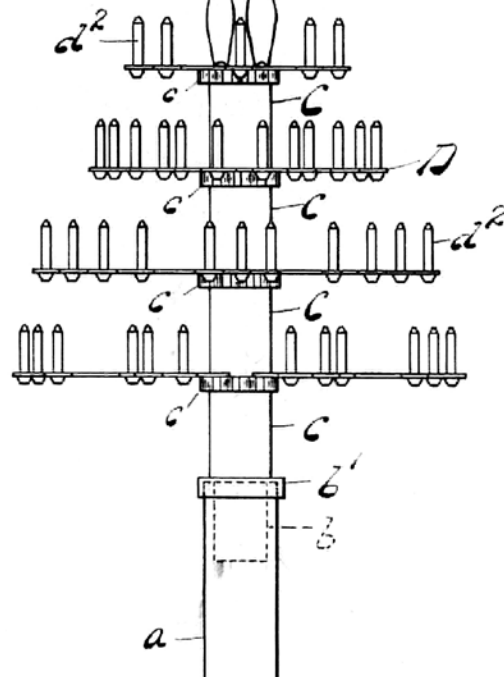

Fig. 5.



Filed Dec 17 1900 No Model 457
 Candle Holder & Dish for Birthday Cakes

64
7

Dis.

Dis. v. 11

3,093,372

100755 DIV. 62

PRINT OF DRAWING AS
ORIGINALLY FILED

2

FIG. 1

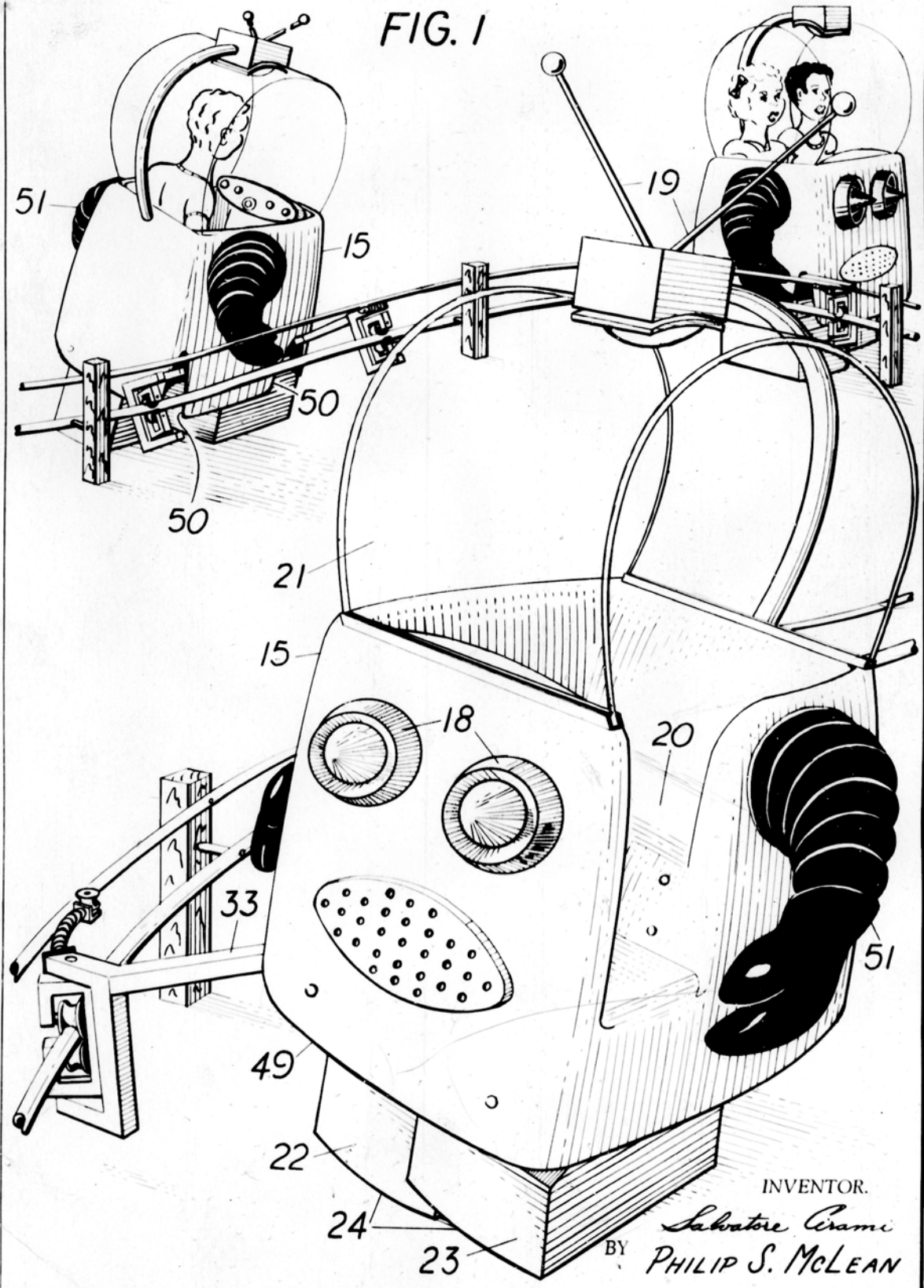

INVENTOR.

Sabatore Cerami

BY *PHILIP S. McLEAN*

Toy Circus.

No. 239,340.

Patented March 29, 1881.

Fig. 1.

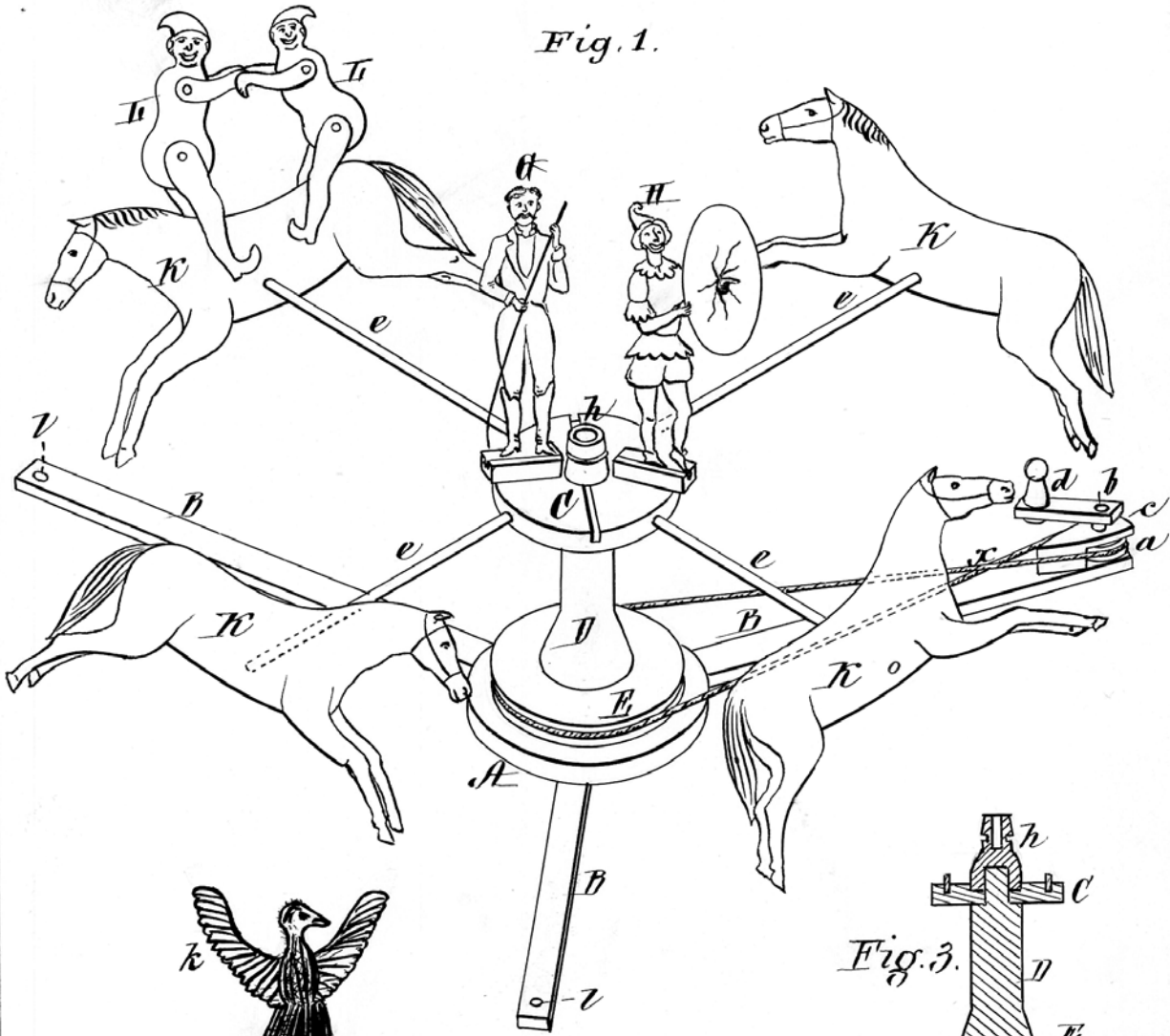

Fig. 2.

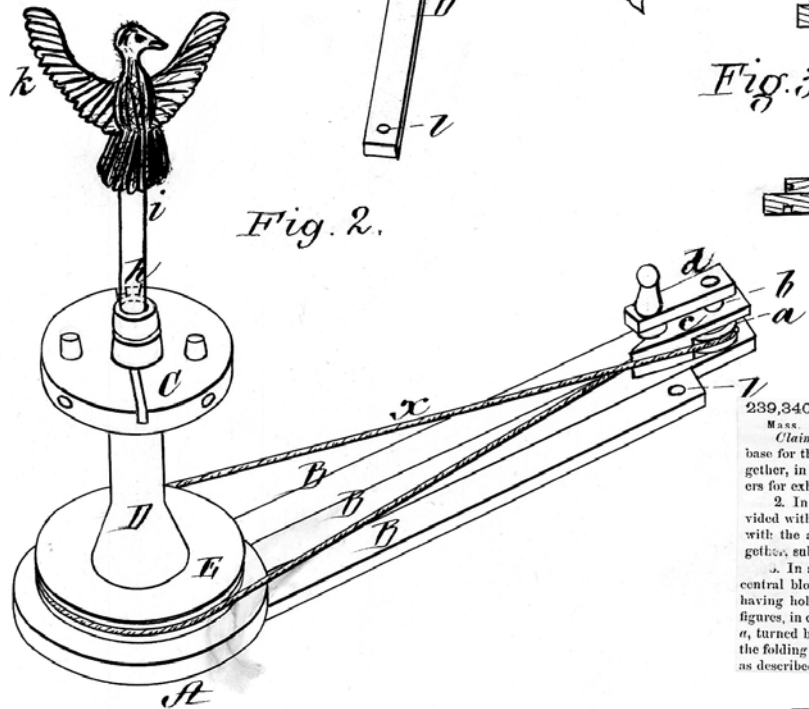
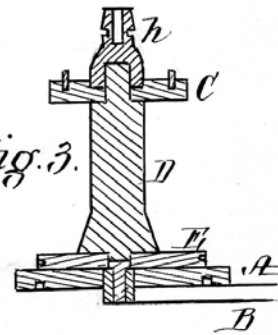

Fig. 3.



239,340. TOY CIRCUS. WILLIAM S. REED, Leominster, Mass. Filed Mar. 1, 1881. (No model.)
 Claim.—1. In a toy circus, two or more arms, B, forming a base for the block A, said arms being adapted to fold or close together, in combination with a central post, D, and suitable holders for exhibiting the figures, substantially as described.
 2. In a toy circus, a revolving post, D, and platform C, provided with means for holding the figures in place, in combination with the arms B, forming a base and adapted to fold or close together, substantially as described.
 3. In a toy circus, the wheel E, pivoted within the stationary central block, A, and provided with a post, D, and platform C, having holes or sockets for the reception of rods supporting the figures, in combination, and connected by a belt, x, with the pulley a, turned by a crank, d, at the outer end of one of the arms B of the folding base, constructed and arranged to operate substantially as described.

Witnesses:

Grace C. Stearns.
 Jas^s Compton

Inventor:

William S. Reed,
 Per Norman W. Stearns,

No Model
 340

No Model.

No Model

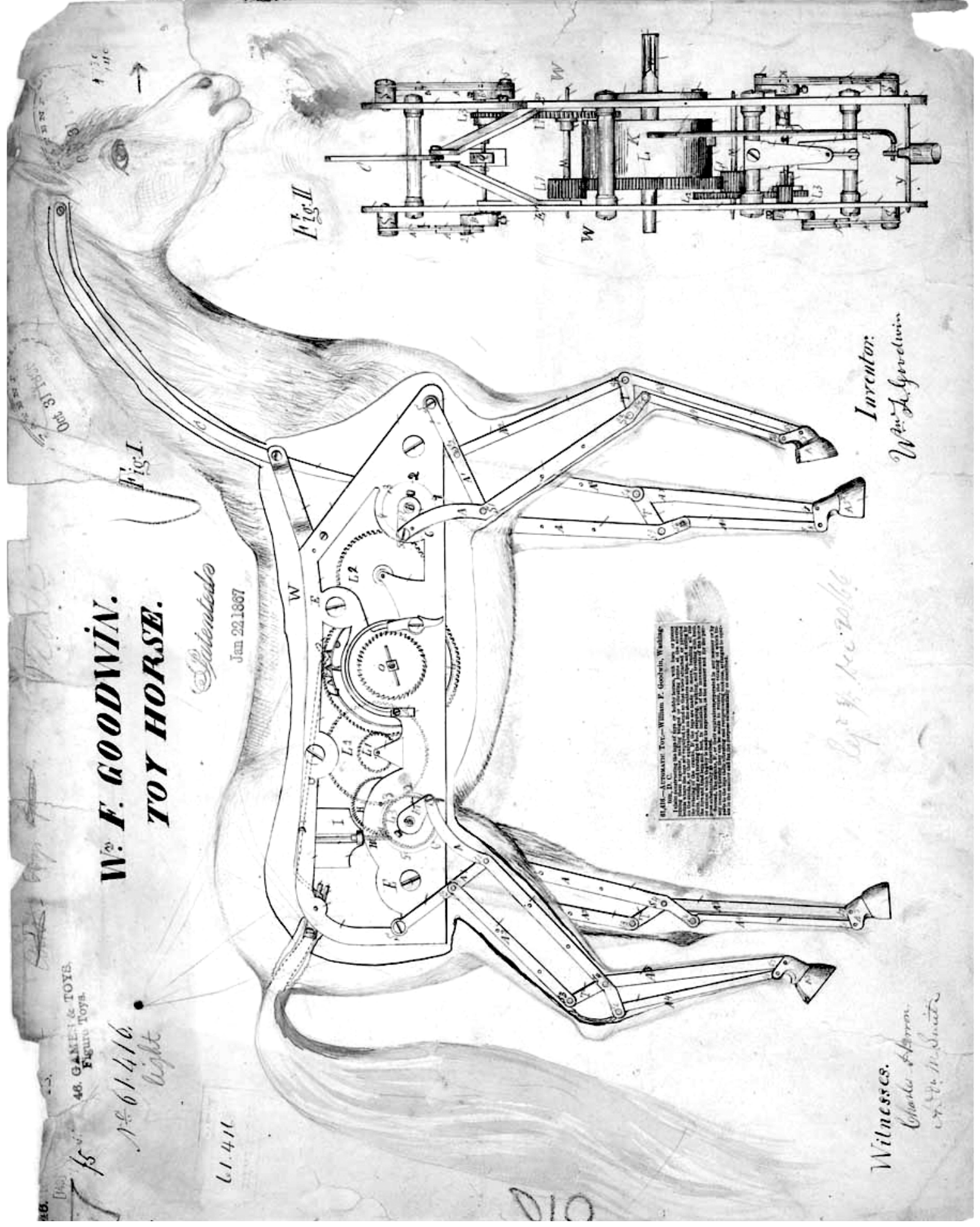

**W. F. GOODWIN.
TOY HORSE.**

Patented
Jan 22 1867

Inventor:
Wm. F. Goodwin

Witnesses:
Charles H. Brown
Wm. M. Smith

BE ALL—ATTORNEY: Toy.—William F. Goodwin, Wash-
ington, D. C.
This is to certify that the above is a true and correct copy of the specification of a toy horse, as filed in the office of the Commissioner of Patents, at Washington, D. C., on the 15th day of January, 1867, and that the same is hereby published in accordance with the provisions of the Act of Congress, approved March 3, 1879, relating to the publication of specifications of patents.

46. GAMES & TOYS,
Figuro Toys.

1861416
right

11411

Fig. II

Fig. I

ONE WHEELED VEHICLE.

No. 325,548.

Patented Sept. 1, 1885.

Fig. 1.

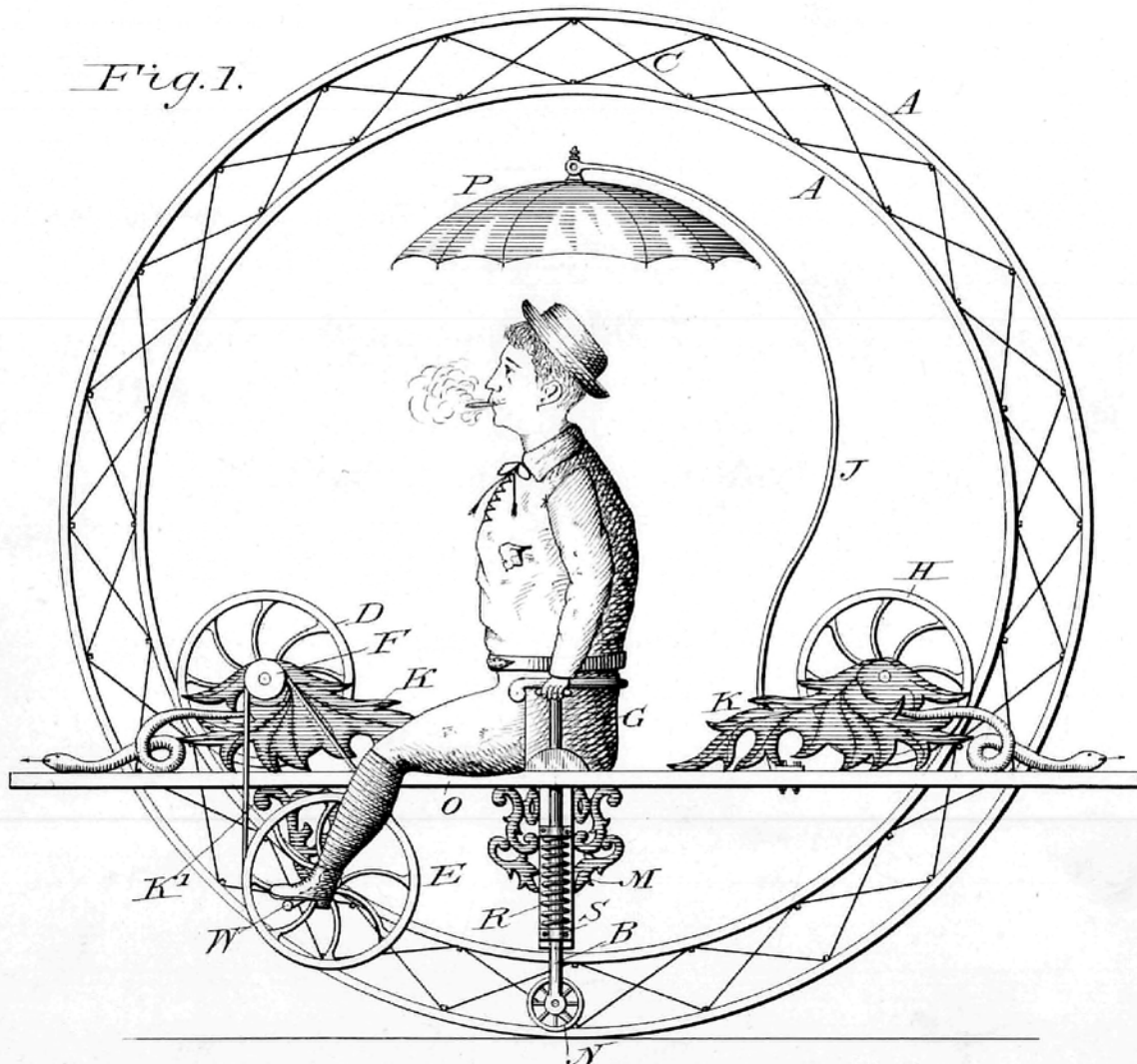
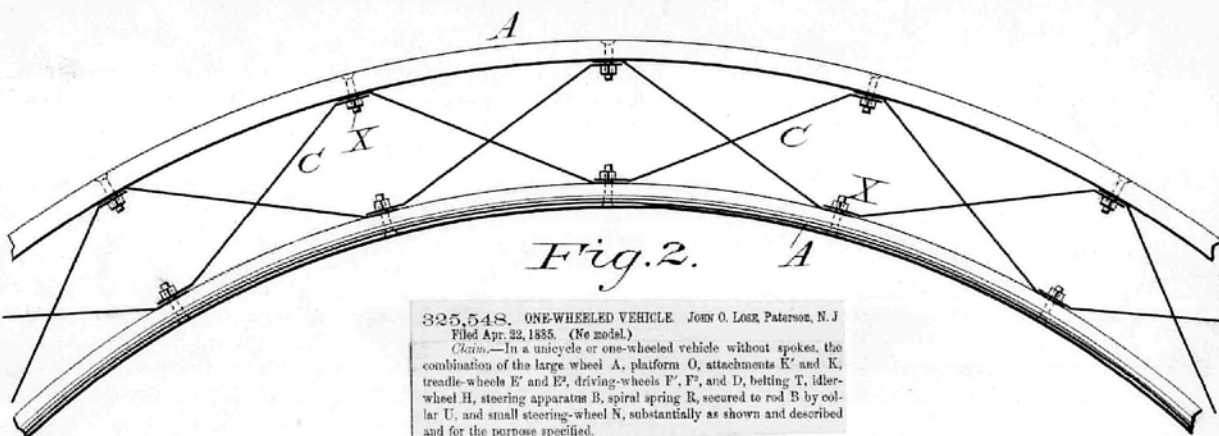

Fig. 2.



325,548. ONE-WHEELED VEHICLE JOHN O. LOSE, Paterson, N. J.

Filed Apr. 22, 1885. (No model.)

Claim.—In a unicycle or one-wheeled vehicle without spokes, the combination of the large wheel A, platform O, attachments K' and K, treadle-wheels E' and E, driving-wheels F', F, and D, belting T, idler-wheel H, steering apparatus B, spiral spring R, secured to rod B by collar U, and small steering-wheel N, substantially as shown and described and for the purpose specified.

Witnesses:

Andrew B. Inglish,
John H. Reynolds.

Inventor:

John Otto Lose
By John F. Kern
Attorney

Classification Division. 52
J
O. Lose. One Wheeled Vehicle.

No. 730,918.

PATENTED JUNE 16, 1903.

A. JACKSON, JR.
EYE PROTECTOR FOR CHICKENS.
APPLICATION FILED DEC. 10, 1902.

NO MODEL.

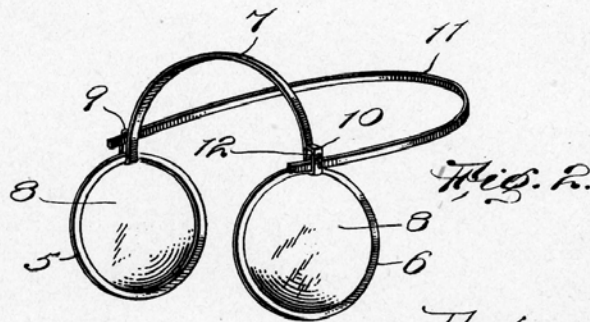
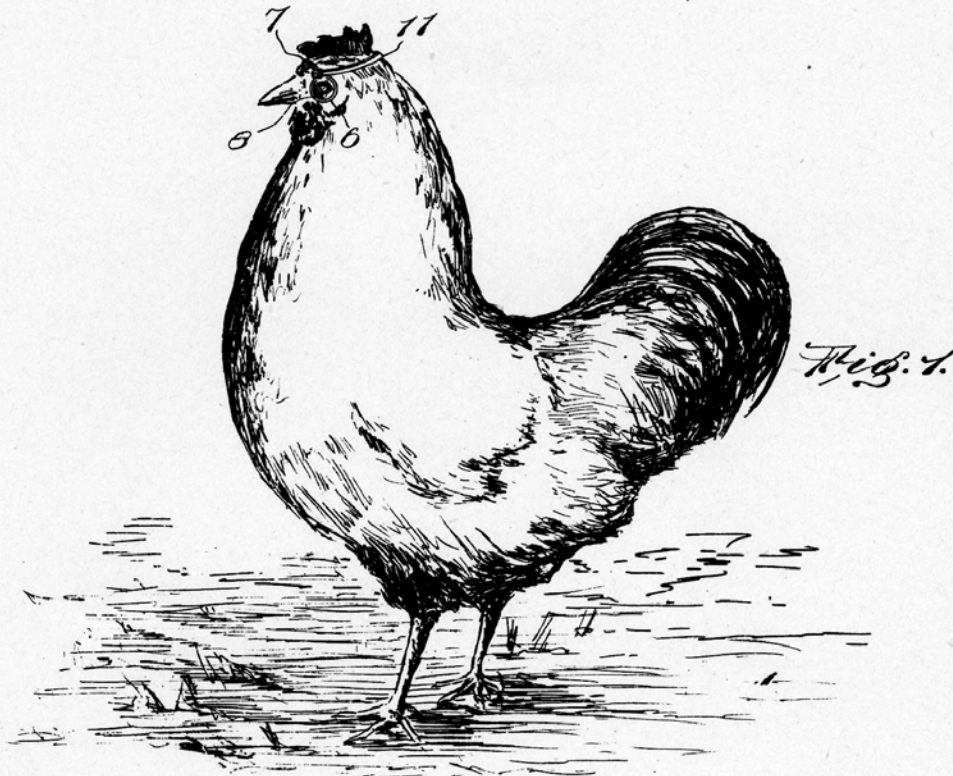

Witnesses
W. Simpson
Harry W. Chandler

Inventor
Andrew Jackson, Jr.
By *Charles Chandler*
Attorneys

J. C. BOYLE.
SALUTING DEVICE.

No. 556,248.

Patented Mar. 10, 1896.

1401
120

dir 3

Fig: 1.

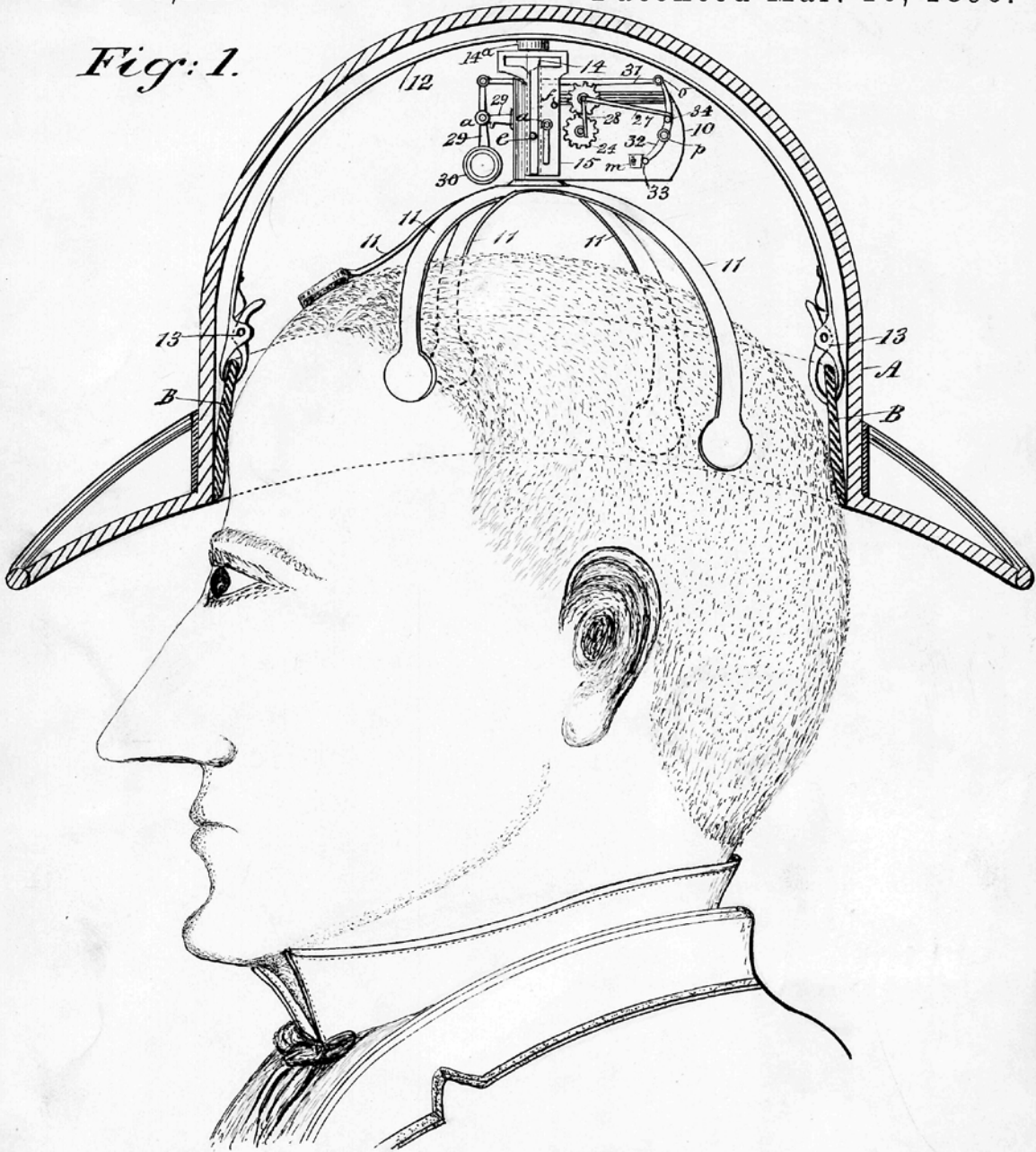

Fig: 2.

WITNESSES:

Wm P Patton
Herbert A Thorpe

INVENTOR

J. C. Boyle

BY *Wm P Patton*

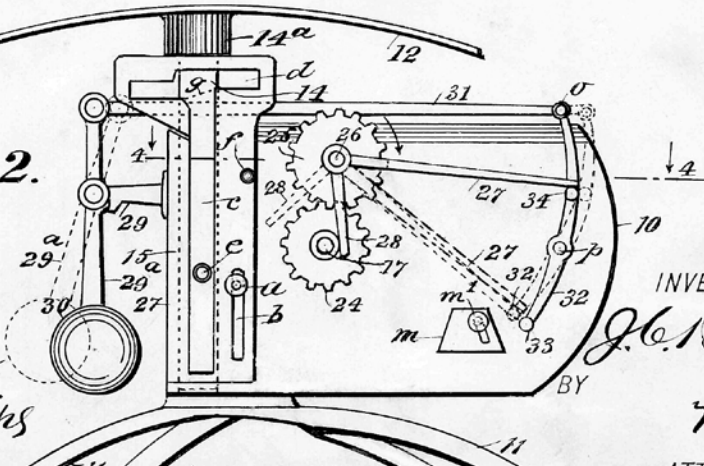

J. C. Boyle,
Saluting Device,
248

J. J. HENTZ.
BICYCLE.

(Application filed Nov. 3, 1897.)

(No Model.)

No Model
Classification Division
624,651

Div.
Be
Craw
&
Chan

Fig. 3.

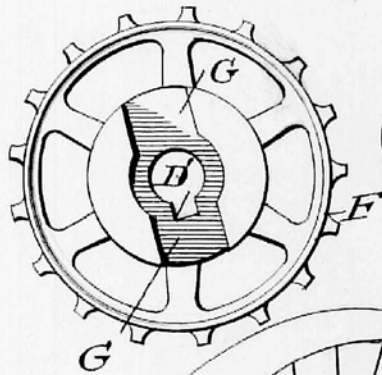

Fig. 1.

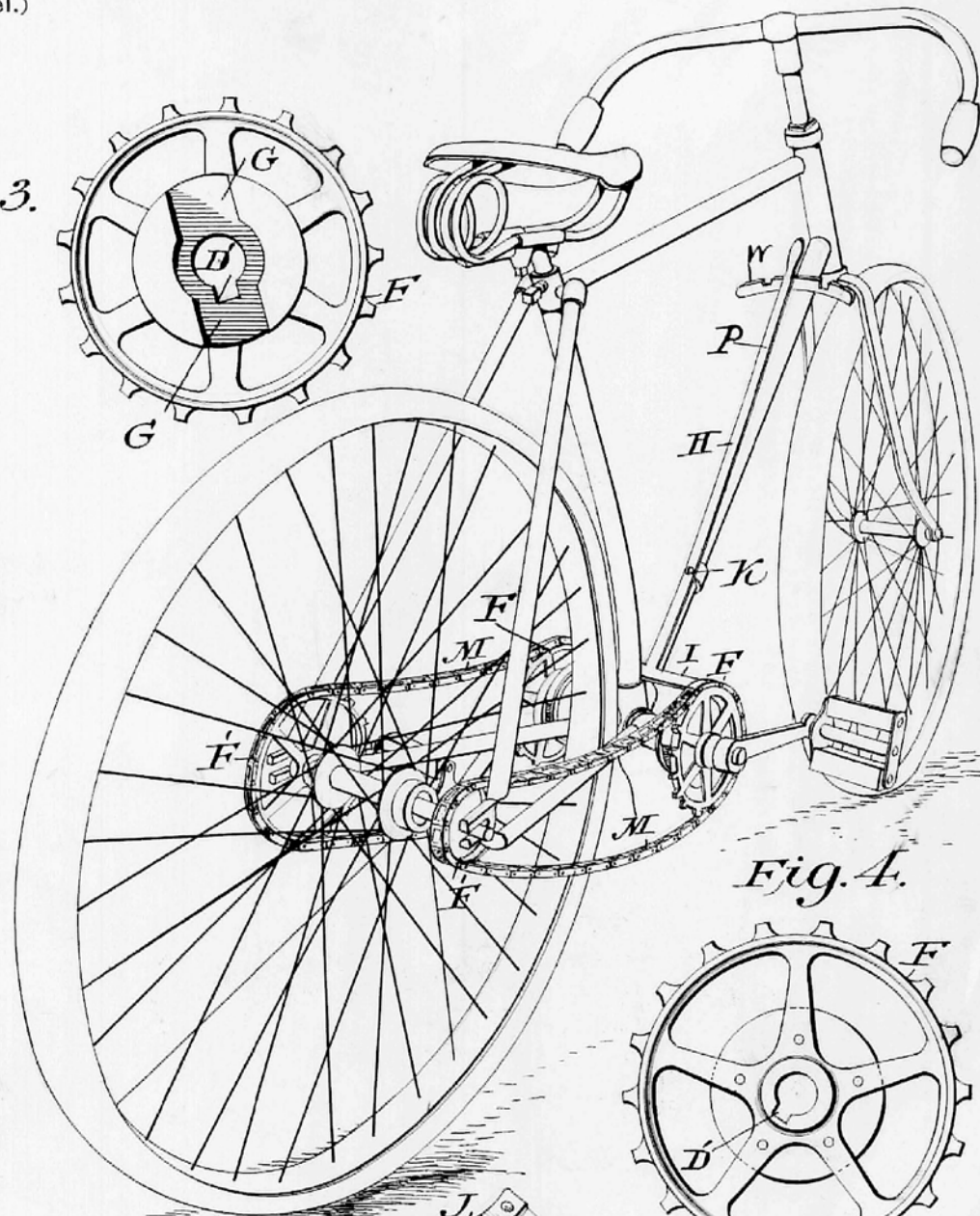

Fig. 4.

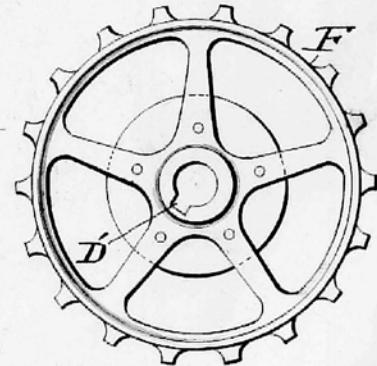

Fig. 5.

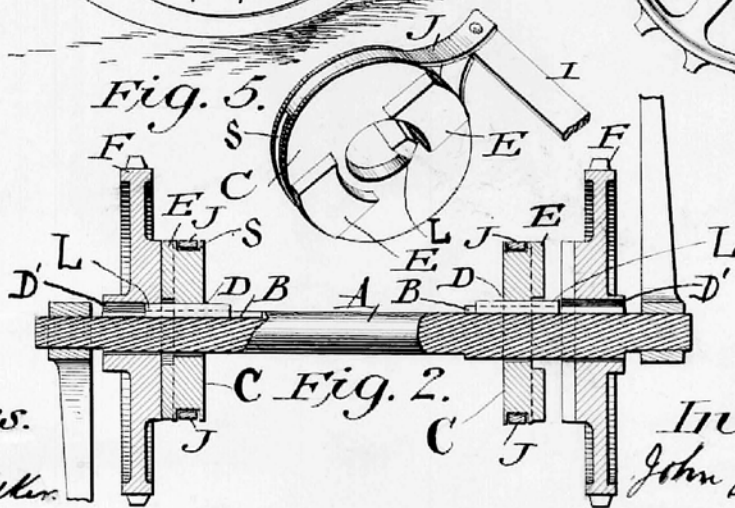

Fig. 2.

Witnesses:

Chas. H. Baker

Inventor:

John J. Hentz

HAMMOCK.

537

No. 400,131.

Patented Mar. 26, 1889.

CLASSIFICATION
DIVISION

Herbert Morley Small
Hammock

Fig. 1.



Fig. 2.

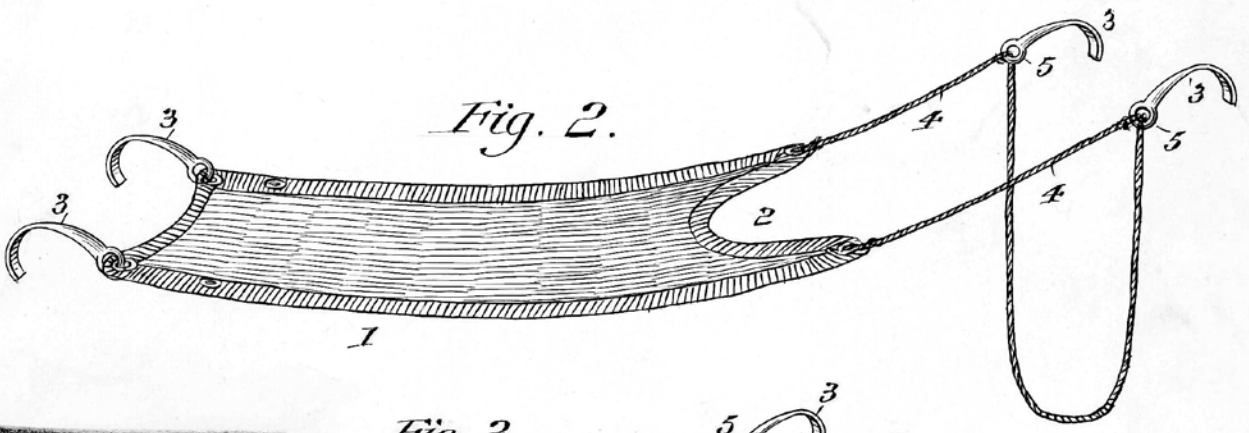
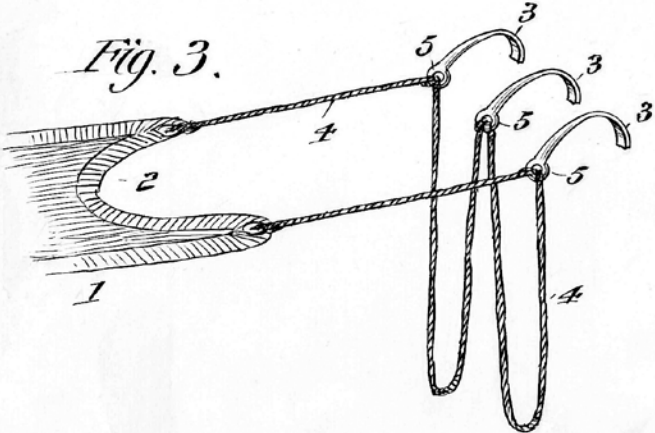

Fig. 3.



400,131. HAMMOCK. HERBERT M. SMALL, Baldwinville, Ma.
 Filed June 19, 1888. Serial No. 277,573. (No model.)
Claim.—1. A hammock consisting in a seat and back portions, supporting-hooks at the upper end of the back portion, a looped rope secured at its ends to the forward corners of the seat portion, and adjustable hooks on the parallel parts of the rope, the looped part of the rope forming a foot-rest, substantially as set forth.
 2. A hammock constructed with supporting-hooks at one end and having at its other end a curved recess, and supporting-hooks with a rope passing through eyes in the shanks of the hooks and attached at its ends to the corners of the recessed end of the hammock, substantially as shown and described.
 3. A hammock constructed with main portion 1, having curved recess 2, supporting-hooks 3 at one end and the looped rope 4 with its ends secured at the recessed end of the main portion 1, and supporting-hooks 3, having eyes 5, through which rope 4 passes, substantially as shown and described.

WITNESSES:

H. Clark

INVENTOR:

H. M. Small

CLASSIFICATION
DIVISION
Cat 7

Josiah H. L. Tuck.
Submarine Vessel.

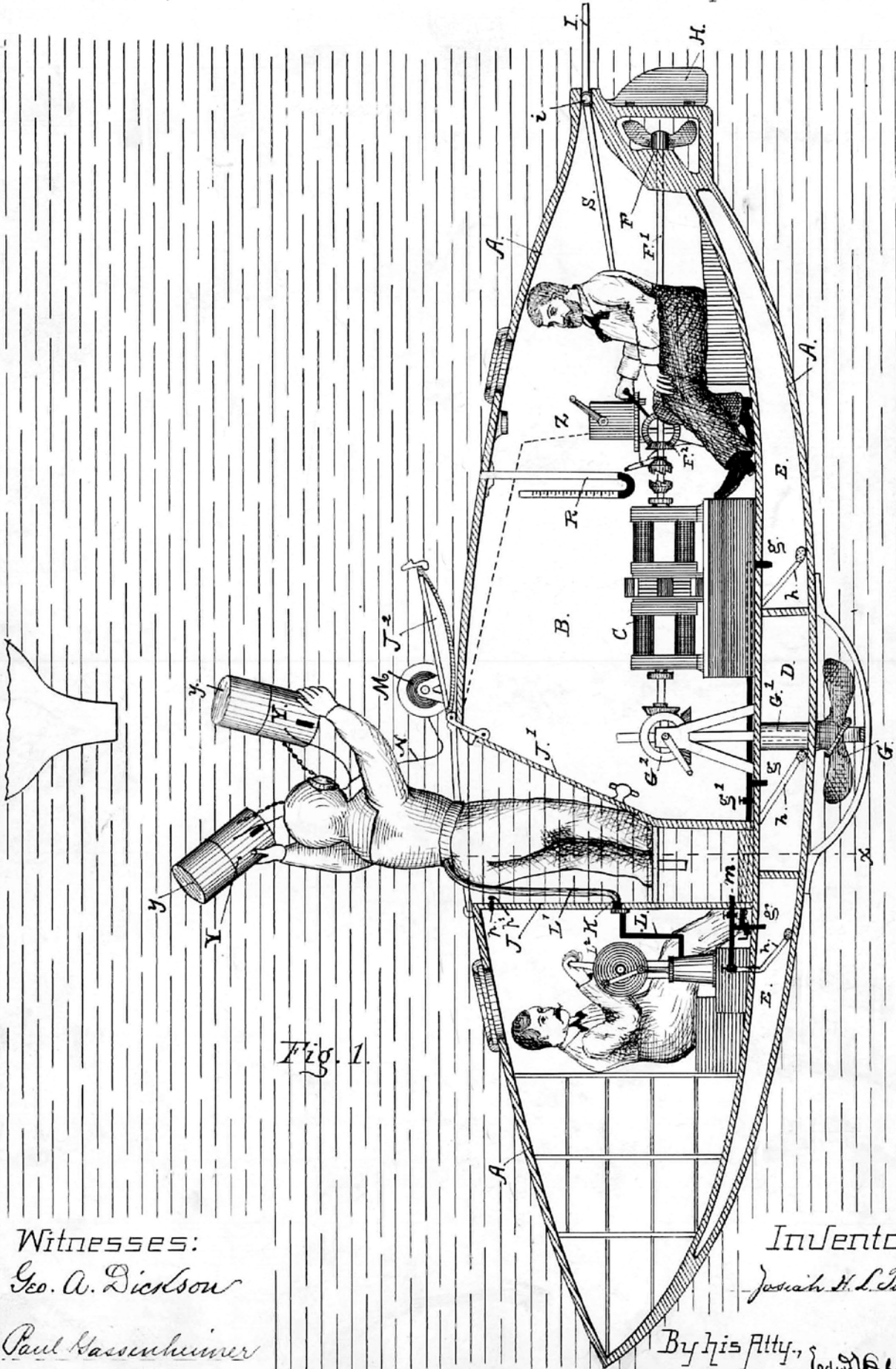

Fig. 1.

Witnesses:
Geo. A. Dickson
Paul Kassenheimer

Inventor:
Josiah H. L. Tuck
By his Atty.,
Edw. S. Stone

(No Model.)

G. L. WITSIL.
SANDWICHED BREAD.

No. 248,247.

Patented Oct. 11, 1881.

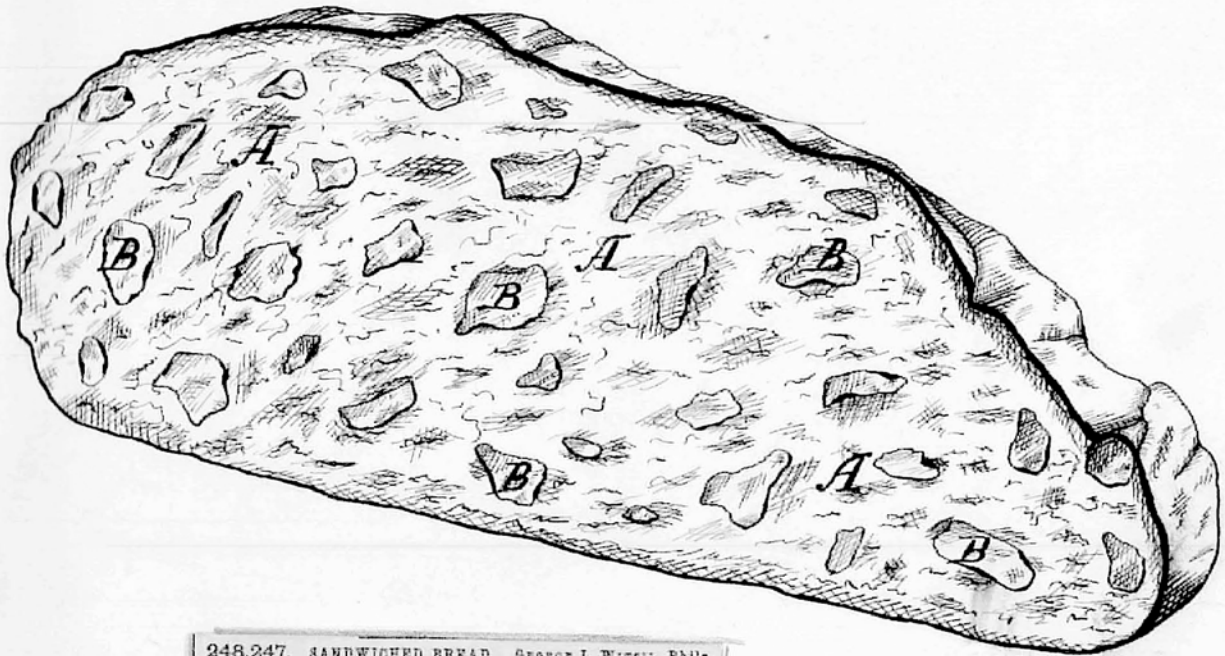

248,247. SANDWICHED BREAD. GEORGE L. WITSIL, Philadelphia, Pa., assignor, by direct and mesne assignments, to Alfred Martien and John Jolley, Jr., both of same place. Filed Jan. 8, 1881. (No specimens.)



Claim.—As a new article of manufacture, sandwiched bread or bread containing pieces of meat which have been distributed in a raw condition throughout the dough of which the bread is composed and have been cooked at the same time therewith, substantially as hereinbefore set forth.

985,746.

Patented Feb. 28, 1911.

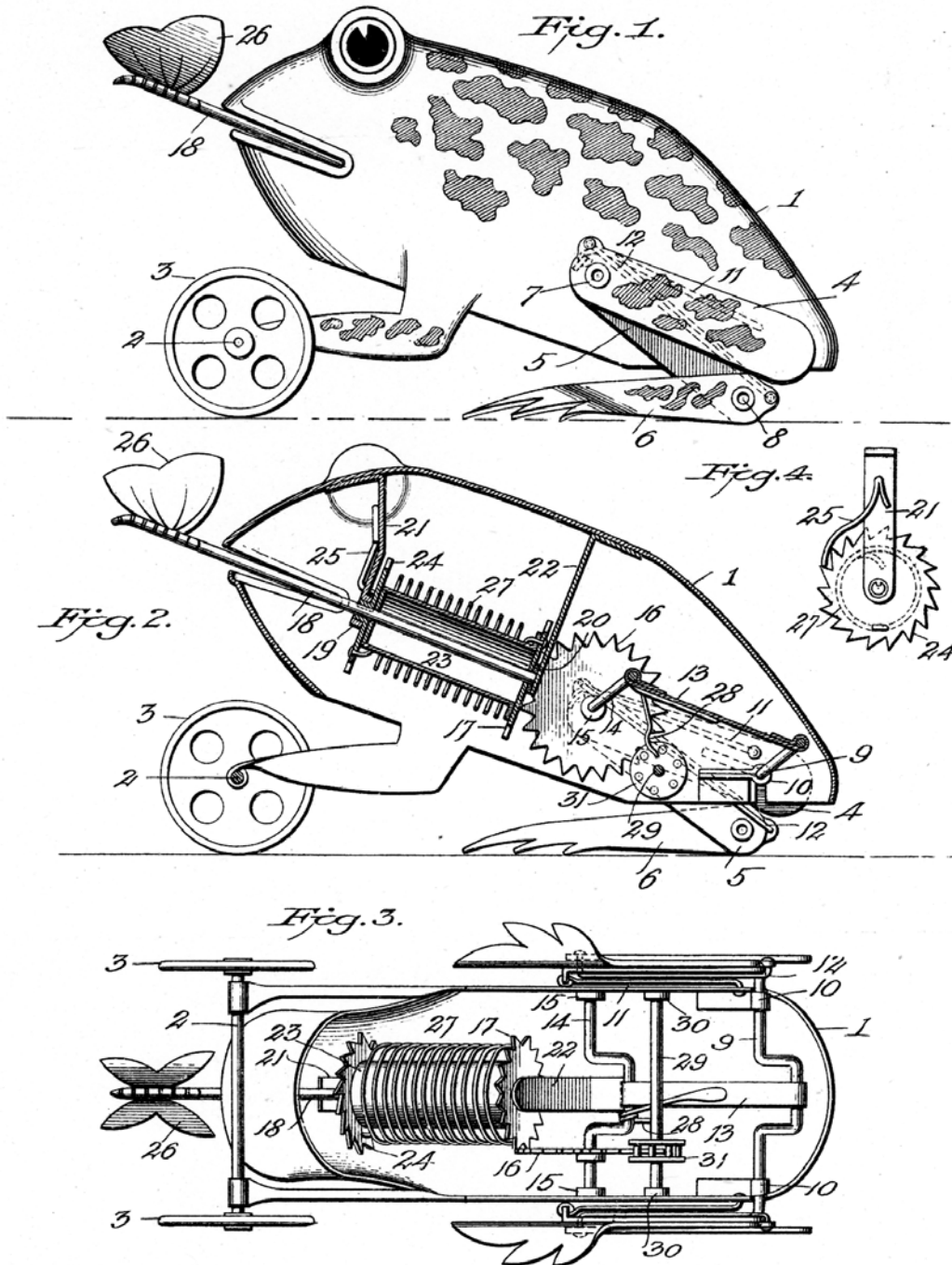

Witnesses:
 G. Sargent Elliott
 Adella M Fowle

Inventor:
 Charles A. Lewis.
 By H. S. Bailey Attorney.

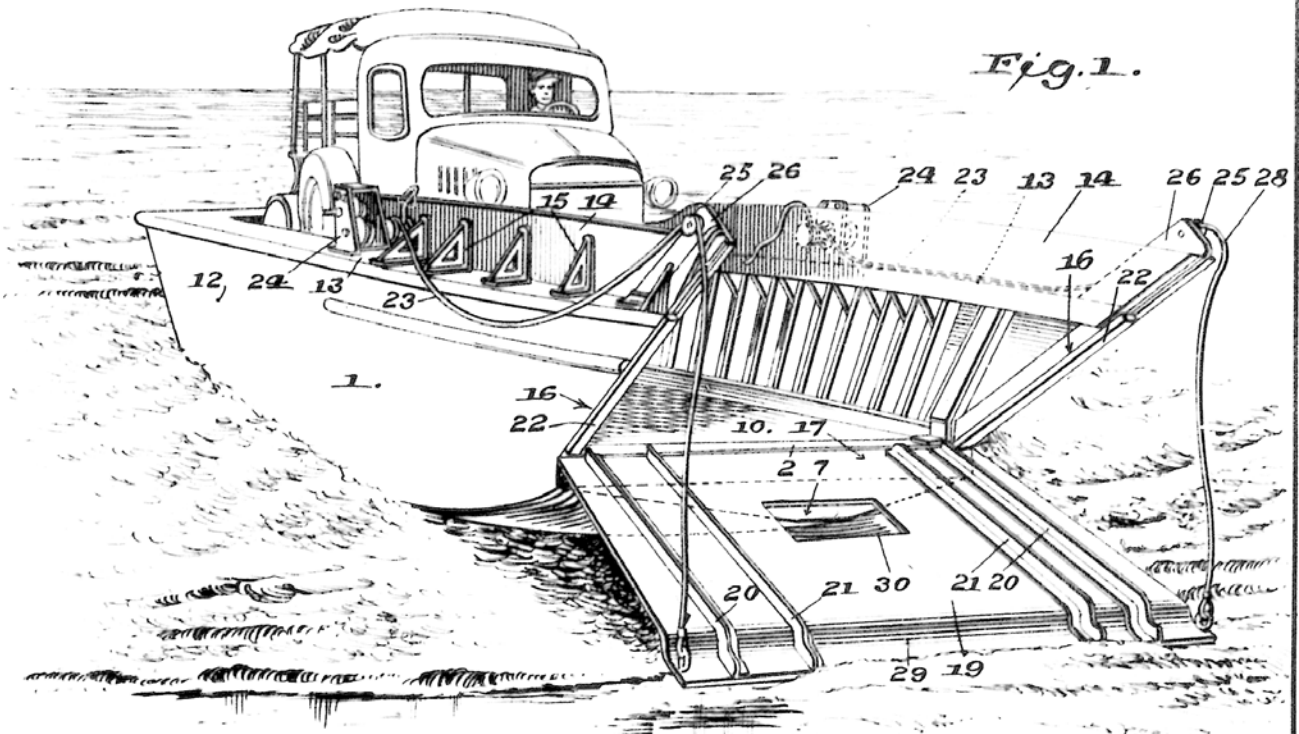

Fig. 1.

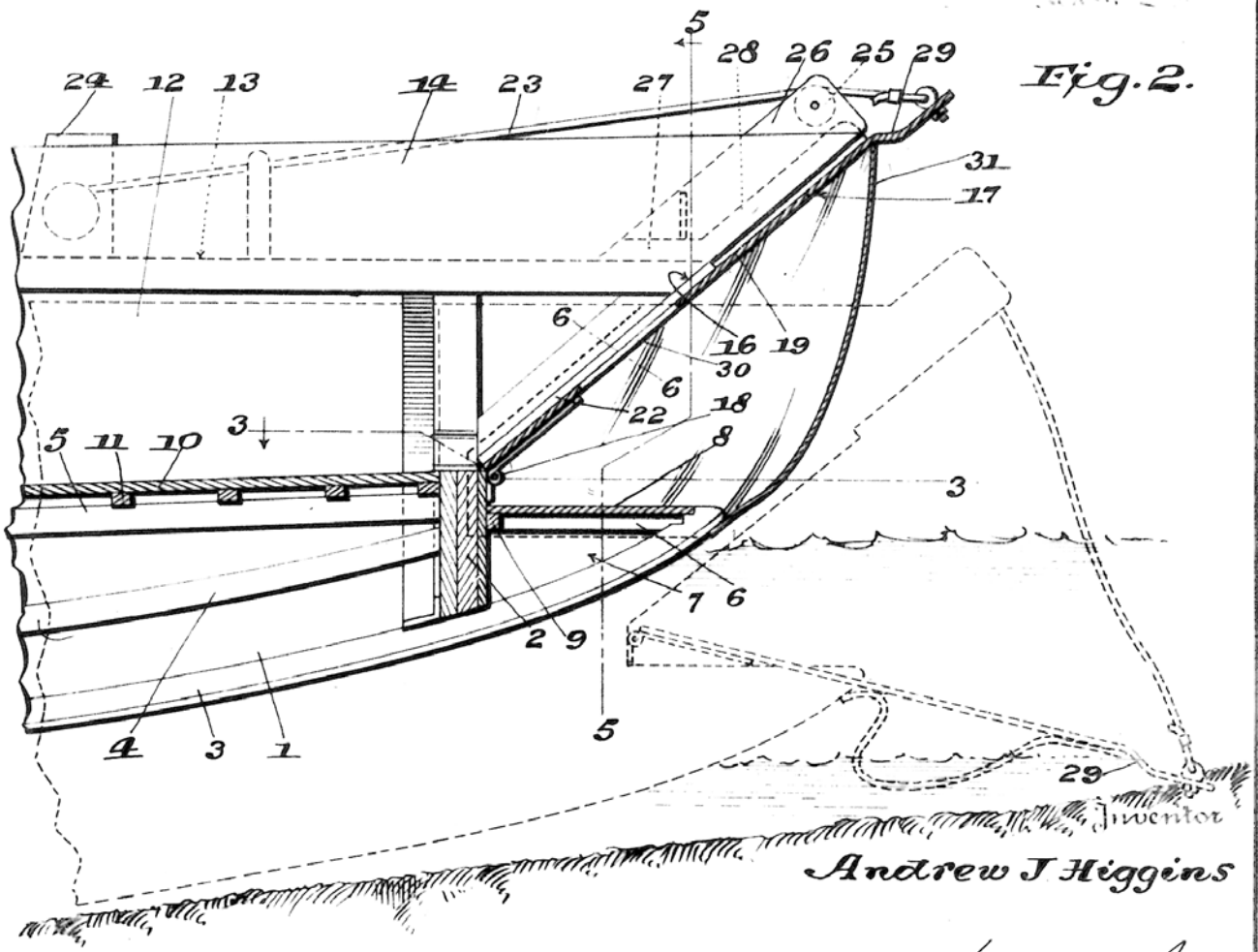

Fig. 2.

Inventor
Andrew J Higgins

Mason Fenwick Lawrence
 Attorneys

Patent for a lighter for mechanized equipment, 1944. (Recognize it? This became the troop lander used at D-day landings.)

No. 755,209.

PATENTED MAR. 22, 1904.

J. E. BENNETT.
BASE BALL CATCHER.
APPLICATION FILED FEB. 18, 1903.

NO MODEL.

4 SHEETS—SHEET 1.

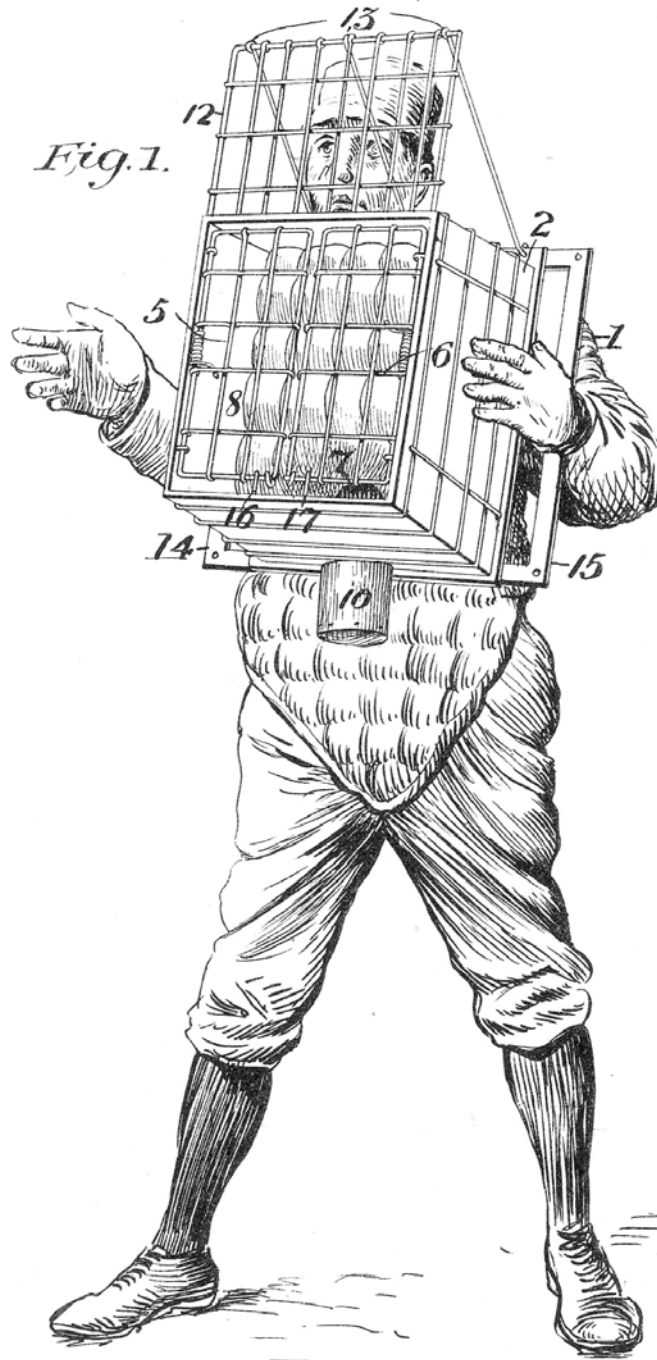

Witnesses
H. J. Roden
B. F. Gray.

Inventor
James Edward Bennett
By Joseph W. Sower
att'y

May 8, 1934.

H. A. HIRSCH

1,958,045

COMBINED LOUNGE ROBE AND JACKET

Original Filed July 18, 1932

Fig. 1

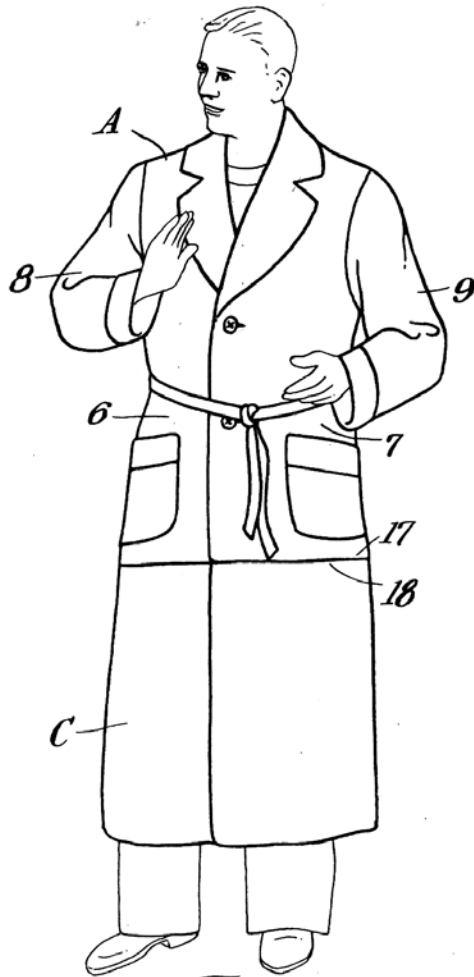

Fig. 2



Property of the U. S. Patent Office
Not to be taken from the Files.

Fig. 3

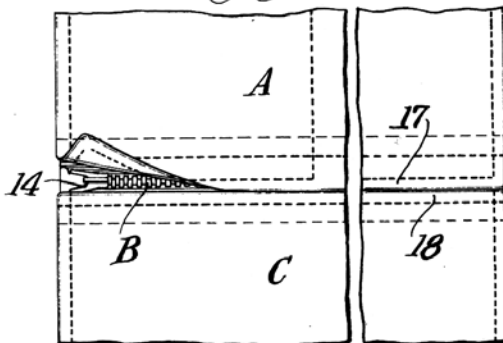

Fig. 4

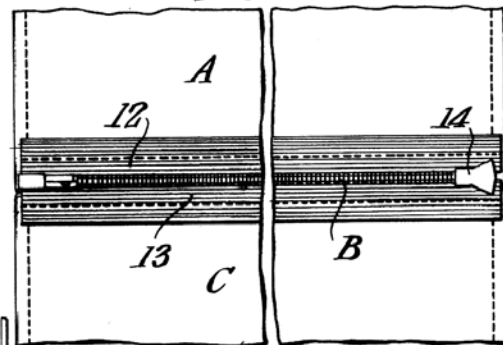

Fig. 5

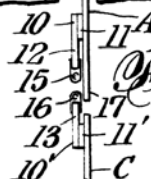
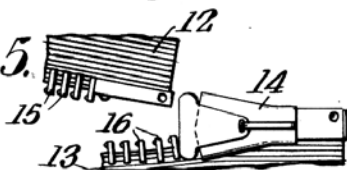

Fig. 6

INVENTOR

Harry A. Hirsch

BY

Samuel Spring
ATTORNEY

#2

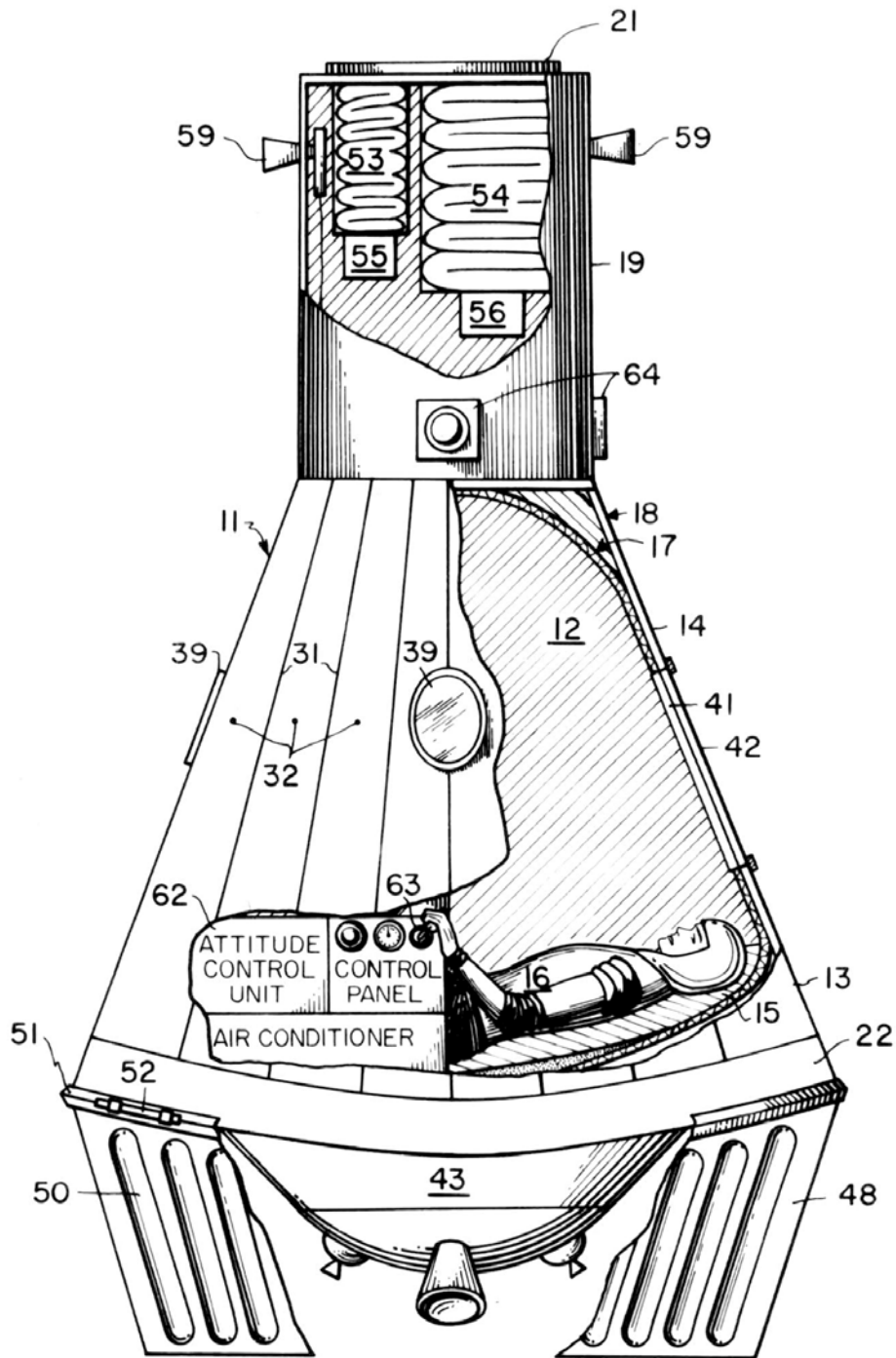

FIG. I

INVENTORS
M.A. FAGET W.S. BLANCHARD, JR.
A.J. MEYER, JR. A.B. KEHLET
R.G. CHILTON J.B. HAMMACK
C.C. JOHNSON, JR.