



# UNITED STATES COAST GUARD

---

Report of Investigation into the Circumstances Surrounding the  
Explosion, Fire, Sinking and Loss of Eleven Crew Members

Aboard the  
MOBILE OFFSHORE DRILLING UNIT

## *DEEPWATER HORIZON*

In the GULF OF MEXICO

April 20 – 22, 2010



Volume I  
MISLE Activity Number: 3721503

## Table of Contents

**Volume I** (*Systems and responsibilities within U.S. Coast Guard purview under the U.S. Coast Guard-Minerals Management Service Memorandum of Agreement dated March 27, 2009*)

Table of Contents	i
Prologue	iii
Executive Summary	viii
Chapter 1   Explosion	1
Chapter 2   Fire	34
Chapter 3   Evacuation / Search and Rescue	46
Chapter 4   Flooding and Sinking	72
Chapter 5   Safety Systems (Personnel and Process)	89
Chapter 6   Summary of Conclusions	112
Chapter 7   Safety Recommendations	120
Chapter 8   Administrative Recommendations	127
Appendices	
Appendix A   List of Abbreviations	A-1
Appendix B   Lists of Figures and Tables	B-1
Appendix C   Parties in Interest	C-1
Appendix D   Crew Data	D-1
Appendix E   Vessel Particulars	E-1
Appendix F   Weather Information	F-1
Appendix G   Final Action Report on the SAR Case Study into the Mass Rescue of Personnel off the Mobile Offshore Drilling Unit <i>DEEPWATER HORIZON</i>	G-1

Appendix H	Critical Events Timeline	H-1
Appendix I	Potential Legal Issues Associated with Vessels Employing Dynamic Positioning Systems	I-1
Appendix J	Synopsis of Audits and Surveys	J-1
Appendix K	Examples of Transocean’s Non-compliance with the International Safety Management Code	K-1
Appendix L	Post-sinking Analysis for <i>DEEPWATER HORIZON</i>	L-1
Appendix M	Operational Risk Assessment	M-1
Appendix N	BP <i>DEEPWATER HORIZON</i> Follow Up Rig Audit, Marine Assurance Audit and Out Of Service Period, September 2009	N-1
Appendix O	Results of Inspections & Surveys of <i>Deepwater Horizon</i> (2009-2010)	O-1
Appendix P	Convening Order Joint Department of the Interior and Department of Homeland Security Statement of Principles and Convening Order Regarding Investigation into the Marine Casualty, Explosion, Fire, Pollution, and Sinking of Mobile Offshore Drilling Unit <i>DEEPWATER HORIZON</i> , with Loss of Life in the Gulf of Mexico 21-22 April 2010	P-1
Appendix Q	USCG Investigation Team Members	Q-1

## PROLOGUE

---

On April 20, 2010, the Mobile Offshore Drilling Unit (MODU) *DEEPWATER HORIZON* was dynamically-positioned at location 28°-44' North 088°-21' West in the Mississippi Canyon Block 252 of the U.S. Outer Continental Shelf (OCS). The MODU was performing drilling operations on the Macondo Well, which had been previously started by another vessel. That evening, a series of events began that would ultimately result in an explosion and fire, taking 11 lives, injuring 16 others, and ultimately causing the MODU to become severely crippled and sink. The casualty resulted in a continuous flow of hydrocarbons into the Gulf of Mexico for 87 days before the well was capped, causing the largest oil spill in U.S. history and significant environmental damage to the Gulf of Mexico. The tragedy affected the lives of hundreds of thousands of people who live along the Gulf Coast or rely on the various economies associated with the Gulf of Mexico.

Within six days of the incident, the Department of Homeland Security and the Department of the Interior determined that a joint investigation of the *DEEPWATER HORIZON*'s explosion, sinking, and the associated loss of life was the best strategy for determining the events, decisions, actions, and resultant consequences of this marine casualty. The joint investigation was conducted by the U.S. Coast Guard (USCG) and the Bureau of Ocean Energy Management, Regulation and Enforcement (BOEMRE). The Joint Investigation Team (JIT) used the combined investigative powers and authorities afforded to the USCG and BOEMRE. Personnel from each agency were specifically assigned to the JIT to accommodate the collection of evidence, conduct public hearings and inquiries, and coordinate forensic testing.

The agencies operated under the 2009 Memorandum of Agreement (MOA) that identifies responsibilities of the Minerals Management Service (MMS) (predecessor to BOEMRE) and the USCG. The USCG and MMS entered this agreement under the authority of Title 14, United States Code (U.S.C.) § 141 – USCG Cooperation with other Agencies; 43 U.S.C. §§ 1347, 1348(a) – the Outer Continental Shelf Lands Act (OCSLA), as amended; 33 U.S.C. § 2712(a)(5)(A) – the Oil Pollution Act of 1990 (OPA); 43 U.S.C. §§ 1301-1315 – the Submerged Lands Act (SLA), as amended; and the Energy Policy Act of 2005.

Per its Maritime Regulations, the Republic of the Marshall Islands (RMI), the flag state for *DEEPWATER HORIZON*, is also responsible for investigating casualties that are categorized as “Serious Marine Casualty” under the International Maritime Organization’s (IMO) Casualty Investigations Code. The *DEEPWATER HORIZON* casualty falls in this category. To avoid duplication of efforts, the USCG and RMI investigators shared data and coordinated requests for information. Upon conclusion of the investigations, both countries are required to submit their reports to the IMO for distribution of lessons learned and possible enhancement of safety standards.

### *Regulatory Structure*

The Outer Continental Shelf Lands Act (OCSLA), Title 43, United States Code, Chapter 29, Subchapter III, provides regulatory authority over activities on the outer continental shelf (OCS)

to the Secretary of the Interior, Secretary of Homeland Security, Secretary of the Army, Secretary of Labor, Secretary of Transportation and Secretary of Energy. The Secretary of the Interior and the Coast Guard (which has received a delegation of the relevant authorities from the Secretary of Homeland Security) are responsible for requiring, wherever practicable, the best available and safest technologies that are economically feasible, wherever failure of equipment would have a significant effect on safety, health, or the environment. The Coast Guard also promulgates regulations or standards applying to unregulated hazardous working conditions related to activities on the OCS when such regulations or standards are necessary. OCSLA specifically requires the Secretary of the Interior and the Coast Guard to individually or jointly enforce these safety and environmental regulations at least once a year. Such enforcement should include inspecting all safety equipment designed to prevent or ameliorate blowouts, fires, spillages, or other major accidents, and performing a periodic onsite inspection without advance notice to the operator.

To meet these requirements, the Coast Guard and MMS signed a memorandum of understanding (MOU) to delineate inspection responsibilities between both the agencies. The MOU is further broken down into five memoranda of agreement (MOAs): OCS-01 Agency Responsibilities, OCS-02 Civil Penalties, OCS-03 Oil Discharge Planning, Preparedness and Response, OCS-04 Floating Offshore Facilities and OCS-05 Incident Investigations. OCS-01 established responsibilities for each agency and clarified overall responsibility where jurisdiction overlapped.

Based on these memoranda of agreement, the Coast Guard performs annual inspections on U.S.-flagged MODUs/floating offshore installations and annual examinations on foreign-flagged MODUs. These visits focus on the safe manning and operation of MODUs and include inspection of: lifesaving, fire-fighting, hull integrity, vessel stability, means of egress, locations containing hazardous electrical equipment, machinery systems, electrical systems, helicopter facilities, cranes, navigation and occupational health and safety. In the case of foreign-flagged MODUs, the flag state has primary responsibility for ensuring compliance with applicable international standards. However, the United States can set requirements and conditions for conducting activities on the U.S.OCS, including those that are applicable to foreign-flagged MODUs. Pursuant to Coast Guard regulations specified in 33 C.F.R. § 146.205, foreign-flagged MODUs engaged in OCS activities must comply with one of three regulatory schemes, one of which is the International Maritime Organization (IMO) MODU Code, which contains recommended design criteria, construction standards, and other safety measures for MODUs.

*DEEPWATER HORIZON* was a foreign-flagged MODU that engaged in oil drilling activities on the OCS. It was built and operated in accordance with the 1989 IMO MODU Code. Its flag state, RMI, used the American Bureau of Shipping and Det Norske Veritas as recognized organizations to conduct its required surveys and audits. The USCG periodically performed a limited safety examination, which included verifying statutory certificates, testing of safety devices, and witnessing emergency drills. At the time of the casualty, *DEEPWATER HORIZON* possessed all required valid documents certifying compliance with applicable international, RMI and USCG requirements.

## *The Investigation*

Under the MOAs, BOEMRE is responsible for investigating incidents related to systems associated with exploration, drilling, completion, workover, production, pipeline and decommissioning operations for hydrocarbons and other minerals on the OCS. The USCG is responsible for investigating marine casualties involving deaths, injuries, property/equipment loss, vessel safety systems, and environmental damage resulting from incidents aboard vessels subject to U.S. jurisdiction. The MOA assigns responsibility in joint investigations according to these responsibilities. Volume I addresses the areas of USCG responsibility and Volume II will address the areas of BOEMRE responsibility.

The *DEEPWATER HORIZON* catastrophic casualty was comprised of a number of events. The initial events included a loss of well control leading to a blowout, which were preceded by a number of risk-based decisions by the lessee and vessel operators. In this Volume I, the subsequent events, including explosion, fire, evacuation, vessel sinking and vessel safety systems are examined. It focuses on the period from approximately 2150 on April 20, when hydrocarbons reached the Drill Floor and the drilling crew reported a “well control situation,” until 1026 on April 22, when *DEEPWATER HORIZON* sank.

The marine casualty investigation into this incident began almost immediately after the USCG received a distress alert from *DEEPWATER HORIZON*. Three Coast Guard investigators were dispatched to the scene. They, along with MMS investigators, were transported by helicopter to the platform *MATTERHORN TLP*, where they boarded the offshore supply vessel *DAMON B. BANKSTON*, which had rescued the survivors, and began conducting interviews and gathering documentary evidence. Coast Guard marine casualty investigators also obtained the results of post-casualty drug tests were conducted upon the *DAMON B. BANKSTON*'s arrival in Port Fourchon, Louisiana.

The joint investigation began on April 27, when the Department of Homeland Security and the Department of the Interior issued a Convening Order for the investigation. Captain Hung Nguyen, USCG, and Mr. [REDACTED] MMS, were assigned as co-chairs. Later, Captain Mark Higgins, Captain [REDACTED] (USCG, retired), and Lieutenant Commander [REDACTED] were designated as Coast Guard members. Additionally, Lieutenant Commander [REDACTED] was assigned as Coast Guard Counsel to the Joint Investigation Team.

USCG marine casualty investigation activities are guided by statute, regulations, and the Marine Safety Manual, Volume V. Significant Coast Guard resources were devoted to this investigation. The Board received technical, public affairs, legal and administrative support from the following Coast Guard units and Headquarters offices:

- Marine Safety Unit Houma
- Marine Safety Unit Morgan City
- Marine Safety Unit Port Arthur
- Sector Honolulu
- Sector Houston-Galveston
- Sector New Orleans

- Sector San Francisco
- Public Affairs Detachment Houston
- District Eight External Affairs
- Investigations National Center of Expertise
- Offshore National Center of Expertise
- Marine Safety Center
- Commandant (CG-094, CG-52, CG-53, CG-54)

In determining causal factors and identifying potential improvement, an “Investigation Roadmap,” Figure 1 was developed to focus investigators on potential problem areas. Initial public hearings were organized to evaluate the adequacy of vessel design standards, casualty response and Government oversight. As information became available, additional hearings were held to examine the results of forensic testing of physical evidence, the effectiveness of vessel safety management, and corporate safety culture. The oil spill response efforts associated with the explosion and extending beyond April 26th are outside the scope of this investigation. Information dealing with the oil spill response may be obtained by contacting the Coast Guard in Washington, DC.<sup>1</sup>

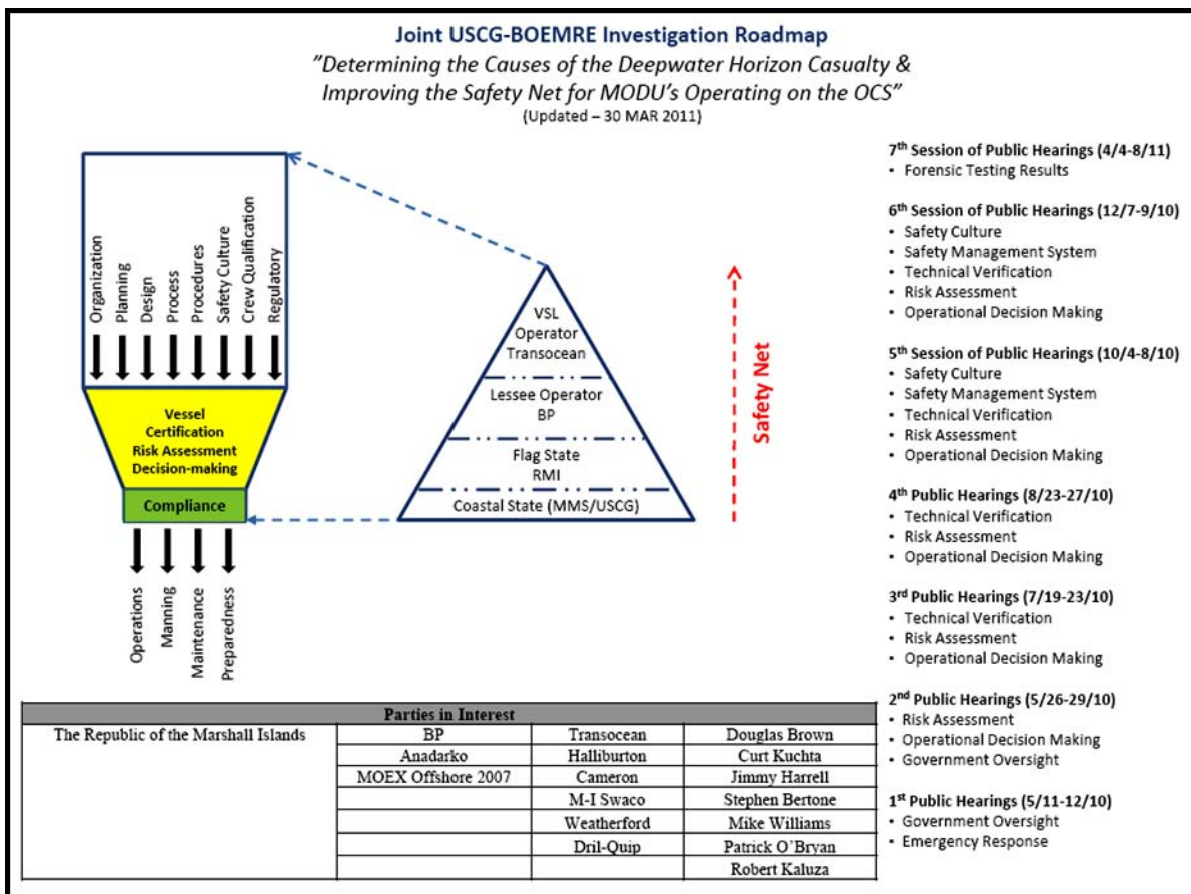

Figure 1 – Investigation Roadmap – *DEEPWATER HORIZON* Casualty

<sup>1</sup> United States Coast Guard, Attn: Commandant (CG-5), 2100 Second Street, S.W., Stop 7355, Washington, DC 20593-7355

Relating to vessel safety, the USCG members of the Board identified a number of subjects for inclusion in the investigation:

- The materiel condition and emergency preparedness of *DEEPWATER HORIZON*;
- The vessel's dual-command organizational structure and how it impacted the crew's situational awareness, risk assessment and decision making;
- The role that Transocean's safety management system played leading up to and during this casualty;
- The Republic of the Marshall Islands' safety oversight of *DEEPWATER HORIZON*;
- The Coast Guard's regulatory requirements for U.S. and foreign-flagged MODUs that engage in activities on the U.S. OCS;
- The "flag state/coastal state" oversight regime for foreign MODUs, which engage in activities on the U.S. OCS;
- The application of the 1989 IMO MODU Code to *DEEPWATER HORIZON*; and
- The international standards and Coast Guard regulations pertaining to vessels with dynamic positioning systems.

Safety recommendations have been developed to promote a higher safety standard, a more effective Government oversight program, and a more prepared response posture for complex and dangerous offshore oil and gas drilling operations.

In each chapter of this Volume I, the following are included:

- An overview of the event;
- A discussion of the relevant safety systems and any failures; and
- A discussion on how certain actions or decisions impacted the safety systems or caused them to fail.



## EXECUTIVE SUMMARY

---

On April 20, 2010 at approximately 2150, hydrocarbons rising up from BP's Macondo well ignited and caused an explosion on *DEEPWATER HORIZON*, a mobile offshore drilling unit (MODU) that was drilling approximately 40 miles off the coast of Louisiana. A short time later, a second explosion rocked the unit. These explosions triggered a massive fire that burned out of control. Crew members evacuated by lifeboat and liferaft, and some jumped from the burning unit. U.S. Coast Guard and other vessels and aircraft searched for survivors and sought to salvage the vessel. Because *DEEPWATER HORIZON* had not been able to shut in the well (close) or disconnect from the well head, the hydrocarbons that were fueling the fire continued to flow unabated. At 1026 on April 22, *DEEPWATER HORIZON* sank into the Gulf of Mexico. 115 people aboard successfully evacuated and survived. However, 11 crew members are missing and presumed deceased, and 16 were injured.

The Joint Investigation Team (JIT) comprised of members from the U.S. Coast Guard and Bureau of Ocean Energy Management, Regulation and Enforcement (BOEMRE) examined five aspects of this disaster relating to areas of responsibility of the U.S. Coast Guard: the explosions, the fire, the evacuation, the flooding and sinking of the MODU, and the safety systems of *DEEPWATER HORIZON* and its owner-operator, Transocean. Although the events leading to the sinking of *DEEPWATER HORIZON* were set into motion by the failure to prevent a well blowout, the investigation revealed numerous systems deficiencies, and acts and omissions by Transocean and its *DEEPWATER HORIZON* crew that had an adverse impact on the ability to prevent or limit the magnitude of the disaster. These included poor maintenance of electrical equipment that may have ignited the explosion, bypassing of gas alarms and automatic shutdown systems that could prevent an explosion, and lack of training of personnel on when and how to shutdown engines and disconnect the MODU from the well to avoid a gas explosion and mitigate the damage from an explosion and fire. These deficiencies indicate that Transocean's failure to have an effective safety management system and instill a culture that emphasizes and ensures safety contributed to this disaster.

This investigation also revealed that the oversight and regulation of *DEEPWATER HORIZON* by its flag state, the Republic of the Marshall Islands (RMI), was ineffective in preventing this casualty. By delegating all of its inspection activities to "recognized organizations," without conducting on board oversight surveys by administration officials, the RMI effectively abdicated its vessel inspection responsibilities. In turn, this failure illustrates the need to strengthen the system of U.S. Coast Guard oversight of foreign-flagged MODUs, which as currently constructed is too limited to effectively ensure the safety of such vessels.

The JIT is offering recommendations to enhance the safety and effective oversight of foreign-flagged MODUs. Many of these recommendations are for the Commandant of the Coast Guard to work with the International Maritime Organization (IMO) to amend its MODU Code, which is intended to provide guidance to flag state administrations in promulgating their own regulations.

## I. Explosions

During the evening of April 20, 2010, as the master (captain) of *DEEPWATER HORIZON* was conducting a tour of the MODU for visiting BP and Transocean officials, the drilling crew observed abnormal pressures in the pipe leading to the well and began initiating steps to shut in the well to prevent the release of hydrocarbons. Around 2150, however, there was a well blowout, as drilling mud and hydrocarbons came shooting up from the well. Although the crew tried to divert the flow to the mud gas separator (MGS), a system that separated out and released gas through an outlet at the top of the derrick, the mud and hydrocarbons began discharging onto the Drill Floor. Alarms activated, signaling that flammable gases were in various locations on or near the Drill Floor. The vessel was rocked by an explosion followed by a fire. As additional gas alarms activated, the MODU then suffered a second more violent explosion, which caused a total loss of electrical power.

After the explosions, the master asked for and received permission from the offshore installation manager (OIM) to activate the emergency disconnect system (EDS), designed to shut in the well and disconnect the MODU from the well, thereby cutting off the flow of hydrocarbons fueling the fire. By this time, however, the subsea supervisor on the bridge had already attempted to activate the EDS. Although the control panel displayed what appeared to be proper indications of operation, he determined that the signal never left the control panel, and the MODU could not be disconnected from the well.

### A. Causal Analysis

As the well blowout occurred, an uncontrolled volume of gas consisting of methane, ethane, propane, and hydrocarbons flowed up from the wellhead and likely formed a gas cloud over large areas on several decks. The explosions likely occurred when gas from this cloud encountered one or more ignition sources on the Drill Floor or elsewhere on *DEEPWATER HORIZON*.

- **Points of Origin:** The first explosion and fire occurred on the Drill Floor. Several witnesses observed drilling mud and liquids flowing out of a vent on the derrick connected to the MGS system, followed by an explosion. The second explosion occurred in Engine Room # 3 or in one of the adjacent switchgear or electrical rooms. Personnel in the Engine Control Room (ECR) saw and heard the explosion come from the direction of Engine Room #3 and force inward the port side door to the ECR.
- **Ignition Source:** Although the exact location of the ignition sources cannot be conclusively identified, the evidence best indicates that flammable gases were ignited by (1) electrical equipment on or near the Drill Floor, and/or (2) electrical equipment in or near the main engines and switchgear rooms.
- **Impact on Personnel:** All of the missing and presumed deceased crew members were last seen on or near the Drill Floor area or in the Mud Pits. Although cause of death cannot be definitively established, the crew members in the Drill Floor area are believed to have suffered fatal injuries during the initial explosions, because the

layout of the Drill Floor provided no protection from the force and heat of an explosion. The type of barrier between the Mud Pits and the Drill Floor area did not provide substantial protection for crew members against an explosion originating on the Drill Floor.

## B. Key Investigative Findings

The JIT investigation identified several system deficiencies and crew decisions that may have affected the explosions or their impact, including:

- **Failure to Use the Diverter Line:** When the drilling crew directed the uncontrolled well flow through the MGS, the high pressure exceeded the system's capabilities and caused gas to discharge on the main deck. Alternatively, the crew could have directed the well flow through a "diverter line" designed to send the flow over the side of the MODU. Although the diverter line also may have failed under the pressure, had it been used to direct the flow overboard, the majority of the flammable gas cloud may have formed away from the Drill Floor and the MODU, reducing the risk of an onboard explosion.
- **Hazardous Electrical Equipment:** At the time of the explosions, the electrical equipment installed in the "hazardous" areas of the MODU (where flammable gases may be present) may not have been capable of preventing the ignition of flammable gas. Although *DEEPWATER HORIZON* was built to comply with IMO MODU Code standards under which such electrical equipment is required to have safeguards against possible ignition, an April 2010 audit found that *DEEPWATER HORIZON* lacked systems to properly track its hazardous electrical equipment, that some such equipment on board was in "bad condition" and "severely corroded," and that a subcontractor's equipment that was in "poor condition" had been left in hazardous areas. Because of these deficiencies, there is no assurance that the electrical equipment was safe could not have caused the explosions.
- **Gas Detectors:** Although gas detectors installed in the ventilation inlets and other critical locations were set to activate alarms on the bridge, they were not set to automatically activate the emergency shutdown (ESD) system for the engines or to stop the flow of outside air into the engine rooms. The bridge crew was not provided training or procedures on when conditions warranted activation of the ESD systems. Thus, when multiple gas alarms were received on the bridge, no one manually activated the ESD system to shut down the main engines. Had it been activated immediately upon the detection of gas, it is possible that the explosions in the engine room area could have been avoided or delayed.
- **Bypassed Systems:** A number of gas detectors were bypassed or inoperable at the time of the explosions. According to the chief electronics technician, it was standard practice to set certain gas detectors in "inhibited" mode, such that gas detection would be reported to the control panel but no alarm would sound, to prevent false alarms from awakening sleeping crew members. Similarly, the crew bypassed an automatic shutdown system designed to cut off electrical power when ventilation system safety

features failed, possibly allowing flammable gas to enter an enclosed area and reach an ignition source. The chief electrician had been told that it had “been in bypass for five years” and that “the entire fleet runs them in bypass.”

- **Design of the Main and Emergency Sources of Electrical Power:** Although the arrangement of main and emergency generators on *DEEPWATER HORIZON* met IMO MODU Code requirements to have completely independent engine-generator rooms along with independent power distribution and control systems, it did not prevent a total failure of the main electrical power system, when the explosions and fire damaged multiple generators and their related power distribution and control equipment. The design also did not adequately take into account that the proximity of the air inlets to each other created a risk that flammable gases could impact all six generators at once.
- **Crew Blast Protection:** *DEEPWATER HORIZON* did not have barriers sufficient to provide effective blast protection for the crew. Although the barriers separating the Drill Floor from adjacent crew quarters met the standards of the IMO MODU Code, those specifications are only designed to slow the spread of fire, not to resist an explosion. They did not prevent personnel in the crew accommodations area from sustaining injuries.
- **Command and Control:** Because of a “clerical error,” by the Republic of the Marshall Islands, *DEEPWATER HORIZON* was classified in a manner that permitted it to have a dual-command organizational structure under which the OIM was in charge when the vessel was latched on to the well, but the master was in charge when the MODU was underway between locations or in an emergency situation. When the explosions began, however, there was no immediate transfer of authority from the OIM to the master, and the master asked permission from the OIM to activate the vessel’s EDS. This command confusion at a critical point in the emergency may have impacted the decision to activate the EDS.

### C. Key Recommendations

The JIT recommends that the IMO MODU Code be amended to:

- Include clear requirements for labeling and control of electrical equipment in hazardous areas and to require continued inspection, repair, and maintenance of such electrical equipment;
- Provide more detailed guidance for the design and arrangement of gas detection and alarm systems and to identify recommended automatic and manual emergency shutdown actions to be performed following gas detection in vital areas;
- Require that ventilation inlets for machinery spaces containing power sources be located as far as possible from hazardous locations; and

- Require an explosion risk analysis to determine whether the levels of protective barriers for a MODU's accommodation areas, escape paths and embarkation stations are adequate.

The JIT also recommends that the Commandant of the Coast Guard pursue regulatory changes to provide clear designation of the person in charge under both operating and emergency conditions for all MODUs operating on the U.S. Outer Continental Shelf (OCS).

## II. The Fire

As alarms sounded following the explosions, personnel assigned to *DEEPWATER HORIZON*'s firefighting team began to assemble at the designated staging area. With no electrical power, however, the MODU's fire pumps could not be started to supply water to the fire main and sprinkler system. The chief engineer tried to start the standby generator in order to bring one of the main generators on line to supply electrical power for the fire pumps. He was unsuccessful. The firefighting team soon concluded that fighting the fire would be futile. When it became apparent that there was no electrical power and the EDS had not disconnected the MODU from the well, the master made the decision to abandon ship.

*DEEPWATER HORIZON* was equipped with several firefighting systems, including (1) a fire main system, consisting of fire pumps to draw water from the sea and send it to hose stations, a single fire monitor (water cannon), and a "deluge system" for the area separating the drill floor from crew quarters; (2) a sprinkler system over the crew quarters and dining area; (3) a carbon dioxide fire extinguishing system to fight fires in key systems areas; and (4) a foam system to put out fires involving helicopters and their fuel. In addition, in certain critical locations, such as between the Drill Floor and crew quarters, *DEEPWATER HORIZON* used fire resistant bulkheads (barriers between sections of the MODU) designed to slow the spread of fire.

### A. Key Investigative Findings

- Because the fire main system depended exclusively on electric motor driven fire pumps, it was rendered useless when the explosions caused a total loss of power. Although the IMO MODU Code does not require the availability of a non-electric fire pump, this system vulnerability could have been addressed by having at least one diesel-powered fire pump.
- Without electricity to operate the fire pumps, and without being able to secure the source of fuel to the fire, the fire brigade members' decision not to attempt to fight the fire was reasonable.
- The crew's approach to fire drills may have influenced its lack of response to the fire. Given that drills were held at the same time and on the same day every week, that drilling personnel were excused from these exercises, and that records indicate that the crew was not treating fire drills as "the real deal," the routine, repetitive nature of the fire drills may have led to a degree of complacency among the crew members.

- The spread of the fire after the explosions was not limited by the “A-class bulkheads” (barriers) on *DEEPWATER HORIZON* and resulted in one of the visiting Transocean executives suffering serious burns. These barriers were never designed to stand up to explosions and the extreme heat of a hydrocarbon fire.

## **B. Key Recommendations**

The JIT recommends that the IMO MODU Code be amended to enhance fire safety on MODUs by:

- Requiring that MODUs have available a non-electrically powered fire pump to provide fire main pressure during a loss of electrical power;
- Requiring a fixed water deluge system to fight fires on or near the Drill Floor, which may automatically activate upon gas detection; and
- Requiring hydrocarbon fire-resistant bulkheads between the drilling area, adjacent accommodation spaces, and spaces housing vital safety equipment.

## **III. The Evacuation**

When the master (captain) gave the order to abandon ship, crew members assembled near the two lifeboats at the bow of *DEEPWATER HORIZON*. Although designated personnel sought to take a headcount prior to evacuation, they were unable to do so effectively because of confusion and panic. As debris fell around the crew, several crew members chose to jump overboard rather than wait for the lifeboats.

When the two lifeboats were launched, ten crew members were left behind. Because it was clear they could not safely reach the two remaining lifeboats at the opposite end of the MODU, the master elected to launch a liferaft. Because of intense heat and smoke, and crew fears that the raft would burn or melt, the liferaft was launched with only seven crew members aboard. Judging that there was not enough time to launch another liferaft, the master and two remaining crew members jumped over 50 feet into the water.

At the time of the explosions, the *DAMON B. BANKSTON*, an offshore supply vessel, was alongside *DEEPWATER HORIZON* to receive drilling mud to be transported ashore. After the first crew members jumped in the water, *DEEPWATER HORIZON* requested that *DAMON B. BANKSTON* launch its “fast rescue craft,” a small boat, which was then used to rescue the personnel who had jumped from the MODU and to tow the liferaft to safety. After the two lifeboats reached the *DAMON B. BANKSTON* safely, the first complete headcount since the explosions revealed that 115 personnel had successfully evacuated, but that 11 crew members were still missing.

## **A. Key Investigative Findings**

- The *DEEPWATER HORIZON* crew did not follow its own emergency procedures for notifying the crew of an emergency and taking steps to prepare for evacuation. For

example, contrary to standard procedure, the crew failed to sound the general alarm after two gas detectors activated. This failure may be attributable to the presence of the BP and Transocean executives onboard, which had also prevented key personnel from attending to the well control issues immediately prior to the blowout. A senior drilling crew member acknowledged that if he and the master had not been conducting a tour for the company executives, he would have been on the Drill Floor while key tests were being conducted.

- Although *DEEPWATER HORIZON* conducted a number of emergency drills, it never conducted drills on how to respond to a well blowout that leads to the need to abandon ship. In the confusion of the evacuation, no complete muster (headcount) of personnel was conducted onboard *DEEPWATER HORIZON*.
- The current lifeboat design and testing requirements do not adequately ensure the safe loading of a stretcher or permit adequate seating to accommodate the physical build of the average offshore worker today.
- The liferaft launch area had no effective barrier to shield it from the intense heat of the fire that threatened to incinerate the liferaft. Without a regulatory requirement to launch liferafts during evacuation drills, the crew struggled to launch the raft and failed to release a line connecting it to the MODU, which caused the raft to toss the occupants about and eject one crew member upon contact with the water.
- The evacuation of *DEEPWATER HORIZON* was substantially aided by the presence of the *DAMON B. BANKSTON* and the use of its “fast rescue craft,” which assisted at least 15 survivors. Although there was no regulatory requirement for a MODU to have a “standby vessel” at its side for safety purposes or to have its own fast rescue craft, the role of *DAMON B. BANKSTON* in saving lives demonstrates the value that such requirements could provide.

## B. Key Recommendations

The JIT recommends that the IMO MODU Code be amended to:

- Include the type, frequency, extent, randomness and evaluation criteria for all emergency contingency drills;
- Amend the Lifesaving Appliances (LSA) Code and its testing recommendations to ensure the adequacy of lifesaving appliance standards;
- Establish standards on the maximum allowable heat exposure for personnel at the muster stations and lifeboat/liferaft lowering stations; and
- Address the need for a fast rescue boat/craft onboard MODUs.

The JIT also recommends that the Commandant revise regulations to:

- Require the crew to practice launching liferafts during evacuation drills; and
- Establish designated standby vessels for MODUs engaging in oil and gas drilling activities on the U.S. OCS.

#### **IV. Flooding and Sinking**

During the two days following the explosions, the Coast Guard engaged in search and rescue efforts aimed at finding the 11 missing personnel. They were never found and are presumed to have died. During the same period, 11 different vessels arrived on scene to fight the fire on *DEEPWATER HORIZON* using fire monitors (water cannons). At the outset, there was little coordination of the firefighting efforts until SMIT Salvage Americas, a contractor engaged by Transocean, began to take charge late on April 21. With the large volumes of water applied to the fire, some portion of that water likely began to accumulate inside of, and migrated within, the hull. By the morning of April 22, as more openings became submerged, *DEEPWATER HORIZON* began taking on increasing amounts of water until at 1026, it sank.

##### **A. Causal Analysis**

- Although the exact cause of the loss of stability and sinking of *DEEPWATER HORIZON* cannot be determined based on the limited information available, possible factors include (1) damage to the MODU from the explosions and fire; (2) accumulation of water from firefighting efforts in the interior portions of the MODU, known as “downflooding”; and (3) migration of water within the MODU through watertight barriers that were damaged, poorly maintained, or left open by crew at the time of evacuation.
- Some amount of water from firefighting efforts remained onboard, increased the weight of the vessel, and reduced its stability. Although there is insufficient data to determine what percentage of such water remained onboard, a Coast Guard post-casualty stability analysis (Appendix L) revealed that the MODU’s displacement of water increased by an amount that was too great to have been caused by the shifting of loads onboard prior to the explosion.
- In the absence of the volume of firefighting water applied to *DEEPWATER HORIZON*, the MODU’s structure would likely have been exposed to more extreme heat, which could have expedited a catastrophic structural failure. It is therefore not possible to conclude that the water from the firefighting vessels accelerated its sinking.

##### **B. Key Investigative Findings**

- Prior to the explosions, *DEEPWATER HORIZON* was not in compliance with established requirements for maintaining the watertight integrity of its internal compartments. Audits in September 2009 and April 2010 found watertight integrity issues, one of which “directly affects the stability of the rig.” Faulty watertight closures could have accelerated progressive flooding on the MODU.



- Pursuant to its Search and Rescue Policy, the Coast Guard prioritized search and rescue efforts and thus did not take charge of, or coordinate, the marine firefighting effort. Such coordination did not occur until over 24 hours after the explosions, when Transocean's contractor, SMIT Salvage Americas, began to actively direct the firefighting efforts and seek to minimize downflooding. As a result, massive quantities of water were directed toward *DEEPWATER HORIZON* without careful consideration of the potential effects of water entering the hull.
- Transocean never developed a salvage plan for *DEEPWATER HORIZON*. The only document it generated, an introductory guidance document, did not designate a specific person on scene to direct response vessels and did not warn of the possible impact of downflooding on the stability and buoyancy of the MODU. The lack of a salvage plan with such information extended the amount of time *DEEPWATER HORIZON* was exposed to an uncoordinated firefighting effort.
- Although Transocean had a vessel response plan for *DEEPWATER HORIZON* that addressed an emergency or casualty that could have resulted in an oil spill. Transocean personnel engaged in the response were not familiar with the plan and deviated from it without appropriate justification when they selected a salvage company different from the one identified in the plan.
- During and after the casualty, Transocean did not have available loading information on *DEEPWATER HORIZON* at the time of the explosions. The lack of loading information prevented responders from assessing the damage to the MODU and determining the amount of time available until sinking. It also prevented investigators from determining the cause of the sinking.
- Contrary to the IMO MODU Code and the *DEEPWATER HORIZON* operations manual, Transocean failed to conduct a deadweight survey within the past five years to determine the weight of *DEEPWATER HORIZON*. This failure made it difficult for responders and investigators to evaluate the stability of the vessel.

### C. Key Recommendations

The JIT recommends that the Commandant:

- Review all organization policy on marine firefighting to ensure consistency;
- Extend current vessel response plan requirements for non-tank vessels to MODUs engaging in oil and gas drilling activities on the U.S. OCS;
- Evaluate regulatory requirements for MODUs engaging in oil and gas drilling activities on the U.S. OCS to, on a daily basis, relay their loading information ashore; and

- Update regulations to include a requirement to conduct a deadweight survey every five years for all (U.S. and foreign-flagged) MODUs conducting activities on the U.S. OCS.

## V. Safety Systems

The catastrophic well failure and explosions on *DEEPWATER HORIZON* represented a failure of the “maritime safety net” established to ensure safety on offshore drilling MODUs on the U.S. OCS. Multiple stakeholders are entrusted with ensuring safety. During day-to-day operations, Transocean (the vessel operator) had primary responsibility for ensuring the safety of *DEEPWATER HORIZON* and its personnel. RMI (the flag state) was responsible for conducting inspections to ensure *DEEPWATER HORIZON* met international standards and flag state regulations. RMI delegated these duties to two “recognized organizations,” American Bureau of Shipping (ABS) and Det Norske Veritas (DNV). Finally, the Coast Guard (the coastal state), relying heavily on the flag state’s oversight of its vessels, conducted limited safety examinations to assess whether the vessel was in substantial compliance with U.S. laws and regulations.

This “maritime safety net” system, however, failed to prevent this disaster. The investigation revealed that *DEEPWATER HORIZON* and its owner, Transocean, had serious safety management system failures and a poor safety culture. It has also shown that RMI’s oversight of safety issues was inadequate and created an environment in which the casualty could occur. These failures have exposed the weaknesses of a regulatory scheme in which the U.S. Coast Guard is called upon to conduct only limited oversight of foreign-flagged vessels engaged in OCS activities.

### A. Transocean

The investigation has shown that over a period of years and in the time immediately before the casualty, Transocean amassed numerous deficiencies in the area of safety, including:

- **International Safety Management Code Violations:** Both Transocean and *DEEPWATER HORIZON* were required to have a safety management system that complied with the ISM Code, the purpose of which is to ensure safety at sea, prevent injury or loss of life, and avoid damage to the environment. The investigation, however, determined that Transocean had a history of ISM Code violations on *DEEPWATER HORIZON* and other vessels.
- **Poor Maintenance Record:** Two recent audits of *DEEPWATER HORIZON* found numerous maintenance deficiencies that could impact safety, including problems with firefighting, electrical, and watertight integrity systems. In particular, the audits found that, contrary to the manufacturer’s guidelines which called for inspection and certification of the blowout preventer (BOP) every three to five years, Transocean did not arrange to have the *DEEPWATER HORIZON* BOP recertified for over ten years. In addition, key BOP parts had “significantly surpassed the recommended recertification period” and needed to be replaced.

- **History of Safety Incidents:** In 2008, *DEEPWATER HORIZON* had two significant incidents which could have seriously affected the safety of the vessel or the environment – a loss of power that jeopardized the MODU’s ability to maintain its position above the well and the flooding of a compartment resulting from a failure to close valves. Neither of these incidents was properly investigated and addressed.
- **Crew Training and Knowledge:** Transocean failed to ensure that its onboard management team and crew had sufficient training and knowledge to take full responsibility for the safety of the vessel. The master acknowledged that the training he received on the Safety Management System consisted of viewing a PowerPoint presentation the content and whereabouts of which he was unable to recall. The master was not aware that he had the authority to activate the Emergency Disconnect System, a critical step to cut off the flow of flammable gases to the MODU, and the official who received gas alarms was unaware of procedures relating to the activation of the emergency shutdown system in response to such alarms, even though shutting down the engines could have averted an explosion.
- **Emergency Preparedness:** Transocean failed to require that systems and personnel emphasize maximum emergency preparedness. As discussed above, Transocean allowed the *DEEPWATER HORIZON* crew to inhibit or bypass gas alarms and automatic shutdown systems, and it did not require robust emergency drills.

Collectively, this record raises serious questions whether Transocean’s safety culture was a factor that contributed to the disaster.

## B. Flag State

The Republic of the Marshall Islands (RMI) failed to ensure that *DEEPWATER HORIZON* was in compliance with all applicable requirements, including those relating to the electrical installations in hazardous zones, degradations in watertight integrity, crew training, emergency preparedness, and others. RMI entrusted all flag state duties to ABS and DNV, and did not conduct sufficient oversight of those classification societies to detect mistakes. This incident raises serious questions about the regulatory model under which a flag state may rely entirely on classification societies to do its inspection and investigative work.

## C. Coast Guard

The Coast Guard conducted limited safety examinations of *DEEPWATER HORIZON* in 2008 and 2009, but did not identify safety concerns. Given the flag state’s oversight deficiencies, the Coast Guard’s regulatory scheme, which defers heavily to the flag state to ensure the safety of foreign-flagged MODUs, is insufficient. Among the system’s weaknesses is that under Coast Guard regulations:

- A foreign-flagged MODU is only required to undergo a Coast Guard safety examination, a much less rigorous review than a Coast Guard inspection of a U.S.-flagged MODU.

- A foreign-flagged MODU is only required to report to the Coast Guard incidents resulting in death or serious or numerous injuries, but not other accidents or mechanical failures that could affect the vessel's seaworthiness or fitness for service.

#### **D. Key Recommendations**

The JIT recommends that the Commandant:

- Require and coordinate expanded ISM Code examinations of all Transocean vessels that are subject to the ISM Code and that engage in oil and gas drilling activities on the U.S. OCS;
- Work with the RMI to require an immediate annual verification of the safety management system of the main and North American offices of Transocean;
- Develop more comprehensive inspection standards for foreign-flagged MODUs operating on the U.S. OCS and a risk-based program to provide additional Coast Guard oversight of such vessels;
- Work with the IMO to evaluate the need to require flag states to audit classification societies acting on their behalf as a Recognized Organization and to develop a code of conduct for Recognized Organizations; and
- Make marine casualty reporting requirements for foreign-flagged MODUs operating on the U.S. OCS consistent with the requirements for U.S.-flagged MODUs.

This section describes the events onboard the mobile offshore drilling unit (MODU) *DEEPWATER HORIZON* on April 20, 2010 from 2100 hours local time to the secondary explosion at 2150. It provides an overview of the preliminary indications and warnings of well control problems leading up to the explosion; a description of the introduction of hydrocarbons onto the MODU; discussion of possible ignition sources, emergency power systems, fire and gas detection systems, crew blast protection systems and their failure; discussion of actions and decisions that may have increased the likelihood or impact of the explosions; and a description of government and third party oversight of vessel inspection and survey.

### I. Overview

#### A. The Explosions and Emergency Disconnect System Activation

On April 20, the crew began the temporary well abandonment<sup>2</sup> process by running tests to determine the integrity of the well, following procedures sent to the MODU by a BP drilling engineer that morning.<sup>3</sup> The crew first conducted a positive pressure test to determine whether the well casing could sustain pressure exerted on it from the inside by the well formation and received satisfactory results.<sup>4</sup> During the afternoon of the April 20, the crew pumped mud up from the well and onto the *DAMON B. BANKSTON*, an offshore supply vessel working at Macondo.

Next, crew members turned to conducting a negative test, which would give the crew indications whether the final cement job was capable of keeping hydrocarbons out of the well. The first negative test gave uncertain results, so the decision was made to run a second negative test.<sup>5</sup> Shortly before 2000, both the Transocean crew and the BP well site leader on the MODU concluded that the second negative test was successful, indicating that the final cement job was satisfactory.<sup>6</sup> After moving mud between various mud pits, the crew opened the blowout preventer (BOP) and pumped seawater down the drill pipe to displace mud and a spacer out of the riser. Although there were changes in drilling pressure while these well activities were continuing, personnel monitoring the well did not recognize these changes to be a sign of a “well kick,” a problematic influx of fluids into the wellbore.

From approximately 2100 to 2150 hours, however, the drilling crew observed abnormal pressures on the drill pipe and began initiating steps to shut in the well and divert flow to the mud gas separator (MGS). At 2150, the assistant driller called the senior toolpusher and informed him that “we have a situation ... [t]he well is blown out ... [w]e have mud going to the

---

<sup>2</sup> Definitions of drilling terms can be found at <http://www.boemre.gov/glossary/> or [http://www.osha.gov/SLTC/etools/oilandgas/glossary\\_of\\_terms/glossary\\_of\\_terms\\_a.html](http://www.osha.gov/SLTC/etools/oilandgas/glossary_of_terms/glossary_of_terms_a.html).

<sup>3</sup> BP –HZN-MBI-000021237.

<sup>4</sup> BP-HZN-MBI-00136947.

<sup>5</sup> Testimony ██████████ 5/27/2010 pp 26-27.

<sup>6</sup> Testimony ██████████ 5/27/2010 pp 90-91; Testimony ██████████ 5/28/2010 p 247.

crown.”<sup>7</sup> When asked if the well was shut in, the on-watch assistant driller advised that the on-watch toolpusher was doing so.<sup>8</sup>

At approximately 2150, the on-watch dynamic positioning officer (DPO) in the Central Control Room/Bridge (CCR)<sup>9</sup> felt the MODU jolt.<sup>10</sup> A series of alarms indicating the presence of flammable gas on the Drill Floor and in the Shale Shaker House appeared on the main fire and gas detection system control panel.<sup>11</sup> The on-watch senior dynamic positioning officer (SDPO) tried to investigate by repositioning the closed circuit television system (CCTV) video monitor (Camera 6) to focus in the starboard aft direction. He observed drilling mud being ejected onto the Drill Floor, but was unable to determine its source.<sup>12</sup> At this time, the on-watch DPO received a call from the Drill Floor informing her of a “well control situation.”<sup>13</sup> Immediately after, the first explosion occurred and the on-watch SDPO observed flames on the CCTV, but was again unable to determine their source. Additional gas alarms activated, indicating the presence of flammable gas in the Shale Shaker House. The on-watch SDPO attempted to call the Shale Shaker House to warn personnel, but there was no answer.<sup>14</sup> At about the same time, the on-watch DPO received a call from the Engine Control Room (ECR) inquiring into the events onboard.<sup>15</sup> At about the same time, the MODU suffered a second more violent explosion and fire and a loss of electrical power.<sup>16</sup> The Bridge crew was unable to rapidly determine the source of the explosion or the extent of the fire. As the event was unfolding, the chief mate arrived in the CCR; he reported that the fire was not controllable and advised the master that the MODU should be abandoned.<sup>17</sup>

Following the first explosion, the crew on watch in the CCR began taking actions to ascertain the status of the thrusters, which were needed to move off the well site to a safe location if the emergency disconnect system (EDS) was activated.<sup>18</sup> The on-watch SDPO was unable to confirm the operability of the dynamic positioning system (DPS) because he was receiving a position drop-out.<sup>19</sup> However, he was able to evaluate the trends of the MODU’s pitch and roll as well as the vessel’s draft to determine that the vessel was not listing.<sup>20</sup> At the same time, the

---

<sup>7</sup> Testimony █████ 5/28/2010 pp 283.

<sup>8</sup> *Id.*

<sup>9</sup> For additional information on the facilities and features of *DEEPWATER HORIZON* referenced throughout the report, and their specific location on the MODU and in relation to each other, see the descriptions and maps/floor plans contained in Appendix E.

<sup>10</sup> Testimony █████ 10/5/2010 p 13.

<sup>11</sup> Testimony █████ 10/5/2010 p 13.

<sup>12</sup> *Id.*; Testimony █████ 10/5/2010 p 150.

<sup>13</sup> Testimony █████ 10/5/2010 p 150.

<sup>14</sup> Testimony █████ 10/5/2010 pp 150-151.

<sup>15</sup> Testimony █████ 10/5/2010 pp 13-14.

<sup>16</sup> Testimony █████ 10/5/2010 p 151; Testimony █████ 10/5/2010 pp 13-14.

<sup>17</sup> Testimony █████ 10/5/2010 p 19.

<sup>18</sup> The Emergency Disconnect System (EDS) is a critical safety system that is intended to allow personnel to disengage the MODU from the well. It is operated in emergencies to disconnect the drill pipe from the well, allowing the MODU to move away from the well site.

<sup>19</sup> Testimony █████ 10/5/2010 pp 240-241. A position drop-out occurs when the MODU’s Global Positioning Systems (GPS) reference systems are no longer working. In this instance, the SDPO believed that three of the MODU’s positioning antennae located on top of the crown of the derrick were damaged by the fire in the derrick, and thus could not accurately determine the position of the MODU.

<sup>20</sup> Testimony █████ 10/5/2010 p 152.

on-watch DPO called up a series of thruster menus on her control console, which showed numerous alarms, indicating that the thrusters were not available.<sup>21</sup>

Shortly thereafter, the on-watch subsea supervisor arrived in the CCR and advised the master, “I’m EDSing.” The master responded, “No, calm down. We’re not EDSing.” The on-watch subsea supervisor proceeded to the EDS panel. The on-watch well site leader standing by the EDS panel told the subsea supervisor, “They got the well shut in.”<sup>22</sup> The on-watch subsea supervisor observed a number of alarms flashing. He then told the on-watch well site leader “I’m getting off here,” to which the on-watch well site leader responded “Yeah, hit the button.” The on-watch subsea supervisor activated the EDS and observed on the panel what appeared to be a proper sequence of operation; however, he then determined that the signal never left the control panel because no hydraulic power was available.<sup>23</sup>

Approximately five minutes later, the offshore installation manager (OIM) arrived in the CCR. The master asked and received permission from the OIM to EDS.<sup>24</sup> The master then told the on-watch subsea supervisor to EDS; the subsea supervisor responded, “I already hit it.”<sup>25</sup>

## B. Origin of the Explosions

Although the exact cause and origin of the explosions and fire cannot be definitively established, crew testimony identified two locations from which the explosions and fire may have started, one on or near the Drill Floor and a second on or near Engine Room #3. There is conclusive testimony that two explosions occurred along with a loss of electrical power; however, the testimony conflicts on the order in which the three events occurred. As the discussion below shows, the loss of electrical power is the key indicator of the sequence of events, and likely was caused by the second explosion damaging the electrical power distribution and control equipment in the switchgear rooms and ECR adjacent to the Engine Room # 3.

### 1. Drill Floor

Personnel in a position to see the main deck and Drill Floor of *DEEPWATER HORIZON* reported that they saw drilling mud and other liquids discharging first from somewhere on the Drill Floor, and then from the top of the derrick located on the Drill Floor.<sup>26</sup> Drilling mud and other liquids then discharged from the area of the MGS gooseneck vent on the starboard aft side of the derrick.<sup>27</sup>

The portside crane operator testified that after the initial discharge of drilling mud from the top of the derrick, he saw drilling mud coming from the MGS vent, followed by the first explosion:

---

<sup>21</sup> Testimony [REDACTED] 10/5/2010 pp 44-45.

<sup>22</sup> Testimony [REDACTED] 5/28/2010 p 123.

<sup>23</sup> Testimony [REDACTED] 5/28/2010 p 123.

<sup>24</sup> Testimony [REDACTED] 8/26/2010 p 440; Testimony [REDACTED] 10/5/2010 pp 21, 26.

<sup>25</sup> Testimony [REDACTED] 5/28/2010 pp 144-145.

<sup>26</sup> Testimony [REDACTED] 5/29/2010 p 144; Testimony [REDACTED] 5/11/2010 pp 98-99; Testimony [REDACTED] 5/29/2010 p 9;

Testimony [REDACTED] 5/11/2010 p 136.

<sup>27</sup> Testimony [REDACTED] 5/29/2010 p 10; Testimony [REDACTED] 5/11/2010 p 243.

“And it come out of it so strong and so loud that it just filled up the whole back deck with a gassy smoke.....Then something exploded. I’m not sure what exploded, but just looking at it, it was where the degasser was sitting, it’s a big tank and it goes into a pipe. I’m thinking that the tank exploded. And that started the first fire, which was on top of the motor shed and on the starboard side of the derrick.”<sup>28</sup>

The crane operator stated that his first action after the explosion was to turn off the air conditioner in the cab of the crane because he was concerned that the gas he observed was flammable,<sup>29</sup> which indicates that electrical power was still available at that time. He then stated that “about that time everything in the back just exploded at one time. It went -- the whole back deck.”<sup>30</sup>

The crew members on board *DAMON B. BANKSTON* also had a good view of the derrick and testified that the first explosion was on the main deck area aft of the derrick, on or near the Drill Floor:

*Captain* [REDACTED] “I was stationed on the center console steering the boat and through the support window. The green flash was coming from the main deck area aft of the derrick....The height of my vessel is pretty much even with the main deck of the *HORIZON*.”<sup>31</sup>

\*\*\*

*Chief Mate* [REDACTED] “My recollection was that it was about amidships aft. I saw an eruption of liquid that looked like seawater. It didn’t look brown as mud coming up out of the deck. It was a pretty heavy eruption of liquid because it was higher than the eight-foot high containers that were on deck. I could see the liquid boiling out of the deck and shortly after that, a flash of fire on top of the liquid above it and it continued to burn.”

Q. So kind of in the derrick area?

A: Yes, sir, aft of the derrick center, [a]midships center.<sup>32</sup>

\*\*\*

*Chief Engineer* [REDACTED] “I saw a small explosion behind the aft of the derrick.”<sup>33</sup>

The on-watch SDPO testified that from his vantage point on the bridge, he was observing the Drill Floor through the CCTV system when the first explosion occurred. He was unable to see from where the explosion had originated, but he did see flames. Following the first explosion, he testified that a number of gas alarms were received on the fire and gas detection system control

---

<sup>28</sup> Testimony [REDACTED] 5/29/2010 pp 10-11.

<sup>29</sup> Testimony [REDACTED] 5/29/2010 p 11.

<sup>30</sup> *Id.*

<sup>31</sup> Testimony [REDACTED] 5/11/2010 p 137.

<sup>32</sup> Testimony [REDACTED] 5/11/2010 p 243.

<sup>33</sup> Testimony [REDACTED] 5/11/2010 p 183.



panel just “before that generator exploded.”<sup>34</sup> When asked what led him to believe that the second explosion was the generator exploding, he replied “Because the rig blacked out.”<sup>35</sup>

## 2. Engine Room

According to personnel located in the ECR and the adjacent Electronics Technician Room on the second deck (below the main deck) at the time of the explosions, Engines # 3 and # 6 increased in rpm just prior to the explosion. They believed that the explosion came from Engine Room # 3, since Engine # 3 was located on the port side of the ECR, and the first explosion forced inward the port side door to the ECR. Another explosion, coming from the direction of Engine # 6, caused the starboard door into the ECR to forcibly open inward.<sup>36</sup>

The chief electrician testified that damage he observed while evacuating from the ECR to the aft part of the MODU indicated that the explosion involved Engine # 3.

“At that point I looked up at the wall, and the exhaust stacks for Engine Number 3, the wall, the handrail, the walkway, all those things were missing. They were completely blown off the back of the rig.”<sup>37</sup>

The chief mechanic reported similar observations.

“Well, the first explosion basically came from the port side in the direction that Number 3 engine is located at, and plus, when we went back out on the aft lifeboat deck, there was damage coming from the back of Engine Room 3.”<sup>38</sup>

As a result of the explosions and fire, 11 persons were reported missing and are presumed dead. 16 persons reported sustaining injuries either during the initial explosions or during the evacuation process. The locations of the presumed dead and injured crew members are summarized in Table 1.

Table 1 – Locations of Missing and Injured Crew Members

Missing	Employer	Position	Last Known Location On <i>DEEPWATER HORIZON</i>
Anderson, Jason	Transocean	Toolpusher	Drill Floor
Burkeen, Aaron	Transocean	Crane Operator	Crane Deck
Clark, Donald	Transocean	Assistant Driller	Mud Pump Room
Curtis, Stephen	Transocean	Assistant Driller	Mud Pump Room
Jones, Gordon	MI Swaco	Mud Engineer	Shaker House

<sup>34</sup> Testimony [REDACTED] 10/5/2010 p 168.

<sup>35</sup> Testimony [REDACTED] 10/5/2010 pp 220-221.

<sup>36</sup> Testimony [REDACTED] 5/26/2010 p 97; Testimony [REDACTED] 5/29/2010 pp 32-33; Testimony [REDACTED] 7/23/2010 pp 14-15; Testimony [REDACTED] 5/28/2010 pp 341-342.

<sup>37</sup> Testimony [REDACTED] 7/23/2010 p 16.

<sup>38</sup> Testimony [REDACTED] 5/26/2010 p 130.

<b>Missing</b>	<b>Employer</b>	<b>Position</b>	<b>Last Known Location On <i>DEEPWATER HORIZON</i></b>
Kemp, Roy	Transocean	Derrick Hand	Mud Pump Room
Kleppinger, Karl	Transocean	Floorhand	Drill Floor
Manuel, Blair	MI Swaco	Mud Engineer	Shaker House
Revette, Dewey	Transocean	Driller	Drill Floor
Roshto, Shane	Transocean	Floorhand	Drill Floor
Weise, Adam	Transocean	Floorhand	Mud Pump Room
<b>Injured</b>	<b>Employer</b>	<b>Position</b>	<b>Location</b>
██████████	Transocean	Chief Mechanic	Engine Control Room
██████████	Art Catering	Bedroom Utility	Stairway between 2 <sup>nd</sup> & 3 <sup>rd</sup> Deck
██████████	Art Catering	Baker	Galley
██████████	Transocean	Floorhand	2 <sup>nd</sup> Deck Gym
██████████	Transocean	Roustabout	Portside Crane
██████████	Art Catering	Cook	Hallway outside Galley
██████████	Transocean	1 <sup>st</sup> Assistant Engineer	Engine Control Room
██████████	Transocean	Motor Operator	Engine Control Room
██████████	Art Catering	Galley Hand	Hallway outside Galley
██████████	Art Catering	Galley hand	Galley
██████████	Art Catering	Laundry	Laundry
██████████	Transocean	Motor Operator	Engine Control Room
██████████	Transocean	Division manager	2 <sup>nd</sup> deck outside OIM Office
██████████	Art Catering	Laundry	Room 239
██████████	Transocean	Toolpusher	2 <sup>nd</sup> deck near Toolpusher's Office
██████████	Transocean	Chief Electronics Technician	Engine Control Room

\* Denotes injury occurred while en route to or boarding lifeboat.

## II. Systems

As the well control incident unfolded, an uncontrolled volume of gas flowed up from the wellhead to the MODU and onto the Drill Floor and main deck. Gas samples collected by Woods Hole Oceanographic Institute on July 27, 2010 show that the composition of the uncontrolled gas discharged from the well was primarily methane (69.9 %), with lesser amounts of ethane (6.9 %) and propane (4.5 %). The remainder of the gas consisted of a mixture of various weight hydrocarbons.<sup>39</sup> The flammable range of the gas is estimated to be from 5-14% by volume.

<sup>39</sup> Analysis Report, Isotech Laboratories dated 8/2/2010 Sample #s WHOI-IGT6 and WHOI-IGT8.

Several minutes after the start of the release of gas from the wellhead, a gas cloud within the flammable range formed over large areas on several decks. The explosions likely occurred when gas from this cloud encountered one or more ignition sources on the Drill Floor or elsewhere on the MODU. The precise location of the ignition sources that caused the two explosions cannot be definitively established. The investigation, however, has identified several possible ignition sources. The possible sources that are best supported by the evidence are:

- **Hazardous Area Electrical Sources:** Flammable gas may have been ignited by unguarded electrical equipment in hazardous areas on or near the Drill Floor. (see additional discussion below)
- **Main Engines:** Flammable gas may have traveled through ventilation inlets to one of the main engines, which ignited the gas. (see additional discussion below)
- **Switchgear Room Electrical Equipment:** Personnel located in the ECR testified conclusively that they experienced blast forces that destroyed the bulkheads, deck, overhead surfaces, and the exterior bulkhead of switchgear room number three.<sup>40</sup> This indicates that flammable gases may have traveled through a ventilation inlet system (located on the aft main deck, amidships) to that switchgear room and reached unguarded electrical equipment in the 11 kV switchboard compartments, the 480 V switchboard rooms (located adjacent the ECR, port and starboard) or any of the switchgear rooms located behind each engine.

Additional possible ignition sources include:

- **Temporary Electrical Circuits:** Another potential ignition source could have been temporary electrical circuits installed in hazardous areas on the Drill Floor to support current operations.
- **Mechanical Sources:** The Drill Floor had numerous mechanical sources of ignition that could have caused the explosions, such as friction from rotating shafts and the winches on the port and starboard cranes. An April 2010 ModuSpec USA, Inc. audit commissioned by Transocean (Section 4.4) found that the port forward air winch wire was rubbing against a steel plate on the lower derrick level, and recommended the installation of a guide roller, or removal of the plate.<sup>41</sup> It is not known if this condition had been corrected at the time of the explosion.
- **Non-Hazardous Area Sources:** If the flammable gas cloud dispersed beyond the hazardous areas on the rig to other deck levels with unclassified equipment, then an untold number of ignition sources could have sparked an explosion. For example,

---

<sup>40</sup> Testimony [REDACTED] 5/26/2010 p 97; Testimony [REDACTED] 5/29/2010 pp 32-33; Testimony [REDACTED] 7/23/2010, pp 14-15; Testimony [REDACTED] 5/28/2010 pp 341-342.

<sup>41</sup> ModuSpec USA Inc. Rig Condition Assessment of the *DEEPWATER HORIZON* 4/11-14/2010, TRN-USCG\_MMS-00038609 to 95.

ventilation fans for non-hazardous spaces were not of non-sparking construction and could have been an ignition source.<sup>42</sup>

- **Electrostatic Discharge:** The gas could have been ignited without an onboard ignition source, but instead by an electrostatic discharge from the high velocity flow of flammable liquids and gases being released from the well head.<sup>43</sup>

The following sections will discuss the main systems relating to the cause or effects of the explosions and how they performed or failed to perform during the casualty.

#### A. Drill Floor Ignition Source Safeguard Systems

To the extent that the explosion may have originated on the Drill Floor, the most likely source of ignition would be electrical equipment located there. Because the hazardous areas of a MODU may be exposed to flammable vapors in the course of normal operations, electrical equipment installed in these areas must either prevent ignition of such vapors or safely contain any ignited vapors.

*DEEPWATER HORIZON* was constructed in accordance with the 1989 International Maritime Organization (IMO) Mobile Offshore Drilling Unit (MODU) Code. Chapter 6 of the Code classifies hazardous areas into three categories. Zone 0 areas are those where explosive gas/air mixtures are normally present. Zone 1 areas are those where explosive gas/air mixtures are likely to occur in normal operation. Zone 2 areas are those where explosive gas/air mixtures are not likely to occur, but if they do occur, they are expected to be present for only a short period of time. For each type of hazardous area, all installed electrical equipment is to be certified as suitable for the explosive gas/air mixtures that may be encountered.

On *DEEPWATER HORIZON*, the Drill Floor at elevation 46 m (151 ft) was classified as a Zone 2 area. All electrical equipment in this area was classified safe for such a location except for the electrical equipment in the Drill Shack, the Drilling Equipment Room (DER), and the mud logging and the measurement while drilling (MWD) units. These areas were not equipped with classified electrical fixtures, but were maintained under positive pressure in accordance with safeguard 3, explained below. All other areas on the Drill Floor that were within the wind walls and intermediate levels of the Moon Pool<sup>44</sup> directly beneath the Drill Floor from elevation 33 m (108 ft), up to the drawworks blowers on the starboard side, and up to approximately elevation 66 m (216 ft) on the port side, were classified as either Zone 1 or Zone 2 areas. In addition, the mud gas separator (MGS) vent at the very top of the derrick was classified as a Zone 1 area for a distance of 1.5 m (4.9 ft) from the outlet, and as a Zone 2 area for an additional 1.5 m (4.9 ft) beyond that point. The extent of the electrically classified areas is shown in yellow in Figures 2 through 5.

---

<sup>42</sup> *DEEPWATER HORIZON* Operations Manual March 2001 Section 9.1.1, ABSDWH000533.

<sup>43</sup> Fire Protection Handbook, National Fire Protection Association, Quincy, MA, 19<sup>th</sup> ed., p 210.

<sup>44</sup> The *Oil Gas Glossary* defines a "Moon Pool" as : a walled round hole or well in the hull of a drill ship (usually in the center) through which the drilling assembly and other assemblies pass while a well is being drilled, completed, or abandoned from the drillship.

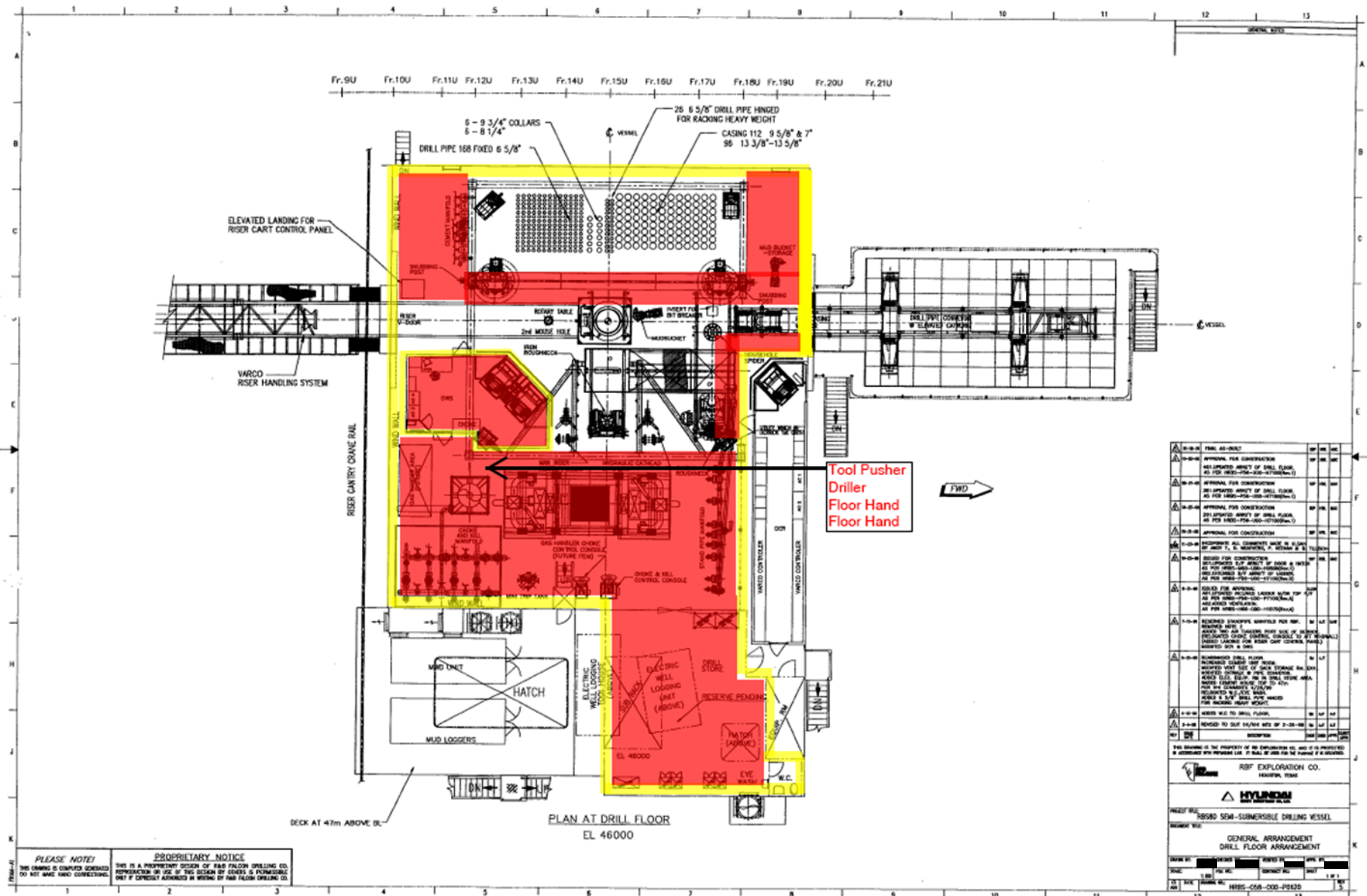

Figure 2 – Drill Floor Plan



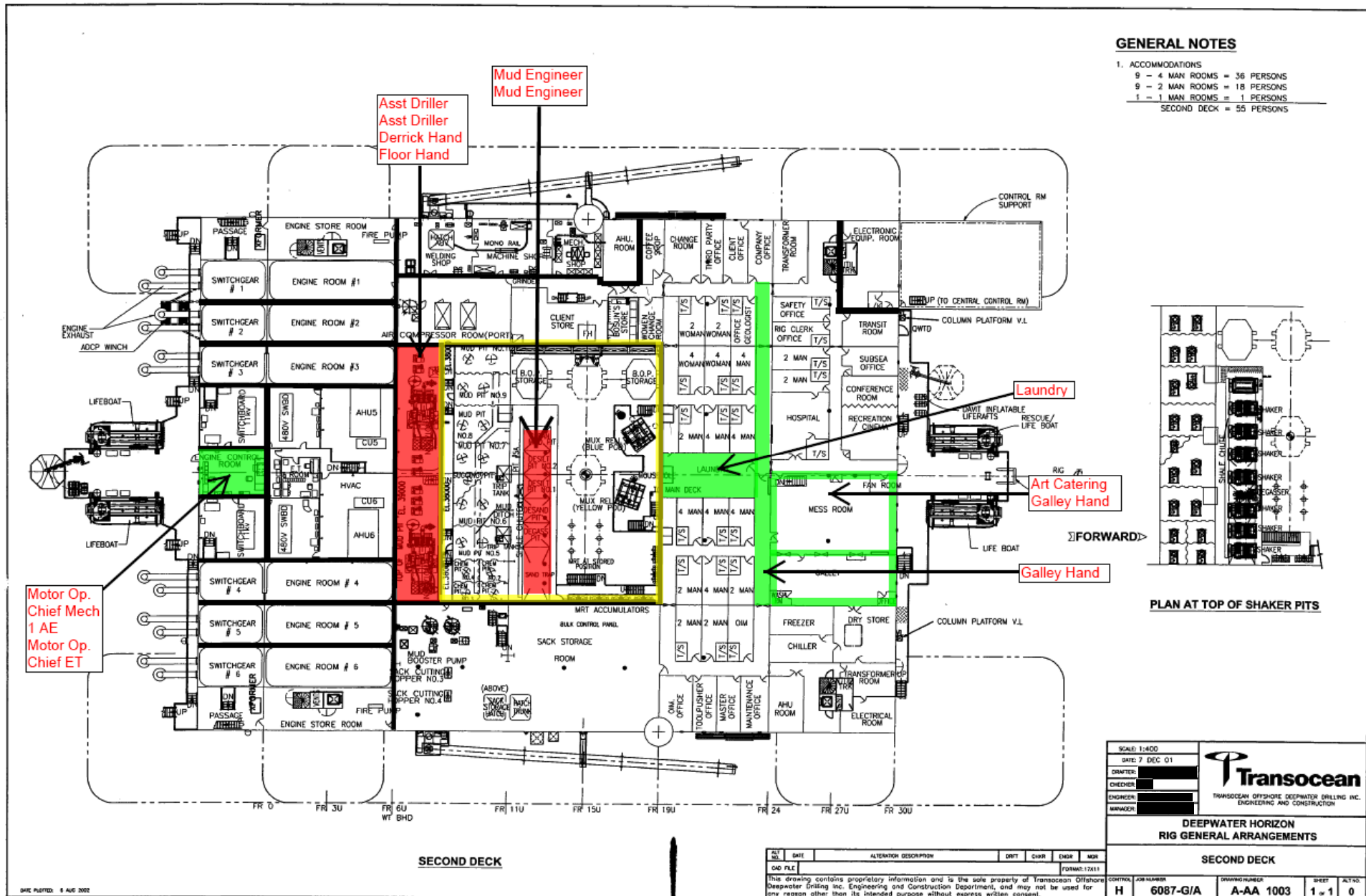

Figure 4 – Second Deck

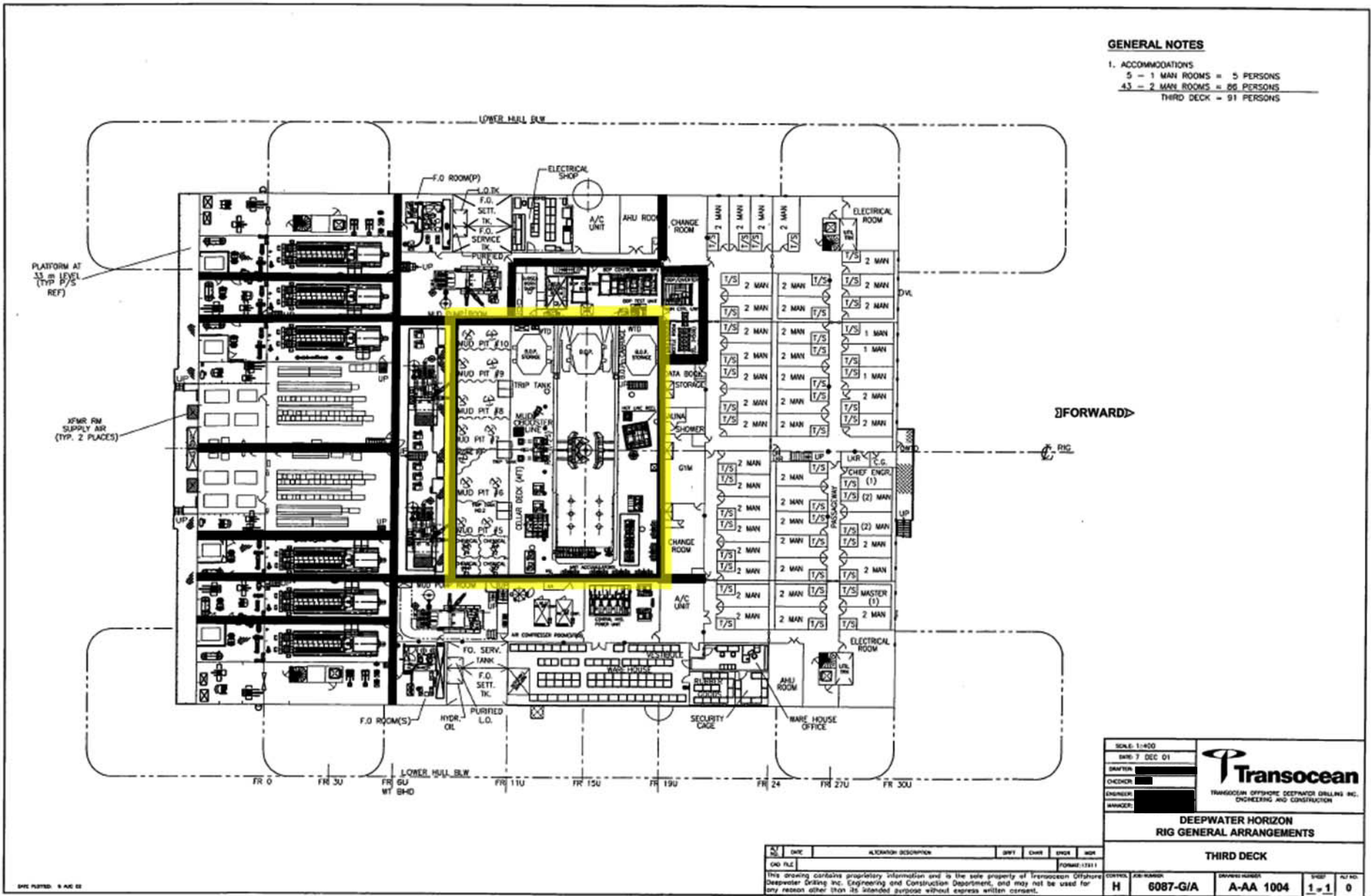

Figure 5 – Third Deck



Electrical equipment in designated hazardous areas must be subject to one of three safeguards: it must be contained in explosion-proof enclosures, be intrinsically-safe, or be purged and pressurized:

- **Explosion-proof enclosures** are robust housings built to contain electrical equipment and prevent contact with flammable gases. If such gases leach into the enclosure and are ignited by a spark, they remain contained within the enclosure and are cooled during venting so as to prevent any ignition of the gases outside of the enclosure.
- **Intrinsically-safe equipment** is low energy electrical equipment that does not have sufficient energy to ignite flammable gases, even if a spark occurs.
- **Purged and pressurized equipment** consists of electrical equipment that is contained within enclosures supplied with fresh air from a safe location at a pressure higher than the pressure of the surrounding area. Because of the pressure differential within and outside the enclosure, flammable gas cannot leach into the enclosure and therefore cannot be ignited by the equipment.

*DEEPWATER HORIZON* was designed in accordance with the 1989 IMO MODU Code requirements, and proper electrical equipment was originally installed in the hazardous areas. On the MODU, the use of properly maintained and certified explosion-proof, intrinsically-safe, or purged and pressurized equipment on the Drill Floor should have prevented the ignition of flammable gases by any electrical equipment installed in the hazardous area. If poorly maintained, however, such equipment could have provided an ignition source for flammable gases. The IMO MODU Code, however, does not contain any requirements for the continued control and maintenance of electrical equipment in hazardous areas.

Investigative findings concerning *DEEPWATER HORIZON*'s failure to properly maintain electrical equipment are discussed in Section 3 of this Chapter.

## **B. Main Engine Room Ignition Source Safeguard Systems**

Another possible ignition source for the explosion was one of the main engines. Certain crew members testified that the explosion originated with Engine #3. At the time of the casualty, Engines # 3 and # 6 and their associated generators were supplying electrical power to the MODU. The other four generators were kept in a reserve mode. In the case of a fault or loss of power, one of the reserve generators would automatically start up and function as the emergency power source.

To the extent that the explosion initiated with an engine, the ventilation inlets for the engine rooms may have allowed the flammable gas cloud to travel to the main engines located aft of the Drill Floor. Because each of the six Wärtsilä diesel engines did not have (and were not required to have) independently ducted combustion air vents, the engines drew combustion air from the air supplied to the individual engine rooms by the ventilation inlets.

The ventilation inlets for Engine Rooms # 3 and # 4 were located together on the main deck, amidships under the aft deck catwalk and next to the ventilation inlets for the Mud Pump Rooms. The ventilation inlets for Engines # 5 and # 6 were located on the starboard side of the main deck, aft, outboard of the riser storage area. The ventilation inlets for Engines # 1 and # 2 were located on the port side of the main deck, aft, outboard of the riser storage area. According to the chief mechanic, the ventilation inlets for Engine Room # 3 were located within approximately 4.5 m (15 ft) to 6.1 m (20 ft) of the Drill Floor, while the ventilation inlets for Engine Room # 6 were located approximately 7.6 m (25 ft) to 10.7 m (30 ft) from the Drill Floor.<sup>45</sup>

Gas detectors were installed in the ventilation inlets. Upon gas detection, they would activate an audible and visible alarm at the fire and gas detection system control panel in the CCR, but they were not set to automatically activate the emergency shutdown (ESD) system for the engines or close the engine room ventilation dampers to stop the flow of outside air into the engine rooms.

If flammable gases entered Engine Rooms # 3 and # 6 through the vents, they may have contacted numerous unguarded electrical sources of ignition, since the engine rooms were not classified as Zone 1 or Zone 2 hazardous areas. The gases could also have caused an increase in rpm of the engines. If an engine were to “overspeed” in this manner, it may have led to a catastrophic mechanical failure and caused the ignition of the flammable gas when it came in contact with hot metal fragments, triggering an explosion.

Each of the six Wärtsilä diesel engines had three separate safety devices designed to prevent the engine from overspeeding:

- **Diesel Engine Speed Measuring System:** Each engine is outfitted with a Diesel Engine Speed Measuring System (DESPEMES) that provides a hardwire logic signal to the Simrad Integrated Automated Control System (IACS). The IACS uses this signal to determine if the engine is operating within its design specification. If the IACS receives a signal from the DESPEMES that the engine speed has risen 13% above the normal operating speed, it sends a signal to an electro-pneumatic overspeed trip device and the air charge cut off valves. This action will cut both the fuel and air supply to the engine, resulting in an engine shutdown.<sup>46</sup>
- **Woodward Governor/Actuator:** Should the DESPEMES fail to detect an overspeed condition and the engine reaches a speed 15% above its normal operating speed, then the engine’s Woodward 723 governor<sup>47</sup> is programmed to send a signal to the governor/actuator to move the fuel rack to zero and send a shutdown signal to the IACS system.
- **Mechanical Overspeed Trip Device:** Finally, if the engine still continues to overspeed and reaches 18% above its normal operating speed, a direct-acting mechanical overspeed

---

<sup>45</sup> Testimony ██████████ 5/26/2010 p 101.

<sup>46</sup> Wärtsilä North America Written Submission to JIT 10/14, 2010 (forwarding details of the Wärtsilä Vasa 32 engines).

<sup>47</sup> A governor is a mechanical safety device installed on internal combustion engines to automatically limit the speed of the engine by regulating the intake of fuel or similar means.

trip device, independent of the Woodward governor and DESPEMES systems, automatically stops the engine. The mechanical overspeed trip device is a centrifugal force-tripping mechanism fastened to the engine camshaft. Once the device reaches its set point, it will move the entire fuel rack to the zero position and notify the IACS of a shutdown.<sup>48</sup>

In addition, the engine's air charge cut-off valves provide another safety mechanism against overspeeding. The valves are designed to close in an emergency situation to prevent flammable gases from entering the diesel engine and ensure that the engine will not overspeed. The valves can be activated in one of three different ways: (1) automatically by the IACS, after receiving a signal from DESPEMES, as described above; (2) manually by a crew member at the IACS operator station who activates the emergency shutdown function; or (3) manually by a crew member closing the valve at the engine.

Despite the presence of these safety mechanisms, crew members testified that before the explosions, they heard the online engines "rev up," increasing in rpm, which could indicate that flammable gases were feeding the engines and causing "overspeeding."<sup>49</sup> To the extent that the engines did overspeed, without access to the engines that sank along with the MODU, the reason that the multiple overspeed safety features did not prevent the operating engines from increasing in RPM cannot be determined.

### **C. Main and Emergency Power Systems**

The explosions caused the loss of the main and emergency power systems and limited *DEEPWATER HORIZON* to transitional power that could only operate the emergency lighting and communications systems, but could not reestablish the main power system. The design of the system, though consistent with applicable standards, was insufficient to overcome the casualty.

#### **1. Main Power System Design**

*DEEPWATER HORIZON*'s main electrical power was supplied by six seven-megawatt diesel engine-generator sets consisting of Wärtsilä 18V32 LN(E) engines and ABB AMG 0900XU10 generators.<sup>50</sup> The engine-generator sets were located in six separate engine rooms protected by A-60 fire resistant bulkheads and located on the aft portion of the MODU on the second and third decks. Each engine room was constructed with its own supply and exhaust fan. The supply fans and ducting for each generator space were located on the main deck aft of the Drill Floor, outside any hazardous class locations.<sup>51</sup> The engine room ventilation system exhaust outlets were located on the aft deck next to each of the main engine exhaust pipes.

---

<sup>48</sup> Wartsila North America Written Submission to JIT 10/14, 2010 (forwarding details of the Wärtsilä Vasa 32 engines).

<sup>49</sup> Testimony ██████ 5/26/2010 p 97; Testimony ██████ 7/23/2010 p 13.

<sup>50</sup> *DEEPWATER HORIZON* Operations Manual March 2001 Section 8.1, ABSDWH000364-367.

<sup>51</sup> Hazardous Area Drawings, ABSDWH004274-82.

The power system could be arranged with one or more generators in reserve mode, so that if a loss of power occurred, one of the reserve generators would automatically start and pick up the load. This arrangement complies with paragraph 5.3.5 of the 1989 IMO MODU Code, which permits one of the reserve generators to function as the emergency source of power.

The standby means of electrical power was supplied by a four-hundred kW diesel engine-generator set consisting of a Caterpillar 3408C D1-TA Engine and a Caterpillar SR4 generator, located on the port side of the main deck, about amidships. It would be used to re-start the power plant (a cold start) and would power emergency lighting and communications systems.<sup>52</sup> This standby generator was the only generator on *DEEPWATER HORIZON* installed away from the six main engines.

This design generally complied with applicable standards. *DEEPWATER HORIZON* was designed in compliance with American Bureau of Shipping (ABS) Mobile Offshore Drilling Unit Rules, ABS Rules for Building and Classing Steel Vessels, 1989 IMO MODU Code, and the Panamanian MODU Standards and Regulations.<sup>53</sup> Accordingly, ABS had to verify compliance with ABS Rules, check the soundness of the MODU structure and design to ensure an acceptable level of safety was provided, and assign a “class notation” that clarifies the environmental conditions and operating criteria under which the unit is suited to operate.<sup>54</sup>

Because the MODU was constructed with an ABS DPS-3 class “dynamic positioning system,” it was required to be capable of providing a main and emergency source of power adequate to continue maintaining position in the event that any single compartment was damaged due to fire or flooding. To meet this classification, ABS requires generators and their main engines to be located in at least two separate compartments.<sup>55</sup> Further, ABS also requires two separate power management (control) systems so that loss of a single compartment will not render the control system inoperable.<sup>56</sup> To satisfy this requirement, *DEEPWATER HORIZON*'s redundant power management systems were located in the CCR and the ECR.<sup>57</sup>

Both ABS rules<sup>58</sup> and IMO standards<sup>59</sup> allow a vessel to be designed without a dedicated emergency generator and electrical bus if the design is arranged so that a fire or other casualty in one space will not affect the power distribution from the other spaces. This includes the use of class A-60 fire resistant boundaries for each space.

---

<sup>52</sup> *DEEPWATER HORIZON* Operations Manual March 2001 Section 8.2, ABSDWH000448-470.

<sup>53</sup> *DEEPWATER HORIZON* Operations Manual March 2001 Sections 1.7-1.8, ABSDWH000046-47. These regulations, rules and standards combined to form a regulatory scheme that is accepted by the U.S. Coast Guard (USCG) as an equivalent to U.S. regulations, 33 C.F.R. 143.207, 146.205. After *DEEPWATER HORIZON* was reflagged to the Republic of the Marshall Islands (RMI) in 2005, it also met the RMI MODU Standards and Regulations, which are accepted by the USCG as an equivalent regulatory scheme.

<sup>54</sup> ABS is a Classification Society that maintains Rules, Guides, standards and other criteria for the design and construction of drilling units, consistent with the IMO MODU Code. ABS was also contracted by the vessel owner to confirm that *DEEPWATER HORIZON* met the standards of the RMI.

<sup>55</sup> ABS Rules for Building and Classing Steel Vessels Part 4 Chapter 3 Section 5 15.5.2.

<sup>56</sup> ABS Rules for Building and Classing Steel Vessels Part 4 Chapter 3 Section 5 15.5.3.

<sup>57</sup> *DEEPWATER HORIZON* Operations Manual March 2001 Section 6.1, ABS DWH0000248-59.

<sup>58</sup> ABS Mobile Offshore Drilling Unit Rules Part 4 Chapter 3 Section 2 Section 5.1.3.

<sup>59</sup> Code for the Construction and Equipment of Mobile Offshore Drilling Units 1989 Chapter 5 Section 5.3.5.

Although *DEEPWATER HORIZON* met DPS-3 and IMO MODU Code requirements by having completely redundant generator/engine rooms, the design did not prevent a total failure of the main electrical power system. When the explosions caused damage to both Engine Rooms # 3 and # 6, the damage was more than the design criteria contemplated. The other engines were supposed to start up to replace the lost engines, but the design of the emergency power system failed to take into account the close proximity of the engine space ventilation inlets to each other. Thus, even if the engines were sufficiently spaced apart, the presence of flammable gases near the ventilation inlets could, and likely did, immediately affect all six engine rooms. The IMO MODU Code does not consider this possible failure.

## 2. Transitional Power

Following the explosions, the transitional power systems largely functioned. In the event of a loss of electrical power, *DEEPWATER HORIZON* had a number of uninterruptible power supply (UPS) and charger/battery systems available to support certain limited functions. These were:

- Four charger/battery systems for the lifeboat embarkation area, one per quadrant
- One UPS system for drilling control system
- One charger/battery system for radio communication equipment
- Two UPS systems for the blowout preventer system (located in MUX room)
- One redundant fire and gas UPS System
- One redundant emergency shutdown (ESD) UPS system
- Five redundant IACS UPS systems
- Eight redundant thruster UPS systems
- Eight charger/battery systems for 11 kV switchgear control power
- Two redundant Hydroacoustic Reference System (HPR/HIPAP) UPS systems
- Two charger/battery systems for the emergency generator
- Two public address/general alarm (PA/GA) UPS systems
- One charger/battery system for the obstruction lights
- One charger/battery system for the warning horns<sup>60</sup>

---

<sup>60</sup> *DEEPWATER HORIZON* Operations Manual March 2001 Section 8.1.5, ABS DWH0000370.

These systems were designed to provide continuous power to critical systems at all times for a period of no less than 18 hours.<sup>61</sup>

During the casualty, the transitional electrical power on board *DEEPWATER HORIZON* was operational in the CCR and throughout the MODU, unless the location supplied by the UPS was too damaged to function. As a result, the crew was able to hear and acknowledge alarms, had working IACS panels, utilized the PA/GA systems and utilized the communications system in the CCR. There is no indication of a failure of transitional power. Further, there is no evidence available that shows transitional power having severely impacted the crew’s ability to evacuate the MODU.<sup>62</sup>

Table 2 – Status of Uninterruptible Power Supply

UPS System	Condition Post-Explosion
Lifeboat Embarkation Areas	No data to validate
Drilling Control System	Drill Floor area damaged
Radio Communication Equipment <sup>63</sup>	Working
BOP system (Bridge Panel) <sup>64</sup>	The OIM and subsea supervisor testified seeing indicator lights on the panel after arriving on the Bridge
Fire & Gas System (Bridge) <sup>65</sup>	The DPO testified that she continued to acknowledge alarms after the explosions
IACS System (Simrad SVC Bridge) <sup>66</sup>	Working
Redundant Thruster	No data to validate
Switchgear Control Power	No data to validate
HPR/HIPAP	No data to validate
Charger/battery for emergency generator <sup>67</sup>	Working
PA/GA <sup>68</sup>	Working
Obstruction Lights	No data to validate
Warning Horns	No data to validate

#### D. Gas Detection System Design

The main fire and gas detection system control panel was located in the CCR, and was arranged to monitor the fire detection system as well as the flammable and toxic gas detection system.<sup>69</sup>

<sup>61</sup> Code for the Construction and Equipment of Mobile Offshore Drilling Units 1989 Section 5.3.10.

<sup>62</sup> There was testimony that during the evacuation, crew members had difficulty finding their way because the emergency lighting was inadequate. See Chapter 3. As noted in the above description of the Transitional Power System, the emergency lighting in the accommodation areas was not supplied by this system.

<sup>63</sup> Testimony ██████████ 7/19/10 p 43; Testimony ██████████ 10/5/10 pp 152-153.

<sup>64</sup> Testimony ██████████ 5/27/10 pp 66-67; Testimony ██████████ 5/28/10 pp 123, 145.

<sup>65</sup> Testimony ██████████ 10/5/2010 p 14.

<sup>66</sup> Testimony ██████████ 7/19/10 p 36.

<sup>67</sup> Testimony ██████████ 7/19/10 p 41.

<sup>68</sup> Testimony ██████████ 5/27/10 p 327; Testimony ██████████ 5/28/10 p 232; Testimony ██████████ 5/29/10 p 148.

Two remote repeater panels were installed on the MODU, located in the Driller's Work Station (DWS) and the ECR. These panels provided indication of any alarms that appeared on the main control panel at these alternate locations. The system also monitored the status of the hazardous area ventilation systems, carbon dioxide (CO<sub>2</sub>) fire extinguishing systems, sprinklers, and other fire-fighting systems.

The gas detection system included flammable gas and toxic (H<sub>2</sub>S) gas detectors, which were installed at selected locations along the drilling mud path and in other locations where gas could have been expected as a result of drilling activities. H<sub>2</sub>S gas detectors were installed in the following locations:

- Moon Pool area, near the diverter housing, just below the Drill Floor;
- Drill Floor;
- DWS and Drilling Equipment Room purge fan air intakes;
- Drill Shack (internal);
- Drilling Equipment Room (internal);
- Shaker / Mud Process Room;
- Mud Pit Room;
- Mud Pump Room;
- Accommodations and galley ventilation air intakes; and
- Well Test Area.

Flammable gas detectors were provided in the following locations:

- Engine room air intakes;
- Welding Shop; and
- Battery Room.

The fire detection system was arranged with individually addressable fire detectors located throughout the MODU to allow rapid identification of the affected area. With this arrangement, each individual detector had a system "address" that indicated the location of the detector on the

---

<sup>69</sup> *DEEPWATER HORIZON* Operation Manual March 2001 Sections 9.2.1 to 9.2.3, ABSDWH000547-548.

control panel.<sup>70</sup> Fire detection devices included heat, smoke, and infrared flame detectors, selected for reliable operation in the areas in which they were installed. Fire detection devices and manual pull alarm stations were installed in all machinery spaces, all normally occupied areas, and all spaces within the accommodations area.

A September 2009 audit of *DEEPWATER HORIZON* on behalf of BP revealed problems with both the operability of the fire and gas detection system and the training and knowledge of personnel charged with operating it. The audit found that two flammable gas detectors and seven fire detection devices on the MODU were inoperable and required repair.<sup>71</sup> In addition, at the time of the audit, the Drill Shack's fire and gas detection system panel was displaying numerous active alarm conditions, including fire alarm, fault emergency shutdown, fault fire and gas, and fire and gas override. These fault conditions rendered the fire and gas detection system inoperable. However, the driller and assistant driller on duty at the time of the audit were unaware of the fault conditions.<sup>72</sup>

### 1. Fire and Gas Detection System Logic

Activation of a gas or fire detector would result in immediate audible and visual alarms in the CCR, ECR, and DWS. The system was arranged so that the alarms would be acknowledged by personnel in one of the three control locations and allow them to direct other personnel to investigate and report based on the location of the alarm and levels of gas detected. Subsequent alarms, including the general alarm to all personnel, would need to be manually activated from one of these control locations.<sup>73</sup>

In addition, the chief electronics technician testified that it was standard practice to have a number of detectors set in "inhibited" mode, such that the detection of gas would be reported to the control panel but no alarm would sound, to prevent false alarms from awakening sleeping crew members during the night.<sup>74</sup>

The gas and fire detection system was not arranged to automatically stop the engines and other machinery or close ventilation dampers if flammable gas was detected; it instead relied on personnel on watch in the CCR to manually activate the ESD systems.<sup>75</sup> However, the crew was not provided with training or procedures to clarify when conditions warranted activation of the ESD systems and what actions to take in such an event.<sup>76</sup> Thus, when multiple gas alarms were received in the CCR during the well control event, no personnel manually activated the ESD systems for the operating main engines.<sup>77</sup>

---

<sup>70</sup> Non-addressable fire detection systems have their detectors connected on wiring loops, and activation of any detector will cause the entire loop to indicate on the control panel, in which case personnel need to go to the affected area to determine which detector has alarmed.

<sup>71</sup> BP Common Marine Inspection Document Section 11.4, BP-HZN-MBI00170650.

<sup>72</sup> BP *DEEPWATER HORIZON* Follow-up Rig Audit p 40, BP-HZN-IIT-0008910.

<sup>73</sup> Testimony [REDACTED] 10/5/2010 pp 54-55.

<sup>74</sup> Testimony [REDACTED] 7/23/2010 pp 30-34.

<sup>75</sup> Kongsberg Cause and Effect Matrix, ABSDWH001090-1227.

<sup>76</sup> Testimony [REDACTED] 10/5/2010 pp 60-61.

<sup>77</sup> Testimony [REDACTED] 10/5/2010 pp 60-61.



Similarly, *DEEPWATER HORIZON* had a ventilation monitoring and control system that was designed to monitor and indicate ventilation failures in those areas where positive or negative pressure was required to control potentially hazardous gas levels. In the event that a loss of pressure was detected, an alarm would have appeared in the IACS and in the CCR, but the alarm would not automatically cause equipment shutdown.<sup>78</sup>

Section 9.8 of the 1989 IMO MODU Code states that a gas detection and alarm system should be provided to the satisfaction of the MODU's flag Administration. The Code does not indicate whether the gas detection system should provide an alarm only, or if it should be arranged to activate emergency shutdown of equipment in the affected areas. In addition, it provides no guidance regarding the type and number of gas detectors, their arrangement, alarm set points, response times, wiring protocols or survivability requirements.

While Section 6.5 of the 1989 MODU Code specifies criteria for the emergency shutdown of selected equipment in case of emergency conditions due to drilling operations, it does not clearly indicate whether the gas detection system should be arranged to automatically activate these emergency shutdown provisions or if they are to be manually activated.

For a MODU using a dynamic positioning system, there is a particular concern that a gas explosion that impacts the generators would threaten the MODU's station keeping ability. The 2009 IMO MODU Code includes a further recommendation for dynamic positioned units such as *DEEPWATER HORIZON*:

“6.5.2 In the case of units using dynamic positioning systems as a sole means of position keeping, special consideration may be given to the selective disconnection or shutdown of machinery and equipment associated with maintaining the operability of the dynamic positioning system in order to preserve the integrity of the well.”

The intent of this new recommendation is not clear, as the IMO MODU Code does not provide a recommended hierarchy of automatic and manual emergency shutdown actions following gas detection in areas that may impact the dynamic positioning system, or the emergency power sources necessary for maintaining the MODU's position in the event of a flammable gas release.

## **E. Crew Blast Protection Failures**

During and following the explosions, 11 personnel were missing and are presumed dead, and 16 others were injured. The primary means of protection from the effects of an explosion are the bulkhead divisions that separate different areas on the MODU. On *DEEPWATER HORIZON*, A-60 class bulkheads were provided in accordance with section 9.1.3 of the 1989 IMO MODU Code, to separate the exterior boundaries of superstructures from the Drill Floor.<sup>79</sup> This section will discuss the effectiveness of these barriers.

---

<sup>78</sup> *DEEPWATER HORIZON* Operations Manual March 2001 Section 9.2, ABS DWH0000547-558.

<sup>79</sup> A-class bulkheads are defined in the SOLAS Convention as fire rated separations capable of preventing the spread of fire for a period of one hour.

## 1. Placement of Barriers on *DEEPWATER HORIZON*

The 1989 IMO MODU Code does not include any safety measures for blast resistance. Regulation 9.1.3 of the Code requires exterior boundaries of superstructures and deckhouses enclosing accommodation areas to be constructed of A-60 class divisions for the whole of the portion which faces and is within 30 m (98.4 ft) of the center of the rotary table. On *DEEPWATER HORIZON*, the rotary table was located in the center of the Drill Floor on the centerline of the unit.<sup>80</sup> Because of this requirement, A-60 bulkheads surrounded the drilling area on the second and third decks. The drilling area on the main deck at elevation 41.5 m (136 ft), and the Drill Floor at elevation 46 m (150 ft) did not abut any accommodations and consequently were not bounded by fire rated divisions. The Drill Shack located on the Drill Floor was considered part of the industrial process area and was not subjected to any structural fire protection requirements; thus it was designed with large windows for viewing the Drill Floor operations.

## 2. Limitations of A-Class Bulkheads

On July 6, 1988, an explosion occurred on the platform *PIPER ALPHA* in the North Sea, causing the loss of 165 persons, the largest single loss of life in the history of offshore operations. Research done for the *PIPER ALPHA* inquiry indicated that depending on their specific design, A-class bulkheads may be capable of withstanding a blast pressure of about 0.01 N/mm<sup>2</sup> (0.1 bar). Typical explosion pressures expected from the ignition of hydrocarbon vapors during a blowout approach the range of 0.02-0.04 N/mm<sup>2</sup> (0.2 – 0.4 bar).<sup>81</sup> Thus, without further means of blast protection, personnel cannot be effectively shielded from a Drill Floor explosion by A-class bulkheads.

In general, the blast resistance necessary to ensure the survivability of accommodation spaces, service areas and control stations located adjacent to hazardous areas can be calculated based on the volume enclosed within the affected spaces and a determination of the relative level of congestion. Various international safety guides provide suggested calculation techniques based on an accidental explosion load defined by a maximum explosion overpressure and pulse duration period (i.e., the force and duration of the explosion).<sup>82</sup> None of this information is provided in the IMO MODU Code.

## 3. Impact on Personnel

All of the missing and presumed deceased crew members were located in one of two areas on *DEEPWATER HORIZON* when the well blowout and explosions began. Seven members of the drilling crew were last seen on or near the Drill Floor or near the Driller's Shack, Shale Shaker

---

<sup>80</sup> See Appendix E for further details.

<sup>81</sup> The Public Inquiry into the *PIPER ALPHA* Disaster, Hon. Lord Cullen, November 1990, Volume 1, pp 65-69.

<sup>82</sup> UKOOA/HSE Fire and Explosion Guidance, Parts 0 & 1, October 2003; ISO/FDIS 13702, Petroleum and Natural Gas Industries – Control and Mitigation of Fires and Explosions on Offshore Production Installations, 1998. NORSOK Standard S-001, Rev. 3 Technical Safety, 2001; API RP2A, Recommended Practice for Planning, Designing and Constructing Fixed Offshore Platforms, Section 18, 21<sup>st</sup> edition.

House or starboard side crane pedestal.<sup>83</sup> The remaining four missing crew members were last seen in the Mud Pump Room, between Mud Pumps # 2 and # 3.<sup>84</sup>

Witness testimony suggests that one of the explosions occurred in the vicinity of the derrick on the Drill Floor or the nearby MGS. The layout of the Drill Floor on *DEEPWATER HORIZON* provided no protection from blast overpressure or thermal radiation (the force and heat of an explosion) to the personnel working there. Accordingly, although cause of death cannot be definitively established, the crew members in the Drill Floor area are believed to have suffered fatal injuries during the two initial explosions.

The Mud Pump Room and the Shale Shaker House were separated from the Drill Floor area by an A-class bulkhead. Thus, the personnel last known to be in those areas would not have had substantial protection from the explosion if it originated on the Drill Floor. Moreover, because one witness testified that the gas alarms for the Mud Pump Room and the Shale Shaker House sounded before the explosions occurred, flammable gas vapors may have entered the Mud Pit ventilation system and ignited within the Mud Pump Room and the Shale Shaker House.<sup>85</sup>

The majority of non-fatal injuries caused by the explosion occurred in two separate areas on the second deck – the ECR located on the centerline aft, and the accommodation area, laundry and galley complex located in the forward starboard corner. One injury was reported on the main deck by the operator of the port side gantry crane. One crew member reported being injured while moving from the third deck up to the second deck, when he was thrown down the stairway by the force of the explosion. Another was injured while traveling to the lifeboats.<sup>86</sup>

The ECR was separated from the drilling area by three successive A-class bulkheads that bounded the intervening mud pump rooms and switchgear rooms. Personnel in the ECR, however, testified that blast forces also originated in Engine Room # 3 located on the port side of the ECR. Their injuries occurred despite the intervening A-class bulkheads.<sup>87</sup>

The second deck accommodation area was separated from the drilling area by an A-class bulkhead. The personnel located in these areas did not report smelling any sign of hydrocarbon vapors prior to the explosion. Thus, it appears that the explosion occurred outside this area, and that the blast forces damaged the intervening A-class bulkhead and were transmitted to the corridors and cabins within the accommodation area.

The locations of the missing and injured crew members are shown in Figures 2 through 4. Areas highlighted in green are the locations of injured personnel; the areas highlighted in red depict the last known locations of the missing. A-class bulkheads are shown as heavy black lines.

---

<sup>83</sup> Testimony [REDACTED] 5/29/2010 p 156; Testimony [REDACTED] 12/7/2010 pp 243-245.

<sup>84</sup> Testimony [REDACTED] 5/27/2010 pp 335-336.

<sup>85</sup> Testimony [REDACTED] 10/05/2010 pp 292-293.

<sup>86</sup> Witness Statement Walker 4/21/2010.

<sup>87</sup> Testimony [REDACTED] 5/26/2010 p 97; Testimony [REDACTED] 5/29/2010 pp 32-33; Testimony [REDACTED] 7/23/2010 pp 14-15; Testimony [REDACTED] 5/28/2010 pp 341-342.

#### 4. Blast Protection for Vital Systems

The 2009 IMO MODU Code, which will apply to new MODUs constructed after January 1, 2012, includes new requirements for an engineering analysis to verify that the level of blast resistance of any barriers separating the occupied areas from the hazardous areas should be determined adequate for the likely hazard:

“In general, accommodation spaces, service spaces and control stations should not be located adjacent to hazardous areas. However, where this is not practicable, an engineering evaluation should be performed to ensure that the level of fire protection and blast resistance of the bulkheads and decks separating these spaces from the hazardous areas is adequate for the likely hazard.”<sup>88</sup>

MODUs not designed to avoid having such spaces adjacent to the Drill Floor will need to consider stronger barriers than A-60 bulkheads for spaces adjacent to the Drill Floor. However, an engineering evaluation is only required when a Type 1 space (control station), Type 2 space (corridor), Type 3 space (accommodation) or Type 4 space (stairway) is adjacent to a hazardous area. This limited application fails to consider vital safety systems and equipment such as fire extinguishing systems, fire pumps, emergency generators, Dynamic Positioning controls and other equipment that could be located in machinery spaces or service spaces. The *DEEPWATER HORIZON* casualty highlights the need to ensure the availability of such systems to mitigate the effects of an explosion or fire. Thus, it is important that all safety equipment located adjacent to hazardous areas be considered in the engineering evaluation specified by paragraph 9.3.1, regardless of the type of space where this equipment is located.

### III. Actions/Decisions Contributing to System Failure

#### A. The crew diverted the gas from the wellhead to the Mud Gas Separator instead of the Diverter Line.

At the outset of the blowout, the drilling crew appears to have aligned the uncontrolled well flow through the MGS, located on the starboard side of the derrick, which is designed to separate gas from the returned drilling mud and vent it through the outlet at the top of the derrick. The high pressure well flow, however, exceeded the system’s limitations, causing failure of the MGS system. The gas then could have discharged not just from the MGS vent located at the top of the derrick as designed, but also from other places along the MGS system not typically used to release gas: the MGS rupture disk on the main deck, and the MGS vacuum breaker located on the starboard derrick leg about 23 m (75 ft) above the main deck.

Alternatively, the crew could have directed the well flow through the port or starboard 356 mm (14-in) diverter lines, designed to “divert” high volume well flow over the side of the MODU in a well control situation. Since *DAMON B. BANKSTON* was operating on the port side of the MODU, the starboard side diverter would have been used. Had the flow been diverted

---

<sup>88</sup> Code of the Construction and Equipment of Mobile Offshore Drilling Units 2010 Section 9.3.1.

overboard, the majority of the flammable gas cloud may have formed away from the Drill Floor and the MODU, reducing the risk of an onboard explosion.

Nevertheless, this action ultimately may not have prevented an explosion. Because of the extremely large volume of gas flowing from the well under high pressure, significant levels of flammable gas may still have been released, through slip joints and other riser components that failed under pressure, into the Moon Pool or onto the Drill Floor. It then could have reached unguarded ignition sources and caused an explosion.

**B. Transocean failed properly to track and maintain Drill Floor electrical equipment that could have served as an ignition source.**

As discussed above, in order not to run the risk of serving as an ignition source, electrical equipment installed in hazardous areas must be safe for the expected atmosphere (environment). The IMO MODU Code provides the applicable requirements, and proper operation of such equipment is essential to maintain continued safe operation in hazardous areas.

Based on the design drawings made available to the Joint Investigation Team, the electrical equipment on the Drill Floor and in other hazardous classified areas where explosive gas/air mixtures could be present was reported to be certified safe for use in explosive atmospheres.<sup>89</sup>

However, the April 2010 ModuSpec USA, Inc. audit found that *DEEPWATER HORIZON* lacked systems properly to track its hazardous electrical equipment and that the hazardous area electrical equipment on board was in “bad condition.”<sup>90</sup> The audit determined that contrary to the IMO International Safety Management (ISM) Code,<sup>91</sup> none of the classified electrical equipment on the Drill Floor had been tagged with an identification number, and the MODU did not have on board a hazardous area equipment registry or hazardous area drawing that would have identified both the classified electrical equipment and the boundaries of the hazardous areas.<sup>92</sup> Since the crew did not have any means to clearly identify the classified electrical equipment or the extent of the hazardous areas, there can be no assurance that no unclassified fixtures were introduced into the hazardous areas during maintenance or modifications.

In addition, several of the shale shaker motor starters were “extremely dirty and covered in mud,” drilling mud agitator frames were “severely corroded,” and both types of equipment had missing or illegible certification labels.<sup>93</sup> The audit also noted that a subcontractor’s drilling mud processing equipment, had been brought on board and placed on the main deck and in the

---

<sup>89</sup> ABS Letter dated 1/5/2001, ABSDWH004303-4310; Hyundai Heavy Industries Hazardous Area Classification Drawings HRBS-E81-000-H0015 Rev. A. Sheets 4-7, ABSDWH004278-81.

<sup>90</sup> ModuSpec USA Inc. Rig Condition Assessment of the *DEEPWATER HORIZON* 411-14/2010 Section 4.16, TRN-USCG\_MMS-00038689.

<sup>91</sup> Section 11.2 of the IMO International Safety Management (ISM) Code specifies that the company should ensure that valid documents are available at all relevant locations, and that changes to documents are reviewed and approved by authorized personnel.

<sup>92</sup> ModuSpec USA Inc. Rig Condition Assessment of the *DEEPWATER HORIZON* 4/11-14/2010 Section 4.16, TRN-USCG\_MMS-00038689-38690.

<sup>93</sup> *Id.*

Moon Pool areas, and that it was in “poor condition.”<sup>94</sup> Such equipment could have presented an ignition risk. As a result of these problems, the auditors recommended that a third party perform a hazardous equipment inventory, label the equipment, and then perform a survey “to establish the true condition of all electrical equipment installed in the hazardous areas on the rig.”<sup>95</sup>

Because of the failure properly to track and maintain the electrical equipment, there is no assurance that on the date of the casualty, approximately one week after the audit was completed, the classified electrical equipment was safe and could not serve as an ignition source.

**C. The *DEEPWATER HORIZON* crew bypassed an automatic shutdown system designed to prevent flammable gas from reaching ignition sources.**

There were several electrical installations on the Drill Floor that were maintained safe by enclosing them in a “purged and pressurized” enclosure. For example, the mud logger testified that the Halliburton Mud Logger’s Unit, adjacent to the Drill Floor, was maintained under a positive pressure and would shut down if gas vapors were detected in the unit. He testified that, at the time of the explosion, he smelled gas just prior to the unit losing power:

“When I started smelling the gas fumes, my monitors vibrated real hard on my walls and I heard a loud noise, like a whistling sound, and by then, I went to grab my hard hat, which I always keep right here on the side of me, and by the time I picked it up, all my lights and all that had went out due to the gas coming in my unit.”<sup>96</sup>

Another such location was the Drill Shack, which housed the blowout preventer (BOP) control panel. The chief electrician testified that if the access door to the Drill Shack was held open for an extended period of time the work station would “lose purge.” Because the BOP control panel was kept separate under a positive pressure, if the BOP control panel doors were opened causing it to “lose purge,” it would automatically shut down electrical power, requiring the panel to be cleared and restarted. As a result, the crew had set the positive pressure feature of the BOP control panel in a continuously bypassed condition to avoid unnecessary shutdown of the system. The chief electrician had been told by a crew member that it had “been in bypass for five years” and that “the entire fleet runs them in bypass.”<sup>97</sup> With the positive pressure feature bypassed, any flammable gases that entered the BOP control panel could be exposed to unguarded ignition sources without an automatic power shutdown.

Thus, during the well control efforts immediately prior to the explosion, if crew members entered and exited the Drill Shack to such a degree that it resulted in a loss of positive pressure, flammable gases could have entered and made contact with the BOP control panel or other electrical ignition sources within the area.

---

<sup>94</sup> *Id.*

<sup>95</sup> *Id.*

<sup>96</sup> Testimony [REDACTED] 12/7/2010 p 62.

<sup>97</sup> Testimony [REDACTED] 7/23/2010 pp 39-42.

**D. The crew failed to activate the engine room emergency shutdown system upon receiving gas alarms.**

When the Bridge crew began receiving the gas alarms, they did not immediately activate the ESD system to prevent ignition by the engines. This delay may be attributed to a lack of clear procedures and training. Beginning at approximately 2100 hours, the drilling crew observed abnormal pressures on the drill string and was initiating steps to shut in the well. At 2150, the on-watch assistant driller called the senior toolpusher and advised him of a well control situation.<sup>98</sup> Likewise, the on-watch toolpusher called the well site leader and advised him that he was diverting returns to the gas buster.<sup>99</sup>

Just before the initial explosion, the on-watch DPO received a call from the Drill Floor informing her of a well control situation, followed by a call from the ECR inquiring into the current circumstances on board. By this time, the on-watch DPO was aware of multiple flammable gas alarms. However, she did not inform the ECR personnel of the alarms, nor did she advise them to shut down the engines; she had not been trained to take such actions.<sup>100</sup> The on-watch DPO had access to the controls for the engine room ESD system and the general alarm from the CCR, but did not activate the ESD systems after the flammable gas alarms sounded because she was not aware of any procedures requiring her to do so.<sup>101</sup>

Had the ESD system for the main engines been activated immediately upon the detection of gas in the area, it is possible that the explosions in the engine room area could have been avoided or delayed. However, the decision to activate the ESD system for the main engines had to be balanced with the need to maintain electrical power to ensure the station keeping ability of the dynamic positioning system. If the main engines were shut down prior to the explosions and the unit drifted off position, the riser and its connection to the well may have been damaged.

**E. Transocean used a dual-command organization structure that created command confusion during the well control incident and the decision to activate the EDS.**

At the time of the casualty, there was confusion on *DEEPWATER HORIZON* about who was in charge of the MODU arising from the dual-command organizational structure instituted by Transocean. The Minimum Safe Manning Certificate (MSMC) issued by the Republic of the Marshall Islands (RMI) for *DEEPWATER HORIZON* listed the vessel as a self-propelled MODU rather than as a dynamic positioned vessel. RMI has since acknowledged that listing the unit as a self-propelled MODU was the result of a “clerical error.”<sup>102</sup> For self-propelled MODUs, the RMI required a master to be on board when the vessel is underway and allowed an OIM to be in charge when it is latched-up. For dynamically positioned vessels, the RMI required a master to be on board at all times but did not clearly define the chain of command.<sup>103</sup> As a result, Transocean implemented a dual-command organizational structure, in which the master was in

---

<sup>98</sup> Testimony [REDACTED] 5/28/2010 p 283.

<sup>99</sup> [REDACTED] interview notes, BP-HZN-MBI00021406-432.

<sup>100</sup> Testimony [REDACTED] 10/5/2010 p 40.

<sup>101</sup> Testimony [REDACTED] 10/5/2010 pp 60-61.

<sup>102</sup> The Republic of the Marshall Islands letter to the Joint Board of Investigation dated 8/25/2010.

<sup>103</sup> The Republic of Marshall Islands Marine Notice No. 7-038-2, Revised 12/2009.

charge whenever the MODU was underway between locations, and the OIM was in charge when the MODU was latched up and using the dynamic positioning system to maintain position. In any emergency situation, the master was to assume full control over the unit. *DEEPWATER HORIZON's* operations manual states that “the Master has overriding authority and responsibility to make decisions with respect to safety and pollution prevention and to request all internal company assistance as necessary.” The operational guidance is clear that only one individual can be the person in charge at any given point.<sup>104</sup>

During the normal course of operations, if an emergency were to occur while the MODU was latched up, command was to shift from the OIM to the master. The transfer of responsibility and authority could be done verbally, with the time noted and a formal documented transfer completed when time allowed. Whenever possible, a PA system broadcast was to be made at the time of transfer to ensure that all personnel were aware of any change in command.<sup>105</sup>

This arrangement may have impacted the decision to activate the vessel’s EDS. At the time of the casualty, the master was in the CCR conducting a familiarization tour for BP and Transocean executives. The OIM was below in his stateroom and did not arrive in the CCR for several minutes after the explosions. Upon his arrival, there was no immediate transfer of responsibility between the OIM and the master and no verbal or PA announcement to indicate that the master had relieved the OIM as the person in charge. This failure to clearly delineate that the responsibility for the operation of *DEEPWATER HORIZON* had shifted from the OIM to the master created a situation in the CCR where it was unclear who was in charge. The lack of clarity is evidenced by the fact that the master asked the OIM for permission to activate the EDS.<sup>106</sup> The confusion was further demonstrated by the fact that by this time, the subsea supervisor had already activated the EDS.<sup>107</sup>

Current U.S. regulations regarding manning requirements for MODUs require self-propelled MODUs to be under the control of the master when underway.<sup>108</sup> MODUs that are bottom bearing or moored with anchors are considered on location, and no longer underway.<sup>109</sup> However, the existing regulations do not account for the use of dynamic positioning (DP) systems. U.S. flagged MODUs using DP for station keeping are considered self-propelled motor vessels that are underway, and cannot be considered on-location as defined in 46 C.F.R. § 10.107. Thus, a dual command structure is not permitted on a U.S. flagged DP MODU. The regulations are less clear about the division of responsibilities between the vessel master and the OIM for foreign flagged DP MODUs operating on the U. S. OCS. Further discussion of the shortcomings of the existing U.S. regulations is provided in Appendix I.

---

<sup>104</sup> *DEEPWATER HORIZON* Operations Manual Section 2.1, ABSDWH000062.

<sup>105</sup> *Id.*, Section 2.1.1.

<sup>106</sup> Testimony ██████████ 8/26/2010 p 440.

<sup>107</sup> Testimony ██████████ 5/28/2010 p 123.

<sup>108</sup> 46 C.F.R. 15.520(d).

<sup>109</sup> 46 C.F.R. 10.107.



## **IV. U.S. Government / Class / Flag Oversight**

### **A. Responsibilities for Vessel Inspections and Surveys**

*DEEPWATER HORIZON* was flagged by the RMI, classified by the ABS, contracted to BP and was operating on the U.S. Outer Continental Shelf. This created an inspection/survey regime from five different entities: RMI, USCG, ABS, Det Norske Veritas (DNV), and BP. Transocean also used an independent auditor, ModuSpec USA Inc., to perform its internal survey of the vessel's materiel conditions.

### **B. Company Inspections and Surveys**

Classification Societies are non-governmental organizations that grew out of the marine insurance industry primarily during the 18<sup>th</sup> and 19<sup>th</sup> centuries to set neutral and impartial standards and "class rules" to promote maritime safety in a manner that protected the often competing interests of ship owners, the insurers, and the public. Vessels meeting class rules and standards are issued a Certificate of Classification. As permitted by several international conventions, Classification Societies also may be delegated authority by the flag state to act on their behalf in conducting specified audits, surveys, and certifications required by those conventions.

Transocean elected to use the services of ABS to perform Classification Society Surveys that included the issuance of the Certificate of Classification for Machinery and Hull, and verification of the vessel dynamic positioning system, elevators, and lifting gear. The machinery survey in particular provides for a continuous survey of the main engines and components, which can be drawn out for an extended period of time until the Certificate renews. Transocean elected in 2005 to discontinue the ABS survey services for the Drilling Equipment.

As a contracted vessel of BP, *DEEPWATER HORIZON* underwent inspection audits to ensure that the vessel was in compliance with BP policies and international and U.S. regulations. Two independent audits were conducted: one audit was conducted in September 2009 by BP utilizing the International Marine Contractor's Association Common Marine Inspection Document; a second audit was initiated by Transocean and conducted by ModuSpec USA, Inc. in April 2010, a week before the casualty.

### **C. Flag State**

The RMI and the USCG were mandated by international and U.S. regulatory requirements to perform inspections and examinations on the MODU. The RMI did not physically evaluate the MODU. All of *DEEPWATER HORIZON* Ship Statutory Certification Services were performed by the recognized organizations (RO) acting on behalf of the RMI. ABS acted as the RO for the review and survey of technical issues such as engineering and design, while DNV was the RO for the review and audit of the safety management system (SMS) for compliance with the ISM Code. The RO is required to submit an annual report using the Republic of the Marshall Islands Report of Safety Inspection for MODU/MOU form (form number MSD 252 MODU/MOU rev.

6/07). The RMI review was limited to administrative subjects and relied on ABS reports and documentation for the review of all technical matters.

ABS used checklists for the relevant surveys that the surveyor was expected to perform and made multiple visits to *DEEPWATER HORIZON* to perform a total of 22 different surveys over a one-year period. These surveys combined regulatory and classification society responsibilities and were performed by multiple surveyors.

Per Appendix O, ABS was on *DEEPWATER HORIZON* in March 2009 to perform a dry-dock extension survey. During that survey, the watertight doors were noted as being in satisfactory condition. ABS was also present in September 2009 to conduct several surveys, during which it made no findings relating to the vessel's ability to prevent a fire or explosion. BP then conducted its audit and found several deficiencies relating to watertight integrity, fire and gas systems, ventilation systems and fire doors. ABS returned in December 2009 to carry out additional surveys and perform a flag state annual inspection. On the inspection report to the RMI, ABS noted no deficiencies and characterized the MODU's overall condition as clean and acceptable. ABS returned to *DEEPWATER HORIZON* in February 2009 to continue its survey. During this visit, it noted no discrepancies that affected the vessel's ability to mitigate fire or explosion. Finally, in April 2010, ModuSpec USA, Inc. attended the vessel on behalf of Transocean and conducted an audit which noted discrepancies with the ventilation system but resulted in an overall report listing the entire ventilation system to be in fair condition.

#### **D. Coast Guard Inspections**

Foreign-flagged MODUs are subject to the requirements of Title 33, Code of Federal Regulations (C.F.R.), Subchapter N. 33 C.F.R. § 143.207 requires foreign-flagged MODUs to demonstrate that they provide a minimum level of safety consistent with 46 C.F.R. Parts 107, 108 and 109. Owners of foreign-flagged MODUs have three options to show compliance with this regulation: they may elect to comply with the regulations in 46 C.F.R. Parts 107, 108 and 109 for U.S. flag MODUs; they may show compliance with the IMO MODU Code; or they may conform to the regulations of the documenting nation, if it is determined that these regulations provide an adequate level of safety. To ensure compliance with Subchapter N, the Coast Guard conducts annual Certificate of Compliance (COC) examinations of foreign-flagged MODUs to verify statutory certificates, test safety devices, and witness emergency drills. These examinations are much less detailed than those used by Classification Societies to verify full compliance with their classification regulations.

The scope of inspections required during COC examinations of foreign-flagged MODUs is not stated in 46 C.F.R. Subchapter I-A. Instead, guidance to inspectors is provided in Navigation and Vessel Inspection Circular (NVIC) 3-88 CH-1.<sup>110</sup> Coast Guard inspectors consequently rely on this and other informal inspection guidance documents when attending foreign-flagged

---

<sup>110</sup> NVICs are Coast Guard guidance documents that are not a substitute for applicable legal requirements, nor are they regulations. NVICs are not intended to nor do they impose legally-binding requirements on any party. They represent the Coast Guard's current thinking on certain topics and are issued for guidance purposes to outline methods of best practice for compliance with the applicable law. MODU operators may use an alternative approach if the approach satisfies the requirements of the applicable statutes and regulations.

MODUs. As a result, inspection records do not provide a consistent level of information that may be of use during reinspections by different inspectors.

On July 29, 2009, Coast Guard Inspectors from Marine Safety Unit (MSU) Port Arthur conducted a COC examination and issued a two-year COC. The inspection results documented in the Coast Guard Marine Information for Safety and Law Enforcement (MISLE) database noted that ventilation systems, fire systems, and hazardous locations were in satisfactory condition at the time of the inspection.<sup>111</sup> The Coast Guard files do not reference the exact systems tested or whether they were tested in whole or in part. It does not appear that the COC examination extended beyond a spot check inspection. The inspector narrative supplement for the 2009 inspection does address the fact that testing fire pumps, reviewing records related to testing and the preventive maintenance system for generators, testing fire boundary doors and testing ventilation shutdowns were conducted without incident. However, the narrative supplement for the COC examination case is not specific and does not list the exact systems that were tested (i.e., what fire pump was run, which engines the shutdowns were tested on, which ventilation fans successfully shutdown). Further, it does not address the condition of any watertight doors (satisfactory or unsatisfactory). Therefore, it is difficult to determine what was witnessed during the Coast Guard inspection in comparison to any other inspection.

A review of the previous COC annual examination performed on October 15, 2008 by MSU Morgan City revealed even less detail in the examination results, since the inspection report<sup>112</sup> did not reference any deficiencies. In fact, the October examination notes, “No 835 deficiencies were issued.”<sup>113</sup>

## V. Conclusions

- A. The exact location of the ignition source or sources that caused the initial and subsequent explosions and fire on *DEEPWATER HORIZON* cannot be conclusively identified. A number of possible ignition sources may have been present on the MODU, the most likely of which are electrical equipment on the Drill Floor, in the engine rooms, or in the switchgear rooms.
- B. The first explosion and fire occurred on the Drill Floor in or near the mud gas separator system. The second explosion occurred in Engine Room # 3 or in one of the adjacent switchgear or electrical rooms.
- C. The second explosion caused a total loss of electrical power by damaging electrical power distribution and control equipment and circuits in or near Engine Room # 3.
- D. The classified electrical equipment installed on *DEEPWATER HORIZON* at the time of the incident may not have been capable of preventing the ignition of flammable gas. Previous audit findings showed a lack of control over the maintenance and repair of such equipment;

---

<sup>111</sup> Coast Guard Activity report dated 7/29/2009, MSU Port Arthur, Activity # 3513781.

<sup>112</sup> Coast Guard Activity report dated 10/15 2008, MSU Morgan City, Activity # 3378271.

<sup>113</sup> CG 835, Notice of Merchant Marine Inspection Requirements, is a form issued by an attending Marine Inspector noting the requirement to rectify deficiencies found during inspection of domestic vessels.

therefore, it cannot be determined whether the classified electrical equipment was in proper condition. The 1989 International Maritime Organization (IMO) Mobile Offshore Drilling Unit (MODU) Code is insufficient because it does not have clear requirements for the long term labeling and control of classified electrical equipment, nor does it establish requirements or guidance for the continued inspection, repair and maintenance of such equipment. The 2009 IMO MODU Code includes criteria for the identification of classified electrical equipment, but does not require an on board maintenance program.

- E. The fire and gas detection system was not arranged to automatically activate the emergency shutdown (ESD) system if flammable gases were detected in critical areas. The system relied upon the crew on watch in the Central Control Room/Bridge to take manual actions to activate the necessary ESD systems; however, inadequate training was provided to clarify each crew member's responsibilities in the event of fire or gas detection. As a result, the Engine Control Room was not immediately notified to shut down the operating generators following the detection of gas, nor was the ESD systems activated for these areas. Additionally, a number of fire and gas detectors may have been bypassed or inoperable at the time of the casualty. The 1989 IMO MODU Code is insufficient because it does not include specific requirements for the design and arrangement of gas detection and alarm systems. This concern has not been corrected in the 2009 IMO MODU Code.
- F. Separation of the Drill Floor from the adjacent occupied areas by A-class bulkheads, as specified by the 1989 IMO MODU Code, did not provide effective blast protection for the crew. The majority of injuries occurred in the accommodations areas separated from the Drill Floor by A-class bulkheads. The 1989 MODU Code is insufficient because it does not include minimum standards for the blast resistance of occupied structures. The 2009 IMO MODU Code is also insufficient because it only requires an evaluation to ensure the level of blast resistance of accommodation areas adjacent to hazardous areas is adequate, and fails to address structures housing vital safety equipment.
- G. The arrangement of main and emergency generators on *DEEPWATER HORIZON* met the requirements of the 1989 IMO MODU Code for separation by A-60 divisions; however, the arrangement of air inlets was not adequately taken into account. Flammable gases may have affected all six engine rooms since their air inlets were not exclusively located. The 1989 IMO MODU Code is insufficient because it does not require the separation of the emergency generator air inlets from likely sources of flammable gases. This concern has not been corrected in the 2009 IMO MODU Code.
- H. The Republic of the Marshall Islands' (RMI) "clerical error" in listing *DEEPWATER HORIZON* as a self-propelled MODU instead of a dynamic positioned vessel enabled Transocean to implement a dual-command organizational structure on board the vessel. This arrangement may have impacted the decision to activate the vessel's emergency disconnect system (EDS). Even though the master, who was responsible for the safety of his vessel, was in the CCR at the time of the well blowout, it cannot be conclusively determined whether his questionable reaction was due to his indecisiveness, a lack of training on how to activate the EDS or the failure to properly execute an emergency transfer of authority as required by the vessel's operations manual. U.S. regulations do not address whether the master or OIM has

the ultimate authority onboard foreign registered dynamic positioned MODUs operating on the U.S. Outer Continental Shelf.

- I. By not visiting and inspecting *DEEPWATER HORIZON*, RMI lacked the ability to validate or audit its recognized organizations (ROs) in order to ensure that their inspection reports were accurate and that the RO was adequately performing its role.
- J. Class surveyors may not always perform regulatory oversight on a specific system unless it is part of the survey. Pieces of the statutory inspection are integrated into the classification survey which results in an incremental examination. Even though a surveyor is frequently on board, the possibility exists that a system may not be inspected until it is required by regulations.
- K. The Coast Guard's current guidance for inspectors performing MODU Certificate of Compliance examinations and the casework process contained in the Coast Guard Marine Information for Safety and Law Enforcement database system do not provide inspectors with a sufficient level of detail for documenting and entering examination activities. Only the main categories of inspected systems are provided. As a result, it is impossible to understand which specific systems were satisfactorily examined by the Coast Guard.
- L. The guidance circulars used by Coast Guard MODU inspectors and the offshore industry are inadequate.

This section describes the events onboard the offshore mobile drilling unit (MODU) *DEEPWATER HORIZON* following the explosions and fire on April 20, 2010 at 2150 hours local time until April 22, 2010 when the vessel sank. It provides an overview of the fire-fighting and emergency response by the crew, describes the fire-fighting and fire protection systems onboard the vessel and the vessel's structural fire protection measures, and identifies system limitations and deficiencies and crew actions and decisions that may have impacted the course of the fire and fire-fighting activities.

### I. Overview

As a result of the combustible gas explosion on the Drill Floor at approximately 2150 on April 20, 2010, *DEEPWATER HORIZON* experienced a significant fire that lasted until approximately 1026 on April 22, 2010, when the MODU sank. Crew members on the vessel's fire brigade initially attempted to respond to the fire as assigned by the MODU's emergency procedures. The chief mate, who was the assigned on-scene fire brigade team leader, testified that after the initial explosion, he responded to the fire equipment locker, but was not immediately joined by the other assigned fire brigade members, and "was basically waiting for any fire team-wise to show up."<sup>114</sup>

"I grabbed my radio back off my desk and headed out of the starboard door and went to the Fire Gear Locker Number 1, which is port forward and just aft of the bridge. And I began -- I grabbed a jacket at first, was the only thing I grabbed as far as suiting up and waited.... I got reports that there was a man down over by the starboard crane so I made my way over there.... I knew I couldn't move him myself so I went to get help. I went back to the gear locker and one more person showed up there. They suited up in fire gear."<sup>115</sup>

After the second explosion, the chief mate decided to abandon fire-fighting efforts and focus on evacuation.

At that point.... another explosion went off and we couldn't get back to him basically. The area was obstructed.... We basically started making our way to the boats.... We were just trying to get people out of there."<sup>116</sup>

Concurrently, the chief engineer and two other members of the crew left the Central Control Room/Bridge (CCR) and made an unsuccessful attempt to start the standby generator in order to bring one of the main generators on line to supply electrical power for the fire pumps.<sup>117</sup> The chief engineer testified that he believed that if the emergency disconnect system (EDS) could have been activated and the MODU unlatched from the riser, the fire could have been fought with the available fire-fighting equipment on *DEEPWATER HORIZON*.

---

<sup>114</sup> Testimony [REDACTED] 5/27/2010 p 287.

<sup>115</sup> Testimony [REDACTED] 5/27/2010 pp 264-266,

<sup>116</sup> Testimony [REDACTED] 5/27/2010 pp 265-266.

<sup>117</sup> Testimony [REDACTED] 7/19/2010 p 191.

“After I had spoken with [REDACTED] about EDSing, my thinking was that if the BOP had separated, then we would have cut off the source of the fuel. At that time, all the fuel that would be in the riser would burn out and we were going to -- then we're facing a fire that we could actually control and put out. And to do that, we needed power and we need fire pumps. That's why I went to the standby generator to get it started to get us more power if we needed the compressors or whatever to get the main engines started then it would be online and running.”<sup>118</sup>

When efforts to start the standby generator failed, and it became apparent that the EDS had not disconnected the riser from the well and the hydrocarbons fueling the fire, the master made the decision to abandon ship. In his testimony, the master provided his reasoning behind the decision:

“Q. In a situation such as occurred on *DEEPWATER HORIZON* on the 20th of April, at what point did you draw the line and say fire-fighting was no longer an option and abandonment was required?

A. When we blacked out and had no power to run the fire pumps.

\*\*\*

Q. After you gave the direction to go ahead and exercise the EDS, what happened after that?

A. Well, it was pretty straightforward. No -- the fuel to the fire wasn't -- wasn't shut off. We had -- we were dark. We had no fire pumps. There was nothing left else to do but leave the vessel -- abandon.”<sup>119</sup>

The officers in charge and the visiting company executives in the CCR were faced with making rapid decisions regarding the emergency actions to take after the explosions and fire occurred. There is, however, no evidence that prior to the abandonment of the MODU, there was any organized effort to determine the condition or location of crew members who may have been injured or trapped.

## II. Systems

*DEEPWATER HORIZON* was equipped with a range of fire-fighting and fire safety systems that included (1) a fixed fire main system designed to supply seawater to fire hose stations located throughout the unit; (2) an automatic sprinkler system for the protection of the accommodations and service areas; (3) fixed total flooding carbon dioxide systems for the protection of the main engine and control rooms and other critical areas; (4) a fixed foam system for the protection of the helideck; and (5) a structural fire protection system comprised of fire resistant bulkheads and decks, intended to prevent or delay the spread of fire between discrete areas. This section will

---

<sup>118</sup> Testimony [REDACTED] 7/19/2010 p 191.

<sup>119</sup> Testimony [REDACTED] 5/27/2010 pp 182, 191.

describe the specifications of these systems and identify specific limitations and deficiencies in these systems made apparent by the fire on *DEEPWATER HORIZON*.

## A. Fire-fighting System Specifications

### 1. Fire Main

*DEEPWATER HORIZON* was equipped with a fixed fire main system throughout all decks that was pressurized by two electric motor driven fire pumps located in Engine Rooms # 1 and # 6 on the second deck. Each fire pump was sized to provide 100% of the maximum fire water demand, and was rated for 125 m<sup>3</sup>/hr at 55 m head (550 gpm at 78 psi). The fire main pumps draw water from the salt water system used to supply cooling water to the main engines and other drilling related equipment. The fire pumps automatically started upon detection of pressure drop in the fire main. Both pumps could be started locally in the pump rooms and were furnished with local and remote pressure gauges located on the suction and discharge flanges. If the fire pumps were inoperable, the electric motor driven ballast pumps and salt water service pumps could be aligned to supply the fire main.<sup>120</sup>

Main and emergency electrical power for the fire pumps was supplied by the six main engines. The standby generator was not configured to operate the fire pumps.<sup>121</sup>

Because of the height of the MODU above the water surface, the salt water service pumps were used to boost pressure to the fire pumps. The salt water service pumps were located in the four lower pump rooms, one in each quadrant of the pontoons. Each salt water service pump was rated for 525 m<sup>3</sup>/hr at 83 m head (2312 gpm at 118 psi). The salt water service pumps took water directly from the sea through fittings in the hull below the waterline located in each column, to supply a number of onboard systems, including cooling water for the thrusters and main engines and service water for the mud pits, water makers, sanitary system, and fire protection systems. Pressure in the salt water service main was controlled by two back-pressure controllers that opened and closed valves as needed to control flow in the system. Excess flow from the system was discharged overboard.<sup>122</sup>

The fire main system supplied water to hose stations located on the third deck and above. Hose stations in the columns below the third deck were supplied directly from the salt water service system instead of the fire main, because of the lower elevation of the hose stations. The elevation difference between the fire pumps and lower hose stations would have caused excessive system pressure. Hose stations on the Drill Floor, main deck and at the lifeboats were 63 mm (2-1/2 in) diameter. Elsewhere on the rig and in the crew accommodation areas, the hose stations were 38 mm (1-1/2 in). Each hose station included collapsible hose stowed on a hose

---

<sup>120</sup> *DEEPWATER HORIZON* Operations Manual March 2001 Section 7.1.6, ABSDWH000310; Section 9.4.1, ABSDWH000593.

<sup>121</sup> *DEEPWATER HORIZON* Operations Manual March 2001 Section 7.1.6, ABSDWH000310; Section 9.4.1, ABSDWH000593; *DEEPWATER HORIZON* Safety and Fire Control Plan, ABSDWH000599-611.

<sup>122</sup> *DEEPWATER HORIZON* Operations Manual March 2001 Section 7.1.3, ABSDWH000308.



rack with an angle valve, nozzle, and spanner wrench. Hose stations in the engine rooms were supplied with applicator type nozzles.<sup>123</sup>

In addition to the hose stations, the fire main supplied water to an 80 m<sup>3</sup>/hr (350 gpm) stationary monitor<sup>124</sup> (nozzle) that protected the well test equipment area, the automatic sprinkler system protecting the crew accommodations area, and the Drill Floor cellar deck deluge system protecting the bulkhead that separated the crew accommodations area from the Moon Pool. The Drill Floor cellar deck deluge system was designed to provide cooling water at a rate of at least 6 lpm/m<sup>2</sup> (0.15 gpm/ft<sup>2</sup>) over the bulkhead that separated the Moon Pool from the forward accommodations area. The system was manually actuated when needed by a crew member opening the system valve located near the port crane.<sup>125</sup>

## 2. Accommodation Area Automatic Sprinkler System

A wet pipe automatic sprinkler system was installed for the protection of the crew accommodation and service areas on the second and third decks. The sprinkler heads were Automatic Sprinkler Company of America (ASCOA) ½ inch orifice model H sprinkler heads that automatically opened at a temperature of 68°C (154°F). The system also included ten sprinkler heads in the galley with a 93° C (200°F) operating temperature. The system was hydraulically designed to provide a water application rate of 5 lpm/m<sup>2</sup> (0.12 gpm/ft<sup>2</sup>) over the most remote area of 280 m<sup>2</sup> (3,000 ft<sup>2</sup>).

The system was supplied through a 3000 liter (792 gal) fresh water pressure tank located in the starboard forward column at elevation 28.5 m (94 ft). The pressure in the tank was maintained by a connection from the unit's air compressor system. Water supply to the tank was provided by a feed from the fresh water system. A seawater connection from the fire main was also provided downstream from the tank. The pressure tank discharged through separate 100 mm (4 inch) diameter risers to each deck through ASCOA Model 353 alarm check valves.<sup>126</sup>

If power was lost to the fire pumps, the residual water supply in the storage tank was capable of supplying the sprinkler system for a period of slightly over two minutes. It is possible that this occurred during the casualty: one of the cementers testified that during his escape from the accommodation areas, he observed the sprinklers discharging even though there was no fire in the immediate area.<sup>127</sup>

---

<sup>123</sup> Applicators are fire-fighting nozzles consisting of a metal "L" shaped pipe about 2 m (6 feet) in length fitted with a water fog fire nozzle on the short segment of the device.

<sup>124</sup> A monitor nozzle, sometimes called a water cannon, is a large bore fire-fighting nozzle permanently fixed to installed piping that is used to discharge large volumes of water from a distance. Monitor nozzles discharge greater quantities of fire-fighting water than can be safely controlled by fire-fighters using hand hose lines.

<sup>125</sup> *DEEPWATER HORIZON* Operations Manual March 2001 Section 7.1.6, ABSDWH000311.

<sup>126</sup> Water Sprinkler Fire Extinguishing System Drawings, Hyundai Heavy Industries Co., LTD, ABSDWH004187-4235.

<sup>127</sup> Testimony █████ 5/28/2010 p 261.

### 3. Fixed Carbon Dioxide Systems

*DEEPWATER HORIZON* was also fitted with three fixed total flooding carbon dioxide (CO<sub>2</sub>) systems. The main carbon dioxide system provided fire protection for:

- Engine Rooms # 1-3 (port)
- Engine Rooms # 4-6 (starboard)
- 11 kV Switchgear Rooms # 1-3 (port)
- 11 kV Switchgear Rooms # 4-6 (starboard)
- 11 kV Switchboard Rooms (port & starboard)
- 600 V Switchgear Rooms (port & starboard)
- 480 V Switchboard Rooms (port & starboard)
- Motor Control Center rooms (port & starboard)
- Fuel Oil Rooms (port & starboard)
- Engine Control Room
- Mud Pit Room

The system consisted of twenty-four 45 kg (100 lb) capacity high pressure CO<sub>2</sub> cylinders fitted with manual pneumatic remote and local releasing controls. The CO<sub>2</sub> cylinders were located in a room on the centerline aft on the main deck above the engine rooms. When the systems were activated, a 30 second time delay was provided to allow personnel to escape from the protected space prior to the discharge of gas. CO<sub>2</sub> powered sirens would sound in each space to warn of impending discharge. In areas with operating machinery, visible alarms would activate to provide additional warning.

A second CO<sub>2</sub> system, consisting of four 45 kg (100 lb) high pressure CO<sub>2</sub> cylinders protected the standby generator room and paint locker. The cylinder storage room for this system was located on the main deck adjacent to the standby generator.

The third CO<sub>2</sub> system was designed for the protection of the occupied CCR. The system consisted of ten 45 kg (100 lb) CO<sub>2</sub> cylinders that were stored in a dedicated room, just aft of the control room. CO<sub>2</sub> powered pre-discharge alarms along with a 30-second time delay were installed in the protected space.

All of the systems were designed to be manually activated by crew members from remote release stations located near the entrances to the protected spaces, and in the respective CO<sub>2</sub> storage rooms. Except for the systems protecting the standby generator room and paint locker, each system had pressure operated switches installed in the discharge piping between the stop valves and time delays to automatically shut down ventilation systems in the protected areas before CO<sub>2</sub> was discharged.<sup>128</sup>

---

<sup>128</sup> High Pressure CO<sub>2</sub> Fire Extinguishing System Drawings, Hyundai Heavy Industries Co., LTD, ABSDWH004163-4180.

#### 4. Helideck Foam System

The *DEEPWATER HORIZON* helideck and adjacent JP-5 fueling equipment was protected by a fixed foam system. The system utilized 3% Aqueous Film Forming Foam (AFFF) as an extinguishing medium, stored in a 750 liter (200 gal) Ansul horizontal bladder tank located on the roof of the central control room. Foam could be discharged from three 63 mm (2-1/2 in) hose reels and three 76 mm (3 in) fixed monitors located at each of the three access stairways to the helideck. The JP-5 fuel unit was protected by six Grinnell model B-1 overhead foam/water sprinklers that were supplied through a separate discharge line from the foam system.

#### 5. Structural Fire Protection

*DEEPWATER HORIZON*'s structure was subdivided by fire-resistant bulkheads and decks designed to contain fires to the space or area of origin, and to limit fire spread to uninvolved areas. These structural fire protection measures were designed to comply with standards contained in Table 9.1 of the 1989 International Maritime Organization (IMO) MODU Code. There are two defined levels of protection in the Code. A-class divisions are intended to prevent the spread of fire for 60 minutes, while B-class divisions prevent the spread of fire for 30 minutes. These levels of protection are intended to shield the crew for a sufficient time period to allow escape from the affected areas, and allow the fire brigade to safely assemble and begin fire-fighting efforts. In accordance with this table, the CCR and CO<sub>2</sub> room were separated from adjacent areas by A-60 class divisions.<sup>129</sup> The paint locker, warehouse, and electrical equipment rooms were surrounded by A-0 class boundaries. The standby generator room was separated from adjacent areas by A-0 class divisions, except for an A-60 starboard bulkhead which separated the generator room from the paint locker. The galley was separated from the adjacent mess area by A-class bulkheads. The sack storage room was separated by A-class divisions except that the forward bulkhead which shared a boundary with the accommodation spaces, and the aft bulkheads which shared a boundary with Engine Rooms # 5 and # 6, were A-60 class divisions.

In addition to the bulkhead and deck classification requirements in Table 9-1, paragraph 9.1.3 of the 1989 IMO MODU Code requires exterior boundaries of superstructures and deckhouses enclosing crew accommodation areas to be constructed of A-60 class divisions for the entire portion which faces and is within 30 m (98 ft) of the center of the Drill Floor rotary table. Because of this requirement, A-60 bulkheads were used to surround the drilling area on the second and third decks. The drilling area on the main deck (at elevation 41.5 m (136 ft)), and drilling floor (at elevation 46 m (151 ft)) did not abut any accommodations and consequently were not bounded by fire rated divisions. Because the driller's work station located on the Drill Floor was considered part of the industrial process area, it was not subject to any structural fire

---

<sup>129</sup> In addition to 60 minutes of fire resistance, fire rated divisions may be insulated to limit the temperature rise on the fire unexposed side of the division. Such divisions are designated by an alpha-numeric rating system, where the letter indicates whether the division provides 30 or 60 minutes of fire resistance, while the numeral indicates the insulating value of the division. An A-60 bulkhead, for example, provides both 60 minutes of fire integrity and 60 minutes of temperature rise limitation. An A-0 bulkhead (typically a bare 3 mm (1/8 inch) thick steel bulkhead) will have 60 minutes of fire integrity, but no insulating capability.

protection requirements, and thus was permitted to have large windows facing the Drill Floor to allow the Drillers to view ongoing operations.

## **B. System Limitations and Deficiencies**

The *DEEPWATER HORIZON* fire exposed several limitations and deficiencies of the MODU's fire safety systems. This investigation identified the following areas of concern:

### **1. Operation of the fire main system was not possible after the main generators were disabled.**

Paragraph 9.4.2 of the 1989 IMO MODU Code requires that “at least one of the required fire pumps should be dedicated for fire-fighting duties and be available at all times.” The requirement to “be available at all times” was satisfied by the presence of electric motor driven fire pumps in both Engine Rooms #1 and #6. Once the explosions had disabled all of the main and emergency generators, however, the electric motor driven fire pumps could not be operated. The standby generator did not have sufficient capacity to operate the fire pumps, as it was only sized to supply a limited electrical load sufficient to power back-up lighting and the air compressors needed to restart the main engines.<sup>130</sup> Thus, even had the fire brigade laid out the hoses and tried to fight the fire, or activated the Drill Floor cellar deck deluge system, it would not have been possible to pressurize the systems. This incident illustrates that a fire main system that has only electric motor driven fire pumps is vulnerable to a total loss of electrical power. A system that included diesel engine driven fire pumps as well may have provided the ability to operate the fire main under such circumstances.

### **2. A-class structural fire protection barriers were not effective against a hydrocarbon fire exposure.**

A-class bulkheads are not expected to function as effective fire barriers when exposed to a hydrocarbon fire source. The IMO MODU Code structural fire protection requirements were taken from the International Convention for the Safety of Life at Sea (SOLAS) Chapter II-2 regulations for passenger and cargo ships. The fire scenarios envisioned are typical accommodation area fires involving ordinary combustibles.<sup>131</sup> The approval of A-class bulkheads is based on a standard SOLAS fire test method intended to replicate the burning of materials found in staterooms, such as wood, paper and plastic. The fire risk posed by different fire sources is linked to the fuel's heat of combustion, which for ordinary combustible materials, is in the range of 16-19 MJ/kg (7,000 to 8,000 BTU/lb). Hydrocarbons are capable of causing more severe fires since their heat of combustion is expected to be in the 44-51 MJ/kg (19,000-22,000 BTU/lb) range.<sup>132</sup> The 1989 IMO MODU Code does not include any specific fire safety measures to protect against hydrocarbon based fires.

---

<sup>130</sup> Testimony ██████████ 7/23/2010 p 19.

<sup>131</sup> Senate Report No. 184, March 1937, pp 70-73, “Fire Tests on the Steamship *NANTASKET*, Transactions of the Society of Naval Architects and Marine Engineers, Volume 45, Fire Protection Handbook, National Fire Protection Association, Quincy, MA, 19<sup>th</sup> Edition, pp 14-103 -14-104.

<sup>132</sup> Fire Protection Handbook, National Fire Protection Association, Quincy, MA, 19<sup>th</sup> Edition, Tables A-1 through A-3.

In this instance, the spread of fire after the initial explosions was not limited by the A-class bulkheads onboard *DEEPWATER HORIZON*, and resulted in one of the visiting Transocean executives suffering serious burns. At the time of the blowout, the executive was in the hallway outside the offshore installation manager (OIM) office on the second deck, near the doorway to the Sack Room. Although an A-class bulkhead and fire door separated the Sack Room from the hallway, the visiting executive nevertheless suffered serious injuries.<sup>133</sup> Thus, in this instance, the use of A-class bulkheads to separate the drilling area from the accommodation spaces, service spaces and control stations did not provide an adequate level of protection to limit the spread of a hydrocarbon fire.

Accepted standards are available to resolve this issue. A more stringent laboratory fire test method has been developed to simulate exposure to large scale hydrocarbon fires. Fire barriers that have met the standards of the hydrocarbon fire test are designated as H-class fire barriers. Details of the H-class fire test may be found in ASTM E 1529, *Standard Test Methods for Determining Effects of Large Hydrocarbon Pool Fires on Structural Members and Assemblies*.

Moreover, the IMO MODU Code was revised in 2009 and now contains the following new standard:

“In general, accommodation spaces, service spaces and control stations should not be located adjacent to hazardous areas. However, where this is not practicable, an engineering evaluation should be performed to ensure that the level of fire protection and blast resistance of the bulkheads and decks separating these spaces from the hazardous areas are adequate for the likely hazard.”

Footnote (e) of Table 9.1 clarifies that this requirement only applies to Type 1 spaces (control stations), Type 2 spaces (corridors), Type 3 spaces (accommodations) or Type 4 spaces (stairways) that are adjacent to a hazardous area. This application, however, fails to consider the need to protect vital safety systems and equipment such as fire extinguishing systems, fire pumps, emergency generators, dynamic positioning controls and other equipment that could be located in Type 5 through 11 spaces such as machinery spaces or service spaces. The *DEEPWATER HORIZON* fire illustrates the importance of including consideration of all safety equipment located adjacent to hazardous areas in the engineering evaluation specified by paragraph 9.3.1, irrespective of the type of space where this equipment is located.

Notably, the IMO MODU Code does not provide guidelines for performing the engineering evaluation or determining acceptance criteria. Rather, the generally worded requirement to ensure that the level of fire protection of the bulkheads and decks separating accommodation spaces from the hazardous areas is adequate for the likely hazard, does not clearly indicate how the necessary fire protection measures are to be determined.

---

<sup>133</sup> Witness Statement [REDACTED] 4/26/2010.

**3. No fixed fire-extinguishing system was installed for the protection of the Drill Floor and adjacent areas.**

The IMO MODU Code does not require the installation of deluge systems for the protection of the Drill Floor and adjacent areas. In this instance, had the crew been able to successfully disconnect from the riser and regain electrical power, the fire brigade would have had to fight the fire manually using hoses and the single 80 m<sup>3</sup>/hr (392 gpm) fixed monitor located on the starboard main deck near the well test equipment. The cellar deck deluge system was designed to protect only the rear bulkhead of the crew accommodation area, and thus did not provide protection for the rest of the main Drill Floor. The fitting of a fixed deluge system or multiple high capacity monitors for the protection of the entire Drill Floor area would enable crews to more effectively control well head fires, and could also provide a degree of shielding for crew members in the area. Deluge systems automatically activated by a gas detection system could potentially mitigate blast damage within the protected area.

**4. The use of prescriptive standards alone does not provide an adequate level of fire protection safety for MODUs.**

The *DEEPWATER HORIZON* fire revealed that compliance with prescriptive standards is not sufficient to provide adequate fire safety. The arrangement of the main and emergency generators, and the use of all electric motor driven fire pumps, met the standards of the MODU Code. However, a performance-based analysis of these arrangements could have identified the vulnerabilities in locating the main and emergency generator air inlets within close proximity and the limitations in the use of all electric motor-driven fire pumps.

Although the 1989 IMO MODU Code was amended and significantly improved in 2009, compliance with these prescriptive standards alone does not assure that an adequate level of fire protection safety will be provided, except for limited fire hazard scenarios such as those occurring in accommodation or galley areas. The Code does not contain fire protection standards to protect onboard personnel and safety equipment from hydrocarbon fires. The only section in the Code that addresses emergency conditions due to drilling operations focuses on the selective shutdown of ventilation and electrical power equipment.<sup>134</sup> The Code also does not consider the unique aspects or operations of each MODU. A supplemental risk analysis, beyond the limited prescriptive standards in the Code, would provide a method of evaluating the specific design and arrangement of each MODU to determine if safety improvements could be made by reconfiguring the arrangement or location of systems and structures.

### **III. Actions/Decisions Contributing to System Failure**

Although there is insufficient evidence to conclude that crew decisions relating to fire-fighting would have had a demonstrable impact on the course of events, two decisions by the crew may have reduced the overall effectiveness of the fire safety system.

---

<sup>134</sup> Code for the Construction and Equipment of Mobile Offshore Drilling Units, 1989, Chapter 6, Section 6.5.

**A. The fire brigade members quickly decided that the fire was not controllable and did not begin active fire-fighting efforts.**

Crew members testified that they believed onboard fire-fighting efforts would have been to no avail:

“And that time my first thought was to go to the fire-fighting equipment. Being that when I got there I wasn't the only one there, I was -- I was -- as I was untying my boots to put on the fire-fighting equipment. I noticed that I was the only one there. I looked up at the derrick again and by that time I knew that we were not going to be able to fight this fire. So, I decided to tie my boots back on and make myself -- my way to the lifeboat deck. When I got down there was some other members of the roustabout crew and they told me that they had been to the fire-fighting equipment, but they thought the same as I did that there was no way that we were going to be able to put the fire out.”<sup>135</sup>

Although the decision to not fight the fire is considered a reasonable response in this case, post-casualty review of onboard weekly fire drill records found some evidence that drills may have become routine and that the crew was not fully engaged in them. Fire drills were held at the same time, on the same day every week, on Sunday at 1030.<sup>136</sup> Personnel involved in drilling activities whose responsibilities at that time were to continue monitoring important systems were excused from the drills.<sup>137</sup> The record of the fire drill held on April 18, 2010, just two days prior to the casualty, recommended that more focus be given to the proper donning of personal protective equipment during drills, since it was observed that the brigade members were hesitant to put on hoods during exercises because they were hot and uncomfortable. Further, the OIM placed a comment in the record that fire drills need to be treated as “the real deal.”<sup>138</sup> The crew's approach to fire drills may have influenced its response to the fire during this casualty.

**B. The responsible officers took no actions to discharge any of the fixed CO<sub>2</sub> systems protecting important equipment.**

Following the initial explosions, the crew did not attempt to activate any of the manually released CO<sub>2</sub> systems protecting the Engine Rooms, Switchgear Rooms, Motor Control Center Rooms, Fuel Oil Rooms, Engine Control Room and Mud Pit Rooms. This was most likely attributable to the very short time period between the onset of the incident and when the abandon ship order was given. As previously noted, the assembled members of the fire brigade had quickly decided that the fire was uncontrollable, and that abandonment was the more prudent course of action. Moreover, it is likely that blast damage to the enclosure bulkheads of the protected areas had caused enough damage to the structure to prevent the total flooding extinguishing systems from operating effectively.

---

<sup>135</sup> Testimony ██████████ 5/29/2010 pp 145-146.

<sup>136</sup> Testimony ██████████ 5/26/2010 pp113-114; Testimony ██████████ 5/27/2010 pp 46-47.

<sup>137</sup> Testimony ██████████ 5/27/2010 pp 204-205; Testimony ██████████ 10/5/2010 pp 200-201.

<sup>138</sup> Safety Drill Report, 18 April 2010, Document Number DWH-2010-Apr-045-SAF, TRN-USCG\_MMS-00042610.

Witness testimony revealed that the CO<sub>2</sub> system in the Electronics Technician Room forward of the ECR discharged after the initial explosions.<sup>139</sup> While it is unknown what caused the system to operate, it is believed that the force of the explosion may have produced this unintended operation. If the explosion had also caused one of the fixed carbon dioxide systems protecting the main engine rooms to discharge, the pressure operated switches on the control piping would have shut down the ventilation systems for the engine rooms. Thus, to the extent that the explosion had not already disabled the engines and generators, the discharged of the full extinguishing concentration of carbon dioxide would have had the same effect.

#### IV. U.S. Government/Class/Flag Oversight

See related information in Chapter 1, “Explosion.”

#### V. Conclusions

- A. The fire brigade members quickly decided that the fire was not controllable and did not begin active fire-fighting efforts. Although that was a reasonable response in this case, there is evidence to support the view that the routine, repetitive nature of the weekly fire drills had led to a degree of complacency among the crew members and that personnel did not fully embrace the importance of fire brigade exercises.
- B. The fire main system was not capable of operation after all electrical power was lost, because only electric motor driven fire pumps were provided. The 1989 IMO MODU Code as amended in 2009 is insufficient because it does not require a portion of the pumping capability to be supplied by diesel pumps or similar independent sources.
- C. The A-class fire barriers surrounding the Drill Floor were not effective in preventing the spread of the fire. A-class bulkheads are not tested for exposure to hydrocarbon fire sources. The 1989 IMO MODU Code as amended in 2009 is insufficient because it does not require fire separations between the drilling area and adjacent accommodation spaces or spaces housing vital safety equipment to withstand such exposures.
- D. There is no evidence that any consideration was given prior to abandonment of the MODU to trying to determine the condition or location of crew members who may have been injured or trapped, except for the chief mate’s independent attempt to organize the rescue of the starboard crane operator, only to be driven back by subsequent explosions. It was not until the safety of *DAMON B. BANKSTON* was reached that a full accounting of the crew was undertaken by those in charge.
- E. The use of manual fire hoses to fight a hydrocarbon fire of the magnitude experienced on the Drill Floor and adjacent areas of *DEEPWATER HORIZON* could expose the onboard fire brigade members to dangerous levels of fire and heat. A fixed deluge system for the protection of these areas would not place the fire brigade members in jeopardy and could be rapidly activated upon gas detection to mitigate the effects of a possible explosion.

---

<sup>139</sup> Testimony [REDACTED] 7/23/2010 p 14.



- F. The prescriptive standards in the IMO MODU Code do not provide an adequate level of fire protection when considering fires of the magnitude experienced on the Drill Floor and adjacent areas of *DEEPWATER HORIZON*. The 1989 MODU Code is insufficient because it does not require a supplemental performance-based risk analysis to calculate the necessary levels of protection for the unique design, arrangement and operation of each MODU. The 2009 amendments to the IMO MODU Code now require an engineering evaluation to determine the level of fire protection needed for occupied areas that are located adjacent to the hazardous areas on the Drill Floor, but it does not provide guidance on the method for performing the engineering evaluation or defining acceptance criteria.

This section describes and analyzes the events on board the mobile offshore drilling unit (MODU) *DEEPWATER HORIZON* following a series of explosions and the ensuing fire beginning at approximately 2150 on April 20, 2010 and continuing until approximately 1900 on April 23, 2010 when the active Search and Rescue (SAR) efforts were suspended. This section provides an overview of the initial emergency notification of the casualty on board *DEEPWATER HORIZON*, mustering and evacuation of the crew, the available primary lifesaving equipment and systems, and the effectiveness of these systems. This section also reviews government and third party oversight of *DEEPWATER HORIZON*'s inspections and surveys of the primary lifesaving equipment.

### I. Overview

#### A. Notification of Emergency

At approximately 2150 on April 20, 2010, the master and the on-watch senior dynamic positioning officer (SDPO) were escorting four members of the BP and Transocean leadership team on a familiarization tour through the *DEEPWATER HORIZON* Central Control Room/Bridge (CCR), including a hands-on experience operating the dynamic positioning (DP) simulator.<sup>140</sup> Suddenly, the on-watch dynamic positioning officer (DPO) yelled, "We're in a well control situation."<sup>141</sup> Soon thereafter, there were explosions causing a fire and a loss of electrical power on board *DEEPWATER HORIZON*. The first official notice of the emergency to the MODU crew came from the general alarm, which was activated by the DPO.<sup>142</sup> Simultaneously, the on-watch SDPO verbally announced over the MODU's public address system, "This is not a drill ... muster at your emergency stations."<sup>143</sup> A mud engineer on board later testified that he heard an announcement, "Fire, fire, fire, this is not a drill ... report to secondary muster stations, do not go outside."<sup>144</sup>

After learning that three or four personnel from *DEEPWATER HORIZON* had jumped into the water, the SDPO called the offshore supply vessel *DAMON B. BANKSTON*, which was positioned alongside *DEEPWATER HORIZON*, and asked it to launch its fast rescue craft (FRC) to retrieve any persons in the water.<sup>145</sup> *DEEPWATER HORIZON* also directed the *DAMON B. BANKSTON* to move out to a 500 meter position because of the ongoing well condition and the ensuing explosions and fire.<sup>146</sup>

Following the explosion, the performance coordinator on *DEEPWATER HORIZON*, a BP contract employee from Expeditors and Production Services, used a satellite telephone to call the BP Shore Base in Texas to notify it of the fire, to request resources and advise BP of the

---

<sup>140</sup> Testimony ██████████ 5/10 p 149.

<sup>141</sup> Testimony ██████████ 10/5/10 p 220.

<sup>142</sup> Testimony ██████████ 10/5/2010 p 14.

<sup>143</sup> Testimony ██████████ 10/5/10 p 152.

<sup>144</sup> Testimony ██████████ 5/28/2010 pp 234-235.

<sup>145</sup> Testimony ██████████ 10/5/2010 pp 151-152.

<sup>146</sup> Testimony ██████████ 10/5/2010 p 14; *DAMON B. BANKSTON* Log.

evacuation.<sup>147</sup> At 2206, the BP Shore Base Supervisor notified the U.S. Coast Guard by telephone and advised the BP Houston, Texas Logistics Marine Operations Coordinator to assemble a crisis team.<sup>148</sup>

At 2156, the on-watch DPO activated *DEEPWATER HORIZON*'s Global Maritime Distress Safety and System (GMDSS) Digital Select Calling (DSC) Alert, which was automatically relayed first by *M/V NORDSTERN* to Maritime Rescue Coordinator Center Rome, Italy and then sent to the Eighth Coast Guard District Command Center New Orleans, Louisiana for action.<sup>149</sup>

Coast Guard Sector Mobile, Alabama received *DEEPWATER HORIZON*'s DSC alert, as well as a Good Samaritan VHF radio report from the recreational fishing vessel *RAMBLIN' WRECK* that *DEEPWATER HORIZON* was engulfed in fire and that the personnel were abandoning the MODU.<sup>150</sup> The Coast Guard issued an Urgent Marine Information Broadcast, and approximately twenty vessels operating in the area responded to render assistance.<sup>151</sup>

Coast Guard Air Station New Orleans received the Search and Rescue (SAR) alarm at 2210 and launched Coast Guard helicopter CG-6605 at 2228. At 2310, CG-6605 arrived on scene and assumed the role of On-Scene Coordinator (OSC).<sup>152</sup>

## B. Crew Muster<sup>153</sup>

The chief mate and others went to their assigned Emergency Stations and attempted to execute their Fire and Emergency (evacuation) duties as required by the *DEEPWATER HORIZON* Station Bill.<sup>154</sup> Upon arriving at his Fire and Emergency Station in the CCR, the chief engineer heard "The master screaming at the on-watch DPO for pushing the distress button."<sup>155</sup> After assessing the emergency condition on the Drill Floor and evaluating the fire condition, the chief mate returned to the CCR, reported an uncontrolled fire and informed the master that the crew needed to evacuate.<sup>156</sup>

Personnel attempted to reach their assigned Lifeboat Embarkation Stations at Lifeboat #1 or Lifeboat #2 on the second deck. A crane operator testified that when he reported to his secondary muster station at the galley, also known as the Temporary Refuge Area for Lifeboat # 1, the galley was completely collapsed.<sup>157</sup> He waited with others for about ten seconds until they noticed the door leading to the Lifeboat Deck was open. He and the others then made their way

---

<sup>147</sup> Testimony ██████████ 10/6/2010 pp 12-16.

<sup>148</sup> Statement ██████████ 10/5/2010; CG-53, Final Action Report on SAR Case Study, 3/10/2011, pp G-2.

<sup>149</sup> CG-53, Final Action Report on SAR Case Study, 3/10/2011, pp G-2.

<sup>150</sup> CG-53, Final Action Report on SAR Case Study, 3/10/2011, pp G-8.

<sup>151</sup> CG-53, Final Action Report on SAR Case Study, 3/10/2011, pp G-2,3.

<sup>152</sup> CG-53, Final Action Report on SAR Case Study, 3/10/2011, pp G-5.

<sup>153</sup> The term "muster" in a maritime setting means to assemble the crew for the purposes of accounting for personnel.

<sup>154</sup> Statement ██████████ 4/22/2010.

<sup>155</sup> Statement ██████████ 4/21/2010.

<sup>156</sup> Testimony ██████████ 10/5/2010 p 19.

<sup>157</sup> Testimony ██████████ 5/28/2010 pp 233-234.

to the Lifeboat Embarkation Deck where they found the assistant driller attempting to take a headcount.<sup>158</sup>

During the muster of personnel at Lifeboat # 1, the on-watch compliance specialist thought the muster was taking too long and left the Lifeboat Embarkation Deck, proceeded to the lower smoking deck, and jumped overboard.<sup>159</sup> As discussed above, he and four others were quickly recovered from the water by *DAMON B. BANKSTON*'s FRC before either of *DEEPWATER HORIZON* lifeboats was launched.<sup>160</sup>

As personnel continued to board Lifeboat # 1, crew members attempted to load a stretcher transporting the visiting Transocean operations manager-assets. Once he was loaded, he was taken off the stretcher and the stretcher was thrown out of the lifeboat.<sup>161</sup> The BP Vice President of Drilling & Completion for the Gulf of Mexico, who was assigned to Lifeboat # 2, was one of the last people to enter Lifeboat # 1, along with the on-watch Subsea Engineer. The vice president had to physically wedge himself into the cramped lifeboat to get a seat because some of the injured were laid out. He described the environment inside the lifeboat as "pandemonium."<sup>162</sup> There was "mass confusion" over how occupants could secure themselves with the color coded shoulder harnesses.<sup>163</sup>

According to a crane operator, the muster of personnel at Lifeboat # 2's Embarkation Deck was so chaotic that they attempted to have the mustering personnel count off to determine how many people were at the station. The personnel were so scared that they could not provide an accurate count, so the decision was made that they would just to fill the boat to capacity, load the wounded and launch.<sup>164</sup>

### C. Lifeboat Evacuation

When the Transocean operations manager-performance arrived at the Lifeboat Embarkation Deck from the CCR, he saw that neither lifeboat had launched. He believed that the coxswain of Lifeboat # 2 was awaiting instructions to launch the lifeboat. In the absence of the master, and having observed equipment falling down around them, he told the coxswain of Lifeboat # 2 to "go."<sup>165</sup>

After Lifeboat # 2 had departed, the launching of Lifeboat # 1 was delayed as the Transocean operations manager-performance waited for the master, who was assigned to that boat, to arrive. However, when the master finally appeared, he said, "We have other people. We are going to the rafts." The Transocean operations manager-performance waited for a minute or so and then decided to launch the lifeboat.<sup>166</sup>

---

<sup>158</sup> Testimony ██████████ 5/28/2010 pp 224-225.

<sup>159</sup> Testimony ██████████ 5/28/2010 pp 222-223.

<sup>160</sup> Testimony ██████████ 5/28/2010 pp 223-224.

<sup>161</sup> Statement ██████████ 4/26/2010.

<sup>162</sup> Testimony ██████████ 8/26/2010 pp 396, 405.

<sup>163</sup> Testimony ██████████ 12/7/2010 pp 71-72.

<sup>164</sup> Testimony ██████████ 5/29/2010 p 13.

<sup>165</sup> Testimony ██████████ 8/ 24/2010 pp 15-16; Statement ██████████ 4/26/2010.

<sup>166</sup> Testimony ██████████ 8/23/2010 p 453.

The Transocean operations manager-performance reported that on board Lifeboat #1, the coxswain was “a bit excited” so he told the coxswain “to calm down.” He further instructed the launching and movement of the lifeboat away from *DEEPWATER HORIZON*. He recalled the coxswain was going to turn on the air supply to the lifeboat and the water spray system to cool the boat; however, that was never done. While the coxswain maneuvered the lifeboat toward *DAMON B. BANKSTON*, the Transocean operations manager-performance opened the lifeboat’s door against the coxswain’s order and climbed on top of the lifeboat to activate the windshield wiper and clean the lifeboat’s windshield of drilling mud that had accumulated as a result of the well blowout.<sup>167</sup>

Both lifeboats reached the *DAMON B. BANKSTON* safely.

#### D. Liferaft Evacuation

After both lifeboats had been launched, ten survivors remained aboard *DEEPWATER HORIZON* and attempted to evacuate using davit-launched inflatable liferafts. See Figure 11 *infra*. On his way to the liferaft, the on-watch SDPO saw the master and a few others getting the davit ready while the chief mate was preparing the liferaft.<sup>168</sup> After the davit’s releasing hook was attached to one of the three nearby rafts, the davit itself could not rotate outboard from the side of *DEEPWATER HORIZON* in order to inflate the raft. Upon closer examination, the chief electronics technician noticed that a rope attached to the releasing hook was secured to the davit by means of a shackle, which prevented the davit and liferaft from rotating clear of *DEEPWATER HORIZON*. After he removed the shackle pin with a small tool, the davit finally rotated to allow the liferaft to be inflated.<sup>169</sup>

Once the liferaft was inflated, the chief engineer ran over to a nearby stretcher containing the off-watch toolpusher and proceeded to drag it across the deck to the Liferaft Embarkation Deck. The master said, “Leave him,” referring to the injured man. Nevertheless, the chief mate and the chief electrician boarded the raft first, then assisted the chief engineer in loading the stretcher into the liferaft.<sup>170</sup> After the stretcher was loaded, the chief engineer, electrical supervisor, the senior toolpusher, and the DPO boarded the liferaft.<sup>171</sup>

During the loading of the liferaft, the raft was slowly rotating, swinging, filling with smoke and becoming very hot. According to the chief engineer, the flames and heat coming down the forward part of the deck and from under the column-stabilized hull of *DEEPWATER HORIZON* created a vortex at the Liferaft Embarkation Station.<sup>172</sup> After entering the raft, the chief engineer felt the heat of the fire penetrating the clothing covering his knees and the leather gloves protecting his hands. One occupant in the liferaft yelled, “We are going to die.”<sup>173</sup>

---

<sup>167</sup> Testimony ██████████ 8/23/2010 pp 453-455; Statement ██████████ 4/26 /2010.

<sup>168</sup> Testimony ██████████ 10/5/2010 p 153.

<sup>169</sup> Statement ██████████ 4/21/2010.

<sup>170</sup> Statement ██████████ 4/21/2010.

<sup>171</sup> Testimony ██████████ 5/27/2010 pp 332-333.

<sup>172</sup> Testimony ██████████ 7/19/2010 p 45

<sup>173</sup> Testimony ██████████ 7/19/2010 p 46.

The chief electronics technician, who was standing on the Liferaft Embarkation Deck and waiting to board the liferaft, saw fire coming out of the top of the derrick and projectiles coming from everywhere. This combination of events created a back draft underneath *DEEPWATER HORIZON*. At that point, he felt unsure whether the liferaft would survive the heat or “was going to pop and melt, and the people inside were going to cook.”<sup>174</sup>

As the master, on-watch SDPO and the chief electronics technician waited to board the liferaft, it filled with black smoke and got so hot that the chief mate could not find the brake handle to release the raft.<sup>175</sup> Someone within the liferaft told the master, “Let’s go!” and “You all get in.” But the master did not board and said “not to worry about him.”<sup>176</sup> The chief mate finally pulled the release handle that began the raft’s descent.<sup>177</sup>

The master, on-watch SDPO, and the chief electronics technician were left aboard *DEEPWATER HORIZON* at the Liferaft Embarkation Station. The master determined there was not enough time to manually crank the davit’s releasing hook back to the davit to deploy another liferaft.<sup>178</sup> When the on-watch SDPO asked the master, “What about us?” the master said, “I don’t know what you’re going to do, but I’m going to jump.”<sup>179</sup> The master then jumped approximately fifty feet<sup>180</sup> into the water, followed by the on-watch SDPO.<sup>181</sup> The chief electronics technician made his way to the Helicopter Landing Deck from which he jumped approximately seventy-one feet into the water.<sup>182</sup> They did not use the fixed metal ladders extending from the embarkation deck to the surface of the water.<sup>183</sup>

As the liferaft quickly descended approximately thirty-five feet below the Liferaft Embarkation Deck, the liferaft’s painter line, which was still attached to the MODU, became taut.<sup>184</sup> The liferaft tilted approximately 90 degrees, ejecting the off-watch toolpusher from the stretcher while the other occupants tumbled within the confines of the liferaft.<sup>185</sup> Once the liferaft hit the water, the on-watch DPO fell out of the raft and swam away.<sup>186</sup> The chief mate, chief electrician, chief engineer and the on-watch motorman exited the raft and began pulling it away from the burning *DEEPWATER HORIZON*.<sup>187</sup>

Someone then noticed the painter line was still attached to *DEEPWATER HORIZON*. None of the occupants of the liferaft had a knife to cut the painter line, nor could they find the knife

---

<sup>174</sup> Testimony ██████████ 7/23/2010 p 23.

<sup>175</sup> Testimony ██████████ 5/27/2010 pp 268-269.

<sup>176</sup> Testimony ██████████ 10/5/2010 p 154.

<sup>177</sup> Testimony ██████████ 5/27/2010 p 333.

<sup>178</sup> Testimony ██████████ 5/27/2010 p 210.

<sup>179</sup> Testimony ██████████ 10/5/2010 pp 155-156.

<sup>180</sup> Distance determined by *DEEPWATER HORIZON* outboard profile drawing using the drilling draft, ABSDWH000074.

<sup>181</sup> Testimony ██████████ 10/5/2010 p 156.

<sup>182</sup> Distance determined by *DEEPWATER HORIZON* outboard profile drawing using the drilling draft, ABSDWH000074; testimony ██████████ 7/19/2010 pp 47-48.

<sup>183</sup> Testimony ██████████ 10/5/2010 pp 172-173.

<sup>184</sup> Testimony ██████████ 5/27/2010 pp 269-270.

<sup>185</sup> Testimony ██████████ 5/27/2010 pp 269-270.

<sup>186</sup> Testimony ██████████ 10/5/2010 p 15.

<sup>187</sup> Testimony ██████████ 5/27/2010 p 334.

stored on the liferaft despite the light provided from the fire.<sup>188</sup> By this time, the master and the SDPO had swum over to the liferaft, but neither had a knife.<sup>189</sup> BP had a strict “Knife Free” Policy for the crew while on board *DEEPWATER HORIZON*.<sup>190</sup> As the FRC from *DAMON B. BANKSTON* approached the liferaft, its crew pulled the on-watch DPO and the chief electronics technician from the water and provided a knife to the master who then freed the liferaft.<sup>191</sup> The FRC then towed the raft and those clinging to its outer edges safely to *DAMON B. BANKSTON*.<sup>192</sup>

## E. Search and Rescue (SAR)

Please see Appendices G and H for details on SAR activities.

## II. Systems

### A. Notification of Emergency

The *DEEPWATER HORIZON* operations manual established duties and responsibilities by job title for the personnel that make up the MODU’s emergency response organization.<sup>193</sup> Chapter 10.4, Emergency Procedures for Uncontrolled Escape of Hydrocarbons, assigns the responsibility of emergency response procedures via a tiered response approach. The severity of the emergency is identified using a sliding scale of Phase I, Phase II and Phase III with associated alarm signals to alert the MODU crew.<sup>194</sup>

At Phase I, the offshore installation manager (OIM) is in overall command of the emergency and is responsible for advising the company shore-base management of the status of the emergency and ensuring that the marine crew is ready to move off location. At Phase II, the OIM is responsible for sounding the general alarm (GA), announcing the emergency to the crew and requiring them to muster and prepare to leave the MODU. He must also request that the master move the MODU off the location after consulting with the lessee operator’s drilling representative. Phase III includes the sounding of abandon ship, moving off location, and giving the command to launch the lifeboats.<sup>195</sup>

These procedures were not performed during the casualty. This failure may be attributable in part to the presence of the BP and Transocean executives, also referred to as the “leadership team,” on board *DEEPWATER HORIZON* during the casualty. Their presence may have

---

<sup>188</sup> Statement ██████████ 4/21/2010.

<sup>189</sup> Testimony ██████████ 5/27/2010 p 194.

<sup>190</sup> Statement ██████████ 4/21/2010; Transocean Health and Safety Policies and Procedures Manual, HQS-HSE-PP-01, Section 4.9.

<sup>191</sup> Testimony ██████████ 7/23/2010 p 26.

<sup>192</sup> Testimony ██████████ 7/19/2010 p 49.

<sup>193</sup> IMO MODU Code, Chapter 14 requires an Operating Manual. 46 C.F.R. 109.121 requires that the Operating Manual be approved by the Coast Guard.

<sup>194</sup> *DEEPWATER HORIZON* Operations Manual March 2001 Chapter 10.4, Emergency Procedures for Uncontrolled Escape of Hydrocarbons.

<sup>195</sup> *DEEPWATER HORIZON* Operations Manual March 2001 Chapter 10.4, Emergency Procedures for Uncontrolled Escape of Hydrocarbons.

diverted the attention of the OIM and senior toolpusher from the ongoing well conditions and may have caused the drill crew to limit their interactions with these senior drilling crew members. Specifically, the senior toolpusher noted that as he accompanied the leadership team on a tour of the Drill Floor around 1700, he spoke to the on-watch driller about the negative test procedures and then told the on-watch toolpusher that he “would come back [to the Drill Floor].”<sup>196</sup>

The on-watch toolpusher told the senior toolpusher, “No, I’ve got this,” “Don’t worry about it,” and “If I need anything I will call you.”<sup>197</sup> The senior toolpusher did not return to the floor before the explosion.<sup>198</sup> In fact, leading up to the blowout, neither the OIM, senior toolpusher nor the master were actively supervising the performance of the negative test or the displacement of the mud from the drilling riser with sea water.<sup>199</sup> The senior toolpusher acknowledged that the tour took him away from the Drill Floor: when asked “if the tour wasn’t going on, if there wasn’t visitors, would you have stayed [on the Drill Floor],” he said, “Yes, sir. And I wouldn’t be here talking to you.”<sup>200</sup> Thus, had the BP and Transocean executives not been on board *DEEPWATER HORIZON* that evening, the OIM and the senior toolpusher would likely have been more aware of the existing well conditions. In turn, once the blowout occurred, there is a greater likelihood that they would have been engaged sufficiently to implement the emergency procedures outlined in the operations manual.

## B. Evacuation

On *DEEPWATER HORIZON*, the means of escape, also known as evacuation routes, were arranged to comply with Section 9.3 of the 1989 International Maritime Organization (IMO) MODU Code. The means of escape on *DEEPWATER HORIZON* consisted of two separate evacuation routes from all occupied areas, situated as far apart as practicable, that provided access to the Open Deck and Lifeboat Embarkation Stations.

The Accommodations and Service Areas were located on the forward sections of the Second and Third Decks. The Second Deck had quarters for 55 persons distributed among nine 4-bunk cabins, nine 2-bunk cabins and one 1-bunk cabin. The Third Deck had quarters for 91 crew members, arranged in 43 2-bunk cabins and five 1-bunk cabins.<sup>201</sup>

The evacuation route from the Third Deck up to the Embarkation Area on the Second Deck went up a central stairway located amidships at Frame 25U, or up either of two spiral stairways, one each on the port and starboard at the end of the athwart (from side to side; crosswise) ship corridor. The spiral stairways discharged on the Second Deck adjacent to the Transit Room on the port side, and the Transformer Room on the starboard side. An additional exterior stairway up from the Third Deck was located forward of the Accommodations Area.<sup>202</sup>

---

<sup>196</sup> Testimony ██████████ 5/28/2010 pp 305-306.

<sup>197</sup> Testimony ██████████ 5/28/2010 pp 305-306

<sup>198</sup> Testimony ██████████ 5/28/2010 pp 305-306.

<sup>199</sup> Testimony ██████████ 5/28/2010 pp 305-307; Statement ██████████ 4/21/2010; Statement ██████████ 4/21/2010.

<sup>200</sup> Testimony ██████████ 5/28/2010 pp 305-306.

<sup>201</sup> Second and Third Deck, ABSDWH000609-610.

<sup>202</sup> Third Deck, ABSDWH000610.



Escape from the Second Deck to the forward Life Boat Embarkation Stations was possible through three doors, located on the centerline corridor, in the Transit Room and the Transformer Room.<sup>203</sup>

From the CCR on the Main Deck, the evacuation route ran down a stairway located on the starboard aft side of the space to the Second Deck. An exterior door from the CCR to an exterior walkway with stairs down to the Second Deck was also available.<sup>204</sup>

There were four designated primary Muster Stations, two near the forward Lifeboat Embarkation Stations on the bow and two near the aft Lifeboat Embarkation Stations on the stern. Secondary Muster Stations, also known as Temporary Refuge Areas, were located on the Second Deck inside the Accommodations Area in the mess room and the cinema room.<sup>205</sup> In the event that the forward Muster Stations were inaccessible, the crew could travel up to the Main Deck via internal stairways and use exterior walkways and exterior stairs to go down to the aft Muster Stations and lifeboats on the Second Deck.<sup>206</sup>

These means of escape on *DEEPWATER HORIZON* allowed the crew to readily evacuate to the forward Muster Stations. Survivors reported no queuing problems or other chokepoint issues, other than having to travel through debris from collapsed bulkheads and fallen ceiling panels caused by the explosion.<sup>207</sup> Some reported that in some areas of the Accommodations, the automatic sprinklers were discharging, thus causing a slowdown in travel time.<sup>208</sup> Many of the survivors reported having difficulty traveling across open deck areas because the drilling mud and other fluids made the deck very slippery.<sup>209</sup>

### C. Protecting Embarkation Stations from Heat

As discussed above, several personnel recounted that the heat from the fire was so intense that they were concerned they would not survive when launching the liferaft. Paragraph 9.3.5 of the 1989 IMO MODU Code specifies that:

*“9.3.5 Consideration should be given by the Administration to the siting of superstructures and deckhouses such that in the event of fire at the Drill Floor at least one escape route to the embarkation position and survival craft is protected against radiation effects of that fire as far as practicable.”*

This general requirement can be met by situating the Embarkation Stations behind deckhouses; however, there is no assurance that the intervening structure will adequately block the expected radiant heat from a Drill Floor or a Moon Pool fire.

---

<sup>203</sup> Second Deck, ABSDWH000609.

<sup>204</sup> CCR, ABSDWH000608.

<sup>205</sup> Second Deck, ABSDWH000609.

<sup>206</sup> Main Deck, ABSDWH000608.

<sup>207</sup> Testimony ██████████ 5/27/2010 p 53; Testimony ██████████ 5/28/2010 pp 228-232.

<sup>208</sup> Testimony ██████████ 5/28/2010 pp 260-264.

<sup>209</sup> Statement ██████████ 4/26/2010.

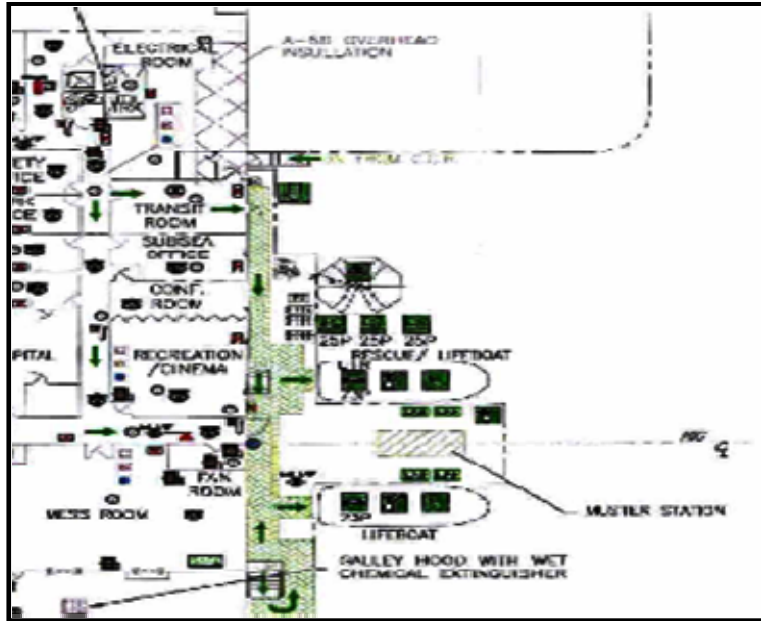

Figure 6 - Means of Escape Forward

#### D. Ladders from the Embarkation Deck to the Water

The master and on-watch SDPO evacuated the MODU by jumping from the embarkation deck to the water.<sup>210</sup> The 1989 IMO MODU Code specifies two standards for the arrangement of embarkation decks:

*“10.3.7 At least two widely separated fixed metal ladders or stairways should be provided extending from the deck to the surface of the water. The fixed metal ladders or stairways and sea areas in their vicinity should be adequately illuminated by emergency lighting.”*

*“10.3.8 If fixed ladders cannot be installed, alternative means of escape with the sufficient capacity to permit all persons onboard to descend safely to the waterline should be provided.*

The *DEEPWATER HORIZON* was fitted with fixed vertical ladders at the Embarkation Decks that extended from the embarkation deck to the waterline.<sup>211</sup> However, the on-watch SDPO knew the bottom 15 to 20 feet of the ladders were severely damaged, so that even if he used one, he would still have had to jump.<sup>212</sup>

The damaged condition of the fixed vertical ladders, also called emergency column escape ladders, was noted during the BP Marine Audit in September 2009 and was assigned to be repaired within six months.<sup>213</sup> Those repairs were not completed. The MODU Spec Rig

<sup>210</sup> Testimony, [REDACTED] 5/27/2010 p 210; Testimony, [REDACTED] 10/5/2010 pp 172-173.

<sup>211</sup> *DEEPWATER HORIZON* outboard profile drawing using the drilling draft, ABSDWH000074.

<sup>212</sup> Testimony, [REDACTED] 10/5/2010, pp 172-173.

<sup>213</sup> BP Marine Audit Report, CMID Annex, BP-HZN-MBI00170578 and BP-HZN-MBI00170608.

Condition Assessment completed just six days before the accident cited each of the ladders on the lower part of all four columns as needing replacement.<sup>214</sup>

#### **E. Emergency Lighting at Embarkation Stations**

During the casualty, the only lighting for the escape routes was provided by the transitional power system. The normal power system failed and was not restored.<sup>215</sup> If all normal power was lost, the 400kW standby generator was designed to automatically start in order to maintain lighting and other standby power.<sup>216</sup> In this incident, the standby generator did not automatically start and could not be manually started despite attempts by the crew.<sup>217</sup>

The *DEEPWATER HORIZON* operations manual states that if normal and standby power were to fail, lighting could still be provided at essential locations by 1.5 hour rated battery back-up systems built into selected lights wired to the standby system.<sup>218</sup> Many of the survivors reported difficulty finding their way out of the Accommodations and Galley Areas due to darkness.<sup>219</sup> It is not clear if there was an inadequate level of battery lighting, if the battery lighting units had been damaged by the explosion, or if they were inoperable because they had not been properly maintained. Once the personnel arrived at the Embarkation Stations, there was no emergency lighting to illuminate those areas.

The 1989 IMO MODU Code requires that Muster and Embarkation Stations as well as alleyways, stairways and exits giving access to the Muster and Embarkation Stations should be adequately illuminated by emergency lighting, but does not require emergency lighting for the areas where the lifesaving appliances are to be lowered. The International Convention for the Safety of Life at Sea (SOLAS) regulation III/16.7 requires that, “During preparation and launching, the survival craft, its launching appliance, and the area of water into which it is to be launched shall be adequately illuminated by lighting supplied from the emergency source of electrical power.”

#### **F. Lifeboats**

*DEEPWATER HORIZON* was outfitted with four totally enclosed lifeboats measuring 8.50 x 2.89 x 1.25 meters, each with a capacity for 73-occupants. They were of the fire protected type, equipped with a self-contained air supply and a water spray system. Each lifeboat was served by davits and winches. Lifeboats were suitable for launching from the Second Deck 38 meters above the keel, down to any draft from the lowest transit draft to the normal 23 meters operating draft.<sup>220</sup>

The lifeboats were approved to SOLAS requirements and manufactured by Fassmer Schiffs Service GmbH & Co.KG. Lifeboats # 1 and # 2 were located on the Second Deck amidships on

---

<sup>214</sup> MODU Spec Rig Condition Assessment Report, TRN-USCG-MMS-00038618.

<sup>215</sup> Statement [REDACTED] 4/21/2010.

<sup>216</sup> *DEEPWATER HORIZON* Operations Manual March 2001 Chapter 8.5.

<sup>217</sup> Statement [REDACTED] 4/21/2010.

<sup>218</sup> *DEEPWATER HORIZON*, Operations Manual March 2001 Chapter 8.7.

<sup>219</sup> Testimony [REDACTED] 5/28/2010 pp 260-264.

<sup>220</sup> *DEEPWATER HORIZON*, Operations Manual March 2001 Chapter 9.68.

the bow while Lifeboats # 3 and # 4 were located on the Second Deck amidships on the stern.<sup>221</sup> Lifeboat # 2 was outfitted and designated to also serve as a rescue boat and was fully equipped to meet HSE/ABS/USCG requirements.<sup>222</sup>

The lifeboat arrangement complied with 1989 IMO MODU Code regulation 10.2.4 and provided availability of 200% lifeboat capacity for persons on board *DEEPWATER HORIZON*.

*“Each unit should carry lifeboats complying with the requirements of regulations III/46, installed in at least two widely separated locations on different sides of or ends of the unit. The arrangement of the lifeboats should provide sufficient capacity to accommodate the total number of person’s on board if: 1) all lifeboats in any one location are lost or rendered unusable; or 2) all the lifeboats on any one side, any one end, or any one corner of the unit are lost or rendered unusable.”*

In the case of this casualty, the redundant arrangement and placement of lifeboats was sufficient to provide alternate means for evacuation. 115 crew members safely evacuated *DEEPWATER HORIZON* by using Lifeboats # 1 and # 2. The chief electronics technician considered using Lifeboats # 3 or # 4 for evacuation as he escaped the Engine Control Room.<sup>223</sup> The final ten persons to evacuate *DEEPWATER HORIZON* also considered Lifeboats #3 and #4 but because safe transit to the aft deck could not be assured, they chose to use one of the liferafts.<sup>224</sup> If the explosions had damaged forward Lifeboats # 1 and # 2 instead of aft lifeboats # 3 and # 4, a dual purpose lifeboat/rescue boat would not have been available, except for the rescue craft provided by the *DAMON B. BANKSTON*. This incident illustrates that MODUs equipped with a single rescue boat are vulnerable to the loss of the rescue boat in an explosion and fire scenario. Further, if the rescue boat is a dual purpose lifeboat/rescue boat, the aggregate capacity of the onboard lifesaving appliances may be impacted.

## 1. Lifeboat Design

The IMO standard for the design and capacities of lifeboats directly impacted the evacuation of injured personnel on *DEEPWATER HORIZON* by not sufficiently providing suitable arrangements for the timely loading or adequate placement of an occupied stretcher. The International Lifesaving Appliance (LSA) Code section 4.4.3.4 requires an arrangement so that helpless people can be brought on board either from the sea or by stretcher; however, the preapproval testing recommendations only call for a demonstration to show that it is possible to bring helpless people on board the lifeboat from the sea.

---

<sup>221</sup> Lifesaving Appliance locations, ABSDWH000609.

<sup>222</sup> *DEEPWATER HORIZON*, Operations Manual March 2001 Chapter 9.68; Lifesaving Appliance locations, ABSDWH000609.

<sup>223</sup> Testimony [REDACTED] 7/23/2010 pp 17-22.

<sup>224</sup> Testimony [REDACTED] 7/23/2010 pp 17-22.



Figure 7 – Lifeboat # 2 Manufacturer Data Label

Due to the nature of his injuries, the Transocean operations manager-assets was carried on a stretcher from the Accommodation Spaces to the Lifeboat Embarkation Deck. Upon arrival, crew members assisted him into the lifeboat. By his account, “The crew helping me to get me in the lifeboat had trouble getting the stretcher on which I was lying into the lifeboat. I requested that they remove me from the stretcher and place me in the lifeboat to avoid any delay in the evacuation.”<sup>225</sup>

The lifeboat design was not conducive to receiving an injured crew member on a stretcher. As illustrated in Figure 8, when loading a stretcher via a side loading door, crew members must maneuver it past the threshold. As shown in Figures 9 and 10, once loaded, the positioning of a stretcher in the lifeboat significantly impedes egress and reduces seating capacity by eight to ten occupants. Neither arrangement provides a means to secure a stretcher from shifting during operation of the lifeboat.

The lifeboat design may also be inadequate to meet the needs of an offshore drilling rig crew. It is generally recognized that the average offshore worker weighs closer to 95 kg (210 pounds) rather than the present standard of 82.5 kg (180 pounds).<sup>226</sup> Thus, an approved lifeboat intended for the carriage of offshore workers could have insufficient overall seat width to permit the maximum number of persons the life boat was designed for to board. This also could result in the suboptimal placement and function of the chest strap and waist belt restraints.

<sup>225</sup> Statement [REDACTED] 4/27/2010.

<sup>226</sup> IMO Resolution.MSC. 272(85), which entered into force on 7/12/2010.

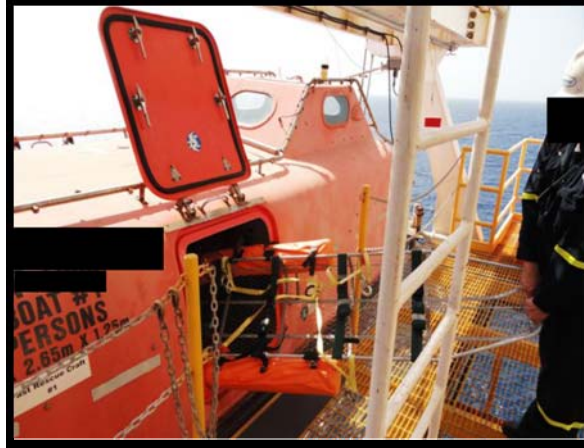

Figure 8 - Typical Stretcher Loading

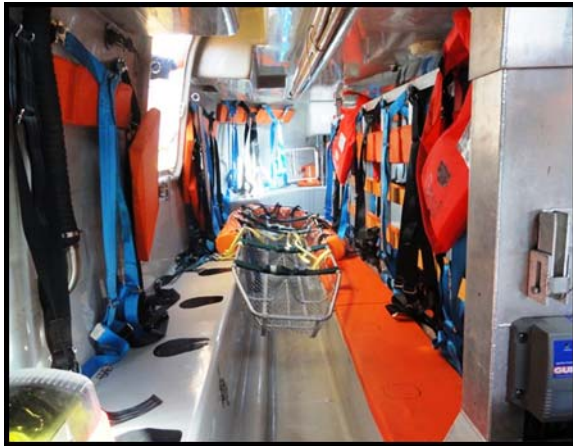

Figure 9 - Stretcher on the Seat

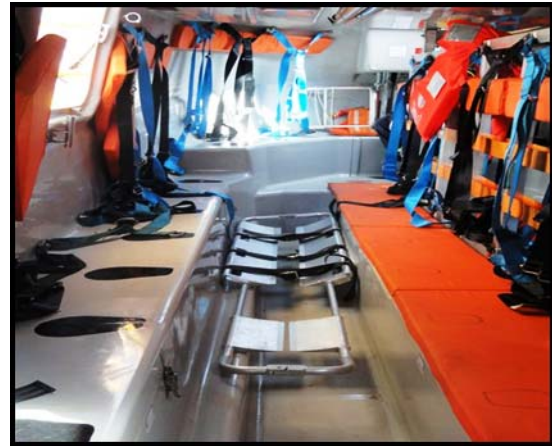

Figure 10 - Stretcher on the Deck

## G. Liferafts

*DEEPWATER HORIZON* was outfitted with six davit-launched liferafts approved to SOLAS regulations and manufactured by Viking Life Saving Equipment A/S. The liferafts were self inflating and came complete with a cover and survival gear from the manufacturer.

The liferaft arrangement complied with 1989 IMO MODU Code Section 10.2.5.

*“In addition [to the lifeboats], each unit should carry liferafts complying with the requirements of regulations III/39 or III/40, of such aggregate capacity as will accommodate the total number of persons on board.”*

The liferafts, known as davit-launched liferafts, were launched by a Schat-Harding SRR 360 liferaft launching appliance. Figure 11 illustrates a typical liferaft deployed by a launching appliance.



Figure 11- Typical Liferaft – Deployed

There were two Liferaft Stations on *DEEPWATER HORIZON*, located on the Second Deck amidships on the bow and on the stern, each comprised of a launching appliance and three liferafts.<sup>227</sup> Both stations were suitable for launching from the Second Deck, 38 meters above the keel, down to the normal operating draft of 23 meters.

The liferafts on *DEEPWATER HORIZON* were not designed to provide self-contained air support to protect the occupants from harmful air pollutants, occupant restraints (seat belts), means of self-propulsion, or a water spray system to protect occupants from heat and fire.<sup>228</sup>

During the use of the liferaft on *DEEPWATER HORIZON*, occupants were subjected to extreme environmental conditions. The entry of smoke into the canopy reduced the chief mate's visibility resulting in panic and deployment of the liferaft before it had been fully loaded.<sup>229</sup> The heat and flames emitted from the deck and from under the davit-launched liferaft caused the chief electronics technician to leave the Liferaft Embarkation Deck.<sup>230</sup> This experience showed that the actual use of a liferaft served by a launching appliance on a column stabilized MODU, during an uncontrolled well event, is particularly hazardous.

## H. Launching of Lifesaving Appliances

### 1. Lifeboats

The 1989 IMO MODU Code standards, Chapter 14, Operating Requirements provide adequate guidance for the practice of musters and drills. The following regulations greatly enhanced *DEEPWATER HORIZON*'s crew's emergency preparedness for abandonment of a MODU.

*14.11.2.5 Lowering of at least one lifeboat as far as reasonably practicable, after any necessary preparation for launch;*

<sup>227</sup> Lifesaving Appliance locations, ABSDWH000530.

<sup>228</sup> SOLAS 73, Regulation III 39 or 40.

<sup>229</sup> Testimony [REDACTED] 5/27/2010 pp 268-269.

<sup>230</sup> Testimony [REDACTED] 7/23/2010 p 23.

14.11.2.6 Starting and operating the lifeboat engine; and

14.11.5 Each lifeboat should, as far as reasonably practicable, be launched with its assigned operating crew aboard and maneuvered in the water at least once every three (3) months.

A review of the lifeboats' records revealed that servicing, inspection and crew drills all were carried out, including changing lifeboat falls,<sup>231</sup> testing releasing gear,<sup>232</sup> conducting weight tests on davits, and launching the lifeboats in the water.<sup>233</sup>

Consistent with previous drills, *DEEPWATER HORIZON* evacuated personnel donned lifejackets after being alerted of the emergency. In addition, previous practice lowering, starting and operating the lifeboats proved critical as both boats were safely launched from *DEEPWATER HORIZON* without serious incident.

## 2. Liferafts

As a result of the crew's efforts to launch the liferaft quickly, it left with a line still attached to the rig, and all of the occupants were tossed about and one fell out of the liferaft upon its impact with the water.<sup>234</sup> *DEEPWATER HORIZON*'s Manual for Lifesaving Appliances outlines detailed operating instructions from Schat-Harding, the manufacturer of the liferaft launching appliance (davit), and requires the officers-in-charge of emergency procedures to further read the liferaft manufacturer's (VIKING) operating instructions. Notably, the two sets of instructions differ in the sequence of actions to be performed by the officer-in-charge. The davit manufacturer requires adjusting the attitude of the davit first while the liferaft manufacturer requires the attaching of the liferaft first.<sup>235</sup> Only the VIKING instructions, typically posted at the operating station, remind crew members to disconnect the painter line.<sup>236</sup>

The 1989 IMO MODU Code, Section 14.11.2.7 and Coast Guard regulations, Title 46 Code of Federal Regulations (C.F.R.) § 109.213(d)(1)(vii), require that the davits used to launch liferafts be operated during each weekly abandon unit drill. Testimony and drill records show that the davits were operated at each drill. However, this requirement only tests the operation of the davit and does not exercise the crew's readiness to use the davit and liferaft together. This training disparity is further exacerbated by removal of Section 14.11.2.7 from the 2009 IMO MODU Code.

---

<sup>231</sup> Lifeboat "falls" are wire rope(s) that raise or lower the boat into position by means of an electric motor or winch.

<sup>232</sup> The servicing agent conducted the off load test of the releasing gear, but was unable to perform the on load test due to weather conditions. The test was rescheduled for May 2010, TRN-USCG\_MMS-00038496.

<sup>233</sup> See Appendix H, p H-5 generally.

<sup>234</sup> [REDACTED] 5/27/2010 pp269-270.

<sup>234</sup> Testimony [REDACTED] 10/5/2010 p 15.

<sup>235</sup> Schat Harding launching procedures, TRN-USCG\_MMS-00026915; VIKING launching procedures, TRN-USCG\_MMS-00026838.

<sup>236</sup> TRN-USCG\_MMS-00026838.



Moreover, the 1989 IMO MODU Code, Section 14.12.3 and 46 C.F.R. § 109.213(g)(5), both require on board training in the use of davit-launched liferafts at intervals of not more than four months and prescribes that “when practicable,” the drill must include inflation and lowering of the liferaft. The regulation’s inclusion of the condition “when practicable,” however, allows the operator of a MODU to forego this critical training. As a result, it reduces the officer-in-charge’s valuable training and experience in the actual preparation, boarding and launching of liferafts served by davit launching appliances. No testimony or records were provided indicating whether the crew had ever activated a liferaft during an abandonment drill on board *DEEPWATER HORIZON*.

## I. Search and Rescue

Please see Appendix G, *Final Action Report On the SAR Case Study Into the Mass Rescue of Personnel off the Mobile Offshore Drilling Unit DEEPWATER HORIZON*. The Joint Investigation Team concurs with the analysis in the report.

## III. Actions/Decisions Contributing to System Failures

### A. The Bridge crew did not follow standard procedure for providing notification of the emergency.

The Bridge Crew of *DEEPWATER HORIZON* was likely overwhelmed by the multiple audible and visual alarms immediately before and after the series of explosions and ensuing fire.<sup>237</sup>

The standard procedure for alerting the crew to flammable gas emergencies required the on-watch DPO to manually activate the general alarm (GA) system after two or more gas detectors were activated.<sup>238</sup> In this case, multiple gas alarms had been activated and acknowledged, but the GA was not sounded until the explosions occurred. When asked why the GA was not immediately sounded after the first alarms were received, the on-watch DPO stated, “It was a lot to take in. There was a lot going on.”<sup>239</sup>

### B. The crew did not conduct a complete muster (headcount) to account for all personnel prior to evacuation.

During the evacuation, there was confusion that resulted in an inability to achieve a full accounting of personnel before departing *DEEPWATER HORIZON*. The first complete muster of the 115 persons evacuated was not completed until more than an hour later, after all of the surviving crew members had boarded *DAMON B. BANKSTON*.<sup>240</sup>

This result could be attributed in part to the fact that the personnel on *DEEPWATER HORIZON* who should have the most knowledge about coordinating a mass evacuation were its merchant marine officers listed in Table 3. Of those officers, at least two of the four senior merchant

---

<sup>237</sup> Testimony ██████████ 10/5/2010 pp 40, 47, 65.

<sup>238</sup> Testimony ██████████ 10/5/2010 p 54.

<sup>239</sup> Testimony ██████████ 10/5/2010 p 65.

<sup>240</sup> BANKSTON Log; SAR Case Report.

marine officers did not participate in the muster or the launching of either lifeboat, as they were fulfilling other duties and responsibilities as outlined in *DEEPWATER HORIZON* Station Bill “Fire & Emergency Stations.”<sup>241</sup>

Table 3 - *DEEPWATER HORIZON* Station Bill: “Abandon Unit Stations”

Life Boat 1	
Position	Assigned
In Charge	Master
2nd In Charge	DPO (off-watch)
3rd In Charge	Chief Mechanic (off-watch)
Prepare Liferaft	A/B Seamen
Take Muster	Assistant Driller (off-watch)
Life Boat 2	
Position	Assigned
In Charge	Chief Mate
2nd In Charge	SDPO (off-watch)
3rd In Charge	Boatswain-
Prepare Liferaft	A/B Seamen
Take Muster	Assistant Driller (off-watch)

Further, despite providing formal and shipboard training, Transocean’s training scenarios did not prepare the merchant marine officers and industrial drilling crew to function as a team under foreseeable hazards such as a well blowout, which was identified in *DEEPWATER HORIZON* Major Hazards Risk Assessment.<sup>242</sup> According to the records of drills, the marine crew and the drill crew performed all required drills within their respective occupations, but the entire crew did not collectively participate in the fire and abandonment drills because of drilling operations.<sup>243</sup> 95% of the time, the drill crew would take their muster and emergency preparations on the Drill Floor.<sup>244</sup> Third party contractors were excused from the drills.<sup>245</sup> The on-watch SDPO testified that to his knowledge, “Well control drills and [rig] abandonment drills were never performed in combination.”<sup>246</sup>

The 1989 IMO MODU Code, Chapter 14, Operating Requirements, provided adequate guidance for the practice of musters and drills every week. However, several standards were removed from the 2009 IMO MODU Code:

*14.11.2.1 Summoning of all on board to muster stations with the general emergency signal and ensuring that they are aware the order to abandon the unit will be given;*

*14.11.2.2 Reporting to stations and preparing for the duties described in the muster list;*

<sup>241</sup> Statement ██████ 4/21/2010; Statement ██████ 4/21/2010; Statement ██████ 4/26/2010; Statement ██████ 4/21/2010. The chief mate was in charge of the fire team and the master was one of the last crew members to leave the CCR.

<sup>242</sup> *DEEPWATER HORIZON* Major Hazards Risk Assessment, 8/29/2004.

<sup>243</sup> Testimony ██████ 10/5/2010 pp 200-201.

<sup>244</sup> Testimony ██████ 10/5/2010 pp 200-201.

<sup>245</sup> Testimony ██████ 10/5/2010 pp 200-201.

<sup>246</sup> Testimony ██████ 10/5/2010 pp 200-201.

14.11.2.3 *Checking that every person is suitably dressed; and*

14.11.2.4 *Checking that lifejackets and immersion suits are correctly donned.*

Reinstating these prescriptive standards and the diligent performance of the *Recommendations on Training of Personnel on MODUs* (Resolution A.891 (21)) recently adopted in the 2009 MODU Code would enhance the emergency preparedness of offshore personnel.

**C. By summoning the fast response craft of the DAMON B. BANKSTON to recover persons in the water, DEEPWATER HORIZON did not have to use Lifeboat #2 as a rescue boat.**

As allowed by the 1989 IMO MODU Code, Section 10.7, the Republic of the Marshall Islands (RMI) designated Lifeboat # 2 as *DEEPWATER HORIZON*'s rescue boat thereby establishing it as a dual-purpose lifesaving appliance. In practice, the rescue boat was intended to recover persons from the water and assist in the marshalling (gathering) of other lifeboats or liferafts once away from *DEEPWATER HORIZON*. In this case, Lifeboat #2 did not perform this intended function due in part to the availability of the FRC on board *DAMON B. BANKSTON*.

According to the on-watch SDPO, the CCR was aware that crew members were jumping overboard, but due to the bigger issue at hand [evacuation], no attempt was made to provide *DEEPWATER HORIZON*'s rescue boat to recover them from the water.<sup>247</sup> The on-watch SDPO explained that using the rescue boat would have taken it out of commission as a lifeboat.<sup>248</sup> Therefore, he summoned the assistance of *DAMON B. BANKSTON* and used its FRC to perform the function.<sup>249</sup> This quick decision allowed the dual-purpose lifeboat to serve its primary function. Once the FRC was deployed, the on-watch compliance specialist and at least three others were rescued before either of the lifeboats was launched from *DEEPWATER HORIZON*.<sup>250</sup>

**D. The crew deploying the liferaft failed to efficiently operate the MODU's liferaft launching appliance and liferaft components.**

As a result of the crew's competing demands, such as responding to their "Fire and Emergency Stations" or assisting injured personnel, ten persons were unable to evacuate *DEEPWATER HORIZON* in their predetermined lifeboats. Those personnel included the master, chief mate, chief engineer, on-watch SDPO, on-watch DPO, chief electronics technician, off-watch toolpusher, senior toolpusher, motorman, and chief electrician.

After struggling to prepare the liferaft launching appliance and inflating the liferaft, the remaining personnel did not ensure the liferaft's painter was freed from the MODU.<sup>251</sup> By not disconnecting the painter, the crew's ability to quickly and safely descend from *DEEPWATER*

<sup>247</sup> Testimony [REDACTED] 10/5/2010 p 171.

<sup>248</sup> Testimony [REDACTED] 10/5/2010 p 171.

<sup>249</sup> Testimony [REDACTED] 10/5/2010 p 171.

<sup>250</sup> Testimony [REDACTED] 5/28/2010 pp 223-224.

<sup>251</sup> Testimony [REDACTED] 5/27/2010 pp 269-270.

*HORIZON* was greatly impacted. The IMO Lifesaving Appliances Code requires liferaft painter length to be not less than 10m (33 feet) plus the distance from the stowed position to the waterline in the lightest seagoing condition, or 15 m (50 feet), whichever is greater.<sup>252</sup> In this case, it appears that the painter became tangled during launching, as the raft was ultimately able to descend to the water, and then had to be cut to release the liferaft.

Occupants evacuating in the tethered liferaft adhered to a BP “Knife-Free” policy.<sup>253</sup> However, a knife was provided in the liferaft equipment and was later found when the raft was alongside *DAMON B. BANKSTON*. Training and familiarity with the liferaft equipment, including the location of such equipment, would have greatly assisted the occupants in quickly freeing themselves once waterborne.

The International Convention on Standards of Training and Certification and Watchkeeping for Seafarers (STCW) outline the minimum standards of competencies an officer must obtain before receiving certification. Chapter VI prescribes mandatory minimum requirements for issuance of certificates of proficiency in the use of survival craft, rescue boats, and fast rescue boats.

The standards of competencies included in the STCW Code A, Section VI/2-1, for an officer-in-charge include:

- Taking charge of a survival craft or rescue boat during and after launching;
- Operating a survival craft engine;
- Managing survivors and survival craft after abandoning ship;
- Using locating devices, including communication and signaling apparatus and pyrotechnics; and
- Applying first aid to survivors.

These recommendations, however, provide no practical training requirements for the identification and use of the different types of liferaft launching appliances that may be on board MODUs. Had the STCW provided *DEEPWATER HORIZON* crew members with practice with various types of lifesaving appliances in realistic training conditions, much like it provides for training in the use of portable fire extinguishers in STCW Code B, Section B-VI/1, the officer-in-charge would have been better prepared to operate the launching appliance and liferaft more efficiently.

## **E. Search and Rescue**

Please see Appendix G, *Final Action Report On the SAR Case Study Into the Mass Rescue of Personnel off the Mobile Offshore Drilling Unit DEEPWATER HORIZON*. The Joint Investigation Team concurs with the analysis in the report.

---

<sup>252</sup> IMO International Lifesaving Appliances Code, 2003, Section 4.1.3.2.

<sup>253</sup> Statement ██████████ 4/21/2010.

## IV. U.S. Government / Class / Flag Oversight

### A. Standards of Training, Certification & Watchkeeping

The RMI established the crew complement for *DEEPWATER HORIZON* and issued a Minimum Safe Manning Certificate (MSMC) identifying the required capacities such as master, OIM, chief engineer, oiler, and the other positions on the rig. The RMI confirmed *DEEPWATER HORIZON* met its Manning Schedule for a dynamically positioned vessel (DPV) MODU at the time of the casualty. According to that schedule, the minimum crew required to operate and respond to emergencies on board *DEEPWATER HORIZON* was fourteen persons.<sup>254</sup>

However, the *DEEPWATER HORIZON* Station Bill require more than thirty additional emergency positions that including fire team leaders, person in charge of muster, and personnel to clear accommodations, to be filled by industrial and catering crews, none of whom are subject to the STCW.

The purpose of the STCW is to establish a minimum global standard of knowledge, understanding, experience and professional competencies of seafarers. The IMO established competencies that must be obtained and demonstrated before a seafarer becomes a certified person. For example, the master must achieve competencies listed in STCW II/2 to receive certification. Likewise, a chief engineer must achieve competencies listed in STCW III/2. There are no STCW professional competency standards established by the IMO for the drilling crew (e.g., OIM, toolpusher, driller).

STCW competencies do not include consideration of vessel types or services. For example, a master certified to STCW Section II/2 is certified on any ship of 500 gross tons or more. However, the 1994 amendments to STCW, which entered into force on January 1, 1996, recognized that there are special training requirements for personnel on tankers. Likewise, the 1997 amendments to STCW, which entered into force on January 1, 1999, included special training requirements for personnel assigned to passenger and “roll on, roll off” passenger ships. However, personnel assigned to MODUs are not required to undergo additional specialized training in order to receive STCW certification.<sup>255</sup>

Had STCW special training requirements for all MODUs been the standard, the certified personnel on *DEEPWATER HORIZON* would have been required to acquire additional knowledge and an appreciation of the interrelationships of the industrial services and marine operations unique to MODU operations. These competencies may have assisted such personnel in better recognition of hazards and performance of crowd management techniques during the mass evacuation of *DEEPWATER HORIZON*.

---

<sup>254</sup> Republic of the Marshall Islands, Marine Notice No. 7-038-2.

<sup>255</sup> International Convention on Standards for Training, Certification and Watchstanding (STCW) for Seafarers, 1978 as amended in 1995 and 1997.

## B. Emergency Evacuation Plan (EEP) and Standby Vessels

An EEP is an emergency contingency plan that addresses persons, resources and actions be taken if an evacuation of a MODU or an OCS facility is required. Per 33 C.F.R. § 146.140, an EEP may apply to more than one facility, if the facilities are located in the same general geographic location and within the same Coast Guard Officer in Charge, Marine Inspection (OCMI) zone; if each facility covered by the EEP is specifically identified in the EEP; and if the evacuation needs of each facility are accommodated. EEP's must be submitted to the Coast Guard for review and approval pursuant to. However, present regulations do not require that the EEP be exercised by having onboard drills to demonstrate its sufficiency and effectiveness. Although the leaseholder of a MODU is required to prepare an EEP, the owner/operator of the MODU has no such requirement.

BP established an EEP for Mississippi Canyon Block 252.<sup>256</sup> On March 8, 2007, the EEP for *DEEPWATER HORIZON* was approved for use in Mississippi Canyon Block 562.<sup>257</sup> However, the EEP had not been checked by the OCMI Morgan City, since *DEEPWATER HORIZON* returned to the OCMI's zone.<sup>258</sup> A copy of the original EEP was not retained, nor was the approval of the EEP documented in the Coast Guard Maritime Information System for Law Enforcement (MISLE) database.

A subsequent review of the EEP has revealed that although the EEP did not definitively list the master of *DEEPWATER HORIZON* as the Person-in-Charge of the MODU, it met the requirements of 33 C.F.R. § 146.210.<sup>259</sup> The EEP did not specifically designate a standby vessel for *DEEPWATER HORIZON*. The purpose of such a vessel is to have an immediate resource available in the case of evacuation that can provide additional lifesaving capabilities. Although there is no regulatory requirement that a MODU have a designated standby vessel, 33 C.F.R. § 143 establishes the requisite operating capabilities of a standby vessel if one is designated in an EEP.

The EEP for *DEEPWATER HORIZON*, Appendix D, Evacuation Craft Details, listed four motor vessels, including *DAMON B. BANKSTON*, as "evacuation craft." None of the vessels were "specifically designated" as a standby vessel, nor was *DAMON B. BANKSTON*'s Certificate of Inspection endorsed for standby service.<sup>260</sup> Nevertheless, during the casualty, *DAMON B. BANKSTON* performed the services and duties of a standby vessel, and there is no doubt that *DAMON B. BANKSTON*'s proximity to *DEEPWATER HORIZON*, its construction and equipment standards, and its crew's actions that night saved lives.

---

<sup>256</sup> BP Emergency Evacuation Plan, Mississippi Canyon Block 252 *DEEPWATER HORIZON* (Jan. 2010).

<sup>257</sup> Officer-in-Charge, Marine Inspection, 16711/Horizon, Serial EEP-07036, March 8, 2007.

<sup>258</sup> Coast Guard Eight District Marine Safety Division, 16711/EEP Approval, 15 September 2003 encouraged each Officers in Charge, Marine Inspection (OCMI) to exercise their authority under 33 C.F.R. 140.15(a) and permit alternative procedures to those specified in 33 C.F.R. Subpart N, for the submission and approval of EEPs under 33 C.F.R. 146.140 and 146.210, provided that the MODU was previously operating with the same OCMI Zone, changes were minor and the plan was prepared by entities which have proven their competency in preparing EEPs. Revised EEPs would be checked in the normal course of inspection. Initial review and approval requirements for newly installed manned Outer Continental Shelf (OCS) facilities remained.

<sup>259</sup> BP Emergency Evacuation Plan, Mississippi Canyon Block 252 *Deepwater Horizon* (Jan. 2010), App. D.

<sup>260</sup> BP Emergency Evacuation Plan, Mississippi Canyon Block 252 *Deepwater Horizon* (Jan. 2010), App. D.



Figure 12 - *DAMON B. BANKSTON*

### C. Fast Rescue Craft

At least 15 of the 115 personnel who evacuated *DEEPWATER HORIZON* were assisted by the FRC deployed from *DAMON B. BANKSTON*. A benefactor of its capabilities testified, “Every rig that’s designed needs a fast rescue craft...if the boat wouldn’t have had a fast rescue craft, there may have been ten more lives that was lost.”<sup>261</sup>

*DEEPWATER HORIZON* was not outfitted or required to be outfitted with a FRC as identified in SOLAS 74. The IMO noted in Resolution A.656 (16), adopted on 19 October 1989, the “current extensive use of Fast Rescue Boats, in particular in offshore activities for rescue purposes.” In addition, the IMO was of the opinion, “...that Fast Rescue Boats are of value in certain circumstances for the rescue, in particular, of persons involved in offshore activities.” Despite these positive endorsements, there remains no requirement for MODUs on the U. S. Outer Continental Shelf to have a FRC.

As shown in Table 4, a comparison of vessels subject to SOLAS 74 highlighted that only roll-on roll-off (RO-RO) Passenger Vessels were required to be fitted with a FRC.<sup>262</sup>

Table 4 - Fast Rescue Craft (FRC) Requirements

Vessel Type	Regulation/No. requiring an FRC
MODU	N/A
Passenger Vessel	N/A
RO-RO Passenger Vessel	SOLAS, III, 26.3/At least one rescue boat must be a Fast Rescue Boat
Cargo Vessels	N/A

*DEEPWATER HORIZON* and other MODUs like it typically operate for extended periods of time using dynamic positioning technology to maintain a watch circle while latched-up to the

<sup>261</sup> Testimony ██████████ 5/27/2010 pp 337-338.

<sup>262</sup> SOLAS 74 was amended as a result of the capsizing of RO-RO passenger ship *ESTONIA* in September 1994.

well head. Because of the operating conditions, MODUs are unable to maneuver to recover a person who has fallen overboard. Furthermore, *DEEPWATER HORIZON*'s hull design (column-stabilized) does not complement the rapid recovery of the rescue boat as the vessel's hull does not extend down to the water's edge, similar to a traditional ship, to provide the rescue boat with stability or a lee from wind and waves.<sup>263</sup>

The master of *DEEPWATER HORIZON* testified that additional precautions must be taken when launching a lifeboat on a semi-submersible, "You need extremely calm weather to launch a lifeboat because you don't have a ship's hull to turn to make a [lee] for it to come alongside. So you're trying to hit two swinging pennants with a lifeboat. It's not safe, and it's not worth putting the crew at risk."<sup>264</sup>

These conditions could be mitigated with the installation of an FRC. The FRC's launching appliance standards<sup>265</sup> are intended to allow its recovery in Sea State 6, with 3 m (10 ft) waves. This is particularly beneficial for MODUs that cannot maneuver to create a lee for recovery. In addition, the FRC would eliminate the use of lifeboats as rescue boats and allow them to be used for their primary function, evacuation.

#### **D. Man Overboard Drills**

Neither the IMO MODU Code nor Coast Guard regulations provide for a man overboard drill on MODUs. However, *DEEPWATER HORIZON* Operations Manual Section 9.8 does require the drill "on a regular basis." In addition, Transocean's Training Manual for Lifesaving Appliances and Station Bill provides specific guidance concerning how to complete the man overboard drill.

Although *DAMON B. BANKSTON* was summoned to provide assistance, *DEEPWATER HORIZON* did not execute the duties and responsibilities for a man overboard situation as required by its Station Bill. For example, *DEEPWATER HORIZON*'s ship's whistle was not sounded and no instructions/orders were provided to post observers to monitor the persons in the water. Had a regulatory or Code requirement to perform man overboard drills been established, the MODU's crew may have been better prepared to respond to a man overboard.

#### **E. Search and Rescue**

Please see Appendix G, *Final Action Report On the SAR Case Study Into the Mass Rescue of Personnel off the Mobile Offshore Drilling Unit DEEPWATER HORIZON*. The Joint Investigation Team concurs with the analysis in the report.

---

<sup>263</sup> Windward is the direction upwind from the point of reference. Leeward is the direction downwind from the point of reference. The side of the ship towards the leeward is the lee side. Masters of ships will create a "lee" (windward shelter) when conducting small boat recovery operations.

<sup>264</sup> Testimony ██████████ 5/27/ 2010 p 181.

<sup>265</sup> IMO Resolution MSC 81(70) Section 8.1.8.



## V. Conclusions

- A. The presence of the visiting BP and Transocean executives in the Central Control Room/Bridge of *DEEPWATER HORIZON* immediately prior to the casualty may have diverted the attention of the offshore installation manager and senior toolpusher from the developing well conditions, limited their interactions with the on-watch drilling crew, and led to their failure to follow the emergency evacuation procedures.
- B. The boundaries established at the bow Liferaft Embarkation Station were inadequate to shield evacuating personnel from exposure to radiant heat emanating from under *DEEPWATER HORIZON*'s column stabilized hull.
- C. Once there was a loss of electrical power, the emergency lighting available in the accommodations, the muster areas, and especially the lifeboat and liferaft lowering stations was inadequate, and there was no lighting over the water into which the lifeboats/liferafts were to be launched, making safe evacuation of personnel and launching of the lifeboats/liferafts more hazardous.
- D. The current lifeboat design and testing requirements do not adequately ensure the safe loading of a stretcher or permit adequate seating to accommodate the physical build of the average offshore worker today.
- E. The International Convention on Standards for Training, Certification and Watchstanding (STCW) does not currently identify a MODU as a "Special Ship," for which marine personnel would be required to undergo specialized training prior to certification. Masters, officers, particular ratings and special personnel assigned to MODUs are not required to receive specialized training for crowd control, crisis management or human behavior. Such training could have helped minimize the chaos and confusion surrounding the muster and evacuation of *DEEPWATER HORIZON*.
- F. The International Maritime Organization (IMO) MODU Code and U.S. Coast Guard subjective language that liferaft launch drills should be conducted "when practicable" minimized the officer-in-charge's opportunities to obtain training experiences in the actual preparation, boarding and launching of liferafts served by davit launching appliances.
- G. Transocean's failure to include on board training in the use of davit-launched liferafts, including the proper inflation and lowering of the liferafts at intervals of not more than four months as prescribed by regulations, significantly reduced the crew's competency in performing these functions in an emergency.
- H. Conducting weekly fire and abandonment drills at fixed times and on predetermined days did not adequately prepare the crew to respond to the casualty "as if the drill was an actual emergency." The crew would have been better prepared if emergency drills were staggered at different times of the day, on different days and during varying environmental conditions.

- I. The failure to integrate weekly well control and evacuation drills limited the crew's ability to demonstrate knowledge and understanding of their duties and responsibilities as outlined in *DEEPWATER HORIZON*'s operations manual and the emergency response manual.
- J. The 2009 IMO MODU Code has removed some previous standards concerning the performance of crew musters and drills, such as demonstrating the ability to timely muster all crew members and having them prepared to carry out their assigned duties and replaced them with recommendations. The implementation of the reduced standards will likely lead to additional confusion during actual casualties.
- K. The STCW does not adequately establish standards and competencies for officers-in-charge of emergency procedures to operate lifesaving appliances that serve liferafts.
- L. The inflatable liferafts on *DEEPWATER HORIZON* served by launching appliances did not provide adequate protection for occupants under the circumstances. The exposure to extreme heat due to the proximity of the fire to the launching area, combined with the lack of a water spray system, placed them at greater risk during the evacuation.
- M. The storage location of the knife in *DEEPWATER HORIZON*'s liferaft was not easily identifiable to the occupants. Had reflective tape and standard IMO symbols been used, the occupants likely could have found the knife and freed the raft from the painter line on their own.
- N. The quantity and location of rescue boats provided on MODUs should align with the "widely separated location" philosophy adopted for lifeboats. The location of a secondary rescue boat at the alternate lifeboat location would increase the availability of a rescue boat.
- O. The proximity and operational capabilities of the offshore supply vessel *DAMON B. BANKSTON* were critical to the successful evacuation of the one hundred-fifteen survivors of this casualty.
- P. The fast rescue craft from *DAMON B. BANKSTON* was extremely effective in ensuring the safe recovery of crew members from *DEEPWATER HORIZON*.
- Q. There currently are no IMO MODU Code standards or Coast Guard regulations to require quarterly drills for a man overboard on MODUs. Failure to require these drills made *DEEPWATER HORIZON* ill-prepared to efficiently recover persons in the water with either *DEEPWATER HORIZON*'s designated rescue boat, or other predetermined emergency response resources.
- R. Pursuant to the regulations in Title 33, Code of Federal Regulations (C.F.R.), Subchapter N, only leaseholders of an area on the U.S. Outer Continental Shelf (OCS), where a MODU will be operating, are required to develop and submit an Emergency Evacuation Plan (EEP). Owners/operators of MODUs operating on the OCS need to have a comprehensive understanding of the applicable EEP in order to ensure the safe evacuation of personnel in an emergency.

- S. Pursuant to the regulations in 33 C.F.R. Subchapter N, there are no established performance and evaluation criteria for an EEP, nor is there an annual requirement to exercise the EEP. The combination of only requiring the leaseholder to develop an EEP and not requiring an on-site demonstration of the MODU's proficiency in executing the EEP significantly undermines its value.
  
- T. The Joint Investigation Team concurs with the conclusions that are documented in Appendix G, *Final Action Report On the SAR Case Study Into the Mass Rescue of Personnel off the Mobile Offshore Drilling Unit DEEPWATER HORIZON*.

This section describes the events on or near the mobile offshore drilling unit (MODU) *DEEPWATER HORIZON* relating to its flooding and sinking, from the secondary explosion and initial indications of the emergency situation onboard the vessel on April 20, 2010 at 2150 hours local time until the MODU sank on April 22, 2010 at 1026. It provides an overview of actions impacting the stability and fire-fighting efforts, a description of the systems in place to address the possible flooding and sinking of *DEEPWATER HORIZON*, and significant actions and decisions leading up to the sinking, including decisions regarding the primary focus of response activities, the failure to issue a salvage plan, and the failure to follow the Vessel Response Plan (VRP).

### I. Overview

During normal operations prior to the event, the crew took active measures to maintain the stability of *DEEPWATER HORIZON* by regularly adjusting weights and ballast to compensate for any changes in the loading condition onboard. However, after *DEEPWATER HORIZON* was evacuated and power was lost, the ability to actively maintain the MODU's stability was lost.

#### A. Damage from Explosions and Fire

At the time of the explosions, *DEEPWATER HORIZON* carried a variety of fixed and liquid loads. The explosions and fire aboard *DEEPWATER HORIZON* caused significant damage. While it is not possible to determine the nature or extent of damage to the underwater hull or internal structures, comparisons of *DEEPWATER HORIZON*'s attitude before and during the casualty indicate that the weight of *DEEPWATER HORIZON* increased, or buoyancy was lost, and that its center of gravity shifted aft and to starboard.<sup>266</sup> Photographs taken on the morning of April 22 reveal that there was serious deformation of topside structures just prior to the sinking. Up to this point there were conflicting reports on the extent of damage. The log from *MAX CHOUEST*, one of the vessels responding to the scene, indicated that another vessel, "*SEACOR WASHINGTON* noticed a breach in Port Fwd Leg" at 1450 on April 21;<sup>267</sup> however, Transocean's on-scene salvage master, responsible for saving the MODU, reported at 0015 on April 22<sup>nd</sup> that "hull and leg structures appear primarily in-tact."<sup>268</sup> As the fire progressed, the equipment on deck began to shift, including the derrick which toppled to starboard.<sup>269</sup> Although video footage taken from the ocean floor indicated damage to the hull below the waterline, it is unclear if this damage occurred before *DEEPWATER HORIZON* sank or as a result of sinking in approximately 5000 feet of water.

---

<sup>266</sup> Coast Guard Post Sinking Analysis for *DEEPWATER HORIZON*, (Appendix L).

<sup>267</sup> *MAX CHOUEST* Rough Log, 4/21/2010.

<sup>268</sup> SMIT Salvage Americas Salvage Daily Progress Report, *DEEPWATER HORIZON*, dated 22 April 2010.

<sup>269</sup> *Id.*

## B. Marine Fire-fighting

According to the master (captain) of *DAMON B. BANKSTON*, at approximately 0055 on April 21, four boats were on scene providing water to the fire, with two more on the way. When asked if anybody was coordinating the fire-fighting he stated, “Not fully, no.”<sup>270</sup> According to the log on *DAMON B. BANKSTON*, at 0130 on April 21, *DEEPWATER HORIZON* “starts to show a list to stbd stern and rotating some with secondary explosions” and at 0318 “a heavy list stbd-stern.”<sup>271</sup> At 0500, the master of *DAMON B. BANKSTON* noted in the log “many more vessel[s] on station to[o] many to list.”<sup>272</sup> Based on logs obtained from response vessels, 11 different vessels reported engaging in fire-fighting efforts during the response. Transocean’s operations manager-performance, who was one of four people on *DEEPWATER HORIZON* who remained on scene after the survivors departed, realized that stability was a concern around 0800 or 0900 on the morning of April 21.<sup>273</sup>

The attempts to control the fire and cool the structure resulted in application of large volumes of seawater. As discussed below, it is likely that some portion of that water accumulated inside the hull. Internal damage to watertight subdivisions, poor maintenance of watertight closures, or simply leaving watertight closures open during the evacuation may have allowed the migration of liquid loads and flooding throughout *DEEPWATER HORIZON*.

The only information regarding the orientation and drafts of *DEEPWATER HORIZON* during the casualty came from SMIT Salvage Americas, Transocean’s contractor engaged to provide salvage services. The contractor’s salvage logs indicated that *DEEPWATER HORIZON* was “listing towards aft stbd @22 degrees w/8’ freeboard” at 0015 on April 22.<sup>274</sup> The salvage master notes indicated no change in this reported condition between 0300 and 0900.<sup>275</sup> However, based on a stability analysis conducted by the Coast Guard (Appendix L), the heel angle observed in pictures during this time frame was only about 12 degrees; and the logs from the Transocean emergency response center reported, “Naval Architect Assessment from Smit 6:00 am observation. Trim of the rig 7-8 degrees, Heel 12-13 degrees. Combination is about 20 degrees.”<sup>276</sup>

Some unknown combination of damage, flooding, and shifting loads slowly trimmed, heeled, and reduced the freeboard on *DEEPWATER HORIZON*, allowing previously un-submerged openings in the hull to move closer to the waterline. On the morning of April 22, *DEEPWATER HORIZON* began taking on increasing amounts of water as more openings were submerged. By 1026, *DEEPWATER HORIZON* had sunk.<sup>277</sup>

---

<sup>270</sup> Testimony ██████████ 5/11/2010 p 148.

<sup>271</sup> *DAMON B BANKSTON* Log.

<sup>272</sup> *Id.*

<sup>273</sup> Testimony ██████████ 8/23/2010 p 470.

<sup>274</sup> SMIT Salvage Americas Salvage Daily Progress Report, *DEEPWATER HORIZON*, dated 22 April 2010.

<sup>275</sup> SMIT Salvage Americas Salvage Master Observations, April 22, 2010.

<sup>276</sup> It is not correct to add trim angles and heel angles together, but it appears this was done to get the 22 degrees reported in the SMIT Salvage Master Observations.

Transocean emergency response center log, TRN-USCG\_MMS-00038830.

<sup>277</sup> SAR Case Report.

Figure 13 shows *DEEPWATER HORIZON* as it came to rest on the ocean floor, depicting some of the damage and showing that the upper hull was buried and is not visible.<sup>278</sup>

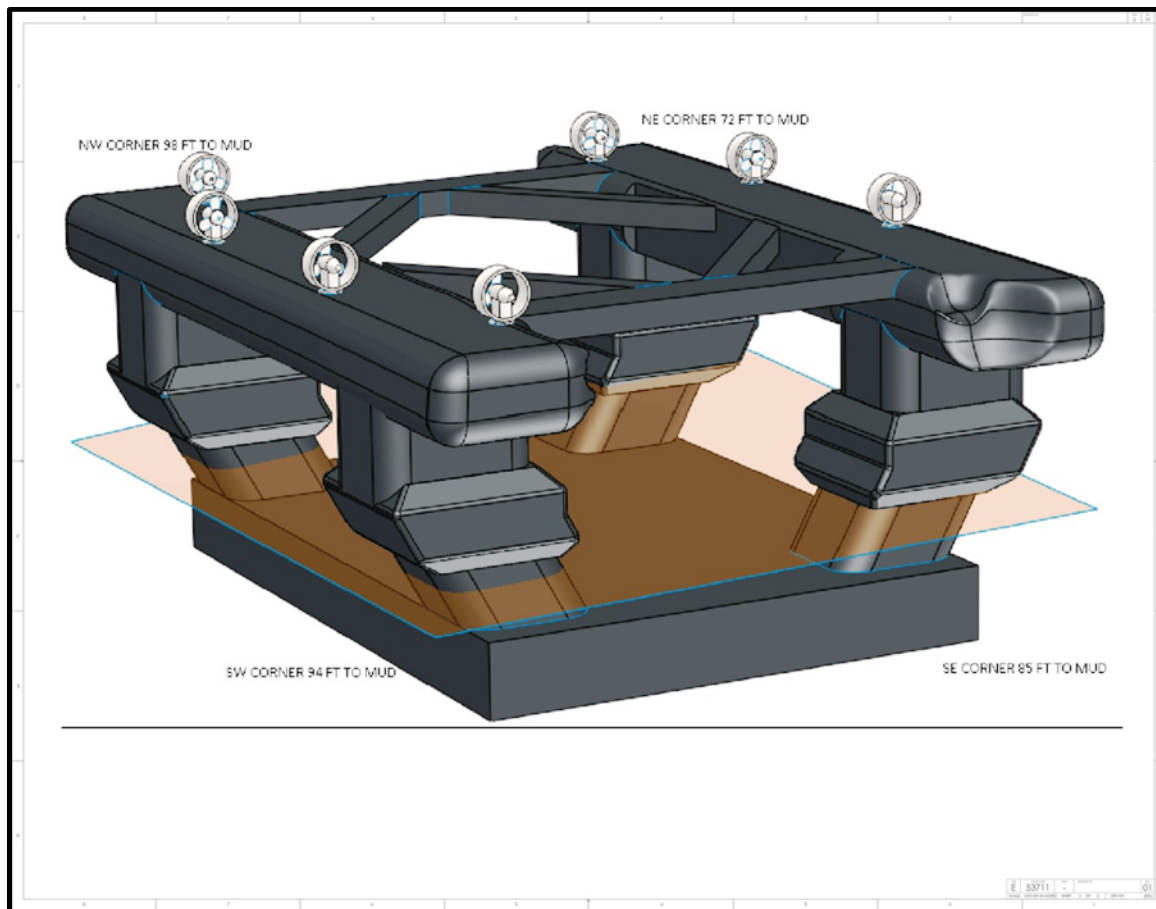

Figure 13 – *DEEPWATER HORIZON* on the Ocean Floor

## II. Systems

### A. Operations Manual – Watertight Integrity

Prior to the explosion on April 20, 2010, *DEEPWATER HORIZON* had established requirements for maintaining the watertight integrity of its internal compartments. The investigation identified, however, that during the month of the explosion, *DEEPWATER HORIZON* was not in compliance with those requirements.

The International Maritime Organization (IMO) Code for the Construction and Equipment of Mobile Offshore Drilling Units (MODU Code) includes damage stability and subdivision standards that require numerous watertight compartments. The IMO MODU Code essentially

<sup>278</sup> Phoenix International Drawing, *DEEPWATER HORIZON* Major Debris Distribution, Sheet 2 of 2, 10/13/2010.

requires a MODU to be able to survive the loss of one compartment, so it is vital to ensure that watertight barriers between each compartment are maintained to prevent progressive flooding.<sup>279</sup>

On *DEEPWATER HORIZON*, those compartments needing both watertight integrity, as well as frequent access were required to have watertight doors or watertight hatches. In addition, all penetrations of the watertight bulkheads that allowed for the passage of piping were to be protected by valves that could be operated from the central ballast control room with remote visual position indicators, in order to maintain watertight integrity and provide situational awareness to the crewmembers on watch.<sup>280</sup>

The vessel's operations manual stressed the importance of maintaining the proper operation of all watertight closures to ensure readiness and stability during damage situations.<sup>281</sup> However, reports from two separate independent materiel condition audits identified issues with the watertight integrity of *DEEPWATER HORIZON* relating to the maintenance and proper operation of watertight doors and dampers. The first report, issued in September 2009 by inspectors contracted by BP, reviewed watertight integrity and noted that "[t]here were failures observed which have raised concerns." It stated:

"In the worst case approximately four of these doors had the limit switch frozen in the closed position. This then means the bridge would be unaware of the status of the door as the limit switch always reports closed status. Additionally when reviewing alarm status conditions on the vessel management system a number of doors had had the 100 second alarm timer disabled. This means that if the doors are left open for more than 100 seconds then the audible alarm will not be generated in line with the original requirements."<sup>282</sup>

In addition, the report found, "The port aft quadrant watertight dampers failed to close when tested."<sup>283</sup> The report also identified deficiencies with another vital stability system:

"During testing of the bilge system three of the four electric bilge pumps failed to take suction, the priming devices being defective. Two emergency bilge suction check valves also failed integrity checks when subject to flow back test."<sup>284</sup>

In April 2010, a second report, from a survey conducted by inspectors contracted by Transocean, identified one issue "that directly affect[s] the stability of the rig":

"The watertight doors appeared to be in fair condition. The rig had two of the hydraulic doors out of service and not working correct[ly], on the 28 1/2 meter deck level and also on the 24 meter deck level, that have to be manually opened and closed."<sup>285</sup>

---

<sup>279</sup> IMO MODU Code, Chapter 3.

<sup>280</sup> 1989 IMO MODU Code 3.6.2.

<sup>281</sup> *DEEPWATER HORIZON* Operations Manual, page 4.8, ABSDWH000152.

<sup>282</sup> *DEEPWATER HORIZON* Follow Up Rig Audit, Marine Assurance Audit and Out of Service Period September 2009, BP-HZN-MBI00136223-136224.

<sup>283</sup> *DEEPWATER HORIZON* Follow Up Rig Audit, Marine Assurance Audit and Out of Service Period September 2009, BP-HZN-MBI00136223-136213.

<sup>284</sup> *DEEPWATER HORIZON* Follow Up Rig Audit, Marine Assurance Audit and Out of Service Period September 2009, BP-HZN-MBI00136223-136224.

With regard to the ballast control system, the report found issues with all four relays for the valve controls, as they were heating up during operation and required replacement. The major concern identified with the relays “would be a flooding problem or safety issues of the watertight integrity of the rig.”<sup>286</sup>

In addition, when the BP auditors conducted a status update in March 2010, it identified a remaining watertight integrity issue relating to the “Multiple Cable Transits” (MCTs):<sup>287</sup>

“[S]ince an MCT survey carried out in 2005/2006 it is reported that two MCTs have leaked or failed under static head pressure. Inventory survey and inspection to be conducted and documented to verify the integrity of MCTs installed in the pontoons, columns, moon pool and main deck areas.”<sup>288</sup>

This recommendation was still outstanding as of March 29, 2010 when the auditors conducted a status update.<sup>289</sup> Dating back to December 2005, failed MCTs had been identified as a concern for drilling rigs when MMS determined that they were responsible for a flooding and stability problem on the *THUNDERHORSE* floating platform during Hurricane Dennis: “Preliminary findings from the investigation indicate that water movement among the access spaces occurred through failed multiple cable transits (MCTs).”<sup>290</sup>

Because of the sinking, the actual watertight integrity of *DEEPWATER HORIZON* at the exact time of the casualty cannot be known. Nevertheless, to the extent that the conditions identified in the audits remained uncorrected, when water from fire-fighting vessels was applied onto the MODU, those compartments with faulty watertight closures or damage to their closures could have accelerated progressive flooding and created a flooding situation well beyond what is addressed by the damage survivability requirements of the MODU Code.

## **B. Coast Guard Search and Rescue Policy – Marine Firefighting**

Coast Guard Search and Rescue (SAR) responders are guided by a SAR policy that states:

- “Coast Guard units shall adopt a conservative response posture” and focus their actions on activities not requiring unit personnel to enter into a hazardous environment.

---

<sup>285</sup> MODUSpec USA, Inc., Rig Condition Assessment *DEEPWATER HORIZON*, MODUSpec Reference: US2147.1, dates 1-14 April, 2010, TRN-USCG\_MMS-00038618.

<sup>286</sup> MODUSpec USA, Inc., Rig Condition Assessment *DEEPWATER HORIZON*, MODUSpec Reference: US2147.1, dates 1-14 April, 2010, p 16.

Inoperable valves in the ballast system could allow for the unrestricted passage of flood water from one compartment to another through the ballast piping. This problem becomes more severe as a vessel heels; flood water previously contained in one or more compartments flows to the low side of the vessel through the piping, increasing the heel of the vessel.

<sup>287</sup> Multiple Cable Transits allow for the passage of cables through watertight bulkheads without compromising the watertight integrity of the compartment.

<sup>288</sup> BP CMID Audit Work list September 2009, Rev Date March 29, 2011, TRN-USCG\_MMS-00043621.

<sup>289</sup> *Id.*

<sup>290</sup> MMS Safety Alert #235, December 15, 2005, [http://www.gomr.boemre.gov/homepg/offshore/safety/safealt/SA\\_235.pdf](http://www.gomr.boemre.gov/homepg/offshore/safety/safealt/SA_235.pdf).



- For fire-fighting in an ICS response structure, “a Firefighting Group should be established to coordinate local authorities responsible for fighting the fires. This should be coordinated prior to an incident.”
- “The Commandant recognizes the significance of the cautious approach the Coast Guard has adopted for marine fire-fighting situations. High training, equipment, and staffing thresholds will limit the response capability of many units, and in some areas, sources of support will not be readily available. Consequently, there will be occasions when a unit will be unable to mount a complete response to an incident. This circumstance is preferred to attempting a complex and potentially hazardous job without the necessary staffing, training and equipment.”<sup>291</sup>

### C. Area Contingency Plan – Marine Fire-fighting

To assist governmental agencies in responding to oil and hazardous material spills, Coast Guard Captains of the Port (COTP), as the likely Federal On Scene Coordinators (FOSC) in the event of an oil spill, are required to develop an Area Contingency Plan (ACP) with members of federal, state and local agencies to establish predetermined plans and strategies for multi-agency efforts to respond to a spill resulting from a marine casualty.<sup>292</sup> The ACP uses the Incident Command System (ICS)<sup>293</sup> as its framework and ordinarily contains procedures for marine fire-fighting. In this instance, the Southeast Louisiana ACP did not contain a specific marine fire-fighting plan, but the ACP did define the following inconsistent duties regarding marine fire-fighting:

- “In general, the USCG Captain of the Port is the Incident Commander for any fire aboard a vessel that is at anchor or underway.”<sup>294</sup>
- The COTP is tasked to “Be prepared to assume the role of Incident Commander if the fire-fighting response is inadequate or nonexistent”<sup>295</sup> or “upon conclusion of fire-fighting operations as appropriate.”<sup>296</sup>
- “The COTP will advise the [Incident Commander] on unique vessel fire-fighting hazards not normally associated with land based fires. Some of these hazards include: Vessel stability due to water discipline, Free surface effect, Hull integrity, List correction/vessel de-watering....”<sup>297</sup>

---

<sup>291</sup> United States Coast Guard, Commandant Instruction M16130.2E, “U.S. COAST GUARD Addendum to the United States National Search and Rescue Supplement (NNS) to the International Aeronautical and Maritime Search and Rescue Manual (IAMSAR)” September 21, 2009, Section 4.4 Firefighting Activities Policy.

<sup>292</sup> 40 C.F.R. 300.210(c)

<sup>293</sup> The Incident Command System (ICS) is a standardized but flexible, on-scene, all-hazards incident management approach that allows for the integration of numerous entities and jurisdictions within a common organization structure.

<sup>294</sup> Southeast Louisiana Area Contingency Plan, 6 February 2003, 4520.3 p 4-34.

<sup>295</sup> Southeast Louisiana Area Contingency Plan, 6 February 2003, 8332.113 p 8-6.

<sup>296</sup> Southeast Louisiana Area Contingency Plan, 6 February 2003, 8330 p 8-4.

<sup>297</sup> Southeast Louisiana Area Contingency Plan, 6 February 2003, 8332.118(2) p 8-6.

### III. Actions / Decisions Contributing to System Failure

#### A. Decisions Relating to Fire-fighting

The parties involved in the fire-fighting and salvage efforts made two decisions that, taken together, resulted in a marine fire-fighting effort that lacked direction and coordination and paid insufficient attention to the risks of excess water destabilizing the rig. These decisions were (1) the Coast Guard's decision to focus priority on Search and Rescue; and (2) the Transocean salvage contractor's decision not to develop a salvage plan.

##### 1. Decision to Focus Priority on Search and Rescue

Both the ACP and SAR policies focus on near shore or in port fires and thus do not emphasize a coordinated offshore marine fire-fighting effort. As discussed above, the ACP states that for situations occurring within their zone, the COTP, as FOOSC, has jurisdiction over marine fire-fighting and that the first priority is the safety of the crew and other personnel in the area. The secondary concerns are for environmental protection and vessel salvage.<sup>298</sup> The Coast Guard Search and Rescue Policy also prioritizes SAR over fire-fighting.<sup>299</sup> Based on the reports of missing persons, this policy was understandably followed. As a result, however, the marine fire-fighting efforts lacked direction and coordination.

The investigation revealed that there was no formal establishment of a fire-fighting group.<sup>300</sup> The Eighth Coast Guard District quickly took over the Search and Rescue Mission Coordinator (SMC) responsibilities from Sector New Orleans as the event was categorized as a Mass Rescue Operation. The FOOSC duties, including marine fire-fighting, remained with the Sector New Orleans sub-unit, Marine Safety Unit Morgan City.<sup>301</sup> But it was the Eighth Coast Guard District office that had the authority to launch Coast Guard boats and aircraft from throughout the Eighth District, which covers most of the units near the Gulf of Mexico. The District established communications with the assets it deployed and had good visibility over all of the directed sub-units.<sup>302</sup>

The initial Coast Guard assets on scene were operating under the SAR policy that takes a cautious approach to marine fire-fighting and thus did not direct those activities. According to the Commanding Officer of the Coast Guard Cutter *ZEPHYR*, who assumed On Scene Coordinator duties at 0724 on April 21, "We gave no direction on fire-fighting."<sup>303</sup> Meanwhile, on shore, the Executive Officer at Marine Safety Unit Morgan City, who was acting as the FOOSC and Incident Commander during the Commanding Officer's absence, stated that, "Marine Safety

---

<sup>298</sup> Southeast Louisiana Area Contingency Plan, 6 February 2003, 9720.1 page 9-57.

<sup>299</sup> United States Coast Guard, Commandant Instruction M16130.2E, "U.S. COAST GUARD Addendum to the United States National Search and Rescue Supplement (NNS) to the International Aeronautical and Maritime Search and Rescue Manual (IAMSAR)" September 21, 2009, Preface.

<sup>300</sup> Testimony ██████ USCG, 10/4/2010, p 30, USCG SAR Case Review, Appendix G, Exhibit 23-1, USCG SAR Case Review, Appendix G, Exhibit 25-1.

<sup>301</sup> Testimony ██████ 10/4/2010 p 27.

<sup>302</sup> Testimony ██████ USCG 10/4/2010 p 30.

<sup>303</sup> USCG SAR Case Review, Appendix G, Exhibit 23-1.

Unit didn't fight the fire nor did we direct any efforts to fight the fire on the *DEEPWATER HORIZON*." According to the Executive Officer, "We (MSU) were told to stay back from any fire-fighting, and to just work on pre-staging and getting ready for the possible need to respond to any pollution."<sup>304</sup>

At the same time, no one from *DEEPWATER HORIZON* took charge of marine fire-fighting. The master of *DEEPWATER HORIZON* could not recall leading a fire-fighting effort before he departed the scene on the morning of April 21.<sup>305</sup> Transocean's operations manager-performance, who remained on scene after the survivors departed, indicated that he was not leading the fire-fighting effort,<sup>306</sup> though when a responding vessel requested permission to put water on *DEEPWATER HORIZON* over the radio, he authorized it.<sup>307</sup> When asked if he considered the impact of the water on the stability of *DEEPWATER HORIZON* when he authorized the boats to use fire monitors (water cannons), the operations manager-performance stated, "We didn't go into great detail there."<sup>308</sup>

Transocean's salvor, SMIT Salvage Americas, initially did not take the lead either. When SMIT Salvage Americas arrived at the Transocean Emergency Response Center in Houston, Texas at approximately 0500 on April 21, it was not clear who was directing the fire-fighting effort on scene.<sup>309</sup> The first successful two-way communication between SMIT Salvage Americas at the Transocean emergency response center and the operations manager-performance onboard *MAX CHOUEST* was at 1300 on April 21.<sup>310</sup> At 1315, the Captain on watch aboard the *MAX CHOUEST*, logged "Informed C. G. Cutter *ZEPHYR* to have fire vessels redirect water flow to legs as per Transocean - [REDACTED]"<sup>311</sup> Figure 14 shows at least 6 vessels providing water to the fire.

According to SMIT Salvage Americas, it initially had "very little and erratic information" regarding the condition of *DEEPWATER HORIZON* from on scene and "didn't have any clear lines of communication" until its chartered vessel *SEACOR VANGUARD* arrived on scene at 2345 on April 21.<sup>312</sup> At that time, a full day into the response, SMIT Salvage Americas members proceeded to take control of and actively direct the fire-fighting efforts and, by their account, made sure that the vessels with fire monitors were minimizing the risk of "downflooding" of the MODU from excess fire-fighting water.<sup>313</sup>

## 2. Decision to Not Issue a Salvage Plan

In the case of a vessel fire or casualty, the vessel owner typically develops a salvage plan to ensure that the situation does not worsen and that the risks to personnel, the vessel, and the

---

<sup>304</sup> USCG SAR Case Review, Appendix G, Exhibit 25-1.

<sup>305</sup> Testimony [REDACTED] 5/27/2010 p 219.

<sup>306</sup> Testimony [REDACTED] 8/23/2010 p 469.

<sup>307</sup> Testimony [REDACTED] 8/23/2010 p 470.

<sup>308</sup> Testimony [REDACTED] 8/23/2010 p 470.

<sup>309</sup> Testimony [REDACTED] 10/4/2010 p 112, 187.

<sup>310</sup> Testimony [REDACTED] 10/4/2010 p 122.

<sup>311</sup> *MAX CHOUEST* Log.

<sup>312</sup> Testimony [REDACTED] 10/4/2010 p 138.

<sup>313</sup> *SEACOR VANGUARD* Log, Testimony [REDACTED] 10/4/2010 p 188.

environment have been addressed and minimized. However, despite having SMIT Salvage Americas in the Transocean emergency response center within about 6 hours of the initial incident, Transocean and SMIT Salvage Americas did not produce a salvage plan in the following day and a half before *DEEPWATER HORIZON* sank.



Figure 14 – Vessels directing water towards the fire

From the perspective of SMIT Salvage Americas, it viewed the fire as a well control issue. The president and general manager of SMIT Salvage Americas indicated that it was very clear that the well had to be dealt with before anything else could be done.<sup>314</sup> As a result, he was apparently waiting for the fuel source to be removed from *DEEPWATER HORIZON* before developing a salvage plan; that never happened. SMIT Salvage Americas was also getting conflicting reports and did not have a clear line of communication from on scene, which made it difficult to develop a salvage plan.

SMIT Salvage Americas did produce an introductory guidance document at 2000 on April 21. But, despite the difficult communications, reports that the MODU was heeling and listing, and knowledge that response vessels were actively putting water on *DEEPWATER HORIZON*, the SMIT Salvage Americas document did not designate a specific person on scene to direct the efforts of response vessels and it did not warn of the direct impact that excess water could have on the stability and buoyancy of *DEEPWATER HORIZON*.<sup>315</sup>

<sup>314</sup> Testimony [REDACTED] 10/4/2010 p 115.

<sup>315</sup> SMIT Salvage Americas Preliminary Salvage Plan *DEEPWATER HORIZON* Mississippi Canyon Block 252, April 21, 2010.

### 3. Impact of Decisions

Marine fire-fighting is challenging because the water used to try and extinguish the fire can add weight to the vessel and ultimately cause it to sink before the fire is extinguished.<sup>316</sup> Without leadership and guidance to avoid it, there is a substantial likelihood that the water from the responding vessel added weight to *DEEPWATER HORIZON*. Some of the 11 response vessels engaged in putting water on *DEEPWATER HORIZON* had the capability to apply up to 8,000 gallons of water per minute using both of their fire monitors; with 100% effectiveness that equates to 31 metric tons per minute, per boat.

There is insufficient data to determine what percentage of water directed from the responding vessels' fire monitors did not evaporate or drain overboard, but remained onboard *DEEPWATER HORIZON* as added weight. Nevertheless, there are indications that some portion of the water did remain onboard. The heat of the fire required the responders to direct the water from a considerable distance. *DEEPWATER HORIZON* was a moving target as it slowly changed location and heading so it was difficult to always get the water on the intended location. In addition, the size and color of the smoke also hindered their efforts. Given the amount of water coming from the fire monitors, any water that missed the fire and reached the deck was quickly deflected in all directions, possibly allowing it to collect in numerous locations. Figure 15 shows water draining off the starboard aft corner of *DEEPWATER HORIZON*, indicating that some portion of the water from the fire monitors did not vaporize, but landed on deck. Furthermore, *DEEPWATER HORIZON* was equipped with a zero-discharge, pollution containment system to prevent the mixture of rainwater and pollutants that collect on deck from running directly overboard.<sup>317</sup> Although it is not known if the system was open at the time of the casualty, if it was, it may have retained water onboard from the fire monitors.<sup>318</sup>

In addition, the stability analysis conducted by the Coast Guard (Appendix L), revealed that the rig's displacement changed by 1500 metric tons (400,000 gallons of sea water), between a pre-casualty condition, assumed to be the maximum authorized drilling draft, and its condition after 30 hours. *DEEPWATER HORIZON*'s shift over that time period was too great to have been caused by a simple shifting of weight from the collapsed derrick, internal liquid loads, and/or fixed weights.

At the same time, it is not clear what the overall impact of a more timely coordinated fire-fighting effort would have been. The fact that this fire was being fueled from an uncontrolled source made it virtually impossible to extinguish without securing the well or removing the fuel source. Thus, although a more coordinated fire-fighting would have likely resulted in less water being put onboard, as a trade off, the structure would likely have been exposed to more extreme heat, which could have expedited a catastrophic structural failure. It is therefore not possible to conclude that the water from the responding vessels accelerated the sinking.

---

<sup>316</sup> Efforts were taken to secure the fuel source locally on the ocean floor, but the *DEEPWATER HORIZON* sank before the well was controlled.

<sup>317</sup> Testimony ██████ 10/4/2010 pp 165-166.

<sup>318</sup> *Id.*



Figure 15 – Water from Responding Vessels Spilling Off the Deck of *DEEPWATER HORIZON*

## B. Vessel Response Plan

The investigation has shown that Transocean failed to rely on the *DEEPWATER HORIZON*'s vessel response plan (VRP) in preparing for and responding to the casualty.

Under 33 C.F.R. § 155, a vessel is required to have a VRP to prepare the owner or operator and crew to prevent or mitigate any oil discharge or substantial threat of a discharge in the event of an emergency or casualty. To ensure familiarity with the plan, there is a requirement to conduct scheduled and unscheduled drills.<sup>319</sup> The National Preparedness for Response Exercise Program (NPREP or PREP) is a voluntary program that, if followed, ensures compliance with the regulatory drill requirements for non-tank vessels set forth in 33 C.F.R. § 155. The Coast Guard approved non-tank vessel response plan for *DEEPWATER HORIZON* stated that the drill program onboard complied with the PREP.<sup>320</sup> The PREP Guidelines require quarterly drills that exercise the vessel's emergency procedures to ensure crew knowledge of actions to be taken to respond to at least one of the following: a vessel fire, collision, or oil spill on deck. During a triennial cycle, PREP requires exercising all of the response plan's components, including demonstration of the ability to assemble and deploy salvage and fire-fighting resources identified

---

<sup>319</sup> Coast Guard NVIC 01-05 CH-1, Interim Guidance for the Development and Review of Response Plans for Notank Vessels, Section 10.

<sup>320</sup> *DEEPWATER HORIZON* Non-Tank Vessel Response Plan 7.1, October 17, 2006, Revision 12, BP-HZN-MBI-00001401.

in the response plan.<sup>321</sup> In addition, the ability to establish an intra-organization and an external communication system must be exercised.<sup>322</sup>

The investigation revealed that Transocean responders were not familiar with the VRP and its requirements. When a Transocean operations manager assigned as coordinator for the Transocean emergency response center was asked “Have you heard of what is called a “vessel response plan?” he responded, “I am not familiar with the term “vessel response plan,” no sir.”<sup>323</sup> The director of upgrade and repair projects had a similar response and confirmed that he had never seen the VRP.<sup>324</sup> Furthermore, there was no specific evidence establishing that Transocean had conducted the drills required by the VRP. The Transocean director of upgrade and repair projects within the engineering and technical support group, who was also a member of the Transocean Emergency Response team responding to the event and had been employed by Transocean or a predecessor company since 1984, testified that he last participated in a drill regarding a fire on a MODU five or six years ago.<sup>325</sup> Given Transocean’s responders unfamiliarity with the VRP after the incident, it is questionable if the required training portion of the plan was exercised.

Moreover, Transocean did not follow provisions of the VRP intended to facilitate a rapid and effective response. During the initial hours of the response, the Transocean director of upgrade and repair projects contacted the president and general manager of SMIT Salvage America to request salvage assistance because they had worked together before.<sup>326</sup> In the approved Vessel Response Plan, however, a different entity, Marine Response Alliance had been the designated salvage and marine fire-fighting provider.

Later, at the Transocean’s emergency response center, the SMIT Salvage Americas salvage team was searching for a Herbert Software Solutions, Inc. “HECSALV” computer stability model of *DEEPWATER HORIZON* to use in its analysis and asked the Transocean naval architects to make one.<sup>327</sup> In doing so, Transocean evidently did not take note of the fact that the VRP indicated that *DEEPWATER HORIZON* was enrolled in the American Bureau of Shipping (ABS) Rapid Response Damage Assessment (RRDA) program. Since ABS RRDA elects to use HECSALV stability software, ABS would have had a HECSALV model for *DEEPWATER HORIZON* on file and ready for immediate use for damage stability and residual strength calculations.<sup>328</sup> ABS was never contacted.<sup>329</sup> It is not known if Transocean ever completed the HECSALV model.<sup>330</sup>

---

<sup>321</sup> PREP Guidelines Response Plan Core Components August 2002, p B-2.

<sup>322</sup> PREP Guidelines Response Plan Core Components August 2002, p B-4.

<sup>323</sup> Testimony [REDACTED] 12/7/2010 p 198.

<sup>324</sup> Testimony [REDACTED] 10/5/2010 p 18.

<sup>325</sup> Testimony [REDACTED] 10/5/2010 p 21.

<sup>326</sup> Testimony [REDACTED] 10/5/2010 p 29.

<sup>327</sup> Testimony [REDACTED] 10/4/2010 p 125.

<sup>328</sup> Non-Tank Vessel Response Plan Appendix B Vessel Specific Information 02/02/07 Rev. 5, page 3.

<sup>329</sup> Testimony [REDACTED] 10/5/2010 p 15.

<sup>330</sup> Testimony [REDACTED] 10/4/2010 p 134.

This same episode reveals that the Vessel Response Plan was not accurate. Since the incident, contact with ABS has revealed that it has no record of *DEEPWATER HORIZON* being enrolled in their program.<sup>331</sup> Thus, the *DEEPWATER HORIZON* VRP contained incorrect information.

#### **IV. U.S. Government / Class / Flag Oversight**

The flooding and sinking of *DEEPWATER HORIZON* revealed several limitations on existing oversight systems.

##### **A. No Loading Information Available**

The unavailability of loading information during the response, which would have indicated the displacement, weight centers, and tank levels maintained onboard *DEEPWATER HORIZON* prior to the incident, prevented responders from being able to take reports from on scene and use a computer model to rapidly evaluate various damage scenarios to possibly determine how long they had until the MODU sank or capsized.

An operations manager for Transocean, who was also the initial Transocean emergency response center coordinator for the response, testified that “there are vessel reports, loading conditions sent in so that they are there and available in the event we need them.”<sup>332</sup> However, when Transocean was required by subpoena to provide “the most recent loading data of *DEEPWATER HORIZON* prior to the incident,” the company did not produce any and stated that they “have not located any documents responsive to this request. Loading records were kept onboard *DEEPWATER HORIZON* and are believed to have gone down with the rig.”<sup>333</sup> The president and general manager of SMIT Salvage Americas, who was present in the Transocean emergency response center shortly after the incident (and is also on retainer by Transocean as outside legal counsel) indicated that no such information was available, that only general loading conditions were available and that they were only obtained verbally from an off watch crewmember of *DEEPWATER HORIZON*.<sup>334</sup>

There are no regulatory requirements for the loading conditions of a MODU to be relayed and maintained ashore. Nevertheless, this total lack of any loading information has hampered any precise forensic stability investigation and has made it impossible to verify if *DEEPWATER HORIZON* was operating in compliance with its stability letter at the time of the incident.

##### **B. Shore-side Damage Calculation Resources**

33 C.F.R. § 155.240 (“Damage stability information for oil tankers and offshore oil barges”), promulgated under the Federal Water Pollution Control Act (FWPCA), as amended by the Oil Pollution Act (OPA) of 1990, requires that oil tankers and offshore oil barges have prearranged, prompt access to computerized, shore-based damage stability and residual structural strength calculations programs. During a casualty, such calculations help responders evaluate the current

---

<sup>331</sup> Telephone conversation between LCDR [REDACTED] (JIT) and Mr. [REDACTED] of ABS on 2/22/2011.

<sup>332</sup> Testimony [REDACTED] 12/7/2010 p 217.

<sup>333</sup> Sutherland Asbill & Brennan LLP Letter to USCG-MMS Investigation Board, dated 8/19/2010.

<sup>334</sup> Testimony [REDACTED] 10/4/2010 p 137.



situation and identify the potential of catastrophic structural failure, quantify the reduction in stability, and estimate the probability of a total loss to a vessel.

The Coast Guard does not have a requirement for MODUs to comply with these regulations. A Notice of Proposed Rule Making (NPRM) has been issued as part of the consideration to have Non-Tank Vessel Response plans comply with the requirements of 33 C.F.R. § 155, Subpart I, “Salvage and Marine Firefighting” that encompass the damage stability requirements of 33 C.F.R. § 155.240. A non-tank vessel is defined as a self-propelled vessel, that is not a tank vessel, and that is operating on the navigable waters of the United States and carrying oil for main propulsion.<sup>335</sup> This rulemaking, however, will not impact MODUs on the OCS since the requirement is applicable to non-tank vessels operating within the navigable waters of the United States, which extend only 12 nautical miles from the baseline.<sup>336</sup>

### C. Stability Verification

The Coast Guard issues Certificates of Compliance (COC) to foreign-flagged MODUs operating on the Outer Continental Shelf if they comply with one of three alternatives:

- United States flag requirements, 33 C.F.R. § 143.207(a);
- Flag state requirements that are evaluated to be equivalent to United States flag requirements, 33 C.F.R. § 143.207(b); or
- IMO MODU Code (IMO Resolution A.414(XI) – 1979 IMO MODU Code), 33 C.F.R. § 143.207(c).

*DEEPWATER HORIZON*'s most recent COC was issued using 33 C.F.R. § 143.207(c), commonly referred to as “Option C,” based on compliance with the IMO MODU Code. On August 9, 2002, the Coast Guard Commandant, Office of Compliance, issued to the Republic of the Marshall Islands (RMI) a letter that stated that a Marshall Islands’ MODU Safety Certificate issued under the provisions of Publication MI-293 (Rev. 8/00) for MODU’s constructed on or after December 31, 1981, will be considered evidence of compliance with the International and Coast Guard requirements under 33 C.F.R. § 143.207(c) and 33 C.F.R. § 146.205(c), “Option C.” Publication MI-293 states that the vessel must meet the IMO MODU Code and, regarding stability, classification society standards that exceed those specified in the International Association of Classification Societies (IACS) Requirements Concerning MODUs (Requirements D3 through D7).<sup>337</sup> Neither IACS nor ABS requires a deadweight survey to be conducted every five years for classification purposes.<sup>338</sup>

---

<sup>335</sup> Federal Register Vol. 74 , No. 167, Monday August 31, 2009, Proposed Rules pages 44970-45001.

<sup>336</sup> Testimony ██████████ 10/7/2010 p 59.

<sup>337</sup> The Republic of the Marshall Islands, Mobile Offshore Drilling Unit Standards, MI-293, Rev. 8/02, Part III, Construction, Strength, Materials, Subdivision, Stability, and Load Line, p 3.

<sup>338</sup> A deadweight survey is used to determine the displacement (weight) of a vessel. If two deadweight surveys are conducted the weight change from modifications, repairs, installation or removal of equipment, and other factors can be determined. The displacement of a vessel is a critical component in evaluating the vessel’s stability.

However, the 1989 and 2009 IMO MODU Codes both require a column stabilized MODU to conduct a deadweight survey, carried out in the presence of an officer of the Administration, or a duly authorized person or representative of an approved organization, at intervals not exceeding five years.<sup>339</sup> The operations manual for *DEEPWATER HORIZON* contained the same requirement. However, the U.S. Coast Guard regulations, 33 C.F.R. § 143.207(c), still reference the 1979 IMO MODU Code that did not require the five year deadweight survey. It has not been updated to reflect changes in the IMO MODU Code.

ABS issued a MODU Safety Certificate on behalf of the RMI, without any evidence that the deadweight survey required by the RMI Publication MI-293, was conducted.<sup>340</sup> The RMI failed to detect through its oversight inspections and audits that ABS, acting on its behalf, issued a MODU Safety Certificate when *DEEPWATER HORIZON* was not in compliance with Publication MI-293. The Coast Guard issued the COC based upon a valid MODU Safety Certificate in accordance with 33 C.F.R. § 143.207(c). Without the results of a recent deadweight survey, the actual weight of *DEEPWATER HORIZON* may have increased in the 10 plus years since it was last evaluated, possibly allowing the crew to unknowingly overload the MODU.

## V. Conclusions

- A. The exact cause of the loss of stability and sinking of *DEEPWATER HORIZON* cannot be determined with the limited information available.
- B. The only method to effectively fight the fire onboard *DEEPWATER HORIZON* would have been to remove the fuel source by securing or disconnecting from the well.
- C. The limited communications between the Transocean emergency response center and the representative on scene made it difficult for the shore-side responders to fully understand the changing conditions of the situation.
- D. Responders and investigators did not have access to information regarding how *DEEPWATER HORIZON* was loaded prior to the casualty.
- E. No quantitative stability and structural analysis of *DEEPWATER HORIZON* was conducted during the event.
- F. The lack of a salvage plan that identified a leader of the fire-fighting effort extended the amount of time *DEEPWATER HORIZON* was exposed to an uncoordinated fire-fighting effort.
- G. The overall fire-fighting effort lacked central coordination. As a result, massive quantities of water were directed toward the rig without careful consideration of the potential effects of water entering the hull. Although improved coordination likely would not have suppressed

---

<sup>339</sup> IMO MODU Code, Chapter 3, 3.1.5-6.

<sup>340</sup> MODU Safety Certificate (1989), the Republic of the Marshall Islands, June 11, 2006.

the fire, an unknown portion of the fire-fighting water (that which did not drain overboard or vaporize) contributed to the reduction of stability and freeboard of *DEEPWATER HORIZON*.

- H. The Area Contingency Plan did not properly address contingencies for this event, specifically offshore marine fire-fighting.
- I. The division of Search and Rescue mission coordinator and federal on scene coordinator (FOOSC) duties between the Eighth Coast Guard District and Captain of the Port (COTP) Morgan City, combined with the Coast Guard's policies regarding marine fire-fighting, limited the ability of the COTP Morgan City to properly respond to the marine fire-fighting aspect of the response as the FOOSC.
- J. Transocean did not follow its operations manual, specifically by not maintaining watertight integrity and by not conducting required deadweight surveys.
- K. Transocean responders were unfamiliar with the vessel response plan; specifically they did not use pre-established resource providers.
- L. *DEEPWATER HORIZON* did not have a deadweight survey conducted every five years as required by the applicable 1989 International Maritime Organization (IMO) Mobile Offshore Drilling Unit (MODU) Code and the Republic of the Marshall Islands' Publication MI-293.
- M. Findings from the event do not indicate the need to modify the structural or stability requirements outlined in Chapters 2 and 3 of the IMO MODU Code.

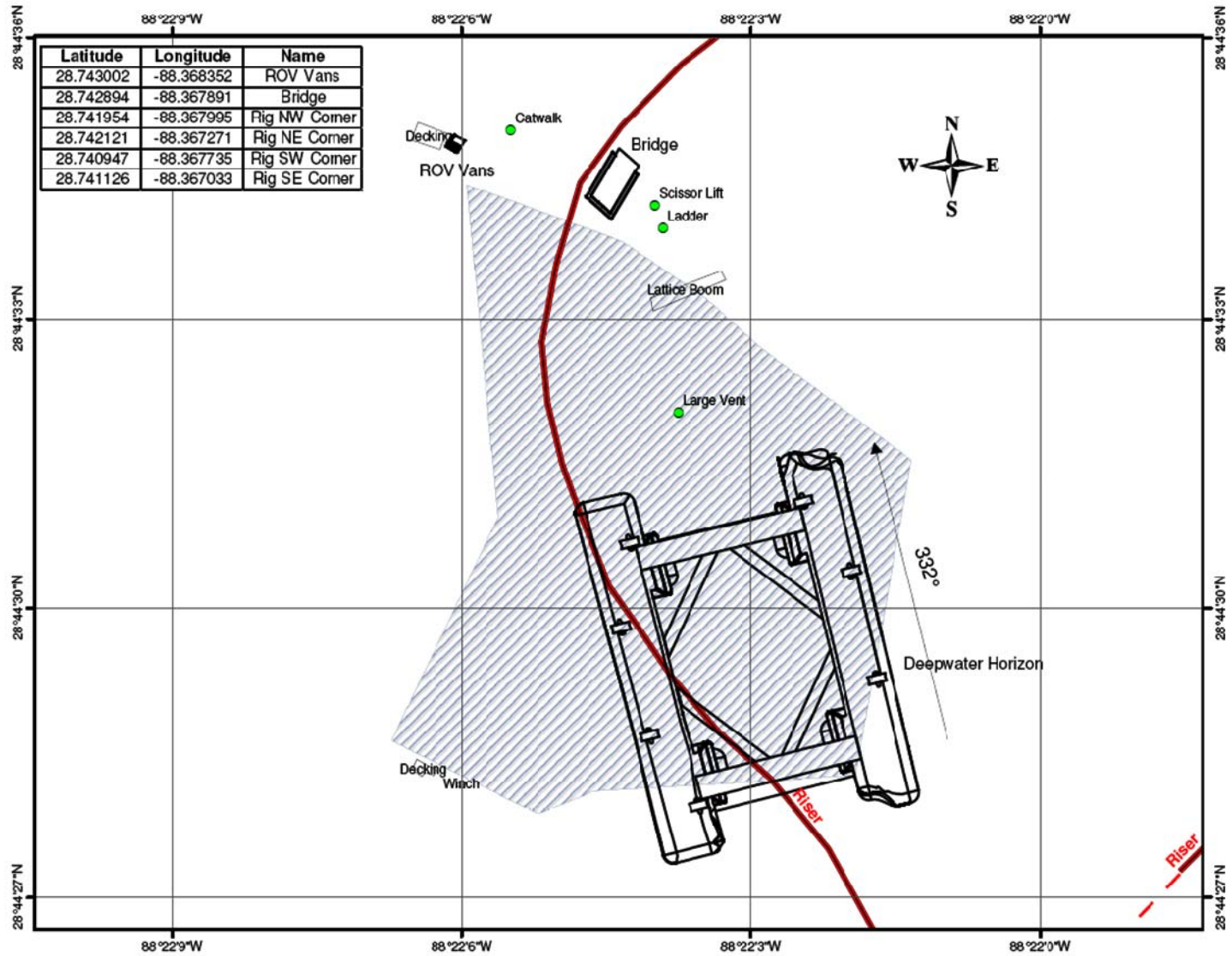

Figure 16 – *DEEPWATER HORIZON* Debris Layout

## Chapter 5 | SAFETY SYSTEMS (PERSONNEL AND PROCESS)

---

This section examines the mobile offshore drilling unit (MODU) *DEEPWATER HORIZON* safety systems regulated by the U.S. Coast Guard. Issues concerning the effectiveness of the safety management system of the lessee operator (BP) will be discussed in Volume II of this Joint Report.

### I. Overview

Throughout the joint investigation, Transocean consistently maintained that *DEEPWATER HORIZON* was a safe vessel. It pointed to the facts that *DEEPWATER HORIZON* possessed all required valid statutory safety certificates, and that the company was awarded a “Safety Award for Excellence” by the Minerals Management Service (MMS) / Bureau of Ocean Energy Management, Regulation and Enforcement (BOEMRE) in 2008.<sup>341</sup> Moreover, on the day of the casualty, several BP and Transocean senior executives were onboard to congratulate the crew on their outstanding safety and performance records.<sup>342</sup> However, Transocean’s view of the effectiveness of its company and *DEEPWATER HORIZON*’s safety management system (SMS) is not supported by the evidence of numerous instances on *DEEPWATER HORIZON* and other Transocean vessels of deficiencies in safety-related systems, inoperable or poorly maintained equipment with the potential to impact safety, and lack of proper personnel training on issues relating to safety. Many such deficiencies were identified during a BP inspection of *DEEPWATER HORIZON* conducted by a five-person team over five days in September 2009 and a Transocean inspection of *DEEPWATER HORIZON* conducted by a five-person team over 14 days in April 2010, within two weeks of the disaster. The Joint Investigation Team has documented these deficiencies in Appendices J (Synopsis of Audits & Surveys) and K (Examples of Transocean’s Non-Compliance with the International Safety Management Code). A copy of the 2009 BP inspection report is included as Appendix N.

The investigation has also revealed significant failures by *DEEPWATER HORIZON*’s flag state, the Republic of the Marshall Islands (RMI), to properly oversee safety issues on the MODU. The Coast Guard, in order to identify and eliminate substandard ships from U.S. waters, sends examiners under its Port State Control (PSC) program to foreign-flagged vessels to ensure that their structure, equipment, operation and the crew are in substantial compliance with U.S. laws and regulations, all applicable international conventions, and certificates issued by the flag state. These examinations, however, are less stringent than for U.S.-flagged vessels. As the coastal state, the United States only intervenes by detaining or restricting operations on those foreign-flagged vessels that have blatant deficiencies under international conventions or applicable U.S. regulations. The Coast Guard relies heavily on the flag state, such as the RMI, to ensure that foreign-flagged MODUs operating on the U.S. Outer Continental Shelf (OCS) are actually in compliance with all applicable international laws and regulations. The inadequate oversight over *DEEPWATER HORIZON* by the RMI and its recognized organizations, along with the failure of Transocean’s SMS, created an unsafe environment that allowed the *DEEPWATER HORIZON*

---

<sup>341</sup> 2008 District SAFE Award Recipients, <http://www.boemre.gov/awards/2008DistrictSAFEWinners.htm>.

<sup>342</sup> Testimony ██████████ 8/26/2010 pp 354-359; Testimony ██████████ 5/29/2010 pp 163-169; Testimony ██████████ 8/23/2010 p 442.

catastrophe to occur. These failings also raise questions with regard to the level of safety provided by “open registries.”<sup>343</sup>

## II. Systems

Many safeguards have been built into the design and operation of MODUs. For safety management, Transocean and *DEEPWATER HORIZON* were required to have a SMS that was in compliance with the International Safety Management (ISM) Code. The objectives of the ISM Code are to ensure safety at sea, prevent human injury or loss of life, and avoid damage to the environment.<sup>344</sup> Key components of an SMS include provisions for safe practices, established safeguards against known risks, continuous improvement of safety management skills, preparation for safety and environmental emergencies, compliance with mandatory rules and regulations, and giving consideration towards industry and regulatory guidelines and recommendations.

### A. Responsibility for Vessel Safety

As shown in Figure 17, for this casualty, four major stakeholders were identified: (1) Transocean (vessel operator), (2) BP (lessee operator), (3) RMI and its recognized organizations (flag state), and (4) the U.S. Coast Guard (coastal state). During day-to-day operations, Transocean had the primary responsibility for ensuring the safety of *DEEPWATER HORIZON* and the personnel onboard, and for the prevention of pollution. As a long-term lessee contractor, BP shared an interest in the condition of *DEEPWATER HORIZON* and contracted with rig inspectors to evaluate the materiel condition of *DEEPWATER HORIZON*.

RMI was responsible for conducting oversight of whether *DEEPWATER HORIZON* design, manning and operations were in accordance with international standards and flag state regulations. RMI delegated these duties to two recognized organizations, American Bureau of Shipping (ABS) and Det Norske Veritas (DNV). DNV was responsible for issuing ISM certificates, the Document of Compliance (DOC)<sup>345</sup> and the Safety Management Certificate (SMC).<sup>346</sup> ABS was responsible for issuing all other statutory certificates. Finally, the Coast Guard reinforced the “maritime safety net”<sup>347</sup> by annually verifying statutory certificates, conducting safety checks, and witnessing emergency drills during Certificate of Compliance (COC) examinations, a requirement for operations on the U.S. OCS.

---

<sup>343</sup> A nation that offers “open registry” is one whose flag registration is open to foreign ship owners. The RMI offers open registry.

<sup>344</sup> International Safety Management (ISM) Code, 2010 Edition, Section 1.2.1.

<sup>345</sup> A DOC is a document issued to a Company to signify that it is in compliance with the requirements of the ISM Code.

<sup>346</sup> A SMC is a document issued to a ship to signify that the Company and its shipboard management operate in accordance with the approved safety management system.

<sup>347</sup> <http://www.imo.org/OurWork/Safety/Implementation/Pages/PortStateControl.aspx>.

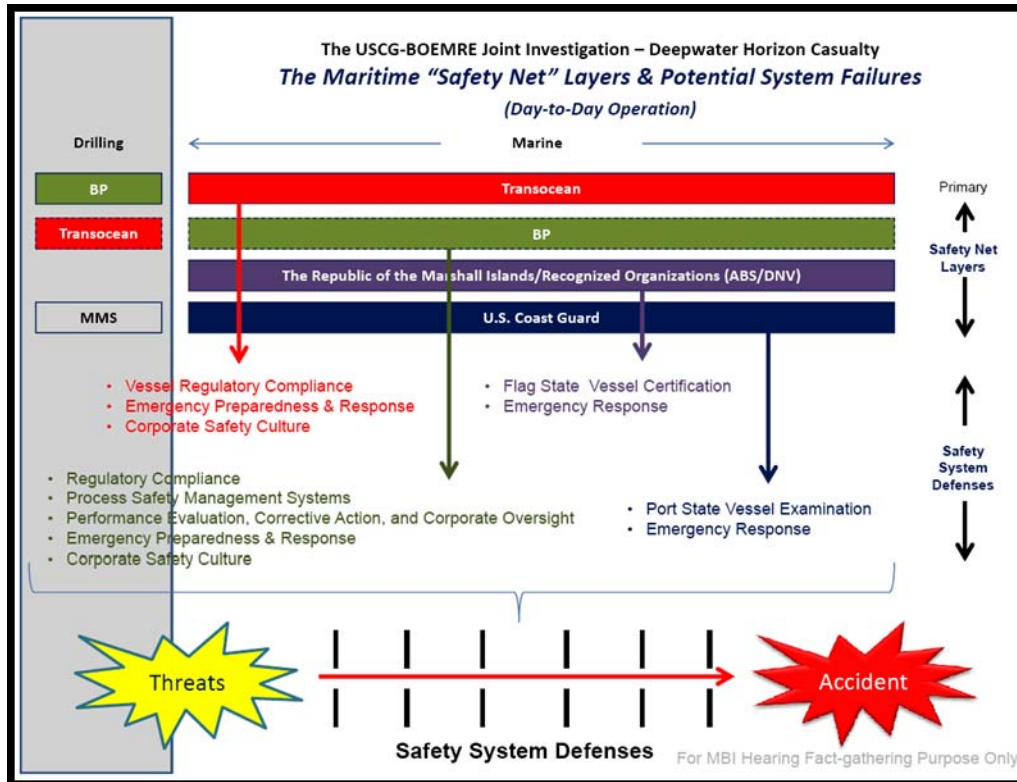

Figure 17 – The “Maritime Safety Net” Layers & Potential System failures

## B. Vessel SMS Requirements

In July 1998, to assist various stakeholders with their duties within the “Maritime Safety Net” and to establish standards for evaluating the effectiveness of a vessel’s SMS, the International Maritime Organization (IMO) implemented the ISM Code for many types of commercial vessels. On July 1, 2002, the ISM Code was implemented for MODUs.<sup>348</sup>

Figure 18 identifies the responsibilities for compliance with the ISM Code by *DEEPWATER HORIZON*. Under the ISM Code, Transocean was responsible for:

- Defining and documenting the responsibility, authority and interrelation of all personnel who manage, perform and verify work relating to and affecting safety and pollution prevention; and
- Ensuring that adequate resources and shore-based support are provided to enable such designated personnel to carry out their functions.<sup>349</sup>

<sup>348</sup> 1974 SOLAS Convention, As Amended, Chapter IX, Resolution MSC.99 (73), December 2000. The ISM Code is only applicable to self-propelled MODUs. A DPV MODU is self-propelled.

<sup>349</sup> International Safety Management (ISM) Code, 2010 Edition, Section 3.

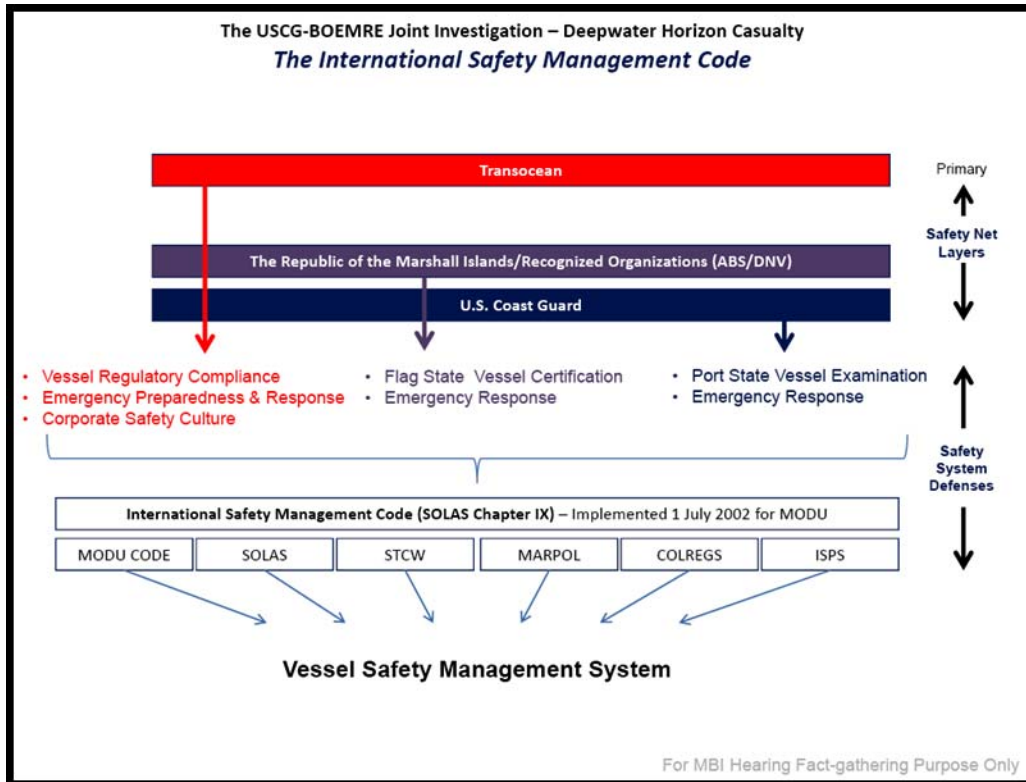

Figure 18 – The International Safety Management Code<sup>350</sup>

As the Flag State of *DEEPWATER HORIZON*, the RMI and its Recognized Organization DNV were responsible for:

- Verifying that *DEEPWATER HORIZON* and Transocean’s Safety Management Systems complied with the ISM Code;
- Withdrawing Transocean’s Document of Compliance (DOC) if there was evidence of major non-conformities with the Code;
- Withdrawing *DEEPWATER HORIZON*’s Safety Management Certificate (SMC) if there was evidence of major non-conformities with the Code; and
- Withdrawing all associated Safety Management Certificates if the DOC was withdrawn.<sup>351</sup>

<sup>350</sup> The International Conventions contained in Figure 15 include:

STCW – International Convention on Standards of Training and Certification and Watchkeeping outlines the standards of competencies seafarers must obtain in the performance of their service.

MARPOL – International Convention for the Prevention of Pollution from Ships.

COLREGS – International Regulations for Preventing Collisions at Sea set out the “rules of the road” to be followed by ships and other vessels at sea.

ISPS - International Ship and Port Facility Security Code is a comprehensive set of measures to enhance the security of ships and port facilities, developed in response to the perceived threats to ships and port facilities in the wake of the 9/11 attacks in the United States.



### C. Enforcement of the ISM Code

As with other flag states, RMI used Recognized Organizations, or classification societies, to conduct surveys of *DEEPWATER HORIZON* and issue statutorily required documents on its behalf. ABS and DNV are both members of the International Association of Classification Societies (IACS), and IACS issues Procedural Requirements (PRs), which are adopted through resolutions by its members, regarding matters of mutual concern. IACS PR17 “Reporting by Surveyors of Deficiencies relating to Possible Safety Management System Failures,” is in place to ensure that DNV, responsible for the issuance of the SMC, was notified when deficiencies relating to possible SMS failures were identified by the surveyor, ABS. In accordance with IACS PR 17, the following need to be reported by the surveyor:

- Deficiencies relating to technical conditions which may lead to the limitation, suspension or withdrawal of a Class or Statutory Certificate;
- Deficiencies relating to documentation;
- Deficiencies relating to operational requirements; and
- Other deficiencies which may seriously affect the safety of ship, personnel or the environment.<sup>352</sup>

As the coastal state, the United States dispatches Coast Guard Port State Control Officers (PSCOs) to conduct examinations to verify statutory certificates, test safety devices, and witness emergency drills. During the examination, the Coast Guard accepts a foreign vessel’s ISM certificates as evidence that the vessel and its company are in compliance with the requirements of the Code, and foregoes an expanded examination of the SMS unless there are clear grounds to do so. To ensure accurate and consistent enforcement, the Coast Guard provided PSCOs with Navigation and Vessel Inspection Circular (NVIC) 04-05, “The Port State Control Guidelines for the Enforcement of Management for the Safe Operation of Ships (ISM Code).” Per NVIC 04-05, examples of conditions that result in clear grounds for an expanded examination include, but are not limited to:

- Improperly endorsed or expired ISM certificates;
- Lack of SMS documentation;
- Crewmembers having insufficient knowledge of their required duties under the SMS; and/or
- Serious, long-standing material deficiencies or systemic lack of maintenance of critical equipment/systems as identified in the ship’s SMS.<sup>353</sup>

---

<sup>351</sup> International Safety Management Code, 2010 Edition, Section 13.

<sup>352</sup> [http://www.iacs.org.uk/document/public/Publications/Procedural\\_requirements/PDF/PR\\_17\\_pdf102.pdf](http://www.iacs.org.uk/document/public/Publications/Procedural_requirements/PDF/PR_17_pdf102.pdf), Section 4.1.

In determining the severity of a deficiency, Coast Guard PSCOs are guided by IMO Resolution A.787 (19), “Guidelines for the Detention of Ships.” For foreign-flagged MODUs engaging in drilling operations on the U.S. OCS, if a major ISM non-conformity<sup>354</sup> is found, the Coast Guard Officer in Charge Marine Inspection should order drilling operations to cease in accordance with the Resolution.<sup>355</sup>

#### D. *DEEPWATER HORIZON*’s Non-Compliance with the ISM Code

Although *DEEPWATER HORIZON* possessed valid ISM certificates at the time of the casualty, evidence documented in Appendix K shows many instances of the vessel’s failure to meet requirements of the ISM Code. Many of the discrepancies, if identified during an inspection by RMI, DNV, ABS, or the Coast Guard, would have been individually categorized as non-conformities. Collectively, they would have indicated a lack of effective and systematic implementation of the ISM Code and could or would have resulted in the assignment of a major non-conformity for the vessel. No one entity, however, had all of this information. Some significant examples that illustrate the systemic failure of *DEEPWATER HORIZON*’s SMS include:

- The 2009 DNV ISM audit revealed that *DEEPWATER HORIZON* had never clearly stated and documented the vessel master’s (captain’s) overriding authority and responsibility as required by the ISM Code.<sup>356</sup>
- The April 2010 audit noted that the date of the last certification of some of *DEEPWATER HORIZON*’S blowout preventer (BOP) components was 13 December 2000, which was “beyond the 5 yearly inspection, overhaul, and re-certification requirement.”<sup>357</sup> This failure to inspect and recertify the BOP within the past ten years violates the requirement of the ISM Code to ensure the vessel is maintained in conformity with the relevant rules and regulations, which call for such action every three to five years.
- The September 2009 audit determined that “further assurance is required to demonstrate that the permit to work and energy isolation systems are working as intended and incorporate the rigor that is demanded from such a key element of the Control of Work process.”<sup>358</sup> The purpose of the “permit to work” program is to identify risks before commencing non-routine work. For example, the program would require the company to identify and discuss which valves, if opened, will result in flooding before starting work to replace salt water piping. The fact that this safety system remained questionable in

---

<sup>353</sup> Coast Guard NVIC 04-05, p 7.

<sup>354</sup> A “non-conformity” is an observed situation where objective evidence indicates the non-fulfillment of a specified requirement. Objective evidence means quantitative or qualitative information, records or statements of fact pertaining to safety or to the existence and implementation of a safety management system element, which is based on observation, measurement or test and which can be verified.

<sup>355</sup> International Maritime Organization Resolution A.787 (19).

<sup>356</sup> DNV 2009 Annual ISM DOC Audit, TRN-USCG\_MMS-0043664.

<sup>357</sup> MODUSpec TRN-USCG\_MMS-00038652.

<sup>358</sup> BP *DEEPWATER HORIZON* Follow Up MODU Audit, Marine Assurance & Out of Service Period September 2009 BP-HZN-MTI00136217.

2009 is significant, given that in May 2008, *DEEPWATER HORIZON* experienced a flooding incident, necessitating \$920,000 in repairs, that was deemed attributable to a “lack of communication” regarding the opening of valves.<sup>359</sup>

#### E. Transocean’s Non-Compliance with the ISM Code

Despite having a valid DOC, Transocean and some of its other vessels operating throughout the world had a history of non-compliance with the ISM Code as documented in Appendix K. Some noteworthy examples include:

- In April 2010, *TRANSOCEAN DISCOVERER DEEP SEAS* operated with an invalid SMC.<sup>360</sup>
- In March 2009, *TRANSOCEAN DRILLER* received a major non-conformity for failing to correct previously observed non-conformities. The ISM Code states that the Company should establish procedures for the implementation of corrective action.<sup>361</sup>
- In April 2009, a review of Transocean’s SMS program had significant difficulty in determining the Transocean fleet’s ISM certification status, internal/external audits status, and Master Review status.<sup>362</sup>

Despite this record of non-compliance, DNV failed to connect the dots and endorsed Transocean’s DOC in Houston, Texas on April 21, 2010, at the same time that *DEEPWATER HORIZON* was engulfed in flames a couple hundred miles away in the Gulf of Mexico.<sup>363</sup> DNV has since sought to explain this decision by stating, “ISM Code audits are management system audits and not accident investigations. At the time of the incident, there was no objective evidence available to DNV that this incident was caused by the failures in the safety management system related to compliance with applicable IMO and Flag State requirements.”<sup>364</sup> If DNV had withheld the endorsement of the DOC, DNV would have essentially restricted operation of all of Transocean's ships globally. Instead, DNV validated Transocean's standards of management for the safe operation of ships on the day after the explosions.

### III. Actions/Decisions Contributing to Safety System Failure

- A. The investigation has shown that over a period of years and in the time period immediately preceding the casualty, Transocean had a history of deficiencies in the area of safety. These weaknesses include (1) a history of poor maintenance and failure to address it in a timely manner; (2) a history of other casualties that were never properly investigated and addressed; (3) a failure to establish a system to ensure that the Bridge was aware of the location of all personnel engaged in repair work in order to warn them of emergencies; (4) a failure to

---

<sup>359</sup> RMI Report of Vessel Casualty or Accident, 05\_30\_2010, RMI 00191-00192, RMI 00184-186.

<sup>360</sup> DNV Survey Report ISM Code DOC Annual Audit, 04/21/2010, TRN-USCG\_MMS-0043665-43667.

<sup>361</sup> DNV Survey Report ISM Code DOC Annual Audit, 04/15/2009, TRN-USCG\_MMS-00043662-43364.

<sup>362</sup> DNV Survey Report ISM Code DOC Annual Audit, 04/10/2008, TRN-USCG\_MMS-00043661.

<sup>363</sup> DNV Survey Report ISM Code DOC Annual Audit, 04/21/2010, TRN-USCG\_MMS-0043665-43667.

<sup>364</sup> DNV Letter, dated December 15, 2010.

provide sufficient training and knowledge to onboard management and crew regarding safety; (5) a failure to require that systems and personnel emphasize maximize emergency preparedness; and (6) a failure to employ risk assessment. Collectively, this record raises serious questions as to whether Transocean's approach to safety was a factor in allowing the casualty to occur.

**B. Transocean had a history of poor maintenance on DEEPWATER HORIZON and other vessels.**

The April 2010 third-party inspection on *DEEPWATER HORIZON*, just two weeks before the explosion, revealed maintenance deficiencies that could impact safety. For example, it found that:

- All eight propulsion thrusters had leaking seals, allowing seawater and oil to mix;
- Fresh and salt water and fixed fire-fighting piping was corroded and had seized valves;
- Watertight doors were inoperable;
- Watertight hatches needed replacement;
- Navigation lights were extinguished; and,
- Electrical power relays were overheating.<sup>365</sup>

As discussed in Chapter 1, this same audit found that Transocean had failed to properly track and maintain its hazardous electrical equipment on the Drill Floor, that the equipment was in "bad condition," and that contractors had been allowed to leave equipment in poor condition on the Drill Floor. As a result, there is no assurance that such equipment did not ignite flammable gas to cause the explosions on April 20.

One of the more serious maintenance issues identified during this April 2010 audit related to Transocean's BOP, manufactured by Cameron. The report stated that "upon review of certification documentation it was noted that the date of last manufacturer's certification was 13 December 2000" and "this is beyond the 5 yearly inspection, overhaul, and re-certification requirement." Rather than follow the American Petroleum Institute Recommended Procedure (API RP) 53, which called for inspection and certification every three to five years, Transocean had decided to use what it called a "condition-based" maintenance program, which did not require inspections on any particular schedule.<sup>366</sup> Transocean also failed to properly document the existence and terms of its BOP "condition-based" maintenance program.<sup>367</sup> Although Transocean claimed that its program was better than API RP 53, because Cameron does not release its maintenance guidelines to external parties, a true comparison between the two

---

<sup>365</sup> MODUSpec Rig Condition Assessment *DEEPWATER HORIZON*, TRN-USCG\_MMS-00038652

<sup>366</sup> Testimony Hay 8/25/2010 pp 203-206.

<sup>367</sup> USCG-BOEMRE meeting with Cameron representatives, February 9, 2010.

programs is not possible.<sup>368</sup> Notably, there is no evidence that Transocean consulted with Cameron before deciding to deviate from Cameron's established maintenance program.<sup>369</sup>

In addition, the 2009 BP inspection team recommended that for the BOP, Transocean should "expedite overhaul of the test, middle and upper pipe ram bonnets which are original and have significantly surpassed the recommended recertification period. Otherwise expedite replacements."<sup>370</sup> The audit team advised completion of this overhaul of key BOP parts "by end of 2009."<sup>371</sup> There is no evidence that Transocean completed this work before the casualty in April 2010.

As this example illustrates, not only did Transocean have maintenance problems on *DEEPWATER HORIZON*, but once it identified such issues it did not address them in a timely fashion. The September 2009 audit concluded that Transocean's maintenance of the rig was inadequate:

"[There were] significant overdue planned maintenance routines in excess of thirty days; these totaled 390 routines which corresponded to 3545 man hours. Many of the jobs were high priority designation, and it is unclear why Transocean did not plan some of these for the service period."<sup>372</sup>

The findings from the September 2009 BP *DEEPWATER HORIZON* inspection stated that with respect to its previous audit:

"A number of the recommendations that Transocean had indicated as closed out had either deteriorated again or not been suitably addressed in the first instance"; and

"In other cases findings were simply rejected, with no formal risk mitigation demonstrated."<sup>373</sup>

In addition, when the same auditors conducted an update status report on March 29, 2010, they found numerous items still awaiting resolution approximately six months after the initial findings. Most were originally given advised completion dates of no more than two months.<sup>374</sup> The extensive list of deferred maintenance on some vital systems documented in Appendix J and Appendix N indicate that the system in place for the safe management and operation of the MODU was not working.

---

<sup>368</sup> *Id.*

<sup>369</sup> Testimony ██████████ 8/25/2010 pp 353-354.

<sup>370</sup> BP *DEEPWATER HORIZON* Follow Up MODU Audit, Marine Assurance & Out of Service Period September 2009, BP-HZN-IIT-0008890.

<sup>371</sup> *Id.*

<sup>372</sup> BP *DEEPWATER HORIZON* Follow Up MODU Audit, Marine Assurance & Out of Service Period September 2009, BP-HZN-MBI00136211.

<sup>373</sup> BP *DEEPWATER HORIZON* Follow Up MODU Audit, Marine Assurance & Out of Service Period September 2009, BP-HZN-MBI00136214-215.

<sup>374</sup> BP *DEEPWATER HORIZON* Follow Up MODU Audit, Marine Assurance & Out of Service Period September 2009 Status March 29, 2010, TRN-USCG\_MMS-00043611-00043642.

This same tendency not to correct deficiencies extended to the company overall. In May 2007, Petroleum Safety Authority (PSA) Norway, which has regulatory responsibility for safety, emergency preparedness and the working environment in the petroleum sector, identified serious concerns about Transocean's compliance with regulatory requirements for maintenance management and handling of non-conformities.<sup>375</sup> PSA Norway stated:

“Transocean does not fulfill the regulatory requirements for maintenance management, nor does the company fulfill the regulatory requirements for handling of nonconformities. We found the conditions to be so serious that a notification of order was issued.”<sup>376</sup>

PSA Norway noted that “deficient maintenance can increase the risk of major accidents, injuries, and accidents.”<sup>377</sup>

**C. *DEEPWATER HORIZON* had a history of casualties that endangered the safety of the rig that were never properly investigated**

*DEEPWATER HORIZON* had two incidents in 2008 that jeopardized the safety of the MODU, but did not result in investigation. In August 2008, *DEEPWATER HORIZON* lost electrical power and “blacked out,” which resulted in the vessel losing the ability to actively maintain its position for a period of two minutes.<sup>378</sup> When *DEEPWATER HORIZON* was on station engaged in drilling, it relied upon the proper operation of a dynamic positioning system, consisting of a complex system of shipboard sensors and eight electric powered propulsors, to keep the vessel in one location over the well in various sea states. If power was lost, *DEEPWATER HORIZON* would not be able to counteract the environmental forces acting on it and could drift off station. Because the riser, the only connection between *DEEPWATER HORIZON* and the sea floor, is not designed to be an anchor, such drift could impose enough force to break the MODU free from the well head. Although the environmental conditions were calm on April 20,<sup>379</sup> under certain conditions such a power outage could have catastrophic consequences.

Transocean never conducted an investigation sufficient to determine the precise cause of the blackout. Although the crew planned to change out an actuator and a governor, or a speed limiter, to address the problem,<sup>380</sup> according to ABS's assistant chief surveyor for offshore, “one governor failure on a DP-3 Class rig should not cause any blackout at all.”<sup>381</sup>

Although not required by law or regulation, neither RMI nor ABS conducted a third-party investigation of this incident. When asked why ABS did not investigate the loss of power, ABS's assistant chief surveyor for offshore stated, “I can only assume that the guy talking with the people onboard understood the situation and decided it wasn't a Class issue.”<sup>382</sup> Moreover, ABS did not notify DNV of this event, even though it involved a deficiency that could seriously

---

<sup>375</sup> <http://www.ptil.no/news/audit-of-maintenance-management-in-transocean-offshore-ltd-article3286-79.html>.

<sup>376</sup> *Id.*

<sup>377</sup> *Id.*

<sup>378</sup> RMI Report of Vessel Casualty or Accident, August 10, 2008, RMI 00182-183.

<sup>379</sup> Testimony ██████████ 05/27/2010 p 176.

<sup>380</sup> Email between RMI and *DEEPWATER HORIZON*, RMI 180.

<sup>381</sup> Testimony ██████████ 05/26/2010 p 224.

<sup>382</sup> Testimony ██████████ 05/26/2010 p 224.

affect the safety of ship and personnel.<sup>383</sup> The reason for ABS's failure to notify DNV is not specifically known, but the master of *DEEPWATER HORIZON* reported to RMI by email that when notified of the event, ABS told the chief engineer onboard that ABS "did not need to get involved with the situation."<sup>384</sup>

In May 2008, *DEEPWATER HORIZON* suffered flooding in its starboard forward column. ABS conducted an inspection to verify repairs to the damaged equipment. According to the RMI Report of Vessel Casualty or Accident submitted by the Master:

"The preliminary cause is during the early morning of 26 May 08 a 12 inch pipe approximately 5 feet long had been removed from the seawater line, which can be crossed over to the ballast system. The pump was electrically isolated, but the valves that protect the pump room from water ingress were not mechanically isolated. Due to lack of communication a valve in the system was opened causing an ingress of water."<sup>385</sup>

In other words, someone opened a valve that should have remained closed, with an effect similar to cutting a 12 inch hole in the bottom of the MODU. This action most probably resulted from a failure to follow the established procedures for tagging out or securing equipment during maintenance, created a flooding and stability issue that required the evacuation of non-essential personnel to a standby vessel.

Although this flooding likely constituted a deficiency "which may seriously affect the safety of ship, personnel, or the environment" that warranted notification to DNV, there is no evidence that ABS notified DNV of this event. In fact, ABS noted in its Damage Repair Survey on June 3, 2008 that "This Vessel is not subject to IACS PR 17 (Only when it is NOT required to have an ISM SMC Certificate)" indicating that the surveyor may have incorrectly believed that the ISM Code was not applicable to *DEEPWATER HORIZON*.<sup>386</sup> Thus, following this incident, DNV did not take any corrective action regarding the SMS onboard *DEEPWATER HORIZON*.<sup>387</sup>

**D. Transocean failed to establish a system to ensure that the Bridge was aware of the location of all personnel engaged in repair work in order to warn them of emergencies.**

This flooding incident exposed a weakness in *DEEPWATER HORIZON*'s "tag out" procedures and "permit to work" (PTW) program, which set forth requirements on how to make clear when systems are shutdown for repair through a system of issuing a permit whenever such work is underway. A failure of this system may have been responsible for the opening of a valve that caused the flooding. In July 2009, a Transocean Performance Monitoring Audit and Assessment raised a question about *DEEPWATER HORIZON*'s PTW system, under which the senior toolpusher was assigned to be the work permit administrator and keep track of work occurring on the MODU.<sup>388</sup> The Performance Monitoring Audit and Assessment (PMAA) manager noted:

---

<sup>383</sup> Testimony ██████████ 05/26/2010 pp 331-332.

<sup>384</sup> Email between RMI and *DEEPWATER HORIZON*, RMI00180.

<sup>385</sup> RMI Report of Vessel Casualty or Accident, 05\_30\_2010, RMI 191-192.

<sup>386</sup> ABS Class Survey Report 03-Jun-2008, ABSDWH003894-3901.

<sup>387</sup> Testimony ██████████ 05/26/2010 pp 330-332.

<sup>388</sup> Transocean Management Summary of Corrective and Improvement Opportunities, Performance Monitoring Audit and Assessment, July 2, 2009, TRN-USCG\_MMS-0004379 (final digit of the Bates number not legible).

“[I]n regards to having the Snr. Toolpusher as the PTW administrator what does the rig do in an emergency when the toolpusher goes to the rig floor. I would have thought the DPO’s are the ideal people to administer the permits.”<sup>389</sup>

This system of leaving the PTW system in the charge of an official who is not always on the bridge may have prevented the bridge from warning personnel of the explosions on April 20. That evening, the Chief Electrician had arranged for some work on the mud pump that required it to be electrically isolated, necessitating a permit.<sup>390</sup> The on-watch SDPO recalled talking just prior to the explosions with one of the men last seen in the Mud Pump Room, but did not ask him what job he was doing or where the job was to be performed.<sup>391</sup> Because the “lock-out/tag out log” which tracked work in progress was not controlled by the bridge personnel,<sup>392</sup> the SDPO did not know there were people working in the Mud Pump Room when the combustible gas alarms activated, so he did not call the Mud Pump Room to warn personnel.<sup>393</sup> Had Transocean addressed the PMAA’s concerns and arranged to have the SDPO or other Bridge personnel monitor the PTW program, he would have known that there were workers in the Mud Pump Room and likely would have warned them of the emergency.

**E. Transocean failed to ensure that its onboard management team and crew had sufficient training and knowledge to take full responsibility for the safety of the vessel, including during a well control issue.**

In their testimony before the Joint Investigation Team, Transocean witnesses and corporate executives consistently maintained that it was BP’s drilling plan and procedures that caused the casualty and that Transocean did not have any input regarding the safety of *DEEPWATER HORIZON*. In fact, as the vessel owner and operator, Transocean had responsibility for compliance with the ISM Code, and there is no evidence that BP assumed sole responsibility for such compliance. BP and Transocean had executed a bridging document that indicated that they had joint responsibility for Health, Safety and Environmental (HSE) programs.<sup>394</sup>

During the Joint Investigation Team hearing, Transocean’s ISM Designated Person for the North American Division demonstrated very little knowledge of the ISM Code and could not explain the company’s program for compliance.<sup>395</sup> Significantly, the Designated Person “is the person ashore whose influence and responsibilities should significantly affect the development and implementation of a safety culture within the Company.”<sup>396</sup>

---

<sup>389</sup> *Id.*

<sup>390</sup> Statement [REDACTED] 4/21/2010.

<sup>391</sup> Testimony [REDACTED] 10/5/2010 p 314.

<sup>392</sup> Testimony [REDACTED] 10/5/2010 p 314.

<sup>393</sup> Testimony [REDACTED] 10/5/2010 p 294.

<sup>394</sup> BP Gulf of Mexico Transocean Offshore Deepwater Drilling Inc. North America HSE Management System Bridging Document, September 8, 2008.

<sup>395</sup> Testimony Canducci 12/09/2010 pp 4-126.

<sup>396</sup> International Safety Management Code, 2010 Edition, Guidelines for the Operational Implementation of the ISM Code by Companies.



This lack of knowledge and training on safety matters was also present onboard *DEEPWATER HORIZON*. The master testified that the SMS training consisted of a PowerPoint presentation sent from shore, which he viewed onboard just prior to the incident.<sup>397</sup> When asked, “So what’s in this PowerPoint presentation?” he replied, “I’m sorry, I don’t recall those details.”<sup>398</sup> The master was also unable to recall where the SMS was physically located onboard, or whether it was stored on a computer or in a binder. He stated that for most of those small details, he could not recall.<sup>399</sup>

As discussed in Chapter 1, during the casualty, the master apparently did not know that he had the authority to activate the Emergency Disconnect System, a critical step that could have cut off the flow of flammable gases to the MODU. Moreover, the on-watch DPO had not been trained to report gas alarms to the Engine Control Room (ECR) or advise the ECR to shut down the engines, and she was unaware of procedures relating to the activation of the emergency shutdown (ESD) system under such circumstances, even though shutting down engines is a means to avert an explosion.<sup>400</sup>

Furthermore, the September 2009 BP audit of *DEEPWATER HORIZON* revealed training and knowledge deficiencies on systems that could impact safety. It found that:

- Contractors were not knowledgeable with drilling and well operations practice or engineering technical practices;
- There was ineffective RMS II training regarding the maintenance management system; and
- There was inadequate training on “Kelvin Top Set.”<sup>401</sup>

Training issues extended to other Transocean vessels. In April 2009, the *GSF DEVELOPMENT DRILLER I* was observed to have a significant issue with crew training. Only 63% of the crew had the required training as defined by the company training matrix.<sup>402</sup>

## F. Transocean did not ensure proper emergency preparedness

The investigation has identified weaknesses in Transocean’s emergency preparedness systems that may have reduced the crew’s effectiveness in responding to the well control issue. First, Transocean allowed the crew to bypass emergency safety mechanisms. As noted during the September 2009 audit, “control of alarms and defeats and bypasses was not well managed, in fact no single person could account for which alarms, etc. were overridden or indeed for what

---

<sup>397</sup> Testimony ██████████ 5/27/2010 pp 174-175.

<sup>398</sup> Testimony ██████████ 5/27/2010 pp 212-214.

<sup>399</sup> *Id.*

<sup>400</sup> *See supra* Chapter 1.

<sup>401</sup> BP *DEEPWATER HORIZON* Follow Up MODU Audit, Marine Assurance & Out of Service Period September 2009, BP-HZN-MBI-00136218.

Kelvin TOP-SET is a leading incident investigation and problem solving methodology, <http://www.kelvintopset.com/>

<sup>402</sup> Initial ISM/ISPS; TRN-USCG\_MMS-00059172.

reason.”<sup>403</sup> As discussed in Chapter 1, the crew routinely bypassed an automatic shutdown system designed to turn off electrical power to prevent flammable gas from reaching ignition sources, in order to avoid restarting the system whenever the system activated. It also routinely put gas alarms in “inhibited” mode, so that any false alarms would not awaken the crew.<sup>404</sup> The fact that Transocean permitted this pattern of bypassing safety mechanisms in a manner that placed crew convenience ahead of emergency preparedness raises questions about its commitment to safety.

Second, the investigation has revealed that *DEEPWATER HORIZON* emergency drill procedures were not robust. Although Transocean held drills every week to address emergency situations such as fire and abandon ship, they were always held at the same time, which rendered them less realistic and effective than drills held at random times. Transocean required well control drills, but they were limited to just 16 personnel, and the drills never addressed a situation in which a well control issue might lead to a fire and need to abandon ship.<sup>405</sup> Although *DEEPWATER HORIZON* crew responded to fire drills prior to the casualty in a timely manner, reports from the fire drills onboard identified needed improvement, including: “Drills need to be treated as the real deal and all life saving equipment needs to be utilized,” “continue training personnel in the use of life saving equipment,” and “Still having Third Party Personnel show up at life boats without gloves.”<sup>406</sup> Beyond *DEEPWATER HORIZON*, several ISM audits revealed deficiencies in the emergency preparedness programs onboard other Transocean vessels.<sup>407</sup>

Certain crew actions during the event itself indicated that Transocean’s emergency drills did not properly prepare the crew for a simultaneous well control issue, fire, and abandon ship. The on-watch dynamic positioning officer failed to follow emergency procedures and sound the general alarm after observing the gas detection alarms, failed to notify the watchstanders in the ECR of the alarms so they could shut down the engines, and did not activate the emergency shutdown system for ventilation during a high gas alarm.<sup>408</sup> Although lifeboat and abandon ship training was required, the crew had such difficulty in taking a muster and launching the first lifeboat that some crew members chose to jump overboard from great heights rather than wait for the lifeboats.<sup>409</sup>

One report indicated that the original announcement was “fire, fire, fire, report to your secondary muster station do not go outside,”<sup>410</sup> but the crew should have been notified, and already known, that in the response to a well control event leading to a fire they should report directly to the primary muster station at the lifeboats.

Furthermore, the shore-side emergency response team that formed at the Transocean Emergency Response Center shortly after the incident was not adequately organized or trained to respond to

---

<sup>403</sup> BP *DEEPWATER HORIZON* Follow Up MODU Audit, Marine Assurance & Out of Service Period September 2009, BP-HZN-IIT-0008884.

<sup>404</sup> See *supra* Chapter 1.

<sup>405</sup> Testimony [REDACTED] 10/5/2010 pp 200-201.

<sup>406</sup> Safety Drill Report RMI 000627-638.

<sup>407</sup> Initial ISM/ISPS; TRN-USCG\_MMS-00059172, 00059193, 00059216, 00059202.

<sup>408</sup> Testimony [REDACTED] 10/5/2010 pp 40, 59-61.

<sup>409</sup> Testimony [REDACTED] 5/28/2010 pp 210-211.

<sup>410</sup> Testimony [REDACTED] 5/28/2010 pp 234-235.

a marine casualty of this size. During Transocean's own internal ISM audit conducted in March 2010, Transocean observed that "in reviewing the roles of the Emergency Response team it was identified that personnel assigned a role within the team have not been provided with training regarding their duties."<sup>411</sup> As a result, this team failed to have a full understanding of the emergency procedures and resource providers already in place to assist in these types of emergencies, and it ended up providing conflicting tasking to those on scene.<sup>412</sup>

By permitting safety systems to be bypassed and failing to have a robust emergency drill system and shoreline response team, Transocean revealed a lack of emphasis on safety that limited its ability to avoid or mitigate the impact of the casualty.

**G. Transocean did not instruct *DEEPWATER HORIZON* onboard management team to conduct proper risk assessment.**

In the time period leading up to the casualty, as the personnel on *DEEPWATER HORIZON* were struggling to complete the well drilling, the numerous maintenance deficiencies, training and knowledge deficiencies, and limited emergency preparedness described above demonstrated that *DEEPWATER HORIZON* faced clear safety risks that were not confronted. For example, given the important role a BOP plays during an emergency to protect the crew members, who essentially live directly above the well, the failure of the onboard management team to demand that the BOP be maintained in accordance with the manufacturer's recommendations is difficult to understand.

This acceptance of departures from safety requirements is similar to the "*Normalization of Deviance*" identified in the *PIPER ALPHA* incident, in which crew members failed to detect early warning signs of impending dangerous situations.<sup>413</sup>

Under these conditions, a risk assessment tool, such as the one created during the course of this investigation (Appendix M, Operational Risk Assessment), could have been employed to identify the possible consequences of operating *DEEPWATER HORIZON* in its documented condition. If warranted by the results of the assessment, the onboard management or crew could have exercised their Transocean stop work authority, known as a "Time Out for Safety" (TOFS), which "occurs when an observation made by personnel requires the task be stopped for the purpose of addressing an unplanned hazard or a change in expected results."<sup>414</sup> According to the Transocean Health and Safety Policy Statement, "Each employee has the obligation to interrupt an operation to prevent an incident from occurring."<sup>415</sup>

Transocean, however, did not provide the onboard management with a risk assessment tool or other means by which to assess the risks arising from well conditions and the safety related deficiencies onboard *DEEPWATER HORIZON*. Not surprisingly, prior to April 20, no crew

---

<sup>411</sup> Transocean Internal ISM Audit, TRN-USCG\_MMS-00043696

<sup>412</sup> Transocean Emergency Response Center Log, TRN-USCG\_MMS-00038824.

<sup>413</sup> The Public Inquiry into the Piper Alpha Disaster, Hon. Lord Cullen, November 1990, Volume 1, pp 65-69.

<sup>414</sup> Transocean Health and Safety Policies and Procedures Manual, December 14, 2009, TRN-HCEC-00004896-4897.

<sup>415</sup> Transocean Health and Policy Statement, December 15, 2009, TRN-HCEC-0004731.

members took action to institute a safety time out, nor did any crew members make a report to the Coast Guard or any other government agency regarding unsafe conditions on *DEEPWATER HORIZON*.

Transocean also did not create a climate conducive to such analysis and reporting of safety concerns. In March 2010, Transocean hired Lloyd's Register, a classification society, to conduct a SMS Culture/Climate Review which included auditors conducting surveys at Transocean offices and vessels over a two week period. The results indicated that "a significant proportion (43.6%) of the personnel participating in the perception survey reported that they worked with a fear of reprisal if an incident or near hit occurred. This issue is strongly related to the investigation process, which nearly 40% of the participants believed was applied to apportion blame."<sup>416</sup> At a company where employees fear reprisal for whatever reason and when there are significant costs associated with any unscheduled shutdown or delay of drilling activities, it is unlikely that the crew would report safety issues even if it identified risks.

#### **IV. U.S. Government/Class/Flag Oversight**

*DEEPWATER HORIZON* casualty and the subsequent investigation have exposed weaknesses in the U.S. Coast Guard and flag state oversight of *DEEPWATER HORIZON* and in the regulations and standards for the operation and maintenance of MODUs.

##### **A. The Republic of the Marshall Islands did not meet its responsibility to ensure the safety of *DEEPWATER HORIZON*.**

In 2009, the RMI issued a certificate to *DEEPWATER HORIZON* classifying it as a self-propelled MODU, as opposed to a dynamic positioned vessel.<sup>417</sup> RMI has since described this action as a "clerical error."<sup>418</sup> This error, however, had significant consequences. A self-propelled MODU without a dynamic positioning system must be anchored to the ocean floor when it is on location to maintain position. According to RMI, a non-DPV does not require a traditional marine crew led by a master while the MODU is on location. However, given that the dynamic positioned MODU is always taking active means to remain on location, a master and full marine crew is required at all times for a DPV.<sup>419</sup> When classified as a self-propelled MODU, however, Transocean was permitted under international regulations to implement a dual-command organizational structure on the vessel, which reduced the master's awareness of potential threats to his vessel and his effectiveness in ensuring the safety of his vessel. As discussed in Chapter 1, the dual-command organizational structure may have delayed the activation of the vessel's emergency disconnect system and increased the likelihood of the subsequent events (explosion, fire, loss of life, injury, and sinking).

The RMI did not provide adequate oversight of DNV, its Recognized Organization for verifying Transocean's compliance with the ISM Code, to ensure that *DEEPWATER HORIZON* and

---

<sup>416</sup> Lloyd's Register SMS Climate/Cultural Review, March 9 – 26, 2010, TRN-HCEC-00090503.

<sup>417</sup> RMI Safe Manning Certificate, September 17, 2009, RMI 00027.

<sup>418</sup> The Republic of the Marshall Islands letter dated August 25, 2010 to the Joint Board of Investigation.

<sup>419</sup> The Republic of the Marshall Islands letter dated August 25, 2010 to the Joint Board of Investigation, RMI Safe Manning Certificate, September 17, 2009, RMI 00027.

Transocean were truly in compliance with the ISM code. As documented in Appendix K, Transocean's non-compliance with the ISM Code requirements included deficiencies on *DEEPWATER HORIZON*, other Transocean vessels that operated worldwide, and at the corporate office. For example, during a 2009 audit, *TRANSOCEAN DRILLER* was found to have previously identified non-conformities still unresolved.<sup>420</sup> Instead of raising a red flag and issuing a major non-conformity for this failure of the SMS system, DNV unacceptably decided to classify the problem as a simple non-conformity.<sup>421</sup>

The RMI also did not provide adequate oversight of ABS, its Recognized Organization charged with verifying *DEEPWATER HORIZON*'s compliance of all regulatory requirements not delegated to DNV. Specifically, relating to the flooding casualty in May 2008, the RMI was notified of the casualty but it did not question ABS's determination, without any investigation into the cause of the flood, that there was no deficiency relating to a possible safety management system failure.<sup>422</sup>

Additionally, the RMI missed opportunities to identify and address the ineffectiveness of *DEEPWATER HORIZON*'s SMS when it failed adequately to conduct its own investigations into the vessel's previous flooding and loss of power casualties in 2008.<sup>423</sup> The fact that these casualties could have had severe consequences for *DEEPWATER HORIZON*, its crew, and the coastal state illustrates that RMI's policy of not investigating incidents if they do not meet the specific IMO Resolution A.849(20) definition of "serious marine casualty" is inadequate to ensure safety.

RMI's lack of oversight allowed *DEEPWATER HORIZON* to continue to operate when there were grounds for it to be detained and ordered to cease operation. According to RMI's Marine Notice on the ISM Code, a major non-conformity includes operational shortcomings that would render the ship substandard by IMO standards.<sup>424</sup> IMO Resolutions A.739(19) and A.882(21) provide guidelines for conditions which would result in a detention by a coastal state. Based on these resolutions, the U.S. Coast Guard will detain a vessel if it is determined to have (1) multiple deficiencies affecting the vessel's safety, none of which alone warrant vessel detention, but which collectively make the ship substandard with respect to compliance with IMO conventions, or (2) a failure of essential machinery to operate properly, especially due to lack of maintenance.<sup>425</sup> *DEEPWATER HORIZON* had multiple deficiencies documented in its two audits, including failures of the essential bilge system -- three of the four bilge pumps were tested, and all three bilge pumps failed to function properly.<sup>426</sup> Had *DEEPWATER HORIZON* been a U.S.-flagged MODU, the Coast Guard likely would have become aware of the condition of the bilge pumps and the list of other deficiencies and detained it under extant Coast Guard

---

<sup>420</sup> DNV Survey Report ISM Code DOC Annual Audit, 04/15/2009, TRN-USCG\_MMS-00043662-43364.

<sup>421</sup> *Id.*

<sup>422</sup> RMI Letter to Joint Investigation Team dated December 6, 2010.

<sup>423</sup> RMI Report of Vessel Casualty or Accident RMI 191-192, RMI 00184-186, RMI 00182-183.

<sup>424</sup> RMI Marine Notice No. 2-011-13, Rev. 7/10.

<sup>425</sup> NVIC 06-03, CH-2; Coast Guard Port State Control Targeting and Examination Policy for Vessel Security and Safety, Appendix A.

<sup>426</sup> BP *DEEPWATER HORIZON* Follow Up MODU Audit, Marine Assurance & Out of Service Period September 2009, BP-HZN-MBI00136213.

guidance.<sup>427</sup> However, because *DEEPWATER HORIZON* was a foreign-flagged MODU subject only to limited Coast Guard oversight, it fell primarily to RMI to identify these deficiencies and detain *DEEPWATER HORIZON* if warranted. RMI failed to exercise this responsibility.

Several of the conclusions arising from *DEEPWATER HORIZON* casualty can be linked directly back to RMI's failure to ensure that *DEEPWATER HORIZON* was in compliance with all applicable requirements, including those relating to the electrical installations in hazardous zones, degradations in watertight integrity, crew training, emergency preparedness, and others. Having never inspected the vessel except through Recognized Organizations, RMI entrusted all flag state inspection duties to Recognized Organizations and did not conduct sufficient oversight of those classification societies to detect mistakes and accurately determine the condition of its vessel prior to the casualty. Such oversight is crucial because there is always a potential conflict of interest in the work of classification societies, as they are paid by the vessel owner and only perform the work the owner requests. This casualty raises serious questions about the model under which a flag of open registry may rely entirely on classification societies to do its inspection and investigative work.

**B. The Coast Guard regulatory scheme for ensuring the safety of foreign-flagged MODUs engaging in U.S. OCS activities is insufficient.**

The weaknesses in the flag state's oversight of *DEEPWATER HORIZON*'s safety illustrate the need to consider strengthening U.S. regulation of foreign-flagged MODUs engaging in OCS activities.

**1. Coast Guard safety examinations of foreign-flagged MODUs do not provide an equivalent level of safety as compared to the Coast Guard inspections of U.S.-flagged MODUs.**

By regulation, the scope of a Coast Guard inspection of a U.S.-flagged MODU and a Coast Guard safety examination of a foreign-flagged MODU are significantly different.<sup>428</sup> The Coast Guard inspection is a lengthy process that includes an assessment of all regulated systems onboard, issuance of applicable certificates, and witnessing of emergency drills. By contrast, Coast Guard safety examinations on a foreign-flagged MODU generally require less time, since the flag state is responsible for conducting the vessel's safety oversight. This arrangement should work if the flag state conducts inspections comparable to those conducted by the Coast Guard on U.S.-flagged MODUs. The weaknesses in the performance of *DEEPWATER HORIZON*'s flag state and its Recognized Organizations, when compared to the findings from the audits in September 2009 and April 2010, raises questions whether the U.S. safety examination system for foreign-flagged MODU's needs to be enhanced.

**2. The Coast Guard casualty reporting regulations for foreign-flagged MODU's engaging in U.S. OCS activities are insufficient.**

---

<sup>427</sup> NVIC 06-03, CH-2; Coast Guard Port State Control Targeting and Examination Policy for Vessel Security and Safety, Appendix A.

<sup>428</sup> Testimony [REDACTED] 05/12/2010 pp 192-193.

The Outer Continental Shelf Lands Act (OCSLA) of 1953<sup>429</sup> authorizes the Coast Guard to investigate Marine Casualties, but its regulations do not require foreign-flagged MODUs to report the same types of marine casualties on the U.S. OCS involving their vessels that U.S. flagged MODUs are required to report.<sup>430</sup> The Coast Guard casualty reporting thresholds for a foreign-flagged MODU engaged in OCS activities are less stringent than those for a U.S. MODU. Under 33 C.F.R. § 146.303, a foreign-flagged MODU is only required to notify the Coast Guard and submit a written report for casualties that involve:

- (a) Death;
- (b) Injury to 5 or more persons in a single incident; or,
- (c) Injury causing any person to be incapacitated for more than 72 hours.

Accordingly, Transocean was not required to inform the Coast Guard of the flooding and total loss of power casualties in 2008, even though a loss of power on a dynamically positioned vessel attached to a well by a riser can be catastrophic. Per its maritime regulations, the RMI required Transocean to submit written reports for these casualties;<sup>431</sup> however, the RMI did not investigate them and was not required to do so.<sup>432</sup>

The requirements of a U.S.-flagged MODU are different. In accordance with 46 C.F.R. § 4.05-1(a), the following incidents must be reported to the U.S. Coast Guard:

- (1) An unintended grounding, or an unintended strike of (allison with) a bridge;
- (2) An intended grounding, or an intended strike of a bridge, that creates a hazard to navigation, the environment, or the safety of a vessel, or that meets any criterion of paragraphs (a) (3) through (8);
- (3) A loss of main propulsion, primary steering, or any associated component or control system that reduces the maneuverability of the vessel;
- (4) An occurrence materially and adversely affecting the vessel's seaworthiness or fitness for service or route, including but not limited to fire, flooding, or failure of or damage to fixed fire-extinguishing systems, lifesaving equipment, auxiliary power-generating equipment, or bilge-pumping systems;
- (5) A loss of life;
- (6) An injury that requires professional medical treatment (treatment beyond first aid) and, if the person is engaged or employed on board a vessel in commercial service, that renders the individual unfit to perform his or her routine duties; or

---

<sup>429</sup> 43 U.S.C § 1348 (as amended December 29, 2000).

<sup>430</sup> 46 C.F.R. 4.03-1.

<sup>431</sup> RMI Maritime Act Amended 1990, RMI 00790.

<sup>432</sup> RMI Letter to Joint Investigation Team dated December 6, 2010.

- (7) An occurrence causing property-damage in excess of \$25,000, this damage including the cost of labor and material to restore the property to its condition before the occurrence, but not including the cost of salvage, cleaning, gas-freeing, drydocking, or demurrage.
- (8) An occurrence involving significant harm to the environment as defined in Sec. 4.03-65.

Had *DEEPWATER HORIZON* been required to report to the Coast Guard marine casualties described in 46 C.F.R. § 4.05-1, it would have had to report both 2008 incidents, which in turn likely would have led to the identification of the systemic failure of the vessel's work permit system. It also likely would have led to scrutiny of the vessel's SMS and a requirement that corrections be made. Reporting of marine casualties allows the Coast Guard to identify trends and safety issues across specific industries or types of vessels to be investigated, evaluated and addressed. Thus, this casualty raises questions whether reporting requirements for foreign-flagged MODUs should be made equivalent to those of U.S. flagged MODUs.

### **3. Coast Guard regulations for reporting unsafe working conditions are ineffective.**

Although *DEEPWATER HORIZON* had numerous deviations from regulatory standards, no crew member reported such violations to the U.S. Coast Guard. Neither the Transocean TOFS policy nor the federal "whistleblower" guidelines in place cause such reporting to occur. The current regulation, 33 C.F.R. § 142.7, does not require reporting of unsafe working conditions; it simply states:

- (a) Any person **may** report a possible violation of any regulation in this subchapter or any other hazardous or unsafe working condition on any unit engaged in OCS activities to an Officer-in-Charge, Marine Inspection.
- (b) After reviewing the report and conducting any necessary investigation, the Officer-in-Charge, Marine Inspection, notifies the owner or operator of any deficiency or hazard and initiates enforcement measures as the circumstances warrant.
- (c) The identity of any person making a report under paragraph (a) of this section is not made available, without the permission of the reporting person, to anyone other than those officers and employees of the agency receiving the report.

Given the fear of reprisal amongst almost half of the crew members questioned during the Lloyds Register SMS Climate and Culture assessment,<sup>433</sup> and the inherent difficulties for crew members to come forward with information about safety concerns, consideration should be given to making reporting of safety violations mandatory rather than voluntary.

---

<sup>433</sup> Lloyd's Register SMS Climate/Cultural Review, 3/9-26, 2010, TRN-HCEC-00090493-90685.



**4. International standards and Coast Guard regulations do not properly reflect differences relating to dynamically positioned (DP) Vessels.**

The manning requirements of a DP vessel are unique and different from those of traditionally manned vessels or even MODUs anchored to the ocean floor, in that the vessel requires more manning because it is effectively always taking active propulsion measures to remain on location. The consequences of a loss of propulsion on a DP vessel, where station keeping can be vital, is much greater than on a traditional vessel that may simply drift momentarily while propulsion is restored. The terminology surrounding DP vessels adds to some confusion as well. Appendix I (Potential Legal Issues Associated with Vessels Employing Dynamic Positioning Systems) addresses these differences and concludes that regulations and international standards should be amended to clarify issues regarding manning, credentialing, design, and operations.

**5. The post casualty drug testing regulations for foreign-flagged MODUs engaging in U.S. OCS activities are insufficient.**

Current regulations only require owners and operators of U.S.-flagged MODUs to determine if drugs and alcohol were a contributing factor in an incident occurring on the U.S. OCS.<sup>434</sup> Owners and operators of foreign-flagged vessels are only required to conduct post-casualty drug testing, and only if the serious marine casualty occurs on the navigable waters of the United States.<sup>435</sup> Drug testing must be performed within 32 hours of the serious marine incident, and alcohol testing must be conducted within two hours and is not required after eight hours.<sup>436</sup>

In this instance, however, no alcohol testing was conducted because the crew remained at sea on *DAMON B. BANKSTON* for several hours and did not return to shore until approximately 0130 on April 22, roughly 28 hours after they abandoned ship, and there were not enough alcohol testing strips onboard that vessel to test all crew.<sup>437</sup> Although alcohol use is not thought to be a contributing cause in this incident, regulations and procedures should be corrected to ensure that following a serious marine casualty on a foreign flagged MODU operating on the U.S. OCS, all crew members are required to and able to undergo alcohol testing.

**6. The Coast Guard's current delegation of OCS inspection responsibilities inhibits mastery of the required inspection skill set.**

With the implementation of the Alternative Compliance Program (ACP) in 1992, the Coast Guard delegated authority to the ABS and other Recognized Organizations to conduct inspections on its behalf for some commercial vessels. However, per Navigation and Vessel Inspection Circular 02-95, Change 2, the Coast Guard still attend and conduct periodic examinations on ACP vessels for certification and oversight.

---

<sup>434</sup> 46 C.F.R. 4.03-1, 46 4.05-1, 46 C.F.R. 4.05-10, 46 C.F.R. 4.05-12.

<sup>435</sup> 46 C.F.R. 4.03-1, the navigable waters of the U.S. extend 12 miles from the baseline and do not cover the the location of the Macondo well or the entire OCS.

<sup>436</sup> 46 CFR 4.03-1 (a), 46 CFR 4.03.2.

<sup>437</sup> No positive results: DWH crew, International Drug Detection, LLC, Harahan, LA., West Jefferson Hospital, Marrero, LA, Southern Alabama University Hospital, Mobile, AL. and Ochsner Medical Center, Gretna, LA. Bankston [REDACTED] KLS, Gretna, LA.

Some U.S.-flagged MODUs utilize the ACP program and therefore are inspected by the ABS rather than the Coast Guard. As a result, within the Coast Guard some inspection skill sets relevant to MODUs are now almost non-existent, which has reduced the competency of the inspection program and limited the Coast Guard's ability to provide proper technical and effective oversight of the Recognized Organizations and other flag states.

Coast Guard expertise on the inspection of MODUs is further limited by the existing organizational structure on the Gulf Coast. Currently, inspections of MODUs operating on the OCS are divided amongst six Officers in Charge Marine Inspection (OCMI) zones on the Gulf Coast. The division of labor and workload only requires one OCMI to have a dedicated OCS inspection office with four to five inspectors; the remaining offices have one to three inspectors performing OCS inspections intermittently. Because there are several additional advanced skill sets required for OCS work, it is difficult for some zones to train and maintain the required competencies. If all OCS duties were assigned to one centralized office, the consistent inspection workload would allow members assigned to that office to specialize in OCS inspections and become true subject matter experts. A one-office approach would also allow for consistent enforcement of newly developing technologies that have outpaced regulations.

## V. Conclusions

*DEEPWATER HORIZON* and its owner, Transocean, have had serious safety management system failures and a poor safety culture, as manifested in the maintenance deficiencies, training and knowledge gaps, and emergency preparedness weaknesses discussed above, which culminated in the casualty at the Macondo well on April 20, 2010. Many well-known gaps in the "Maritime Safety Net" for foreign-flagged MODUs aligned and tragically failed to prevent the deaths of eleven people and the largest oil spill in U.S. history.

- A. *DEEPWATER HORIZON*'s safety management system had significant deficiencies that rendered it ineffective in preventing this casualty. It failed to support proper risk assessment and decision making by *DEEPWATER HORIZON* leadership, to provide adequate maintenance of safety critical equipment, and to ensure the crew was trained and ready to respond to emergencies.
- B. Transocean's safety management system had significant deficiencies that rendered it ineffective in preventing this casualty. The company leaders' failure to commit to compliance with the International Safety Management Code and created a safety culture throughout its fleet that could be described as: "running it until it breaks," "only if it's convenient," and "going through the motions." This is best illustrated by the condition based maintenance of the BOP, and the deferral of recertification and required maintenance, the bypassing of alarms and emergency shutdown devices, and the conduct of emergency drills. This culture resulted in poor materiel conditions, ineffective decision making, and inadequate emergency preparedness for responding to catastrophic events.
- C. The crew onboard *DEEPWATER HORIZON* and Transocean employees failed to identify the potential consequences of their decisions regarding deferred maintenance and the loss of situational awareness regarding the overall safety of the MODU.

- D. The Republic of the Marshall Islands failed to meet its responsibility for ensuring the safety of *DEEPWATER HORIZON*.
- E. The Republic of the Marshall Islands failed to properly monitor the activities of its Recognized Organizations, DNV and ABS.
- F. The regulatory regime for the Coast Guard to ensure the safety of foreign flagged MODUs is not as comprehensive as that used for U.S.-flagged MODUs operating on the OCS.
- G. The International Association of Classification Societies Procedural Requirement 17, “Reporting by Surveyors of Deficiencies relating to Possible Safety Management System Failure,” did not function properly. There is no evidence of any communications from ABS to DNV regarding possible SMS deficiencies found onboard *DEEPWATER HORIZON*.
- H. The international standards and Coast Guard regulations for dynamic positioned vessels do not properly address the current design, operation and manning found aboard these vessels.
- I. Foreign-flagged MODUs operating beyond the navigable waterways of the United States are not subject to the same standard of marine casualty reporting or chemical testing requirements established for U.S. MODUs.
- J. The current Coast Guard inspection program for MODUs and the Alternative Compliance Program hinder the mastery of required inspector skill sets and limit the effectiveness of Coast Guard oversight of Recognized Organizations and other flag states.

The conclusions reached in the causal analysis of this series of events, set forth at the end of the preceding chapters, are repeated in this summary chapter to better reflect the conclusions in a single place and to provide summarized conclusions in support of the recommendations that follow in chapter 7.

The *DEEPWATER HORIZON* casualty was the tragic result of a series of failures that resulted in hydrocarbons travelling up the riser and igniting onboard *DEEPWATER HORIZON*. The resulting explosions and fire caused the deaths of eleven people, the injury to sixteen others, and the sinking of the vessel. However, it is also noteworthy that 115 people successfully evacuated and survived. The conclusions identify factors that contributed to or mitigated the effects of the casualty and provide the basis for recommended improvements to prevent similar tragedies in the future.

Systematic failures in the Safety Management System of Transocean and *DEEPWATER HORIZON* rendered the system ineffective in preventing or responding to the flow of hydrocarbons in the riser and the subsequent explosion and fire. The Safety Management System failed to provide proper risk assessment, adequate maintenance and materiel condition, and process safety adherence. The Flag State and USCG did not identify these system failures in time to ensure the safety of the vessel.

### 1. Explosion

- A. The exact location of the ignition source or sources that caused the initial and subsequent explosions and fire on *DEEPWATER HORIZON* cannot be conclusively identified. A number of possible ignition sources may have been present on the MODU, the most likely of which are electrical equipment on the Drill Floor, in the engine rooms, or in the switchgear rooms.
- B. The first explosion and fire occurred on the Drill Floor in or near the mud gas separator system. The second explosion occurred in Engine Room # 3 or in one of the adjacent switchgear or electrical rooms.
- C. The second explosion caused a total loss of electrical power by damaging electrical power distribution and control equipment and circuits in or near Engine Room # 3.
- D. The classified electrical equipment installed on *DEEPWATER HORIZON* at the time of the incident may not have been capable of preventing the ignition of flammable gas. Previous audit findings showed a lack of control over the maintenance and repair of such equipment; therefore, it cannot be determined whether the classified electrical equipment was in proper condition. The 1989 International Maritime Organization (IMO) Mobile Offshore Drilling Unit (MODU) Code is insufficient because it does not have clear requirements for the long term labeling and control of classified electrical equipment, nor does it establish requirements or guidance for the continued inspection, repair and maintenance of such

- E. The fire and gas detection system was not arranged to automatically activate the emergency shutdown (ESD) system if flammable gases were detected in critical areas. The system relied upon the crew on watch in the Central Control Room/Bridge to take manual actions to activate the necessary ESD systems; however, inadequate training was provided to clarify each crew member's responsibilities in the event of fire or gas detection. As a result, the Engine Control Room was not immediately notified to shut down the operating generators following the detection of gas, nor was the ESD systems activated for these areas. Additionally, a number of fire and gas detectors may have been bypassed or inoperable at the time of the casualty. The 1989 IMO MODU Code is insufficient because it does not include specific requirements for the design and arrangement of gas detection and alarm systems. This concern has not been corrected in the 2009 IMO MODU Code.
- F. Separation of the Drill Floor from the adjacent occupied areas by A-class bulkheads, as specified by the 1989 IMO MODU Code, did not provide effective blast protection for the crew. The majority of injuries occurred in the accommodations areas separated from the Drill Floor by A-class bulkheads. The 1989 MODU Code is insufficient because it does not include minimum standards for the blast resistance of occupied structures. The 2009 IMO MODU Code is also insufficient because it only requires an evaluation to ensure the level of blast resistance of accommodation areas adjacent to hazardous areas is adequate, and fails to address structures housing vital safety equipment.
- G. The arrangement of main and emergency generators on *DEEPWATER HORIZON* met the requirements of the 1989 IMO MODU Code for separation by A-60 divisions; however, the arrangement of air inlets was not adequately taken into account. Flammable gases may have affected all six engine rooms since their air inlets were not exclusively located. The 1989 IMO MODU Code is insufficient because it does not require the separation of the emergency generator air inlets from likely sources of flammable gases. This concern has not been corrected in the 2009 IMO MODU Code.
- H. The Republic of the Marshall Islands' (RMI) "clerical error" in listing *DEEPWATER HORIZON* as a self-propelled MODU instead of a dynamic positioned vessel enabled Transocean to implement a dual-command organizational structure on board the vessel. This arrangement may have impacted the decision to activate the vessel's emergency disconnect system (EDS). Even though the master, who was responsible for the safety of his vessel, was in the CCR at the time of the well blowout, it cannot be conclusively determined whether his questionable reaction was due to his indecisiveness, a lack of training on how to activate the EDS or the failure to properly execute an emergency transfer of authority as required by the vessel's operations manual. U.S. regulations do not address whether the master or OIM has the ultimate authority onboard foreign registered dynamic positioned MODUs operating on the U.S. Outer Continental Shelf.

- I. By not visiting and inspecting *DEEPWATER HORIZON*, RMI lacked the ability to validate or audit its recognized organizations (ROs) in order to ensure that their inspection reports were accurate and that the RO was adequately performing its role.
- J. Class surveyors may not always perform regulatory oversight on a specific system unless it is part of the survey. Pieces of the statutory inspection are integrated into the classification survey which results in an incremental examination. Even though a surveyor is frequently on board, the possibility exists that a system may not be inspected until it is required by regulations.
- K. The Coast Guard's current guidance for inspectors performing MODU Certificate of Compliance examinations and the casework process contained in the Coast Guard Marine Information for Safety and Law Enforcement database system do not provide inspectors with a sufficient level of detail for documenting and entering examination activities. Only the main categories of inspected systems are provided. As a result, it is impossible to understand which specific systems were satisfactorily examined by the Coast Guard.
- L. The guidance circulars used by Coast Guard MODU inspectors and the offshore industry are inadequate.

## 2. **Fire**

- A. The fire brigade members quickly decided that the fire was not controllable and did not begin active fire-fighting efforts. Although that was a reasonable response in this case, there is evidence to support the view that the routine, repetitive nature of the weekly fire drills had led to a degree of complacency among the crew members and that personnel did not fully embrace the importance of fire brigade exercises.
- B. The fire main system was not capable of operation after all electrical power was lost, because only electric motor driven fire pumps were provided. The 1989 IMO MODU Code as amended in 2009 is insufficient because it does not require a portion of the pumping capability to be supplied by diesel pumps or similar independent sources.
- C. The A-class fire barriers surrounding the Drill Floor were not effective in preventing the spread of the fire. A-class bulkheads are not tested for exposure to hydrocarbon fire sources. The 1989 IMO MODU Code as amended in 2009 is insufficient because it does not require fire separations between the drilling area and adjacent accommodation spaces or spaces housing vital safety equipment to withstand such exposures.
- D. There is no evidence that any consideration was given prior to abandonment of the MODU to trying to determine the condition or location of crew members who may have been injured or trapped, except for the chief mate's independent attempt to organize the rescue of the starboard crane operator, only to be driven back by subsequent explosions. It was not until the safety of *DAMON B. BANKSTON* was reached that a full accounting of the crew was undertaken by those in charge.

- E. The use of manual fire hoses to fight a hydrocarbon fire of the magnitude experienced on the Drill Floor and adjacent areas of *DEEPWATER HORIZON* could expose the onboard fire brigade members to dangerous levels of fire and heat. A fixed deluge system for the protection of these areas would not place the fire brigade members in jeopardy and could be rapidly activated upon gas detection to mitigate the effects of a possible explosion.
- F. The prescriptive standards in the IMO MODU Code do not provide an adequate level of fire protection when considering fires of the magnitude experienced on the Drill Floor and adjacent areas of *DEEPWATER HORIZON*. The 1989 MODU Code is insufficient because it does not require a supplemental performance-based risk analysis to calculate the necessary levels of protection for the unique design, arrangement and operation of each MODU. The 2009 amendments to the IMO MODU Code now require an engineering evaluation to determine the level of fire protection needed for occupied areas that are located adjacent to the hazardous areas on the Drill Floor, but it does not provide guidance on the method for performing the engineering evaluation or defining acceptance criteria.

### 3. Evacuation / Search and Rescue

- A. The presence of the visiting BP and Transocean executives in the Central Control Room/Bridge of *DEEPWATER HORIZON* immediately prior to the casualty may have diverted the attention of the offshore installation manager and senior toolpusher from the developing well conditions, limited their interactions with the on-watch drilling crew, and led to their failure to follow the emergency evacuation procedures.
- B. The boundaries established at the bow Liferaft Embarkation Station were inadequate to shield evacuating personnel from exposure to radiant heat emanating from under *DEEPWATER HORIZON*'s column stabilized hull.
- C. Once there was a loss of electrical power, the emergency lighting available in the accommodations, the muster areas, and especially the lifeboat and liferaft lowering stations was inadequate, and there was no lighting over the water into which the lifeboats/liferafts were to be launched, making safe evacuation of personnel and launching of the lifeboats/liferafts more hazardous.
- D. The current lifeboat design and testing requirements do not adequately ensure the safe loading of a stretcher or permit adequate seating to accommodate the physical build of the average offshore worker today.
- E. The International Convention on Standards for Training, Certification and Watchstanding (STCW) does not currently identify a MODU as a "Special Ship," for which marine personnel would be required to undergo specialized training prior to certification. Masters, officers, particular ratings and special personnel assigned to MODUs are not required to receive specialized training for crowd control, crisis management or human behavior. Such training could have helped minimize the chaos and confusion surrounding the muster and evacuation of *DEEPWATER HORIZON*.

- F. The International Maritime Organization (IMO) MODU Code and U.S. Coast Guard subjective language that liferaft launch drills should be conducted “when practicable” minimized the officer-in-charge’s opportunities to obtain training experiences in the actual preparation, boarding and launching of liferafts served by davit launching appliances.
- G. Transocean’s failure to include on board training in the use of davit-launched liferafts, including the proper inflation and lowering of the liferafts at intervals of not more than four months as prescribed by regulations, significantly reduced the crew’s competency in performing these functions in an emergency.
- H. Conducting weekly fire and abandonment drills at fixed times and on predetermined days did not adequately prepare the crew to respond to the casualty “as if the drill was an actual emergency.” The crew would have been better prepared if emergency drills were staggered at different times of the day, on different days and during varying environmental conditions.
- I. The failure to integrate weekly well control and evacuation drills limited the crew’s ability to demonstrate knowledge and understanding of their duties and responsibilities as outlined in *DEEPWATER HORIZON*’s operations manual and the emergency response manual.
- J. The 2009 IMO MODU Code has removed some previous standards concerning the performance of crew musters and drills, such as demonstrating the ability to timely muster all crew members and having them prepared to carry out their assigned duties and replaced them with recommendations. The implementation of the reduced standards will likely lead to additional confusion during actual casualties.
- K. The STCW does not adequately establish standards and competencies for officers-in-charge of emergency procedures to operate lifesaving appliances that serve liferafts.
- L. The inflatable liferafts on *DEEPWATER HORIZON* served by launching appliances did not provide adequate protection for occupants under the circumstances. The exposure to extreme heat due to the proximity of the fire to the launching area, combined with the lack of a water spray system, placed them at greater risk during the evacuation.
- M. The storage location of the knife in *DEEPWATER HORIZON*’s liferaft was not easily identifiable to the occupants. Had reflective tape and standard IMO symbols been used, the occupants likely could have found the knife and freed the raft from the painter line on their own.
- N. The quantity and location of rescue boats provided on MODUs should align with the “widely separated location” philosophy adopted for lifeboats. The location of a secondary rescue boat at the alternate lifeboat location would increase the availability of a rescue boat.
- O. The proximity and operational capabilities of the offshore supply vessel *DAMON B. BANKSTON* were critical to the successful evacuation of the one hundred-fifteen survivors of this casualty.



- P. The fast rescue craft from *DAMON B. BANKSTON* was extremely effective in ensuring the safe recovery of crew members from *DEEPWATER HORIZON*.
- Q. There currently are no IMO MODU Code standards or Coast Guard regulations to require quarterly drills for a man overboard on MODUs. Failure to require these drills made *DEEPWATER HORIZON* ill-prepared to efficiently recover persons in the water with either *DEEPWATER HORIZON*'s designated rescue boat, or other predetermined emergency response resources.
- R. Pursuant to the regulations in Title 33, Code of Federal Regulations (C.F.R.), Subchapter N, only leaseholders of an area on the U.S. Outer Continental Shelf (OCS), where a MODU will be operating, are required to develop and submit an Emergency Evacuation Plan (EEP). Owners/operators of MODUs operating on the OCS need to have a comprehensive understanding of the applicable EEP in order to ensure the safe evacuation of personnel in an emergency.
- S. Pursuant to the regulations in 33 C.F.R. Subchapter N, there are no established performance and evaluation criteria for an EEP, nor is there an annual requirement to exercise the EEP. The combination of only requiring the leaseholder to develop an EEP and not requiring an on-site demonstration of the MODU's proficiency in executing the EEP significantly undermines its value.
- T. The Joint Investigation Team concurs with the conclusions that are documented in Appendix G, *Final Action Report On the SAR Case Study Into the Mass Rescue of Personnel off the Mobile Offshore Drilling Unit DEEPWATER HORIZON*.

#### 4. **Flooding & Sinking**

- A. The exact cause of the loss of stability and sinking of *DEEPWATER HORIZON* cannot be determined with the limited information available.
- B. The only method to effectively fight the fire onboard *DEEPWATER HORIZON* would have been to remove the fuel source by securing or disconnecting from the well.
- C. The limited communications between the Transocean emergency response center and the representative on scene made it difficult for the shore-side responders to fully understand the changing conditions of the situation.
- D. Responders and investigators did not have access to information regarding how *DEEPWATER HORIZON* was loaded prior to the casualty.
- E. No quantitative stability and structural analysis of *DEEPWATER HORIZON* was conducted during the event.

- F. The lack of a salvage plan that identified a leader of the fire-fighting effort extended the amount of time *DEEPWATER HORIZON* was exposed to an uncoordinated fire-fighting effort.
- G. The overall fire-fighting effort lacked central coordination. As a result, massive quantities of water were directed toward the rig without careful consideration of the potential effects of water entering the hull. Although improved coordination likely would not have suppressed the fire, an unknown portion of the fire-fighting water (that which did not drain overboard or vaporize) contributed to the reduction of stability and freeboard of *DEEPWATER HORIZON*.
- H. The Area Contingency Plan did not properly address contingencies for this event, specifically offshore marine fire-fighting.
- I. The division of Search and Rescue mission coordinator and federal on scene coordinator (FOSC) duties between the Eighth Coast Guard District and Captain of the Port (COTP) Morgan City, combined with the Coast Guard's policies regarding marine fire-fighting, limited the ability of the COTP Morgan City to properly respond to the marine fire-fighting aspect of the response as the FOSC.
- J. Transocean did not follow its operations manual, specifically by not maintaining watertight integrity and by not conducting required deadweight surveys.
- K. Transocean responders were unfamiliar with the vessel response plan; specifically they did not use pre-established resource providers.
- L. *DEEPWATER HORIZON* did not have a deadweight survey conducted every five years as required by the applicable 1989 International Maritime Organization (IMO) Mobile Offshore Drilling Unit (MODU) Code and the Republic of the Marshall Islands' Publication MI-293.
- M. Findings from the event do not indicate the need to modify the structural or stability requirements outlined in Chapters 2 and 3 of the IMO MODU Code.

## 5. Safety System (Personnel & Process)

The *DEEPWATER HORIZON* and its owner, Transocean, have had serious safety management system failures and a poor safety culture, which culminated in the casualty at the Macondo well on April 20, 2010. Many well-known gaps in the "Maritime Safety Net" for foreign-flagged MODUs aligned and tragically failed to prevent the deaths of eleven people and the largest oil spill in U.S. history.

- A. *DEEPWATER HORIZON*'s safety management system had significant deficiencies that rendered it ineffective in preventing this casualty. It failed to support proper risk assessment and decision making by *DEEPWATER HORIZON* leadership, to provide adequate maintenance of safety critical equipment, and to ensure the crew was trained and ready to respond to emergencies.

- B. Transocean's safety management system had significant deficiencies that rendered it ineffective in preventing this casualty. The company leaders' failure to commit to compliance with the International Safety Management Code and created a safety culture throughout its fleet that could be described as: "running it until it breaks," "only if it's convenient," and "going through the motions." This is best illustrated by the condition based maintenance of the BOP, and the deferral of recertification and required maintenance, the bypassing of alarms and emergency shutdown devices, and the conduct of emergency drills. This culture resulted in poor materiel conditions, ineffective decision making, and inadequate emergency preparedness for responding to catastrophic events.
- C. The crew onboard *DEEPWATER HORIZON* and Transocean employees failed to identify the potential consequences of their decisions regarding deferred maintenance and the loss of situational awareness regarding the overall safety of the MODU.
- D. The Republic of the Marshall Islands failed to meet its responsibility for ensuring the safety of *DEEPWATER HORIZON*.
- E. The Republic of the Marshall Islands failed to properly monitor the activities of its Recognized Organizations, DNV and ABS.
- F. The regulatory regime for the Coast Guard to ensure the safety of foreign flagged MODUs is not as comprehensive as that used for U.S.-flagged MODUs operating on the OCS.
- G. The International Association of Classification Societies Procedural Requirement 17, "Reporting by Surveyors of Deficiencies relating to Possible Safety Management System Failure," did not function properly. There is no evidence of any communications from ABS to DNV regarding possible SMS deficiencies found onboard *DEEPWATER HORIZON*.
- H. The international standards and Coast Guard regulations for dynamic positioned vessels do not properly address the current design, operation and manning found aboard these vessels.
- I. Foreign-flagged MODUs operating beyond the navigable waterways of the United States are not subject to the same standard of marine casualty reporting or chemical testing requirements established for U.S. MODUs.
- J. The current Coast Guard inspection program for MODUs and the Alternative Compliance Program hinder the mastery of required inspector skill sets and limit the effectiveness of Coast Guard oversight of Recognized Organizations and other flag states.

The recommendations developed as a result of this investigation are provided in the following sections and are aligned with the different chapters in the table of contents of the report. *DEEPWATER HORIZON* was constructed to the 1989 edition of the International Maritime Organization (IMO) Mobile Offshore Drilling Unit (MODU) Code, and many of the below recommendations suggest improvements to the IMO MODU Code. This investigation has chosen to make recommendations for improvements to the IMO MODU Code, realizing that despite its preamble and introductory language, as well as the Assembly Resolution adopting it, the Code does not address all aspects of MODU design, construction, equipment and operation as comprehensively as the U.S. regulations in Title 46 Code of Federal Regulations (C.F.R.) Subchapter I-A or the Classification Society rules. Although the Code is recommendatory in nature and intended to provide guidance to flag state Administrations for their use in promulgating their own domestic regulations, it is used extensively by Classification Societies as a basis for their MODU Rules. Any amendments to the IMO MODU Code will ultimately be promulgated by the International Association of Classification Societies members worldwide in their rules for the design and construction of MODUs.

It is also noted that the IMO MODU Code has been amended and substantially improved since 1989; however, the recommendations contained in this report identify areas that remain in need of improvement. Any areas that have significantly changed since 1989 have been noted in the text of the report.

### 1. Explosion Protection

- A. It is recommended that Commandant work with the IMO to amend the MODU Code to include clear requirements for the long term labeling and control of all electrical equipment in hazardous areas. In addition, requirements should be established for the continued inspection, repair and maintenance of electrical equipment in hazardous areas in the unit's safety management system. (Conclusion 1.D)
- B. It is recommended that Commandant work with the IMO to amend the MODU Code to provide more detailed guidance for the design and arrangement of fixed automatic gas detection and alarm systems as specified in paragraph 9.8 of the MODU Code (paragraph 9.11). The guidelines should include as a minimum, the recommended type and number of gas detectors, their arrangement, alarm set points, response times, wiring protocols and survivability requirements. (Conclusion 1.E)
- C. It is recommended that Commandant work with the IMO to amend the MODU Code to provide more detailed guidance for establishing fire and explosion strategies on board units using dynamic positioning systems for station keeping. The guidelines should provide a hierarchy of recommend automatic and manual emergency shutdown actions following gas detection in vital areas. The guidelines should also provide accepted approaches for the design and arrangement of the emergency power source necessary for station keeping in the event of a flammable gas release. (Conclusion 1.E)

- D. It is recommended that Commandant work with the IMO to amend the MODU Code to require specific minimum values for explosion design loads to be used in calculating the required blast resistance of structures. In addition, unified guidelines for performing the required blast resistance calculations should be developed. (Conclusion 1.F)
- E. It is recommended that Commandant work with the IMO to amend the MODU Code to require an explosion risk analysis of the design and layout of each facility. The analysis should use accidental blast loads defined by the Organization, to determine whether the levels of protection for accommodation areas, escape paths and embarkation stations provided by the prescriptive requirements in the Code are adequate. (Conclusion 1.F)
- F. It is recommended that Commandant work with the IMO to amend the MODU Code to require ventilation inlets for machinery spaces containing primary and emergency sources of power to be located as far as practicable from hazardous locations. (Conclusion 1.G)
- G. It is recommended that Commandant prepare and submit a “lessons learned” information paper to the IMO strongly recommending that existing facilities reevaluate the placement of supply air intakes for main and emergency power sources, coordinated with the fire and gas detection system logic. The paper should recommend that training, policies and procedures are implemented to shut down ventilation systems and close dampers in the event flammable gas is detected in critical locations. (Conclusions 1.E, 1.G)
- H. It is recommended that Commandant pursue the regulatory changes for dynamic positioned vessels recommended in Appendix I, including clear designation of the person in charge under both operating and emergency conditions for all MODUs operating on the U.S. OCS. (Conclusion 1.H)
- I. It is recommended that Commandant work with the IMO to evaluate the need to create a requirement for flag states to audit classification societies acting on their behalf as a recognized organization. (Conclusions 1.I, 1.J)
- J. It is recommended that Commandant evaluate the need to establish unannounced regulatory inspections. (Conclusions 1.I, 1.J)
- K. It is recommended that Commandant work with Recognized Organizations to evaluate the need to create a complete stand-alone regulatory check list that does not rely on the result of other surveys to ensure a 100% regulatory check of the MODU. (Conclusions 1.I, 1.J)
- L. It is recommended that Commandant evaluate the need for improving inspection guidance documents and case work entry standards to ensure the proper documentation of Certificate of Compliance examinations. (Conclusions 1.K, 1.L)

## 2. Fire Protection

- A. It is recommended that Commandant work with the IMO to amend the MODU Code to require that fire pump systems should be self contained and depend on no other onboard systems. This should include dedicated fuel supplies for at least 18 hours of operation. (Conclusion 2.B)
- B. It is recommended that Commandant work with the IMO to amend the MODU Code to require H-60 fire separations between the drilling area and adjacent accommodation spaces as well as any spaces housing vital safety equipment. (Conclusion 2.C)
- C. It is recommended that Commandant work with the IMO to amend the MODU Code to develop uniform guidelines that can be used as a basis for performing engineering evaluations to ensure that the level of fire protection of the bulkheads and decks separating hazardous areas from adjacent structures and escape routes is adequate for likely drill floor fire scenarios. (Conclusion 2.C)
- D. It is recommended that Commandant work with the IMO to amend the MODU Code to require a fixed deluge system or multiple high capacity water monitors for the protection of the drill floor and adjacent areas. Consideration should be given to requiring automatic operation upon gas detection. (Conclusion 2.E)
- E. It is recommended that Commandant work with the IMO to amend the MODU Code to require a fire risk analysis to supplement the prescriptive requirements in the MODU Code. The risk analysis should be a performance-based engineering evaluation that utilizes defined heat flux loads to calculate the necessary levels of protection for structures, equipment and vital systems that could be affected by fires on the drill floor, considering the unique design, arrangement and operation of each MODU. (Conclusion 2.F)

## 3. Evacuation / Search and Rescue

- A. It is recommended that Commandant work with the IMO to amend the IMO MODU Code to establish performance standards concerning the maximum allowable radiant heat exposure for personnel at the muster stations and lifesaving appliance lowering stations, along with guidelines for calculating the expected radiant heat exposure for drill floor fire events for each MODU hull type. (Conclusion 3.B)
- B. It is recommended that Commandant work with the IMO to harmonize the IMO MODU Code with International Convention for the Safety of Life at Sea (SOLAS) regulation III/16.7 to require adequate emergency lighting of Muster Areas, Lifeboat and Liferaft Lowering Stations and the corresponding waters into which the lifeboats/liferafts will be launched. (Conclusion 3.C)
- C. It is recommended that Commandant work with the IMO to amend the Lifesaving Appliances (LSA) Code and its testing recommendations to ensure the adequacy of lifesaving appliance standards. (Conclusion 3.D)

- D. It is recommended that Commandant remove or specifically define the term “when practicable” in Title 46 Code of Federal Regulations (C.F.R.) § 109.213(d)(1)(vii). It is further recommended that Commandant work with the IMO to amend the IMO MODU Code, Section 14.11.2.7. (Conclusion 3.F)
- E. It is recommended that Commandant work with the IMO to amend the International Convention on Standards for Training, Certification and Watchstanding (STCW) to establish MODUs as a “Special Ship” within Chapter V and develop specialized training standards and competencies for masters, officers, particular ratings and special personnel assigned to MODUs to include training for crowd control and crisis management. (Conclusion 3.E)
- F. It is recommended that Commandant work with the IMO to amend the IMO MODU Code to include the type, frequency, extent, randomness and evaluation criteria for all emergency contingency drills. (Conclusions 3.H, 3.I, 3.Q)
- G. It is recommended that Commandant work with the IMO to amend the STCW to develop standards and competencies for the operation of lifesaving appliances that serve liferafts. (Conclusion 3.K)
- H. It is recommended that Commandant evaluate the adequacy of inflatable liferafts served by a launching appliance installed on MODUs whose hull design is not of a traditional ship’s hull and determine if other suitable lifesaving appliances could enhance occupant safety. (Conclusion 3.L)
- I. It is recommended that Commandant work with the IMO to develop a symbol for “knife” and require the placement of a label to identify its location in all lifesaving appliances requiring the tool. (Conclusion 3.M)
- J. It is recommended that Commandant work with the IMO to amend the IMO MODU Code to prohibit the dual purpose acceptance of life boats as rescue boats, and adopt the “widely separated location” philosophy applied to the quantity and location of rescue boats on board MODUs. (Conclusion 3.N)
- K. It is recommended that Commandant revise the 33 C.F.R., Subchapter N regulations, to establish designated standby vessels for MODUs engaging in oil and gas drilling activities on the U.S. Outer Continental Shelf (OCS). (Conclusion O)
- L. It is recommended that Commandant work with the IMO to amend the IMO MODU Code to address the need for a fast rescue boat/craft on board MODUs. (Conclusion 3.P)
- M. It is recommended that Commandant amend 46 C.F.R. § 109.213 and work with the IMO to amend the IMO MODU Code to require the performance of a man overboard drill on at least a quarterly basis. (Conclusion 3.Q)

- N. It is recommended that Commandant revise the 33 C.F.R., Subchapter N regulations, to require the owner/operator of a MODU operating on the U.S. OCS, instead of the leaseholder, to develop and submit an emergency evacuation plan (EEP). (Conclusions 3.R, 3.S)
- O. It is recommended that Commandant revise the 33 C.F.R., Subchapter N regulations, to establish performance and evaluation criteria and require the annual exercise of the EEPs, including all identified emergency resources, equipment and agencies necessary to perform a mass evacuation. (Conclusions 3.R, 3.S)

#### **4. Flooding & Sinking**

- A. It is recommended that Commandant revise the current policy with respect to response plan requirements for vessels engaging in oil and gas drilling activities on the U.S. OCS. Operator's response plans should specifically address responses to vessel fires in addition to well fires. (Conclusion 4.B)
- B. It is recommended that Commandant evaluate regulatory requirements for operators of vessels engaging in oil and gas drilling activities on the U.S. OCS to maintain a continuously manned shore based operations center for monitoring operations and maintaining primary and emergency communications for responding to casualties. (Conclusion 4.C)
- C. It is recommended that Commandant evaluate regulatory requirements for vessels engaging in oil and gas drilling activities on the U.S. OCS to relay daily loading information to a designated person ashore. (Conclusion 4.D)
- D. It is recommended that Commandant extend current vessel response plan requirements for tank vessels to all vessels engaging in oil and gas drilling activities on the U.S. OCS. (Conclusion 4.E)
- E. It is recommended that area committees evaluate the adequacy of their area contingency plans for responding to incidents involving vessels engaging in oil and gas drilling activities on the U.S. OCS. (Conclusion 4.H)
- F. It is recommended that Commandant evaluate the current policy regarding the implementation of an incident commander to perform both the search and rescue mission coordinator and federal on scene coordinator duties during an event consisting of a mass rescue operation and a major marine casualty. (Conclusion 4.I)
- G. It is recommended that Commandant review all organization policy on marine firefighting to ensure consistency. (Conclusion 4.I)
- H. It is recommended that Commandant update the regulations to include the requirement to conduct a deadweight survey every five years for all (U.S. and foreign-flagged) column stabilized MODUs to be consistent with the current IMO MODU Code. (Conclusion 4.L)



## 5. Safety Systems: Personnel & Process

- A. It is recommended that Commandant develop a risk-based Port State Control targeting program to provide additional oversight for foreign-flagged MODUs working on the OCS based on predetermined evaluation criteria, including the identity of the flag state. (Conclusions 5.A, 5.B, 5.C)
- B. It is recommended that Commandant develop more comprehensive inspection standards for foreign-flagged MODUs operating on the OCS. (Conclusions 5.A, 5.B, 5.C, 5.D, 5.F)
- C. It is recommended that Commandant work with the IMO to develop a code of conduct for Recognized Organizations to ensure that verification of all flag state requirements are being conducted properly. (Conclusions 5.A, 5.B, 5.D)
- D. It is recommended that Commandant further develop the Operational Risk Assessment model (Appendix M) for use by MODU personnel and government inspectors. (Conclusion 5.A, 5.B, 5.E)
- E. It is recommended that Commandant work with International Association of Classification Societies to improve implementation of its Procedural Requirement 17. (Conclusion 5.G)
- F. It is recommended that Commandant revise the current marine casualty reporting requirements and drug testing requirements for foreign-flagged MODUs operating on the OCS and make them consistent with the requirements for U.S.-flagged MODUs. (Conclusion 5.I)
- G. It is recommended that Commandant evaluate the benefit of combining current OCS inspection responsibilities assigned to each OCMI into one OCMI covering all OCS inspection activities. (Conclusion 5.J)
- H. It is recommended that Commandant determine how to continue to maintain a properly trained and educated Coast Guard work force for inspecting vessels that are allowed to participate in the Alternative Compliance Program. (Conclusion 5.J)
- I. It is recommended that Commandant investigate the role of Safety Management System failures in recent marine casualties and based upon those findings; determine if a change in the current inspection and enforcement methods are required to increase compliance with the ISM Code. The investigation should include a request to the National Research Council, Commission on Engineering and Technical Systems, Marine Board to perform a comprehensive investigatory assessment of the effectiveness of the ISM Code as used in the marine environment. (Conclusion 5.C, 5.D, 5.E, 5.G)

- J. It is recommended that Commandant work with BOEMRE to evaluate the benefits of shifting to a “Safety Case” approach similar to that used in the North Sea, a method in which there is a more holistic approach to safety. (Conclusion 5.A, 5.B, 5.C, 5.D)
- K. It is recommended that Commandant require and coordinate expanded International Safety Management (ISM) Code examinations of all Transocean vessels that are subject to the ISM Code and engaging in oil and gas drilling activities on the U.S. OCS. (Conclusions 5.A, 5.B)
- L. It is recommended that Commandant work with the Republic of the Marshall Islands to require an immediate annual verification of the safety management system of Transocean offices (Main and North America). As DNV’s performance as the recognized organization for the RMI has been questionable, and to avoid conflict of interest, another approved recognized organizations should perform the verification. (Conclusions 5.A, 5.B)

## Chapter 8 | ADMINISTRATIVE RECOMMENDATIONS

---

1. The crew of *DAMON B. BANKSTON* should receive a Public Service Award for their outstanding actions during the response to the *DEEPWATER HORIZON* casualty with special emphasis on their heroic efforts in the recovery and compassionate treatment of the 115 surviving crew members of *DEEPWATER HORIZON*.
2. Captain [REDACTED] of *DAMON B. BANKSTON* is recommended for special personal recognition for his heroic actions in responding to *DEEPWATER HORIZON* casualty. Captain [REDACTED] actions were instrumental not only in the safe recovery of the 115 crew members from *DEEPWATER HORIZON*, but also in providing extraordinary leadership and guidance during the continuing Search and Rescue and fire-fighting efforts despite personal risk to himself and his crew.
3. Engineer Anthony [REDACTED] and Able Bodied Seaman [REDACTED] of *DAMON B. BANKSTON* are recommended for special personal recognition for their heroic actions in piloting *DAMON B. BANKSTON*'s Fast Recovery Craft and heroically recovering five *DEEPWATER HORIZON* crew members from the water and towing *DEEPWATER HORIZON*'s liferaft loaded with an additional seven crew members safely away from the burning vessel despite personal risk to themselves.
4. The crew of the recreational vessel *RAMBLIN' WRECK*, [REDACTED] [REDACTED] and [REDACTED] should receive a Public Service Award for their outstanding efforts in providing tenacious search and rescue efforts following the casualty.
5. Chief Engineer [REDACTED] of *DEEPWATER HORIZON* is recommended for special recognition for his selfless and heroic actions following the casualty. He was instrumental in the efforts to attempt to start the standby generator in order to regain power to operate the fire pumps to fight the fire. When those efforts failed, he immediately went to the Lifeboat/liferaft Embarkation Station and assisted with loading injured personnel into the liferaft, and when the liferaft hit the water, he jumped out and assisted again by helping swim it away from the burning vessel.
6. Chief Electrician [REDACTED] of *DEEPWATER HORIZON* is recommended for special recognition for his selfless and heroic actions following the casualty. Immediately following the explosion, he made his way from near the Pump Room through the accommodations spaces assisting injured and trapped crew members as he went. Later, after making it to the Central Control Room/Bridge and subsequently to the Lifeboat Embarkation Station, he was instrumental in helping evacuate injured personnel ([REDACTED] and [REDACTED]) safely from the MODU.
7. Chief Electronics Technician [REDACTED] of *DEEPWATER HORIZON* is recommended for special recognition for his selfless and heroic actions following the casualty. Immediately following the explosion, he helped injured personnel in the Engine Control Room escape to the Lifeboat Embarkation Station. He was instrumental in assisting

the efforts to start the standby generator in order to regain power to operate the fire pumps. When those efforts failed, he immediately went to the Lifeboat/Liferaft Embarkation Station and was critical in releasing the davit and getting the liferaft successfully launched before jumping from the flight deck into the water.

8. It is recommended that Marine Safety Unit Morgan City coordinate with the Republic of the Marshall Islands (RMI) to consider, based on this report, whether and to what extent action should be taken against Captain [REDACTED] mariner license.
9. It is recommended that Commandant (CG-543) evaluate the impact of this casualty on the RMI' status as a Qualship21<sup>438</sup> participant

---

<sup>438</sup> Coast Guard efforts to eliminate substandard shipping have focused on improving methods to identify poor-quality vessels (targeting schemes). However, regardless of the score that a vessel receives in our targeting matrix, all foreign-flagged vessels are examined no less than once each year. This provides few incentives for the well run, quality ship. Hundreds, perhaps thousands, of vessels are operated responsibly, and are typically found with few or no deficiencies. Under our current policies, vessels operating at a higher-quality share nearly the same boarding intervals as those vessels operating at lower-quality standards. These high-quality vessels should be recognized and rewarded for their commitment to safety and quality. Therefore, on January 1, 2001, the Coast Guard implemented an initiative to identify high-quality ships, and provide incentives to encourage quality operations. This initiative is called QUALSHIP 21, quality shipping for the 21st century.

## Appendix A | LIST OF ABBREVIATIONS

---

ABS	American Bureau of Shipping
ACP	Area Contingency Plan
AIRSTA	Coast Guard Air Station
ATC	Coast Guard Aircraft Training Center Mobile, AL
BBL	Barrel
BOEMRE	Bureau of Ocean Energy Management, Regulations & Enforcement (2010)
BOP	Blowout Preventer
BP	British Petroleum (Company formally changed name to BP in 2001)
CCR	Central Control Room
CFR	Code of Federal Regulations
CO <sub>2</sub>	Carbon Dioxide
COC	Certificate of Compliance
COI	Certificate of Inspection
COTP	Captain of the Port
DER	Drilling Equipment Room
DESPERMES	Diesel Engine Speed Measuring System
DGPS	Differential Global Positioning System
DHS	Department of Homeland Security
DNV	Det Norske Veritas
DOC	Document of Compliance
DOI	Department of the Interior
DP	Dynamic Positioning
DPO	Dynamic Positioning Officer
DPS	Dynamic Positioning System
DWS	Drillers Work Station
ECR	Engine Control Room
EDS	Emergency Disconnect System
ESD	Emergency Shutdown
FOSC	Federal On Scene Coordinator
FRC	Fast Recovery Craft
GA	General Announcement

## Appendix A | LIST OF ABBREVIATIONS

---

GMDSS	Global Maritime Distress and Safety System
GOM	Gulf of Mexico
GPM	Gallon Per Minute
H <sub>2</sub> S	Hydrogen Sulfide
IACS	Integrated Automatic and Control System
IMO	International Maritime Organization
ISM	International Safety Management
JIT	Joint Investigation Team
LSA	Lifesaving Appliances Code
MGS	Mud Gas Separator
MISLE	Coast Guard, Marine Information System for Law Enforcement
MMD	Merchant Mariner Document
MMS	Mineral Management Service (now BOEMRE)
MODU	Mobile Offshore Drilling Unit
MSM	Marine Safety Manual
MSMC	Minimum Safe Manning Certificate
MSU	Coast Guard Marine Safety Unit
NPREP	National Preparedness for Response Exercise Program
OCMI	Officer in Charge, Marine Inspection
OCS	Outer Continental Shelf
OIM	Offshore Installation Manager
OSC	On Scene Coordinator
PA	Public Address
PIC	Person in Charge
PII	Party in Interest
POB	Persons-on-Board
PR	Procedural Requirement
RMI	The Republic of the Marshall Islands
RO	Recognized Organization
ROV	Remotely Operated Vehicle
SAR	Search and Rescue

## **Appendix A | LIST OF ABBREVIATIONS**

---

SDPO	Senior Dynamic Positioning Officer
SMC	Safety Management Certificate
SMS	Safety Management System
SOLAS	International Convention for the Safety of Life at Sea
STA	Coast Guard Station
STCW	Standards of Training, Certification & Watch Keeping
UPS	Uninterruptible Power Supply
USC	United States Code
USCG	United States Coast Guard
UWILD	Underwater Inspection in Lieu of Dry-Dock
VRP	Vessel Response Plan

**Figures**

Figure 1	Investigation Roadmap – <i>DEEPWATER HORIZON</i> Casualty
Figure 2	Drill Floor Plan
Figure 3	Main Deck
Figure 4	Second Deck
Figure 5	Third Deck
Figure 6	Means of Escape Forward
Figure 7	Lifeboat # 2 Manufacturer Data Label
Figure 8	Typical Stretcher Loading
Figure 9	Stretcher on the Seat
Figure 10	Stretcher on the Deck
Figure 11	Typical Liferaft – Deployed
Figure 12	<i>DAMON B. BANKSTON</i>
Figure 13	<i>DEEPWATER HORIZON</i> on the Ocean Floor
Figure 14	Vessels Directing Water Towards the Fire
Figure 15	Water From Responding Vessels Spilling Off the Deck of <i>DEEPWATER HORIZON</i>
Figure 16	<i>DEEPWATER HORIZON</i> Debris Layout
Figure 17	The “Maritime Safety Net” Layers & Potential System Failures
Figure 18	The International Safety Management Code

**Tables**

Table 1	Locations of Missing and Injured Crew Members
Table 2	Status of Uninterruptible Power Supply
Table 3	<i>DEEPWATER HORIZON</i> Station Bill: “Abandon Unit Stations”
Table 4	Fast Rescue Craft (FRC) Requirements



## Appendix C | PARTIES IN INTEREST

Per Title 46 Code of Federal Regulations 4.03-1, a “party in interest” shall mean “any person whom the Marine Board of Investigation or the investigating officer shall find to have a direct interest in the investigation conducted by it and shall include an owner, a charterer, or the agent of such owner or charterer of the vessel or vessels involved in the marine casualty or accident, and all licensed or certificated personnel whose conduct, whether or not involved in a marine casualty or accident is under investigation by the Board or investigating officer.”

Parties in Interest	Role	Counsel
BP	Operator	Fowler, Rodriguez, Valdez-Fauli; Mr. [REDACTED] Esq.
Transocean	Owner	Preis & Roy; Mr. [REDACTED] Esq.
Cameron	BOP Manufacturer	Beck, Redden & Secrest; Mr. [REDACTED] Esq.
Haliburton	Cementing Contractor	Mr. [REDACTED] Esq.
M-I Swaco	Mud Engineer	Mr. [REDACTED], Esq. and Mr. [REDACTED], Esq.
DrilQuip	Riser Manufacturer	Mr. [REDACTED], Esq.
Weatherford	Casing Manufacturer	Mr. [REDACTED], Esq.
Anadarko	Co-Lessee	Mr. [REDACTED], Esq.
MOEX USA	Co-Lessee	Mr. [REDACTED], Esq.
[REDACTED]	Chief Mechanic	Elias & Seely; Mr. [REDACTED]
[REDACTED]	Master	Schonekas, Evans, McGoe & McEachin; Mr. [REDACTED] Esq.
[REDACTED]	Offshore Installation Manager	Mr. [REDACTED], Esq.
[REDACTED]	Chief Engineer	Mr. [REDACTED] Esq.
[REDACTED]	Chief Mechanic	Mr. [REDACTED], Esq.
[REDACTED]	VP Drilling & Completions	Mr. [REDACTED], Esq.
[REDACTED]	Well Site Leader	Mr. [REDACTED] Esq.
The Republic of the Marshall Islands	Flag State	Mr. [REDACTED], Esq.

### A. Lessee Operator

BP was the principal lease holder of *DEEPWATER HORIZON* at the time of the incident. The lease between BP and Transocean was entered into in March of 2008 and ran to September 2013. BP was also the principal developer of the Macondo Prospect, holding ownership of a 65% share. The remainder of the ownership of the project belonged to Anadarko Petroleum Corporation which held a 25% share, and MOEX Offshore 2007, which held the remaining 10%

share. MOEX Offshore 2007 is a unit of Mitsui Corporation. BP acquired the mineral rights of the Macondo Project at the Minerals Management Service lease sale in March 2008.

### B. Vessel Owner/Operator

The Owner and Operator of *DEEPWATER HORIZON* at the time of the incident was Transocean. The unit was originally commissioned by R&B Falcon, which later became part of Transocean. *DEEPWATER HORIZON* was built by Hyundai Heavy Industries in Ulsan, South Korea and delivered on February 23, 2001.

### C. Contractors

Numerous contractors had employees aboard *DEEPWATER HORIZON* at the time of the incident engaged in support of the drilling operations along with the assigned support staff. In addition, *DEEPWATER HORIZON* had four visitors on board the time of the incident: two were BP representatives and two were Transocean representatives who were present for a Management Visibility Visit. Contractors with employees on board *DEEPWATER HORIZON* at the time of the casualty include:

- Art Catering: Housekeeping and Food Staff – (14 persons)
- Dril-Quip: Drilling Operations Support – (1 person)
- EPS: Administrative Support – (1 person)
- Halliburton: Drilling Operations Support – Cement – (2 persons)
- Hamilton Engineering: Drilling Operations Advisor – (1 person)
- MI Swaco: Drilling Operations Support – Mud Engineering - (7 persons)
- Oceaneering; Drilling Operations Support – ROV Technicians – (3 persons)
- OCS: Drilling Operations Support – Tank Cleaning – (8 persons)
- Sperry-Sun: Drilling Support Operations – Mud Loggers – (2 persons)
- Weatherford: Drilling Operations Support – (2 persons)

A. Manning

As the Owner and Operator of *DEEPWATER HORIZON*, Transocean is required to provide a crew complement as required by The Republic of the Marshall Islands manning standards (see the below tables). All Maritime Crew members held the necessary licenses/documents for their assigned positions and in keeping with the Minimum Safe Manning Certificate (MSMC).

2.2.5 Reductions from Basic Manning - MOU			
	Application	On Location/ Field Move	Underway
Schedule A	Self Propelled Mobile Offshore Drilling Unit	Offshore Installation Manager Barge Supervisor Two (2) Ballast Control Operators Two (2) Able Seamen MODU One (1) Ordinary Seaman MODU  Maintenance Supervisor Assistant Maintenance Supervisor Second Assistant Engineer Two (2) Oiler/Motormen MODU	Master Chief Mate Second Mate Third Mate Three (3) Able Seamen Two (2) Ordinary Seamen  Chief Engineer 1 <sup>st</sup> Assistant Engineer 2 <sup>nd</sup> Assistant Engineer 3 <sup>rd</sup> Assistant Engineer Three (3) Oiler/Motormen
	For voyages of less than 72 hours but more than 16 hours		Master Two (2) Third Mates Three (3) Able Seamen Two (2) Ordinary Seamen  Maintenance Supervisor Two (2) Asst. Maint. Sups Two (2) Oiler/Motormen
	For voyages 16 hours or less, but more than 8 hours		Master Two (2) Third Mates Three (3) Able Seamen Two (2) Ordinary Seamen  Maintenance Supervisor Asst. Maint. Sup. Two (2) Oiler/Motormen
	For voyages of 8 hours or less		Master Two (2) Third Mates Two (2) Able Seamen Ordinary Seamen  Maintenance Supervisor Asst. Maint. Sup. Oiler/Motormen

Rev. 12/09 6 of 30 7-038-2

The Republic of the Marshall Islands

Appendix D | CREW DATA

	Application	On Location/ Field Move	Underway
Schedule DPV	Dynamically Positioned (DP) Unit and Drilling Ships	Master Offshore Installation Manager Chief Mate Third Mate Two (2) Able Seamen MODU One (1) Ordinary Seaman MODU  Chief Engineer Maintenance Supervisor First Assistant Engineer Second Assistant Engineer Third Assistant Engineer Two (2) Oiler/Motormen MODU	Master Chief Mate Second Mate Third Mate Three (3) Able Seamen Two (2) Ordinary Seamen  Chief Engineer 1 <sup>st</sup> Assistant Engineer 2 <sup>nd</sup> Assistant Engineer 3 <sup>rd</sup> Assistant Engineer Three (3) Oiler/Motormen
	For voyages of less than 72 hours but more than 16 hours		Master Chief Mate Second Mate Third Mate Three (3) Able Seamen Two (2) Ordinary Seamen  Chief Engineer 1 <sup>st</sup> Assistant Engineer 2 <sup>nd</sup> Assistant Engineer 3 <sup>rd</sup> Assistant Engineer Two (2) Oiler/Motormen
	For voyages 16 hours or less, but more than 8 hours		Master Chief Mate Second Mate Third Mate Three (3) Able Seamen Two (2) Ordinary Seamen  Chief Engineer 1 <sup>st</sup> Assistant Engineer 2 <sup>nd</sup> Assistant Engineer 3 <sup>rd</sup> Assistant Engineer Two (2) Oiler/Motormen
	For voyages of 8 hours or less		Master Chief Mate Second Mate Third Mate Two (2) Able Seamen One (1) Ordinary Seamen  Chief Engineer 1 <sup>st</sup> Assistant Engineer 2 <sup>nd</sup> Assistant Engineer 3 <sup>rd</sup> Assistant Engineer One (1) Oiler/Motormen

**1. Master**

The Master held the following licenses and endorsements at the time of the incident:

License / Endorsement	Issue Date	Expiration Date
Master	04/05/2007	01/09/2012
Barge Supervisor	04/05/2007	01/09/2012
Offshore Installation Manager (OIM)	12/12/2008	01/19/2012

**2. Chief Mate**

The Chief Mate (C/M) held the following licenses and endorsements at the time of the incident:

License / Endorsement	Issue Date	Expiration Date
Chief Mate	02/01/2010	09/18/2014
Ballast Control Operator	02/01/2010	09/18/2014

**3. Chief Engineer**

The Chief Engineer (C/E) held the following licenses and endorsements at the time of the incident:

License / Endorsement	Issue Date	Expiration Date
Chief Engineer	03/12/2009	12/19/2013

**4. First Assistant Engineer**

The First Assistant Engineer held the following licenses and endorsements at the time of the incident:

License / Endorsement	Issue Date	Expiration Date
First Assistant Engineer	06/17/2009	08/29/2012

**5. Third Assistant Engineer:**

The Third Assistant Engineer held the following licenses and endorsements at the time of the incident:

License / Endorsement	Issue Date	Expiration Date
Third Assistant Engineer Engineering Officer - MMD	06/30/2009	05/02/2014

**6. Deck Watch Officer; Senior Dynamic Positioning Officer**

The on-watch Senior Dynamic Positioning Officer held the following licenses and endorsements at the time of the incident:

License / Endorsement	Issue Date	Expiration Date
Barge Supervisor - MMD	03/30/2010	03/04/2015

**Appendix D | CREW DATA**

**7. Deck Watch Officer; Dynamic Positioning Officer**

The on-watch Dynamic Positioning Officer held the following licenses and endorsements at the time of the incident:

License / Endorsement	Issue Date	Expiration Date
Third Mate	04/08/2010	04/26/2013
Ballast Control Operator - MMD	04/08/2010	04/26/2013

**8. Offshore Installation Manager**

The Offshore Installation Manager onboard held the following license and endorsements at the time of the incident:

License / Endorsement / STCW Certification	Issue Date	Expiration Date
Offshore Installation Manager –Mobile Offshore Drilling Unit, Without Restriction	07/18/2006	04/11/2011
Barge Supervisor	07/18/2006	04/11/2011

**MARINE CREW**

Survivors	Employer	Position	MMC #
██████	Transocean	Chief Engineer	██████
██████	Transocean	Able Bodied Seaman	██████
██████	Transocean	Able Bodied Seaman	██████
██████	Transocean	Dynamic Positioning Officer II 3 <sup>rd</sup> Mate	██████
██████ Jimmy	Transocean	Offshore Installation Manager	██████
██████	Transocean	Senior Dynamic Positioning Officer	██████
██████	Transocean	Master/OIM/Ballast Control	██████
██████	Transocean	1 <sup>st</sup> Assistant Engineer	██████
██████	Transocean	Senior Dynamic Positioning Officer	██████
██████	Transocean	3 <sup>rd</sup> Assistant Engineer	██████
██████	Transocean	Boatswain	██████
██████	Transocean	Dynamic Positioning Officer II 3 <sup>rd</sup> Mate	██████
██████	Transocean	Chief Mate/Ballast Control	██████

**OPERATIONS & SUPPORT**

Survivors	Employer	Position	Role
[REDACTED]	Art Catering	Baker	Support
[REDACTED]	Art Catering	BR	Support
[REDACTED]	Art Catering	Utility Hand	Support
[REDACTED]	Art Catering	Steward	Support
[REDACTED]	Art Catering	Baker	Support
[REDACTED]	Art Catering	Galley Hand	Support
[REDACTED]	Art Catering	Cook	Support
[REDACTED]	Art Catering	Galley Hand	Support
[REDACTED]	Art Catering	BR	Support
[REDACTED]	Art Catering	Laundry	Support
[REDACTED]	Art Catering	BR	Support
[REDACTED]	Art Catering	Laundry	Support
[REDACTED]	Art Catering	Galley Hand	Support
[REDACTED]	Art Catering	Steward	Support
[REDACTED]	BP	Subsea Engineer	Drilling Ops
[REDACTED]	BP	Well Site Leader	Drilling Ops
[REDACTED]	BP	Well Site Trainee	Drilling Ops
[REDACTED]	BP	Well Supervisor	Drilling Ops
[REDACTED]	BP	Field Engineer	Drilling Ops
[REDACTED]	BP	Well Site Leader	Drilling Ops
[REDACTED]	Dril-Quip	Service Technician	Drilling Ops
[REDACTED]	EPS	Dispatcher/Clerk	Administrative
[REDACTED]	Haliburton	Cementer	Drilling Ops
[REDACTED]	Haliburton	Cementer	Drilling Ops
[REDACTED]	Hamilton Engineering	Coordinator	Advisor
[REDACTED]	MI Swaco	Mud Engineer	Drilling Ops

**Appendix D | CREW DATA**

██████████	MI Swaco	Mud Engineer	Drilling Ops
██████████	MI Swaco	Mud Engineer	Drilling Ops
██████████	Oceaneering	ROV Technician	Support
██████████	Oceaneering	ROV Technician	Support
██████████	Oceaneering	ROV Technician	Support
██████████	OCS	Technician	Support
██████████	OCS	Tank Cleaner	Support
██████████	OCS	Tank Cleaner	Support
██████████	OCS	Tank Cleaner	Support
██████████	OCS	Tank Cleaner	Support
██████████	OCS	Supervisor	Support
██████████	OCS	Tank Cleaner	Support
██████████	OCS	Service Technician	Support
██████████	Sperry-Sun	Mud Logger	Support
██████████	Sperry-Sun	Mud Logger	Support
██████████	Transocean	Roustabout	Drilling Ops
██████████	Transocean	Floor Hand	Drilling Ops
██████████	Transocean	Crane Operator	Drilling Ops
██████████	Transocean	Chief Mechanic	Drilling Ops
██████████	Transocean	Driller	Drilling Ops
██████████	Transocean	Electrical/Electronics Supervisor	Drilling Ops
██████████	Transocean	Roustabout	Drilling Ops
██████████	Transocean	Chief Mechanic	Drilling Ops
██████████	Transocean	Roustabout	Drilling Ops
██████████	Transocean	Roustabout	Drilling Ops
██████████	Transocean	Chief Electrician	Drilling Ops
██████████	Transocean	Roustabout	Drilling Ops
██████████	Transocean	Welder	Support
██████████	Transocean	Subsea Trainee	Drilling Ops



**Appendix D | CREW DATA**

██████████	Transocean	Materials Coordinator	Support
██████████	Transocean	Senior Toolpusher	Drilling Ops
██████████	Transocean	Medical Technician	Support
██████████	Transocean	Mechanic	Drilling Ops
██████████	Transocean	Floorhand	Drilling Ops
██████████	Transocean	Rig Safety & Training Coordinator	Support
██████████	Transocean	Senior Subsea Supervisor	Drilling Ops
██████████	Transocean	Floor Hand	Drilling Ops
██████████	Transocean	Floor Hand	Drilling Ops
██████████	Transocean	Senior Materials Coordinator	Support
██████████	Transocean	Mechanical Supervisor	Drilling Ops
██████████	Transocean	Roustabout	Drilling Ops
██████████	Transocean	Chief Mechanic	Drilling Ops
██████████	Transocean	Roustabout	Drilling Ops
██████████	Transocean	Deck Pusher	Drilling Ops
██████████	Transocean	Roustabout	Drilling Ops
██████████	Transocean	Floor Hand	Drilling Ops
██████████	Transocean	Deck Pusher	Drilling Ops
██████████	Transocean	Motorman	Drilling Ops
██████████	Transocean	Roustabout	Drilling Ops
██████████	Transocean	Assistant Driller	Drilling Ops
██████████	Transocean	Crane Operator	Drilling Ops
██████████	Transocean	Chief Electrician	Drilling Ops
██████████	Transocean	Floor Hand	Drilling Ops
██████████	Transocean	Derrick Hand	Drilling Ops
██████████	Transocean	Roustabout	Drilling Ops
██████████	Transocean	Floor Hand	Drilling Ops
██████████	Transocean	Subsea Supervisor	Drilling Ops
██████████	Transocean	Roustabout	Drilling Ops

**Appendix D | CREW DATA**

████████	Transocean	Pump Hand	Drilling Ops
████████	Transocean	Electronic Technician	Drilling Ops
████████	Transocean	Crane Operator	Drilling Ops
████████	Transocean	Motorman	Drilling Ops
████████	Transocean	Assistant Driller	Drilling Ops
████████	Transocean	Roustabout	Drilling Ops
████████	Transocean	Motorman	Drilling Ops
████████	Transocean	Radio Operator	Support
████████	Transocean	Chief Electronic Technician	Drilling Ops
████████	Transocean	Roustabout	Drilling Ops
████████	Transocean	Toolpusher	Drilling Ops
████████	Transocean	Chief Electronic Technician	Drilling Ops
████████	Weatherford	Technician	Drilling Ops
████████	Weatherford	Rig System Specialist	Drilling Ops

	<b>MODU</b>	<b>Visitors</b>	
████████	BP	VP for Drilling & Completions	Familiarization
████████	BP	Drilling & Completions Manager	Familiarization
████████	Transocean	Division Manager – Assets	Familiarization
████████	Transocean	Division Manager – Performance	Familiarization

**A. General**

*DEEPWATER HORIZON* was an Ultra-Deepwater, Dynamically Positioned (DP), Semi-Submersible Mobile Offshore Drilling Unit (MODU). Construction started in December 1998, the keel was laid on March 21, 2000, and *DEEPWATER HORIZON* was delivered on February 23, 2001. *DEEPWATER HORIZON* was built in Ulsan, South Korea by Hyundai Heavy Industries, was commissioned by R&B Falcon and was registered in Majuro, Marshall Islands.<sup>447</sup> The vessel was a fifth-generation MODU and was designed to drill subsea wells for oil exploration and production using an 476mm (18.75 in), 100,000kPa (15,000 psi) Blowout Preventer (BOP), and a 530mm (21 in) outside diameter marine riser. *DEEPWATER HORIZON* was capable of operating in waters up to 2427 m (8,000 ft) deep, to a maximum drill depth of 9,100 m (30,000 ft). In 2002, the vessel was upgraded with “e-drill,” a drill monitoring system whereby technical personnel based in Houston, Texas, received real-time data from the vessel and transmitted maintenance and troubleshooting information.



*DEEPWATER HORIZON*

At the time of its loss, *DEEPWATER HORIZON* was leased to BP plc through 2013. Under the contract to BP, the daily operating cost was \$496,800 for the bareboat MODU, with crew, gear and support vessels estimated to cost an equivalent amount per day. Thus, the estimated daily operating costs of *DEEPWATER HORIZON* were approximately \$1M. In September 2009, the MODU drilled deepest oil well in history at a vertical depth of 35,050 feet (10,683m) and measured depth of 10,685m (35,055 ft) in the Tiber Field at Keathley Canyon, Block 102, approximately 250 miles southeast of Houston, Texas in 400 m (4,132 ft) of water. In February 2010, *DEEPWATER HORIZON* commenced drilling an exploratory well at the Macondo Prospect (Mississippi Canyon Block 252), approximately 41 nautical miles off the Southeast coast of Louisiana, at a water depth of approximately 5,000 feet. At the time of its loss,

---

<sup>447</sup> R&B Falcon later merged with Transocean shortly after construction of *DEEPWATER HORIZON* was begun.

## Appendix E | VESSEL PARTICULARS

*DEEPWATER HORIZON* was insured for \$560M, designed to cover its replacement cost and wreckage removal.

<i>DEEPWATER HORIZON</i>	
IMO Number	8764597
Call Sign	V7HC9
Service	Mobile Offshore Drilling Unit (MODU)
Keel Laid Date	March 20, 2000
Delivery Date	February 23, 2001
Hull Material	Steel
Built By	Hyundai Heavy Industries
Gross Tonnage	32,588 GRT
Net Tonnage	9,776 NRT
Length Overall	396 Feet (114 Meters)
Breadth	256 Feet (78 Meters)
Depth	136 Feet (41.5 Meters)
Propulsion	Diesel-Electric
Horsepower	53,640
Estimated Market Value	\$ 560,000,000
Estimated Replacement Cost	\$ 560,000,000
Hailing Port	Majuro, Marshall Islands
Inclining Test Conducted & Location (ABS)	January 25, 2001
Date of Recent Stability Report (ABS)	February 7, 2001
Classification Document (ABS)	Expiry Date: February 28, 2011
International Load Line Certificate (ABS)	Expiry Date: February 28, 2011
International Safety Management Certificate (DNV)	Expiry Date: May 16, 2012
Certificate of Compliance (USCG)	Expiry Date: July 29, 2011
Port Issued	Marine Safety Unit (MSU) Port Arthur
USCG Inspection Office	Marine Safety Unit (MSU) Port Arthur
Date Issued	July 29, 2009
Owner	Triton Asset Leasing GmbH
Operator	Transocean Holdings LLC

# Appendix E | VESSEL PARTICULARS

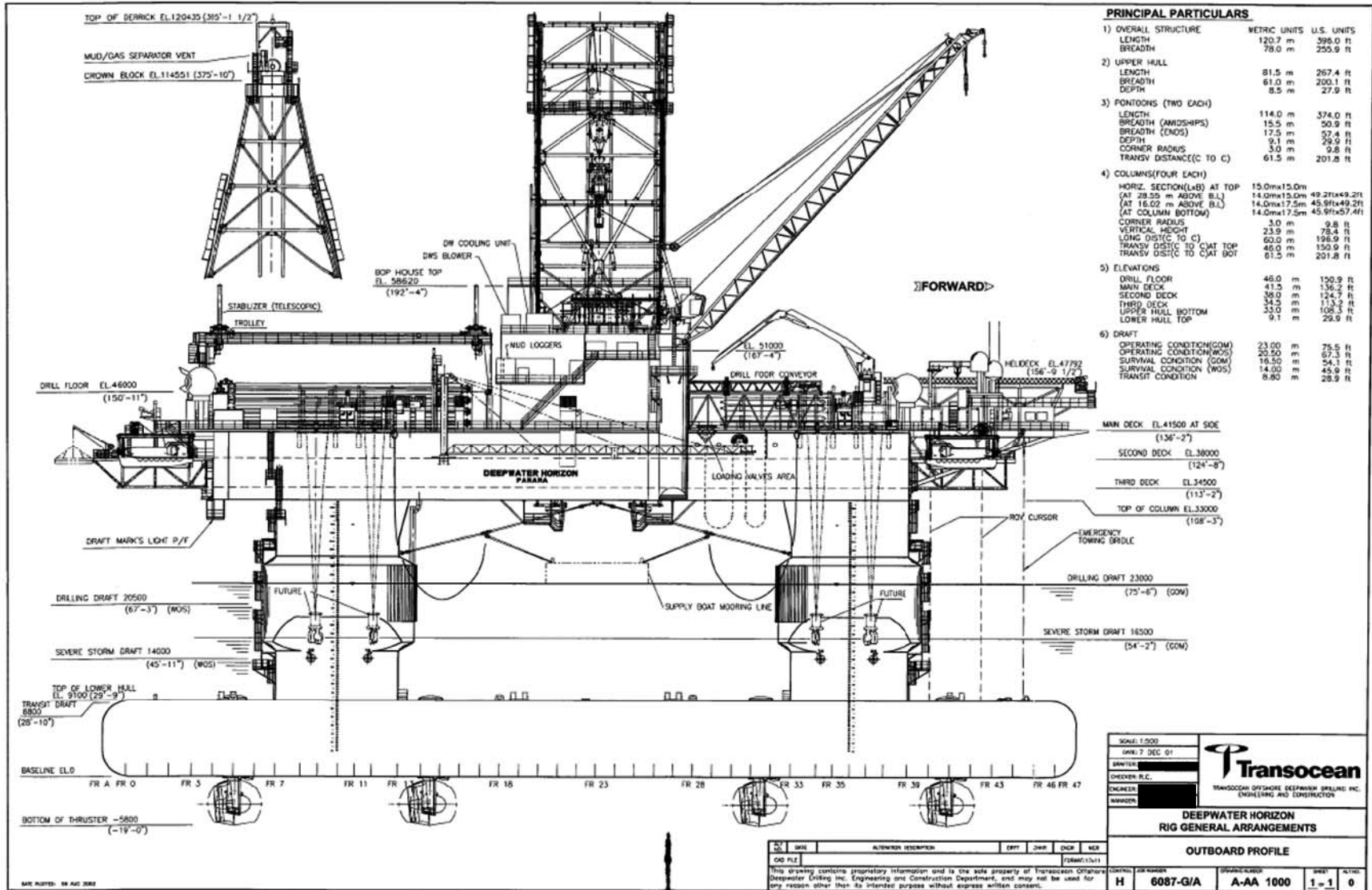

General Arrangements – Outboard Profile

# Appendix E | VESSEL PARTICULARS

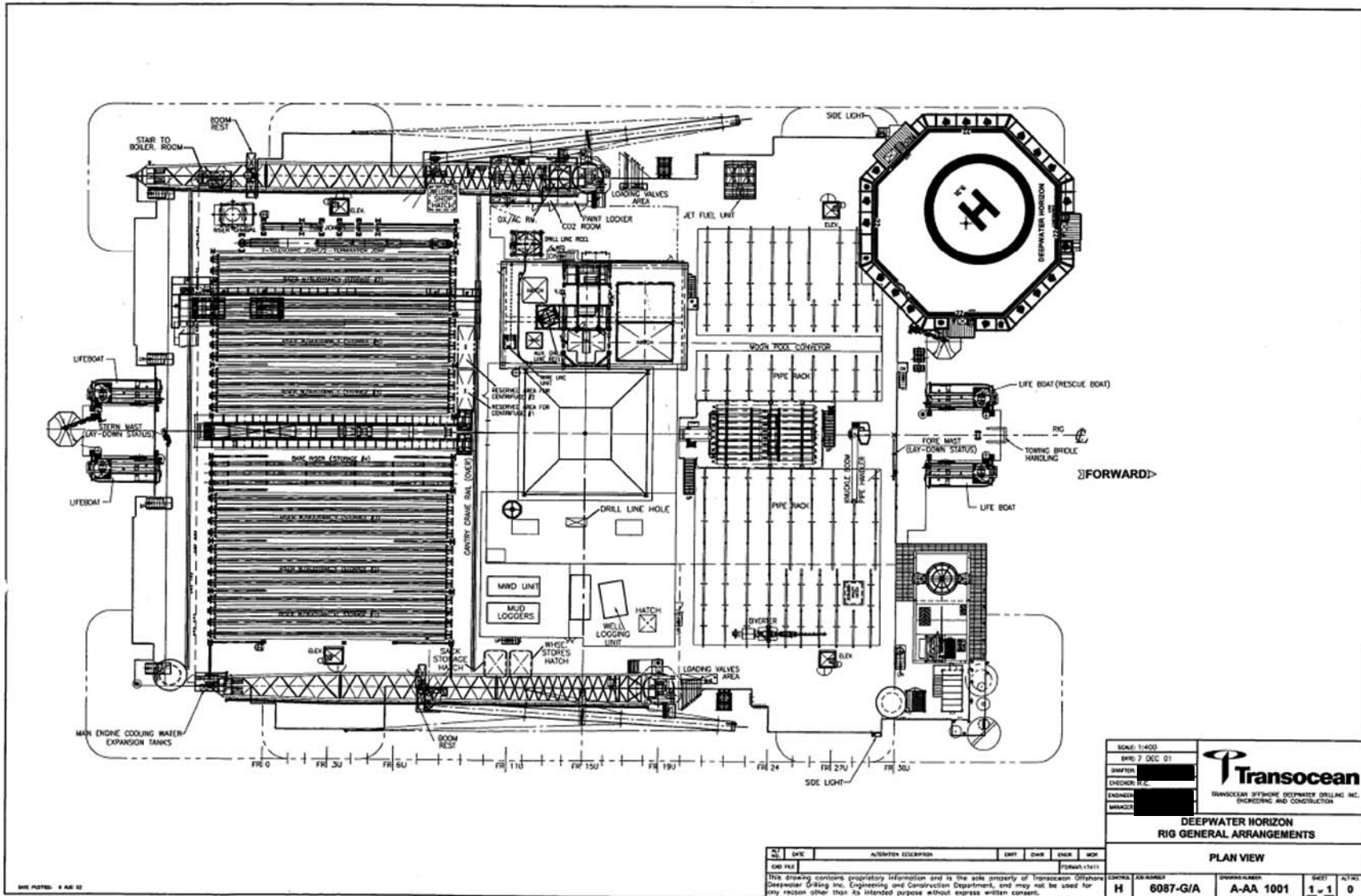

General Arrangements – Plan View

**B. Main Deck** (See Figure 3)

**1. Central Control Room/Bridge (CCR)**

The Central Control Room/Bridge (CCR) was located port side forward on the Main Deck. Navigation Equipment in the CCR included radars, radar repeaters, Electronic Chart Display and Information System (ECDIS), thruster control system, magnetic compass binnacle, a Doppler weather radar screen and a Global Maritime Distress Safety System (GMDSS). In addition to navigation equipment, a Dynamic Positioning (DP) Console was located aft of the Navigation Console. The DP equipment included radar, a radar repeater, Differential Global Position System (DGPS) monitor, Dynamic Positioning (DP) computer system and a Doppler weather radar screen. Other critical consoles in the CCR included a fuel and gas system, Emergency Shutdown System (ESD) panel, power and vessel management system panels, and a load and stability computer system. The critical components regarding the drilling operation included a drilling deck console, driller's intercom, the drilling equipment desk, Emergency Disconnect System (EDS), and the Blowout Preventer (BOP) control panel. Communications gear included a telephone and a Public Announcement (PA) speaker system. Also, a fire and General Alarm (GA) buttons and an indicator panel for general and bilge alarms were located in the CCR.

Fire protection of the CCR included A-60 Boundaries on all walls, windows, ceiling, and floor. Emergency lighting was part of the CCR construct as well. Fire-fighting equipment included CO<sub>2</sub> extinguishers which were part of the fixed CO<sub>2</sub> fire extinguishing system. The emergency escape route from the CCR was through the starboard aft stairwell down to the Second Deck exit. The door at the bottom of the stairs exited to the Transit Room, which has a water-tight door. Once outside the water-tight door, crew members would proceed to the Lifeboat Deck.<sup>448</sup>

*Communications*

All radio equipment, including Very High Frequency (VHF) AM, VHF--FM, Single Side Band (SSB), Global Marine Distress Safety System (GMDSS) and INMARSAT systems had been installed in accordance with all governing bodies, regulatory agencies, and all applicable recommended practices. This included the American Bureau of Shipping (ABS), the International Maritime Organization (IMO), the International Safety of Life at Sea (SOLAS), and Det Norske Veritas (DNV).<sup>449</sup> VHF-FM transceivers (each with separate power supply) were installed at the following locations:

- Central Control Room (CCR) / Bridge (3)
- Engine Control Room (ECR) (1)
- Installation Manager Office (OIM) (1)
- Driller's Workstation (DWS) (1)
- Cranes (4)
- Lifeboats (4)
- Hand-held with rechargeable batteries (16)

---

<sup>448</sup> See ABS *DEEPWATER HORIZON* Operations Manual, Section 9.3, ABSDWH0000580

<sup>449</sup> See ABS *DEEPWATER HORIZON* Operations Manual, Section 9.3.2, ABSDWH0000580





A differential Global Positioning Systems (DGPS) and a GLONASS positioning system were installed in the CCR, and were connected to the Integrated Automatic Control System (IACS), GMDSS equipment, INMARSAT B & C radio rack, and VHF--FM radios.<sup>450</sup>

### 2. Fixed CO<sub>2</sub> Fire-extinguishing System

In accordance with Section 9.5 of the International Maritime Organization (IMO) Mobile Offshore Drilling Unit (MODU) Code, a fixed fire extinguishing system was provided for protection of the spaces listed below:

- Engine Rooms
- Paint Locker
- Mud Pump Room
- Mud Processing Area
- Standby/Auxiliary/Essential Generator Room
- Switchgear Rooms
- Central Control Room/Bridge
- Snuffing System for Degasser Vent Line
- Engine Control Room
- Main Generators

Systems were fitted with adjustable pneumatic discharge delay timers and CO<sub>2</sub> powered alarms to provide personnel with evacuation warnings prior to discharge. The alarm signal, distinctive, visible, and clearly audible over the normal noise levels, were provided in the respective spaces. Ventilation systems were automatically shut down in any compartment when CO<sub>2</sub> alarms were activated via pressure operated switches.

### 3. Standby/Auxiliary/Essential Generator Room

The Standby/Auxiliary/Essential Generator and Standby Generator Switchboard were located on the port Main Deck in the Standby Generator Shack. The generator was diesel powered.

In the event of loss of power to the 480V main ring bus distribution system, the 480V main switchboard transformer feeder breakers and the feeder to the Standby Switchboard opened. The Standby Generator was designed to be started automatically after a ten minute delay by the Integrated Automatic Control System (IACS).

The various lines feeding the Standby Generator Room included 120V, 208V, and 408V power lines, lube oil, fuel oil, MODU air, and drill and potable water. The control systems located in the space included battery charger, bus tie, distribution panel, generator panel, Blowout Preventer (BOP) UPS, and IACS UPS. Fire protection construction included A-0 Boundaries for the port, forward, and the aft walls, ceiling and floor. Fire protection construction was A-60 for the starboard wall. Fire detection systems in the Generator Room included heat and smoke detectors. The fire-fighting equipment located within the space included CO<sub>2</sub> extinguishers, foam extinguishers, and a feed from the fixed CO<sub>2</sub> system. The main access to the Standby

---

<sup>450</sup> See ABS *DEEPWATER HORIZON* Operations Manual, Section 9.3.3, ABSDWH0000581

Generator Room was the only means of egress and exited to the riser deck where an individual could proceed to either Lifeboat Deck.

### C. **Second Deck** (See Figure 4)

#### 1. **Engine Rooms (#1 - #6)**

See the Machinery and Propulsion, Section G, for particulars.

#### 2. **Galley**

The Galley was located starboard forward side. The power lines being fed into the Galley included a 120V. The various control systems included supply and exhaust fans, dishwasher, hood fans, disposals, and ovens. Fire-fighting equipment located in the space included a fixed H<sub>2</sub>O sprinkler system, portable CO<sub>2</sub> extinguishers, and a fire blanket. In adjacent spaces, a dry powder extinguisher and a water fire hose was available for further fire fighting ability. The emergency escape route was through the port door, then through the mess room and forward through the watertight door and then exit via the Lifeboat Deck.

The Temporary Safe Refuge (TSR) was designated to be on the Second Deck in the Accommodations Mess area adjacent to the Galley. Signs were posted within the area.<sup>451</sup>

#### 3. **Electrical Equipment Room**

The Electrical Equipment Room was located portside forward. The power lines feeding this space included a 480V distribution, a 120V, and 208V, control air, and a sweater line to foam pump. Fire-fighting equipment was located adjacent to the space and included a fire axe, portable CO<sub>2</sub> extinguisher, and fire water hose. A telephone was available for two way communications and the public announcement system could be heard for general announcements. Emergency lighting was also located within the space. The escape route from the space was through the two doors on the aft bulkhead, either of which led to the utility trunk or the transformer room. An individual could then proceed through the dry stores, and the Galley to exit through the mess deck to the Lifeboat Deck.<sup>452</sup>

#### 4. **Mud Pits**

*DEEPWATER HORIZON* was equipped with ten active mud pits plus a slug pit. These were located on the forward side of the Mud Pump Room on the Third Deck. The top of the pits extended through the Second Deck.

All of the pits were equipped with vertical explosion proof electrical agitators and mud gun agitators and the active pits were fitted with level indicators and level alarms. The levels were monitored and recorded inside the Driller's Workstation and the Central Control Room. The maximum storage capacity for drilling mud was 4,434 barrels or 186,228 gallons.

---

<sup>451</sup> See ABS *DEEPWATER HORIZON* Operations Manual, Section 9.6.7, ABSDWH0000598

<sup>452</sup> See ABS *DEEPWATER HORIZON* Operations Manual, Section 8.2.1, ABSDWH0000448

# Appendix E | VESSEL PARTICULARS

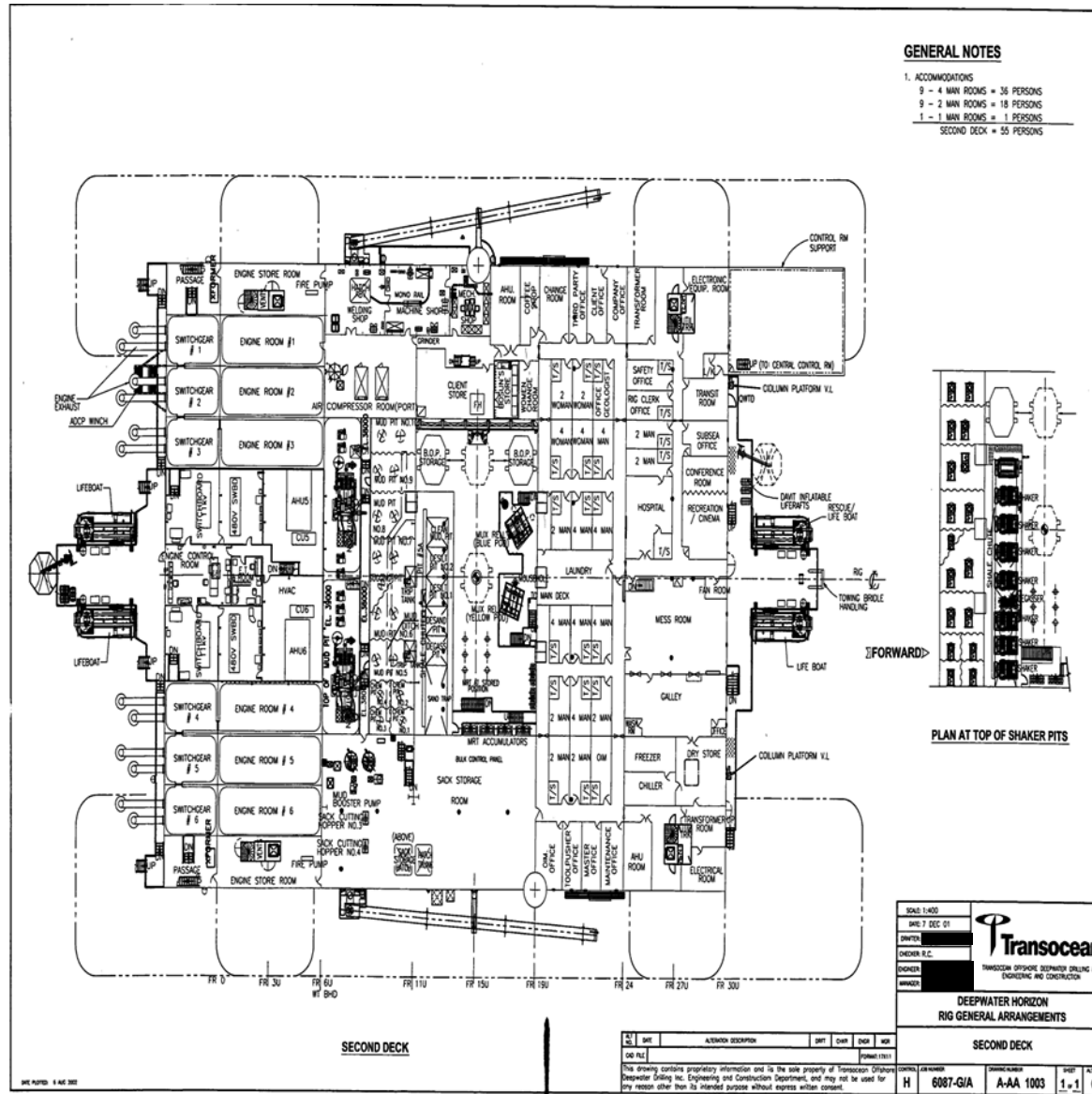

Engine Room Layout

Power lines feeding the mud pits included a 120V power line, drill water line, various chemicals, sea water, fire water, base oil, and low and high pressure mud lines. The fire and gas detection systems in this space included smoke detectors and H<sub>2</sub>S detectors. Fire-fighting equipment included a fixed CO<sub>2</sub> system. Portable dry powder extinguishers, CO<sub>2</sub> extinguishers, foam extinguishers, and fire water hoses were located in an adjacent space. Available communications within the space included a telephone and public announcement system speakers. A Fire Alarm button was available for activation and the General Alarm could be heard within the space. Emergency lighting was also located within the space. For emergency egress, the exit was through the sack room to a stairwell.<sup>453</sup>

### 5. Accommodation Spaces

On the Second Deck, Accommodations were supplied for fifty-five persons. The Second Deck Accommodations area had nine 4-man cabins, nine 2-man cabins, and one 1-man cabin.

#### D. Third Deck (See Figure 5)

##### 1. Accommodation Spaces

On the Third Deck forward, Accommodations were supplied for ninety-one persons. The Third Deck Accommodation area had forty-three 2-man cabins and five 1-man cabins.<sup>454</sup>

##### 2. Fuel Oil Service Tanks

Diesel oil was provided to the eight storage tanks through a deck filling line. Four rotary diesel oil transfer pumps, two located in each aft pump room took suction from the storage tanks and discharged into the settling tanks, day tanks, or to the mud pits. Each pump was rated for 31.8 m<sup>3</sup>/hr (140 GPM) @ 49 m (161 ft) head and driven by a 7.5 KW (10 hp) electric motor. A flow meter was provided to measure the amounts of diesel oil transferred. Each pump was sized to supply fuel oil for three engines at 100% capacity, that is, two pumps running in parallel to supply 100% of the engines' required fuel supply to meet the ABS DPS3 requirement. When required, provisions existed to allow the pumps to transfer the diesel oil between storage tanks. All of the storage tanks were equipped with instrumentation for transmitting level values to the Integrated Automatic Control System (IACS). The system pumps and valves could be monitored and controlled locally or through the IACS. One settling tank and one service tank were located on each side of *DEEPWATER HORIZON* on the Third Deck. On each side of the Third Deck, double fuel oil purifiers were provided. Both settling and day tanks were equipped with instrumentation for transmitting level values to the IACS, and the settling tanks were equipped with high and low level alarms arranged to appear in the IACS. Diesel oil service pumps located on the port and starboard sides of the Third Deck took suction from the fuel oil service tank and distributed the diesel oil to the Standby (Emergency) Generator fuel tank, the well logging unit, the cementing unit and the two deck cranes. The pump was rated for 3.4 m<sup>3</sup>/hr (15 GPM) @ 30.5 m (100 ft) and driven by a 2.24 KW (3 HP) electric motor.<sup>455</sup>

---

<sup>453</sup> See ABS *DEEPWATER HORIZON* Operations Manual, Section 3.4, ABSDWH0000120

<sup>454</sup> See ABS *DEEPWATER HORIZON* Operations Manual, Section 1.10.6, ABSDWH000059

<sup>455</sup> See ABS *DEEPWATER HORIZON* Operations Manual, Section 7.1.7, ABSDWH0000312

### E. Drill Floor

The Drill Floor consisted of the draw works, rotary table, dead-line anchor, mouse holes, casing stabbing basket, iron roughneck, pipe racking system, and catheads.

The draw works was a machine on *DEEPWATER HORIZON* that consisted of a large-diameter steel spool, brakes, a power source and assorted auxiliary devices. The primary function of the draw works was to reel out and reel in the drilling line, a large diameter wire rope, in a controlled fashion. The drilling line was reeled over the crown block and traveling block to gain mechanical advantage in a "block and tackle" or "pulley" fashion. This reeling out and in of the drilling line caused the traveling block, and anything that may be hanging underneath it, to be lowered into or raised out of the wellbore. The reeling out of the drilling line was powered by gravity and reeling in by an electric motor or diesel engine. The draw works on board *DEEPWATER HORIZON* were Active Heave Compensating Draw Works (AHD), supplied by HITEC, and was designed for 1,000 short tons with 14 lines continuous duty and was driven by six 1,300 hp AC motors. *DEEPWATER HORIZON* heave motion, as observed by the motion reference units was instantaneously received by the AHD control system along with the true position feedback from the block position sensors. Processing of the collected data resulted in an active heave compensation of the draw works by controlling the motor speed reference. This action allowed for automatic control of the traveling block position at all times relative to the observed vessel motion.

The rotary table was the revolving or spinning section of the Drill Floor that provided power to turn the drill string in a clockwise direction (as viewed from above). The rotary motion and power were transmitted through the kelly bushing and from the kelly to the drill string. When the drill string was rotating, the drilling crew commonly described the operation as simply, "rotating to the right," "turning to the right," or, "rotating on bottom." The rotary table, supplied by Varco, had a 60" opening with adapters for 60" x 49" and 49" x 37" openings. The rotary table was driven by four hydraulic motors supplied from the 3,000 psi loop. The maximum torque was 48,000 ft. lbs at 3,000 psi. The maximum speed was 25 rpm at 180 GPM. The rotary table was furnished with a remote hydraulically operated locking mechanism. The rotary table was supplied with 37" Master Bushing, #1, #2, #3, bowls and complete with API split extended bowl and lifting slings and bit breaker plate.<sup>456</sup>

A dead line anchor was a device to which the dead line, the drilling line from the crown block sheave to the anchor, so called because it does not move, is securely fastened to the mast or derrick substructure. The dead line anchor had a rated capacity of 160,000 lbs for a 2 inch wire rope. The anchor was furnished with a weight sensor and dead line clamp.<sup>457</sup>

Mouse holes are shallow bores under *DEEPWATER HORIZON* floor, usually lined with pipe, in which joints of drill pipe are temporarily suspended for later connection to the drill string. On board *DEEPWATER HORIZON*, two mouse holes were provided, one for temporary storing a length of drill pipe prior to connection to the drill string. The primary mouse hole was furnished with a mouse hole spider, which allows for off line stand building.

---

<sup>456</sup> See ABS *DEEPWATER HORIZON* Operations Manual, Section 3.2.2, ABSDWH000094

<sup>457</sup> See ABS *DEEPWATER HORIZON* Operations Manual, Section 3.2.2, ABSDWH000095

# Appendix E | VESSEL PARTICULARS

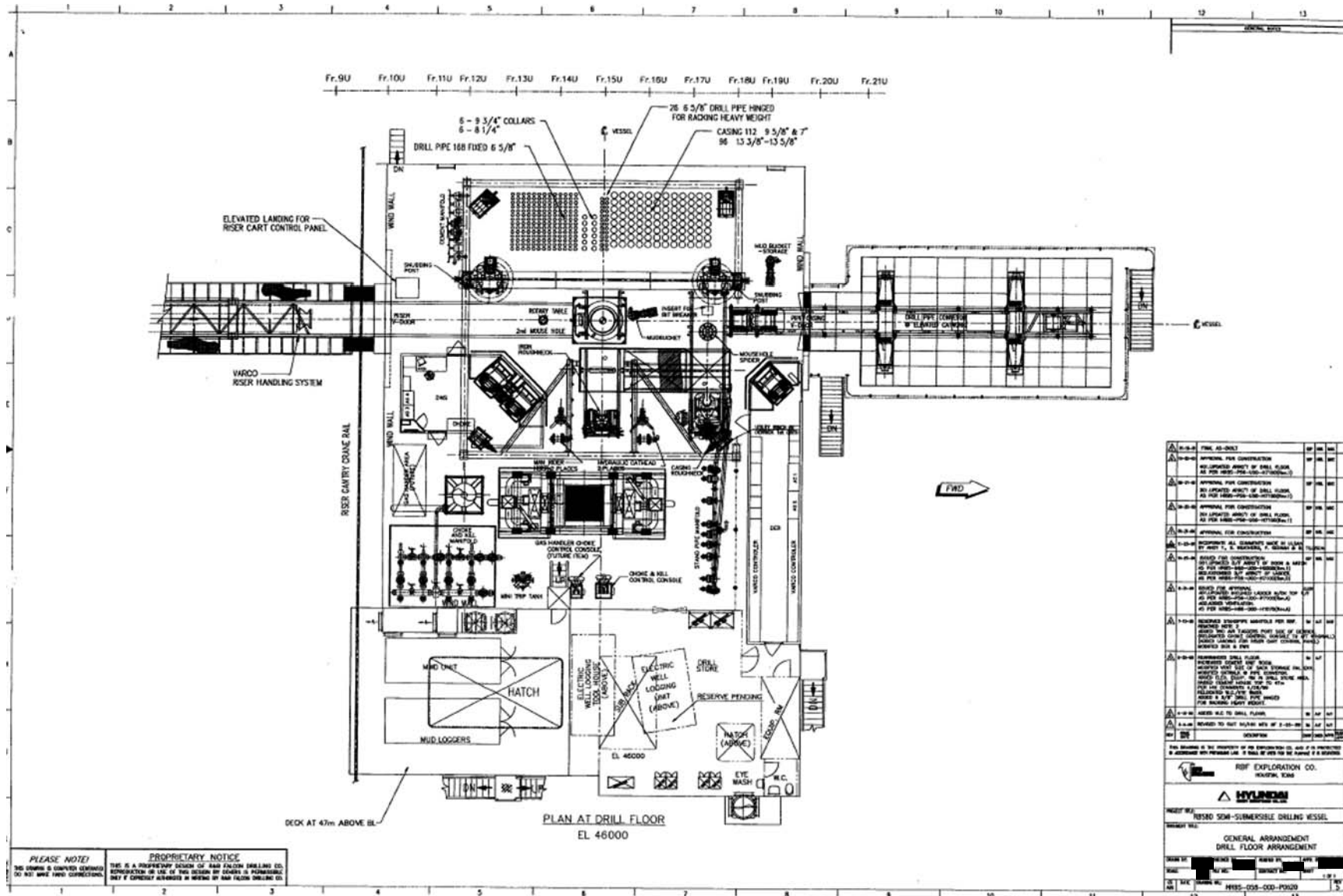

Drill Floor Layout

A casing stabbing basket, also known as a telescopic working platform, supplied by Dreco, was mounted in the Derrick. Fully extended, the basket was approximately 8.5 m from its mounting point. The basket had a lifting capacity of 660 lbs and had a maximum tilt of plus or minus 60 degrees. The basket operator would establish positive verbal communication via radio with the driller while operating the basket. The basket could be tied off to the derrick with suitable tie-down straps while not in operation.<sup>458</sup>

An iron roughneck has a pair of upper jaws carrying pipe gripping dies for gripping tool joints. The jaws have recesses formed on each side of the pipe gripping dies to receive spinning rollers. By positioning the spinning rollers in the upper jaws at the same level as pipe gripping dies, the spinning rollers were able to engage the pipe closer to the lower jaws and could then grasp the tool joint rather than on the pipe stem. The iron roughneck, supplied by Varco, was a floor mounted modular unit complete with gateless torque wrench and four roller drive spinning wrenches. The spinning wrench was located above the torque wrench for spinning the pipe into and out of the tool joint. The spinning wrench was capable of handling 3½" to 9" 00 tubulars. The torque wrench for making and breaking the drill pipe was capable of handling 3½" to 9" 00 drill collars. The unit provided 100,000 ft lbs of makeup torque and 160,000 ft lbs of break out torque. A torque gauge was located on the Iron Roughneck with another located on the Driller's Console. Sufficient rail was supplied to allow the Iron Roughneck to travel from the rotary to the side-slide and from the side-slide back to its parked position. The Iron Roughneck had the capacity for quick removal of the spinning wrench and quick installation of up to 14" modified Eckel casing/tubing tongs in a quick removal carriage assembly. The control system permitted operator initiated control sequences, which allowed the operator to customize the tool's vertical and horizontal travel during an automatic make-up and break-out sequence. The control sequence automatically positioned the torque wrench at the tool joint for make-up or break-out purposes. When breaking out, the unit executed a full sequence and returned to the setback position based on only one signal input from the operator. In the makeup mode, the sequence stopped prior to applying makeup torque, which allowed the tool to be used as a stabbing guide. The operator resumes the sequence, which would stop again while make-up torque was being applied, allowing the operator/driller to verify correct make up torque. During any automatic sequence, the operator could terminate the sequence and then later complete it using the appropriate manual control switches. The control system was provided with interlocks to prevent operator actions that may cause tool damage.<sup>459</sup>

*DEEPWATER HORIZON* was furnished with two identical pipe racking systems (Varco PRS-6i). The pipe racking system moved to the well center and engaged the drill string. Once the joint was broken, the stand was lifted clear of the pipe remaining in the rotary, the arms were retracted and the column was rotated. The column then moved to the setback area where the arms were extended, and the carriages lowered into the stand to the setback. The unit could then return to the well for another stand. The arm reach was 15 ft at 24,000 lbs and 10 ft at 30,000 lbs. The vertical column assembly included a structural box section, which guided the upper arm and supported the lower arm. The assembly was fixed to the upper and lower horizontal drives via flexible couplings and contained a drive shaft which transferred the power from the lower drive to the upper drive for horizontal movement. The upper arm and hoist assembly consisted of a modular unit complete with a scissor type racking arm that hoisted, extended and retracted

---

<sup>458</sup> Ibid.

<sup>459</sup> Ibid.

via a linear actuator with electric motor and spring applied power for release of the (fail-safe) brake. The scissor type design simplified the vertical control by moving the vertically held pipe horizontally when extending and retracting the arm. The hoist assembly included hoist motors, spring applied power to release or fail-safe brakes and hoist line and was guided by the vertical column. The arm could have been used for off line stand and bottom -hole assembly (BHA) building with the addition of the jaw mounted pick-up and lay-down elevators. The upper lifting and racking head was complete for drill pipe and drill collar lifting and racking. Integral on-board hydraulics operated the clamp and roller jaw. The head was capable of handling 3" through 9" drill pipe and drill collars, and up to 13 5/8" casing with one remote operated head.<sup>460</sup>

The lower arm assembly was a modular unit complete with racking arm that extended and retracted. The design simplified vertical control by moving the pipe horizontally when extending/retracting the arm. The arm was capable of reaching out 15ft laterally from the Racker column centerline and was capable of tailing in drill pipe and collar from an in-line single joint feeding system. The lower arm assembly incorporated a linear actuator for arm extension, and electric motor and spring applied power to release the fail-safe brake.

The lower racking head was complete for drill pipe and drill collar racking. The remotely adjustable air adjustable head was capable of guiding, stabilizing and tailing 3~" through 9% " CD drill pipe and drill collars, and up to 13 5/8" OD casing. The upper guide track assembly included PRS-6i electric and pneumatic service loops enclosed in a drag chain arrangement complete with all necessary mounting brackets and hardware. The lower drive and rotation assembly with rotation and horizontal drive systems was a floor mounted modular unit complete with remotely operated electric horizontal positioning system, electric rotation drive system together with rotation support bearings and horizontal support rollers. The upper drive assembly was an upper track mounted modular unit, complete with horizontal travel guide and drive carriage assembly. The assembly was driven mechanically from the lower drive unit located at *DEEPWATER HORIZON's* floor via a splined drive shaft supported within the vertical column assembly. The floor mounted drive and guide track assembly for the PRS-6i was provided by two modular frames, which could be mounted flush to *DEEPWATER HORIZON* floor. Within the frame was a gear rack for the drive pinion of the lower drive and the top surface of the frame was comprised of the roller track. The pipe racking system was supplied with two elevators, one allowed the racking system to hoist 2" through 9% " tubular directly from the pipe conveyor at the Drill Floor. The other elevator allowed the racking system to handle 9" through 20" OD casing directly from the pipe conveyor. Each elevator was furnished with adapter plate sets for each different size of pipes. The elevators were air operated and controlled from the assistant driller's console.<sup>461</sup>

A head was supplied for tailing 60" CD risers, which mounted to the upper arm assembly. The head was held in place by a mounting pin and was secured against the jaw hanger frame by the roller jaw. The arms of the tailing head were connected to the grip jaws and movement of the arms was controlled by the operator's grip jaw controls. The head included adapter arms fitted with rollers to facilitate vertical motion of the riser while guiding the riser into the horizontal plane. The upper arm motion provided accurate control of the riser into the derrick between a

---

<sup>460</sup> See ABS *DEEPWATER HORIZON* Operations Manual, Section 3.2.2, ABSDWH000096.

<sup>461</sup> See ABS *DEEPWATER HORIZON* Operations Manual, Section 3.2.2, ABSDWH000097.



tailing trolley and well center. The racking systems were controlled by a PLC control system located in the Driller's Equipment Room, and remotely operated from the operator control chair.

A cathead was a spool-shaped attachment on the end of the cat shaft, around which rope for hoisting and moving heavy equipment on or near *DEEPWATER HORIZON* floor was wound. On board *DEEPWATER HORIZON*, two hydraulic catheads were supplied on the Drill Floor, which imparted pulling power to the oat line that was wrapped on it. The cathead provided a line pull at a variable rate of 0 to 1.5 ft/sec with an adjustable relief valve, which allowed the line pull force to be varied to 30,000 lbs using 5 foot tongs. The hydraulic cathead assembly consisted of a frame assembly with support braces, bottom mounting plate and was bolted directly to the draw works structural members. Within the frame assembly was a double acting hydraulic cylinder with a 42" stroke resulting in a line stroke of 84".<sup>462</sup>

### F. Driller's Workstation (DWS) and Driller's Equipment Room (DER)

All the equipment associated with drilling operations and safety was monitored and controlled from the Driller's Workstation (DWS) and Drilling Equipment Room (DER) which included the following:

- Drilling equipment control system
- Drill floor and derrick pipe handling control system
- Equipment interlock system
- Drilling instrumentation system
- Blowout preventer
- Diverter control and riser disconnect system
- Automatic choke control system
- Trip tank system one
- Zone management system
- Mud mixing
- Shale shakers
- Iron roughneck
- Riser tensioner control system
- Closed circuit TV system
- Drilling intercom system
- Public address (PA) and general alarm (GA) system
- Fire and gas system
- Emergency shutdown (ESD) system
- Dynamic positioning (DP) system
- Power management system
- Deluge release (in Moon Pool and Drill Floor area)

The driller had a clear and unobstructed view out to the Drill Floor and up into the derrick and was able to perform his work from a sitting position. The Integrated Automatic Control System (IACS), which was a part of the Vessel Management System, was interfaced with the HITEC Drillers Cabin via a fiber optic communication link between the CCR/ECR and the Drillers Cabin. Since one of the functions of the IACS system was to monitor and archive certain

---

<sup>462</sup> See ABS *DEEPWATER HORIZON* Operations Manual, Section 3.2.2, ABSDWH000098.

information such as alarms, shutdowns, and other miscellaneous information for historical trending, most of the information associated with the drilling systems was monitored in either the CCR or the ECR.<sup>463</sup>

### G. Machinery and Propulsion

#### 1. Power Distribution

There were six Engine Rooms located on the Third Deck aft, three port side aft and three starboard side aft. The main power was supplied by six 7.0 Megawatt Wartsila diesel engine-generator sets. Power distribution was divided into the following systems:<sup>464</sup>

- Medium Voltage System 11000 Volts AC 3-phase 60Hz
- AC Power System 4BOV AC 3-phase 60Hz
- AC Power & Lighting Systems 120/20BV AC 3-phase 60Hz
- AC Power & Service System 230V AC I-phase 60Hz
- UPS Power Systems 120V AC I-phase 60Hz
- Drilling Drive Power System
- Thruster Drive Power System

#### 2. UPS Power Systems

There were a number of uninterruptible power supply (UPS) and charger/battery systems utilized.<sup>465</sup> They included:

- Four charger/battery systems for the Lifeboat
- Embarkation area, one per quadrant
- One UPS system for the drilling control system
- One charger/battery system for radio communication equipment
- Two ups systems for the blowout preventer (BOP) system (located in the MUX room)
- One redundant fire & gas UPS system
- One redundant ESD UPS system
- Five redundant Integrated Automatic Control System (IACS) ups systems
- Eight redundant thruster UPS systems
- Eight charger/battery systems for 11 kV switchgear control power
- Two redundant HPR/HLPAP UPS systems
- Two charger/battery systems for the standby/auxiliary/essential generator
- Two PA/GA UPS systems
- One charger/battery system for the obstruction lights
- One charger/battery system for the warning horns

---

<sup>463</sup> See ABS *DEEPWATER HORIZON* Operations Manual, Section 3.2.2, ABSDWH000099.

<sup>464</sup> See ABS *DEEPWATER HORIZON* Operations Manual, Section 6.1.1, ABSDWH0000248.

<sup>465</sup> See ABS *DEEPWATER HORIZON* Operations Manual, Section 8.1.5, ABS DWH0000370.

### 3. Drilling Drive Power Systems

The drilling drive power systems were fed from six 3000KVA 11KV/600V AC 3-phase 60Hz transformers. The 11 KV Switchboard #7 fed three of these transformers while the 11 KV Switchboard #8 fed the other three. The port and starboard drilling power systems were identical. The three starboard drilling transformers fed three drilling drive line-ups. Each line-up converted 600V AC 60Hz power into DC. The DC power out of a line-up was in turn fed into separate variable inverters that converted DC power back into AC. The frequency of the AC power was controlled. Varying the frequency coming out of the inverter controlled the speed of the drilling motors being fed.<sup>466</sup>

### 4. Electric Power Plant

The total installed power on *DEEPWATER HORIZON* was 42 MW. The 11kV system was divided into eight bus sections and was normally connected in a ring configuration. It was also possible to operate the power plant as a split system divided by tie breakers # 6 and #30. In this configuration, the system would connect switchboards 2, 3, 7, and 4 in one system and switchboards 5, 6, 8, and 1 in the other paralleled system. Six of the eight bus sections were fed by a single generator with each connected to one thruster. The remaining two bus sections each fed one thruster, one half of the drilling drives, and a forward and an aft 480 volt distribution network. In the event of the loss of any one of the eight 11kV Switchboards or Switchboard Rooms, the most severe consequence would be the shutdown of one thruster and the possible shutdown of one engine. The thruster shutdown and possible engine shutdown would be those connected to the corresponding lost switchboard or switchboard room.

To prevent loss of electrical powers, the switchboards on *DEEPWATER HORIZON* would normally be operated as a ring system as described above. A special, quick acting (100 ms) differential protective relay scheme was designed and installed on each of the eight 11kV switchboards to detect and isolate each switchboard for a three-phase, phase to phase, or phase to ground fault on any section of the ring system. This configuration prevented the loss of more than one thruster due to a single bus fault condition. The circuit breakers that would operate to isolate the eight 11kV switchboards systems were as follows:

- Unit 1 and Unit 6 for 11kV Switchboard # 1
- Unit 6 and Unit 11 for 11kV Switchboard # 2
- Unit 11 and Unit 16 for 11kV Switchboard # 3
- Unit 16 and Unit 25 for 11kv Switchboard # 7
- Unit 25 and Unit 30 for 11kV Switchboard # 4
- Unit 30 and Unit 35 for 11kV Switchboard # 5
- Unit 35 and Unit 40 for 11kV Switchboard # 6
- Unit 40 and Unit 1 for 11kV Switchboard # 8

All the drilling consumers were fed from the 11kV switchboard # 7 and switchboard # 8.

The eight thruster frequency converters (ABB SAMI Megastar) each included a power loss function, which could handle short time (up to 5 minute) networks breaks preventing the thruster

---

<sup>466</sup> See ABS *DEEPWATER HORIZON* Operations Manual, Section 8.1.6, ABSDWH0000370.

from under-voltage faults. The supply breaker of the converter would normally be kept closed. If the internal DC-voltage dropped, the converter would stop modulation and the motor would decelerate. If the DC-voltage increased within the time limit, the converter would automatically start up, synchronize to the motor and accelerate to the required speed. If the DC-voltage did not increase within the time limit, a power-off fault would occur and the frequency converter would trip.

### 5. Emergency Black Start Procedures

In the event there was a total loss of power, due to any number of conditions, the priority systems such as the vessel control system, ballast control system and all Communications, would have been maintained and operational with all the UPS Systems available. There were two main electrical busses, an essential buss and a non-essential buss, included in the electrical design. There were several utilities systems connected to the essential buss, which included the instrument air and plant air systems. The first step, in the event of a total power outage, would have been to bring the standby (essential) generator on line and tie into the essential buss. This would have provided power for the plant air compressor, which was required to start the main generators. Since the standby generator was a battery start, this would not pose any problems. After the main generators were brought on line and tied into the essential and non-essential busses, the normal operation of the vessel could resume.<sup>467</sup>

### 6. Thruster Drive Power Systems

There were eight thruster drives installed on *DEEPWATER HORIZON*. The thruster drive power systems were fed from a 7300KVA 11 KV/3450/3450V AC 3phase 60Hz dual secondary winding transformers. The dual 3450V AC feeds were converted and inverted back into a dual variable frequency AC output. The dual stator, thruster motor speed was controlled by varying the thruster drive output frequency.

### 7. Visual and Audible Alarms

Audible alarms created a sound level of 75 decibels, or 20 decibels above the ambient noise, whichever was greater. In extremely noisy areas (such as engine rooms) several sets of flashing beacons were installed to ensure that personnel were notified of alarm conditions (minimum two sets per engine room). Audible alarms in the engine rooms, Mud Pump Room, Drill Floor, Moon Pool, eight Thruster Rooms and four Lower Hull Pump Rooms were equipped with air horns. Audible alarms for open decks, storerooms, switchgear rooms and sack room, were multi-tone electronic horns. In the Accommodations block, audible warning devices consisted of multi-tone electronic horn alarms and 12 inch General Alarm gongs. These devices were distributed within the quarters and offices, in passageways and in public areas.

Visual Alarms in the engine rooms, Mud Pump Room, Drill Floor, Moon Pool, eight Thruster Rooms and four Lower Hull Pump Rooms were explosion proof, outdoor type xenon lamp beacons. Visual Alarms for store rooms, switchgear rooms, workshops and the sack room, were general purpose (indoor) multi-lamp tower assemblies of smaller xenon lamp beacons.

---

<sup>467</sup> See ABS *DEEPWATER HORIZON* Operations Manual, Section 9.2.9, ABSDWH0000569.

All visual and audible alarm devices were identified by clearly legible signs (white text on a red field) that identify the alarm device's function, the correct response to an alarm, and the alarm device's tag number.

There were ten General Alarm contact makers, complete with lockable weather tight enclosures, distributed as follows:

- Drill Floor (2)
- Offshore Installation Manager's Office
- Forward Lifeboat Station
- Aft Lifeboat Station
- Standby (Essential) Generator Room
- Central Control Room / Bridge (2)
- Engine Control Room (2)

The contact maker for the Drill Floor was explosion proof. The details for the alarm tones that were generated by the different safety systems are listed in the following table:<sup>468</sup>

- P.A.P.A. (Abandon Ship): Standard PAPA - Sweeping Tone
- GENERAL ALARM: 2 kHz (approximately) for 1 sec/1 sec blank repeat continuously
- FIRE: 1 kHz for 3 sec/1 sec blank, 1.6 kHz for 1 sec/1 sec blank, repeat continuously
- COMBUSTIBLE GAS: 1 kHz for 1 sec, 1.6 kHz for 1 sec, repeat continuously
- TOXIC GAS: 2 kHz (approximately) continuously
- ALL CLEAR: Bell for 6 sec/3 sec blank

### 8. Emergency Shutdown System

The Emergency Shutdown (ESD) System was integrated into the safety system. ESD stations with eight individual mushroom head maintained position manual controls (pushbuttons), included:<sup>469</sup>

- Port machinery space ventilation
- Starboard machinery space ventilation
- Quarters ventilation
- Fuel oil services / fired heaters
- Non-essential electrical equipment
- Essential electrical equipment - main generator cb trips
- Standby electrical equipment – standby (essential) generator CB trips
- Generator prime mover shutdown

These stations were located at:

- Central Control Room / Bridge
- Engine Control Room
- Drill Shack

---

<sup>468</sup> See ABS *DEEPWATER HORIZON* Operations Manual, Section 9.2.7, ABSDWH0000559.

<sup>469</sup> See ABS *DEEPWATER HORIZON* Operations Manual, Section 9.2.8, ABSDWH0000569.

### 9. Watertight/Weather Tight Doors and Hatches

As per the International Convention for the Safety of Life at Sea (SOLAS), weather tight doors are defined as doors which will not allow water to penetrate into the ship under any sea conditions. Watertight doors are defined as doors having the capability of preventing the passage of water through the structure in any direction under a head of water for which the surrounding is designed. The design of *DEEPWATER HORIZON* incorporated the installation of monitoring contacts and local audible and visual alarms at all watertight doors and hatches that must be monitored while the vessel was underway or moored in order to comply with the regulatory bodies, including the Coast Guard and United Kingdom rules. Each watertight door had a local audible alarm horn and flashing red beacon, as well as two Form "C" contacts to indicate the door was "CLOSED". One contact was used to operate the local alarms, and the other was a dry contact wired to the Integrated Alarm Control System (IACS). The IACS included monitoring for all watertight doors and hatches and controls for all hatches or doors that were required to have remote closing capability by the Class Society or by the Regulatory Bodies.<sup>470</sup>

*DEEPWATER HORIZON* was subdivided by a number of longitudinal and transverse watertight boundaries/bulkheads. The overall damaged stability of *DEEPWATER HORIZON* was dependent on the integrity of these watertight boundaries. There were various openings provided in the watertight boundaries for access by personnel and materials in the form of sliding watertight doors and watertight (dogged) hatches. The normal position for these access ways would have been the closed position.

It was ultimately the master's responsibility to ensure the watertight integrity of *DEEPWATER HORIZON*. All openings on the Main Deck such as hatches, ventilators, tank vents, companionways, were provided with a means of watertight closure. All openings not required during a move would be secured in the closed position. In order to ensure the watertight integrity of the bulkheads and flats the following policies were in place:

- All crew members were informed of the importance of maintaining the watertight boundary integrity.
- All doors and hatches through the boundaries were required to be clearly labeled with the following text: "this door/hatch to be kept closed while at sea."
- No cables or hoses could pass through a watertight door while *DEEPWATER HORIZON* was at sea.
- All modifications to *DEEPWATER HORIZON* must be assessed with regard to water tight integrity and procedures under the company's Quality Assurance (QA) system to ensure that the integrity of the boundary was restored after modifications were completed.

---

<sup>470</sup> See ABS *DEEPWATER HORIZON* Operations Manual, Section 5.2.6, ABSDWH0000547.

**H. Lifesaving Appliances**

**1. Lifeboat**

- Fassmer Lifeboat Model CLR-T 8.5
- Coast Guard Approval # 160.135/0000063/0 (listed as SOLAS approved)

**2. Liferaft**

- Viking liferaft Model # 25DKF+
- Coast Guard Approval # 160.151/0000118/0 (listed as SOLAS approved)

## Appendix F | WEATHER INFORMATION

---

Winds:	6 Knots
Direction:	218 Degrees True / SSW
Wave Height:	0.6 Feet
Seas:	< 1 Foot
Swell:	None
Prevailing Conditions:	High Pressure / Stable Air Mass
Ambient Temp:	69 Degrees Fahrenheit
Water Temp:	71 Degrees Fahrenheit
Pressure:	1013.3 hPa / 29.92 hg
Tendency:	Steady
Icing:	N/A

❖ The above were weather conditions at the time of the casualty.



Appendix G | FINAL ACTION REPORT ON THE SAR CASE STUDY INTO THE MASS RESCUE OF PERSONNEL OFF THE MOBILE OFFSHORE DRILLING UNIT *DEEPWATER HORIZON*

---



Commandant  
United States Coast Guard

2100 2ND ST SW STOP 7000  
Washington, DC 20593-7000  
Phone: (202) 372-2080  
Fax: (202) 372-2908

16106

**MEMORANDUM**

MAR 25 2010

From: [REDACTED]  
Cari B. Thomas, Rear Admiral  
CG-53

To: Distribution

Subj: FINAL ACTION REPORT ON THE SAR CASE STUDY INTO THE MASS RESCUE OF PERSONNEL OFF THE MOBILE OFFSHORE DRILLING UNIT DEEPWATER HORIZON

Ref: (a) U.S. Coast Guard Addendum to the United States National Search and Rescue Supplement (NSS) to the International Aeronautical and Maritime Search and Rescue Manual (IAMSAR), COMDTINST M16130.2E  
(b) 40 CFR Part 300, National Oil and Hazardous Substances Pollution Contingency Plan  
(c) RRT-6 FOSC Dispersant Pre-Approval Guidelines and Checklist

1. This Final Action Report sets forth the relevant facts adduced from the SAR Case Study following the Mass Rescue Operation (MRO) of the Mobile Offshore Drilling Unit (MODU) DEEPWATER HORIZON (DWH) explosion and resulting fire. The Case Study was conducted pursuant to reference (a) to look at initial actions including coordination of firefighting efforts, the decision process of either evaluating risk or prioritizing the application of dispersants during ongoing SAR efforts and direct actions to improve SAR execution. The Motor Vessel (M/V) DAMON B. BANKSTON was on-scene<sup>1</sup> when the incident occurred and was able to quickly recover personnel who abandoned DWH. As a result, 115 lives were saved. Additionally, vessels and platforms in the area volunteered critical SAR resources and staging areas for U.S. Coast Guard and commercial aircraft use. Without the availability of the M/V DAMON B. BANKSTON on-scene and cooperation of surrounding MODUs and platforms, the MRO would have been more challenging.

2. **Overview.**

- a. At 2150 local (approximately 2.5 hours after sunset), April 20, 2010, the MODU DWH Rig Clerk called a British Petroleum (BP) dispatcher in Port Fourchon, Louisiana, reporting that the DWH was on fire and people were evacuating by water and in need of emergency assistance. The dispatcher, in turn, notified Transocean Ltd (hereafter "Transocean"). Over the next twenty (20) minutes, Transocean representatives notified -

---

<sup>1</sup> The M/V DAMON B. BANKSTON was initially alongside and connected to the MODU DWH awaiting a liquid mud transfer. After the explosion, the M/V was disconnected from the MODU and moved approximately 1,000 yards away.

Appendix G | FINAL ACTION REPORT ON THE SAR CASE STUDY INTO THE  
MASS RESCUE OF PERSONNEL OFF THE MOBILE OFFSHORE  
DRILLING UNIT *DEEPWATER HORIZON*

---

Subj: FINAL ACTION REPORT ON THE SAR CASE STUDY INTO THE MASS RESCUE OF PERSONNEL OFF THE MOBILE OFFSHORE DRILLING UNIT DEEPWATER HORIZON 16106

MODUs and drill ships in the vicinity of DWH, commercially contracted medical aviation support, BP Houston and the Coast Guard. Environmental conditions on-scene were reported as light winds with a light chop on the water. Average air temperature and water temperature for April 21, 2010, were recorded as 63° F and 69° F, respectively.

- b. At 2204, April 20, 2010, Coast Guard Sector Mobile, Alabama, Command Center received the DWH Digital Select Calling (DSC) distress alert. This information was forwarded to the Command Center, Commander, Eighth Coast Guard District. Coast Guard Search and Rescue (SAR) Mission Coordinator (SMC) was assumed by Commander, Eighth Coast Guard District, New Orleans, Louisiana. The District Command Center immediately began coordinating the MRO. The SMC issued an Urgent Marine Information Broadcast (UMIB) and Search and Rescue Units (SRUs) were launched from:
  - (1) Coast Guard Air Station New Orleans, Louisiana.
  - (2) Coast Guard Aviation Training Center Mobile, Alabama.
  - (3) Coast Guard Sector New Orleans, Louisiana.
  - (4) Coast Guard Sector Mobile, Alabama.
- c. The DWH crew evacuated the MODU into survival craft and into the water. Commercial and recreational vessels were first to arrive on-scene and began retrieving the survivors. Survivors on board M/V DAMON B. BANKSTON<sup>2</sup> reported to the SMC that there were a total of 126 persons on-board DWH at the time of the explosion.<sup>3</sup> When Coast Guard SRUs arrived on-scene, they observed that DWH was on fire and multiple surface vessels<sup>4</sup> were actively searching within 100 yards of the MODU, with additional vessels searching within sight of the DWH. DWH was engulfed in flames from below the MODU to the top of the derrick.<sup>5</sup>
- d. Coast Guard SRUs were notified of the DWH fire within twenty (20) minutes of SMC notification by Transocean. During these twenty (20) minutes the involved command centers were acquiring reports from various sources, assimilating and interpreting the information that was being received, and determining appropriate assets to launch. The first Coast Guard SRU, CG-6605,<sup>6</sup> was airborne en route the DWH's position eighteen (18) minutes later and arrived on-scene within forty-two (42) minutes.

---

<sup>2</sup> IMO Number: 9275012.

<sup>3</sup> M/V DAMON B. BANKSTON took onboard 115 DWH survivors.

<sup>4</sup> The actual number of vessels that responded to the initial distress broadcast by the DWH is not ascertainable but by one account from a recreational vessel at 0110 local on April 21, 2010, there were ten (10) to fifteen (15) vessels on-scene searching for persons in the water and five (05) vessels spraying water on the DWH fire.

<sup>5</sup> A derrick is the framework erected over the oil well that allows drilling tubes to be raised and lowered.

<sup>6</sup> CG-6605 is a Coast Guard MH65 Dolphin helicopter. The Dolphin is primarily a Short Range Recovery (SRR) aircraft, usually deployed from shore but it can be deployed from Medium and High Endurance Coast Guard Cutters, as well as the Polar Icebreakers. Dolphin missions include: SAR, law enforcement, polar ice breaking, marine environmental protection, and military readiness. CG-6605 is stationed at Coast Guard Air Station New Orleans, Louisiana.

Appendix G | FINAL ACTION REPORT ON THE SAR CASE STUDY INTO THE  
MASS RESCUE OF PERSONNEL OFF THE MOBILE OFFSHORE  
DRILLING UNIT *DEEPWATER HORIZON*

---

Subj: FINAL ACTION REPORT ON THE SAR CASE STUDY INTO THE MASS RESCUE OF PERSONNEL OFF THE MOBILE OFFSHORE DRILLING UNIT DEEPWATER HORIZON 16106

- e. The initial attempted aerial search on the DWH and immediate vicinity by CG-6605 was 75 feet above the water and within 150 feet of the burning MODU; but was unsuccessful due to the extreme radiant heat emitting from DWH. The rescue helicopter reduced altitude to 50 feet above the water and continued the search. The rescue helicopter identified a small raft on fire underneath the DWH and observed burning liquid from the MODU pouring on the small raft. CG-6605 conducted another pass and visually confirmed that no one was in the small raft, under the MODU, clinging to one of the MODU's four legs, or still on the MODU itself.
- f. Stationed approximately 1,000 yards from the DWH, M/V DAMON B. BANKSTON initially assumed the lead in coordinating smaller vessels on-scene that were searching for survivors. CG-6605's rescue swimmer was lowered to M/V DAMON B. BANKSTON to coordinate the medical evacuation of critically injured DWH survivors.
- g. Throughout the evening of April 20 and early morning hours of April 21, additional Coast Guard SRUs arrived to support the search for eleven (11) persons still missing. These additional SRUs included:
  - (1) CG-2308<sup>7</sup>, which relieved CG-6605 as Coast Guard designated On-Scene Coordinator (OSC) for aviation SRUs.
  - (2) Coast Guard Cutter (CGC) POMPANO<sup>8</sup>, which assumed Coast Guard designated OSC responsibilities from M/V DAMON B. BANKSTON for surface units.
- h. Initial firefighting efforts were coordinated from the M/V DAMON B. BANKSTON. OSV's that responded to request for support from Transocean applied firefighting water onto the DWH fire while other vessels launched a Remote Operated Vehicle (ROV) that attempted to secure the flow of hydrocarbons from the well by operating the Blowout Preventer. The other surface SRUs continued searching for the missing DWH crewmembers.
- i. Coast Guard Marine Safety Unit Morgan City, Louisiana, Investigation Officer cross-referenced the DWH crew list (of missing personnel) with that of survivors witness/interview statements on April 22, 2010. Of the eleven (11) missing persons, seven (07) were identified as likely to be deceased by eyewitness accounts and four (04) were unaccounted for. None of the eleven (11) missing DWH crewmembers were ever located.
- j. Coast Guard and other SRUs searched for over sixty-eight (68) hours; including over twenty-six (26) sorties<sup>9</sup> and more than 137 resource hours before the Coast Guard SMC made the decision to suspend the search for the DWH crewmembers that were

---

<sup>7</sup> CG-2308 is an HC-144A (Ocean Sentry) Maritime Patrol fixed-wing aircraft. The HC-144A performs various Coast Guard missions, including SAR, homeland security, law enforcement, marine environmental protection, military readiness, international ice patrol, as well as cargo and personnel transport. CG-2208 is stationed at Coast Guard Aviation Training Center Mobile, Alabama.

<sup>8</sup> CGC POMPANO is an 87-foot Marine Protector Class Coastal Patrol Boat that conducts SAR, law enforcement, and Homeland Security missions.

<sup>9</sup> Sorties refer to each time a resource such as assets or personnel are dispatched to respond to a SAR incident.

Appendix G | FINAL ACTION REPORT ON THE SAR CASE STUDY INTO THE MASS RESCUE OF PERSONNEL OFF THE MOBILE OFFSHORE DRILLING UNIT *DEEPWATER HORIZON*

---

Subj: FINAL ACTION REPORT ON THE SAR CASE STUDY INTO THE MASS RESCUE OF PERSONNEL OFF THE MOBILE OFFSHORE DRILLING UNIT DEEPWATER HORIZON 16106

unaccounted for. When the SAR case was suspended at 1853 local, April 23, 2010, twenty-four (24) separate search patterns were conducted by surface and air SRUs, covering over 5,000 square miles. During these searches, the Coast Guard designated OSC received and coordinated the investigation of reports of burnt survival craft, an article of clothing, orange discoloration to the water, other debris, and a possible 121.5 MHz Emergency Position Indicating Radio Beacon (EPIRB) alert located within the search area.

**3. Findings of Fact.**

- a. The position of DWH, a 396 foot by 256 foot, 8,000 metric ton, steel hull, MODU registered in the Marshall Islands, was 28°- 44' North 088°- 21' West (approximately 50 miles south of South Pass, Louisiana).
- b. The time the Coast Guard was notified of the DWH distress was 2204 local, April 20, 2010.
- c. Assumptions the SMC used in planning the search for the missing DWH crewmembers were:
  - (1) The eleven (11) missing persons did not perish in the initial MODU fire.
  - (2) The eleven (11) persons may have fallen/jumped off the MODU, or may have remained on board.
  - (3) The missing persons were not wearing life jackets or in a life raft; but may have been floating free in the water.
  - (4) The object type used for search planning: Person-in-the-Water (PIW) without a life jacket.
- d. Environmental data utilized by the SAR watchstanders during search planning was obtained from the Coast Guard Search and Rescue Optimal Planning System (SAROPS), Environmental Data System (EDS) for wind and manually input from the Self-Locating Data Marker Buoy (SLDMB) for current. This data was used in planning the searches for the designated Alpha through Juliet search plans.
- e. Many of the completed searches in the SAROPS Summary review column, enclosure (1), were labeled as "Tentative". In this case SAROPS assumes the actual commence search time and end search time will both be as planned and that the search is 100% complete.
- f. The SAROPS summary for the PIW searches conducted from April 20, 2010 to April 23, 2010 is provided as enclosure (1).
  - (1) Enclosure (1) is a summary of the search areas coordinated, type of SRU assigned, type of search patterns conducted, the area searched, track length miles and percentage of the search area completed.

Appendix G | FINAL ACTION REPORT ON THE SAR CASE STUDY INTO THE  
MASS RESCUE OF PERSONNEL OFF THE MOBILE OFFSHORE  
DRILLING UNIT *DEEPWATER HORIZON*

---

Subj: FINAL ACTION REPORT ON THE SAR CASE STUDY INTO THE MASS RESCUE OF PERSONNEL OFF THE MOBILE OFFSHORE DRILLING UNIT DEEPWATER HORIZON 16106

- (2) SAROPS calculated the Probability of Success (POS) in the cumulative searches for a PIW without a lifejacket as 84% within the defined search area at the end of the Juliet search.
- g. Commander, Eighth Coast Guard District, New Orleans, Louisiana, assumed SAR case SMC at 2206 local on April 20, 2010.
- (1) The SMC's primary focus was SAR until the search was suspended at 1853 local, April 23, 2010.
- (2) Two additional Coast Guard Eighth District Command Center personnel were recalled to augment and assist the Command Center watch.
- h. The SMC was in communication with BP while coordinating the DWH MRO response.
- i. M/V DAMON B. BANKSTON initially assumed the lead in coordinating the rescue of DWH survivors with other vessels that arrived on-scene to assist.
- j. CG-6605 assumed Coast Guard designated OSC for aviation SRUs and was relieved shortly after arriving on scene by CG-2308.
- k. After arriving on-scene, CGC POMPANO assumed the Coast Guard designated OSC from M/V DAMON B BANKSTON for surface SRUs conducting the PIW search. CGC POMPANO was later relieved by CGC ZEPHYR.<sup>10</sup>
- l. Both CGCs POMPANO and ZEPHYR communicated with the Offshore Supply Vessels (OSVs) on-scene. During the initial MRO, the OSVs reported to CGCs POMPANO and ZEPHER and requested tasking. The Coast Guard designated OSCs tasked the OSVs and other vessels to continue to maintain a lookout for possible DWH survivors, as well as report findings and changes to the DWH's status.
- m. The OSVs provided a heat screen by using their fire monitors to pump water on and around the DWH fire, attempted to secure the source of the hydrocarbons, and kept a lookout for the missing DWH crewmembers. None of these actions inhibited the Coast Guard SAR response.
- n. BP assigned six (06) vessels to assist the Coast Guard and Transocean with SAR operations.
- o. At 2300, April 21, 2010, BP's Incident Action Plan (IAP) (Submitted by Mr. [REDACTED]) identified the general response objectives for resources that responded to the DWH disaster. These objectives included:
- (1) Support Coast Guard and Transocean led SAR Activities.
- (2) Control the source of the spill. These actions included:
- (a) Support Transocean in emergency shutdown.
- (b) Develop secondary options for well control.

---

<sup>10</sup> CGC ZEPHYR is a 179-foot Cyclone Class Patrol Coastal Boat. CGC ZEPHYR's missions include SAR, law enforcement, and Homeland Security operations.

Appendix G | FINAL ACTION REPORT ON THE SAR CASE STUDY INTO THE  
MASS RESCUE OF PERSONNEL OFF THE MOBILE OFFSHORE  
DRILLING UNIT *DEEPWATER HORIZON*

---

Subj: FINAL ACTION REPORT ON THE SAR CASE STUDY INTO THE MASS RESCUE OF PERSONNEL OFF THE MOBILE OFFSHORE DRILLING UNIT DEEPWATER HORIZON 16106

- (c) Protect infrastructure in the area.
- p. The BP IAP Resource Summary assigned resources to groups within the Incident Command Operations Branch. These groups included the:
- (1) SAR Group.
  - (2) Dispersant Group.
  - (3) Emergency Response Branch.
  - (4) Firefighting Group.
  - (5) Mechanical Recovery Group.
- q. According to the IAP Resource Summary (prepared at 2300 by Mr. David Hull), five (05) vessels (M/V C-ENFORCER, M/V GLORIA CALLIS, M/V MONICA ANN, M/V NORBERT BOUZIGARD and M/V SEACOR LEE) were assigned to the Marine Firefighting Group.
- r. The SMC and Coast Guard designated OSC did not coordinate the firefighting actions of the vessels assigned to the Marine Firefighting Group.
- s. There is no requirement for a Responsible Party or the Regional Response Team (RRT) to consider SAR when planning the use of dispersants. Regardless, the RRT, Eighth Coast Guard District Incident Management Team (IMT), and the SMC were consulted before authorizing the use of dispersants by the Responsible Party. The SMC confirmed the use of dispersants would not inhibit SAR operations.
- t. The dispersant, Corexit EC9527A, was sprayed in an active search area on April 22, 2010, (1,500 gallons were sprayed in five (05) separate sorties). Technical Bulletin #D-1, provided by the U.S. Environmental Protection Agency, indicates that Corexit EC9527A is harmful to humans.<sup>11</sup> Dispersant planning and spraying was conducted in accordance with references (b) and (c).
- u. At 1534 local, April 22, 2010, the DWH survivors were debriefed by Coast Guard Investigating Officers from Coast Guard Marine Safety Unit Morgan City, Louisiana. The DWH crew list was used during debrief.
- (1) From the interviews it was determined that seven (07) of the missing persons were likely to be deceased.
  - (2) The remaining four (04) missing persons were not seen by the survivors after the explosion.
- v. Coast Guard Command Duty Officers, SAR Controllers, Operations and Situation Unit watchstanders from the Eighth Coast Guard District Command Center, Coast Guard Sector New Orleans, Louisiana, and Coast Guard Sector Mobile, Alabama, were interviewed for the SAR case study.

---

<sup>11</sup> The MSDS for Corexit EC9527A indicates that *acute excessive exposure* may cause "central nervous system effects, nausea, vomiting, anesthetic or narcotic effects" (emphasis added).

Appendix G | FINAL ACTION REPORT ON THE SAR CASE STUDY INTO THE MASS RESCUE OF PERSONNEL OFF THE MOBILE OFFSHORE DRILLING UNIT *DEEPWATER HORIZON*

---

Subj: FINAL ACTION REPORT ON THE SAR CASE STUDY INTO THE MASS RESCUE OF PERSONNEL OFF THE MOBILE OFFSHORE DRILLING UNIT DEEPWATER HORIZON 16106

- w. Eighth Coast Guard District Command Center, Coast Guard Sector New Orleans, Louisiana, and Coast Guard Sector Mobile, Alabama, reported there were no equipment problems or issues found during the review of the case materials, correspondence and SAR case history. The Rescue 21<sup>12</sup> system was fully operational.
- x. At the time of the DWH distress notification, a Command Duty Officer (qualified SAR Controller), SAR Controller, and an Operations Unit watchstander were on watch. Within two (02) hours, an additional SAR Controller was recalled to augment the watch. This met the requirement of the established policy at the Eighth Coast Guard District Command Center. Coast Guard Sector New Orleans, Louisiana, and Coast Guard Sector Mobile, Alabama, had qualified SAR watchstanders on watch at the time of DWH distress notification as required by policy.
- y. The following SRUs were available at the time of the DWH distress notification:
  - (1) Coast Guard Aviation Training Center Mobile, Alabama: Four (04) HC-144 aircraft in Bravo Status.<sup>13</sup>
  - (2) Coast Guard Air Station New Orleans, Louisiana: Four (04) HH-65 helicopters in Bravo Status.<sup>14</sup>
  - (3) Coast Guard Sector New Orleans, Louisiana:
    - (a) One (01) Coast Guard cutter in Bravo Status<sup>15</sup> (six (06) hours readiness).
    - (b) Two (02) Coast Guard cutters in Bravo Status, (twelve (12) hours readiness).
  - (4) Coast Guard Sector Mobile, Alabama:
    - a. One (01) Coast Guard cutter in Alpha Status (underway).
    - b. One (01) Coast Guard cutter in Bravo Status (twenty-four (24) hours readiness).
  - (5) CGC ZEPHYR, in transit from maintenance and repairs to homeport, was diverted to the DWH distress.
- z. Of the above listed SRUs, all crewed aircraft and cutters were deployed.
- aa. EPIRB satellite data from DWH was originally received at 1252 local, April 21, 2010, approximately three (03) hours after the initial distress notification to the Coast Guard. The original positions had a fifty percent (50%) A and B position probability and were plotted 156 nautical miles (NM) due east of Jacksonville, Florida, and 900 NM north and

---

<sup>12</sup> Rescue 21 is the Coast Guard's new command, control, and communications system for all missions in the coastal zone that provides increased communications coverage and advanced direction-finding capabilities.

<sup>13</sup> Aircraft Bravo Status indicates that the aircraft is mechanically available for operations. However, there may not be a crew to operate the Bravo status aircraft.

<sup>14</sup> Aircraft Bravo Status indicates that the aircraft is mechanically available for operations. However, there may not be a crew to operate the Bravo status aircraft.

<sup>15</sup> Cutter Bravo Status indicates the readiness condition of the resource. This is a time frame in which the vessel will be able to meet the next level of readiness. In this case the next level of readiness is Alpha, which is an underway status.

Appendix G | FINAL ACTION REPORT ON THE SAR CASE STUDY INTO THE MASS RESCUE OF PERSONNEL OFF THE MOBILE OFFSHORE DRILLING UNIT *DEEPWATER HORIZON*

---

Subj: FINAL ACTION REPORT ON THE SAR CASE STUDY INTO THE MASS RESCUE OF PERSONNEL OFF THE MOBILE OFFSHORE DRILLING UNIT DEEPWATER HORIZON 16106

east of the Lesser Antilles. Subsequent reports received from the EPIRB indicated the accurate position of DWH.

- bb. The primary means of communication between the SMC, OSC, and SRUs was via a secure communication system. This data was not saved and cannot be recovered.
- cc. The Cold Exposure Survival Model (CESM) was used in accordance with Coast Guard policy at the time of the DWH incident.<sup>16</sup> SAR watchstanders used the CESM on April 22, 2010. A water temperature of 70°F was used (air temperature is not significant in CESM calculations for a PIW submerged to the neck). The CESM functional time was calculated to be 18.7 hours. Survival time was calculated to be thirty-one (31) hours.<sup>17</sup>

4. **Consolidated SAR Case Timeline.**

**April 20, 2010**  
(All times local time)

- 2150 – Mr. [REDACTED] (BP) received original notification from DWH.
- 2156 – Maritime Rescue Coordination Center Rome, Italy, and received the DWH Digital Select Calling (DSC) High Frequency (HF) Distress Alert.
- 2204 – Coast Guard Sector Mobile, Alabama, Command Center received the DWH DSC HF distress alert; position 28°-44' North 088°-21' West.
- 2206 – Eighth Coast Guard District Command Center received a phone call from Mr. [REDACTED] who reported DWH was on fire with personnel abandoning the MODU, approximately 50 NM south of South Pass, Louisiana. Eighth Coast Guard District Command Center assumed SMC.
- 2206 – Coast Guard Sector Mobile, Alabama, received a radio transmission from recreational vessel RAMBLIN' WRECK, relaying communications that DWH was engulfed in flames and personnel were abandoning the MODU.
- 2210 – Coast Guard Sector Mobile, Alabama, reported the alert and notified the Eighth Coast Guard District Command Center. Eighth Coast Guard District Command Center recalled CGCs RAZORBILL<sup>18</sup> and POMPANO and launched aircraft from Air Stations New Orleans, Louisiana, and Mobile, Alabama.

<sup>16</sup> The CESM is a tool that provides SAR professionals with predicted functional time and predicted survival time of distressed persons based upon cooling of the body's core temperature. At functional time, the person is incapacitated by hypothermia and is at the limits of self-help. Survival time is the predicted time after immersion when the person's core temperature falls to the end of moderate hypothermia at 28°C (82.4°F).

<sup>17</sup> The Coast Guard Probability of Survival Detection Aid (PSDA) replaced the CESM and was released on April 16, 2010. The PSDA uses a significantly improved model and includes dehydration survival impacts in warmer waters. An example PSDA was made during the development of the DWH SAR case study using a water temperature of 70°F and air temperature of 72°F. The PSDA model provided a functional time of 71.7 hours and a survival time of 120 hours. 120 hours is the maximum calculated survival time in the PSDA model for persons immersed in water.

<sup>18</sup> 87-foot Marine Protector Class Coastal Patrol Boat.



**Appendix G | FINAL ACTION REPORT ON THE SAR CASE STUDY INTO THE  
MASS RESCUE OF PERSONNEL OFF THE MOBILE OFFSHORE  
DRILLING UNIT *DEEPWATER HORIZON***

---

Subj: FINAL ACTION REPORT ON THE SAR CASE STUDY INTO THE MASS RESCUE OF PERSONNEL OFF THE MOBILE OFFSHORE DRILLING UNIT DEEPWATER HORIZON 16106

- 2210 – Coast Guard Air Station New Orleans, Louisiana, was notified of the DWH distress and directed to launch CG-6605.
- 2215 – Coast Guard Sector Mobile, Alabama, issued an UMIB.
- 2215 – Civilian helicopter S-92<sup>19</sup> was tasked to support the DWH response.
- 2228 – CG-6605 was launched, enroute DWH.
- 2235 – CG-2308 was launched. Mission: SAR and report any DWH oil.
- 2240 – S-92 launched from South Lafourche Leonard Miller Jr. Airport,<sup>20</sup> Galliano, Louisiana, to assist in DWH SAR operations.
- 2300 – CGC COBIA<sup>21</sup> diverted to the DWH.
- 2310 – CG-6605, the first Coast Guard SRU on-scene, assumed Coast Guard designated OSC.
- 2315 – CG-2308 on-scene; relieved CG-6605 as the Coast Guard designated OSC.
- 2337 – BP reports 111 persons<sup>22</sup> from the DWH are onboard the M/V DAMON B. BANKSTON

**April 21, 2010**

- 0004 – CG-6576<sup>23</sup> arrived on-scene.
- 0100 – The Federal Aviation Administration (FAA) granted the Coast Guard's request for an airspace Temporary Flight Restriction (TFR).
- 0110 – A Good Samaritan vessel reported that ten (10) to fifteen (15) vessels were on-scene searching for PIWs; five (05) vessels were spraying water on the DWH fire.
- 0133 – CG-6508<sup>24</sup> arrived on-scene.
- 0210 – CGC POMPANO assumed Coast Guard designated OSC for all surface SRUs.
- 0245 – SAROPS Case Name "DEEPWATER HORIZON" opened by Mr. [REDACTED] Eighth Coast Guard District Command Center.

---

<sup>19</sup> The S-92 helicopter used in the DWH response was owned and operated by VIH Cougar Helicopters, Galliano, Louisiana. S-92 received a page from Cougar Helicopters dispatch of a possible fire on BP DWH. A second page was received from Cougar Helicopter dispatch verifying the mission.

<sup>20</sup> Call Sign: KGAO.

<sup>21</sup> 87-foot Marine Protector Class Coastal Patrol Boat.

<sup>22</sup> Subsequent MISLE entries provide that the final number of DWH personnel aboard the M/V DAMON B. BANKSTON as 115.

<sup>23</sup> Coast Guard Dolphin helicopter stationed at Coast Guard Air Station New Orleans, Louisiana.

<sup>24</sup> Coast Guard Dolphin helicopter stationed at Coast Guard Air Station New Orleans, Louisiana.

Appendix G | FINAL ACTION REPORT ON THE SAR CASE STUDY INTO THE  
MASS RESCUE OF PERSONNEL OFF THE MOBILE OFFSHORE  
DRILLING UNIT *DEEPWATER HORIZON*

---

Subj: FINAL ACTION REPORT ON THE SAR CASE STUDY INTO THE MASS RESCUE OF PERSONNEL OFF THE MOBILE OFFSHORE DRILLING UNIT DEEPWATER HORIZON 16106

- 0400 – CG-6016,<sup>25</sup> CG-6605, CGC POMPANO commenced Alpha searches.<sup>26</sup>
- 0437 – S-92 landed at the University of South Alabama and delivered five (05) critically injured DWH personnel.
- 0643 – Eighth Coast Guard District requested from Coast Guard Atlantic Area to use CGC DECISIVE.<sup>27</sup>
- 0700 – CG-6605 and CG-6508<sup>28</sup> commenced Bravo searches.
- 0715 – CGC ZEPHYR arrived on-scene.
- 0730 – CGC ZEPHYR assumed Coast Guard designated OSC.
- 0800 – CG-2308, CGC COBIA<sup>29</sup> and CGC ZEPHYR commenced Bravo searches.
- 0813 – M/V ODYSSEA DIAMOND<sup>30</sup> located 2 burned life rafts (no persons on board).
- 0830 – CGC RAZORBILL commenced a Bravo search.
- 0840 – CG-6556<sup>31</sup> deployed a data marker buoy.<sup>32</sup>
- 1000 – Unified Command planning meeting was held. Dispersant aircraft on standby in Mississippi and Arizona.
- 1045 – CG-6016 commenced Charlie search.
- 1100 – Second attempt to shut the DWH Blowout Preventer failed.
- 1130 – CG-6556 and CG-6605 commenced Charlie searches.
- 1230 – Coast Guard Gulf Strike Team<sup>33</sup> personnel en route Houston, Texas, and New Orleans, Louisiana, for possible dispersant operations. Dispersant checklist was reported complete.
- 1243 – Deployed data marker buoy was relocated.

---

<sup>25</sup> CG-6016 is a Coast Guard HH-60J Jayhawk helicopter. The Jayhawk is a multi-mission, twin-engine, medium-range helicopter that performs various missions, including SAR, law enforcement, homeland security, marine environmental protection, military readiness, as well as cargo and personnel transport. CG-6016 is stationed at Coast Guard Aviation Training Center Mobile, Alabama.

<sup>26</sup> Extended search activities are accomplished in “epochs” of time. A search involving several facilities is planned and a search action plan with specific taskings for these facilities is promulgated. Planning for a subsequent search then begins so that it may be implemented quickly should the present search effort fail to locate the survivors. The two periods when facilities are on-scene would form two search epochs. Search epochs are designed with letters (A, B, C...) where a letter is assigned to each epoch in time sequence. The first planned search epoch is designated, “Alpha,” the second, “Bravo,” and so forth.

<sup>27</sup> CGC DECISIVE is a 210-foot Coast Guard Medium Endurance Cutter, homeported in Pascagoula, Mississippi.

<sup>28</sup> Coast Guard Dolphin helicopter stationed at Coast Guard Air Station New Orleans, Louisiana.

<sup>29</sup> 87-foot Marine Protector Class Coastal Patrol Boat.

<sup>30</sup> IMO Number: 951454700. This was a Good Samaritan that volunteered to assist in the search for survivors.

<sup>31</sup> Coast Guard Dolphin helicopter; Coast Guard Air Station New Orleans, Louisiana.

<sup>32</sup> Datum Marker Buoys (DMBs) are tools for determining total water current in a search area.

<sup>33</sup> The USCG Gulf Strike Team is one of 3 deployable special teams that make up the National Strike Force and is comprised of personnel who are specifically trained for response to hazards including oil spills and use of dispersants .

Appendix G | FINAL ACTION REPORT ON THE SAR CASE STUDY INTO THE  
MASS RESCUE OF PERSONNEL OFF THE MOBILE OFFSHORE  
DRILLING UNIT *DEEPWATER HORIZON*

---

Subj: FINAL ACTION REPORT ON THE SAR CASE STUDY INTO THE MASS RESCUE OF PERSONNEL OFF THE MOBILE OFFSHORE DRILLING UNIT DEEPWATER HORIZON 16106

- 1600 – S-92 helicopter commenced a Delta search.
- 1630 – CG-6508 and CG-2308 commenced Delta searches.
- 2100 – CGC ZEPHYR commenced an Echo search.

**April 22, 2010**

- 0600 – CGC PELICAN<sup>34</sup> commenced a Foxtrot search.
- 0620 – CG-2305<sup>35</sup> commenced a Foxtrot search.
- 0741 – CG-6540<sup>36</sup> commenced a Foxtrot search.
- 0935 – S-92 helicopter commenced a Foxtrot search.
- 1000 – CGC COHO<sup>37</sup> commenced a Foxtrot search.
- 1026 – DWH sank.
- 1205 – Phone conference conducted with Coast Guard liaisons in BP's Houston Incident Command Post to get updated plans on possible dispersant use.
- 1226 – Coast Guard Marine Safety Unit Morgan City, Louisiana, and Gulf Strike Team members assigned to conduct flight observations from Venice, Louisiana.
- 1300 – Eighth Coast Guard District Incident Management Team was activated.
- 1345 – Oil targeted for dispersant operations identified in overflight.<sup>38</sup>
- 1423 – CG-6540 and CG-2305 commenced Golf searches.
- 1534 – Coast Guard Marine Safety Unit Morgan City, Louisiana, Investigation Officer cross-referenced the DWH crew list (of missing personnel) with that of survivors witness/interview statements. Of the eleven (11) missing persons, seven (07) were identified as likely to be deceased by eyewitness accounts.

**April 23, 2010**

- 0700 – CG-6508 and CG-2301<sup>39</sup> commenced India search.
- 1000 – CGC COHO commenced an India search.
- 1615 – Eighth Coast Guard District Command Center recommended Active Search Suspension.

---

<sup>34</sup> 87-foot Marine Protector Class Coastal Patrol Boat.

<sup>35</sup> HC-144A Ocean Sentry fixed wing aircraft stationed at Coast Guard Aviation Training Center, Mobile, Alabama.

<sup>36</sup> Coast Guard Dolphin helicopter stationed at Coast Guard Air Station, New Orleans, Louisiana.

<sup>37</sup> 87-foot Marine Protector Class Coastal Patrol Boat.

<sup>38</sup> Based on recorded MISLE entries, 1,500 gallons of dispersants were applied in five (05) sorties between 1345 on April 22, 2010 and 0243 April 23, 2010.

<sup>39</sup> HC-144A Ocean Sentry fixed wing aircraft stationed at Coast Guard Aviation Training Center Mobile, Alabama.

Appendix G | FINAL ACTION REPORT ON THE SAR CASE STUDY INTO THE  
MASS RESCUE OF PERSONNEL OFF THE MOBILE OFFSHORE  
DRILLING UNIT *DEEPWATER HORIZON*

---

Subj: FINAL ACTION REPORT ON THE SAR CASE STUDY INTO THE MASS RESCUE OF PERSONNEL OFF THE MOBILE OFFSHORE DRILLING UNIT DEEPWATER HORIZON 16106

1853 – Coast Guard Eighth District suspended the active search for the unaccounted for DWH personnel.

**5. Opinions**

- a. From the time of initial notification of the Command Center, Eighth Coast Guard District to the suspension of the active search, watchstanders remained vigilant, and SRUs professionally executed a thorough search for the survivors of DWH.
- b. The U.S. Coast Guard SRUs that initially responded to the reports of distress were small boats and small cutters that have small crews and limited communications capabilities. These units rely primarily on voice communications over very high and high frequencies that are adequate. During the response to DWH, a more robust communications suite would have enhanced the communications and sharing of information, and coordination of SRUs.
- c. The SMC utilized CESM to calculate the functional and survival time of the missing personnel from DWH. The System Management and Engineering Facility (SMEF) Advisory number SAROPS-10-001 dated April 16, 2010, announced the release of the Probability of Survival Decision Aid (PSDA) as the survival model of choice. The release was four (04) days prior to DWH incident. The advisory did not mandate that units replace the CESM model, but rather announced a period of familiarization and beta testing. On June 22, 2010, the U.S. Coast Guard Director for Response Policy (CG-53) released an All Coast Guard (ALCOAST) message that required the use of PSDA and removed CESM. PSDA is a physiological based model of both heat and water loss for survivors immersed in water or out in open air. Consideration of these additional factors reflects an improvement over CESM because it predicts more realistic survival times. During the pendency of the DWH MRO, SMC was trained, experienced and most familiar with using CESM; and opted not to use this SAR case to test the newly rolled out PSDA. Accordingly, the use of CESM during the DWH MRO was both prudent and authorized based on the guidance of the SMEF Advisory of April 16, 2010.
- d. The fact that the SMC failed to document the completion of the search patterns marked as “Tentative” in the SAROPS Summary may cause the estimated cumulative POS to be inaccurate. The reliance of the SMC on using a single SLDMB as a source of current data combined with the failure to document search start and completion times in SAROPS may affect the cumulative POS and subsequent estimates of the most likely location of survivors.
- e. The decision to suspend the active search for survivors of the DWH was made by the SMC. This decision was based on the following facts as presented, appeared prudent and was consistent with policy in reference (a):
  - (1) The intense saturation of SRUs and excellent search conditions (winds & seas);
  - (2) The CESM that produced a functional time of 18.7 hours and a survival time of thirty one (31) hours;

Appendix G | FINAL ACTION REPORT ON THE SAR CASE STUDY INTO THE MASS RESCUE OF PERSONNEL OFF THE MOBILE OFFSHORE DRILLING UNIT *DEEPWATER HORIZON*

---

Subj: FINAL ACTION REPORT ON THE SAR CASE STUDY INTO THE MASS RESCUE OF PERSONNEL OFF THE MOBILE OFFSHORE DRILLING UNIT DEEPWATER HORIZON 16106

- (3) Twenty-two (22) parallel search patterns and four (04) creeping line searches were assigned covering an area of over 5,375 square miles;
  - (4) Efforts to raise the cumulative Probability of Success by continuing to search could not be significantly raised through the use of SAROPS;
  - (5) The violent and dangerous nature of the DWH explosion and ensuing mass conflagration; and
  - (6) The report by the Coast Guard Marine Safety Unit Morgan City, Louisiana, that provided eyewitness accounts that seven (07) of the eleven (11) missing persons were most likely killed in the initial explosion.
- f. During the execution of the SAR case, SAR checklists were not completed, search action plans were not documented and secure internet communications were not saved or otherwise memorialized anywhere. Contemporaneous documentation was available from MISLE<sup>40</sup> entries from watchstanders, SAROPS, SITREPS<sup>41</sup> and audio recordings<sup>42</sup>. There is no indication that the lack of documentation influenced the results of the case. However, lack of documentation hindered this immediate case study and may similarly hinder future case studies or investigations.
- g. Section 4.4.2.1., et seq., of reference (a) provides guidance for firefighting activities. Consistent with reference (a), the SMC did not conduct or coordinate firefighting efforts in support of lifesaving because it was presumed that there could be no survivors onboard the MODU DWH at the time the first SRUs arrived. This conclusion was reached based on the totality of the situation after considering several factors including; the intense radiant heat and flames reported from CG-6605 and other on-scene vessels, the inability for vessels or air assets to get within close proximity, and that the nearest assets to the MODU relayed that there were no survivors visible on the MODU. Review of the findings of fact indicates that all response efforts in regard to fire were concentrated on securing the fuel source. The firefighting and marine incident response did not hinder the SAR efforts.
- h. The decision to spray the dispersant was in accordance with policy and guidance in effect at the time of the DWH MRO. The Responsible Party elected to use dispersants because an area of dispersible oil was identified drifting towards land and the RRT authorized dispersant use in accordance with reference (b and c). The U.S. Coast Guard Federal On-Scene Coordinator (FOSC) concurred with the use of dispersants based on a decision that dispersant use could be coordinated to not hinder the active SAR efforts. The required checklist (which was completed in this case) directs the controller to maintain a lookout

---

<sup>40</sup> The Marine Information for Safety and Law Enforcement (MISLE) database is managed and used by the Coast Guard to store data regarding marine safety, security, environmental protection and law enforcement information.

<sup>41</sup> SITREPs are Situation reports used to pass key operational information in a timely manner, both up and down USCG organization.

<sup>42</sup> As of the date of this report, the official transcription of the audio recordings was not available.

Appendix G | FINAL ACTION REPORT ON THE SAR CASE STUDY INTO THE MASS RESCUE OF PERSONNEL OFF THE MOBILE OFFSHORE DRILLING UNIT *DEEPWATER HORIZON*

---

Subj: FINAL ACTION REPORT ON THE SAR CASE STUDY INTO THE MASS RESCUE OF PERSONNEL OFF THE MOBILE OFFSHORE DRILLING UNIT DEEPWATER HORIZON

16106

for marine life during the aerial deployment of dispersants.<sup>43</sup> There is no information from any source that suggests any of the unaccounted for personnel from the DWH were in the areas where dispersants were deployed or otherwise came into contact with dispersants.

6. **Actions.** Pursuant to the foregoing findings of facts and opinions, the following actions are necessary:
- a. Coast Guard Eighth District and subordinate Sectors should:
    - (1) Coordinate with industry representatives to discuss the DWH incident and evaluate industry contingencies for a mass evacuation from their MODU.
    - (2) Ensure SAR, mass rescue, and/or mass evacuation contingencies are incorporated into appropriate contingency plans.
  - b. Coast Guard designated SMCs should request a suitable command and control platform for tactical control during MROs.
  - c. SAR Coordinators shall emphasize to subordinates that documentation requirements in the U.S. Coast Guard Addendum to the United States National Search and Rescue Supplement (NSS) to the International Aeronautical and Maritime Search and Rescue Manual (IAMSAR), COMDTINST M16130.2E, are followed. Additionally, watchstanders and watch supervisors shall ensure case documentation and data entry are timely, accurate, and complete.
  - d. The National Search and Rescue School shall ensure students understand the effect that accurate search documentation in SAROPS has on the calculation of POS and subsequent estimates of the most likely location of survivors. The Office of Search and Rescue (CG-534) shall update reference (a) to expand the discussion of "Tentative" entries and their impact.
  - e. Expand Coast Guard Policy in the U.S. Coast Guard Addendum to the United States National Search and Rescue Supplement (NSS) to the International Aeronautical and Maritime Search and Rescue Manual (IAMSAR) for case file documentation of correspondence to include secure communications that occur during the prosecution of SAR cases.
  - f. The Office of Search and Rescue (CG-534) shall coordinate with the Office of Waterways Management (CG-541) to amend the Coast Guard's policy for marine firefighting on vessels contained in Marine Safety Manual, Vol. VI, Ports and Waterways Activities, COMDTINST M16000.11 (series), and provide expanded guidance to the SMC concerning coordination of firefighting efforts for vessel fires beyond the port environment.
  - g. The Office of Search and Rescue (CG-534) and the Office of Incident Management and Preparedness (CG-533) shall develop a policy that requires the FOSC to coordinate with

---

<sup>43</sup> While not explicitly referenced in the checklist it is reasonable to assume that the controller would also be looking out for PIWs.

**Appendix G | FINAL ACTION REPORT ON THE SAR CASE STUDY INTO THE  
MASS RESCUE OF PERSONNEL OFF THE MOBILE OFFSHORE  
DRILLING UNIT *DEEPWATER HORIZON***

---

Subj: FINAL ACTION REPORT ON THE SAR CASE STUDY INTO THE MASS RESCUE OF PERSONNEL OFF THE MOBILE OFFSHORE DRILLING UNIT DEEPWATER HORIZON 16106

the SMC prior to the use of dispersants during concurrent SAR and pollution response operations. Considerations for the use of dispersants during active SAR response should take a critical look at the area of dispersant use and carefully document and provide specific direction to dispersant controllers on procedures for identifying and avoiding the spraying of survivors.

#

Encl: (1) SAROPS SUMMARY

Distribution: COMDT (CG-534)  
COMDT (CG-533)  
COMDT (CG-541)  
LANTAREA (Ao/Acc)  
National SAR School  
CGD EIGHT (drm)

Appendix G | FINAL ACTION REPORT ON THE SAR CASE STUDY INTO THE MASS RESCUE OF PERSONNEL OFF THE MOBILE OFFSHORE DRILLING UNIT *DEEPWATER HORIZON*

---

ENCLOSURE (1)

## SAROPS Summary

### Case Properties

Case Name	DEEPWATER HORIZON
Status	ACTSUS
Opened By	[REDACTED]
Date Opened	210745Z APR 10
Closed By	os1 [REDACTED]
Date Closed	240107Z APR 10
<hr/>	
Unit Case Number	0087-10
MISLE Case Number	497499
MISLE Case URL	<a href="http://misle.osc.uscg.mil/msnweb/MSN_Case_Detail.asp?Case_ID=497499">http://misle.osc.uscg.mil/msnweb/MSN_Case_Detail.asp?Case_ID=497499</a>
<hr/>	
Location	45NM ESE OF SOUTH PASS, LA
Nature Of Distress	Mass Rescue Ops
Number Of Persons	126
Vessel/Aircraft ID	DEEPWATER HORIZON

### Run Properties

Case Name	DEEPWATER_HORIZON
Date	231402Z APR 10
Search Plan	JULIETT
Planner	[REDACTED]
Run Name	JULIETT_DEEPWATER_HORIZON1
Comments	
Status	Complete

### Search Objects

Type	PIW without PFD (Average)
Detection	
Capacity	
Length	1.00 FT
Beam	1.80 FT
Height	1.30 FT



**Appendix G | FINAL ACTION REPORT ON THE SAR CASE STUDY INTO THE  
MASS RESCUE OF PERSONNEL OFF THE MOBILE OFFSHORE  
DRILLING UNIT *DEEPWATER HORIZON***

---

ENCLOSURE (1)

**Leeway**

Rate (%) 1.10 %  
Average Div Angle 30.00 Deg

---

**Scenarios**

Name	Type	DST	Weight	Weight %
Scenario 1	LKP	210303Z APR 10	5	100%

---

**Hazards**

**No Hazards.**

---

**Completed Searches as of 232353Z APR 10**

Prefi x	SRU ID	Descript or	Type	CST	EST	% Com p	Track Length Search ed	Area Search ed	Review ed
A-3	HH60		PS	210900 Z APR 10	211159 Z APR 10	100%	229 NM	30 SQNM	Tentative
A-2	POMPAN O	POMPANO	PS	210900 Z APR 10	211656 Z APR 10	100%	81 NM	43 SQNM	Tentative
B-1	6605		PS	211200 Z APR 10	211459 Z APR 10	100%	230 NM	48 SQNM	Tentative
B-2	6508		PS	211200 Z APR 10	211459 Z APR 10	100%	229 NM	41 SQNM	Tentative
B-3	RAZORBI LL		PS	211330 Z APR 10	212325 Z APR 10	100%	101 NM	79 SQNM	Tentative
B-4	2308		PS	211300 Z APR 10	211629 Z APR 10	100%	446 NM	446 SQNM	Tentative
B-5	COBIA		CS	211300 Z APR 10	212257 Z APR 10	100%	102 NM	52 SQNM	Tentative
B-6	CGC		PS	211345	220042	100%	121 NM	50 SQNM	Tentative

**Appendix G | FINAL ACTION REPORT ON THE SAR CASE STUDY INTO THE  
MASS RESCUE OF PERSONNEL OFF THE MOBILE OFFSHORE  
DRILLING UNIT *DEEPWATER HORIZON***

---

ENCLOSURE (1)

	ZEPHYR			Z APR 10	Z APR 10				
<UNK >	CG 2308	B4-2308	PS	211400 Z APR 10	211729 Z APR 10	100%	446 NM	446 SQNM	Tentative
C-1	6010		PS	211545 Z APR 10	211844 Z APR 10	100%	230 NM	25 SQNM	Tentative
C-2	6556		PS	211630 Z APR 10	211929 Z APR 10	100%	229 NM	32 SQNM	Tentative
C-3	6605		PS	211630 Z APR 10	211929 Z APR 10	100%	229 NM	39 SQNM	Tentative
D-1	6608		PS	212130 Z APR 10	212314 Z APR 10	70%	134 NM	28 SQNM	Tentative
D-3	2308		CS	212130 Z APR 10	220029 Z APR 10	100%	381 NM	413 SQNM	Tentative
E-1	ZYPHER		PS	220300 Z APR 10	221050 Z APR 10	100%	80 NM	132 SQNM	Tentative
<UNK >	COUGAR	Cougar D search	PS	212100 Z APR 10	212259 Z APR 10	100%	153 NM	31 SQNM	Tentative
<UNK >	CG 2308	B4-2308 OFFSET	PS	211400 Z APR 10	211729 Z APR 10	100%	446 NM	446 SQNM	Tentative
F-2	HC144		PS	221120 Z APR 10	221559 Z APR 10	100%	892 NM	893 SQNM	Yes
F-1	HH65		PS	221241 Z APR 10	221449 Z APR 10	15%	34 NM	7 SQNM	Yes
F-3	87327	PELICAN	PS	221100 Z APR 10	221721 Z APR 10	75%	61 NM	41 SQNM	Yes
F-5	COUGAR HELO		CS	221435 Z APR 10	221559 Z APR 10	50%	115 NM	23 SQNM	Yes
F-4	87321	COHO	CS	221500 Z APR 10	230258 Z APR 10	100%	122 NM	53 SQNM	Tentative
G-1	2305		PS	221923 Z APR 10	230022 Z APR 10	100%	638 NM	682 SQNM	Tentative
H-1	CGC COHO		PS	231200 Z APR 10	232353 Z APR 10	100%	121 NM	111 SQNM	Tentative

**Appendix G | FINAL ACTION REPORT ON THE SAR CASE STUDY INTO THE  
MASS RESCUE OF PERSONNEL OFF THE MOBILE OFFSHORE  
DRILLING UNIT *DEEPWATER HORIZON***

---

ENCLOSURE (1)

I-1	65		PS	231200 Z APR 10	231459 Z APR 10	100%	229 NM	50 SQNM	Tentative
I-2	23		PS	231200 Z APR 10	231658 Z APR 10	100%	550 NM	1,105 SQNM	Tentative
I-3	CGC COHO		CS	231500 Z APR 10	231652 Z APR 10	100%	19 NM	26 SQNM	Tentative
<b>Total</b>							6,647 NM	5,375 SQNM	

**Leeway Winds**

**Source** EDS-NOGAPS  
**Confidence** low

D:\CASES\OTHER\HQJRFROST\CASES\DEEPWATER\_HORIZON\JULIETT\_DEEPWATER\_HORIZO  
N1\NOGAPS\_201042310512827\_67695\_94892.NC

**Surface Currents**

**Source** EDS-SKETCH  
**Confidence** low

D:\CASES\OTHER\HQJRFROST\CASES\DEEPWATER\_HORIZON\JULIETT\_DEEPWATER\_HORIZO  
N1\SKETCH\_20100423\_1418.NC

**Review**

**Simulator Mode** normal  
**Shoreline** Sticky

**Simulator POS Report as of SIM End Time ( 231600Z APR 10 )**

Search Object	Number Adrift	Number on Land	Conditional POS	Object Probability	Joint POS	Remaining Probability
PIW without PFD	5000	0	83%	100%	83%	17%

**Appendix G | FINAL ACTION REPORT ON THE SAR CASE STUDY INTO THE MASS RESCUE OF PERSONNEL OFF THE MOBILE OFFSHORE DRILLING UNIT *DEEPWATER HORIZON***

---

ENCLOSURE (1)

(Average)						
<b>TOTAL</b>	5000	0	--	100%	83%	17%

**Key:**

**Number Adrift:** Number of simulation particles adrift at 231600Z APR 2010.

**Number on Land:** Number of simulation particles on land at 231600Z APR 2010.

**Conditional POS:** Cumulative Probability to date of the search object being located, assuming it is the given type.

**Object Probability:** Likelihood a search object of the given type resulted from the distress incident (based on search object and scenario weighting).

**Joint POS:** Cumulative Probability to date of the search object resulting from the distress incident being the given type AND being found (equals Conditional X Object.)

**Remaining Probability:** Cumulative Probability to date of the search object resulting from the distress incident being the given type and remaining unlocated, considering all previous searches (equals Object - Joint.)

**Total Joint POS:** Cumulative Probability to date of finding any search object that is one of the given types (sum of all search object Joint POS values.)

**Total Remaining Probability:** Cumulative Probability to date that any search object described within the run remains to be found.

**SAROPS PLANNER:: On Scene Conditions**

What SRU types will be used?	What Sensors will be used?
Aircraft : YES	Visual :YES
Vessel : NO	NVG : NO
	Other : NO

**On Scene Weather (Visual)**

**Visibility**                    5.00 NM  
**Wind Speed**                12.00 KTS  
**Sea Height**                 3 FT  
**Cloud Ceiling**            4000 FT  
**Predicted/Observed**    Observed

**SAROPS PLANNER:: SRUs**

SRU	Type	CST	On Scene	Speed	Search Objects
-----	------	-----	----------	-------	----------------

**Appendix G | FINAL ACTION REPORT ON THE SAR CASE STUDY INTO THE  
MASS RESCUE OF PERSONNEL OFF THE MOBILE OFFSHORE  
DRILLING UNIT *DEEPWATER HORIZON***

---

ENCLOSURE (1)

ID			Endurance		Sweep Width	Search for	
						1: PIW witho	adrift
2301	FixedWing	231730Z APR 10	6 hrs	140 kts		n	n
65XX	Helo	231700Z APR 10	2 hrs	90 kts		n	n

**Search Objects Reference Key:**

1 - PIW without PFD (Average)

Plan the search to maximize POS for search objects that are neither adrift nor landed.

**SAROPS PLANNER:: Patterns**

Prefix	SRU ID	Descriptor	Track Length	Area	Type	Plan POS %	Eval POS %
J-1	2301		713 NM	764 SQNM	PS	3%	3%
J-2	65XX		153 NM	50 SQNM	PS	1%	1%
<b>Total</b>			866 NM	814 SQNM			4%
<b>Cumulative</b>			7,512 NM	6,189 SQNM			84%

**Key:**

**Plan POS%:** POS value for the Planner rectangle generated for a given SRU.

**Eval POS%:** The Evaluation POS value for the pattern assigned to a given SRU.

**Total POS%:** The combined POS for all SRUs for the given search epoch.

**Cumulative POS%:** The combined POS for all SRUs considering all search epochs.

**Note:** The Probability of Success values within this table are measured across all search objects, not just those specified to Planner for optimization.

**Search epoch:** JULIETT

**Planning POS Report as of SRU Completion Time ( 232329Z APR 2010 )**

**Appendix G | FINAL ACTION REPORT ON THE SAR CASE STUDY INTO THE  
MASS RESCUE OF PERSONNEL OFF THE MOBILE OFFSHORE  
DRILLING UNIT *DEEPWATER HORIZON***

---

ENCLOSURE (1)

<b>Search Object</b>	<b>Number Adrift</b>	<b>Number on Land</b>	<b>Conditional POS</b>	<b>Object Probability</b>	<b>Joint POS</b>	<b>Remaining Probability</b>
PIW without PFD (Average)	5000	0	84%	100%	84%	16%
<b>TOTAL</b>	5000	0	--	100%	84%	16%

**Key:**

**Number Adrift:** Number of simulation particles adrift at 232320Z APR 2010.

**Number on Land:** Number of simulation particles on land at 232320Z APR 2010.

**Conditional POS:** Cumulative Probability to date of the search object being located, assuming it is the given type.

**Object Probability:** Likelihood a search object of the given type resulted from the distress incident (based on search object and scenario weighting).

**Joint POS:** Cumulative Probability to date of the search object resulting from the distress incident being the given type AND being found (equals Conditional X Object.)

**Remaining Probability:** Cumulative Probability to date of the search object resulting from the distress incident being the given type and remaining unlocated, considering all previous searches (equals Object - Joint.)

**Total Joint POS:** Cumulative Probability to date of finding any search object that is one of the given types (sum of all search object Joint POS values.)

**Total Remaining Probability:** Cumulative Probability to date that any search object described within the run remains to be found.

### 1. Pre-Casualty

*DEEPWATER HORIZON* was an ultra-deepwater, dynamically positioned, column stabilized, semi-submersible, Mobile Offshore Drilling Unit (MODU). Construction began in December 1998, the keel was laid on March 20, 2000, and the MODU was delivered on February 23, 2001. *DEEPWATER HORIZON* was built by Hyundai Heavy Industries in Ulsan, South Korea. (CG Vessel Critical Profile; ABS *DEEPWATER HORIZON* Operations Manual; RMI-00068-78)

*DEEPWATER HORIZON* was commissioned by R&B Falcon, which later became part of Transocean, and was registered in Majuro, Marshall Islands at the time of the casualty. *DEEPWATER HORIZON* was originally flagged in Panama following construction, but changed flag states in 2005 to the Republic of the Marshall Islands (RMI). (CG Vessel Critical Profile; ABS *DEEPWATER HORIZON* Operations Manual; RMI-00068)

### September 13, 2000

The ABS Houston reviewed the Safety System design philosophy for the RBS8D Project “*DEEPWATER HORIZON*” that performs emergency detection and shutdown services for compliance with the IMO MODU Code (IMO Resolution A. 649). (TRN-HCEC-00027277-295)

### 2001

The ABS determined *DEEPWATER HORIZON* was built and complied with the ABS, “Rules for Building and Classing Offshore Drilling Units, 1997,” “Rules for Building and Classing Steel Vessels,” “Guide for Thrusters and Dynamic Positioning Systems,” “Guide for Certification of Drilling Systems,” “Guide for Certification of Cranes,” and “Automated Central Control Units.” (RMI-00117-124)

*DEEPWATER HORIZON* was subsequently issued ABS Class notations and symbols as follows:

A1, AMS, “Column Stabilized Drilling Unit,” CDS, DPS-3, ACCU. (RMI-00117-124)

### March 2001

Transocean’s *DEEPWATER HORIZON*’S Operations Manual<sup>471</sup> defined the Person in Charge based upon the vessel’s mode of operation.<sup>472</sup>

*Under normal operating conditions, when the vessel is on location and considered in the drilling or industrial mode, Transocean elects to nominate the Installation Manager as the Person in Charge (PIC).*

---

<sup>471</sup> An Operations Manual is required by the International Maritime Organization (IMO) Mobile Offshore Drilling Unit (MODU) Code, Chapter 14 and must be approved by the Flag Administration. 46 CFR 109.121 requires that the Operating Manual be approved by the Coast Guard.

<sup>472</sup> *DEEPWATER HORIZON* Operations Manual, Chapter 2.

*During transit or underway mode, Transocean elects to nominate the Master as the Person in Charge (PIC). (ABS DEEPWATER HORIZON Operations Manual, Section 2.1 - ABSDWH000061-63)*

### **June 5, 2001**

Under the Authority of the Government of the Republic of Panama, the ABS issued a MODU Safety Certificate (1989) for *DEEPWATER HORIZON* for a total number of one hundred-thirty persons. (TRN-HCEC-00027264-265)

### **August 19, 2001**

Under the Authority of the Government of the Republic of Panama, the ABS issued a MODU Safety Certificate (1989) for *DEEPWATER HORIZON* for a total number of one hundred fifty persons. (TRN-HCEC-00027271-272)

### **June 2, 2002**

Under the Authority of the Government of the Republic of Panama, the ABS issued a MODU Safety Certificate (1989) for *DEEPWATER HORIZON* for a total number of one hundred-forty persons after modifications to increase accommodation capacity. (TRN-HCEC-00027269-270)

### **September 27, 2002**

Under the Authority of the Government of the Republic of Panama, the ABS issued MODU Safety Certificate (1989) for *DEEPWATER HORIZON* for a total number of one hundred-fifty persons. (TRN-HCEC-00027271-272)

### **February 27, 2003**

Under the Authority of the Government of the Republic of Panama, the ABS issued MODU Safety Certificate (1989) for *DEEPWATER HORIZON* for a total number of one hundred-forty-six persons. (TRN-HCEC-00027266)

### **September 15, 2003**

The Eighth Coast Guard District (D8) issued policy for the alternative approval of Emergency Response Plans (ERPs) for the Gulf of Mexico (GOM) to D8 Officers in Charge of Marine Inspection (OCMIs).<sup>473</sup> (BP-HZN-MBI00002549)

---

<sup>473</sup> Coast Guard Eighth District Marine Safety Division, 16711/EEP Approval, September 15, 2003 encouraged each Officer-in-charge, Marine Inspection (OCMI) to exercise their authority under 33 CFR 140.15(a) and permit alternative procedures to those specified in 33 CFR Subpart N, for the submission and approval of Emergency Evacuation Plans (EEPs) under 33 CFR 146.140 and 146.210 provided the MODU was previously operating with the same OCMI zone, changes were minor and the plan was prepared by entities which have a proven their competency in preparing EEPs. Revised EEPs would be checked in the normal course of inspection. Initial review and approval for newly installed manned Outer Continental Shelf (OCS) facilities remained.



### December 2004 – July 29, 2005

*DEEPWATER HORIZON* was registered under the authority of the RMI having been previously registered with the Panamanian authority following completion of construction in 2001. The ABS verified adherence to their Classification Society Standards. (RMI-00112-147)

The RMI authorized Det Norske Veritas (DNV) and the ABS to act as Recognized Organizations (RO's) for conducting inspections and surveys for the purpose of issuing International Statutory and Classification Society Certificates. (RMI-00405-406)

### March 2, 2005

Mr. [REDACTED] and Ms. [REDACTED] were designated as the International Safety Management (ISM) Code Designated Person and Alternate respectively for *DEEPWATER HORIZON*. (RMI-405-406)

### March 27, 2005

Under the authority of the RMI, ABS inspector (Haynie) performed a flag state inspection of *DEEPWATER HORIZON* with the master (Marzolf) reviewing the inspection report. One deficiency was noted: Publication, 2001 International Convention for the Safety of Life At Sea (SOLAS) Manual needs to be onboard. (RMI-00169-173)

### August 16, 2005

The Coast Guard Marine Safety Unit (MSU) Morgan City conducted the annual Certificate of Compliance (COC) examination for *DEEPWATER HORIZON*. No discrepancies were noted. (CG Activity Report 2466860).

### January 2, 2006

Under the authority of the RMI, the ABS issued the flag state Verification and Acceptance Document under the provisions of the Guidelines for Vessels with Dynamic Positioning (DP) Systems certifying *DEEPWATER HORIZON* has been duly documented, surveyed, and tested in accordance with the Guidelines for Vessels with DP Systems (MSC/Cir. 645) and allowed to operate in DP Equipment Class Three (3). (RMI-00046-48)

Under the authority of the RMI, the ABS inspector (Gee) performed a flag state inspection of *DEEPWATER HORIZON* with the master (Marzolf) reviewing the inspection report. There were no deficiencies noted. (RMI-00164-168)

### June 11, 2006

Under the authority of the RMI, the ABS issued *DEEPWATER HORIZON* an International Maritime Organization (IMO) International Load Line Certificate, MODU Code Construction and Equipment Certificate (1989), Shipboard Elevator Certificate, and International Oil Pollution Prevention Certificate to expire February 28, 2011. (RMI-00030-38, 108)

**August 11, 2006**

Coast Guard MSU Morgan City conducted the annual COC examination for *DEEPWATER HORIZON*. The examination identified two items which were corrected during the visit: (1) provide valve position indicators for the bilge/ballast valves; and (2) provide a cover for the eyewash station on the Drill Floor. (CG Activity Report 2744163).

**January 1, 2007**

Under the authority of the RMI, the ABS inspector (Gee) performed a flag state inspection of *DEEPWATER HORIZON* with the master ( ) reviewing the inspection report. There were no deficiencies noted. (RMI-00160-163)

**August 7, 2007**

Coast Guard MSU Port Arthur conducted the annual COC examination for *DEEPWATER HORIZON*. During the course of the verification it was noted that the cable for the stern falls for Lifeboat #4 were broken. The crew indicated they were awaiting replacement parts later that week and that the ABS was scheduled to attend the vessel and verify the correction on August 13, 2007. The Coast Guard issued a discrepancy requiring *DEEPWATER HORIZON* to provide the Coast Guard with a copy of the ABS paperwork pertaining to the renewal of the falls and the associated testing. Corrections were to be completed by October 4, 2007. (CG Activity Report 2990305).

**October 4, 2007**

Coast Guard MSU Port Arthur conducted a deficiency check for *DEEPWATER HORIZON*. The vessel had one outstanding discrepancy from the Coast Guard's earlier annual examination for lifesaving and engineering deficiencies. The Coast Guard verified that the ABS had submitted its survey report certifying the load test for the Lifeboat #4 cables. The outstanding discrepancy was cleared. (CG Activity Report 3072937).

**December 4, 2007**

Under the authority of the RMI, ABS inspector ( ) performed a flag state inspection of *DEEPWATER HORIZON* with the master ( ) reviewing the inspection report. There were no deficiencies noted. (RMI-00156-159)

**April 10, 2008**

DNV completed the ISM Code Certification of Company Audit for Transocean Deepwater Drilling Company and issued the corresponding certificate having found no non-conformities and seven observations. (0251-JIT-DNV AUDIT; TRN-USCG-MMS-00043660-61)

### May 26, 2008

*DEEPWATER HORIZON* while located in the Gulf of Mexico (GOM) on the Outer Continental Shelf (OCS) in Mississippi Canyon Block 948 experienced a flooding condition of the starboard forward column. As reported, the casualty resulted in the evacuation of 77 non-essential personnel to two standby vessels. The flooding occurred as a result of the removal of a twelve-inch pipe approximately five feet in length earlier in the day from the seawater line, which could be crossed over to the ballast system. The pump had been electrically isolated, but the valves that protect the pump room from water ingress were not mechanically isolated. Due to a lack of communication, a valve in the system was opened allowing water ingress. (RMI-00182-195)

Transocean assembled an Emergency Support Team at its Park 10 Office and made subsequent notifications to the RMI, the ABS and the Coast Guard. (RMI-00182-195)

The casualty ultimately resulted in damages estimated to be \$920,000. (RMI-00182-195)

The ABS Surveyor attended the vessel on May 28, 2008 to conduct a damage survey and on June 2 and 3, 2008 to witness the repairs. Upon completion of the survey and documentation, the attending Surveyor did not exercise International Association of Classification Societies Procedural Requirement (PR) 17.<sup>474</sup>

### May 30, 2008

1236: The master (██████████) of *DEEPWATER HORIZON* made written notification to the RMI via e-mail restating the casualty and informing the return of the MODU to the drilling draft and attached RMI Form MI-109, Report of Vessel Casualty or Accident. (RMI-00189-196)

1500: Mr. ██████████, of the RMI Marine Investigations Division in Reston, Virginia, acknowledged the report delivered via e-mail, “The description of the casualty incident is duly noted. Let us know if there are any corrective safety measures relevant to this situation.”<sup>475</sup> (RMI-00189-196)

### August 7, 2008

1442: *DEEPWATER HORIZON* while located in the GOM on the OCS in Mississippi Canyon Block 948 experienced an equipment failure causing two main diesel engines (MDEs) to trip off-line resulting in a total loss of electrical power. As reported, the Power Management System and crew stabilized the situation within two minutes and power and propulsion were restored. (RMI-00182-183)

---

<sup>474</sup> International Association of Classification Societies (IACS) Procedural Requirement (PR) No. 17 is an instrument to ensure that the Organization responsible for the issuance of the Safety Management Certificate (SMC) is notified when deficiencies relating to possible Safety Management System (SMS) failures are identified by a surveyor. As noted on the PR 17, “This Procedural Requirement applies from 1 July 2009.” However, the American Bureau of Shipping (ABS) Form template used to document the survey clearly identifies PR No. 17.

<sup>475</sup> In a letter to the Joint Investigation Team (JIT) dated December 5, 2010, the Republic of the Marshall Islands (RMI) advised that it was not required to conduct an investigation in accordance with the International Maritime Organization (IMO) Casualty Code.

**August 11, 2008**

1429: The master ( [REDACTED] ) of *DEEPWATER HORIZON* made written notification to the RMI via e-mail on Form MI-109, Report of Vessel Casualty or Accident attached. (RMI-00180-181)

1650: Mr. Nelson, of the RMI Marine Investigations Division in Reston, Virginia, acknowledged the report of the loss of electrical power and inquired whether the ABS had been informed of the occurrence and if a possible cause of the circumstance was identified. (RMI-00180-181)

**August 12, 2008**

0849: The master ( [REDACTED] ) of *DEEPWATER HORIZON* responded to Mr. Nelson and informed him, "The chief engineer notified ABS and they said they did not need to get involved with this situation. But we will keep them advised of any changes we encounter during the investigation." The master ( [REDACTED] ) reported preliminary finding of a governor malfunction on the #3 MDE and that Wartsila representatives were arriving to help investigate. The master ( [REDACTED] ) reported plans to replace the actuator and governor drive gear amounting to \$13,000 in parts. (RMI-00180-181)

1131: Mr. Nelson acknowledged the master's ( [REDACTED] ) e-mail and requested the results of the examination.<sup>476</sup> (RMI-00180-181)

**October 15, 2008**

The Coast Guard MSU Morgan City conducted the annual COC examination for *DEEPWATER HORIZON*. No discrepancies were noted. (CG Activity Report 3378271).

**November 2008**

A Transocean representative delivered the failed Woodward governor, identified as the cause of the August loss of electrical power to Wartsila. The Wartsila inspection revealed that the governor was more than 15,000 hours past its recommended maintenance period. (WART-TO-10178342)

**December 7, 2008**

Under the authority of the RMI, ABS inspector ( [REDACTED] ) performed a flag state inspection of *DEEPWATER HORIZON* with the master ( [REDACTED] ) reviewing the inspection report. There were no deficiencies noted. (RMI-00152-155)

**March 19, 2009**

The ABS conducted the Dry Dock Survey Portion of *DEEPWATER HORIZON*'s Annual Class Survey Report while the vessel was dynamically positioned in the Keathly Canyon Block 102 area in the Gulf of Mexico for a six-month Underwater Inspection in Lieu of Dry-Dock

---

<sup>476</sup> Ibid.

(UWILD) survey as noted. The UWILD extension survey was a general examination of the vessel's structure above the water line including the upper hull column and areas as accessible in the moon pool. This included verifying that all safety related items throughout the MODU were carried out and found to be satisfactory. All watertight doors throughout the MODU were examined as were the pump rooms, thruster rooms, tunnels, sea chests, strainers and overboard piping systems; all were found to be satisfactory. The UWILD extension survey was approved with a new UWILD date of September 30, 2009. (ABS Class Survey Report of March 20, 2009; RMI-00227-231)

### **April 16, 2009**

DNV completed its Annual Survey of the Transocean Deepwater Drilling Company and issued its findings. DNV identified one non-conformity and eight observations. The non-conformity related back to the external ISM Code Audit that was conducted for the *TRANSOCEAN DRILLER* which identified eight non-conformities and two observations. The non-conformity related to the Corrective Action Plan (CAP) for the eight non-conformities, in that there was no evidence that the CAP had ever been completed. (0252-JIT-DNV-AUDIT; TRN-USCG-MMS-00043666-69)

### **June 27, 2009**

Coast Guard MSU Port Arthur conducted the annual COC examination for *DEEPWATER HORIZON*. No discrepancies were noted. The new COC amended the number of required Lifeboatmen from four to six based upon reconsideration of the number of lifeboats (4) and life rafts (2). (CG Activity Report 3513781).

### **August 4, 2009**

Triton Hungary Asset Management Limited Liability Company (LLC) requested permission of the RMI, International Registries Inc. to sell *DEEPWATER HORIZON* to Triton Asset Leasing GMBH. (RMI-00099)

### **August 17, 2009**

Triton Hungary Asset Management Limited Liability Company (LLC) sold *DEEPWATER HORIZON* to Triton Asset Leasing GMBH for the total price of \$10 dollars (US) and other good and valuable consideration. (RMI-00089-92)

### **August 18, 2009**

The RMI granted permission for the sale of *DEEPWATER HORIZON* to Triton Asset Leasing GMBH. (RMI-00071)

### **September 13-17, 2009**

The BP MODU Audit Group performed a follow-up MODU and Marine Assurance Audit of *DEEPWATER HORIZON*. The guidelines and results of the audit were captured in the Marine

## Appendix H | CRITICAL EVENTS TIMELINE

---

Audit, Common Marine Inspection Document (CMID) and a CMID Annex (BP requirements for Mobile Offshore Drilling Units (MODUs). (BP-HZN-MBI00136211-00136270) (BP-HZN-MBI00170612-00170669; BP-HZN-MBI00170553-00170611)

### September 17, 2009

The RMI documented the sale and re-registry of *DEEPWATER HORIZON* under the RMI and the ownership of Triton Asset Leasing GMBH of Switzerland. (RMI-00061-77)

The RMI issued a provisional Certificate of Registry and other official forms and publications including a Minimum Safe Manning Certificate (MSMC) (Form Rev. 1/02) for Schedule A, Self-Propelled MODU. (RMI-00061-68)

Mr. Jimmy Moore, Director of Quality Health, Safety and Environment (QHSE), and Mr. Gary Butler, Managing Director Triton Asset Leasing GMBH, were designated as the ISM Code and International Code for the Security of Ships and Ports Facilities (ISPS) Designated Person and Alternate, respectively, for *DEEPWATER HORIZON*. (RMI-00061-70)

### October 4, 2009

MODU *MARIANAS* moved on to location at Mississippi Canyon Block 252 to commence drilling operations on the Macondo Well. (BP-HZN-MBI00020885; Testimony [REDACTED] 8/24/2010, p 17)

### October 7, 2009

The Macondo Well was officially spudded by the *MARIANAS*. (BP-HZN-MBI00020451)

### October 19, 2009

At Transocean's Quarterly Health, Safety and Environment (QHSE) Steering Committee Meeting, Mr [REDACTED], Transocean International Safety Management (ISM)/International Port and Ship Security (ISPS) Manager, reported "*Meeting flag state Minimum Safe Manning requirements continues to be an issue; Records management of required ISM/ISPS documents and certificates remains to be a challenge; and overall understanding of ISM and ISPS requirements beginning to improve as result of audit process, but further improvement still needed.*" (TRN-USCG-MMS-00039100)

### December 14, 2009

The ABS commenced *DEEPWATER HORIZON's* Annual Statutory Survey. The surveyor noted the following discrepancies needed to be corrected: (1) the Oily Water Separator (OWS) piping on the starboard aft column at the 28.5 m (92 ft) level was corroded and fitted with multiple soft patches and hose clamps. The surveyor recommended repairs prior to completion of the Annual International Oil Pollution Prevention Survey; (2) the surveyor noted that the gross tonnage information on the Long Range Identification and Tracking (LRIT) Conformance Test report was incorrect in that the report listed the net tonnage rather than the gross tonnage. The surveyor

recommended the correction of the error by the completion of the Annual MODU Survey; (3) the surveyor noted that both the port and the starboard crane and hydraulic systems were found to have excessive oil leaks, to the point of creating a fire hazard, and the auxiliary line on the starboard crane was inoperable; and that the starboard crane was giving alarms during normal operations. The surveyor recommended correction prior to the completion of the Annual Cargo gear survey; and, (4) the surveyor noted that the elevators on all four columns on board were in the process of being upgraded with newer sensors and control systems. No ABS approval for such upgrades was found on board. It was also noted that the starboard forward elevator was damaged and inoperable. Plans were in place to remove and repair the elevator. The surveyor recommended correction of the above item before completion of the Elevator Survey. (ABS Statutory Survey Report of December 18, 2009)

### **December 14, 2009**

The ABS commenced *DEEPWATER HORIZON's* Annual Class Survey. The surveyor noted the following items needed correction: (1) the surveyor found the discharge spool on the sea water service pump #8 had a pinhole leak in way of a flange weld with a steady stream in the #8 Thruster Room; (2) the surveyor found the lube oil (L/O) low pressure alarm tripping device on the #5 main generator engine (MGE) was not working as intended. The engine failed to trip upon simulated loss of oil pressure at the sensor; (3) the surveyor found the piping on the MSD skid on the starboard forward column at the 24 meter level was found to have excessive corrosion and sections of soft patches; (4) the surveyor found that the #3 and #4 Thruster Rooms had excessive oil and grease in the bilges; (5) the surveyor found that the #3 thruster cooling water heat exchanger was leaking water; (5) the surveyor found that the #2 thruster was taken out of service due to its inability to operate as intended. The manufacturer's representative was on board examining the electric motor, however; an exact cause was not found by the end of the surveyor's visit. The surveyor also noted that the vessel's preventative maintenance plan requires oil samples of the thrust lube and hydraulic system to be taken and evaluated every quarter. The on board records showed that the last time samples were taken was in October of 2008. The thrusters were examined and tested as necessary and found to be satisfactory for intended service. (ABS Class Survey Report of December 18, 2009)

### **December 17, 2009**

Under the authority of the RMI, ABS inspector ( ) performed a flag state inspection for *DEEPWATER HORIZON* with the master ( ) reviewing the inspection report. There were no deficiencies noted. (RMI-00152-155)

### **January 2010**

*DEEPWATER HOZION* Emergency Evacuation Plan (EEP) for Mississippi Canyon Block 252 was issued and dated January 2010. (BP-HZN-MBI00002516)

**January 30, 2010**

*DEEPWATER HORIZON* moved on to Mississippi Canyon Block 252 to re-enter the Macondo Well. (TRN-USCG-MMS-00026112-116; BP-HZN-MBI00020368; BP-HZN-MBI00013592-595; Testimony [REDACTED] 5/28/2010, pp 10-12)

**February 23, 2010**

The ABS conducted a follow-up of *DEEPWATER HORIZON's* Annual Statutory Survey. The surveyor noted the following outstanding items had been correct from the previous visit: (1) all items concerning the cargo gear operations had been corrected, including faulty alarm sensor, the whip line was retested after repairs on the gross overload protection block (replaced) and the excessive oil was clean with new drip pans having been installed to reduce the amount of oil collected; (2) the LRIT Conformance Report was run and the gross tonnage error was corrected; and (3) repairs to the OWS piping were examined, tested and considered satisfactory. (ABS Statutory Survey Report of February 23, 2010; RMI-00207-211)

**March 10-15, 2010**

An internal ISM Code audit of the Transocean Corporate Office was conducted during the above period. The primary objective was to assess Transocean's compliance with the ISM Code. The audit identified six observations and no non-conformities. The audit specifically noted the need to ensure that previously issued Corrective Action Plans (CAP) were completed citing the non-conformity on the *TRANSOCEAN DRILLER* that was not resolved in accordance with the CAP. (0253-JIT-TO-ISM-AUDIT; TRN-USCG-MMS-00043694-67)

**April 1-14, 2010**

ModuSpec USA, INC. performed a Rig Condition Assessment of the *DEEPWATER HORIZON*. The End-of-Inspection Meeting Document included a listing of those who attended : Transocean Team Leader ([REDACTED]) Offshore Installation Manager ([REDACTED]) Master ([REDACTED]) Chief Engineer ([REDACTED]) Electrical/Electronics Supervisor ([REDACTED]) Mechanical Supervisor ([REDACTED]) and Senior Subsea ([REDACTED]) (TRN-USCG\_MMS-00038609-00038609)

**April 5, 2010**

Transocean issued Well Operations Group Advisory, HQS-OPS-ADV-09, titled: MONITORING WELL CONTROL INTEGRITY OF MECHANICAL BARRIERS. (TRN-USCG-MMS-00042595)

**April 5, 2010**

Mr. [REDACTED] reported to *DEEPWATER HORIZON* and assumed the duties and responsibilities of the offshore installation manager (OIM). (Testimony [REDACTED] 5/27/2010, p 8)



### April 14, 2010

Transocean issued Well Operations Group Advisory, NRS-OPS-ADV-008, titled: LOSS OF WELL CONTROL DURING UPPER COMPLETION. The Advisory provided the investigative results following gas entering another MODU's riser resulting in 11.1 days of lost time and costs of approximately £5.2M including a significant loss of reputation to Transocean. (TRN-USCG-MMS-00043223)

### April 15, 2010

BP relieved one of two of the well site leaders assigned to *DEEPWATER HORIZON* to reportedly attend a scheduled well control school. Mr. [REDACTED] was transferred from the *THUNDER HORSE* as Mr. [REDACTED] relief. Mr. [REDACTED] had no prior experience as the well site leader on *DEEPWATER HORIZON*.<sup>477</sup> (Testimony [REDACTED] 7/20/2010, pp; 15-16; Testimony Guide, 7/22/2010, pp 103-113)

### April 16, 2010

Ms. [REDACTED] reported to *DEEPWATER HORIZON* and was assigned the duties and responsibilities of dynamic positioning officer (DPO).<sup>478</sup> (Testimony [REDACTED] 10/5/2010, p 10)

Mr. [REDACTED] reported to *DEEPWATER HORIZON* and was assigned the duties and responsibilities of senior dynamic positioning officer (SDPO). (Testimony [REDACTED] 10/5/2010, p 126)

Mr. [REDACTED] reported to *DEEPWATER HORIZON* and was assigned the duties and responsibilities of chief mate. (Testimony [REDACTED] 5/27/2010, p 248)

### April 19, 2010

1142 – 1201: *DAMON B. BANKSTON* held a job safety analysis followed by a man overboard / fast rescue craft (FRC) drill. The crew launched and operated the FRC for 8 minutes and then recovered it. The FRC crew was comprised of [REDACTED] as the coxswain and [REDACTED] as the rescuer. (*BANKSTON* Log; Testimony [REDACTED] 5/10/2010, pp 174-176; Testimony [REDACTED] 5/11/2010, p 234; Testimony [REDACTED] 5/11/2010, pp 89-91)

## 2. Day of the Casualty

### April 20, 2010

---

<sup>477</sup> Mr. [REDACTED] reported to the *DEEPWATER HORIZON* only five days before the casualty and had never served on the rig before. However, during the course of the investigation there was no evidence that the timing of his arrival contributed to the casualty.

<sup>478</sup> The Dynamic Positioning Officer (DPO- [REDACTED] the Senior Dynamic Positioning Officer (SDPO- [REDACTED] and the Chief Mate [REDACTED] all reported for the beginning of their hitch 4 days prior to the casualty. All of the crewmembers had previously completed hitches on the *DEEPWATER HORIZON* in the same capacity. During the course of the investigation, there was no evidence the timing of their arrival contributed to the casualty.

## Appendix H | CRITICAL EVENTS TIMELINE

---

1200: Mr. [REDACTED] assumed the duties and responsibilities of SDPO in the CCR of *DEEPWATER HORIZON*. (Testimony [REDACTED] 10/5/2010, p 148)

1200 – 1430: Captain [REDACTED] reported to *DEEPWATER HORIZON* and assumed the duties and responsibilities of master. (Testimony [REDACTED] 5/27/2010, p 182)

1231: *DAMON B. BANKSTON* was dynamically positioned alongside *DEEPWATER HORIZON* and ready for cargo operations. (*BANKSTON* Log; Testimony [REDACTED] 5/10/2010, pp 176-182; Testimony [REDACTED] 5/11/2010, p 234)

1328: The mud hose from *DEEPWATER HORIZON* to *DAMON B. BANKSTON* was onboard *DAMON B. BANKSTON*. (*BANKSTON* Log; Testimony [REDACTED] 5/10/2010, pp 176-182)

1328 – 1717: Mud was transferred from *DEEPWATER HORIZON* to *DAMON B. BANKSTON*. Approximately 3,100 barrels (BLS) were transferred, although an exact amount was never determined and the flow was not monitored by any gauging. (Testimony [REDACTED] 5/10/2010, pp 176-182; Testimony [REDACTED] 5/11/2010, pp 245-246; Testimony [REDACTED] 5/11/2010, pp 94-97)

*DAMON B. BANKSTON* remained alongside *DEEPWATER HORIZON* after receiving liquid mud from *DEEPWATER HORIZON*. The transfer was completed; *DAMON B. BANKSTON* was standing by while the transfer hoses remained connected. (*BANKSTON* Log; Testimony [REDACTED] 5/10/2010, p 182; Testimony [REDACTED] 5/11/2010, pp 245-246; Testimony [REDACTED] 5/11/2010, pp 94-97)

1430: Mr. [REDACTED] BP Vice President of Drilling and Completion for the GOM; Mr. [REDACTED] BP Drilling Operations Manager for Exploration and Appraisal for the GOM; Mr. [REDACTED] Transocean Performance Manager for Operations and Mr. [REDACTED] Transocean Performance Manager for Assets arrived on board *DEEPWATER HORIZON* to conduct a leadership team visit. As a first time visitor to the *DEEPWATER HORIZON*, Mr. [REDACTED] attends a one hour orientation. (Testimony [REDACTED] 8/26/2010, pp 354-360; Testimony [REDACTED] 5/29/2010, pp 163-169; Testimony [REDACTED] 8/23/2010, p 442)

1600: The Transocean and BP leadership team visitors began their guided tour of *DEEPWATER HORIZON*. (Testimony [REDACTED] 8/26/2010, p 360)

1700: The leadership team toured the Drill Shack on *DEEPWATER HORIZON*. Approximately twelve total persons were in the Drill Shack including the drill crew. (Testimony [REDACTED] 8/23/2010, p 443)

Mr. [REDACTED] remained on the Drill Floor as the leadership team continued their tour of *DEEPWATER HORIZON* because they were having a “little trouble with the Annular holding.” (Testimony [REDACTED] 5/27/2010, p 25)

1730: *DEEPWATER HORIZON* chief engineer ([REDACTED]) noted that there were some issues with the well. *DEEPWATER HORIZON* personnel stopped pumping mud to the *BANKSTON* due to

## Appendix H | CRITICAL EVENTS TIMELINE

---

the dinner break. (Sperry Sun Data; Testimony ██████████ 7/19/2010, pp 33-34; Testimony ██████████ 8/23/2010, p 443)

1730 - 1745: The leadership team completed their tour of *DEEPWATER HORIZON*. (Testimony ██████████ 8/26/2010, p 363)

1800: Ms. ██████████ assumed the duties and responsibilities of DPO in the CCR of *DEEPWATER HORIZON*. (Testimony ██████████ 10/5/2010, p 13)

1800-1900: The BP Transocean leadership team visitors attended dinner in the Galley. The well site leader (██████████) came to BP VP for Drilling and Completion (██████████) at dinner and asked if he wanted him to attend the 1900 meeting. The BP VP for Drilling and Completion said, “No, we’re not rolling out any new material.” and excused him from the meeting. (Testimony ██████████ 8/26/2010, pp 360-364; Testimony ██████████ 5/29/2010, pp 179 & 200)

1900: The leadership meeting began. (Testimony ██████████ 8/26/2010, p 364; Testimony ██████████ 5/29/2010, p 172)

1900: *DEEPWATER HORIZON* chief engineer (██████████) attended the leadership meeting with all supervisors and BP and Transocean managers. The leadership meeting reportedly lasted until approximately 2100 - 2115. At the conclusion, chief engineer (██████████) departed for his room. (Testimony ██████████ 7/19/2010, p 34)

2045 – 2100: The leadership meeting involving BP and Transocean senior management and all supervisors on *DEEPWATER HORIZON* concluded. (Testimony ██████████ 8/26/2010, p 365; Testimony ██████████ 8/23/2010, p 444)

2045: BP and Transocean senior management (██████████ ██████████) and ██████████ arrived in the CCR of *DEEPWATER HORIZON* to get a tour and practice on the DP simulator. (Statement ██████████ 4/21/2010; Testimony ██████████ 8/23/2010, p 446; Testimony ██████████ 8/26/2010, p 366.)

2130: The chief mate (██████████) on *DEEPWATER HORIZON* visited the Drill Floor and heard the on-watch tool pusher and driller (Anderson & Curtis) discussing differential pressure. (Statement ██████████ 4/21/2010)

2140-2150: The chief electrician (██████████) secured the electricity to the #2 pump by locking out/tagging out the electricity so a pump man, AD and two roughnecks (Kemp, Roshto, Clark, Weise), could replace a pressure relieving device (aka, pop-off valve) located on the #2 mud pump. After completing the pump repair he then de-isolating the electricity. Shortly thereafter, he heard a noise of high pressure, felt the rig vibrate and heard a loud boom from the direction of the mud pump room. (Statement ██████████ 4/21/2010; Testimony ██████████ 5/27/2010, pp 335-336)

2145: The mate (██████████) on-watch on board the Bridge of *DAMON B. BANKSTON* observed “outflow” under the MODU and received a radio message from *DEEPWATER HORIZON* indicating a well control problem. (██████████ Statement 4/21/2010; Testimony ██████████ 5/11/2010, pp 228-232)

## Appendix H | CRITICAL EVENTS TIMELINE

---

2145-2150: While in his unit, Sperry Sun mud logger (██████) saw his well monitors start shaking, heard a loud whistling sound and the sound of rain falling on his unit. Next, he smelled gas and observed his unit shutting down, and saw fire between his unit and the sample collection unit. He noticed his air conditioners coils on fire, the electrical breaker box inside his unit start arcing and sparking and then felt and heard a loud explosion. (Testimony ██████ 12/7/2010, pp 62-64, 102, 137-138)

2148: According to the witnesses, the first explosion on *DEEPWATER HORIZON* occurred; the crane operator (██████) believes the degasser (tank) exploded, which was stored on the motor shed, starboard side of the derrick. "...and that started the first fire." This is the same area that the chief mate (██████) on the *DAMON B. BANKSTON* reported seeing the explosion. (Testimony ██████ 5/29/2010, pp 9-12, 15-16; Testimony ██████ 5/11/2010, pp 238-243)

2150: The OIM (██████) was in his stateroom 228A on the Second Deck of *DEEPWATER HORIZON*. (Testimony ██████ 5/27/2010, p 3)

2150: The on-watch assistant driller (Curtis) called the senior tool pusher (██████) and told him "we have a situation." "The well is blown out." "We have mud going to the crown." The on-watch assistant driller (Curtis) was asked if the well was shut in and he indicated that "Jason is shutting it in now." (Testimony ██████ 5/28/2010, pp 283-289; Testimony ██████ 5/28/2010, pp 180-182)

2150: The on-watch tool pusher (Anderson) called the well site leader (██████) and informed him, "We're getting mud back, I (sic) diverting returns to gas buster." (0268-██████ interview notes, BP-HZN-MBI00021406-432)

2150: *DEEPWATER HORIZON* jolted. Personnel on the Drill Floor notified the DPO, "we are under a well control situation." The Engine Control Room (ECR) called the DPO to inquire into the situation and was told "we were under a well control situation." An explosion occurred followed by combustible gas alarms in the Shaker House and Drill House were received and acknowledged which was followed by all of the combustible gas alarms sounding. A second explosion occurred followed by a loss of electrical power. (Statement ██████ 4/21/2010; Testimony ██████ 10/5/2010, pp 18-19; Statement ██████ 4/21/2010; Testimony ██████ 10/5/2010, pp 150-151)

2150-2155: The Sperry Sun mud logger (██████) testified "Everything in the back [deck] exploded." "And then the flames went away from me where I was at and it was shooting straight up to over the derrick." (Testimony ██████ 10/5/2010, p 14; Testimony ██████ 5/28/2010, pp 283-289; Testimony ██████ 5/27/2010, pp 263-266, 271; Testimony ██████ 5/29/2010, pp 9-16; Testimony ██████ 12/7/2010, pp 63-67, 103-109; Statement ██████ 4/21/2020)

2151-2155: The chief mate (██████) activated the general alarm in the CCR on *DEEPWATER HORIZON* before exiting. He later returned and reported an uncontrolled fire and advised the master (██████) to abandon. (Testimony ██████ 10/5/2010, p 19; Testimony ██████ 10/5/2010 p 152, Testimony ██████ 5/28/2010, p 145)

## Appendix H | CRITICAL EVENTS TIMELINE

---

2152 - 2156: The subsea supervisor ( ) arrived in the CCR and told the master ( ) that he was going to activate the emergency disconnect system (EDS). The master told him "Calm down. Don't activate the EDS." He proceeded to the EDS panel and saw the well site leader ( ) standing next to the panel. The well site leader said, "They got the well shut in." The subsea supervisor said, "Yeah, the lower annular closed, the vertical closed and I had alarms going off, lower accumulator alarm." Without the master's knowledge, the subsea supervisor and the well site leader activated the EDS. The subsea supervisor noted the gallon count showed "no flow", which indicated the lower marine riser package (LMRP) had not retracted. At the same time, the subsea supervisor overheard the master talking with Transocean's operations manager-performance asking, "Could we EDS?" The operations manager-performance said, "Yeah, You hadn't already." The Captain then said to the subsea supervisor, "We can EDS." He replied, "I already did." (Statement ( ) 4/23/2010; Testimony ( ) 5/28/2010, pp 122-124,144-145, 175-176)

The chief engineer ( ) arrived in the CCR and overheard the master ( ) screaming at the on-watch DPO ( ) for pushing the distress button. The main diesel engines (MDEs) were not starting back up. The chief engineer ( ) asked the subsea supervisor ( ) if the EDS functioned, but was told permission was needed to function it. The Transocean operations manager-performance ( ) was asked for said permission and informed them to function (initiate) the EDS. Someone then indicated only the OIM could approve the action. (Statement ( ) 4/21/2010)

2153: Crew members on *DAMON B. BANKSTON* heard and observed a large release of air/gas followed by mud raining down on the afterdeck of the *BANKSTON B. BANKSTON*. The master ( ) of *DAMON B. BANKSTON* contacted *DEEPWATER HORIZON* CCR via VHF Channel 66 and was advised that *DEEPWATER HORIZON* was having trouble with the well and ordered them to move to a 500 meter standby position. This was immediately followed by an explosion on board *DEEPWATER HORIZON*. The transfer hoses were manually released and *DAMON B. BANKSTON* moved away. (Statement ( ) 4/21/2010; *BANKSTON* Log; Testimony ( ) 5/10/2010, p 183; Testimony ( ) 5/11/2010, pp 234-243; Testimony ( ) 5/11/2010, pp 99-100)

2155 – 2200 The OIM ( ) arrived in the CCR and told the subsea supervisor ( ) to go ahead and EDS (Emergency Disconnect System). (Testimony ( ) 5/27/2010, pp 11, 68)

The BP VP for Drilling and Completions ( ) heard the master ( ) ask permission of the OIM ( ) to EDS. (Testimony ( ) 8/26/2010, p 440)

2156 – 22:04:47 *DEEPWATER HORIZON* issued a Digital Select Calling (DSC) Alert which was then relayed to the Eighth Coast Guard District Command Center via Maritime Rescue Coordination Center Mumbai (India), Ministry of Infrastructure and Transportation, Italian Coast Guard. Coast Guard Sector Mobile, Alabama received a Distress Alert via the High Frequency (HF) site. (SAR Case Report; Testimony ( ) 5/11/2010, p 105)

The OIM ( ) went to the lifeboat station to check out the damage to ensure the lifeboats were safe to load personnel. (Testimony ( ) 5/27/2010, p 11)

## Appendix H | CRITICAL EVENTS TIMELINE

---

The chief engineer ( [REDACTED] ) after determining that a change-of-command from the OIM ( [REDACTED] ) to the master ( [REDACTED] ) had occurred, asked permission from the master ( [REDACTED] ) to send a party to attempt to start the standby generator. The master ( [REDACTED] ) agreed and the chief electronics technician ( [REDACTED] ), the chief engineer ( [REDACTED] ) and the motorman ( [REDACTED] ) departed to the standby generator room in an attempt to start it and regain electrical power and energize the onboard fire pumps. (Statement [REDACTED] 4/21/2010; Testimony [REDACTED] 10/5/2010, pp 152-153, 165-166; Testimony [REDACTED] 8/23/2010, p 478; Testimony [REDACTED] 5/28/2010, pp 122-123)

2200: The on-watch DPO ( [REDACTED] ) reportedly activated the general alarm (GA) and the on-watch SDPO ( [REDACTED] ) made an announcement using the public address (PA) system to alert personnel to report to their emergency stations and the lifeboats. An announcement was made over the PA system of “This is not a drill, [Report] to muster at your emergency stations.” (Testimony [REDACTED] 10/5/2010, p 152; Testimony [REDACTED] 7/19/2010, p 57)

A mud engineer ( [REDACTED] ) heard the announcement “fire, fire, fire, report to your secondary muster station. Do not go outside.” The mud engineer ( [REDACTED] ) also testified that his secondary muster station, the Galley, was completely collapsed. After making his way to the Galley, he waited for about ten seconds with the others trying to muster until they noticed the door leading to the Lifeboat Deck was open. He and the others made their way to the Lifeboat Muster Deck where they found the off-watch assistant driller ( [REDACTED] ) attempting to take a muster. (Testimony [REDACTED] 5/28/2010, pp 220-236)

The roustabout ( [REDACTED] ), chief mate ( [REDACTED] ), mud engineer ( [REDACTED] ) and the driller ( [REDACTED] ) along with others attempted to report and execute their Fire and Emergency Stations as required by the announcement. After reporting to the Fire Team Muster area, the driller noticed that there was nobody around and that the fire in the derrick was too big of a fire to fight and went to his lifeboat muster station. (Testimony [REDACTED] 5/29/2010, p 105)

The crane operator ( [REDACTED] ) testified that the muster of the persons assigned to Lifeboat #2 was so chaotic that they could not achieve a muster and they attempted to have the mustering personnel count off to determine how many people were around the boat. The personnel were unable to effectively achieve this due to fear. A decision was made to fill the boat until full, load the wounded and launch. (Testimony [REDACTED] 5/29/2010, p 13)

The Transocean operations manager-performance ( [REDACTED] ) testified that after arriving at the Lifeboat Embarkation Deck, neither of the lifeboats had been launched. He further testified that he believed that the coxswain of Lifeboat #2 was awaiting instruction to launch the lifeboats. In the absence of the master and observing the traveling block in the derrick fall, he told the coxswain to “go.” (Testimony [REDACTED] 8/23/2010, pp 452-453)

As additional personnel continued to board Lifeboat #1, a stretcher containing an injured crew member ( [REDACTED] ) was also placed aboard. Once the injured party was onboard, the stretcher was thrown out of the lifeboat. The BP VP for Drilling & Completions ( [REDACTED] ) testified that upon reaching the Lifeboat Embarkation Deck, he confirmed his assignment to Lifeboat #2 by use of the "T" Card that was issued to him from the safety orientation. He retrieved the card from his pocket at the Embarkation Deck and nonetheless boarded Lifeboat #1 along with the subsea

## Appendix H | CRITICAL EVENTS TIMELINE

---

supervisor ( [REDACTED] ). The BP VP for Drilling & Completions ( [REDACTED] ) further testified that he had to wedge himself into the boat to get a seat because the lifeboat was cramped as some injured were lying down. He also stated that he did not use his seat belt and referred to the environment as pandemonium. (Testimony [REDACTED] 8/23/2010, pp 453-455; Testimony [REDACTED] 8/26/2010, p 368)

The master ( [REDACTED] ) of *DAMON B. BANKSTON* received calls from *DEEPWATER HORIZON*'s Global Marine Distress Safety System (GMDSS) as well as by Very High Frequency (VHF) radio. Upon receiving the calls, the crew of *DAMON B. BANKSTON* prepared their fast rescue craft (FRC) for recovery of MODU personnel. (*BANKSTON* Log; Testimony [REDACTED] 5/22/2010, p 1050; Testimony [REDACTED] 5/10/2010, pp 187-197)

2205: Coast Guard D8 Command Center issued an Urgent Marine Information Broadcast (UMIB). Quote: "The Coast Guard has received a report of *DEEPWATER HORIZON* on fire POSITION 28-44.3N 088-21.9W with approximately 144 POB, 45NM ESE of South Pass, LA. All Mariners are requested to maintain a sharp lookout, assist if possible and report all sightings to the nearest U.S. Coast Guard unit." (SAR Case Report)

2206: Coast Guard Sector Mobile, Alabama documented receiving a Good Samaritan VHF radio report from the recreational fishing vessel *RAMBLIN' WRECK* announcing that *DEEPWATER HORIZON* is engulfed in fire and the personnel are abandoning the MODU. (SAR Case Report)

2209: Coast Guard Sector New Orleans Command Center documented receiving notification from *DEEPWATER HORIZON* MODU Manager ( [REDACTED] ) of the casualty. (SAR Case Report)

2212-2332: *DAMON B. BANKSTON* launched their FRC with chief engineer ( [REDACTED] ) and Able-Bodied Seaman (Longlois). Personnel from *DEEPWATER HORIZON* were observed jumping into the water. (*BANKSTON* Log; Testimony [REDACTED] 5/10/2010, pp 187-197; Testimony [REDACTED] 5/11/2010, pp 234-236; Testimony [REDACTED] 5/11/2010, p 116)

During the muster of personnel at Lifeboat #1 Embarkation Deck, the mud engineer ( [REDACTED] ) decided to depart the Lifeboat Deck, and proceeded to the Lower Smoking Deck and jumped overboard; in his opinion, the muster was taking too long. He and two others, who had previously jumped, were quickly recovered from the water by *DAMON B. BANKSTON* FRC before either of the two lifeboats was launched from *DEEPWATER HORIZON*. (Testimony [REDACTED] 5/28/2010, pp 210-211, 224; Testimony [REDACTED] 5/11/2010, pp 187-197; Testimony [REDACTED] 5/11/2010, pp 106-115)

The launching of Lifeboat #1 was delayed because the Transocean operations manager-performance ( [REDACTED] ) waited for the master ( [REDACTED] ) to make his way to the boat. However, when master ( [REDACTED] ) did appear he told the Transocean operations manager-performance ( [REDACTED] ) "We have other people. We are going to the rafts." The Transocean operations manager-performance ( [REDACTED] ) further testified that he said "don't [and] get in the boat." However, the master turned and left. The Transocean operations manager-performance ( [REDACTED] ) testified that he procrastinated for a minute or so and then decided to launch the boat and leave. The roustabout ( [REDACTED] ) who was assigned to Lifeboat #1 estimated it took about thirty to forty-five minutes to get everyone up in lifeboats and launch them. Lifeboat #1 was the

## Appendix H | CRITICAL EVENTS TIMELINE

---

last lifeboat to leave *DEEPWATER HORIZON*. (Testimony [REDACTED] 8/23/2010, pp 453-455; Statement [REDACTED] 4/21/2010)

After boarding Lifeboat #1, the Transocean operations manager-performance ([REDACTED]) testified that the coxswain was a bit excited and he told him to calm down. The Transocean operations manager-performance ([REDACTED]) further instructed the launching and movement of the boat. The Transocean operations manager-performance ([REDACTED]) stated, that the off-watch DPO ([REDACTED]) who was serving as the coxswain said he was going to turn on the air supply to the lifeboat as well as the water spray system to cool the boat; this never happened. (Testimony [REDACTED] 8/23/2010, pp 453-455)

Despite numerous efforts and adjustments, the chief electronics technician ([REDACTED]) the chief engineer ([REDACTED]) and the motorman ([REDACTED]) could not get the standby generator to start and headed back to the CCR. After returning to the CCR, there were three people remaining in the CCR, the master ([REDACTED]) the on-watch SPDO ([REDACTED]) and the on-watch DPO ([REDACTED]). The lifeboats were already gone. The master was standing at the door to the CCR and called abandon...get the hell out. The chief electronics technician ([REDACTED]) and motorman ([REDACTED]) ran to the liferaft. The chief engineer ([REDACTED]) soon followed the master after verifying the SDPO and the DPO was also departing the CCR. ([REDACTED] Statement 4/21/2010; Testimony [REDACTED] 7/19/2010, pp 33-35)

While motoring Lifeboat #1 to *DAMON B. BANKSTON*, the Transocean operations manager-performance ([REDACTED]) opened the hatch and proceeded to climb on top of the boat to actuate the windshield wiper and cleaned the window of mud from the blowout in order to see where they were going. (Testimony [REDACTED] 8/23/2010, p 455)

After both lifeboats had departed, the eleven remaining persons including the chief engineer ([REDACTED]) the master ([REDACTED]) the on-watch DPO ([REDACTED]) the chief electronics technician ([REDACTED]) the electrical/electronics supervisor ([REDACTED]) the toolpusher ([REDACTED]) the senior tool pusher ([REDACTED]) the chief mate ([REDACTED]) the motorman ([REDACTED]) the senior DPO ([REDACTED]) and the chief electrician ([REDACTED]) mustered near the forward Liferaft Embarkation Deck to determine if the remaining persons on board could safely transit *DEEPWATER HORIZON* to Lifeboats #3 and #4 on the stern. It was determined that; evacuation of the remaining eleven persons including the tool pusher ([REDACTED]) who was in a stretcher, could only occur by means of the inflatable liferaft served by a launching appliance from the bow of *DEEPWATER HORIZON*. (Testimony [REDACTED] 10/5/2010, pp 161-164)

During the transit to the davit launched liferafts, the SDPO ([REDACTED]) saw the master ([REDACTED]) and a few others getting the davit ready while the chief mate ([REDACTED]) was preparing the liferaft. However, the davit would not rotate over the side of *DEEPWATER HORIZON*. Upon closer examination, the chief electronic technician ([REDACTED]) noticed a rope attached to the releasing hook was secured to the davit by way of a shackle preventing the davit from swinging clear of *DEEPWATER HORIZON*. Using a small tool, the shackle pin was removed, the davit rotated and the liferaft was inflated for boarding. ([REDACTED] Statement 4/21/2010; Testimony [REDACTED] 10/5/2010, p 154)



## Appendix H | CRITICAL EVENTS TIMELINE

---

Once the liferaft was inflated, the chief engineer (██████████) ran over to a nearby stretcher containing the off-watch tool pusher and proceeded to drag the stretcher across the deck to the Liferaft Embarkation Deck. The chief mate (██████████) and the chief electrician (██████████) boarded the raft first and then assisted the chief engineer (██████████) in loading the stretcher into the liferaft despite an order from the master (██████████) to leave him [injured]. After the stretcher was loaded, the electrician (██████████) chief engineer (██████████) senior tool pusher (██████████) and finally the DPO (██████████) boarded the liferaft. (Statement ██████████ 4/21/2010; Statement ██████████ 4/21/2010)

During embarkation, the liferaft was reported to be slowly rotating, swinging, filling with smoke and becoming very hot. The chief engineer (██████████) testified the flames and heat from under *DEEPWATER HORIZON* was creating a vortex at the Liferaft Embarkation Deck. After entering, the chief engineer (██████████) described how he could feel the heat of the fire penetrating his clothing on his knees and through his leather gloves. (Testimony ██████████ 7/19/2010, pp 44-47; Testimony ██████████ 5/27/2010, pp 326, 331-335)

The chief electronics technician (██████████) who was standing outside the liferaft waiting to board, also noted the fire was coming out of the top of the derrick and projectiles were coming from everywhere and that some type of back draft was occurring underneath *DEEPWATER HORIZON* and the fire was starting to feed itself. At that point, he recalled he wasn't sure if the liferaft was going to survive because of the heat and that it was going to pop or melt and the people inside were going to cook. (Testimony ██████████ 7/23/2010, p 23)

As the master (██████████) the on-watch SDPO (██████████) and the chief electronics technician (██████████) waited, the chief mate (██████████) testified the raft filled with black smoke, got really hot and the brake handle couldn't be identified when the raft began its descent. The on-watch SDPO (██████████) testified that he was standing behind the master for boarding and heard someone within the raft tell the master, "Let's go. You all get in." But, he (the master) did not and said not to worry about him. The chief electrician (██████████) an occupant of the raft, testified that the chief mate (██████████) pulled the release handle that began the raft's descent. (Testimony ██████████ 10/5/2010, pp 161-164; Testimony ██████████ 5/27/2010, pp 326-335)

The master, on-watch SDPO, the chief electronics technician, and the on-watch motorman were left aboard *DEEPWATER HORIZON* at the Liferaft Embarkation Deck. The master determined there was not enough time to manually crank the davit's releasing hook back to the davit to deploy another liferaft. When the on-watch SDPO asked the master, "What about us?" the master said, "I don't know what you're going to do, but I'm going to jump." The master then jumped approximately 50 feet<sup>479</sup> into the water followed by the on-watch SDPO and the on-watch motorman. The chief electronics technician said, he departed the Liferaft Embarkation Deck and made his way to the Helicopter Landing Deck where he then proceeded to jump approximately 71 feet into the water.<sup>480</sup> (Testimony ██████████ 5/27/2010, pp 193-194, 209-211; Testimony ██████████ 10/5/2010, pp 154-156; Testimony ██████████ 7/23/2010, pp 17-28)

During the liferaft's descent, the painter line which is required to be attached to the MODU remained connected. As the liferaft descended approximately 35 feet, the painter line became

---

<sup>479</sup> Distance determined by *DEEPWATER HORIZON* outboard profile drawing using the drilling draft (ABSDWH000074).

<sup>480</sup> Ibid.

## Appendix H | CRITICAL EVENTS TIMELINE

---

taught causing the liferaft to jerk and tilt 90 degrees causing all of the occupants to tumble to one side and ejecting the injured crew member ( ) from the stretcher. (Testimony ( ) 10/5/2010, p 15; Testimony ( ) 5/27/2010, pp 332-334; Testimony ( ) 5/27/2010 pp 269-270)

Once the liferaft hit the water, the DPO ( ) said she fell out of the liferaft and managed to safely swim away. The chief mate ( ), chief electrician ( ) and chief engineer ( ) all exited the liferaft and began pulling it away from the burning *DEEPWATER HORIZON*. While pulling the liferaft away, the chief engineer ( ) witnessed the master ( ) land approximately five feet from the raft after he jumped from the deck; the SDPO ( ) landed approximately ten feet from the raft; the chief electronics technician ( ) run across the Helicopter Landing Deck, jump and landed in the water. As the FRC from *DAMON B. BANKSTON* began its approach to the liferaft, the crew retrieved the DPO ( ) and the chief electronics technician ( ). While the FRC began towing the liferaft to safety, someone noticed the painter line still attached to *DEEPWATER HORIZON*. None of the occupants of the liferaft, the master ( ) or the SDPO ( ) had a knife to cut the liferaft's painter line from the MODU nor could they find the knife stored on the liferaft. Ultimately, the chief engineer ( ) obtained a knife from the FRC crew and gave it to the master ( ) who finally freed the raft. The FRC then towed the liferaft to safety. (Testimony ( ) 10/5/2010, pp 161-164; Testimony ( ) 10/5/2010, p 15; Testimony ( ) 5/11/2010, pp 106-107; Testimony ( ) 5/27/2010, pp 267-271; Testimony ( ) 7/19/2010, pp 47-49; Testimony ( ) 5/27/2010, pp 331-335; Testimony ( ) 5/10/2010, pp 187-197)

2226: The Coast Guard D8 Command Center documented notification from BP of seven persons being retrieved from the water. (SAR Case Report)

2235: The Coast Guard D8 Command Center documented that *DEEPWATER HORIZON* MODU Manager ( ) reported that there were one hundred twenty-six persons-on-board (POB) *DEEPWATER HORIZON* at the time of the casualty and that one hundred-fifteen (115) made it to *DAMON B. BANKSTON*. This is considered to be the first accurate accounting of the POB. (SAR Case Report)

2240: Coast Guard Aircraft Training Center (ATC) Mobile, Alabama documented that aircraft HC-144A (CG-2308) from Coast Guard ATC Mobile, AL departed the airfield. (SAR Case Report)

2245: Coast Guard Sector New Orleans Command Center documented that the *USCGC POMPANO* (CG-87339) departed Coast Guard Station (STA) Venice, LA. (SAR Case Report)

2248: *MONICA ANN* arrived on-scene in the vicinity of *DEEPWATER HORIZON* and commenced Search and Rescue (SAR) operations. (*MONICA ANN* Log)

2249: Coast Guard Sector Mobile documented that the *USCGC COBIA* (CG-87311) was diverted to assist in the mass rescue operations (MRO). (SAR Case Report)

## Appendix H | CRITICAL EVENTS TIMELINE

---

2305: Coast Guard ATC Mobile documented that Coast Guard helicopter from ATC Mobile (CG-6531) was delayed due to mechanical issues. (SAR Case Report)

2310: Coast Guard Air Station New Orleans documented that helicopter (CG-6605) arrived on-scene and commenced searching. (Total elapsed time from initial launch order was 1 Hour and 7 Minutes). (SAR Case Report)

2313: Coast Guard Air Station New Orleans documented that helicopter (CG-6576)'s launch was delayed due to critical equipment not functioning. (SAR Case Report)

2314: Off-watch DPO (██████████) was the last person to debark Lifeboat #1 alongside *DAMON B. BANKSTON*. (██████████ Statement, 4/21/2010; Testimony ██████████ 5/10/2010, pp 187-197)

2315: Coast Guard ATC Mobile documented that CG-HC-144A (CG-2308) was on-scene and commenced search. (Total elapsed time was 1 Hour and 12 Minutes). (SAR Case Report; Testimony ██████████ 5/11/2010, p 112))

2330: *DAMON B. BANKSTON* took a head count of *DEEPWATER HORIZON* personnel on board *DAMON B. BANKSTON*; total is 126-15 = 111 persons-on-board (POB). (SAR Case Report; *BANKSTON* Log)

2330: *DAMON B. BANKSTON* advised all vessels in the vicinity of *DEEPWATER HORIZON* by radio that there were 15 crew members from *DEEPWATER HORIZON* that were missing. (*MONICA ANN* Log)

2353: A Coast Guard (CG) rescue swimmer from CG helicopter (CG-6605) boarded *DAMON B. BANKSTON* to conduct triage and assume control of medical evacuations. (SAR Case Report; *BANKSTON* Log)

2355: The Coast Guard D8 Command Center documented completion of the Critical Incident Communication. (SAR Case Report)

2358: *LEE* arrived on-scene in the vicinity of *DEEPWATER HORIZON* and directed its fire monitors on *DEEPWATER HORIZON*. (*LEE* Log)

2400: *ALICE G McCALL* arrived at *DEEPWATER HORIZON* and commenced SAR operations. (*ALICE G. McCALL* Log).

2400: *MONICA ANN* terminated their SAR operations and moved in closer to *DEEPWATER HORIZON* and engaged in cooling efforts with their fire monitor. (*MONICA ANN* Log)

### April 21, 2010

0004: Coast Guard Air Station New Orleans documented that helicopter (CG-6576) was on scene and commenced searching. (Total elapsed time from launch was 51 Minutes). (SAR Case Report)

## Appendix H | CRITICAL EVENTS TIMELINE

---

0006: The first injured person was emergency-evacuated from *DAMON B. BANKSTON* to Coast Guard helicopter (CG-6605). (SAR Case Report; *BANKSTON* Log)

0030: Coast Guard ATC Mobile documented that (CG-6010) departed the airfield with a Coast Guard flight surgeon on board (O/B). (SAR Case Report)

0043: A second person was emergency-evacuated from *DAMON B. BANKSTON* to Coast Guard helicopter (CG-6605). (SAR Case Report)

0045: Coast Guard Air Station New Orleans documented helicopter (CG-6508) was launched from the airfield. (SAR Case Report)

0053: *DAMON B. BANKSTON* reported that three Coast Guard rescue swimmers were now on board for emergency evacuation operations. (*BANKSTON* Log)

0055: A Coast Guard Message was sent reading: CG Flight Surgeon will be lowered to *DAMON B. BANKSTON* to triage injured parties. Oil platform *NAKITA* can treat non-evacuation medical issues. (SAR Case Report)

0055: *DAMON B. BANKSTON* reported that there were now four boats applying water to the fire: *SECOR LEE*, *GULF PRINCESS*, *NORBET BOUZIGA*, and *MONICA ANN*. The vessels *BEE STING* and *KATRINA FAGAN* reported that they were two miles away and en route with fire monitors and would take up fire-fighting positions upon arrival. (*BANKSTON* Log; *NORBERT BOUZIGA* Log)

0100: The Coast Guard D8 Command Center requests airspace restriction for the area in and around *DEEPWATER HORIZON*. The Federal Aviation Administration (FAA) grants the request. (SAR Case Report)

0106: Three additional persons-on-board (POBs) were emergency-evacuated from *DAMON B. BANKSTON* via Coast Guard helicopter. It was reported that multiple vessels could be seen arriving on scene with fire-fighting capabilities. All parties directed to commence AJC search patterns around *DEEPWATER HORIZON*. (*BANKSTON* Log)

0110: The vessels *BEE STING* and *KATRINA FAGAN* were moving into position to fight the fire. (*BANKSTON* Log)

0115: *DAMON B. BANKSTON* reported the following vessels were now assisting with fire-fighting and SAR operations: *ALICE G. MACALL*; *KOBE CHOUEST*; *OCEAN INTERVENTION III*; *RELIANCE*; *MAX CHOUEST*; *PAT TILLMAN*; *C-PACER*; *MSC FAMILIA*; *GLORIA B. CALLAIS*; *LAINY CHOUEST* and *C-EXPRESS*. (*BANKSTON* Log)

0120: Coast Guard ATC Mobile documented that helicopter (CG-6010) was on scene. (SAR Case Report)

## Appendix H | CRITICAL EVENTS TIMELINE

---

0130: *DEEPWATER HORIZON* starts to develop a list towards its starboard stern, with some rotation along with secondary explosions. Firefighting vessels were forced to move back. (*BANKSTON* Log)

0130: *KATRINA FAGAN*, *LEE*, *MOINCA ANN* and other response vessels back off from fire-fighting on *DEEPWATER HORIZON* efforts due to the explosions. (*KATRINA FAGAN* Log; *LEE* Log; *MONICA ANN* Log)

0130: *LANEY CHOUEST* arrived on-scene in the vicinity of *DEEPWATER HORIZON*. *DAMON B. BANKSTON* directed *LANEY CHOUEST* to begin searching three to five miles around *DEEPWATER HORIZON*. (*LANEY CHOUEST* Log)

0132: Two additional POBs were emergency-evacuated to *NAKITA* from *DAMON B. BANKSTON*. (*BANKSTON* Log)

0133: Coast Guard Air Station New Orleans documented that helicopter (CG-6508) was on-scene. (SAR Case Report)

0139: The Coast Guard D8 Command Center documented BP informing them that vessels providing fire-fighting water to *DEEPWATER HORIZON* were being backed off due to the list. (SAR Case Report)

0156: One critical injured POB on *DAMON B. BANKSTON* was emergency-evacuated. (*BANKSTON* Log)

0200: *WASHINGTON* arrived on-scene in the vicinity of *DEEPWATER HORIZON* and was directed by *DAMON B. BANKSTON*, the On-Scene Coordinator (OSC) [*BANKSTON* assumed OSC responsibilities despite no formal designation in the absence of any Coast Guard assets], to position itself to pump water on the burning MODU. (*WASHINGTON* Log)

0200: *NORBERT BOUIZGA* backs off from *DEEPWATER HORIZON* to a distance of 900' and stands by for further orders. (*NORBERT BOUIZGA* Log)

0220: Coast Guard Air Station New Orleans documented that helicopter (CG-6605) departed the incident scene. (SAR Case)

0225: Four additional POBs on *DAMON B. BANKSTON* were emergency-evacuated plus one critical POB. Coast Guard helicopters (CG-6605), (CG-6531), (CG-6576) and HC-144A (CG-2308) were working on-scene. (*BANKSTON* Log)

0227: Coast Guard ATC Mobile documented that helicopter (CG-6010) departed the incident scene. (SAR Case Report)

0237: *USCGC RAZORBILL* (CG-87332) was delayed getting underway due to the fact that the unit readiness status was other than Bravo-Zero (B-0). (SAR Case Report)

## Appendix H | CRITICAL EVENTS TIMELINE

---

0240: *BOA SUBSEAS EXPRESS* commenced a search four nautical miles to the South of the position of *DEEPWATER HORIZON*. (*BANKSTON* Log)

0248: Coast Guard Air Station New Orleans documented that helicopter (CG-6576) departed the incident scene. (SAR Case Report)

0250: *DAMON B. BANKSTON* reported that *DEEPWATER HORIZON* has now rotated 180 degrees and moved 1,600 feet to the East Northeast. (*BANKSTON* Log)

0300: *KATRINA FAGAN* and *LEE* re-engaged in fire-fighting efforts for *DEEPWATER HORIZON* at a safe distance. (*KATRINA FAGAN* Log; *LEE* Log)

0305: *GULF PRINCESS* was en route to check the report of a flipped life raft. Search discovered no POB. (*BANKSTON* Log)

0315: *SAILFISH* was now on location searching the area and assisting with supplies and water. (*BANKSTON* Log)

0318: *USCGC POMPANO* (CG-87338) was on scene and began searching. *DAMON B. BANKSTON* reported that *DEEPWATER HORIZON* has developed a heavy list toward the starboard stern. (SAR Case Report; *BANKSTON* Log; Testimony ██████████ 5/11/2010, p 115)

0325: *NORBERT BOUIZGA* requested the name of the person requesting fire-fighting help. The master (██████████) of *DEEPWATER HORIZON* provided the name. (*BANKSTON* Log)

0330: Transocean contacted SMIT Americas and requested that they come to the Transocean command center to “assist” developing a salvage plan for *DEEPWATER HORIZON*. (Testimony ██████████ 10/4/2010, pp 110-116; Testimony ██████████ 8/23/2010, pp 468-472)

0335: *ALICE G. McCALL* departed the vicinity of *DEEPWATER HORIZON* for Port Fourchon, LA. (*ALICE G. McCALL* Log)

0340: *USCGC POMPANO* (CG-87338) was en route to check out a report of an overturned liferaft northeast of *DEEPWATER HORIZON*'s location in a debris field. No POBs were discovered. (*BANKSTON* Log)

0343: The Coast Guard D8 Command Center documented that the BP representative would like to establish a joint command center. (SAR Case Report)

0345: Four Coast Guard rescue swimmers were aboard *DAMON B. BANKSTON*. (*BANKSTON* Log)

0347: Two additional POBs were emergency-evacuated from *DAMON B. BANKSTON* via Coast Guard Helicopter. (*BANKSTON* Log)

0349: Coast Guard Air Station New Orleans documented that helicopter (CG-6508) was on scene. (SAR Case Report)

## Appendix H | CRITICAL EVENTS TIMELINE

---

0350: *SECOR LEE* and *NORBERT BOUIZGA* attempted to re-engage with fire-fighting efforts. (*BANKSTON* Log)

0356: Coast Guard ATC Mobile documented that helicopter (CG-6531) departed the incident scene. (SAR Case Report)

0405: One Coast Guard Rescue Swimmer was airlifted to a Coast Guard (CG) helicopter. (SAR Case Report)

0415: *LEE* re-engaged in fire-fighting efforts at the request of *DAMON B. BANKSTON* at a distance they were comfortable. (*LEE* Log)

0420: *NORBERT BOUIZGA* re-engaged in fire-fighting efforts at the request of *DAMON B. BANKSTON* at a distance they were comfortable. (*NORBERT BOUIZGA* Log)

0425: All injured POBs had been emergency-evacuated (16 total). 99 POB remained on board *DAMON B. BANKSTON* from *DEEPWATER HORIZON*. (*BANKSTON* Log)

0426: *DAMON B. BANKSTON*'s FRC was back on board and secured. (*BANKSTON* Log)

0438: The Coast Guard D8 Command Center documented that *USCGC POMPANO* (CG-87339) started their search pattern. (SAR Case Report)

0445: Coast Guard ATC Mobile documented that helicopter (CG-6010) was launched. (SAR Case Report)

0447: *USCGC COBIA* (CG-87311) reported that it has an estimated time of arrival of four hours. (SAR Case Report)

0451: Coast Guard Air Station New Orleans documented that helicopter (CG-6508) departed the incident scene. (SAR Case Report)

0500: *DAMON B. BANKSTON* was still on-scene directing and coordinating fire-fighting and SAR operations. Many additional vessels were seen, too many to accurately identify. (*BANKSTON* Log; Testimony ██████████ 5/11/2010, p 238)

0500: SMIT Americas personnel arrived at Transocean command center. (Testimony ██████████ 10/4/2010, pp 110-111)

0500: *MONICA ANN* shut down their fire monitor on the starboard side of *DEEPWATER HORIZON* as directed. (*MONICA ANN* Log)

0535: Coast Guard ATC Mobile documented that helicopter (CG-6010) was on scene. (SAR Case Report)

## Appendix H | CRITICAL EVENTS TIMELINE

---

0545: Coast Guard ATC Mobile documented that a HC144A (CG-2308) departed the incident scene. (SAR Case Report)

0600: *DAMON B. BANKSTON* requested all vessels to intensify their SAR efforts as daylight approaches. (*BANKSTON* Log)

0600: *VANGARD* is chartered to SMIT America. (*VANGARD* Log)

0628: Coast Guard Air Station New Orleans documented that helicopter (CG-6605) was launched. (SAR Case Report)

0632: Coast Guard Air Station New Orleans documented that helicopter (CG-6556) was launched. (SAR Case Report)

0637: The Coast Guard D8 Command Center documented that BP reported a Cougar flight took six passengers to a Mobile, AL hospital; five were critical. A Coast Guard Flight Surgeon was still on board *DAMON B. BANKSTON*. (SAR Case Report)

0643: The Coast Guard D8 Command Center documented their request for the assistance of *USCGC DECISIVE* (WMEC 629). (SAR Case Report)

0645: *LANEY CHOUEST* terminated their SAR efforts in and around *DEEPWATER HORIZON* location. (*LANEY CHOUEST* Log)

0655: *DAMON B. BANKSTON* reported that all Coast Guard rescue swimmers had departed the vessel. (*BANKSTON* Log)

0700: *MR. SYDNEY* arrived on scene, in the vicinity of *DEEPWATER HORIZON*, to assist with fire-fighting efforts. (*MR. SYDNEY* Log)

0715: *FAST CAJUN* arrived on scene, in the vicinity of *DEEPWATER HORIZON*, to assist with SAR and fire-fighting efforts. (*FAST CAJUN* Log)

0723: The Coast Guard Eighth D8 Command Center documented the release of *DAMON B. BANKSTON* to return to shore with ninety-nine *DEEPWATER HORIZON* persons-on-board. (SAR Case Report; Testimony [REDACTED] 10/5/2010, p 161)

0730: *USCGC ZEPHYR* (WPC8) was on-scene and assumed On-Scene-Coordinator (OSC) of the SAR operations. *DAMON B. BANKSTON* was released to depart. (*BANKSTON* Log; Testimony [REDACTED] 5/11/2010, p 119)

0800: The Transocean Command Center contacted the Transocean operations manager-performance ([REDACTED] while he was on *MAX CHOUEST* and advised him of the need for the fire responders to direct their water flow at the underside of *DEEPWATER HORIZON* instead of on the deck or the columns in order to avoid down flooding and the possible loss of stability. (Testimony [REDACTED] 10/4/2010, pp 120-125; Testimony [REDACTED] 10/5/2010, p 33; Testimony



## Appendix H | CRITICAL EVENTS TIMELINE

---

██████████ 8/23/2010, 468-474)

0803: *DAMON B. BANKSTON* released the custody of Lifeboats # 1 and # 2 from *DEEPWATER HORIZON* to *SAILFISH*. (*BANKSTON* Log)

0803: *DAMON B. BANKSTON* released *NORBERT BOUZIGA* which immediately departed for the *ENSCO 8501*. (*NORBERT BOUZIGA* Log)

0813: *DAMON B. BANKSTON* departed the vicinity of *DEEPWATER HORIZON* en route to the *OCEAN ENDEAVOR*, which was approximately fourteen nautical miles away. (*BANKSTON* Log; Testimony ██████████ 5/11/2010, p 119)

0815: Coast Guard Air Station New Orleans documented that helicopter (CG-6556) arrived on scene. (SAR Case Report)

0816: Coast Guard Air Station New Orleans documented that helicopter (CG-6605) arrived on scene. (SAR Case Report)

0819: Coast Guard ATC Mobile documented that helicopter (CG-6010) departed the incident scene. (SAR Case Report)

0827: *MONICA ANN* was requested to re-engage fire-fighting operations on *DEEPWATER HORIZON*. (*MONICA ANN* Log)

0830: *LEE* was relieved of fire-fighting duties by *JOE GRIFFIN* and departed the vicinity of *DEEPWATER HORIZON* with the permission of *USCGC ZEPHYR*. (*LEE* Log)

0906: *DAMON B. BANKSTON* rendezvoused with *OCEAN ENDEAVOR*, which was standing by for transfer of personnel. (*BANKSTON* Log)

0907: *USCGC RAZORBILL* (87332) was on scene. (SAR Case Report)

0913: The Coast Guard D8 Command Center documented that *ODESSEY DIAMOND* located two burned liferafts with no sign of life or having had life on board. (SAR Case Report)

0925: The Coast Guard D8 Command Center documented that *USCGC ZEPHYR* (WPC8) assumed OSC responsibilities from *USCGC POMPANO* (87339). *USCGC POMPANO* remained on scene. (SAR Case Report)

0945: *MONICA ANN* backed away from *DEEPWATER HORIZON* because the fire was getting too hot (intense). *MONICA ANN* took up a new position approximately 400' to 500' away. (*MONICA ANN* Log)

0949 – 1028: *DAMON B. BANKSTON* transferred six persons-on-board and two packages off. *DAMON B. BANKSTON* then on-loaded two POB: (Medics – ██████████). Four additional POB were off loaded to the *MAX CHOUEST* ██████████ & ██████████ (*BANKSTON* Log; Testimony ██████████ 8/23/2010, pp 472, 515-527; Testimony ██████████ 5/28/2010, p 176)

## Appendix H | CRITICAL EVENTS TIMELINE

---

1015: Despite having no regulatory requirement to do so, four of the surviving personnel from *DEEPWATER HORIZON* (████, █████, █████ and █████ remained on-scene on the *MAX CHOUEST* in an attempt to fight the fire, secure the well and stabilize *DEEPWATER HORIZON*. (*BANKSTON* Log; *MAX CHOUEST* Log; Testimony █████ 8/23/2010, pp 472, 515-527; Testimony █████ 5/28/2010, p 176)

1028: *DAMON B. BANKSTON* departed and rendezvoused with *OCEAN ENDEAVOR* en route to the platform *MATTERHORN TLP*. (*BANKSTON* Log)

1030: *SEACOR VANGUARD* began loading equipment for *DEEPWATER HORIZON*. (*SEACOR VANGUARD* Log)

1100: Coast Guard MSU Morgan City conducted its first unified command meeting with all of the involved parties. (SAR Case Report)

1200: *C-ENFORCER* arrived on scene, in the vicinity of *DEEPWATER HORIZON*, and began directing water on *DEEPWATER HORIZON* from their forward and aft fire monitors. (*C-ENFORCER* Log)

1325: *MAX CHOUEST* informed *USCGC ZEPHYR* to direct fire fighting vessels to redirect water to the columns of *DEEPWATER HORIZON* as per the Transocean Performance Manager (████) (*MAX CHOUEST* Log)

1400 *MAX CHOUEST* making loop around rig to evaluate. (*MAX CHOUEST* Log)

1409: *DAMON B. BANKSTON* arrived at *MATTERHORN TLP* (MC 243). (*BANKSTON* Log)

1439 – 1522: *DAMON B. BANKSTON* stood by for a helicopter landing on the *MATTERHORN TLP*. (*BANKSTON* Log)

1440: *MAX CHOUEST* setting up dynamically positioned (DP), port forward side of *DEEPWATER HORIZON*. (*MAX COUEST* Log)

1445: *SEACOR VANGUARD* departed the Inter-Moor Dock en route for MC 252 *DEEPWATER HORIZON*. (*SEACOR VANGUARD* Log)

1450: *SEACOR WASHINGTON* advised *MAX CHOUEST* that they observed a breach of the port forward column of *DEEPWATER HORIZON*. (*MAX CHOUEST* Log)

1515: *LANEY CHOUEST* was released from further SAR efforts by *USCGC ZEPHYR* and departed the area. (*LANEY CHOUEST* Log)

1515: *MONICA ANN* was requested to move in closer to *DEEPWATER HORIZON* and focus on extinguishing fires on the water in and around *DEEPWATER HORIZON*. (*MONICA ANN* Log)

## Appendix H | CRITICAL EVENTS TIMELINE

---

1522 – 1549: *DAMON B. BANKSTON* conducts loading of nine persons-on-board (3 CG; 2 MMS; 4 Tidewater). (*BANKSTON* Log)

1540: The *MAX CHOUEST* launches their ROV to inspect the Riser and BOP for *DEEPWATER HORIZON*. (*MAX CHOUEST* Log)

1549: *DAMON B. BANKSTON* departed the platform *MATTERHORN TLP* en route to Port Fourchon, LA. (*BANKSTON* Log)

1610: *MAX CHOUEST* ROV reached the BOP for *DEEPWATER HORIZON*. (*MAX CHOUEST* Log)

1730: *MAX CHOUEST* ROV attempted to close the pipe rams on *DEEPWATER HORIZON*'s BOP. *MAX CHOUEST* efforts were unsuccessful. (*MAX CHOUEST* Log)

1800: ROV operations were initiated from responding vessels. (Testimony [REDACTED] 8/23/2010, pp 474-475, 515-527)

1930: *MAX CHOUEST* ROV was back on the deck of the *MAX CHOUEST*. (*MAX CHOUEST* Log)

2050: *MAX CHOUEST* ROV re-entered the water and headed for *DEEPWATER HORIZON* BOP. (*MAX CHOUEST* Log)

2110: *MAX CHOUEST* reported that BP called “all stop” to the ROV efforts. (*MAX CHOUEST* Log)

2140: *MAX CHOUEST* ROV arrived at *DEEPWATER HORIZON* BOP and began pumping in an effort to close the valve on the BOP. (*MAX CHOUEST* Log)

2230: *PAT TILLMAN* was released and departed the vicinity of *DEEPWATER HORIZON* for the *THUNDER HORSE*. (*PAT TILLMAN* Log, TDW-04579)

2240: *MONICA ANN* was directed to back away from *DEEPWATER HORIZON* and stand by for further direction. (*MONICA ANN* Log)

2340: *MAX CHOUEST* ROV returned to the surface to install a grinder. Heading changed to 145 degrees true. (*MAX CHOUEST* Log)

2345: *SEACOR VANGUARD* arrived on scene, in the vicinity of *DEEPWATER HORIZON*, and commenced a damage assessment of the vessel. (*SEACOR VANGUARD* Log)

### April 22, 2010

0000: *MAX CHOUEST* changed out cutting tools. (*MAX CHOUEST* Log)

0001: *VANGARD* standing by at MC 252 *DEEPWATER HORIZON*. (*VANGARD* Log)

## Appendix H | CRITICAL EVENTS TIMELINE

---

0050 – 0355: *C-EXPRESS* was on scene in the vicinity of *DEEPWATER HORIZON* to commence ROV operations. (*C-EXPRESS* Log)

0050: *MAX CHOUEST* ROV re-entered the water headed for *DEEPWATER HORIZON* BOP. (*MAX CHOUEST* Log)

0100: *BEE STING* arrived at *DEEPWATER HORIZON* location and maneuvered into position to spray water on the burning *DEEPWATER HORIZON*. (*BEE STING* Log)

0125: *MAX CHOUEST* ROV was operating on *DEEPWATER HORIZON* BOP as directed. (*MAX CHOUEST* Log)

0127 – 0135: *DAMON B. BANKSTON* arrived C-Port 1 and moored in Slip #1 Port Fourchon, LA. (*BANKSTON* Log)

0135 - 0200: All persons-on-board (POB) *DAMON B. BANKSTON* disembarked; total POB disembarked = 105. All survivors are subject to drug testing. Tidewater employees Breaux, Dawson and Dominique were on board. (*BANKSTON* Log; SAR Case Report)

0200 – 0600: *DAMON B. BANKSTON* was standing by for orders. SE-CON was on board for chemical screening of *DAMON B. BANKSTON* crew following the casualty. The casualty was considered a serious marine incident (SMI) by the Coast Guard; therefore, requiring chemical testing of the crew. (*BANKSTON* Log)

0259: *C-EXPRESS* reported feeling an explosion coming from *DEEPWATER HORIZON*. (*C-EXPRESS* Log)

0345: *SEACOR VANGUARD* at port side aft of rig using their water cannon. (*SEACOR VANGUARD* Log)

0500: *SEACOR VANGUARD* began making a pass around *DEEPWATER HORIZON* (*SEACOR VANGUARD* Log)

0645: *MAX CHOUEST* ROV was back on deck on the *MAX CHOUEST*. (*MAX CHOUEST* Log)

0700: *C-ENFORCER* re-aims their fire monitors as directed. (*C-ENFORCER* Log)

0700: *SEACOR VANGUARD* reported that *DEEPWATER HORIZON*'s heading had now shifted to 055 degrees true and that it listing heavily to starboard and the stern. (*SEACOR VANGUARD* Log)

0730: *MAX CHOUEST* off loaded four persons onto *BOA SUB C*. (*MAX CHOUEST* Log)

## Appendix H | CRITICAL EVENTS TIMELINE

---

0745: *SEACOR VANGUARD* reported that *DEEPWATER HORIZON*'s heading had now shifted to 160 degrees true and that it was listing 22 degrees to starboard and the stern. (*SEACOR VANGUARD* Log)

0825: *SEACOR VANGUARD* reported that *DEEPWATER HORIZON*'s heading had now shifted to 150 degrees true and that it was listing 22 degrees to starboard and the stern. (*SEACOR VANGUARD* Log)

0835: *SEACOR VANGUARD* reported that *DEEPWATER HORIZON*'s heading had now shifted to 140 degrees true and that it was listing 22 degrees to starboard and the stern. (*SEACOR VANGUARD* Log)

0850: *SEACOR VANGUARD* reported that *DEEPWATER HORIZON*'s heading had now shifted to 130 degrees true and that it was listing 22 degrees to starboard and the stern. (*SEACOR VANGUARD* Log)

0910: *SEACOR VANGUARD* reported that *DEEPWATER HORIZON*'s heading had now shifted to 100 degrees true and that it was listing 22 degrees to starboard and the stern. The efforts of the ROV to close the Subsea Valve on the BOP failed. *INTERVENTIN 3* rigging up for Dive. (*SEACOR VANGUARD* Log)

0930: *BEE STING* departs MC 252 en route to VK 826 Neptune Pool 10. (*BEE STING* Log)

1000: *MONICA ANN* backed away from *DEEPWATER HORIZON* as the MODU began to capsize. (*MONICA ANN* Log)

1005: *SEACOR VANGUARD* reported that they had rigged fire hoses on the port side of the vessel in order to provide a shield from the fire and heat. (*SEACOR VANGUARD* Log)

1020: *SEACOR VANGUARD* reported that the starboard side of *DEEPWATER HORIZON* was now in the water and they were moving away to a safe distance. (*SEACOR VANGUARD* Log)

1025: *MAX CHOUEST* reported that *DEEPWATER HORIZON* had capsized and that they had moved five miles away as directed by the Coast Guard. (*MAX CHOUEST* Log; *C-EXPRESS* Log; *MONICA ANN* Log)

1026: *DEEPWATER HORIZON* sank in position 28.73N Latitude and 88.36W Longitude approximately 45 Nautical Miles (NM) East South East (ESE) of South Pass, LA in 5,000 feet of water. (SAR Case Report)

**Appendix I | POTENTIAL LEGAL ISSUES ASSOCIATED WITH VESSELS  
EMPLOYING DYNAMIC POSITIONING SYSTEMS**

---



2100 Second Street, S.W.  
Washington, DC 20593-0001  
Staff Symbol: CG-094  
Phone: (202) 372-3726  
Fax: (202) 372-3966

16712  
11 Feb 2011

**MEMORANDUM**

From: [REDACTED]  
S. D. Poulin, CAPT  
COMDT (CG-0941)

Reply to: CG-0941  
Attn of: [REDACTED]  
2-1198

To: CG-5

Subj: POTENTIAL LEGAL ISSUES ASSOCIATED WITH VESSELS EMPLOYING  
DYNAMIC POSITIONING SYSTEMS

Ref: (a) 46 U.S.C. Parts B, E, and F  
(b) 43 U.S.C. Subchapter III  
(c) 46 C.F.R. Subchapters B, I-A and N  
(d) 33 C.F.R. Subchapter N  
(e) NVIC 8-68  
(f) TJAG memorandum - POTENTIAL IMPACTS ON COAST GUARD PROGRAMS  
OF SUPREME COURT RULING IN STEWART V. DUTRA INTERPRETING  
"VESSEL" UNDER 1 U.S.C. §3, 20 July 2006

This memorandum was prepared to assist Coast Guard programs in considering issues related to Dynamic Positioning technology on vessels. While not written to address the DEEPWATER HORIZON incident, this document was drafted with an appreciation that the analyses and conclusions may be relevant to the inquiry of the USCG-BOEMRE Joint Investigation into the Marine Casualty, Explosion, Fire, Pollution, and Sinking of the Mobile Offshore Drilling Unit DEEPWATER HORIZON with Loss of Life in the Gulf of Mexico 21-22 April 2010. As such, if deemed helpful to that inquiry, this memorandum may be appended to the report of the Joint Investigation.

**Executive Summary**

1. Coast Guard regulations need to be updated to account for the emergence of Dynamic Positioning (DP) aboard vessels. Current regulations do not expressly address DP and may therefore extend certain requirements that are not practical for DP vessels. For example, under existing regulatory definitions, watercraft operating with a DP system are considered: (1) "self-propelled motor vessels"; (2) "underway"; and (3) most relevant for Mobile Offshore Drilling Units maintaining position with a DP system (without an anchor or load bearing connection to the bottom), cannot be considered "on location." Significant issues relating to manning and operational conditions also arise when considering foreign registered DP vessels operating in the navigable waters of the U.S. or engaged in U.S. regulated activities on the outer continental shelf (OCS) which further reflect a need for new regulations and possible legislative changes to address the shortcomings in the current U.S. regulatory regime.

## Appendix I | POTENTIAL LEGAL ISSUES ASSOCIATED WITH VESSELS EMPLOYING DYNAMIC POSITIONING SYSTEMS

---

Subj: DYNAMIC POSITIONING VESSELS

16712

11 Feb 2011

### Background

2. This memorandum is written to address legal issues associated with vessels that operate with DP systems. It addresses both vessels of the U.S.<sup>1</sup> and foreign vessels,<sup>2</sup> including the impact of DP systems on operating requirements on vessels engaged in OCS activities on U.S. OCS, territorial seas and inland waters, as well as in the case of U.S. vessels, on the high seas or the waters of a foreign country. In general, a DP system is a computer controlled system that automatically maintains a vessel's position and heading by use of its own propellers and/or thrusters.<sup>3</sup> Position reference sensors (most commonly differential GPS), combined with wind sensors, motion sensors and heading (gyro compass), provide information to a computer pertaining to the vessel's position and the magnitude and direction of environmental forces affecting its position. The computer will direct the vessel's propulsion and rudder systems to maintain a fixed position and heading. Although a vessel operating under a DP system is capable of making way, its primary purpose is station keeping. The functional difference is that, unlike traditional station keeping, DP does not use anchors or a load bearing connection to the ocean bottom. Additionally, vessels may use DP systems to accurately follow a course, as in survey operations.

3. A vessel operating under DP does not easily fit into existing U.S. statutes and regulations administered by the Coast Guard. In fact, the term "Dynamic Positioning" is only referenced once in Coast Guard regulations, the context of which is not useful in this analysis.<sup>4</sup> The offshore drilling industry is particularly aware of the deficiencies in current regulations, especially whether MODUs operating in DP mode are "underway" or "on location."<sup>5</sup> These statutes and regulations were written well before the use of DP systems became so prevalent and have not been amended to take their unique characteristics into account. Furthermore, technology is continually outpacing existing regulatory requirements. These existing requirements may not be well-suited to DP vessels, especially with respect to minimum manning, training, system requirements (including safety equipment) and credited seagoing experience; all depend on the classification of a subject vessel within the current regulatory regime, along with a determination of its operating condition. As stated, the laws and regulations have not kept up with the burgeoning DP capability on these vessels.

4. Some attempts to address the regulatory shortcomings through policy documents have been made. However, these are at best short-term fixes and reflect policy interpretations. Various program elements within the Coast Guard are beginning to update our regulations. In so doing,

---

<sup>1</sup> 46 U.S.C. § 116 states, "[i]n this title, the term "vessel of the United States" means a vessel documented under chapter 121 of this title, (or exempt from documentation under section 12102(c) of this title), numbered under chapter 123 of this title, or titled under the law of a State."

<sup>2</sup> 46 U.S.C. § 110 states, "[i]n this title, the term "foreign vessel" means a vessel of foreign registry or operated under the authority of a foreign country."

<sup>3</sup> See IMO MSC/Circ. 645, para. 1.3.1

<sup>4</sup> The sole reference of note is 46 C.F.R § 113.40-10 which mentions DP systems in relation to requirements of Rudder Angle Indicator Systems. DP is not defined or referenced in statute.

<sup>5</sup> See International Association of Drilling Contractors (IADC) 19 February 2010 letter commenting on USCG's 17 November 2009 Notice of Proposed Rulemaking, Docket Number USCG-2004-47914.

## Appendix I | POTENTIAL LEGAL ISSUES ASSOCIATED WITH VESSELS EMPLOYING DYNAMIC POSITIONING SYSTEMS

---

Subj: DYNAMIC POSITIONING VESSELS

16712

11 Feb 2011

they are attempting to reconcile a DP vessel's status when determining pertinent issues within their sphere of responsibility and have requested legal analysis. The issues with which they are confronted include:

- a. A determination of minimum manning requirements for a vessel operating (often for extended duration) in a DP system status. This includes both the complement of personnel and the chain of command depending on operational status;
- b. A determination of a watercraft's status when the DP system is used in very limited circumstances such that it could potentially be considered incidental to its operational purpose;
- c. A determination of whether a vessel operating with a DP system may, in certain circumstances, satisfy operational requirements of vessels that have traditionally used a conventional mooring (anchor) or bottom bearing system; and
- d. A determination of a credited sea service for seafarers serving aboard vessels engaged in extended DP operations.

5. This memorandum's purpose is to place DP vessels within the current legal framework and address those laws and regulations that may need to be amended and/or created so the Coast Guard can provide industry with clarity and direction. The primary issues addressed in this memorandum are:

- a. Whether vessels operating under DP are considered "self propelled";
- b. Whether vessels operating under DP are considered "on location";
- c. Whether vessels operating under DP are considered "underway";
- d. Manning and operating condition implications of classifying DP vessels as self-propelled and "underway" and/or engaged in drilling on our OCS; and
- e. U.S. authority over foreign vessels using DP systems engaged in OCS activities<sup>6</sup> on our OCS.

### **Self-propelled motor vessel**

6. The determination of whether a particular watercraft is a "vessel" is critical because it sets the foundation of the regulatory regime. TJAG memorandum (ref. (f)) regarding the definition of "vessel" following the Supreme Court decision, *Willard Stewart v. Dutra Construction Company*, 543 U.S. 481 (2005), discusses the criteria to be considered. This memorandum does not attempt to replicate the *Stewart* memo analysis, but notes 1 U.S.C. § 3's definition of "vessel,"<sup>7</sup> following the Supreme Court decision in *Stewart*, has been somewhat narrowed.<sup>8</sup> Each case is potentially unique, depending on the specific factual determination. There is less emphasis on what is possible and more on what is practicable when determining whether a particular watercraft qualifies as a vessel.<sup>9</sup>

---

<sup>6</sup> 33 CFR 140.10 defines OCS activities as, "any offshore activity associated with exploration for, or development or production of, the minerals of the Outer Continental Shelf."

<sup>7</sup> The word "vessel" includes every description of watercraft or other artificial contrivance used, or capable of being used, as a means of transportation on water. 1 U.S.C. § 3.

<sup>8</sup> *Stewart* at 494.

<sup>9</sup> *Id.*



## Appendix I | POTENTIAL LEGAL ISSUES ASSOCIATED WITH VESSELS EMPLOYING DYNAMIC POSITIONING SYSTEMS

---

Subj: DYNAMIC POSITIONING VESSELS

16712

11 Feb 2011

7. Assuming a watercraft is a “vessel,” the determination of whether it is a “motor vessel” is significant since self-propelled vessels are, in addition to requirements related to their design and equipment, typically subject to 46 U.S.C. Chapters 81-83, addressing minimum manning complements, required credentials, citizenship and watchstanding requirements. 46 U.S.C. § 2101(16) defines “motor vessel” as “a vessel propelled by machinery other than steam.” Self-propelled vessels are addressed in several locations in U.S. regulation. 46 C.F.R. § 10.107 defines “self propelled” as having the same meaning as the terms “propelled by machinery” and “mechanically propelled.”<sup>10</sup> 46 C.F.R. § 42.05-63 notes that “(t)he terms ship(s) and vessel(s) are interchangeable or synonymous words, and include every description of watercraft, other than a seaplane on the water, used or capable of being used as a means of transportation on water.”<sup>11</sup> These provisions provide a very broad definition of what constitutes a self-propelled vessel such that virtually any watercraft that is equipped with machinery that can be used to propel itself would fall under the classification. There are no requirements with respect to duration of operation or distance traveled. The available case law is sparse with respect to the designation of vessels that operate with DP. Cases that mention DP do so in a context that is not germane to the purposes of this memo, but interestingly conclude that DP vessels are self-propelled.<sup>12</sup> As such, any vessel operating under its DP system unless and until our regulations are updated and provide differently would be considered a self-propelled vessel.

8. In 1968, NVC (NVIC) 8-68 recognized that application of such a broad definition of “self propelled” would result in certain unintended (and undesirable) consequences. Some watercraft - such as barges with “kickers” or tunnel type thrusters used solely to aid in assisting mooring or transiting confined areas, that were not intended to be subject to U.S. inspection and manning requirements, would be classified as self propelled thus subjecting them to additional manning and U.S. inspection regulations. NVC 8-68 attempted to solve that perceived problem by simply interpreting such vessels to be exempt. The goal was to exclude certain vessels from those requirements that would be applicable if the vessels were determined to be “self propelled.” NVC 8-68 exempted those vessels where the equipped machinery was used solely in limited operations whereby the propulsion was incidental to its intended purpose of assisting steerage. NVC 8-68, while a policy document, is nevertheless instructive to the present issue; it notes that “Vessels equipped with directional maneuvering equipment and/or substantial propulsion assist units will *normally* be considered as self-propelled vessels. . .” (emphasis added). This would include vessels equipped with DP systems.

9. In light of the broad and generally applicable regulatory definitions of “motor vessel” and “self propelled,” a vessel operating in DP mode, regardless of whether the involved machinery is also used for the vessel making way (transiting), is considered a self-propelled vessel.

---

<sup>10</sup> Although this section of the C.F.R. applies to licensing and credentialing of merchant mariners, it is useful in a general context.

<sup>11</sup> This section of the C.F.R. applies to the application of load lines, but is also instructive.

<sup>12</sup> See *Garry v. Exxon Mobil Corporation*, 2004 WL 3676210 (E.D.La.) (noting the subject DP vessel was self-propelled); *Global Industries v. Pipeliners Local*, 2006 WL 724815 (W.D.La.) (distinguishing a vessel operating under DP from a fixed structure while operating in the OCS).

## Appendix I | POTENTIAL LEGAL ISSUES ASSOCIATED WITH VESSELS EMPLOYING DYNAMIC POSITIONING SYSTEMS

---

Subj: DYNAMIC POSITIONING VESSELS

16712

11 Feb 2011

### On location

10. As noted above, motor vessels are subject to specific manning requirements, one of which involves minimum numbers of licensed individuals as set forth in 46 U.S.C. § 8301. Subsection (c) of that section effectively exempts certain vessels operating under specific conditions, one of which is a MODU when “on location.” A MODU is considered a vessel.<sup>13</sup> As DP systems on MODUs are becoming more common, the question of whether a MODU, operating with DP during drilling operations, is considered “on location,” must be addressed.

11. 46 C.F.R. § 10.107 (Definitions in subchapter B) states that “*On location* means that a mobile offshore drilling unit is bottom bearing or moored with anchors placed in the drilling configuration.” This precludes a vessel maintaining a fixed position with DP from being considered “on location” under our regulations, since there is no physical connection to the ocean bottom that either holds (anchors) the vessel in place or supports it (bottom bearing, as in a jack-up rig). It is noted that a MODU operating under DP may well have a physical connection to the ocean bottom (sometimes referred to as “hooked up” or “latched up”), such as where riser pipelines or drilling lines run from the MODU to the ocean bottom. However, with no actual load involved (i.e., the connection to the ocean floor is not serving as an anchor or support), the regulatory definition of “on location” in 46 C.F.R. § 10.107 is not satisfied. As such, under our current regulations, any vessel holding position solely through the use of its DP system cannot be “on location.”

### Underway

12. A corollary to the “on location” issue is whether a vessel operating with DP is considered “underway.” Whether a vessel is considered underway will determine what navigation rules must be followed. 46 C.F.R. § 10.107 defines “underway” as

“a vessel is not at anchor, made fast to the shore, or aground. When referring to a mobile offshore drilling unit (MODU), underway means that the MODU is not in an on-location or laid-up status and includes that period of time when the MODU is deploying or recovering its mooring system.”

Both the International and Inland Navigation Rules have the same definition, except for the second sentence referencing MODUs.<sup>14</sup> “Underway,” as defined in our regulations and in the navigation rules is essentially contrary to the “on location” definition; that definition even expressly referring to MODU’s on location as being *not* underway. As such, because a vessel operating under DP is not at anchor, nor is it made fast to shore or the ocean bottom,<sup>15</sup> it is by

---

<sup>13</sup> See 46 U.S.C. § 2101(15a).

<sup>14</sup> For the international rule, see Convention on the International Regulations for Preventing Collisions at Sea, 1972, as codified by 33 U.S.C. § 1602 (Navigation Rule 3(i)); for the inland rule, see 33 U.S.C. § 2003(h).

<sup>15</sup> The term “made fast” is not defined in regulation. Some common definitions state that “made fast” is merely the process of connecting a line to an object. However, in the context of the “underway” definition, it implies more than simply being attached, requiring that the connection be capable of supporting a load and ensuring that the vessel is secure in its position. The other two controlling terms, “anchor” and “aground,” clearly denote a level of security

## Appendix I | POTENTIAL LEGAL ISSUES ASSOCIATED WITH VESSELS EMPLOYING DYNAMIC POSITIONING SYSTEMS

---

Subj: DYNAMIC POSITIONING VESSELS

16712  
11 Feb 2011

definition “underway,” although perhaps not *making way*, assuming it is essentially maintaining a fixed position.<sup>16</sup>

13. As noted above, the current definitions in U.S. regulation and law were enacted and published well before the rising prominence of DP systems on vessels. There has been some opinion within USCG programs that a ship operating under DP should be treated the same as a vessel in a traditional anchor mooring system, assuming sufficient precautions (such as operational system redundancies) are taken,<sup>17</sup> or, in the alternative, that its status at least be differentiated from that of a traditional underway vessel. This approach to DP classification would be a policy decision; there is no statutory or international treaty prohibition to this approach. However, such a position should be adopted through a significant rulemaking to modify both the definitions of “on location” and “underway,” along with detailed requirements describing the DP systems to be used.

### Manning Implications

14. Concluding that a watercraft operating under a DP system is to be classified as an underway, self propelled vessel (*not* “on location”) results in that vessel being subject to the somewhat inflexible statutory requirements of 46 U.S.C. Part F, pertaining to the manning of vessels, particularly §§ 8101(complement), 8103(citizenship requirements), 8104(watches), and 8301(minimum number of licensed individuals).

15. Manning requirements are generally dependent on the type and size of a vessel. Because there are no manning exceptions specific to DP-equipped vessels, a vessel that is a “DP vessel” would not be subject to different standards. As an example, a MODU that is operating under DP would be considered a self-propelled MODU. Any exemptions that may apply to its manning requirements would be primarily based on it being a MODU. The fact that it operates under a DP system would only indirectly affect its manning requirements.<sup>18</sup> Similarly, an offshore supply vessel (OSVs) that holds station with a DP system would be subject to the manning requirements of 46 U.S.C. §§ 8301(b) and 8104(g) in the same way as an OSV with a traditional propulsion system.

---

beyond that of mere attachment. Consequently, a MODU, connected to the ocean floor with a riser or some other non-load bearing manner, would not be considered made fast. *See also Virginia Intern. Terminals, Inc. v. M/V Katsuragi*, 263 F.Supp.2d 1025, 1038-39 (E.D.Va., 2003)(in the mooring context, supporting the concept that a line must be capable of supporting a load before a vessel is considered “made fast.”)

<sup>16</sup> Although considered underway, a DP vessel may be “restricted in her ability to maneuver” as defined by Navigation Rule 3(g) (both Inland and International) depending on the operations being conducted from the vessel at the time.

<sup>17</sup> *See* Coast Guard D8 22 January 2003 Memorandum addressing the use of DP systems by OSVs during oil and hazmat transfers.

<sup>18</sup> 46 U.S.C. § 8101(a)(2) allows that “the specialized nature of the unit” may be considered when imposing manning requirements on a MODU. This could arguably include the DP system used. However, the primary factor to consider would be that the vessel is a MODU, not a “DP vessel.” Additionally, since a MODU operating under DP would be considered a self-propelled MODU, it would be subject to 46 CFR §15.520(d), requiring it be under the command of a licensed master who also holds an OIM endorsement at all times.

## Appendix I | POTENTIAL LEGAL ISSUES ASSOCIATED WITH VESSELS EMPLOYING DYNAMIC POSITIONING SYSTEMS

---

Subj: DYNAMIC POSITIONING VESSELS

16712

11 Feb 2011

16. A distinction must be made between U.S. and foreign registered vessels. U.S. jurisdiction over all vessels engaged in OCS activities is described below.<sup>19</sup> However, virtually all manning regulations in the C.F.R. are specific to U.S. flagged ships. Vessels flagged by countries that are parties to international safety conventions to which the U.S. is also a party and offering the same privileges to U.S. flagged vessels are generally granted reciprocity.<sup>20</sup> As such, while a U.S. registered MODU equipped with a DP system must be under the command of a Master (who also holds an Offshore Installation Manager endorsement),<sup>21</sup> the manning requirements of a foreign registered MODU are not subject to the same requirement.

### **Authority over foreign vessels utilizing DP systems engaged in OCS activities on U.S. OCS**

17. The U.S. has certain authority of over any vessel that operates on waters subject to its jurisdiction and may penalize persons operating vessels in an unsafe manner.<sup>22</sup> With few exceptions, vessels operating in U.S. waters are subject to inspections that are broad in scope<sup>23</sup> and the authority to promulgate regulations is well established.<sup>24</sup> In addition, U.S. authority over foreign registered vessels engaged in OCS activities within the outer continental shelf is set forth in 43 U.S.C. §§ 1331 - 1356a (Outer Continental Shelf Lands Act – “OCSLA”). 43 U.S.C. § 1332(6) states:

operations in the Outer Continental Shelf should be conducted in a safe manner by well-trained personnel using technology, precautions, and techniques sufficient to prevent or minimize the likelihood of blowouts, loss of well control, fires, spillages, physical obstruction to other users of the waters or subsoil and seabed, or other occurrences which may cause damage to the environment or to property, or endanger life or health.

33 C.F.R. § 140.3 further clarifies OCSLA as applying to vessels operating on the OCS that are engaged in “OCS activities.” This does not, however, include every vessel that is operating in waters over the OCS. Vessels operating in waters above the OCS, but not engaged in OCS activities as defined by 33 C.F.R. § 140.10 are not subject to OCSLA.<sup>25</sup> Regulations may be promulgated by the Coast Guard as deemed necessary.<sup>26</sup>

18. International instruments addressing DP systems aboard vessels are also lagging behind the emerging technology. To date, only broad advisory documents have been adopted addressing vessel systems<sup>27</sup> and more recently the training and experience of personnel,<sup>28</sup> allowing industry

---

<sup>19</sup> See paragraph 19, *infra*.

<sup>20</sup> 46 U.S.C. § 3303.

<sup>21</sup> 46 CFR § 15.520(d). The status of the vessel (underway, at anchor, etc.) is irrelevant to this requirement.

<sup>22</sup> 46 USC §§ 2301-2302.

<sup>23</sup> 46 U.S.C. §§ 3301-3318.

<sup>24</sup> 46 U.S.C. §3306.

<sup>25</sup> *Alex v. Wild Well Control*, 2009 WL 2599782 (E.D.La.) (not reported in Fed.Supp.).

<sup>26</sup> 43 U.S.C. § 1347(c).

<sup>27</sup> IMO MSC/Circ 645 *Guidelines for Vessels with Dynamic Positioning Systems*, (6 June 1994); The IMO Code for Construction and Equipment of Mobile Offshore Drilling Units, 2009 (MODU Code), devotes one sentence to DP

## Appendix I | POTENTIAL LEGAL ISSUES ASSOCIATED WITH VESSELS EMPLOYING DYNAMIC POSITIONING SYSTEMS

---

Subj: DYNAMIC POSITIONING VESSELS

16712  
11 Feb 2011

leaders such as the International Marine Contractors Association (IMCA) and the Nautical Institute (NI) to publish guidance. Some international bodies desire that DP standards be made mandatory, but the current consensus is that broad guidance is better suited to address the wide variances in DP systems coupled with the rapidly expanding nature of this technology.<sup>29</sup>

19. As noted above, the legal views expressed herein, as they apply to U.S. registered vessels, have not universally been adopted by the international community. For example, the term “on location,” a creature of U.S. law and regulation, is without an international equivalent. IMO MSC/Circular 645 (*Guidelines for Vessels with Dynamic Positioning Systems*), only defines the term “position keeping” as the act of “. . . maintaining a desired position.”<sup>30</sup> The IMO MODU Code states that MODUs utilizing DP systems as “. . . a sole means of position keeping should provide a level of safety equivalent to that provided for anchoring arrangements.”<sup>31</sup> The Code furthermore exempts MODUs from complying with the Convention on the International Regulations for Preventing Collisions at Sea, 1972 (“COLREGs”) “when stationary and engaged in drilling operations.”<sup>32</sup> As such, although not specifically stated, the available international guidance strongly suggests that a MODU operating under a DP system would likely be considered in the same status as one that is traditionally anchored. This does not mean that a foreign MODU (or any vessel) may ignore U.S. law in favor of international guidelines but, at a minimum, it results in the potential for significant confusion, particularly when U.S. regulations allow for a foreign MODU to comply with the “operating standards of the [MODU Code]” as a means of complying with U.S. law.<sup>33</sup> This confusion is compounded, since the MODU Code itself states that in certain circumstances, a MODU should comply with the laws of the coastal state in which it is operating.<sup>34</sup>

20. Additionally, the international community has been unable to agree on any mandatory international manning (numbers of required credentialed mariners on board) standards. The IMO Convention on Standards of Training and, Certification and Watchkeeping for Seafarers, July 7, 1978 (STCW) is not particularly relevant to the issue of such manning. It is principally concerned with safety by establishing minimum competency of seafarers; it says nothing about the minimum number of required seafarers on board, only stating that ships must comply with “applicable safe manning requirements.”<sup>35</sup> The level of on board manning is only indirectly

---

systems, noting they should be as safe as that of anchoring arrangements. When operating on the OCS, the MODU Code is only mandatory to those foreign MODUs subject to 33 CFR § 146.205(c).

<sup>28</sup> STCW Code B-V/1, *Guidance on the training and experience for personnel operating dynamic positioning systems*, (adopted 2 July 2010).

<sup>29</sup> IMO subcommittee Standards of Training and Watchkeeping (STW) *Report To The Maritime Safety Committee*, STW 40/14, p. 25 (23 February 2009).

<sup>30</sup> IMO MSC/Circ 645, p. 3. While the two terms – “on location” and “station keeping” are similar in concept, and may have similarities in some usages, they are not legally equivalent, at least until the USCG takes steps consistent with the APA to make them so for purposes of the laws it administers.

<sup>31</sup> MODU Code, at paragraph 4.13

<sup>32</sup> *Id.*, at paragraph 14.8.1.

<sup>33</sup> 33 C.F.R § 146.205(c) allows foreign MODUs to comply with the MODU Code as an alternative to complying with the 46 C.F.R. Part 109.

<sup>34</sup> MODU Code, at paragraph 14.8.2.

<sup>35</sup> STCW Regulation I/4, at paragraph 1.2.

## Appendix I | POTENTIAL LEGAL ISSUES ASSOCIATED WITH VESSELS EMPLOYING DYNAMIC POSITIONING SYSTEMS

---

Subj: DYNAMIC POSITIONING VESSELS

16712

11 Feb 2011

affected by the convention due to watchkeeping standards,<sup>36</sup> which dictate minimum hours of rest requirements. Furthermore, while minimum standards with respect to watchstanding durations may affect the *number* of personnel required aboard a vessel to insure safe operation and navigation, it will not delineate the orders of responsibility or chain of command for those serving any type of vessel. Therefore, each flag state determines the minimum safe manning required on the safe manning certificate for its registered MODUs.<sup>37</sup>

21. Pursuant to 33 CFR § 146.205, foreign MODUs engaged in OCS activities must comply with one of three regulatory schemes outlined therein, one of which is compliance with the IMO MODU code. Other than requiring<sup>38</sup> that the owner or operator of a MODU designate a person in charge for emergency situations, there are no manning requirements in the MODU Code. As noted above, the MODU code does require compliance with coastal states' safety of navigation laws, but only "when stationary and engaged in drilling operations."<sup>39</sup> It is unclear whether this was intended to apply to MODUs holding position with a DP system. It is unstated what is meant by "requirements for the safety of navigation," whether this is limited to appropriate navigation lights/shapes for a fixed structure or whether this includes all manning and competency requirements of U.S. law and regulation. Reading paragraph 14.8.2 as a whole, noting that it pertains only to stationary MODUs, strongly suggests the former.<sup>40</sup>

22. The U.S. does not prescribe manning requirements for a foreign MODU operating in the OCS adjacent to U.S. territories, other than to require that "[t]he owner or operator shall designate by title and order of succession the person on each OCS facility who shall be the 'person in charge.'"<sup>41</sup> This manning requirement is not specifically effected by the operational status of a MODU, be it underway, on location, at anchor or some other condition. Nor does the U.S. differentiate between foreign MODUs operating with DP systems (self-propelled) and those without. Because the international standards (guidance) do not establish a manning requirement and such mandatory manning standards are a long way off (if ever),<sup>42</sup> there is a gap with respect to the manning and operational requirements for foreign registered MODUs that operate in the U.S. OCS.

---

<sup>36</sup> See STCW Chapter VIII/1 of the Annex and STCW Code Section A-VIII/1.

<sup>37</sup> The U.S. could, but does not currently dictate additional manning requirements for foreign flagged MODUs engaged in OCS activities on the U.S. OCS under OCSLA authorities as well as customary international law.

<sup>38</sup> Use of the word "requiring" may be too strong since the MODU Code uses the word "should" throughout its text. IMO's use of "should" is reserved for guidance (non-mandatory) publications. Nonetheless, the MODU code may be made mandatory through U.S. regulation as in 33 C.F.R. § 146.205(c).

<sup>39</sup> MODU Code, at paragraph 14.8.2.

<sup>40</sup> In the alternative, foreign MODUs would have to comply with all U.S. laws regarding manning and credentialing, including the alternative provided by 46 U.S.C. § 8101(a)(2), dictating that manning requirements for MODUs "consider the specialized nature of the unit."

<sup>41</sup> 33 C.F.R. § 146.5.

<sup>42</sup> Some guidance addressing manning that has come from the IMO STW subcommittee. The most recent attempt to adopt mandatory requirements occurred in January 2010 at STW 41 and had very little support. At most, only mandating the *process* of determining safe manning levels enjoys any broad support. See STW 41/16 Report To The Maritime Safety Committee, pp.42-44, (22 January 2010).

**Appendix I | POTENTIAL LEGAL ISSUES ASSOCIATED WITH VESSELS  
EMPLOYING DYNAMIC POSITIONING SYSTEMS**

---

Subj: DYNAMIC POSITIONING VESSELS

16712

11 Feb 2011

**Conclusion**

23. Under current law, a watercraft operating with a DP System is an underway, self-propelled vessel, and subject to all the regulatory requirements of “traditional” vessels. While operating in DP mode, a vessel cannot be considered “on location.”

24. Subject to the provisions of OCSLA and our implementing regulations in 33 C.F.R. Part 140-147, and to the reciprocity provision in 46 U.S.C. § 3303, 46 U.S.C. Part F, pertaining to the manning of vessels, particularly §§ 8101(complement), 8103(citizenship requirements), 8104(watches), and 8301(minimum number of licensed individuals) applies to vessels in DP mode.

25. There is sufficient statutory authority to address and clarify DP vessels’ status in regulations and both the Coast Guard and industry would be well served by doing so. Items where clarification would be beneficial include:

- a. New and/or amended definitions in the regulations concerning credentialing, manning, ship design and operations, including:
  - (1) DP systems;
  - (2) Self-propelled MODU;
  - (3) Station Keeping with DP systems;
  - (4) Clarifying *on location* to specifically exclude MODUs operating under DP; and
  - (5) Clarifying *underway* to include vessels operating under DP;
- b. Regulations addressing the need for competency standards for seafarers serving aboard vessels equipped with DP systems;
- c. Regulations addressing crediting sea service for seafarers serving on vessels using DP for extended periods;
- d. Regulations addressing DP systems used for station keeping;
- e. Regulations addressing the unique manning requirements of vessels equipped with DP systems. This is one area that would additionally require a statutory change in 46 U.S.C. § 8101(a), similar to what is currently provided therein for sailing school vessels and MODUs.
- f. Regulations addressing manning and operational requirements of self-propelled MODUs in 46 C.F.R. Part 109; and
- g. Regulations addressing the manning requirements of foreign registered vessels, including MODUs, operating with DP systems in the OCS.

Any new regulations to be promulgated should consider current international standards/practices and that DP technology is constantly evolving.

#

Copy: CG-52  
CG-54  
Marine Safety Center

**Appendix J | SYNOPSIS OF AUDITS & SURVEYS**

<b>Audit</b>	<b>Item</b>	<b>Category</b>	<b>Discrepancy</b>	<b>Reportable if US-flagged?</b>	<b>Applicable CG Regulation if US-flagged</b>	<b>Applicable IMO Code</b>	<b>IMO Resolution A.787(19) Detention</b>	<b>CG Enforcement Action</b>
BP 09/09 MODU Audit <sup>481</sup>	1.1.1	Health, Safety and Safety Management	Permit to Work on Powered Systems (SMS)	No	33 CFR § 142.90	ISM		Non-Conformity
BP 09/09 MODU Audit <sup>480</sup>	1.1.2	Health, Safety and Safety Management	Isolation Certificate (Lock-out/Tag-out) Incomplete	No	33 CFR § 142.90	ISM		Non-Conformity
BP 09/09 MODU Audit <sup>480</sup>	1.1.3	Health, Safety and Safety Management	Contractors not knowledgeable w/Drilling and Well Operations Practice or Engineering Technical Practices	No	None	ISM		Non-Conformity
BP 09/09 MODU Audit <sup>480</sup>	1.1.4	Health, Safety and Safety Management	No Competence Assurance Program Implemented	No	None	ISM		Non-Conformity
BP 09/09 MODU Audit <sup>480</sup>	1.1.5	Health, Safety and Safety Management	Mechanical Isolations Inadequate Prior to Repairs/Maintenance	No	33 CFR § 142.90	ISM		Non-Conformity
BP 09/09 MODU Audit <sup>480</sup>	1.6.1	Mechanical Handling	E-Stop on forward Moon Pool man riding winch inoperable	No	None	ISM 10.3		Non-Conformity
BP 09/09 MODU Audit <sup>480</sup>	1.6.2	Mechanical Handling	Proof load test certification not available for man riding winches, utility winches, trolley beams, pad eyes	No	33 CFR § 96	ISM 1.2.3.2		Non-Conformity

<sup>481</sup> DEEPWATER HORIZON Follow Up MODU Audit, Marine Assurance Audit and Out of Service Period September 2009, BP-HZN-MBI00136211--70



**Appendix J | SYNOPSIS OF AUDITS & SURVEYS**

<b>Audit</b>	<b>Item</b>	<b>Category</b>	<b>Discrepancy</b>	<b>Reportable if US-flagged?</b>	<b>Applicable CG Regulation if US-flagged</b>	<b>Applicable IMO Code</b>	<b>IMO Resolution A.787(19) Detention</b>	<b>CG Enforcement Action</b>
BP 09/09 MODU Audit <sup>480</sup>	2.1.1	Health, Safety and Safety Management	Coupling guards inadequate/missing	No	46 CFR § 108.223/33 CFR § 96	ISM 1.2.2.1		Non-Conformity
BP 09/09 MODU Audit <sup>480</sup>	2.1.11	Health, Safety and Safety Management	Heli-foam system inhibited	Yes, If Refueling Capable	46 CFR § 108.487	(89) 9.11.2.2		Deficiency; Helo Restrict
BP 09/09 MODU Audit <sup>480</sup>	2.1.14	Health, Safety and Safety Management	No MSDS information in mud mixing area	No	33 CFR § 96	ISM 11.2.1		Non-Conformity
BP 09/09 MODU Audit <sup>480</sup>	2.1.16	Health, Safety and Safety Management	Fall Hazards in ballast pump rooms	No	33 CFR § 96/33 CFR § 142.87	ISM 1.2.2.1		Non-Conformity
BP 09/09 MODU Audit <sup>480</sup>	2.1.2	Health, Safety and Safety Management	Fall Hazard at crown access platform	No	33 CFR § 96/33 CFR § 142.42	ISM 10.2.3		Non-Conformity
BP 09/09 MODU Audit <sup>480</sup>	2.1.3	Health, Safety and Safety Management	Outdated BP HSE Policy posted	No	No	ISM 11.2.1		Non-Conformity
BP 09/09 MODU Audit <sup>480</sup>	2.1.4	Health, Safety and Safety Management	No annual Health and Safety Plan implemented	No	33 CFR § 96	ISM 7		Non-Conformity
BP 09/09 MODU Audit <sup>480</sup>	2.1.5	Health, Safety and Safety Management	Inadequate Training (26 of 28 lacked Kelvin Top Set Training)	No	33 CFR § 96	ISM 6.4		Non-Conformity

**Appendix J | SYNOPSIS OF AUDITS & SURVEYS**

<b>Audit</b>	<b>Item</b>	<b>Category</b>	<b>Discrepancy</b>	<b>Reportable if US-flagged?</b>	<b>Applicable CG Regulation if US-flagged</b>	<b>Applicable IMO Code</b>	<b>IMO Resolution A.787(19) Detention</b>	<b>CG Enforcement Action</b>
BP 09/09 MODU Audit <sup>480</sup>	2.1.6	Health, Safety and Safety Management	BP awareness of Transocean Focus System (incident tracking system)	No	33 CFR § 96	ISM 6.4		Non-Conformity
BP 09/09 MODU Audit <sup>480</sup>	2.1.9	Health, Safety and Safety Management	Inadequate lighting in stbd-aft stairwell	No	33 CFR § 96	ISM 1.2.2.1		Non-Conformity
BP 09/09 MODU Audit <sup>480</sup>	2.2.1	Drilling and Well Control	BOP control unit triplex pump pressure relief valve out of date for calibration (Every 2 yrs - API)	No	46 CFR § 58.60-1(c)	None		Deficiency
BP 09/09 MODU Audit <sup>480</sup>	2.2.10	Drilling and Well Control	Damaged/Outdated BOP high pressure boost hose	No	46 CFR § 58.60-1(c)	ISM 1.2.3.1		Non-Conformity/ Deficiency
BP 09/09 MODU Audit <sup>480</sup>	2.2.12	Drilling and Well Control	Failure to complete annual maintenance for choke/kill, mud lines	No	46 CFR § 58.60-1(c)	None		Deficiency
BP 09/09 MODU Audit <sup>480</sup>	2.2.2	Drilling and Well Control	No safety lanyards for derrick gates/hatches	No	33 CFR § 143.110	ISM 1.2.2.2		Non-Conformity/ Deficiency
BP 09/09 MODU Audit <sup>480</sup>	2.2.3	Drilling and Well Control	Toe boards not installed IAW API RP 54	No	33 CFR § 143.110	ISM 1.2.3.2/ Load Line 68		Non-Conformity/ Deficiency
BP 09/09 MODU Audit <sup>480</sup>	2.2.6	Drilling and Well Control	Detached/Loose grating clamps	No	33 CFR § 96	ISM 1.2.2.1		Non-Conformity
BP 09/09 MODU Audit <sup>480</sup>	2.2.8	Drilling and Well Control	Damaged high pressure mud hose	No	46 CFR § 58.60-1(c)	ISM 1.2.3.1		Non-Conformity/ Deficiency f

**Appendix J | SYNOPSIS OF AUDITS & SURVEYS**

<b>Audit</b>	<b>Item</b>	<b>Category</b>	<b>Discrepancy</b>	<b>Reportable if US-flagged?</b>	<b>Applicable CG Regulation if US-flagged</b>	<b>Applicable IMO Code</b>	<b>IMO Resolution A.787(19) Detention</b>	<b>CG Enforcement Action</b>
BP 09/09 MODU Audit <sup>480</sup>	2.3.1	Technical Services	No management system for alarm inhibits/defeats/bypasses	No	No	ISM 10.1		Non-Conformity
BP 09/09 MODU Audit <sup>480</sup>	2.3.3	Technical Services	Inadequate maintenance history reports	No	33 CFR § 96	ISM 10.1		Non-Conformity
BP 09/09 MODU Audit <sup>480</sup>	2.3.5	Technical Services	Overdue maintenance for 390 jobs	No	33 CFR § 96	ISM 10.3		Non-Conformity
BP 09/09 MODU Audit <sup>480</sup>	2.3.6	Technical Services	T2 thruster motor low resistance reading	No	33 CFR § 96	ISM 1.2.3.2		Non-Conformity
BP 09/09 MODU Audit <sup>480</sup>	2.6.1	Mechanical Handling	Derrick sheaves not being maintained properly	No	33 CFR § 96	ISM 10.3		Non-Conformity
BP 09/09 MODU Audit <sup>480</sup>	2.6.8	Mechanical Handling	Inoperable back lit LCD screen for safe load indicator for stbd deck crane	No	46 CFR § 108.601(b)(2)	ISM 1.2.3.2		Non-Conformity/ Deficiency
BP 09/09 MODU Audit <sup>480</sup>	3.2.10	Drilling and Well Control	Incomplete maintenance records for RMS II	No	33 CFR § 96	ISM 10.1		Non-Conformity
BP 09/09 MODU Audit <sup>480</sup>	3.2.12	Drilling and Well Control	Missing maintenance records for deadline anchor 5 year overhaul	No	33 CFR § 96	ISM 10.1		Non-Conformity
BP 09/09 MODU Audit <sup>480</sup>	3.2.13	Drilling and Well Control	Inadequate inspection of crown/travelling blocks	No	33 CFR § 96	ISM 10.2		Non-Conformity

**Appendix J | SYNOPSIS OF AUDITS & SURVEYS**

<b>Audit</b>	<b>Item</b>	<b>Category</b>	<b>Discrepancy</b>	<b>Reportable if US-flagged?</b>	<b>Applicable CG Regulation if US-flagged</b>	<b>Applicable IMO Code</b>	<b>IMO Resolution A.787(19) Detention</b>	<b>CG Enforcement Action</b>
BP 09/09 MODU Audit <sup>480</sup>	3.2.17	Drilling and Well Control	Inadequate RMS II2 training of MODU floor personnel	No	33 CFR § 96	ISM 6.5		Non-Conformity
BP 09/09 MODU Audit <sup>480</sup>	3.3.10	Technical Services	Daily maintenance report incomplete/inaccurate	No	33 CFR § 96	ISM 10.3		Non-Conformity
BP 09/09 MODU Audit <sup>480</sup>	3.3.13	Technical Services	Outdated thermographic inspection of switchboards and MCC	No	33 CFR § 96	ISM 10.2.1		Non-Conformity
BP 09/09 MODU Audit <sup>480</sup>	3.3.2	Technical Services	Injection tests of main breakers not completed	No	33 CFR § 96	ISM 10.1		Non-Conformity
BP 09/09 MODU Audit <sup>480</sup>	3.3.3	Technical Services	High voltage test gear not calibrated	No	33 CFR § 96	ISM 10.1		Non-Conformity
BP 09/09 MODU Audit <sup>480</sup>	3.3.5	Technical Services	Driller's cabin fire/gas panel displaying alarms/faulty	Yes	46 CFR § 109.425	(89) MODU 9.7.1		Deficiency/Provide Live Watch
BP 09/09 MODU Audit <sup>480</sup>	3.3.8	Technical Services	Defective monitor on port side drilling UPS	No	33 CFR § 96	ISM 1.2.2.1		Non-Conformity
BP 09/09 MODU Audit <sup>480</sup>	3.3.9	Technical Services	Main Engine #1 Inoperable (fuel pump)	Yes	46 CFR § 4.05	ISM 10.2.3		Non-Conformity
BP 09/09 MODU Audit <sup>480</sup>	3.6.1	Mechanical Handling	Failure to grease derrick mounted divert sheaves	No	33 CFR § 96	ISM 10.1		Non-Conformity

**Appendix J | SYNOPSIS OF AUDITS & SURVEYS**

<b>Audit</b>	<b>Item</b>	<b>Category</b>	<b>Discrepancy</b>	<b>Reportable if US-flagged?</b>	<b>Applicable CG Regulation if US-flagged</b>	<b>Applicable IMO Code</b>	<b>IMO Resolution A.787(19) Detention</b>	<b>CG Enforcement Action</b>
BP 09/09 MODU Audit <sup>480</sup>	3.6.8	Mechanical Handling	No emergency lowering instructions on aft Drill Floor man riding winch	No	33 CFR § 96	ISM 8.3		Non-Conformity
BP 09/09 MODU Audit <sup>480</sup>	4.1.1	Health, Safety and Safety Management	HSE OJT not provided for long term 3rd party personnel	No	33 CFR § 96	ISM 6.3		Non-Conformity
BP 09/09 MODU Audit <sup>480</sup>	4.2.4	Drilling and Well Control	HSE OJT not provided for long term 3rd party personnel	No	33 CFR § 96	ISM 6.3		Non-Conformity
ModuSpec <sup>482</sup> 04/10			Saltwater and freshwater pipes corroded and damage/inoperable valves	Yes	46 CFR § 4.05	(89) 4.8		Cease Operations
ModuSpec 04/10 <sup>481</sup>			2 hydraulic watertight doors inoperable	Yes	46 CFR § 109.419	(89) 3.6.1		Cease Operations
ModuSpec 04/10 <sup>481</sup>			Escape routes in columns in bad condition and in need of repairs/replacement	No	46 CFR § 108.151	(89) 9.3		Cease Ops/Temp Repair
ModuSpec 04/10 <sup>481</sup>			Repair the general alarm light	No	46 CFR § 113.25-10	None		Deficiency
ModuSpec 04/10 <sup>481</sup>			Repair the skin damage on lifeboat #4	No	46 CFR § 180.500	LSA Code		Depends on damage
ModuSpec 04/10 <sup>481</sup>			Replace the damaged glass on lifeboat #2	No	46 CFR § 180.500	LSA Code		Depends on damage

<sup>482</sup> MODU Condition Assessment *DEEPWATER HORIZON*, ModuSpec USA, Inc., 4/1-14/2010, TRNUSCG\_MMS00038609--95

**Appendix K | EXAMPLES OF TRANSOCEAN’S NON-COMPLIANCE WITH THE INTERNATIONAL SAFETY MANAGEMENT CODE**

ISM Code	Requirement Description	<i>DEEPWATER HORIZON</i> Discrepancies	Other Transocean Situations
1.2.3.1	The safety management system should ensure compliance with mandatory rules & regulations.	<ul style="list-style-type: none"> <li>▪ September 2009 - BP Maritime Assurance Audit of Deepwater Horizon identified numerous discrepancies that violated USCG regulations and international standards, and if known by USCG, it would have resulted in ceasing of vessel’s operations<sup>483</sup></li> <li>▪ April 2010 - Transocean intentionally used its “condition-based” maintenance program instead of complying with 30 CFR § 250.446 for maintenance and inspection of Deepwater Horizon’s blowout preventer<sup>484</sup></li> <li>▪ April 2010 – MODUSpec audit identified several discrepancies that violated USCG regulations and international standards, and if known by USCG, it would have resulted in ceasing of vessel’s operations<sup>485</sup></li> </ul>	<ul style="list-style-type: none"> <li>▪ April 2005 - Transocean Offshore Deepwater Drilling Inc. - Currently, engineering work carried out within Transocean that does not go through a formal approval process by a third party (e.g., class, flag administration, coast state administration, etc.) is not formally verified by within the Company. Company should review their practices and introduce a minimum level of formal verification of work specified above.<sup>486</sup></li> <li>▪ January 2007 - Transocean Offshore Deepwater Drilling Inc. - There is currently no formal means to ensure that design engineers have access to the correct revisions of relevant codes, standards, and regulations.<sup>487</sup></li> <li>▪ March 2009 - Transocean Driller received a major non-conformity for not correcting non-conformities as indicated in the vessel’s maintenance tracking system and as was reported to flag state<sup>488</sup></li> </ul>
4	To ensure the safe operation of each ship and to provide a link between the Company and those on board, every Company, as appropriate, should designate a person or persons ashore having direct access to the highest level of management. The responsibility and authority of the designated person or persons should include monitoring the safety and pollution-prevention aspects of the operation of each ship and ensuring that adequate resources and shore-based support are applied, as required.		<ul style="list-style-type: none"> <li>▪ April 2005 - Transocean Offshore Deepwater Drilling Inc. - The corporate Designated Person and Designated Persons in the regional office should have an overview of all ISM audit results relevant to their jurisdiction/operations.</li> </ul>

<sup>483</sup> BP *Deepwater Horizon* Follow Up Rig Audit, Marine Assurance Audit & Out of Service Period September 2009, BP-HZN-MBI00136211 -- 70

<sup>484</sup> Witness Testimonies, USCG-BOEMRE MBI Public Hearings, Various Dates,

<sup>485</sup> MODU Condition Assessment *DEEPWATER HORIZON*, ModuSpec USA, Inc., 4/1-14/2010, TRN-USCG\_MMS-00038609 --95

<sup>486</sup> ISM Code Certification, TRN-USCG\_MMS-00059301

<sup>487</sup> ISM Code Certification, TRN-USCG\_MMS-00059321

<sup>488</sup> DNV Job ID EOCUS466/EP001568-1

**Appendix K | EXAMPLES OF TRANSOCEAN'S NON-COMPLIANCE WITH THE INTERNATIONAL SAFETY MANAGEMENT CODE**

ISM Code	Requirement Description	DEEPWATER HORIZON Discrepancies	Other Transocean Situations
5.1	The Company should clearly define and document the master's responsibility with regard to: .1 implementing the safety and environmental protection policy of the Company; .5 reviewing the safety management system and reporting its deficiencies to the shore-based management	<ul style="list-style-type: none"> <li>▪ 20 April 2010 - <i>Deepwater Horizon's</i> safety management system was designed to operate similar to a fixed platform with the OIM in charge.<sup>489</sup></li> <li>▪ 20 April 2010 – “The function of the vessel and performance of personnel are the responsibility of the offshore installation manager (OIM).”<sup>490</sup></li> </ul>	
5.2	The Company should ensure that the safety management system operating on board the ship contains a clear statement emphasizing the master's authority. The Company should establish in the safety management system that the master has the overriding authority and the responsibility to make decisions with respect to safety and pollution prevention and to request the Company's assistance as may be necessary.	<ul style="list-style-type: none"> <li>▪ March 2009 - “As previously observed the statement of master's Authority is not clearly and completely stated within the Company Safety Management System.”<sup>6</sup></li> </ul>	<ul style="list-style-type: none"> <li>▪ April 2009 - Transocean Offshore Deepwater Drilling Inc. - As previously observed, the statement of master's authority is still not clearly and completely stated within the Company Safety Management System. Although there are various statements of the master's authority, there is no clear and absolute indication of the master's overriding authority and responsibility.<sup>491</sup></li> </ul>
6.1.2	The Company should ensure that the master is fully conversant with the Company's safety management system	<ul style="list-style-type: none"> <li>▪ In his testimony, the master was not able to recall much about <i>Deepwater Horizon's</i> safety management systems<sup>492</sup></li> </ul>	
6.1.3	The Company should ensure that the master is given the necessary support so that the master's duties can be safely performed.	<ul style="list-style-type: none"> <li>▪ The master was not in the charge of Transocean drilling personnel, BP representatives or BP contractors while the MODU was latched up<sup>493</sup></li> <li>▪ In response to uncontrolled escape of hydrocarbons, the Transocean OIM had to consult with the BP's drilling representative before requesting the master to proceed with procedures to move off location<sup>494</sup></li> </ul>	

<sup>489</sup> Health and Safety Policies and Procedures Manual HQS-HSE-PP-01 and Operations Manual

<sup>490</sup> TRN-HCEC-00006430

<sup>491</sup> ISM Code Certification; TRN-USCG\_MMS-00059333

<sup>492</sup> Testimony ██████████ 5/27/2010, pg 213-214

<sup>493</sup> DWH Organization Chart TRN-HCEC-00006431

<sup>494</sup> *Deepwater Horizon* Operations Manual TRN-HCEC-00018993

**Appendix K | EXAMPLES OF TRANSOCEAN’S NON-COMPLIANCE WITH THE INTERNATIONAL SAFETY MANAGEMENT CODE**

ISM Code	Requirement Description	DEEPWATER HORIZON Discrepancies	Other Transocean Situations
		<ul style="list-style-type: none"> <li>▪ Transocean procedures for uncontrolled escape of hydrocarbons did not clearly document the change of command from the OIM to master<sup>495</sup></li> </ul>	
6.2	<p>The Company should ensure that each ship is manned with qualified, certificated and medically fit seafarers in accordance with national and international requirements</p>	<ul style="list-style-type: none"> <li>▪ September 2009 – No competence assurance program<sup>1</sup></li> <li>▪ “Numerous personnel changes had occurred in the eighteen months since our last audit. These were seen at all levels and all disciplines... Any further dilution of experienced personnel may be detrimental to the performance of the rig.”</li> <li>▪ 20 April 2010 - While Mr. [REDACTED] was showing BP &amp; Transocean VIPs the DP simulator, the navigational watch may not be in compliance with STCW requirements<sup>2</sup></li> </ul>	<ul style="list-style-type: none"> <li>▪ January 2007 - Transocean Offshore Deepwater Drilling, Inc. - It was stated that manning is becoming an issue in the current economic climate for the drilling industry, and that there is a potential ‘knowledge gap’ between senior personnel nearing retirement age and new personnel coming into the industry. It is recommended the Owner prepare and execute a plan to maintain sufficient numbers of trained, qualified and suitable experienced personnel in the organization both onshore and offshore to ensure safe operations.<sup>486</sup></li> </ul>
6.3	<p>The Company should establish procedures to ensure that new personnel and personnel transferred to new assignments related to safety and protection of the environment are given proper familiarization with their duties. Instructions which are essential to be provided prior to sailing should be identified, documented and given</p>	<ul style="list-style-type: none"> <li>▪ There was no written procedures for relieving of key crewmembers<sup>2</sup></li> <li>▪ “It is a requirement that all staff and contractor personnel be knowledgeable of the Drilling and Well Operations Practice and associated Engineering Technical Practices. The audit highlighted that this still needed to be communicated to relevant Transocean personnel on the rig.”<sup>1</sup></li> <li>▪ “With many new personnel, continuous rigor is required to ensure that that there is the expected consistency in the application of the risk management tools including Permit to Work &amp; Energy Isolation”<sup>1</sup></li> </ul>	<ul style="list-style-type: none"> <li>▪ March 2009 - GSF [REDACTED] - It was noted that a number of personnel onboard require training as defined by the Company training matrix.<sup>496</sup></li> <li>▪ April 2009 - GSF Development Driller I - It was noted that a number of personnel onboard require training defined by the Company training matrix (overall compliance 63%).<sup>497</sup></li> <li>▪ April 2009 - GSF Development Driller II - It was noted that a number of personnel on board require training as defined by the Company training matrix.<sup>498</sup></li> <li>▪ September 2009 - Discoverer Clear Leader - It was noted that a number of personnel on board require training as defined by the Company</li> </ul>

<sup>495</sup> Deepwater Horizon Operations Manual TRN-HCEC-00018989-94

<sup>496</sup> Initial ISM/ISPS; TRN-USCG\_MMS-00059193

<sup>497</sup> Initial ISM/ISPS; TRN-USCG\_MMS-00059172

<sup>498</sup> Initial ISM/ISPS - TRN-USCG\_MMS-00059216



**Appendix K | EXAMPLES OF TRANSOCEAN’S NON-COMPLIANCE WITH THE INTERNATIONAL SAFETY MANAGEMENT CODE**

ISM Code	Requirement Description	DEEPWATER HORIZON Discrepancies	Other Transocean Situations
			training matrix (overall compliance approximately 85%). <sup>499</sup>
6.5	The Company should establish and maintain procedures for identifying any training, which may be required in support of the safety management system and ensure that such training is provided for all personnel concerned	<ul style="list-style-type: none"> <li>▪ In his testimony, the master was not able to recall much about <i>Deepwater Horizon’s</i> safety management systems<sup>10</sup></li> </ul>	<ul style="list-style-type: none"> <li>▪ May 2007 – Discoverer Spirit - It was noted that a number of personnel onboard require training as defined by the Company training matrix.<sup>500</sup></li> <li>▪ July 2007 – Transocean Marianas - It was noted during the audit that while the crew are very familiar with the Company’s Safety management documents and procedures, some crewmembers are somewhat unfamiliar with the ISM Code itself.<sup>501</sup></li> <li>▪ April 2009 - GSF Development Driller I - It was noted that some crewmembers are new to the unit and, although familiar with the general requirements of the Code, they require further exposure/ training to the Company Safety Management System.<sup>15</sup></li> <li>▪ January 2010 – Discoverer America - GMS (Global Management System) Records of Personnel Training- The GMS data/reports retrieved on board were found to be missing or inaccurate, and use of previous tracking programs GRS has been phased out.<sup>502</sup></li> <li>▪ March 2010 - Discoverer Inspiration - Gallery service was provided by third party and there is no systematic way to train the galley staff using the fire fighting system and equipment.<sup>503</sup></li> </ul>
7	The Company should establish procedures for the preparation of plans and instructions, including checklists as appropriate, for key shipboard	<ul style="list-style-type: none"> <li>▪ “Control of work issues identified specifically with isolation permit process &amp; integrity of mechanical isolations”<sup>1</sup></li> </ul>	

<sup>499</sup> Initial ISM/ISPS; TRN-USCG\_MMS-00059202

<sup>500</sup> Renewal ISM/ISPS; TRN-USCG\_MMS-00059151

<sup>501</sup> Initial ISM/ISPS; TRN-USCG\_MMS-00059229

<sup>502</sup> Initial ISM/ISPS; TRN-USCG\_MMS-00059179

<sup>503</sup> Initial ISM/ISPS; TRN-USCG\_MMS-00059187

**Appendix K | EXAMPLES OF TRANSOCEAN’S NON-COMPLIANCE WITH THE INTERNATIONAL SAFETY MANAGEMENT CODE**

ISM Code	Requirement Description	DEEPWATER HORIZON Discrepancies	Other Transocean Situations
	operations concerning the safety of the ship and the prevention of pollution. The various tasks involved should be defined and assigned to qualified personnel	<ul style="list-style-type: none"> <li>▪ “Control of alarms and defeats and bypasses was not well managed, in fact no single person could account for which alarm etc. were overridden or indeed for what reason.”<sup>1</sup></li> <li>▪ 20 April 2010 - There was no bridging document for BP and Transocean Management of Change processes<sup>2</sup></li> <li>▪ 20 April 2010 – There was no Management of Change for implementing the Rig Maintenance System<sup>2</sup></li> </ul>	
8.3	The safety management system should provide for measures ensuring that the Company's organization can respond at any time to hazards, accidents and emergency situations involving its ships.	<ul style="list-style-type: none"> <li>▪ 20 April 2010 - Transocean’s safety management system promoted a culture of complacency: (1) general alarm was inhibited, (2) drills were conducted at same time &amp; on the same weekday, and (3) conduct and documentation of drills were unsatisfactory<sup>504</sup></li> </ul>	
9.1	The safety management system should include procedures for ensuring that non-conformities, accidents and hazardous situations are reported to the Company, investigated and analyzed with the objective of improving safety and pollution prevention.	<ul style="list-style-type: none"> <li>▪ “The Incident Report Log was reviewed for the past year ... The status of actions arising from these incidents should be periodically monitored by BP to ensure proper close-out...”<sup>1</sup></li> </ul>	<ul style="list-style-type: none"> <li>▪ April 2008 – Transocean Offshore Deepwater Drilling, Inc. - It was noted that a number of REAs for update of the Operations Manuals are outstanding due to workload within the Marine Department.<sup>505</sup></li> </ul>
9.2	The Company should establish procedures for the implementation of corrective action.	<ul style="list-style-type: none"> <li>▪ “Many of the recommendations concerning the toe boards and safety slings as per API recommended practices made during our 2008 audit remain outstanding with no action taken..., not only is this an NOV requirement but also a lesson learned from industry incidents, including one on this rig, ...”<sup>1</sup></li> <li>▪ “NOV inspection reports dated August 2006 and May 2007 highlighted that both PRS’ had worn pins and bushes, it was highlighted during our last audit in January 2008 that although this</li> </ul>	<ul style="list-style-type: none"> <li>▪ April 2010 – Operations Manager Performance did not actively distribute the Operations Advisory or the revised well control published after the loss of well control during displacement of riser in the North Sea, despite being onboard during similar operations.</li> </ul>

<sup>504</sup> USCG-BOEMRE Public Hearings Witness testimonies; TRN-USCG\_MMS-00024204 through 00024211

<sup>505</sup> ISM Code Certification; TRN-USCG\_MMS-00059293

**Appendix K | EXAMPLES OF TRANSOCEAN’S NON-COMPLIANCE WITH THE INTERNATIONAL SAFETY MANAGEMENT CODE**

ISM Code	Requirement Description	<i>DEEPWATER HORIZON</i> Discrepancies	Other Transocean Situations
		<p>work was necessary to improve PRS reliability it had not been completed.”<sup>1</sup></p> <ul style="list-style-type: none"> <li>▪ “Test, middle and upper BOP ram bonnets are original and out with OEM and API five year recommended recertification period”<sup>1</sup></li> <li>▪ “As reported during our 2008 audit, comprehensive checks to verify proper operation of the anti-collision system (ACS) were still not being periodically undertaken. Clearly, lessons learned from the equipment collisions on this rig have not been fully implemented.”<sup>1</sup></li> <li>▪ “Despite previous recommendations it could not be demonstrated that all critical digital and analogue drilling instrumentation is being calibrated.”<sup>1</sup></li> <li>▪ “There is an issue with the dead man lever associated with the watertight door... The culture onboard is to start the open/close cycle then release the handle... This difference in operating philosophy also presents a risk to personnel and watertight door operation familiarization should be taken on an urgent basis.”<sup>1</sup></li> <li>▪ April 2010 – MODUSpec audit identified several discrepancies that violated USCG regulations and international standards, and if known by USCG, it would have resulted in ceasing of vessel’s operations<sup>484</sup></li> </ul>	
10.1	The Company should establish procedures to ensure that the ship is maintained in conformity with the provisions of the relevant rules and regulations and with any additional requirements which may be established by the Company.	<ul style="list-style-type: none"> <li>▪ September 2009 - BP Maritime Assurance Audit of <i>Deepwater Horizon</i> identified numerous discrepancies that violated USCG regulations and international standards, and if known by USCG, it would have resulted in ceasing of vessel’s operations<sup>1</sup></li> <li>▪ April 2010 – MODU Spec audit identified several discrepancies that violated USCG regulations and international standards, and if</li> </ul>	<ul style="list-style-type: none"> <li>▪ 16 May 2007 – “During the period 20-23 March 2007, the Petroleum Safety Authority Norway (PSA) conducted an audit of maintenance management in Transocean Offshore Ltd (TO). TO does not meet the regulatory requirements for maintenance management, nor does the company meet the requirements for handling of nonconformities. We found the conditions to be so serious that we issued a notification of order</li> </ul>

**Appendix K | EXAMPLES OF TRANSOCEAN’S NON-COMPLIANCE WITH THE INTERNATIONAL SAFETY MANAGEMENT CODE**

ISM Code	Requirement Description	<i>DEEPWATER HORIZON</i> Discrepancies	Other Transocean Situations
		<p>known by USCG, it would have resulted in ceasing of vessel’s operations<sup>484</sup></p> <ul style="list-style-type: none"> <li>▪ The Maintenance Management System, RMS II, was not effectively implemented. RMS II replaced Transocean’s Empack system after the corporate merger of Global Santa Fe, RMS II database listing redundant maintenance procedures, and required performance of maintenance of equipment not onboard the MODU resulting in significant overdue planned maintenance routines in excess of 30 days and totaled 390 routines corresponding to 3545 man hours.</li> <li>▪ Engine #1 and #4 were overdue for overhaul by 24k hrs while Thruster #2 was non operational</li> </ul>	<p>in a letter dated 23 March 2007, followed by an order in a letter dated 3 April 2007.”<sup>506</sup></p> <ul style="list-style-type: none"> <li>▪ May 2007 – Discoverer Spirit - Overdue planned maintenance tasks were noted in the unit’s planned maintenance system database, including five overdue items for equipment deemed safety critical.<sup>18</sup></li> <li>▪ July 2007 – Transocean Marianas - A number of planned maintenance tasks were noted in the unit’s planned maintenance system database, including some overdue items for equipment deemed safety critical.<sup>500</sup></li> <li>▪ March 2009 - GSF C.R. Luigs - A small number of overdue planned maintenance tasks were noted in the unit’s planned maintenance system database, including some overdue items for equipment deemed critical, dating back up to one month.<sup>495</sup></li> <li>▪ April 2009 - GSF Development Driller I - A small number of overdue planned maintenance tasks were noted in the unit’s planned maintenance system database, including some overdue items for equipment deemed critical.<sup>15</sup></li> <li>▪ April 2009 - GSF Development Driller II - A number of overdue planned maintenance tasks were noted in the units planned maintenance system database, including 20 items six months overdue for equipment deemed critical.<sup>497</sup></li> <li>▪ September 2009 - Discoverer Clear Leader - A large number of overdue planned maintenance tasks (approximately 650) were noted in the unit’s planned maintenance system database, including some overdue items for equipment deemed critical.<sup>498</sup></li> </ul>

<sup>506</sup> www. http://www.ptil.no/news/audit-of-maintenance-management-in-transocean-offshore-ltd-article3286-79.html

**Appendix K | EXAMPLES OF TRANSOCEAN’S NON-COMPLIANCE WITH THE INTERNATIONAL SAFETY MANAGEMENT CODE**

ISM Code	Requirement Description	DEEPWATER HORIZON Discrepancies	Other Transocean Situations
11.1	The Company should establish and maintain procedures to control all documents and data which are relevant to the safety management system.	<ul style="list-style-type: none"> <li>▪ “All too frequently maintenance history was substandard with missing information and poor quality reports that lacked sufficient detail to convince the reader that the task had been performed in accordance with the procedure.”<sup>1</sup></li> </ul>	<ul style="list-style-type: none"> <li>▪ April 2008 – Transocean Offshore Deepwater Drilling Inc. - Currently, an overview of the Fleet ISM certification, internal/external audit status, and Master’s Review status is not easily obtained.</li> </ul>
12.2	The Company should periodically evaluate the efficiency of and, when needed, review the safety management system in accordance with procedures established by the Company.	<ul style="list-style-type: none"> <li>▪ “Closing out of the last audit recommendations had no apparent verification by BP. Consequently a number of recommendations that Transocean had indicated as closed out had either deteriorated again or not been suitably addressed in the first instance”<sup>1</sup></li> </ul>	
12.6	The management personnel responsible for the area involved should take timely corrective action on deficiencies found.		<ul style="list-style-type: none"> <li>▪ October 2009 - After almost 8 years after the implementation of the ISM Code for MODU, Transocean senior executives failed to ensure the company’s full compliance with the ISM Code<sup>507</sup></li> </ul>
13.4	The validity of a Document of Compliance should be subject to annual verification by the Administration or by an organization recognized by the Administration or, at the request of the Administration, by another Contracting Government within three months before or after the anniversary date.	<ul style="list-style-type: none"> <li>▪ 11 April 2010 - “Last external audit of this office was 2006-12-11, and external Company audit plan not found available.”<sup>508</sup></li> </ul>	<ul style="list-style-type: none"> <li>▪ April 2010 - Transocean Discoverer Deep Seas operated with an invalid Safety Management Certificate<sup>507</sup></li> </ul>

<sup>507</sup> TRN-USCG\_MMS-00039100 & 1

<sup>508</sup> DNV Job ID 196115



Commanding Officer  
United States Coast Guard  
Marine Safety Center

2100 2ND ST SW STOP 7102  
WASHINGTON DC 20593-7102  
Staff Symbol: MSC-1  
Phone: (202) 475-3401  
Fax: (202) 475-3920  
Email: [mso@uscg.mil](mailto:mso@uscg.mil)

16732/P015713  
Serial: H1-1100432  
01 March 2011

## MEMORANDUM

From: [REDACTED]  
CG MSC - SERT

Reply to LT [REDACTED]  
Attn of: (202) 475-3396

To: [REDACTED]  
Co-chair, DEEPWATER HORIZON Joint Investigation Team

Subj: POST SINKING ANALYSIS FOR DEEPWATER HORIZON, IMO 8764597

1. As requested, we performed a technical analysis of the stability of the DEEPWATER HORIZON. Our review of the operational load conditions in the rig's Operations Manual indicated that those conditions met the applicable intact and damaged stability criteria in the IMO MODU Code. In addition, our analysis confirmed the validity of the loading restrictions imposed in the Stability Letter issued by the American Bureau of Shipping in 2001. Because details of the rig's loading condition immediately prior to the casualty are unknown, it was not possible to determine whether or not she was in compliance with her Stability Letter at that time.

2. The extent of damage required by the IMO MODU Code's damage stability criteria is limited to the outer shell area of the columns, consistent with a collision with another vessel at or near the waterline. We are confident that the IMO MODU Code's required extents of damage are clearly not intended to address the type of casualty sustained by the DEEPWATER HORIZON.

3. The lack of information regarding the DEEPWATER HORIZON's loading, extent of damage, and sources of flooding made it impossible to conduct a conclusive analysis of the factors that contributed to her sinking. An analysis of photographs taken in the hours before she sank, indicated that weight was added to the starboard aft quadrant of the rig. The nearly infinite permutations and combinations of hull damage scenarios and flooded compartments make it impossible to determine the dominant source of added weight or lost buoyancy. Ultimately, through some unknown combination of floodwater and a lack of watertight integrity, the rig's weight exceeded the available buoyancy, resulting in sinking.

4. Enclosure (1) is a detailed explanation of our assumptions and analysis.

5. If you have questions or need additional information, please contact LT Andrew Lawrence of our staff.

#

Enclosure: (1) Explanation of Analysis & Assumptions

## EXPLANATION OF ANALYSIS & ASSUMPTIONS

### 1 General Comments Regarding Our Stability Analysis

- Our computer model's hull geometry was created using R&B Falcon, Drawing D-87-G13, rev. 4A, "Construction Lines," 2 sheets, dated July 18, 1999.
- Our computer model's compartmentation was created using R&B Falcon, Drawings HRBS-058-000-P-0607, 058-000-P0608, 058-000-P0609, 058-000-P0611, 058-000-P0613 058-000-P0617, rev. 5, "General Arrangement," dated January 18, 2001
- Creative Systems General HydroStatics (GHS) software version 12.26B was used for our analysis.
- All longitudinal references in this report are measured from amidships (MS) located at frame 23. Vertical references and drafts were measured from a baseline (BL) located at the bottom of the pontoons.
- All weights are reported in metric tons (MT). One MT is equivalent to 2205 pounds.
- Downflooding points are described in the Operations Manual in Appendix A (page A-25) and in the Stability Letter issued by the American Bureau of Shipping (ABS) (page A-33)
- The DEEPWATER HORIZON is a foreign-flagged mobile offshore drilling unit (MODU) and, as such, is subject to the International Maritime Organization (IMO) Code for the Construction and Equipment of Mobile Offshore Drilling Units, Resolution A.649(16), 1989, (MODU Code) for intact and damaged stability.

### 2 Model Development

The computer model used throughout this analysis was created using the Construction Lines Plan (shown in Figure 1). Compartmentation and superstructure were added to the model based on the provided General Arrangements. Our model's hydrostatic properties were validated against the hydrostatics tables provided in Appendix A of the Operations Manual (pages A-8 through A-12) and are accurate to within 1.4% of those listed in the Operations Manual.

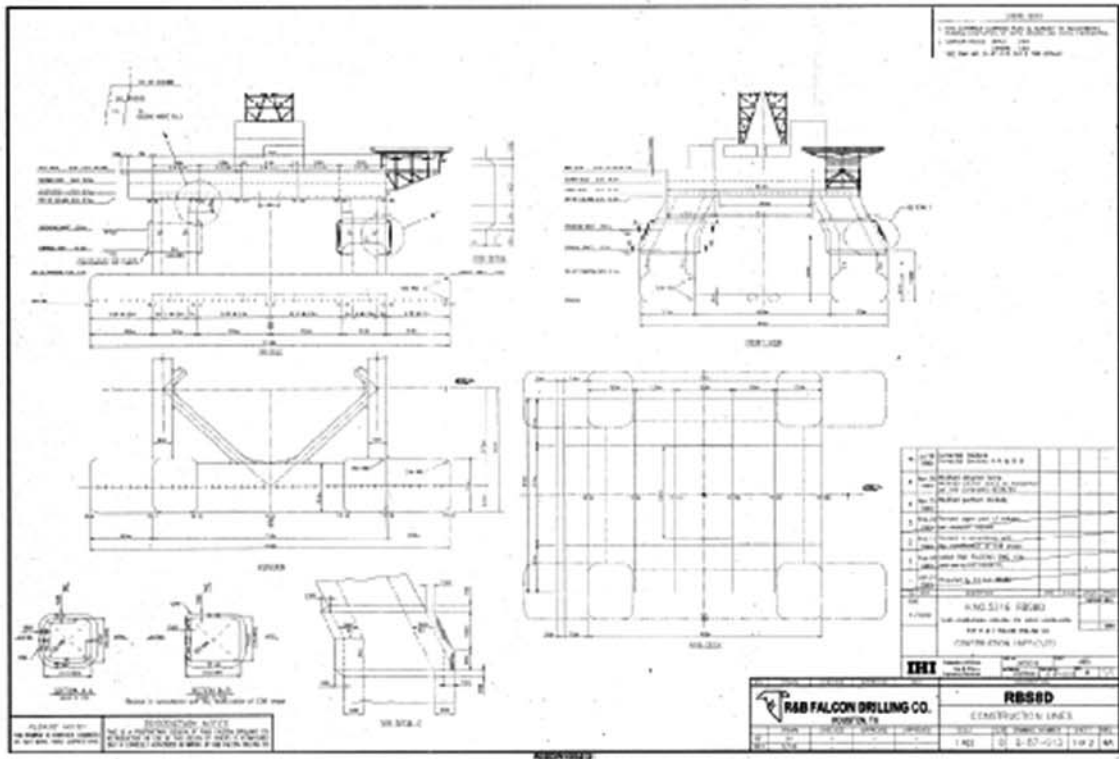

Figure 1: Construction Lines for the DEEPWATER HORIZON (Sheet 1)

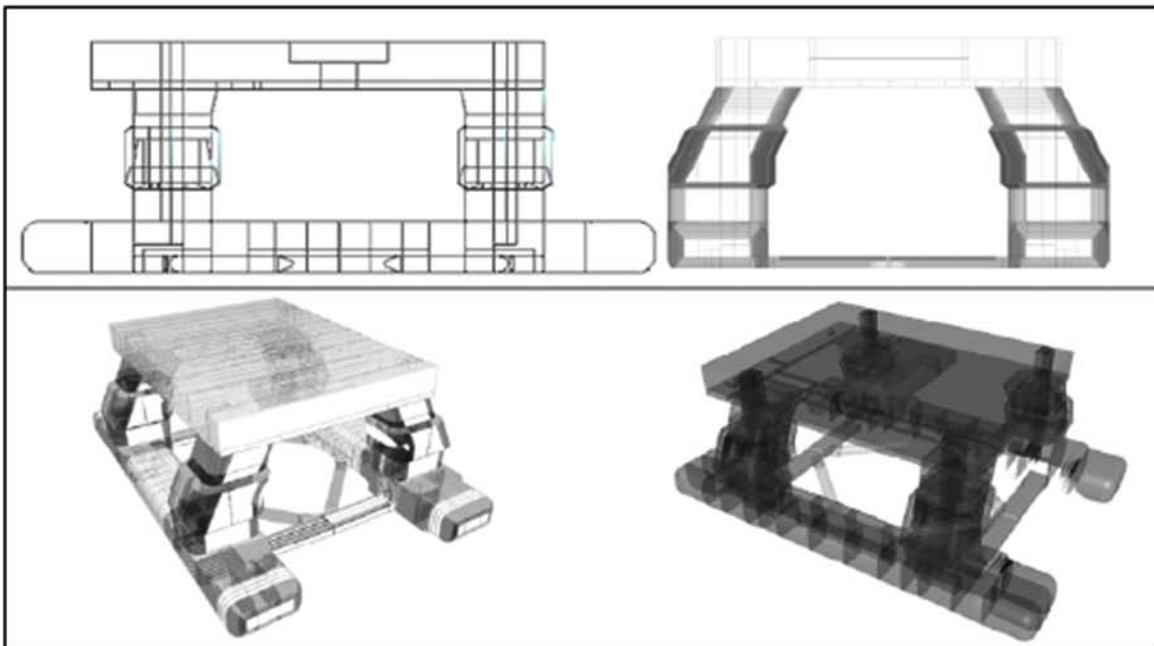

Figure 2: MSC's Computer Model of the DEEPWATER HORIZON



### 3 Intact and Damaged Stability Review

The intact and damaged stability requirements applicable to the DEEPWATER HORIZON at the time of her construction are contained in the MODU Code. For intact stability in the normal operating condition, the MODU Code requires that righting energy exceed heeling energy by at least 30 percent when subjected to a 70 knot wind from any direction. In an intact survival condition, the righting energy must also exceed heeling energy by at least 30 percent when subjected to a 100 knot wind from any direction. To reach the survival condition, the rig's freeboard may be increased by discharging ballast, but solid and other variable loads must be retained onboard.

The MODU Code also provides damage stability requirements for conditions where the rig sustains damage to periphery compartments located from 5 meters above to 3 meters below the rig's intact waterline. In each damage stability scenario, only one compartment is damaged if that compartment extends more than 1.5 meters in from the side shell, is more than 3 meters in height, and extends over more than 1/8 of the side shell of a column. These damage extents are consistent with a collision scenario at or near the waterline.

When the rig is subjected to the extent of damage listed above, the MODU Code requires the rig to come to equilibrium at a static heel angle less than 17 degrees, with weathertight downflooding points more than 4 meters above the damaged waterline, and with residual righting energy that exceeds the heeling energy caused by a 50 knot wind by 100%.

The ABS issued a Stability Letter for the DEEPWATER HORIZON in February of 2001 after verifying compliance with multiple standards, including the MODU Code. The ABS's stability approval and subsequent loadline assignment limited the rig to a maximum draft of 23 meters and to a table of maximum vertical centers of gravity (VCG) at operational drafts ranging from 20 meters to 23 meters.

Based on our independent analysis of the DEEPWATER HORIZON's intact and damage stability, we concur with the limits provided in the ABS Stability Letter. In our independent review, we did not evaluate the heeling moment due to the thrusters because no thrust was provided during the casualty. Table 1 shows how our independent stability review limits compare with those provided by ABS's Stability Letter for the "no thrust" condition. ABS' maximum VCG values are slightly more conservative than ours; these differences are within expected tolerance, resulting from minor variations in the hull model.

Baseline Operational Draft (meters)	ABS Letter Maximum VCG (meters)	Independent Review Maximum VCG (meters)
23.0	22.77	22.77
22.0	22.91	23.32
21.0	23.48	24.09
20.5	23.86	24.52
20.0	24.24	25.00

Table 1: Stability Review, Limiting VCG Comparison

#### 4 Load Condition at the Time of the Casualty

##### 4.1 Pre-Casualty

Based on witness testimony, the DEEPWATER HORIZON was approximately at a 23 meter draft prior to the casualty. This is consistent with the draft specified in the “Gulf of Mexico Max. Load Condition” as described on page B-51 of the Operations Manual. Using this draft, we know from the hydrostatics tables in the Operations Manual, as well as our own computer model, that the DEEPWATER HORIZON displaced approximately 52,800 MT with a longitudinal center of gravity (LCG) and transverse center of gravity (TCG) located at amidships on centerline. Normally, a VCG is necessary to calculate the LCG and TCG associated with a given trim and heel, however in this case, since the underwater body is symmetric fore and aft, a zero trim condition implies an LCG at amidships with a TCG on centerline.

The exact tank loading, variable deck loads, and other deadweight items are not available, making it impossible to determine the rig’s VCG. Without this information, we could not evaluate whether the DEEPWATER HORIZON was in compliance with her Operations Manual and applicable regulatory stability criteria at the time of the casualty.

##### 4.2 During the Casualty

Without information on the rig’s loading prior to the casualty, it is impossible to analyze specific damage scenarios. We also lack precise information regarding the rig’s draft, heel, and trim as the casualty progressed. However, using photographs of the DEEPWATER HORIZON during the casualty, we estimated her waterplane in the damaged, floating condition. To estimate the waterplane, we used photographs taken at known times and identified three recognizable hull locations that intersected the waterline. The hull locations at the waterline that we used are marked on the photographs (see below) with yellow circles. Figure 3 and Figure 4 were reportedly taken at 0612 on April 22, 2010. Figure 5 and Figure 6 illustrate how the waterplane estimated from these photographs looks when applied to our computer model. Figure 7 and Figure 8 were taken at approximately 1030 on April 22, 2010, just prior to the rig sinking. Figure 9 and Figure 10 illustrate how the waterplane that was estimated from these photographs looks when applied to our computer model. Although the extent of damage shown in Figure 7 and Figure 8 indicate that some hull deflection may exist, our waterplane estimates cannot account for deflection and necessarily assume that the hull was not deflecting in the pictures.



Figure 3: DEEPWATER HORIZON, Port Bow Aspect (0612 on 22 April 2010)

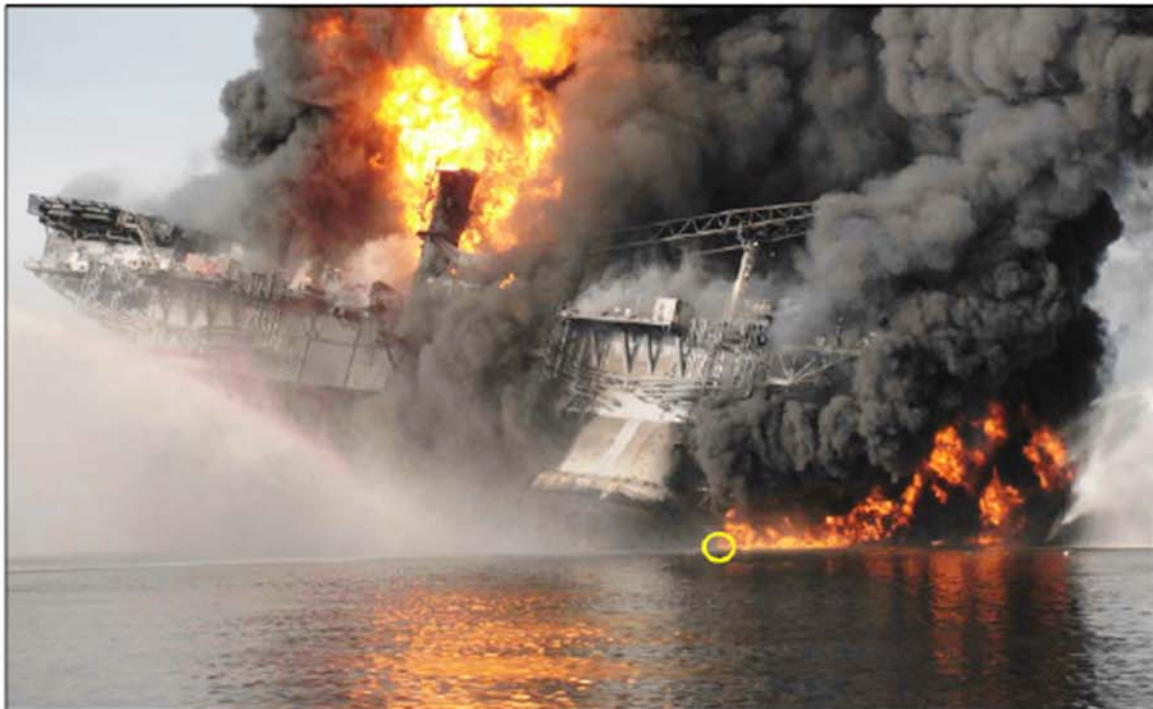

Figure 4: DEEPWATER HORIZON, Port Aspect (0612 on 22 April 2010)

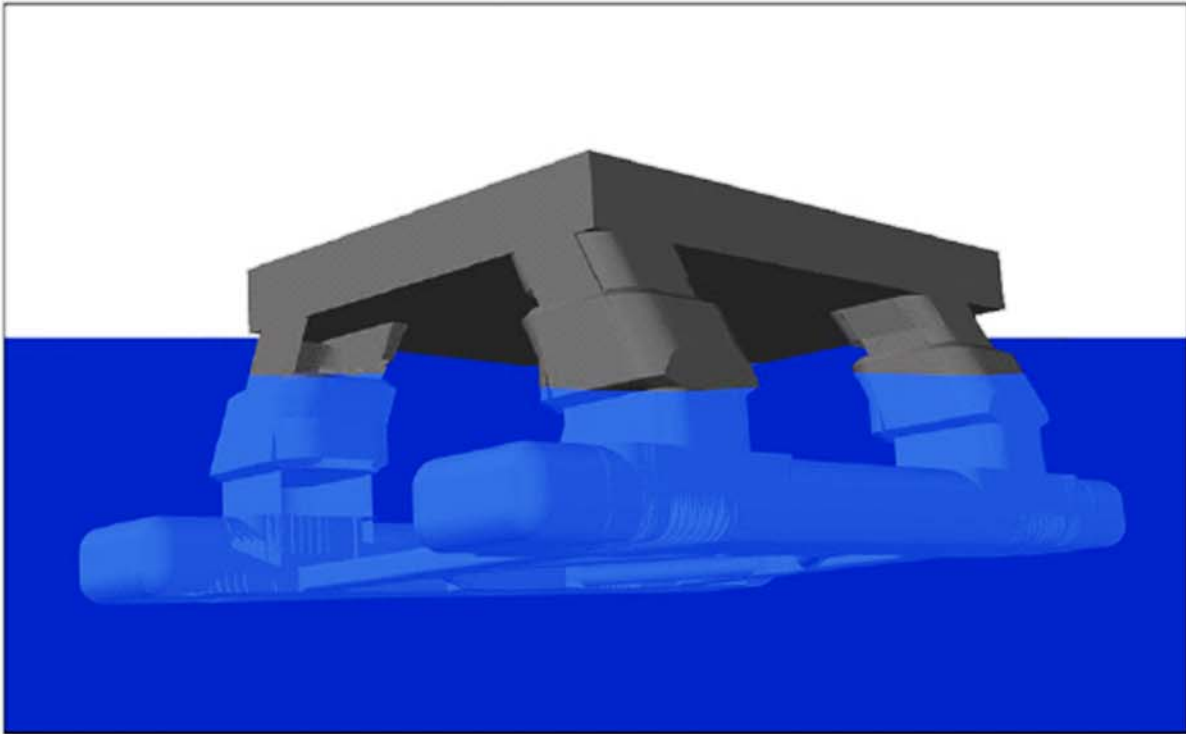

Figure 5: Computer Model Showing the Estimated Waterline, Port Bow Aspect (0612 on 22 April 2010)

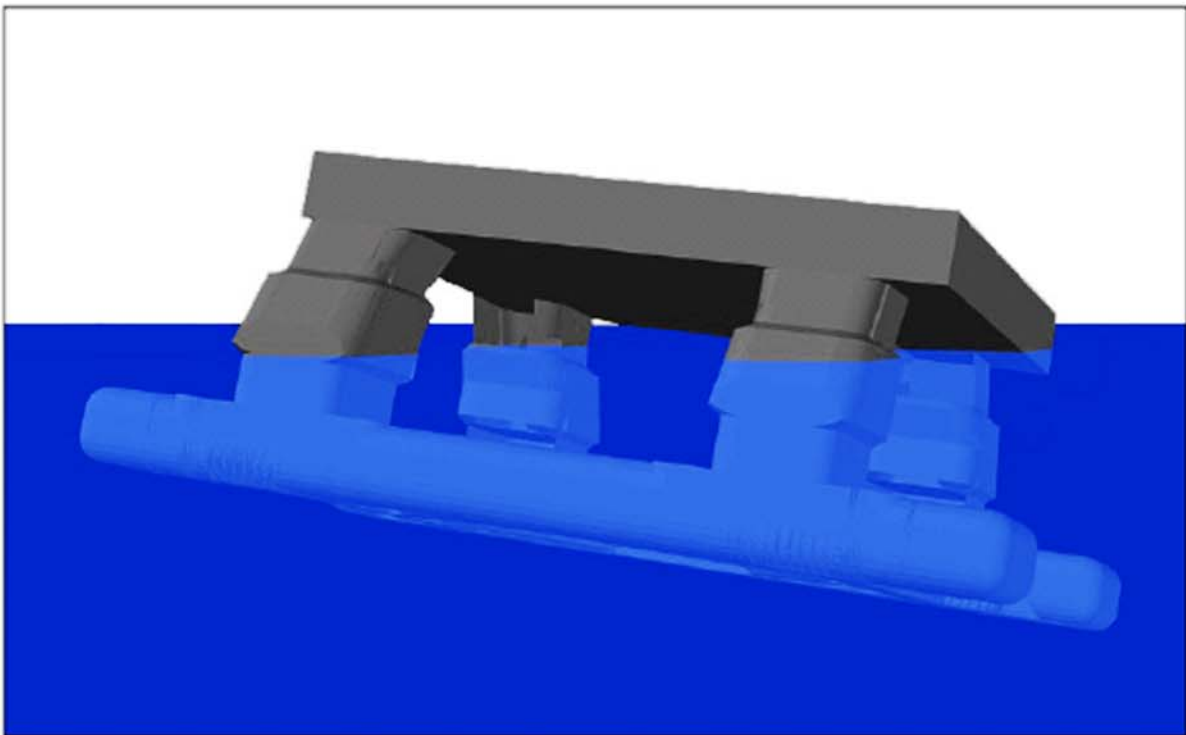

Figure 6: Computer Model Showing the Estimated Waterline, Port Aspect (0612 on 22 April 2010)

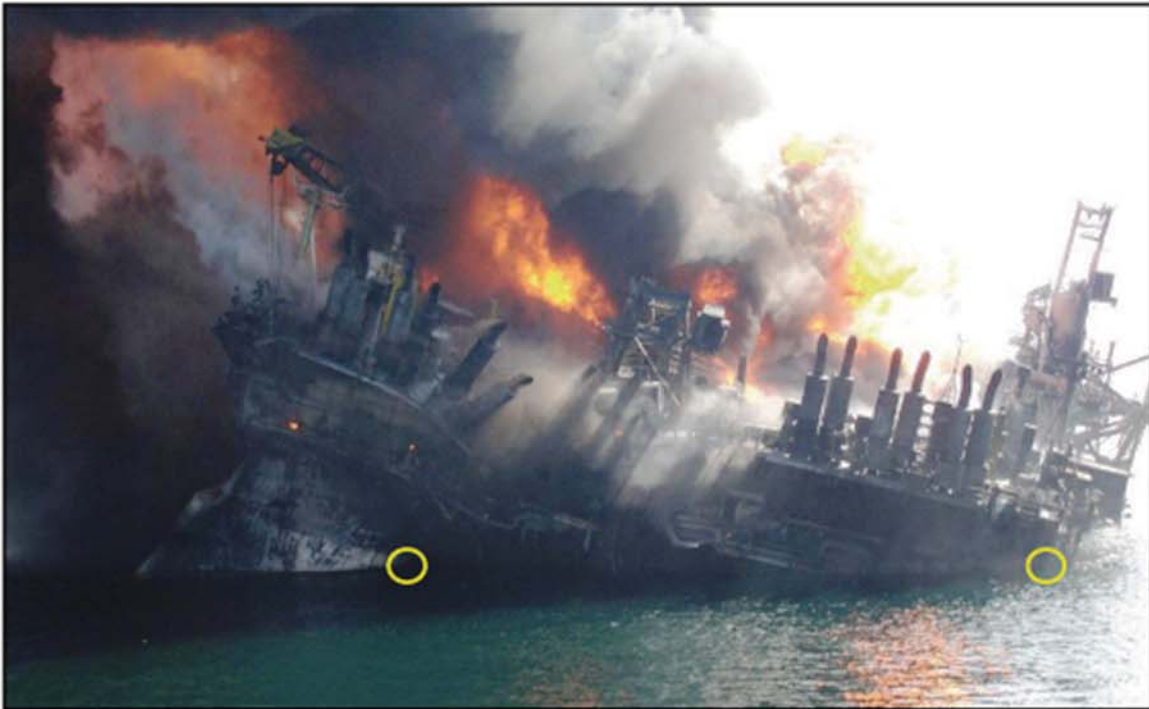

Figure 7: DEEPWATER HORIZON, Stern Aspect (1034 on 22 April 2010)



Figure 8: DEEPWATER HORIZON, Starboard Quarter Aspect (1023 on 22 April 2010)

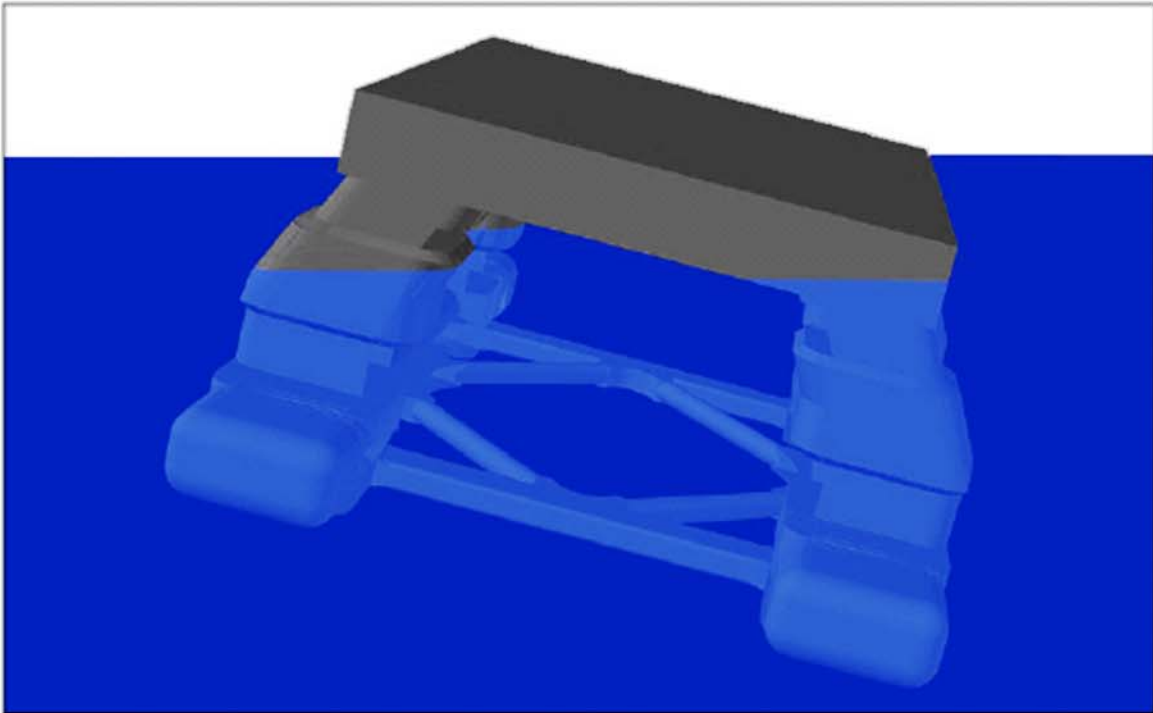

Figure 9: Computer Model Showing the Estimated Waterline, Stern Aspect (1034 on 22 April 2010)

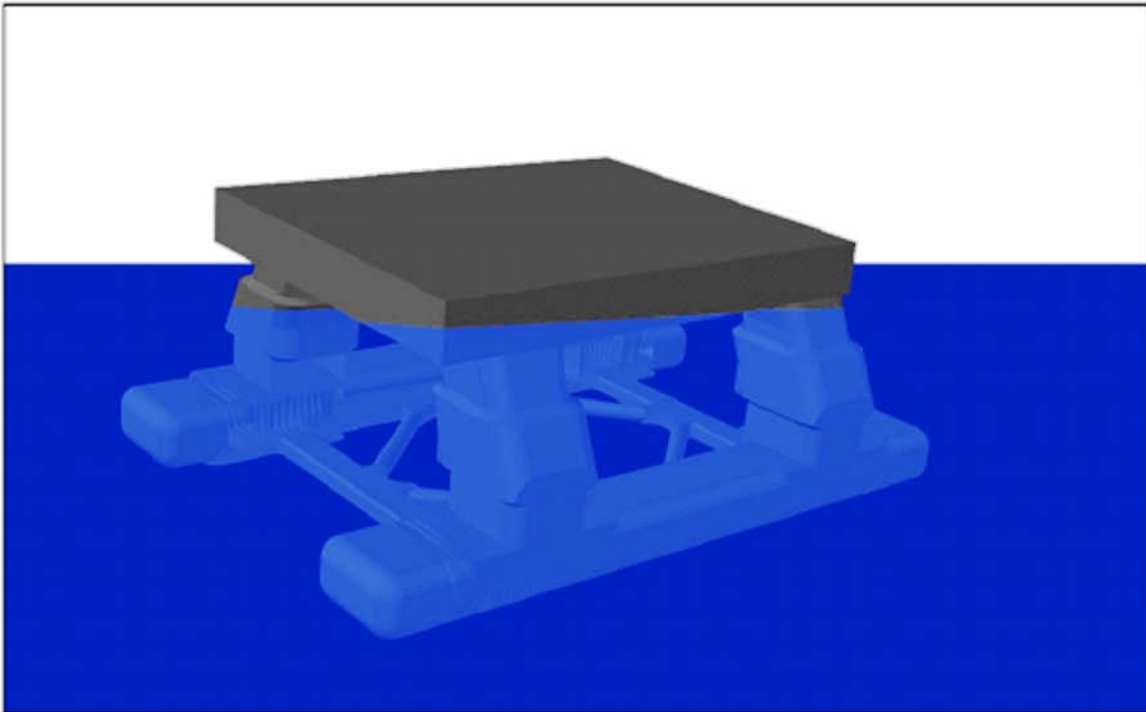

Figure 10: Computer Model Showing the Estimated Waterline, Starboard Quarter Aspect (1023 on 22 April 2010)

**5 Analysis**

Based on the waterplane estimates shown in Figures 5, 6, 9, and 10, we estimated the displacement, heel, and trim at two discrete times: 0612 and 1030 on 22 April 2010. The rig’s attitude and displacement for these conditions, as well as the presumed 23 meter draft pre-casualty condition are shown in Table 2. These results show that the rig’s displacement had increased by approximately 1500MT at 0612 and by 2300MT at 1030 on 22 April 2010. Changes in displacement describe the cumulative effect of added weight (or lost buoyancy) required for the rig to achieve its estimated waterline. The results shown in Table 2 indicate that the vessel must have experienced flooding, either as the result of damage to the watertight envelope, or as a result of downflooding caused by firefighting water and/or downflooding through preexisting openings, or some combination thereof. In other words, without any flooding, the shifting of on-board weights such as ballast, topside loads, and/or the toppling of the derrick, either alone or in combination, would not have been sufficient to place the vessel in the conditions shown in Table 2.

Condition	Displacement, metric tons	Heel	Trim
23 meter draft	52,800	0°	0°
0612 on 22 April 2010	54,300	11° to starboard	6° aft
1030 on 22 April 2010	55,100	15° to starboard	5° aft

Table 2: Displacement, Heel, and Trim for Estimated Waterplanes

For the purpose of comparison, the changes in displacement are listed in Table 3 and converted to volume.

Condition	Change in Displacement, metric tons	Change in Displaced Volume, gallons	Side length of an equivalent cube of seawater, meters (feet)
0612 on 22 April 2010	1,500	400,500	12 (38)
1030 on 22 April 2010	2,300	622,100	13 (44)

Table 3: Change in Displacement Volume Comparisons

The exact location of flooding cannot be determined because the rig’s initial loading condition, sources of floodwater, and potential damage to watertight boundaries are unknown. We identified numerous hypothetical scenarios in which various combinations of compartments in either the upper hull, starboard aft column, or starboard pontoon were flooded, each of which could have caused the rig to attain the approximate attitude and displacement shown in the photographs above. In short, there are a large number of flooding scenarios that could have caused the rig to attain its observed condition of draft, trim and heel. The actual scenario cannot be determined with the information available.

Assuming that the DEEPWATER HORIZON had a 23 meter draft prior to the blowout at approximately 2200 on 20 April, the rate at which her estimated displacement changed was non-linear. In the first 32 hours after the casualty, from 2200 on 20 April until 0612 on 22 April, we estimate that the rig's displacement increased by 1500MT. In the subsequent 4 hour period, from 0612 to 1030 on 22 April, we estimate that the rig's displacement increased an additional 800MT. One possible reason for this increased rate is the significant structural damage visible in Figure 7 and Figure 8, indicating compromised watertight integrity of the upper hull. This lack of watertight integrity may have allowed free ingress of seawater into compartments of the upper hull as the starboard aft section submerged.

## 6 Conclusions

Our independent analysis of the operational load conditions in the DEEPWATER HORIZON's Operations Manual indicated that those conditions met the applicable intact and damaged stability criteria in the MODU Code. In addition, our analysis confirmed the validity of the loading restrictions imposed in the Stability Letter issued by the ABS in 2001. Because the rig's loading condition immediately prior to the casualty is unknown, it was not possible to determine whether or not she was in compliance with her Stability Letter at that time.

The extent of damage required by the IMO MODU Code is limited to the outer shell area of the columns, consistent with a collision with another vessel at or near the waterline. The compartments within the columns of the DEEPWATER HORIZON were arranged to limit the effects from this type of damage and ensure compliance with damaged stability requirements. The extent of damage, if any, to the rig's columns cannot be discerned from available photographic evidence. These photographs do, however, show significant damage to the upper hull and topside equipment. The MODU Code's required extents of damage are clearly not intended to address the type of casualty sustained by the DEEPWATER HORIZON.

The lack of information regarding the DEEPWATER HORIZON's loading, extent of damage, and sources of flooding made it impossible to conduct a conclusive analysis of the factors that contributed to her sinking. An analysis of photographs taken in the hours before she sank indicated that weight was added to the starboard aft quadrant of the rig. The nearly infinite permutations and combinations of hull damage and compartments flooding scenarios make it impossible to determine the dominant source of added weight or lost buoyancy. Ultimately, through some unknown combination of floodwater and a lack of watertight integrity, the rig's weight exceeded the available buoyancy, resulting in sinking.



## Appendix M | OPERATIONAL RISK ASSESSMENT

Using the guidance in the Coast Guard Marine Safety Manual Volume V on causal analysis and the standards identified in various International Maritime Organization (IMO) and the Republic of the Marshall Islands guidelines, an operational risk assessment model was developed by the Joint Investigation Team. This is the first time such a model has been used and it does not have Coast Guard Headquarters approval.

The first diagram outlines the model. It identifies the system and organization factors involved that can reduce or enhance (increase) risk and whether the risk increase poses a moderate or serious enhanced risk. Time may be allowed to correct Moderate risks. However, serious risk discrepancies require immediate action, such as exercising stop work authority, detaining the vessel, or removing certificates.

The second diagram applies this model to evaluate the status of *DEEPWATER HORIZON* and the operating environment at the time of the casualty. The results of the evaluation illustrate that immediate action should have been taken, such as *DEEPWATER HORIZON* crew exercising their Stop Work Authority or reporting the discrepancies to the Coast Guard.

The fact that the crew did not exercise their stop work authority or report the unsafe working conditions reflects problems in the Stop Work Authority and the unsafe working conditions reporting programs.

**OPERATIONAL RISK ASSESSMENT MODEL**

	COMMON FACTORS <sup>509</sup>	RISK CHARACTERIZATION		
		GREEN (Risk Reducer)	YELLOW (Risk Enhancer)	RED (Risk Enhancer)
<b>SYSTEM</b> <sup>510,511</sup>	<ul style="list-style-type: none"> <li>▪ Vessel Design</li> <li>▪ Vessel Inspection</li> <li>▪ Vessel Maintenance</li> <li>▪ Safety Management System</li> <li>▪ Emergency Preparedness</li> </ul>	Condition or tool that reduces risk. For example, <ul style="list-style-type: none"> <li>- Quality operator</li> <li>- Non-novel vessel</li> <li>- Routine operation</li> <li>- Vessel Safety Management System (SMS) in Compliance with International Safety Management (ISM) Code</li> </ul>	Discrepancy that poses a MODERATE threat to the safety of personnel or the ship or a serious risk to the environment that MAY BE ALLOWED TIME to correct. For example, <ul style="list-style-type: none"> <li>- CG-835 cited items</li> <li>- ISM Code non-conformity or observation</li> <li>- Items pending regulatory action</li> </ul>	Discrepancy that poses a SERIOUS threat to the safety of personnel or the ship or a serious risk to the environment that requires IMMEDIATE corrective action. For example, <ul style="list-style-type: none"> <li>- Loss of situational awareness</li> <li>- Port State Control (PSC) detainable discrepancies</li> <li>- ISM Code major non-conformity</li> </ul>
<b>ORGANIZATION</b> <sup>509,510</sup>	<ul style="list-style-type: none"> <li>▪ Staffing/Manning</li> <li>▪ Training</li> <li>▪ Organizational Structure</li> <li>▪ Chain of Command</li> <li>▪ Delegation of Authority</li> <li>▪ Communications</li> <li>▪ Operational Culture</li> <li>▪ Norms and Rules</li> <li>▪ Values and Beliefs</li> <li>▪ Operational Tempo</li> <li>▪ Time Pressures</li> <li>▪ Incentives</li> <li>▪ Risk Management</li> <li>▪ Safety Management</li> <li>▪ Operations &amp; Internal Oversight</li> <li>▪ Regulations &amp; External Oversight</li> <li>▪ Laws/Regulations</li> <li>▪ Standards</li> <li>▪ Enforcement</li> </ul>	<ul style="list-style-type: none"> <li>- Complying with Standards of Training, Certification and Watchkeeping (STCW) Code</li> <li>- Empowering safety personnel &amp; integrating them in operation</li> <li>- Conducting internal safety surveys and following up on results</li> </ul>	<ul style="list-style-type: none"> <li>- ISM Code non-conformity or observation</li> <li>- Items pending regulatory action</li> <li>- Operator not ensuring adequate experience of key personnel</li> </ul>	<ul style="list-style-type: none"> <li>- PSC detainable discrepancies</li> <li>- Attitude of non-compliance toward regulatory requirements</li> <li>- Unwillingness to report unsafe operations</li> <li>- Unwillingness to accept responsibility</li> <li>- Not learning from past incidents</li> <li>- Flag state not in compliance with International Maritime Organization (IMO) Resolution A.739(18)<sup>512</sup></li> <li>- Flag state or its recognized organization not in compliance with IMO MSC/Circ. 1059 MEPC/Circ. 401<sup>513</sup></li> </ul>

<sup>509</sup> USCG Marine Safety Manual Volume V, Investigations and Enforcement

<sup>510</sup> International Maritime Organization Resolution A.787(19), Procedures for Port State Control

<sup>511</sup> Republic of the Marshall Islands Marine Notice No. 2-011-13, International Safety Management (ISM) Code

<sup>512</sup> International Maritime Organization Resolution A.739(18), Guidelines for the Authorization of Organizations Acting On the Behalf of the Administration

<sup>513</sup> International Maritime Organization MSC/Circ. 1059 MEPC/Circ. 401, Procedures Concerning Observed ISM Code Major Non-Conformities

***Model Applied to DEEPWATER HORIZON CASUALTY***

SYSTEM <sup>508</sup>	GREEN (Risk Reducer)	YELLOW (Risk Enhancer)	RED (Risk Enhancer)
	<ul style="list-style-type: none"> <li>▪ Coast Guard QUALSHIP21-designated flag state</li> <li>▪ Transocean THINK planning process</li> <li>▪ Transocean START process</li> </ul>	<p><i>DEEPWATER HORIZON</i></p> <ul style="list-style-type: none"> <li>- Fire &amp; gas detection system logic was not configured to stop operating machinery or close ventilation dampers if explosive gases were detected</li> <li>- Non-random drill schedule did not prepare crew for actual emergency</li> <li>- Did not utilize class optional certification of drilling package since 2005</li> </ul> <ul style="list-style-type: none"> <li>▪ Transocean                             <ul style="list-style-type: none"> <li>- Emergency Response Center did not have updated information on BOP configuration</li> </ul> </li> <li>▪ IMO 1989 MODU Code                             <ul style="list-style-type: none"> <li>- Lifeboat design did not adequately provide for placement of a stretcher or reflect actual physical build of average offshore worker</li> <li>- Subjective language “when practicable” reduced effectiveness of emergency preparedness</li> <li>- No guidance on the continued inspection, testing, repair and maintenance of classified electrical equipment</li> <li>- No guidance on design and arrangement of gas detection and alarm systems</li> <li>- No minimum standards for blast resistance of occupied structures</li> <li>- Not require separation of emergency generator air inlets from likely sources of combustible gases</li> <li>- Inadequate level of fire protection when considering fires originating from the Drill Floor</li> <li>- Lifeboat embarkation station not adequately shielded from radiant heat of fire</li> <li>- No requirement for man overboard drill</li> <li>- Lack of requirements on crisis management and crowd control for MODU</li> </ul> </li> </ul>	<ul style="list-style-type: none"> <li>▪ <i>DEEPWATER HORIZON</i> <ul style="list-style-type: none"> <li>- Poor materiel conditions, unsafe work practices &amp; inadequate training (see Appendix J)</li> <li>- Loss of situational awareness; too many activities were going on during temporary plugging and abandonment operation</li> <li>- Systemic failure of vessel’s Safety Management System (see Appendix K)</li> </ul> </li> <li>▪ Transocean                             <ul style="list-style-type: none"> <li>- Corporate emergency response team was not adequately trained</li> <li>- Systemic failure of company’s Safety Management System (see Appendix K)</li> </ul> </li> </ul>

***Model Applied to DEEPWATER HORIZON CASUALTY***

ORGANIZATION <sup>509,510</sup>	GREEN (Risk Reducer)	YELLOW (Risk Enhancer)	RED (Risk Enhancer)
	<ul style="list-style-type: none"> <li>▪ Transocean                             <ul style="list-style-type: none"> <li>- HSE Bridging Document for occupational safety</li> </ul> </li> <li>▪ Coast Guard                             <ul style="list-style-type: none"> <li>- Newly-established Offshore Center of Expertise</li> </ul> </li> </ul>	<p><i>DEEPWATER HORIZON</i></p> <ul style="list-style-type: none"> <li>- Dual-command organizational structure adversely impacted vessel senior leaders' situational awareness, risk assessment &amp; decision making</li> <li>- No training or instruction was provided for crew members on watch in the CCR on how to activate the ESD systems in the event of fire or gas detection</li> <li>- Workers worried about drilling priorities taking precedence over planned maintenance<sup>514</sup></li> <li>- Workers felt they could not report actions leading to a "risky" situation without retaliation<sup>513</sup></li> </ul> <ul style="list-style-type: none"> <li>▪ Transocean                             <ul style="list-style-type: none"> <li>- Lack of a bridging document to coordinate marine &amp; drilling operations</li> <li>- Lack of compatible model that could be used by both Transocean and SMIT personnel</li> </ul> </li> <li>▪ RMI                             <ul style="list-style-type: none"> <li>- Did not provide proper oversight of its recognized organizations (ABS, DNV)</li> <li>- Did not investigate <i>DEEPWATER HORIZON</i>'s complete loss of electrical power and flooding casualties in 2008</li> </ul> </li> <li>▪ USCG                             <ul style="list-style-type: none"> <li>- Regulations for Outer Continental Shelf activities have not been updated since 1982</li> <li>- Lack of a coordinated off-shore fire-fighting response policy</li> </ul> </li> </ul>	<ul style="list-style-type: none"> <li>▪ <i>DEEPWATER HORIZON</i> <ul style="list-style-type: none"> <li>- Despite poor materiel conditions and concerns about multiple activities during plugging and abandonment operation, no one exercised their Stop Work Authority</li> <li>- Lack of unit's loading information</li> <li>- Did not conduct a deadweight survey every 5 years as required</li> </ul> </li> <li>▪ Transocean                             <ul style="list-style-type: none"> <li>- Policy on using its condition-based maintenance program, vice complying with regulatory requirements</li> <li>- Lack of commitment to ensure its full compliance with ISM Code</li> <li>- Lack of communication between Transocean Command Center and the representative on scene</li> </ul> </li> <li>▪ RMI                             <ul style="list-style-type: none"> <li>- DNV failed to identify systemic failure of Transocean's Safety Management System</li> </ul> </li> </ul>

<sup>514</sup> Lloyd's Register Safety Survey of *DEEPWATER HORIZON* Workers

**Distribution**

1. [REDACTED] Deepwater Horizon Wells Team Leader
2. [REDACTED] Wells Manager
3. [REDACTED] GoM Wells Engineering Authority
4. [REDACTED] GoM Marine Authority
5. Central File EPT Drilling, Sunbury

**Deepwater Horizon  
Follow Up Rig Audit, Marine Assurance  
Audit and Out of Service Period  
September 2009**

Prepared by

.....  
[REDACTED]  
Rig Auditor  
24 September 2009

Approved by

.....  
[REDACTED]  
Manager, Specialist Technical Support - Rig Audit  
30 September 2009

### Executive Summary

A rig and marine assurance audit was performed on the semi submersible drilling rig Deepwater Horizon. The rig was audited on location at the Kodiak prospect at Mississippi Canyon 7-27. The audit was undertaken by a four man team from 13 to 17 September 2009.

The rig commenced the out of service period on 31 August 2009 to undertake Underwater In Lieu of Dry-dock (UWILD) inspection, DP system upgrades, refurbishment of the forward and aft PRS and replacement of the iron roughneck.

Prior to recommencing operations the rig was subject to a follow up rig and marine assurance audit, and key function testing such as black out recovery, customer acceptance trials concerning DP control system upgrades. Planned checks to verify the functionality of the drill floor anti collision system and reliability of the iron roughneck and PRS could not be performed as on departure from the rig issues with this equipment were still being addressed.

The audit made a number of findings, based on the nature of these findings, i.e. rig floor non operational, and the potential adverse effect on rig emergency preparedness and watertight integrity regarding the marine related issues a recommendation was made to the Wells Team to suspend operations until many have been satisfactorily addressed.

Findings of particular note were the following:

- Closing out of the last audit recommendations had no apparent verification by BP. Consequently a number of the recommendations that Transocean had indicated as closed out had either deteriorated again or not been suitably addressed in the first instance.
- Control of work issues identified specifically with isolation permit process and integrity of mechanical isolations
- Numerous personnel changes had occurred in the eighteen months since our last audit. These were seen at all levels and all disciplines.
- Overdue planned maintenance considered excessive 390 jobs amounting to 3545 man hours. With the recent shift from Empac to RMS II maintenance systems and revised maintenance scheduling the back log does not look as though it will improve
- The aft PRS was non operational, the retract function of the lower arm was defective
- The iron roughneck could not be made to operate from Cyberbase unless the anti collision system was in override

- Top drive guard is not fitted with a safety sling, not only is this an NOV requirement but also a lesson learned from industry incidents, including one on this rig, where the guard had been knocked off due to equipment clash.
- Annual drawworks maintenance routine overdue since February 2009, includes critical checks on the braking system
- Test, middle and upper BOP ram bonnets are original and out with OEM and API five year recommended recertification period.
- The port aft quadrant watertight dampers failed to close when tested
- The starboard aft quadrant bilge and ballast valves, ballast pump and tank sounding system were rendered inoperable due to a process station (PCU 18) card failure
- Three out of four electric bilge pumps were tested, all three failed to achieve suction due to defective priming systems
- Emergency bilge suction check valve integrity checks concluded valves were passing
- Several hydraulic watertight door issues concerning both operability and functionality. Insufficient onboard spares to make repairs
- Just one of the eight seawater cooling pumps was totally defect free. Two of the defective pumps were identified during the previous audit (January 2008) while some of the defective pumps could be operated, four pumps were deemed non operational

### Introduction

██████████ Deepwater Horizon Drilling Superintendent, requested the Rig Audit Group to perform a follow up rig and marine assurance audit on the semi-submersible Deepwater Horizon. Customer Acceptance Trials concerning the DP hardware and software mid life upgrade, a black out recovery and DP field arrival trials were also witnessed during mobilisation from the out of service period location to the field.

The follow up rig audit was undertaken whilst on location on DP at Mississippi Canyon 7-27, Kodiak prospect. Operations ongoing during the audit period were focussed on the drill floor where problems with the refurbished aft PRS and new iron roughneck were being worked. Audit focus in addition to the follow up terms of reference was on verifying that equipment which had been replaced, changed or upgraded was operating correctly and reliably.

The audit was undertaken by a four man team from 13 to 17 September 2009.

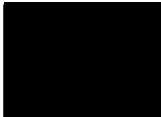

Team Leader, Drilling and Technical  
HSE  
Marine  
Technical and Marine

The wells team must review the Audit Report Action Sheet (ARAS) to accept, change or reject the recommendations. If a recommendation is not accepted the reason for the decision should also be documented and filed. Rig Audit Group consider that implementation of all recommendations will; improve safety/environmental performance, comply with industry standards and best practice, and enhance operational integrity.

The marine assurance audit was captured in the Common Marine Inspection Document (CMID) and a CMID Annex (BP requirements for MODUs). Recommendations from the marine assurance audit are included in CMID Annex (BP requirements for MODUs) report. If a recommendation is not accepted the reason for the decision should be documented, filed and the Rig Audit Group informed. All marine recommendations from this report must be tracked and satisfactorily closed out.

This report incorporates the audit findings and recommendations and will be placed on the Rig Audit Share Point site at <https://epti.bpglobal.com/sites/RigAudit/default.aspx>. The wells team is responsible for completing the audit report action sheets and placing the updated version on the share point site. Further advice on the functioning of the share point site can be obtained from the author of this report.

### Observations

The main scope of work during the out of service period (OSP) included installation of a refurbished iron roughneck, refurbishment of the forward and aft PRS and, Under Water in Lieu of Dry-dock (UWILD) class survey and update of the DP control system



(software and hardware) with associated Customer Acceptance Trials, black out recovery and field arrival trials. Whilst the DP and UWILD elements of the out of service period generally went well the drill floor work was less successful. Details of the respective work scopes are detailed within the applicable sections of this report and also the CMID and CMID Annex.

Previous Audit

Protocol for closing out the last audit recommendations needs to be improved, as it was evident that the close out process utilised was with Transocean closing out the recommendations and no apparent verification by BP. Consequently a number of the recommendations that Transocean had indicated as closed out had either deteriorated again or not been suitably addressed in the first instance. In other cases findings were simply rejected, with no formal risk mitigation demonstrated.

Overall expectations with respect to close out of class one and two recommendations were not entirely met and while it is appreciated that a good number of findings had been addressed by hard work and effort there were too many that had not.

Safety

As of 15 September 2009 the rig has gone 2390 days without a Days Away From Work Case which is an excellent achievement, however 15 serious near hits were reported over the last year and a safety stand-down was held prior to starting operations following the out of service period. The START tour process needs to be re-energised to re-enforce safety behaviours and ensure that all work areas are subjected to periodic audit by the Supervisors, who are accompanied by a junior member of the crew therefore providing some good mentoring practice. An annual structured Health and Safety Plan was not in place although a number of safety goals were listed, but these were not commonly known and not widely communicated. The BP HSE Policy posted within the accommodation was dated May 2002; this does not send the right message.

With many new personnel, continuous rigour is required to ensure that there is the expected level of consistency in the application of the risk management tools including Permit to Work and Energy Isolation. Senior personnel and supervisors should focus on continuous improvement in coaching the crews and third party personnel to ensure that the control systems in place are being effectively applied.

It is a requirement that all staff and contractors personnel be knowledgeable of the Drilling and Well Operations Practice and associated Engineering Technical Practices. The audit highlighted that this still needed to be communicated to relevant Transocean personnel on the rig.

Control of Work

Approximately 70% of work was being carried out using THINK plans and Prompt cards but no TSTP. The TSTP which provides the core risk assessment procedure is only used if one is available for the job. It was evident that the extensive TSTP library was not being fully utilised. That said the written THINK plans reviewed were generally of an

acceptable quality and personnel were seen to be actively involved during the THINK Planning process.

Time out for safety was being used and personnel were aware that they had the right and the responsibility to call a time out and stop the job if they felt that this action was required. Data arising from use of the various behavioural based risk management tools was compiled by the RSTC and statistics were reported daily with personnel briefed on results at the various rig meetings. It was noted that approximately 14% of START cards submitted were for unsafe or at risk operations while the remainder were for safe and positive observations. It was also noted that the submission of START cards by Third Party personnel was low.

The BP Golden Rules set out specific requirements for permit to work and energy isolation. This requires a permit to be issued for work on all energy systems. However the Transocean SMS can give the OIM discretion to determine if a permit to work was an additional requirement when an isolation certificate was issued for maintenance or repair of a system, or component, containing energy. It was understood that an isolation certificate was rarely issued without a permit to work but an example was sighted when only an isolation certificate had been issued for an electrical isolation prior to replacement of the iron roughneck service hose bundle. There needs to be clear alignment between the two requirements, and where there is conflict then the higher level of control should be applied.

Control of work deficiencies identified during the audit concerned the integrity and application of mechanical isolations. In the machinery spaces two permitted jobs, one to replace an air start compressor motor, the other to clean a water maker had resulted in non-isolation of the mechanical systems. An air receiver pressure gauge on the air start compressor was registering 24 bar, despite this the isolation valve although shut had not been locked or tagged. The water maker had been opened up and again although jacket water and seawater inlet and outlet valves were closed neither were locked or tagged. Of more concern, this had not been identified on the isolation certificate. On another occasion the isolation certificate issued for changing out a valve and associated pipe work in the port forward ballast pump room did not have the mechanical lock (padlock) number identified on the certificate hence all control measures had not been recorded. Details such as these should be verified before work commences during the approval stage and further checked during audit.

Other control of work deficiencies also concerned energy isolation, permit to work and improper THINK planning. During overhaul of the aft PRS it developed an incline of approximately 11 feet from the vertical plane when work between shifts was not effectively controlled or risk assessed. The brake mechanism had been removed from the PRS upper carriage and this information was not handed over between shifts. When work resumed on the aft PRS a THINK plan was not undertaken to identify and mitigate the associated hazards. Hence two control of work failings resulted in unplanned movement of the PRS.

ESD fault and inhibit alarm conditions were indicated on the bridge fire and gas panel. The vessel management system operator station was reviewed and unacknowledged communication line faults were noted. On clearing the line faults the ESD fault condition cleared. Further review indicated that active ESD inhibits were in place for the helifoam fire fighting system. These had been in place as a result of testing the helifoam system the previous day and had been in place during the morning's helicopter operations. The Task Specific Think Procedure (TSTP) for helicopter pre-arrival had not included checks to ensure all critical safety systems were operational and clearly poor control of work and management of defeats and bypasses was evident.

#### Incident Analysis and Prevention

The Incident Report Log was reviewed for the past year and of the twenty seven incidents reported, fourteen related to personal injury of which four were recordable (not DAFWC). The remaining thirteen were for serious near hits. These included two incidents where anchored man-rider winch lines had become snagged during drill-floor operations, one line parted and the other was damaged. Another incident involved the aft PRS veering 11 feet off the vertical plane. Others involved a torque valve failing under pressure and the loss of power/blackout. The remaining serious near hits related to dropped objects. The status of actions arising from these incidents should be periodically monitored by BP to ensure proper close-out; access to the Focus tracking system was not possible during the audit period.

#### Audit, Assurance and Learning

A Performance Monitoring Audit and Assessment (PMAA) was conducted between 30 June and 3 July 2009 and coincided with the ISM and ISPS audits. The PMAA audit found no areas of non-conformities although a number of improvement actions and corrective actions were recorded. One of these related to the requirement for the rig to adopt the practice of requiring a permit for all isolations that are raised. This was not yet the case.

The maintenance summary in the PMAA highlighted the fact that EMPAC was being utilised onboard. There has since been a change to the RMS II. Personnel were still becoming familiar with the new system and needed to be more knowledgeable in its use e.g. when accessing the DROPS data on the rig floor, there was an issue in locating items found in inspections that had been carried out.

Further assurance is required to demonstrate that the permit to work and energy isolation systems are working as intended and incorporate the rigour that is demanded from such a key element of the Control of Work process. This area needs to be continually monitored by both BP and Transocean.

#### Training and Competency

The turnover of personnel on the rig has been high over the last two years with personnel either being attracted to other contractors or moved to new builds within the Transocean Fleet. Personnel who have moved on include OIM, Toolpusher, Drillers, and various drilling crew personnel. Within the maintenance department, one Electrical Supervisor

and one Mechanical Supervisor have left in addition to a number of Mechanics and Electricians. The core group of experienced personnel has been shrinking to the point where some consolidation is now required. Any further dilution of experienced personnel may be detrimental to the performance of the rig.

The Transocean Training Matrix was reviewed (updated on 14 September 2009). Most of the percentages given for training required against training completed were high indicating that most personnel onboard were nearing completion of both On the Job Training (OJT) and external training requirements. Training requirements that were mostly unfulfilled related to the Safety Leadership Foundations course (41%) and the Kelvin Top Set incident investigation training (12%). During the audit numerous discussions were held with a cross-section of the crew and most indicated that they were committed to the OJT programme. Environmental and DROPS OJTs had recently been added to the requirements but had not yet been added to the ongoing programme

There was no competence assurance system in place. This was ongoing on other Transocean rigs but personnel interviewed during the audit had little or no knowledge of the competence system. Rig management need to confirm the Transocean requirement to have a competence assurance system in place. There is also a requirement under the BP Drilling and Well Operations Practice for the contractor's safety management system to incorporate systems for training and competency.

#### Derrick Inspection and Dropped Objects

The derrick was inspected to assess structural condition and effectiveness of dropped object prevention measures. DROPS inspections are carried out in accordance with RMS II maintenance routines and checklists, since our last audit the DROPS inspection process has been supplemented and improved with the addition of detailed picture book covering each derrick fixture and all derrick levels. This was produced following a comprehensive third party derrick survey. A derrick register was in use to control personnel and tool movements in the derrick, however not all information was being recorded e.g. some people were not signing the log to register that they had come down or notified that tools and equipment had been removed.

The derrick was covered in a thick film of drilling mud from the fingerboard level down; this was attributed to the previous drilling operation when setting balanced plugs. The danger being that drain holes in the girts becoming permanently plugged leading to standing water and corrosion. Despite regular derrick DROPS inspections items of trash were recovered during our inspection, clearly the required degree of rigour and vigilance are not being exercised during the rig DROPS inspections. Although secondary retention of derrick fixtures was generally satisfactory some anomalies were identified. Best practice securing methods had not been employed for the CCTV cameras while secondary retention of the flare igniter equipment was best described as suspect. The rig has been operational since 2001 but according to maintenance history files just forty three derrick bolts have been inspected. Given the rig's age all bolts should have been inspected by this time.

Many of the recommendations concerning toe boards and safety slings as per API recommended practices made during our 2008 audit remain outstanding with no action taken. It was also surprising to find the top drive guard not fitted with a safety sling, not only is this an NOV requirement but also a lesson learned from industry incidents, including one on this rig, where the guard had been knocked off due to equipment clash.

Although the third party lifting gear inspection had recently been completed, the majority of derrick fixed and loose lifting gear was incorrectly colour coded. The utility winch turndown sheave for example in the mini derrick was found in poor condition and many of the remote grease nipples for divert sheaves was dry, indicating that greasing was not being performed.

#### Drilling Equipment

On arrival on the rig work was still ongoing to complete installation of the new iron roughneck and refurbishment of the aft PRS. Problems had been encountered with both projects.

Initially some functions of the iron roughneck did not work; this was traced to a faulty service loop, thought to have been damaged during installation. The service loop was subsequently replaced with a new spare and although all iron roughneck functions were now available the machine could not be indexed and thus could not be operated from the Cyberbase chairs unless ACS release/ignore key switches were operated. Initially it was thought that the problem may be mechanical, a difference in track and encoder gear tooth pitch, but this was eliminated. Fault finding efforts using E-Hawk, NOV's remote software interrogation system, were thwarted as an undetermined issue with the remote access modem could not be resolved. Although every effort was made to achieve iron roughneck operation from Cyberbase and within the control of ACS forward progress had not been made on our departure from the rig.

NOV inspection reports dated August 2006 and May 2007 highlighted that both PRS' had worn pins and bushes, it was highlighted during our last audit in January 2008 that although this work was necessary to improve PRS reliability it had not been completed. Review of the planned PRS work scope against that completed revealed some gaps, basically the planned pin, bush and guide wheel replacements had not been performed on the forward unit, and only the forward tailing arm had been refurbished. The aft PRS had generally been refurbished according to plan with pins, bushes and guide wheels replaced as required. Justification for not completing the work scope on the forward unit was not provided.

During the last well the linear actuator was renewed on the aft PRS, a few days later problems were experienced with the lower arm retract function. The lower arm would not stay fully retracted, and on release of the joystick the arm extends out by approximately 8" putting the aft PRS into ACS initiated stop. A risk assessment was undertaken to allow continued use of the PRS, this was achieved by operators holding the joystick in the retract position when slewing and traversing the PRS. It was thought that this was due to the wear in the various pins and bushes and refurbishment would solve

the issue. However following refurbishment the problem is still prevalent; the problem appears to be attributed to mechanical interference between the primary arm and stabiliser arm. Although the arms have been dimensionally checked, a difficult task in itself with the arm in situ, Transocean had trouble interpreting the required readings as three separate detail design drawings were available each one different to the other. As a separate check the aft stabiliser arm dimensions were compared with the forward PRS stabiliser arm and differences were identified which resulted in the forward arm having greater clearance with the primary arm. Prior to departure from the rig Transocean had decided to remove the aft stabiliser arm and send it ashore for accurate dimensional analysis and possible repair.

As reported during our 2008 audit comprehensive checks to verify proper operation of the anti-collision system (ACS) were still not being periodically undertaken. Clearly lessons learned from the equipment collisions on this rig have not been fully implemented.

Top drive maintenance was reported as up to date with no outstanding issues, it was however noted that it had been omitted from the recent drilling load path inspection and condition of the mud hose was unacceptable.

The annual drawworks maintenance routine was found overdue since February 2009. When queried as to why this critical maintenance routine had not been planned or performed during the out of service period no answer could be provided. This annual maintenance routine includes integrity checks on the drawworks disc braking system including caliper disassembly, MPI of the pins and arms and adjustment checks. When challenged further the Transocean Asset Manager communicated that this maintenance routine, despite being active in RMS II and referenced on the overdue maintenance list, was no longer valid and would be changed to ten or five year frequency hence there was no need to complete it. Given the planned high casing string weights on the forthcoming well and also due to the fact that crack like indications and seized pins are not uncommon findings for this type of drawworks braking system Transocean were requested to conduct the maintenance routine or otherwise provide formal technical justification for not performing it.

According to maintenance history calibration of critical drilling instrumentation remains an area where improvement is required. Despite previous recommendations it could not be demonstrated that all critical digital and analogue drilling instrumentation is being calibrated.

Third party inspection reports of the drilling load path were generally very poor, frequently amounting to little more than a line item on a record of examination sheet. The actual components or areas inspected were seldom reported or indicated and where pictorial representation was provided it did not accurately reflect the equipment installed on the rig. In one instance MPI reports for the derrick feet were requested, these could not be located on the rig, so a call to the third party inspection company resulted in a previous inspection report being faxed to the rig with an additional line item added; "MPI 4 derrick feet – pass". This assurance approach certainly does not provide the required or

expected degree of integrity or rigour. Additionally in many cases such as top drive and PRS the inspection reports did not tally with the procedure outlined in RMS II.

#### Mud Systems

The pit room, pump room, shaker room and sack store were generally found in a clean and tidy condition with no reported defects. Mud pump crankshaft NDT inspections were in date and reported as defect free. Excessive use of silicon sealant was noted on the mud pump covers, this can result in blocked oil galleries and bearing starvation leading to pump failure. OEM gaskets should be used following future maintenance activity.

#### Well Control

Following time spent with the Subsea department it was evident that most well control related equipment maintenance is being recorded out with RMS II on separate spreadsheets and in the daily log book.

The upper middle and test ram bonnets are original and therefore out with OEM and API certification requirements. The ST-locks have however been checked. Ram cavity measurements had just been taken but results had not been recorded, it was communicated that all clearances were within recommended specification. The annual NDT inspection of the ram blocks and buttons was last performed during July 2008. All annular and ram seals were replaced during the out of service period. One annular has been in service for three years while the inner and outer piston was replaced on the other during 2008. Since our last visit, all tensioner defects have been addressed by way of new rods and modified packing, the last remaining tensioner hose was replaced during the audit period. There is no one complete spare tensioner in the yard and another currently being overhauled.

The spare POD is not 100% complete being deficient in solenoid valves and the SEM needs to be refurbished by Cameron.

The previously reported "holed" hot line has been renewed but the boost hose is original supply and dated 1999, and clearly out with Transocean's five year replacement policy. Indeed it could not be established by way of maintenance records that high pressure hoses are being maintained in accordance with RMS II requirements. According to maintenance history the choke and kill manifold has not been maintained in accordance with former Transocean maintenance requirements or indeed API recommended practices. Choke manifold valves having been replaced on the basis of failure only, periodic internal choke manifold and valve inspection having not been performed.

Recent third party inspection reports for riser bolts and inserts again were of a poor standard, serial numbers for traceability purposes had not been recorded. The rig now has an onboard riser bolt torque tool calibration unit, but calibration certification for this unit could not be produced. Based on Vetco recommendations riser bolt torque will be reduced from 25,500 ft-lb to 19,250 ft-lb during the next well, this change is based on the

introduction of new lubricant, Moly Paste TS 70 as per the technical bulletin dated June 2009.

Review of the thickness inspection reports for the high pressure piping systems once again highlighted an inferior reporting process. The reports amounted to little more than numbers as the original thickness, corrosion allowance and percentage wear were not specified. In some cases large portions of high pressure pipe work had not been inspected due to access issues and in some cases heavy corrosion was noted but no measurement recorded.

#### Maintenance Management

Maintenance management system has recently been changed from Transocean's former Empac system to the GSF legacy RMS II system. Although training has been provided for most personnel many were still coming to terms with the operation and features of RMS II. Although former maintenance history has been copied across to RMS II based on conversation and observation it is evident that Transocean has not fully set the rig up for success in terms of maintenance management. Maintenance routines now encompass the former rig specific routines, the generic Transocean Routines and the legacy GSF best practice maintenance routines; it has been left to the rig to decide which routines are required and report those that are not using the change request system. In addition maintenance scheduling has not been well thought out, in many instances and for each discipline some months has more maintenance hours scheduled than available man hours; this will clearly result in increases in overdue maintenance.

A review of the RMS II maintenance management system indicated that there were significant overdue planned maintenance routines in excess of thirty days; these totalled 390 routines which corresponded to 3545 man hours. Many of the jobs were high priority designation and it is unclear why Transocean did not plan some of these for the out of service period.

Whilst it is appreciated that attempts are being made to improve quality of maintenance reporting based on observations during the audit period further effort is still required. All too frequently maintenance history was substandard with missing information and poor quality reports that lacked sufficient detail to convince the reader that the task had actually been performed in accordance with the procedure.

Planned maintenance was inspected for the two deck cranes, knuckle boom crane and riser gantry crane. All scheduled work appeared to be up to date, with no current outstanding corrective maintenance apparent or implied. Additionally deck crane pedestal NDT inspections and boom segment bolts replacements were found in date.

With the excessive overdue maintenance and the recent introduction of more maintenance routines it would appear that the maintenance department is struggling to stay in touch with the planned maintenance schedule.

#### Software Management



A robust software management system in line with BP expectations, and Transocean Operations and Maintenance Advisory Notice, with the exception of DP software, could not be demonstrated. This was reported during the last audit. Interrogation of the system highlighted omissions from both the software register and hard copy back up files for critical software. Poor system management and audit appeared to have been exacerbated due to recent changes in Electrical Supervisor.

#### Marine Assurance

During the audit period the rig had just completed a UWILD survey and mid life upgrade for the DP system. During this period twelve skin valves were replaced as well as software and hardware for the DP system. No work was undertaken on the vessel control system (vessel management system). The Kongsberg Customer Acceptance Trial (CAT) was witnessed which covered testing of the newly installed upgrade to the DP system. A number of issues were identified but the majority of these were cleared prior to departure from the rig. The blackout recovery and DP CAT report can be found in Appendix A of this report.

A black start recovery test was witnessed and on restart, four of the thrusters were delayed in starting. One high voltage switchboard had a diesel generator connected which subsequently failed and the second diesel generator took some time to become run rated. On the basis of this result a second black recovery out was undertaken with much improved results.

Watertight integrity was reviewed and a number of tests were undertaken. There were failures observed which have raised some concerns. On testing the port aft quadrant watertight dampers a command from the vessel management system was issued but no dampers closed. Four watertight doors were found to be able to be operated locally only, evidently there were insufficient spares onboard to return the doors to remote operation. A further two watertight doors were found to have fault conditions which were identified during random testing.

There is an issue with the dead man lever associated with the watertight doors. This has manifested itself in the dead man lever when released not returning to the neutral position. On some doors it can go past the neutral position and cause the door function to be reversed, i.e. from open to close and vice versa. This is considered a safety hazard to staff. The method of operation of the door in the procedures is for the dead man lever to be maintained in the direction of travel of the door throughout the operation. The culture onboard is to start the open/close cycle then release the handle until the operation is completed. The design premise of allowing a door to continue in operation even though the dead man lever is released is considered poor, is different to the norm including the sister rig, the deepwater Nautilus, and should be addressed. This difference in operating philosophy also presents a risk to personnel and watertight door operation familiarisation should be undertaken on an urgent basis.

The weatheright door limit switches indicating door status to the bridge were found in some cases to be non-functional. In the worst case approximately four of these doors had

the limit switch frozen in the closed position. This then means the bridge would be unaware of the status of the door as the limit switch always reports closed status. Additionally when reviewing alarm status conditions on the vessel management system a number of doors had had the 100 second alarm timer disabled. This means that if the doors are left open for more than 100 seconds then the audible alarm will not be generated in line with the original requirements.

During the audit period process station PCU18 serving the starboard aft quadrant failed. The PLC card failure meant that it was not possible to operate the starboard aft bilge and ballast valves, ballast pump remotely and the tank sounding system was also rendered inoperable. The defect could not be immediately rectified due to insufficient onboard spares.

During testing of the bilge system three of the four electric bilge pumps failed to take suction, the priming devices being defective. Two emergency bilge suction check valves also failed integrity checks when subject to flow back tests.

Of the eight seawater cooling pumps just one was totally defect free, while four pumps were deemed non-operational others could be operated despite the defects such as severely leaking upper and lower shaft seals. In two cases pump defects had been reported during our previous audit over eighteen months ago.

#### Power Plant

Engine #1 was overdue, since May 2009, a planned 24,000 hour overhaul. While engine #4 was overdue, since June 2009, a planned 24,000 hour overhaul and 12,000 hour turbo charger replacement. The Maintenance Supervisor cited a lack of manpower as the reason for no progress.

Thruster #2 was non operational during the audit period, problems had been encountered with current imbalance on the variable frequency drive inverter; due to manpower focus on the rig floor issues it had not been investigated. According to the daily maintenance report the rig has requested an extension, to 4Q2010, for the eight year thruster drive maintenance routine; this basically involves systematic disassembly and inspection of each drive with specific part replacement in accordance with OEM recommendations. The request for this extension is currently pending.

Thermographic survey and current injection testing remain outstanding, although the rig now has the thermographic inspection equipment onboard the windows to facilitate inspection have not been made on the various switchboards, drive cubicles and MCC's.

Control of alarms and defeats and bypasses was not well managed, in fact no single person could account for which alarms etc. were overridden or indeed for what reason.

#### Mechanical Handling

Certification for most of the lifting equipment was sighted with the exception of the proof load test certification for the man riding winches, utility winches, trolley beams and pad

eyes, which could not be produced. Webbing slings were all changed out during February 2009 and all had current certification. The last ABS load tests on the two deck cranes, knuckle boom crane and the riser gantry crane were performed between January 2006 to December 2007 and the last class annual thorough examination was completed in December 2008; with the Cargo Gear Register being endorsed as required.

The last third party lifting equipment annual survey was completed in August 2009, although the final report had not been received it was communicated that defects were limited to a few wire slings. The present lifting gear colour code is yellow, despite this several pad eyes in the mud pit room and most lifting gear in the derrick were still painted green. The loose and fixed lifting gear was spot checked, and all sighted slings, pad eyes and overhead trolley beams were either tagged or marked with their SWL and ID. There is no dedicated store or rigging loft and subsequently the lifting equipment is mainly stowed in the two aft leg columns with no formal control over use.

The port and starboard deck cranes were function tested and limits successfully tested. The safe load indicators were operational on both deck cranes but the LCD screen on the starboard crane was no longer backlit. The port deck crane lower boom segment lattice, right hand brace to chord intersection has an indentation that is presently being monitored. The daily and weekly crane operator's inspection reports were sighted together with lift plans for special lifts undertaken.

The riser gantry crane and knuckle boom crane were both functioned and limits tested satisfactorily. Due to ongoing operations in the moon pool and on the BOP stack, the BOP crane was not tested during the audit period.

All cranes wire rope certification was in order with specified change out dates honoured. The BOP crane main and wires were last changed in October/November 2007 and are shortly due for renewal under Transocean's two year change out policy.

The drill floor and moon pool man riding and utility winches were inspected and function tested. Anomalies noted, which in one instance included failure of the E stop, have been recorded in the ARAS.

#### Obsolescence Issues

Although obsolescence issues primarily concerning the PRS and iron roughneck control systems were reported during our 2008 audit. No action has been taken to either resolve these issues or otherwise undertake a rig wide study to identify other areas that may be becoming obsolete with potential to have a detrimental effect on equipment availability.

#### Warehouse

The legacy Transocean warehouse management system had just recently, July 2009, been replaced by the GSF legacy Inventory Control System (ICS) with material requests and purchase orders being placed via the intranet to the server onshore. It was communicated that current stock inventory resides at 3,913,687 USD with a further 1,786,198 USD of

material on order covering 448 purchase orders. Of these purchase orders fifty are for critical spares.

Warehouse personnel were still becoming familiar with ICS and consequently were not fully conversant with all functions. For example, they were unable to produce a full list of critical spare parts on the rig. The store rooms were tidy and parts were binned and tagged. Spot checks of the OEM rubber goods indicated that all rubber goods were correctly sealed and in date.

During the audit period several spares shortages came to light, these included critical systems such as watertight doors, vessel control system (PCU 18), fire and gas detectors and main engine turbo chargers.

**Audit Report Action Sheet (ARAS)**

The observations and recommendations are laid out in tabular format that allows tracking of audit recommendations. The first digit in the numbering system indicates the criticality and by reflection of the criticality, timing for reaction to the findings.

Class 1	These items that do not comply with BP policies or Standards
Class 2	These items are outside API, legislation, Rig Owner policies, have high safety or environmental impact potential.
Class 3	These are items that one would expect to find in place from a combination of competent drilling contractor and competent operator.
Class 4	These are items that can be used by the drilling contractor and/or BP to build on the project, though they are not considered as essential.

The second digit in the numbering system indicates the functional area the issue is based within.

1. Health, Safety and Safety Management<sup>1</sup>
2. Drilling and Well Control
3. Technical Services
4. Marine<sup>2</sup>
5. Environmental
6. Mechanical Handling

The final digit is the recognition number for that particular section bearing in mind the items are not set out by priority.

Audit Team Advised Completion is based on what was understood as the criticality of the issue in relation to project timing.

The wells team must review the Audit Report Action Sheet (ARAS) to accept, change or reject the recommendations. If a non-marine recommendation is not accepted the reason for the decision should also be documented and filed. Rig Audit Group consider that implementation of all recommendations will; improve safety/environmental performance, comply with industry standards and best practice, and enhance operational integrity.

---

<sup>1</sup> There is no 3.1 Classification

<sup>2</sup> Recommendations are included in the CMID Annex (BP requirements for MODUs) report

**Appendix N | BP DEEPWATER HORIZON FOLLOW UP RIG AUDIT, MARINE ASSURANCE  
AUDIT AND OUT OF SERVICE PERIOD SEPTEMBER 2009**

Confidential

AUDIT REPORT ACTION SHEET

RIG TYPE: Semi-Submersible

RIG NAME: Deepwater Horizon

DATES OF AUDIT: 13 to 17 September 2009

RIG STATUS: Out of Service Period

REF	OBSERVATION	RECOMMENDATION	AUDIT TEAM ADVISED COMPLETION	ASSET ACCEPTANCE OR CHANGE	ACTUAL COMPLETION DATE	SIGNED OFF BY
<b>1.1</b>	<b><i>Health, Safety and Safety Management</i></b>	<b><i>These items do not comply with BP Policies or Standards</i></b>				
1.1.1	A conflict was noted between the BP Golden Rules on permit to work and Transocean SMS Policy (Section 4.2.2 Sub-section 5.6) OIM's duty to determine if a permit is required in addition to an Isolation Certificate.  An example of an isolation certificate with no associated permit to work was posted in the auxiliary Driller's cabin for work to replace a service hose bundle on the iron roughneck.	A permit to work must be required for work on energy systems. Transocean to abide by the higher level of control and ensure all energy isolations are under control of the permit to work process.  Golden Rules of Safety	Immediately			
1.1.2	The isolation certificate issued for changing out a valve and pipe work in the port forward ballast pump room did not include details of the mechanical isolation, e.g. the padlock number.	When completing isolation certificates, checks should be made to ensure that all information is entered. Lock-out/tag-out details should be checked and recorded. Permit to work audits should include the requirement to check both mechanical and electrical isolations and ensure that the details recorded are complete.  Golden Rules of Safety	Immediately			
1.1.3	There is a requirement for all contract and staff personnel involved in the management and supervision of drilling and well operations for BP to be knowledgeable of the Drilling and Well Operations Practice and associated Engineering Technical Practices. Relevant Transocean personnel were not aware of this requirement.	The Drilling and Well Operations Practice and associated Engineering Technical Practices to be rolled out to relevant Transocean personnel to the point where they are knowledgeable of the contents.  BP Drilling and Well Operations Practice	Within six months			

BP-HZN-MB100136228

**Appendix N | BP DEEPWATER HORIZON FOLLOW UP RIG AUDIT, MARINE ASSURANCE  
AUDIT AND OUT OF SERVICE PERIOD SEPTEMBER 2009**

Confidential

AUDIT REPORT ACTION SHEET

RIG TYPE: Semi-Submersible

RIG NAME: Deepwater Horizon

DATES OF AUDIT: 13 to 17 September 2009

RIG STATUS: Out of Service Period

REF	OBSERVATION	RECOMMENDATION	AUDIT TEAM ADVISED COMPLETION	ASSET ACCEPTANCE OR CHANGE	ACTUAL COMPLETION DATE	SIGNED OFF BY
1.1.4	No Competence Assurance system was in place. This differs from other Transocean rigs (e.g. DDIII) where a competency programme is maintained and competency records held.	Transocean should ensure that the competency system used on other rigs is applied to the Deepwater Horizon.  Drilling and Well Operations Practice	Within four months			
1.1.5	Several instances where mechanical isolations had not been identified or suitable locked and tagged out. Examples include discharge valve on air start compressor #4 during motor replacement and failure to lock out / tag out the jacket water and seawater inlet and outlet valves during disassembly of water maker #5.	Mechanical isolations to be considered for each job involving energy isolation. An effective system of tag and locks to be employed and details included on the Isolation Certificate.  Golden Rules of Safety	Immediately			
1.1.6	The rigour concerning close out of the previous audit findings has generally been unsatisfactory. There has been little sign of BP involvement evident and consequently many of the recommendations reported as closed out could not be adequately demonstrated to the audit team during this visit.	BP involvement required in closing out of audit recommendations. If a recommendation is rejected then formal risk mitigation to be documented.  Six Point Plan	Immediately			

BP-HZN-MBI00136229

**Appendix N | BP DEEPWATER HORIZON FOLLOW UP RIG AUDIT, MARINE ASSURANCE  
AUDIT AND OUT OF SERVICE PERIOD SEPTEMBER 2009**

Confidential

AUDIT REPORT ACTION SHEET

RIG TYPE: Semi-Submersible

RIG NAME: Deepwater Horizon

DATES OF AUDIT: 13 to 17 September 2009

RIG STATUS: Out of Service Period

REF	OBSERVATION	RECOMMENDATION	AUDIT TEAM ADVISED COMPLETION	ASSET ACCEPTANCE OR CHANGE	ACTUAL COMPLETION DATE	SIGNED OFF BY
<i>1.2</i>	<i>Drilling and Well Control</i>	<i>These items do not comply with BP Policies or Standards</i>				
1.2.1	The test, middle and upper pipe ram BOP bonnets are original. They have not been subject to OEM inspection and recertification in accordance with API and OEM requirements. Transocean propose a change out plan commencing in 2010 for completion in 2011.	Expedite overhaul of the test, middle and upper pipe ram bonnets which are original and have significantly surpassed the recommended recertification period. Otherwise expedite replacements.  Drilling and Well Operations Practice	By end of 2009			

BP-HZN-MB100136230



**Appendix N | BP DEEPWATER HORIZON FOLLOW UP RIG AUDIT, MARINE ASSURANCE  
AUDIT AND OUT OF SERVICE PERIOD SEPTEMBER 2009**

Confidential

AUDIT REPORT ACTION SHEET

RIG TYPE: Semi-Submersible

RIG NAME: Deepwater Horizon

DATES OF AUDIT: 13 to 17 September 2009

RIG STATUS: Out of Service Period

REF	OBSERVATION	RECOMMENDATION	AUDIT TEAM ADVISED COMPLETION	ASSET ACCEPTANCE OR CHANGE	ACTUAL COMPLETION DATE	SIGNED OFF BY
<b>1.3</b>	<b>Technical Services</b>	<b>These items do not comply with BP Policies or Standards</b>				
1.3.1	With the exception of the DP control system a comprehensive software management system for critical software such as the BOP control system, ballast control system and vessel management system could not be demonstrated.	Target to be set for completion of auditable software management system. Software verification schedule to be risk based i.e. most critical software to be checked/backed up first. System to be subject to periodic audit in line with Transocean Advisory Notice.  Drilling and Well Operations Practice	Within three months			
1.3.2	No formal means in place to communicate overdue critical maintenance or defective equipment to the BP Well Site Leaders.	Weekly maintenance report to be updated / modified to include all equipment defects and all overdue planned and corrective maintenance. Report to be submitted to the BP Well Site Leader on a weekly basis.  Drilling and Well Operations Practice	Within one week			

BP-HZN-MB100136231

**Appendix N | BP DEEPWATER HORIZON FOLLOW UP RIG AUDIT, MARINE ASSURANCE  
AUDIT AND OUT OF SERVICE PERIOD SEPTEMBER 2009**

Confidential

AUDIT REPORT ACTION SHEET

RIG TYPE: Semi-Submersible

RIG NAME: Deepwater Horizon

DATES OF AUDIT: 13 to 17 September 2009

RIG STATUS: Out of Service Period

REF	OBSERVATION	RECOMMENDATION	AUDIT TEAM ADVISED COMPLETION	ASSET ACCEPTANCE OR CHANGE	ACTUAL COMPLETION DATE	SIGNED OFF BY
<b>1.6</b>	<b><i>Mechanical Handling</i></b>	<b><i>These items do not comply with BP Policies or Standards</i></b>				
1.6.1	The E Stop on the forward moon pool man ridding winch is non operational.	E Stop on the forward moon pool man ridding winch to be made operational.  Golden Rules of Safety	Prior to next use			
1.6.2	The proof load test certification for the man riding winches, utility winches, trolley beams and pad eyes were not available for inspection during the rig audit period.	Ensure that the current proof load test certification for the man riding winches, utility winches, trolley beams and pad eyes are available on the rig for inspection. Should these be unavailable proof load testing to be carried out by competent person.  Golden Rules of Safety	Within one month			

BP-HZN-MBI00136232

**Appendix N | BP DEEPWATER HORIZON FOLLOW UP RIG AUDIT, MARINE ASSURANCE  
AUDIT AND OUT OF SERVICE PERIOD SEPTEMBER 2009**

Confidential

AUDIT REPORT ACTION SHEET

RIG TYPE: Semi-Submersible

RIG NAME: Deepwater Horizon

DATES OF AUDIT: 13 to 17 September 2009

RIG STATUS: Out of Service Period

REF	OBSERVATION	RECOMMENDATION	AUDIT TEAM ADVISED COMPLETION	ASSET ACCEPTANCE OR CHANGE	ACTUAL COMPLETION DATE	SIGNED OFF BY
<b>2.1</b>	<b><i>Health, Safety and Safety Management</i></b>	<b><i>These items are outside API, legislation, Rig Owner policies, have high safety or environmental impact potential.</i></b>				
2.1.1	The coupling guard on the Mathey wire line unit is inadequate and the coupling guard on main engine #2 pre-lube oil pump was missing. Both couplings are exposed.	Modify coupling guard on Mathey wire line unit such that rotating equipment is enclosed.  Coupling guard on main engine #2 pre-lube oil pump to be installed.	Prior to use  Immediately			
2.1.2	Potential fall through hazard identified at the crown access platform of the mini derrick in way of the fast line.	Extend handrails at the crown access platform of the mini derrick in way of the fast line to remove potential fall through hazard.	Within two months			
2.1.3	BP HSE Policy posted in the accommodation is dated May 2002.	Most recent version of BP HSE Policy to be made available and posted on the relevant HSE notice boards.	Within one month			
2.1.4	Although some general safety goals were in place, no structured annual Health and Safety Plan with measureable actions, completion dates and accountable persons was sighted.	An annual Health and Safety Plan should be put in place to formally manage ongoing HSE initiatives. The plan should have clear measureable targets with defined accountabilities.	Within three months			
2.1.5	Only two of the twenty-eight people requiring the Kelvin Top Set one day training course have been trained.	Outstanding one day Kelvin Top Set training to be completed in accordance with the training matrix requirements.	Within three months			

BP-HZN-MBI00136233

**Appendix N | BP DEEPWATER HORIZON FOLLOW UP RIG AUDIT, MARINE ASSURANCE  
AUDIT AND OUT OF SERVICE PERIOD SEPTEMBER 2009**

Confidential

AUDIT REPORT ACTION SHEET

RIG TYPE: Semi-Submersible

RIG NAME: Deepwater Horizon

DATES OF AUDIT: 13 to 17 September 2009

RIG STATUS: Out of Service Period

REF	OBSERVATION	RECOMMENDATION	AUDIT TEAM ADVISED COMPLETION	ASSET ACCEPTANCE OR CHANGE	ACTUAL COMPLETION DATE	SIGNED OFF BY
2.1.6	The FOCUS improvement system was being used to track the status of actions arising from incidents. It was not possible during the audit, to ascertain the actual status of the actions arising from each report.	In conjunction with those actions recorded within the BP Traction system, BP should monitor the status of actions held on the Transocean Focus system which relate to incidents that have occurred on the Deepwater Horizon.	Within one month			
2.1.7	On completion of a job that requires a TSTP, an after action review should be completed. This was not always being done.	Ensure that on completion of all jobs that require a TSTP, an after action review is completed in accordance with the procedure.	Immediately			
2.1.8	Condition of some chemical pallets in the sack store was suspect. Some had sustained mechanical damage due to forklift truck damage. Consequently a number of pallets were splintered while others were tilting.	To avoid injury to personnel forklift drivers should ensure that they take care when handling wooden chemical pallets. This should be discussed and recorded during Think Plans.	Immediately			
2.1.9	The lighting inside the starboard-aft stairwell from the main deck to the lower deck was insufficient.	Improve the lighting inside the starboard-aft stairwell from the main deck to the lower deck	Within two months			
2.1.10	The safety notice board did not contain up to date minutes of safety meetings. There was some information available from the DROPS Steering Committee Meetings but no recent safety meeting minutes were posted.	Ensure that relevant up to date information is posted on the safety notice board which covers all ongoing safety issues on the rig.	Within one week			

BP-HZN-MB100136234

**Appendix N | BP DEEPWATER HORIZON FOLLOW UP RIG AUDIT, MARINE ASSURANCE  
AUDIT AND OUT OF SERVICE PERIOD SEPTEMBER 2009**

Confidential

AUDIT REPORT ACTION SHEET

RIG TYPE: Semi-Submersible

RIG NAME: Deepwater Horizon

DATES OF AUDIT: 13 to 17 September 2009

RIG STATUS: Out of Service Period

REF	OBSERVATION	RECOMMENDATION	AUDIT TEAM ADVISED COMPLETION	ASSET ACCEPTANCE OR CHANGE	ACTUAL COMPLETION DATE	SIGNED OFF BY
2.1.11	An ESD fault was registered on the fire and gas panel located on the bridge, further investigation revealed that the helifoam system had been inhibited thereby preventing operation during a helicopter operations. This inhibit had been missed from system tests the previous day.	The TSTP for conducting helicopter pre-arrival checks to be reviewed to ensure that all critical systems are fully functional. The written THINK Plan should include these checks.	Immediately			
2.1.12	In the shale shaker area, some items of PPE and hand tools had been left lying around e.g. face visor left next to shaker #8 and stilson wrench lying on the walkway.	All PPE to be stored in the PPE locker when not in use and personnel to be reminded that on completion of work, all hand-tools should be properly stored.	Immediately			
2.1.13	The TSTP for working on mud pumps did not adequately address the manual handling aspects involved in moving heavy equipment e.g. mud pump fluid end modules and piston liners.	Review TSTP to ensure that manual handling aspects are included and that personnel consider manual handling hazards in the THINK planning process.	Within one month			
2.1.14	MSDS information was not available in the mud mixing area. Some information was posted on the notice board in this area but this was not considered adequate.	Provide MSDS information at worksites where potentially hazardous materials may be stored and/or used.	Within one month			
2.1.15	The number of START cards submitted by third party and BP personnel was low. None had been submitted for the previous week.	Remind all personnel, including third party and BP personnel, on the rig to be fully engaged in the START card system and people reminded of their duty to use the behavioural tools available.	Immediately			

BP-HZN-MBI00136235

**Appendix N | BP DEEPWATER HORIZON FOLLOW UP RIG AUDIT, MARINE ASSURANCE  
AUDIT AND OUT OF SERVICE PERIOD SEPTEMBER 2009**

Confidential

AUDIT REPORT ACTION SHEET

RIG TYPE: Semi-Submersible

RIG NAME: Deepwater Horizon

DATES OF AUDIT: 13 to 17 September 2009

RIG STATUS: Out of Service Period

REF	OBSERVATION	RECOMMENDATION	AUDIT TEAM ADVISED COMPLETION	ASSET ACCEPTANCE OR CHANGE	ACTUAL COMPLETION DATE	SIGNED OFF BY
2.1.16	Fail hazards were noted in the port forward and starboard forward ballast pump rooms, where valve change out had resulted in gaps with no handrail protection.	Fail hazards presented by the gaps in the port forward and starboard forward ballast pump rooms to be addressed.	Within one week.			
2.1.17	Additional OJT (DROPS and Environmental) had recently been added to the list that had to be completed by onboard personnel. These had not yet been implemented.	A timescale to be established for implementing the DROPS and Environmental OJT.	Within two months			
2.1.18	One of the hospital alarms was tested. Although a signal was activated on the bridge, there was no acknowledgement to the Medic that it had been received.	All four alarms in the hospital to be checked and personnel responsible for acknowledging the alarms made clear on their duty to respond immediately.	Within one week.			

BP-HZN-MB100136236

**Appendix N | BP DEEPWATER HORIZON FOLLOW UP RIG AUDIT, MARINE ASSURANCE  
AUDIT AND OUT OF SERVICE PERIOD SEPTEMBER 2009**

Confidential

AUDIT REPORT ACTION SHEET

RIG TYPE: Semi-Submersible

RIG NAME: Deepwater Horizon

DATES OF AUDIT: 13 to 17 September 2009

RIG STATUS: Out of Service Period

REF	OBSERVATION	RECOMMENDATION	AUDIT TEAM ADVISED COMPLETION	ASSET ACCEPTANCE OR CHANGE	ACTUAL COMPLETION DATE	SIGNED OFF BY
<b>2.2</b>	<b><i>Drilling and Well Control</i></b>	<b><i>These items are outside API, legislation, Rig Owner policies, have high safety or environmental impact potential.</i></b>				
2.2.1	The BOP control unit triplex pump pressure relief valve was last recalibrated during August 2007. It is subsequently now overdue the 2 year recertification period as per API recommended practice.	BOP control unit triplex pump pressure relief valve to be recalibrated.	Within two months			
2.2.2	Derrick gates/hatches were not fitted with safety lanyards.	Derrick gates/hatches to be provided with adequate means of secondary retention.	Within monthly derrick inspection cycle.			
2.2.3	Toe boards are not installed at the edges of a number of derrick walkways. Areas include at the crown in way of the block and fast line, at the fingerboard level at the dead line grating penetration, in way of the aft PRS control cabinets and at the access walkway in way of the forward PRS bridge.	Toe boards to be provided on open sided floors, platforms, walkways in accordance with API RP 54	At next between wells period			
2.2.4	The crown bumper timbers are not equipped with safety slings in accordance with API recommended practice.	Safety slings to be installed on the crown bumper timbers in accordance with API RP 54	Within two months			
2.2.5	Items of trash were recovered/identified during the derrick inspection. These included fixings, split pins, loose cable band, plastic from drill line, grating clamps and wire.	Full sweep of derrick to be conducted, all trash and loose items to be removed. Extra vigilance required by rig crews during derrick inspections.	Within one week			

BP-HZN-MBI00136237

**Appendix N | BP DEEPWATER HORIZON FOLLOW UP RIG AUDIT, MARINE ASSURANCE  
AUDIT AND OUT OF SERVICE PERIOD SEPTEMBER 2009**

Confidential

AUDIT REPORT ACTION SHEET

RIG TYPE: Semi-Submersible

RIG NAME: Deepwater Horizon

DATES OF AUDIT: 13 to 17 September 2009

RIG STATUS: Out of Service Period

REF	OBSERVATION	RECOMMENDATION	AUDIT TEAM ADVISED COMPLETION	ASSET ACCEPTANCE OR CHANGE	ACTUAL COMPLETION DATE	SIGNED OFF BY
2.2.6	Numerous loose and detached grating clamps were identified and retrieved during the derrick inspection. Loose grating clamps prevailed on the derrick hatches while the detached clamps were found mainly at the crown platform.	Survey all derrick grating clamps. Loose items to be secured and missing/detached items to be replaced.	Within monthly derrick inspection cycle.			
2.2.7	Secondary retention arrangements for the crown mounted flare igniter were suspect, not all equipment was adequately secured.	Review and address as required secondary retention arrangements fro the crown mounted flare igniter.	Within monthly derrick inspection cycle.			
2.2.8	The high pressure mud hose was found in unacceptable condition. The outer casing was damaged, due to abrasion with the top drive service loop, and several layers including the steel belt construction were worn through.	High pressure mud hose to be replaced.	Before start of drilling operations			
2.2.9	According to maintenance history choke manifold valves have not been opened up for periodic inspection and overhaul in line with API recommended practice. Consequently only valves failing to meet pressure test requirements have been inspected.	In accordance with API recommended practice choke manifold to be opened up and fully inspected over a four year cycle. All valves to be removed for inspection and repairs to be documented.	At next between wells period			
2.2.10	One of the BOP high pressure boost hoses has been in service since December 1999. The hose is in poor fabric condition and has not been maintained in accordance with Transocean yearly or 5 – yearly maintenance requirements. It was communicated that delivery date for a replacement hose was March 2010.	Replace out of certification BOP high pressure boost hose. Transocean maintain a 5 – year thorough hose inspection / replacement philosophy.	Before start of drilling operations			

BP-HZN-MB100136238



**Appendix N | BP DEEPWATER HORIZON FOLLOW UP RIG AUDIT, MARINE ASSURANCE  
AUDIT AND OUT OF SERVICE PERIOD SEPTEMBER 2009**

Confidential

AUDIT REPORT ACTION SHEET

RIG TYPE: Semi-Submersible

RIG NAME: Deepwater Horizon

DATES OF AUDIT: 13 to 17 September 2009

RIG STATUS: Out of Service Period

REF	OBSERVATION	RECOMMENDATION	AUDIT TEAM ADVISED COMPLETION	ASSET ACCEPTANCE OR CHANGE	ACTUAL COMPLETION DATE	SIGNED OFF BY
2.2.11	The annual maintenance routine for the drawworks was overdue since February 2009. This routine includes disassembly and MPI of the drawworks caliper pins and arms.	Annual maintenance routine for the drawworks to be undertaken. Maintenance routine to be performed in full including disassembly and MPI of the brake caliper, pins and arms. Any deviation from the maintenance system requirements to be subject to formal written technical justification.	Before start of drilling operations			
2.2.12	Annual maintenance routine requires pressure testing of each high pressure hose, choke and kill, and mud hoses for example. Review of the associated history files indicated that visual inspection only had been performed.	Annual maintenance requirements for high pressure hoses to be fulfilled. Pressure testing in accordance with table attached to the maintenance procedure to be undertaken.	Within four months			
2.2.13	The standard of third party NDT inspection reports was woefully inadequate and at best poor. The reports presented for inspection contained insufficient detail of the actual components or areas inspected.	Transocean to communicate clear terms of reference to third party NDT inspection company. Quality of NDT inspection reports to be significantly improved to reflect the actual components and areas inspected.	Prior to further NDT inspection work			
2.2.14	Calibration certificate for the riser bolt torque wrench calibration equipment could not be provided.	Valid calibration certificate to be available onboard for the riser bolt torque wrench calibration equipment.	Within one month			
2.2.15	Review of the most recent (September 2009) drilling load path NDT inspection reports indicated that the following items were not inspected, travelling block, top drive, crown block and the master bushing and insert.	Missed items from drilling load path inspection to be subject to MPI.	Within two months			

BP-HZN-MB100136239

**Appendix N | BP DEEPWATER HORIZON FOLLOW UP RIG AUDIT, MARINE ASSURANCE  
AUDIT AND OUT OF SERVICE PERIOD SEPTEMBER 2009**

Confidential

AUDIT REPORT ACTION SHEET

RIG TYPE: Semi-Submersible

RIG NAME: Deepwater Horizon

DATES OF AUDIT: 13 to 17 September 2009

RIG STATUS: Out of Service Period

REF	OBSERVATION	RECOMMENDATION	AUDIT TEAM ADVISED COMPLETION	ASSET ACCEPTANCE OR CHANGE	ACTUAL COMPLETION DATE	SIGNED OFF BY
2.2.16	The five year derrick inspection maintenance routine requires MPI of the derrick feet. This could not be demonstrated by way of onboard MPI reports. The third party inspection company were contacted and faxed through a revised MPI report. Review of the report submitted indicated that an existing report, one that was available onboard the rig, had simply been modified with the addition derrick feet. This approach to reporting key structural inspections lacks necessary integrity and level of assurance required.	Transocean to communicate clear terms of reference to third party NDT inspection company. Quality of NDT inspection reports to be significantly improved to reflect the actual components and areas inspected. Modifying existing MPI reports with additional line items to suit customer requests is unacceptable.	Immediately			
2.2.17	The recently installed iron roughneck cannot be operated from Cyberbase unless ACS ignore/release override key switches are activated.	Iron roughneck to be made operational from Cyberbase with ACS active.	Before start of drilling operations			
2.2.18	The aft PRS has been operated under a permanent risk assessment as the lower arm will not stay retracted. Although just refurbished the problem has not been eradicated.	Investigate and rectify the retract problem concerning the lower arm of the aft PRS.	Before start of drilling operations			
2.2.19	Calibration of critical analogue and digital drilling instrumentation such as the dead weight indicator, well control related pressure gauges, top drive, and iron roughneck torque could not be demonstrated.	Calibration of critical analogue and digital drilling instrumentation to be undertaken and inspection reports maintained onboard.	Within six months			

BP-HZN-MB100136240

**Appendix N | BP DEEPWATER HORIZON FOLLOW UP RIG AUDIT, MARINE ASSURANCE  
AUDIT AND OUT OF SERVICE PERIOD SEPTEMBER 2009**

Confidential

AUDIT REPORT ACTION SHEET

RIG TYPE: Semi-Submersible

RIG NAME: Deepwater Horizon

DATES OF AUDIT: 13 to 17 September 2009

RIG STATUS: Out of Service Period

REF	OBSERVATION	RECOMMENDATION	AUDIT TEAM ADVISED COMPLETION	ASSET ACCEPTANCE OR CHANGE	ACTUAL COMPLETION DATE	SIGNED OFF BY
2.2.20	Although previously requested comprehensive derrick bolt inspection reports could not be provided. A third party MPI report was produced with a line item stating UT inspection of 43 derrick bolts.	Given the age of the derrick comprehensive (100%) derrick bolt inspection to be undertaken. Derrick bolts to be inspected for security, corrosion and elongation.	Within six months			
2.2.21	The top drive guard although previously ripped off during a collision with the PRS and also recommended by NOV is not fitted with a safety sling.	Top drive guard to be fitted with a suitable safety sling.	Before start of drilling operations			
2.2.22	A derrick register was in use however not all information was being recorded e.g. some people were not signing the log to register that they had come down from the derrick and notified that tools and equipment had been taken down.	Drilling Supervisors to ensure strict enforcement of the derrick register, i.e. all personnel accessing the derrick sign out once they have completed the work and register that all tools and equipment taken up have been brought down.	Immediately			

BP-HZN-MBI00136241

**Appendix N | BP DEEPWATER HORIZON FOLLOW UP RIG AUDIT, MARINE ASSURANCE  
AUDIT AND OUT OF SERVICE PERIOD SEPTEMBER 2009**

Confidential

AUDIT REPORT ACTION SHEET

RIG TYPE: Semi-Submersible

RIG NAME: Deepwater Horizon

DATES OF AUDIT: 13 to 17 September 2009

RIG STATUS: Out of Service Period

REF	OBSERVATION	RECOMMENDATION	AUDIT TEAM ADVISED COMPLETION	ASSET ACCEPTANCE OR CHANGE	ACTUAL COMPLETION DATE	SIGNED OFF BY
<b>2.3</b>	<b>Technical Services</b>	<b><i>These items are outside APT, legislation, Rig Owner policies, have high safety or environmental impact potential.</i></b>				
2.3.1	A formal system to manage alarm inhibits and control of defeats and bypasses was not in place for vessel management system, drilling control system and related PLC's etc.	Formal management system to be implemented for alarm inhibits and control of defeats and bypasses.	Within one month			
2.3.2	Although not widespread it was evident that maintenance routines were still being closed out although the maintenance tasks were not being performed. E.g. 30 day top drive dolly.	The practice of closing incomplete maintenance work orders must cease. Maintenance Supervisor to produce standing instructions to communicate expectations.	Immediately			
2.3.3	Although previously reported quality of maintenance history reporting remains below par across all disciplines. In many cases history was deficient in content describing the work carried out and it was frequently not possible to determine if the required maintenance tasks had been performed.	Maintenance Supervisor to produce standing instructions to effectively communicate expectation for improved maintenance history reporting	Immediately			
2.3.4	The vast majority of mud pump covers had been installed using silicon sealant. This can plug internal oil ways and galleries leading to bearing oil starvation and failure.	Practice of sealing mud pump covers with silicon sealant to cease. OEM gaskets to be used only.	During future inspections			
2.3.5	Overdue maintenance in excess of 30 days was considered excessive totalling 390 jobs and 3545 man hours. Many of the overdue maintenance routines were high priority.	Communicate forward plan for reducing current high levels of overdue critical maintenance.	Within one week			

BP-HZN-MB100136242

BP-HZN-IIT-0008902

**Appendix N | BP DEEPWATER HORIZON FOLLOW UP RIG AUDIT, MARINE ASSURANCE  
AUDIT AND OUT OF SERVICE PERIOD SEPTEMBER 2009**

Confidential

AUDIT REPORT ACTION SHEET

RIG TYPE: Semi-Submersible

RIG NAME: Deepwater Horizon

DATES OF AUDIT: 13 to 17 September 2009

RIG STATUS: Out of Service Period

REF	OBSERVATION	RECOMMENDATION	AUDIT TEAM ADVISED COMPLETION	ASSET ACCEPTANCE OR CHANGE	ACTUAL COMPLETION DATE	SIGNED OFF BY
2.3.6	Thruster T2 motor has low insulation resistance reading, circa 1M $\Omega$ m.	Investigate and rectify low insulation resistance of thruster T2 motor.	Within one month			

BP-HZN-MB100136243

**Appendix N | BP DEEPWATER HORIZON FOLLOW UP RIG AUDIT, MARINE ASSURANCE  
AUDIT AND OUT OF SERVICE PERIOD SEPTEMBER 2009**

Confidential

AUDIT REPORT ACTION SHEET

RIG TYPE: Semi-Submersible

RIG NAME: Deepwater Horizon

DATES OF AUDIT: 13 to 17 September 2009

RIG STATUS: Out of Service Period

REF	OBSERVATION	RECOMMENDATION	AUDIT TEAM ADVISED COMPLETION	ASSET ACCEPTANCE OR CHANGE	ACTUAL COMPLETION DATE	SIGNED OFF BY
<b>2.6</b>	<b><i>Mechanical Handling</i></b>	<b><i>These items are outside API, legislation, Rig Owner policies, have high safety or environmental impact potential.</i></b>				
2.6.1	The two year maintenance requirement to remove the derrick sheaves and snatch blocks for thorough inspection is not being rigorously applied. It could not be demonstrated when all sheaves were last removed from the derrick. For example the utility winch turn down sheave mounted under the crown of the mini derrick was heavily corroded	Derrick sheaves and snatch blocks to be removed from the derrick for disassembly and thorough inspection. Maintenance history to be updated with details of inspections	Within two months			
2.6.2	None of the pad eyes, safety slings and sheaves within the derrick was colour coded in accordance with the current lifting gear colour code. This is out with Transocean policy.	Ensure loose lifting equipment installed in the derrick is subject to third party inspection and colour coded in accordance with the current lifting gear colour code.	Within three months			
2.6.3	The large crown mounted wireline turn down sheave is not provided with secondary retention arranged to catch the load. Inspection records to demonstrate that the sheave had been subject to periodic maintenance and inspection were not available.	Install secondary retention wire sling arranged to catch load on the wireline turn down sheave otherwise implement formal pre use inspection routine.	Within two months			
2.6.4	There was no SWL visible on the forklift truck.	Mark the SWL on the forklift truck so that it is clearly visible.	Within one week			
2.6.5	There was no SWL visible on the forward drill floor man riding winch.	Mark the SWL on the forward drill floor man riding winch so that it is clearly visible.	Within one week			

BP-HZN-MB100136244

**Appendix N | BP DEEPWATER HORIZON FOLLOW UP RIG AUDIT, MARINE ASSURANCE  
AUDIT AND OUT OF SERVICE PERIOD SEPTEMBER 2009**

Confidential

AUDIT REPORT ACTION SHEET

RIG TYPE: Semi-Submersible

RIG NAME: Deepwater Horizon

DATES OF AUDIT: 13 to 17 September 2009

RIG STATUS: Out of Service Period

REF	OBSERVATION	RECOMMENDATION	AUDIT TEAM ADVISED COMPLETION	ASSET ACCEPTANCE OR CHANGE	ACTUAL COMPLETION DATE	SIGNED OFF BY
2.66	The man riding winch wire certificates indicate that their wires have been in service for over 2 years which is outside Transocean's policy. Visual inspection of the wires indicated that they are still externally in satisfactory condition.	Man riding winch wires to be changed out at 2 year frequency in line with Transocean policy.	Within one month			
2.67	Both deck crane main block hooks are of the spring latch type. Transocean requirements specify positive locking latch type to be fitted.	In accordance with Transocean policy replace the spring latch type main block hooks on both deck cranes, to the positive latch type.	Within one month			
2.68	The safe load indicator on the starboard Liebherr deck crane has faulty back lit LCD screen. A temporary light has been installed so that the readings and alarm signal can be seen at night.	Replace the faulty back lit LCD screen on the safe load indicator on the starboard deck crane	Within one month			
2.69	There was no SWL visible on the port aft drill floor utility winch.	Mark the SWL on the aft drill floor utility winch so that it is clearly visible.	Within one week			

BP-HZN-MBI00136245

BP-HZN-IIT-0008905

**Appendix N | BP DEEPWATER HORIZON FOLLOW UP RIG AUDIT, MARINE ASSURANCE  
AUDIT AND OUT OF SERVICE PERIOD SEPTEMBER 2009**

Confidential

AUDIT REPORT ACTION SHEET

RIG TYPE: Semi-Submersible

RIG NAME: Deepwater Horizon

DATES OF AUDIT: 13 to 17 September 2009

RIG STATUS: Out of Service Period

REF	OBSERVATION	RECOMMENDATION	AUDIT TEAM ADVISED COMPLETION	ASSET ACCEPTANCE OR CHANGE	ACTUAL COMPLETION DATE	SIGNED OFF BY
3.2	<i>Drilling and Well Control</i>	<i>These are items that one would expect to find in place from a combination of competent drilling contractor and competent operator</i>				
3.2.1	Best practice regarding secondary retention of derrick mounted CCTV cameras was not in place. Only one barrier had been applied to the camera casing, the pan and tilt head was not provided with secondary retention.	Best practice for secondary retention to be applied to the derrick mounted CCTV cameras. Camera casing, pan, and tilt head to be provided with independent means of secondary retention as per the DROPS handbook.	Within monthly derrick inspection cycle			
3.2.2	MPI of the crown support beams could not be provided.	Provide documentary evidence to support MPI of the crown support beams. Otherwise mobilise competent third party to perform MPI of same.	Within one month			
3.2.3	No inspection documentation available to show MPI of the Ezy Torque has been performed.	Provide documentary evidence to support MPI of the Ezy Torque. Otherwise mobilise third party inspection company to perform the work.	Within one month			
3.2.4	Two anti-collision system (ACS) checklists have been produced. One of the lists contains just a few clash scenarios and is performed prior to each trip. The other is a comprehensive check of all clash scenarios which is not periodically performed.	Update RMS II to include scheduling for regular testing of the comprehensive ACS checklist.	Within two months			
3.2.5	The catwalk machine belt is worn and has some broken links at the join.	Repair / replace worn catwalk machine belt.	Within two months			

BP-HZN-MB100136246



**Appendix N | BP DEEPWATER HORIZON FOLLOW UP RIG AUDIT, MARINE ASSURANCE  
AUDIT AND OUT OF SERVICE PERIOD SEPTEMBER 2009**

Confidential

AUDIT REPORT ACTION SHEET

RIG TYPE: Semi-Submersible

RIG NAME: Deepwater Horizon

DATES OF AUDIT: 13 to 17 September 2009

RIG STATUS: Out of Service Period

REF	OBSERVATION	RECOMMENDATION	AUDIT TEAM ADVISED COMPLETION	ASSET ACCEPTANCE OR CHANGE	ACTUAL COMPLETION DATE	SIGNED OFF BY
3.2.6	UT thickness inspection reports for high pressure piping were generally poor. The report did not include original thickness, percentage diminution and some isometrics were missing. Consequently the reports amounted to little more than numbers thus the actual pipe work condition could not be established.	Transocean expectations regarding content of the UT thickness inspection reports to be communicated to the third party. Reports to include original thickness, percentage diminution and all isometrics. Pipe work assessment to determine condition to be made.	Within four months			
3.2.7	The aft finger board CCTV camera foundation bolts have been short bolted, in addition they are not provided with means of locking device.	Replace the foundation bolts in the aft finger board CCTV camera and ensure that a suitable locking device is in place.	Within monthly derrick inspection cycle.			
3.2.8	Two of the three hang off line pull back winches have unacceptably loose winch handles. On closer inspection it is evident that the tack weld between the handle and drive shaft has failed.	Replace defective hang off line pull back winches which have loose winch handles.	Within two months			
3.2.9	The top drive service loops were found in poor condition, the outer sheathing had significant mechanical damage due to abrasion with the mud hose.	Make necessary repairs to the outer sheathing of the top drive service loop and install protective spiral wrap.	Within two months			
3.2.10	Much of the well control maintenance was either recorded in the Subsea Engineers daily log book or on various spreadsheets. The level of well control related maintenance history recorded in RMS II was minimal by comparison.	Well control related planned and corrective maintenance to be recorded in RMS II. This simplifies searching for maintenance history and inspection records.	Immediately			
3.2.11	Derrick CCTV camera #5 is currently defective.	Repair/replace defective CCTV camera #5.	Within one month			

BP-HZN-MBI00136247

**Appendix N | BP DEEPWATER HORIZON FOLLOW UP RIG AUDIT, MARINE ASSURANCE  
AUDIT AND OUT OF SERVICE PERIOD SEPTEMBER 2009**

Confidential

AUDIT REPORT ACTION SHEET

RIG TYPE: Semi-Submersible

RIG NAME: Deepwater Horizon

DATES OF AUDIT: 13 to 17 September 2009

RIG STATUS: Out of Service Period

REF	OBSERVATION	RECOMMENDATION	AUDIT TEAM ADVISED COMPLETION	ASSET ACCEPTANCE OR CHANGE	ACTUAL COMPLETION DATE	SIGNED OFF BY
3.2.12	Maintenance notes for the 5 year overhaul of the deadline anchor consisted of cut and paste of the maintenance procedure, no additional comments were added. It was therefore not possible to determine what work was actually performed or indeed if the intent of the maintenance procedure was met. NOV inspection report could not be located on the rig.	Provide documentary evidence that deadline anchor 5 year overhaul was conducted in line with the maintenance procedure. This includes disassembly of the main pivot bearing.	Within two months			
3.2.13	According to maintenance history and NDT inspection reports inspection of the crown block and travelling block is not being conducted in line with the 365 day maintenance procedures. Results of the wobble test were not recorded and MPI was not conducted in accordance with task 4 of the procedure.	Ensure all points identified on the 365 day crown and travelling block maintenance routines are performed in accordance with the procedure tasks and clearly documented.	Within two months			
3.2.14	Current riser bolt and insert inspection reports were inadequate. The reports did not list the serial numbers of the individual bolts and inserts inspected.	For traceability purposes riser bolt and insert inspection reports to list the serial numbers of the units inspected.	At next inspection			
3.2.15	The aft window in the Assistant Driller's cabin is badly cracked. Due to this there is very limited vision of the pipe conveyor and surrounding area.	Change out the badly cracked aft window in the Assistant Driller's cabin.	Within three months			
3.2.16	The rotary table has been non operational for approaching four years. Spares availability is cited as the reason for this.	Expedite rotary table spares and return unit to operational condition as per contract requirements.	Within two months			

BP-HZN-MB100136248

**Appendix N | BP DEEPWATER HORIZON FOLLOW UP RIG AUDIT, MARINE ASSURANCE  
AUDIT AND OUT OF SERVICE PERIOD SEPTEMBER 2009**

Confidential

AUDIT REPORT ACTION SHEET

RIG TYPE: Semi-Submersible

RIG NAME: Deepwater Horizon

DATES OF AUDIT: 13 to 17 September 2009

RIG STATUS: Out of Service Period

REF	OBSERVATION	RECOMMENDATION	AUDIT TEAM ADVISED COMPLETION	ASSET ACCEPTANCE OR CHANGE	ACTUAL COMPLETION DATE	SIGNED OFF BY
3.2.17	When questioned about DROPS inspections drill crews stated that inspections were made in accordance with the maintenance routines generated in RMS II. However drilling personnel including the Toolpusher were not yet sufficiently knowledgeable in how to interrogate the system to demonstrate the routines and history.	Address the lack of knowledge by training relevant rig floor personnel in the use of RMS II2 and ensure that all non-conformances identified by the DROPS inspection programme are being managed effectively within RMS II.	Within two months			
3.2.18	Areas of high pressure system pipe work are not being inspected, lack of access being cited. In some cases, e.g. kill line, heavy corrosion is noted but no thickness measurements are recorded.	Ensure high pressure pipe work systems are fully inspected during UT thickness checks. Proper planning to provide access to entire systems to be in place.	Prior to next annual UT inspection			
3.2.19	Housekeeping under the catwalk machine belt is unacceptable with excessive trash accumulation evident.	Items of trash to be removed from under the catwalk machine belt, specifically nearest the rig floor	Within one week			

BP-HZN-MB100136249

**Appendix N | BP DEEPWATER HORIZON FOLLOW UP RIG AUDIT, MARINE ASSURANCE  
AUDIT AND OUT OF SERVICE PERIOD SEPTEMBER 2009**

Confidential

AUDIT REPORT ACTION SHEET

RIG TYPE: Semi-Submersible

RIG NAME: Deepwater Horizon

DATES OF AUDIT: 13 to 17 September 2009

RIG STATUS: Out of Service Period

REF	OBSERVATION	RECOMMENDATION	AUDIT TEAM ADVISED COMPLETION	ASSET ACCEPTANCE OR CHANGE	ACTUAL COMPLETION DATE	SIGNED OFF BY
3.3	<i>Technical Services</i>	<i>These are items that one would expect to find in place from a combination of competent drilling contractor and competent operator</i>				
3.3.1	There is no maintenance routine for the servicing of the main engine hydraulic overhaul tools and pumps.  BP lessons learned indicate a need to carry out regular maintenance of this equipment and the replacement of the pressure seals as per OEM maintenance routine dictates.	Update RMS II to include maintenance routines for servicing of the main engine hydraulic overhaul tools and pumps, as per OEM requirements.	Within three months			
3.3.2	Current injection tests of the main breakers have not been performed. It is usual that this is done during the 5-year SPS.	Provide update on status/requirements regarding current injection testing of main breakers.	Within four months			
3.3.3	It could not be demonstrated that the high voltage test gear is periodically calibrated.	High voltage test gear to be periodically calibrated.	Within three months			
3.3.4	All rig air regulators installed in the derrick at fingerboard control cubicles etc. had severe air leaks due to various defects.	Renew all defective derrick mounted rig air regulators.	Within one month			
3.3.5	The driller's cabin fire and gas panel had numerous alarm conditions displayed. These included, fire alarm active, fault ESD active, fault fire and gas active and fire and gas override active. The Driller and Assistant Driller on tour were unaware of the fault conditions.	Investigate and rectify various fault conditions displayed on the driller's cabin fire and gas panel. This panel is a slave from the main panel located on the bridge.	Within one week			

BP-HZN-MB100136250

**Appendix N | BP DEEPWATER HORIZON FOLLOW UP RIG AUDIT, MARINE ASSURANCE  
AUDIT AND OUT OF SERVICE PERIOD SEPTEMBER 2009**

Confidential

AUDIT REPORT ACTION SHEET

RIG TYPE: Semi-Submersible

RIG NAME: Deepwater Horizon

DATES OF AUDIT: 13 to 17 September 2009

RIG STATUS: Out of Service Period

REF	OBSERVATION	RECOMMENDATION	AUDIT TEAM ADVISED COMPLETION	ASSET ACCEPTANCE OR CHANGE	ACTUAL COMPLETION DATE	SIGNED OFF BY
3.3.6	It was communicated that since the maintenance system has been changed from Empac to RMS II maintenance routines now consist of existing rig specific, existing Transocean generic and ex GSF best practice routines. It has been left with the rig to determine those that are applicable. Non applicable routines have to be sifted out using the change request system. The current philosophy is too onerous on rig resources.	Transocean to confirm that the correct maintenance routines for the Deepwater Horizon have been loaded into RMS II.	Within four months			
3.3.7	Change over from Empac to RMS II maintenance systems has resulted in poor distribution of the maintenance routines. For example mechanic's routines amount to 1476.5 hours in January 2010, The ET has been assigned 244 hours for July 2010, the electrician has been assigned 3878.5 hours for January 2010; the marine department has been assigned 4265 hours for September 2009, etc for other disciplines. In some cases maintenance man hours exceed actual available man hours.	Review maintenance routines to evenly distribute throughout the year to ease maintenance burden on resources.	Within four months			
3.3.8	The integral monitor on the port side drilling UPS is defective.	Replace defective monitor on the port side drilling UPS.	Within four months			
3.3.9	Main engine #1 is currently out of service pending delivery and installation of a common rail type fuel pump.	Expedite and install fuel pump to main engine #1.	Within two weeks			

BP-HZN-MB100136251

**Appendix N | BP DEEPWATER HORIZON FOLLOW UP RIG AUDIT, MARINE ASSURANCE  
AUDIT AND OUT OF SERVICE PERIOD SEPTEMBER 2009**

Confidential

AUDIT REPORT ACTION SHEET

RIG TYPE: Semi-Submersible

RIG NAME: Deepwater Horizon

DATES OF AUDIT: 13 to 17 September 2009

RIG STATUS: Out of Service Period

REF	OBSERVATION	RECOMMENDATION	AUDIT TEAM ADVISED COMPLETION	ASSET ACCEPTANCE OR CHANGE	ACTUAL COMPLETION DATE	SIGNED OFF BY
3.3.10	The daily maintenance report did not accurately reflect outstanding planned or corrective maintenance or defect equipment. The BP Well Site Leaders were unaware of many of the equipment defects highlighted during the audit period.	Daily maintenance report to be updated / modified to include all equipment defects. Report to be submitted to the BP Well Site Leader on a weekly basis.	Within one week			
3.3.11	The air conditioning unit installed in the port deck crane cabin cab is non operational. The cabin is therefore uncomfortable.	Port deck crane operators cabin air conditioning unit to be repaired / replaced.	Within one month			
3.3.12	The E-Hawk system giving NOV remote drilling control system diagnostic access was defective. Consequently remote troubleshooting of the iron roughneck/ACS problems could not be performed.	E-Hawk system giving NOV remote access to the drilling control system to be made operational.	Within one month			
3.3.13	Thermographic inspection of the switchboards and electrical switchgear has not been performed since the rig entered service in 2000.	Undertake thermographic inspection of switchboards and MCC to locate and eradicate any potential hot spots to prevent electrical failures.	Within four months			
3.3.14	A formal process to demonstrate that defects noted during third party NDT inspections had been closed out was not in place.	Formal tracking process demonstrating close out of defects noted during third party NDT inspections to be implemented.	Within three months			

BP-HZN-MBI00136252

**Appendix N | BP DEEPWATER HORIZON FOLLOW UP RIG AUDIT, MARINE ASSURANCE  
AUDIT AND OUT OF SERVICE PERIOD SEPTEMBER 2009**

Confidential

AUDIT REPORT ACTION SHEET

RIG TYPE: Semi-Submersible

RIG NAME: Deepwater Horizon

DATES OF AUDIT: 13 to 17 September 2009

RIG STATUS: Out of Service Period

REF	OBSERVATION	RECOMMENDATION	AUDIT TEAM ADVISED COMPLETION	ASSET ACCEPTANCE OR CHANGE	ACTUAL COMPLETION DATE	SIGNED OFF BY
3.6	<b>Mechanical Handling</b>	<i>These are items that one would expect to find in place from a combination of competent drilling contractor and competent operator</i>				
3.6.1	Many of the remote grease nipples for the derrick mounted divert sheaves are dry indicating that this equipment is not being lubricated.	Ensure derrick mounted divert sheaves are greased in accordance with derrick maintenance routines.	Within one month			
3.6.2	It could not be verified that the rotary table bushing pullers and the rotary bowl pullers used on the drill floor were certified for use.	Provide current lifting certification for the rotary bushing pullers and the rotary bowl pullers used on the drill floor and colour code each item.	Within one month			
3.6.3	Several pad eyes in the mud pit room are still painted in last years lifting gear colour code, green. Potentially indicating that they were not inspected during the recent third party lifting gear inspection.	Green colour coded padeyes in the mud pit room to be inspected by competent person and colour coded yellow in line with the current lifting gear colour code.	Within one month			
3.6.4	The operators cab windscreen wipers are either non functional or have missing wiper blades on the port and starboard deck cranes, knuckle boom crane and riser gantry crane.	All windscreen wipers to be fully operational on the port and starboard deck cranes, knuckle boom crane and riser gantry crane.	Within two months			
3.6.5	The starboard side moon pool utility winch control lever was seized and hence the winch was non operational.	Starboard side moon pool utility winch to be made operational.	Within one month			

BP-HZN-MBI00136253

**Appendix N | BP DEEPWATER HORIZON FOLLOW UP RIG AUDIT, MARINE ASSURANCE  
AUDIT AND OUT OF SERVICE PERIOD SEPTEMBER 2009**

Confidential

AUDIT REPORT ACTION SHEET

RIG TYPE: Semi-Submersible

RIG NAME: Deepwater Horizon

DATES OF AUDIT: 13 to 17 September 2009

RIG STATUS: Out of Service Period

REF	OBSERVATION	RECOMMENDATION	AUDIT TEAM ADVISED COMPLETION	ASSET ACCEPTANCE OR CHANGE	ACTUAL COMPLETION DATE	SIGNED OFF BY
3.6.6	The riser gantry crane CCTV monitor is not working.	CCTV monitor on riser gantry crane to be made operational.	Within one month			
3.6.7	The rope guard on the port aft moon pool utility winch is broken.	Repair the broken rope guard on the port aft moon pool utility winch.	Within one month			
3.6.8	There is no emergency lowering instructions posted on the aft drill floor man riding winch.	Emergency lowering instruction to be posted at the aft drill floor man riding winch.	Prior to use			

BP-HZN-MB100136254



**Appendix N | BP DEEPWATER HORIZON FOLLOW UP RIG AUDIT, MARINE ASSURANCE  
AUDIT AND OUT OF SERVICE PERIOD SEPTEMBER 2009**

Confidential

AUDIT REPORT ACTION SHEET

RIG TYPE: Semi-Submersible

RIG NAME: Deepwater Horizon

DATES OF AUDIT: 13 to 17 September 2009

RIG STATUS: Out of Service Period

REF	OBSERVATION	RECOMMENDATION	AUDIT TEAM ADVISED COMPLETION	ASSET ACCEPTANCE OR CHANGE	ACTUAL COMPLETION DATE	SIGNED OFF BY
<b>4.1</b>	<b><i>Health, Safety and Safety Management</i></b>	<b><i>These are items that can be used by the drilling contractor and/or BP to build on the project, though they are not considered as essential.</i></b>				
4.1.1	Completion of the HSE OJT was required for all Transocean personnel. Long term third party personnel were not included in the process. The OJT covers permit to work and use of the various risk management tools. It would provide an effective means of ensuring that long term third party personnel were fully trained and conversant with the rig SMS.	Consider using the HSE OJT process as a training tool for all long term third party personnel on the rig.	Within three months			

BP-HZN-MB100136255

**Appendix N | BP DEEPWATER HORIZON FOLLOW UP RIG AUDIT, MARINE ASSURANCE  
AUDIT AND OUT OF SERVICE PERIOD SEPTEMBER 2009**

Confidential

AUDIT REPORT ACTION SHEET

RIG TYPE: Semi-Submersible

RIG NAME: Deepwater Horizon

DATES OF AUDIT: 13 to 17 September 2009

RIG STATUS: Out of Service Period

REF	OBSERVATION	RECOMMENDATION	AUDIT TEAM ADVISED COMPLETION	ASSET ACCEPTANCE OR CHANGE	ACTUAL COMPLETION DATE	SIGNED OFF BY
4.2	<b><i>Drilling and Well Control</i></b>	<b><i>These are items that can be used by the drilling contractor and/or BP to build on the project, though they are not considered as essential.</i></b>				
4.2.1	Dolly rail spreader beam at the monkey board has sustained significant mechanical damage, and is bent and deformed as a result.	Plan to change out damaged dolly rail spreader beam at the monkey board level of the derrick. Derrick builders' procedures and specifications to be followed.	Within six months			
4.2.2	During UT inspection of the choke pipeline significant corrosion was recorded in way of the moon pool.	Corrosion on choke line in the moon pool area to be addressed.	Within one year			
4.2.3	Localised surface and deep corrosion identified on the crown support beams and crown block/fast line pedestals.	Address corrosion on the crown support beams and crown block/fast line pedestals.	Within six months			
4.2.4	Completion of the HSE OJT was required for all Transocean personnel. Long term third party personnel were not included in the process. The OJT covers permit to work and use of the various risk management tools. It would provide an effective means of ensuring that long term third party personnel were fully trained and conversant with the rig SMS.	Consider using the HSE OJT process as a training tool for all long term third party personnel on the rig.	Within six months			
4.2.5	The derrick specifically from the fingerboard level down was coated in a thick film of mud, a few inches deep in some places.	Deep cleaning, pressure washing, of the derrick to be undertaken.	At next between wells period			

BP-HZN-MBI00136256

**Appendix N | BP DEEPWATER HORIZON FOLLOW UP RIG AUDIT, MARINE ASSURANCE  
AUDIT AND OUT OF SERVICE PERIOD SEPTEMBER 2009**

Confidential

AUDIT REPORT ACTION SHEET

RIG TYPE: Semi-Submersible

RIG NAME: Deepwater Horizon

DATES OF AUDIT: 13 to 17 September 2009

RIG STATUS: Out of Service Period

REF	OBSERVATION	RECOMMENDATION	AUDIT TEAM ADVISED COMPLETION	ASSET ACCEPTANCE OR CHANGE	ACTUAL COMPLETION DATE	SIGNED OFF BY
4.3	<i>Technical Services</i>	<i>These are items that can be used by the drilling contractor and/or BP to build on the project, though they are not considered as essential.</i>				
4.3.1	Siemens has phased out the SIMATIC 5 product range, which is used on the PRS and iron roughneck.	Address obsolescence issues, update PRS and iron roughneck PLC's from SIMATIC 5 to SIMATIC 7 product range which is supported by Siemens.	Within one year			
4.3.2	No long term planning was evident with respect to potential equipment and system obsolescence issues.	Undertake a systematic review of rig systems and equipment to identify and address obsolescence issues.	Within one year			
4.3.3	A number of critical systems, watertight doors, seawater cooling systems, fire and gas detectors, etc. were either defective or non operational due to lack of onboard spares.	Spares philosophy regarding critical spares inventory to be reviewed to ensure equipment uptime and availability.	Within one year			

BP-HZN-MB100136257

**Appendix N | BP DEEPWATER HORIZON FOLLOW UP RIG AUDIT, MARINE ASSURANCE  
AUDIT AND OUT OF SERVICE PERIOD SEPTEMBER 2009**

Confidential

AUDIT REPORT ACTION SHEET

RIG TYPE: Semi-Submersible

RIG NAME: Deepwater Horizon

DATES OF AUDIT: 13 to 17 September 2009

RIG STATUS: Out of Service Period

REF	OBSERVATION	RECOMMENDATION	AUDIT TEAM ADVISED COMPLETION	ASSET ACCEPTANCE OR CHANGE	ACTUAL COMPLETION DATE	SIGNED OFF BY
4.6	<i>Mechanical Handling</i>	<i>These are items that can be used by the drilling contractor and/or BP to build on the project, though they are not considered as essential.</i>				
4.6.1	The starboard crane boom is showing signs of damaged paint work and light corrosion where the vertical boom lattice chords meet the boom main chords.	Address the light corrosion and damaged paint work on the starboard crane boom where the vertical boom lattice chords meet the boom main chords.	Within one year			
4.6.2	There is no central rigging store area where all items of loose rigging equipment can be stored out of the weather, maintained and signed out. This leads to a situation where loose rigging equipment is stored at various areas of the rig without control and potentially proper inspection/maintenance.	Locate all loose lifting equipment to an enclosed centralised storage area. Adopt a register for signing out and in equipment and also its location such that control can be exercised.	Within six months			

BP-HZN-MB100136258

Photographs

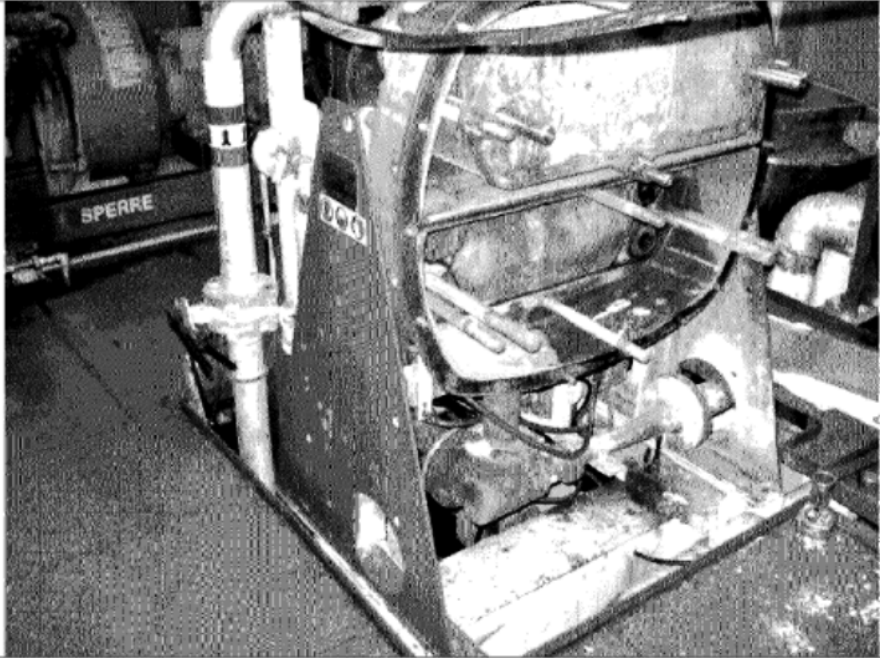
<b>Rig Name:</b>	Deepwater Horizon
<b>Date:</b>	September 2009
<b>ARAS Reference:</b>	1.1.5
	
<p><b>Observations or Comments:</b></p> <p>Maintenance on watermaker #5, note the front of the unit is opened up but none of the jacket water or seawater valves have been locked or tagged shut.</p>	

<b>Rig Name:</b>	Deepwater Horizon
<b>Date:</b>	September 2009
<b>ARAS Reference:</b>	2.2.5
	
<b>Observations or Comments:</b> Trash and loose items recovered from the derrick. The rig crew had made a derrick inspection the shift before our inspection was performed.	

<b>Rig Name:</b>	Deepwater Horizon
<b>Date:</b>	September 2009
<b>ARAS Reference:</b>	2.2.8
	
<b>Observations or Comments:</b> Poor condition of mud hose and top drive service loops	

**Appendix A**

**Blackout Recovery and DP System Upgrade  
Customer Acceptance Trials**

**Executive Summary**

Two black out tests were conducted with the first test considered a fail. There was a difficulty experienced in re-establishing engines to the 11 kV switchboard A. Engine 3 started and then failed while engine 2 was lagging in start timing. For this test it took nearly 14 minutes to re-establish all thrusters to the DP. The failure of engine 3 to start should be investigated to understand the mitigations to put in place to prevent a reoccurrence of this delay in successful black start recovery.

On repeating the test the restart of all the thrusters was achieved in less than 2 minutes. This was considered a successful test but did identify that engine 6 settings were blocked from starting for this test. The reason for the blocking was unclear as a request was made that the power system configuration settings be set up for normal drilling mode. On reviewing the Redundancy and Criticality Assessment (RCA) module on the Vessel Management System the documentation is unclear as to its function. In changing status from DP 3 mode to DP 1 mode the thrusters were deselected from the DP which was unexpected. The control modes of the RCA should be fully investigated and understood such that staff is aware of the implications to both the DP and vessel management system of this module.

As part of the out of service period a DP upgrade was implemented. This involved both hardware and software upgrades. As a result of this upgrade a customer acceptance test was conducted. The port HIPAP requires fault finding as this was not available. There were other minor findings which are being investigated. The rig also carried out a full set of field arrival DP trials. Test found some non-functional thruster emergency stop buttons and these deficiencies are to be addressed. The stability of the thruster 2 at start up appeared to have reliability issues and this reliability in start up should be further investigated.

Environmental Conditions  
Heading set at 136<sup>o</sup>  
Current 256<sup>o</sup> by 0.56 knots  
Wind 172<sup>o</sup> by 3.4 knots

**DP Blackout Testing**

The rig had planned a black out to ensure the system was fully functional and the rig and equipment could restart thrusters in an approximate time of 1 minute 40 seconds from loss of power to reinstatement of thrusters into the DP.

A number of prerequisites were set to ensure that the recovery process was successfully demonstrated. This included synchronisation of clocks, data logger functional, power system configured for normal drilling operations etc.



At the time of the black out, engine 1 was out of service due to diesel mounted fuel pump being inoperative. Engine 6 was warmed for the test but it was then found that problems were apparent with the air start valve for this engine; this required a strip down. A discussion took place regarding two diesel generators being out of service and it was felt that the test should be suspended until all diesel generators with the exclusion of engine 1 were available. One 2500 kVA transformer incomer breaker has a fault condition regarding recharging of the breaker (Tag 237056). Additionally one azimuth pump for the thruster 2 is reported as non-functional. The azimuth circuit uses two pumps normally with one in stand-by.

#### **First Black out Recovery Test**

##### Observations

Environmental Conditions  
Heading: 000°  
Wind: 080° by 14 knots  
K current: 090° by 0.7 knots  
Position Loss: 13m

The test protocol required that engine 4 be stopped using fuel rack failure mode. In essence this meant that for the test that engine 4 was unavailable in the black start recovery process.

Engine 1 was out of service with an engine driven fuel pump failure. For the test this left only engine 2, 3, 5 and 6 available.

The test proved unsuccessful. Although start commands were issued and the high voltage bus opened splitting the system one half of the bus had no generators connected. As no generators were connected to one bus this allowed only four thrusters to be started. It appeared that the rig suffered a partial black out on high voltage board A. Thrusters 6, 7, 8 and 2 were unable to start in line with the black start recovery. It was also noted that little operator intervention was undertaken even when only four thrusters came on line. The rig, based on the environment and the fact that four thrusters were available, was able to stabilise the set point position.

On interrogating the vessel management system logger the engine start commands for engine 3 (bus A) and engine 6 (bus B) were reported in two seconds, while for engine 5 it was 10 seconds and engine 2 it was 16 seconds. It can be understood why the start signal is not issued simultaneously for two engines connected to the same high voltage bus but it is not clear why there is a lag in start command for engine 2 (bus A). This could have been issued at 10 seconds corresponding with engine 5 (bus B). It is also unclear why engine 2 lagged in connecting to bus A. Engine 3 was connected at 23 seconds after the event while engine 2 did not connect until 42 seconds.

Two alarms occurred after 35 seconds relating to engine 3, fuel inlet pressure and HT cooling water circuit inlet water pressure low. Engine 3 circuit breaker tripped leaving the bus B with no engines on line at 40 seconds. Engine 2 then connected 2 seconds after this time. It is assumed that the engine 3 shut down was as a result of these two alarm conditions.

**Appendix N | BP DEEPWATER HORIZON FOLLOW UP RIG AUDIT, MARINE ASSURANCE  
AUDIT AND OUT OF SERVICE PERIOD SEPTEMBER 2009**

---

Thruster load reduction through the drives was demonstrated via the ABB frequency input monitoring. Successful opening and closing of high voltage breakers situated at switchboard 2 and 5 were demonstrated

The first four thrusters were on and enabled in 1 minute forty eight seconds, thruster 1, thruster 3, thruster 4 and thruster 5. The timing for the start up and enable to DP of the last four thrusters was significantly longer with the eight thrusters being available to the DP at 13 minutes 57 seconds. The last thruster being thruster 7. It is of note that a time out occurred at 42 seconds on the lead hydraulic pumps for this thruster but this is assumed to be as a result of the loss of switchboard 3.

Event Time	Time	Event Activity
9:42:13		Black out detected
9:42:15	0:00:02	Thrusters transfer to local control alarm, force reduction alarms
9:42:15	0:00:02	Start Engine 3, Bus A
9:42:15	0:00:02	Start Engine 6, Bus B
9:42:23	0:00:10	Start Engine 5, Bus B
9:42:29	0:00:16	Start Engine 2, Bus A
9:42:35	0:00:22	Engine 6 Connected Bus B
9:42:36	0:00:23	DG 3 Connected Bus A
9:42:42	0:00:29	UPS 11 Main failure, UPS 13 Back up failure
9:42:45	0:00:32	UPS 9 Main failure,
9:42:47	0:00:34	DG 3 HT Cooling Water low Pressure alarm
9:42:47	0:00:34	DG 3 Fuel oil inlet pressure low
9:42:47	0:00:34	DG 5 Connected to Bus B
9:42:53	0:00:40	DG 3 Circuit Breaker CB3-4 trips
9:42:54	0:00:41	Switchboard 4 Black out relay de-energised
9:42:54	0:00:41	Switchboard 3 Black out relay de-energised
9:42:54	0:00:41	Switchboard 2 Black out relay de-energised
9:42:55	0:00:42	DG2 Connected Bus A
9:42:54	0:00:41	Switchboard 2 Black out relay de-energised
9:43:25	0:01:12	UPS 10 Main Failure
9:43:40	0:01:27	UPS 14 port HIPAP failure
9:43:38	0:01:25	Thruster 1 successfully started
9:43:45	0:01:32	Thruster 3 successfully started
9:43:45	0:01:32	Thruster 4 successfully started
9:43:46	0:01:33	Thruster 1 enabled
9:43:48	0:01:35	Thruster 3 enabled
9:43:49	0:01:36	Thruster 4 enabled
9:43:51	0:01:38	Thruster 5 successfully started
9:43:57	0:01:44	Thruster 5 enabled
9:45:01	0:02:48	SWBD 2 11kV breaker closes
9:45:01	0:02:48	SWBD 5 11kV breaker closes
9:48:42	0:06:29	Thruster 8 enabled
9:49:49	0:07:36	Thruster 8 enabled
9:49:58	0:07:45	Thruster 2 enabled
9:56:10	0:13:57	Thruster 7 enabled

**Second Black out Recovery Test**

Observations

Environmental Conditions  
 Heading: 015°  
 Wind: 120° by 13 knots  
 K current: 072° by 0.77 knots  
 Position Loss: 27m

Engine 6 did not start during this test. The vessel management system indicated that the unit was not in stand-by and it is assumed that this is the reason for not starting. It is unclear why this engine was in this mode as it was made clear at the start of the test that the power system should be configured for normal drilling mode.

The rig is fitted with a Redundancy and Criticality System (RCA). This provides on-line fault monitoring which is used to monitor and alert the operator of any deviations identified in the operating mode selected. The system monitors on-line equipment and also applicable stand-by equipment status. The system Functional Design Specification (FDS) identifies that mode blocking is in use.

During testing it was noted that on switching mode selection from DP 1 to DP 3 this caused the thruster enable signals and all thrusters to drop out from the DP. The rig crew were unclear on this functionality and it is clear that further investigation into this system is required. It was also noted on the matrices contained within the FDS that prerequisites are required for the minimum number of generators on line.

Event Time	Time	Event Activity
14:12:16		DG 6 Not Standby (Check Aux)
14:12:17		UPS 13 Back up failure
14:12:17		Black out detected on all Switch boards
14:12:18	0:00:00	Thrusters transfer to local control alarm, force reduction alarms
14:12:18	0:00:00	Start Engine 2
14:12:19	0:00:01	Start Engine 5
14:12:21	0:00:03	Thrusters not ready alarm
14:12:23	0:00:05	Thrusters unexpected stop alarm
14:12:28	0:00:10	Start Engine 3
14:12:28	0:00:10	Insufficient thrust in surge and sway
14:12:32	0:00:14	DG 5 run rated
14:12:33	0:00:15	UPS 14 port HIPAP failure
14:12:38	0:00:20	DG 2 run rated
14:12:39	0:00:21	DG 2 connected
14:12:40	0:00:22	DG 5 connected
14:12:49	0:00:31	UPS 9, 10 mains failure
14:13:04	0:00:48	Position out of limits 5.4,5.0
14:13:11	0:00:53	DG 3 Connected

14:13:41	0:01:23	Switchboard 2 11 kV high voltage breaker closes
14:13:41	0:01:23	Switchboard 5 11 kV high voltage breaker closes
14:13:42	0:01:24	Thruster started
14:13:44	0:01:26	Thruster 1 enabled
14:13:45	0:01:27	UPS 13 Back up failure
14:13:46	0:01:28	Thruster 8 started
14:13:48	0:01:30	Thruster 8 enabled, UPS 10 main failure
14:13:50	0:01:32	UPS 14 port HIPAP failure, UPS 10 failure
14:13:50	0:01:32	Thruster 7 started
14:13:50	0:01:32	Thruster 4 started
14:13:51	0:01:33	Thruster 5 started
14:13:52	0:01:34	Thruster 4 enabled
14:13:53	0:01:35	Thruster 5 enabled
14:13:53	0:01:35	Thruster 6 started
14:13:54	0:01:36	Thruster 7 enabled
14:13:54	0:01:36	Thruster 6 enabled
14:13:55	0:01:37	Thruster 2 started
14:14:01	0:01:43	Thruster 2 enabled
14:14:01	0:01:43	PMS Step 4 bus A
14:14:03	0:01:45	Thruster 3 enabled
14:14:03	0:01:45	Thruster 3 started

**Conclusion**

The test protocol and the status of the non-functional engine 1 allowed for four of the engines to be used for the black start recovery process. The first black start recovery procedure was considered to have not achieved the objective of the recovery process. As a result the black start recovery test was conducted a second time. In this case the rig successfully restarted the thrusters and enabled the thrusters in the DP in 1 minute 45 seconds. During this test, engine 6 was inhibited from recovery sequence leaving only three engines to participate in the process. Further investigation is needed why engine 3 started on the first black start test and then failed. It is also of note that given that the automatic recovery process was expected to be within 2 minutes that manual intervention was not undertaken sooner during the first recovery process to improve recovery time.

The Reliability Criticality Assessment (RCA) system fitted on this rig appears not to be fully documented as to operation and cause and effects. The screen shots for the RCA Processor Unit and RCA Sub System modules were not populated. This tool should be fully investigated particularly with regards to the control modes and operational inputs it has exhibited. Changing modes indicates that the thrusters are deselected from the DP which is considered a risk area when using this system.

### **DP Upgrade**

The rig has just undergone a mid life upgrade with hardware and software changes to the DP system. This has included a replacement of the DPS 200 units with a DPS 232. DGPS 3 has been replaced with a multifix unit. The HIPAP system has been upgraded with two APOS 11 processors and the SBC 400H computers have been replaced. A new Seatex MRU 5 has been fitted (replacement for VRS #3). The Cos 200 processors have been replaced with MP7900 systems while SDP Logger and DP simulator have been replaced. Additionally Gyros #1 and #3 have been replaced with laser gyros.

### Customer Acceptance Trials Testing

To demonstrate that the equipment was fully integrated and functional a Kongsberg supplied Customer Acceptance Trials (CAT) programme was conducted. This was witnessed by the onboard marine team and representatives from Transocean onshore support. The CAT was based on the software upgrade Project SDP 6280 (SW version 6.2.2). Reference is made to CAT document 1117443 revision D, dated 10 September 2009.

Cabling management within the cabinets was clustered with cabling relating to the fibre optic converters poorly managed. Cable tidying within the cabinets containing the OS processors (MP7900) should be reviewed and improved as necessary. During the time of the CAT communications could not be established between DGPS 4 and the back up DP controller. The port HIPAP was not available for use as fault finding was ongoing.

A summary of the functional testing was undertaken based on the following test programme:

### Functional Checks

Lamp test carried out on OS stations and no defects noted

### Positional Stability Tests

Positioning accuracy undertaken in the fore and aft direction, moves forward and astern. Maximum overshoot noted as 1.6 m (after 40m ahead move).

Thrusters 1, 4, 5, 6, 7 and 8 in use and medium gain selected. References HPR 2, DGPS 1, 2 and 3. DGPS 4 (Seatex 232 used as independent reference)

Position reference accuracy in athwartships.

High gain selected for these moves.

Overshoot noted with maximum value of 0.6m

Heading rotation was undertaken with regards to reference systems. Reference systems are all selected. Demodulators monitored for interruption. No defects or blind sectors noted.

The raw data was observed during the turn. Standard Deviation (SD) for DGPS was found not greater than 0.5 m with GPS 1 being used as reference system. DGPS 2 was monitored and was giving an SD of 0.2m. The LBL array (using four transponders) had an SD of 2.5m. DGPS 3 has SD of 0.6m and DGPS 4 SD of 0.5m

Positional stability reasonable when rotation undertaken. No obvious blind sectors noted during rotation. GPS 3 was found less stable than other DGPS but was within tolerance.

Heading test were conducted with up to 30 degrees/minute rotational speed. Heading deviation found to be a maximum of 0.8 degrees with 0.6m in deviation in position.

Computer and Reference System Redundancy Tests Undertaken

- Comp A DPS 01
- Comp B DPS 11
- Comp C DPS 21

Each controller was failed and then reset. Failed master controller and transfer found to be successful. Reference sensor input to DP individually failed and appropriate alarms observed.

- VRS 3 not ready
- Gyro 1 not ready
- Gyro 2 not ready
- Gyro 3 not ready
- Wind sensor 2 not ready

DGPS 4 input to back up DP was found non functional at this time. This input error was later rectified such that DGPS 4 telegram data is received by the DP back up system.

Consequence Analysis System

Reduced the number of thrusters in selected in the DP down to thrusters 4 and 8. This caused 'Thrust critical if Switchboard 6 lost'

Reduced the number of engines down to engine 5 running only. Consequence alarm 'Thrust critical if switchboard 5 lost.' was generated.

With two generators on line with 8 MW load, (approx 65% of bus load) the bus critical alarm was to be simulated. The consequence system is set up such that it reads at the switchboard level only and assumes bus tie open. Hence unable to simulate the generation of the bus critical alarm.

Black out Prevention Test

Using joystick simulated high sudden demand. The high load with joystick caused the following alarms:

- Demand Reduced on Bus A, (4758, 11900, 7088)
- PMS Step 4 Bus A
- SA4 Force Reduction Alarms

Simulation undertaken with reduced number of thrusters. Thrusters enabled to DP 1, 4 and 5.

Autopilot and Auto Track Testing

Autopilot/auto track testing was undertaken as per the CAT procedure. No deficiencies were noted.

**Field Arrival Trials**

As part of the test programme in addition to the CAT a full set of field arrival tests was undertaken. These are usually undertaken in a managed programme after each well such that over the year a full set of trials has been completed. (Reference Document DP Field Arrival Trials revision 01).

Environmental Conditions  
Heading set at 130  
Current 165 by 0.76 knots  
Wind 158 by 12 knots

Key data was extracted and analysed from the rig response to both model control and drift off tests. A model control test was undertaken for duration of 10 minutes and the results were noted:

Max speed	0.08 knots
Average speed	0.06 knots
Drift distance	19.37 m

Table Model Control Test Results

Additionally a Drift off test was conducted. There were poor records as to the results of previous drift tests and the test was conducted with test criteria based on Op Doc 20 which is referenced in the Field arrival trials.

Max speed	0.30 knots
Average speed	0.22 knots
Drift distance	68.35 m

*Table drift off test results*

A drift off simulation was carried out on the DP system and then compared to the actual results achieved from the drift off test. Directionality appeared accurate.

Environmental Conditions  
Heading set at 136  
Current 256 by 0.56 knots  
Wind 172 by 3.4 knots

Time Stamp	Drift Programme	Actual Results
2 minutes 34 seconds	10m drift	9m drift
3 minutes 53 seconds	20m drift	16.5m drift
5 minutes 01 seconds	30m drift	24m drift

*Table drift off results, calculated versus actual drift off results*

Over 10 minutes approximately 11 degrees of heading was lost (to starboard)

Thruster Emergency Stops

As part of the CAT, the thruster emergency stops are tested at the DP desk. It was requested that the emergency stops for the thrusters be tested at the ECR and also the bridge thruster control desk. The results noted the following.

Thruster 3 emergency stop from the bridge thruster control panel non-functional  
Thruster 5 emergency stop from the ECR thruster control panel non-functional  
Thruster 5 emergency stop from the DP panel is not used as there is a wiring defect which although the button is functional would cause difficulties in resetting the emergency stop.

It is stated that the non-DP console thruster emergency stops have not been tested for at least a year; this routine should be included in the RMS maintenance system as a periodic test.

The long base line (LBL) and super short base line (SSBL) testing was undertaken. The LBL array has only four transponders and one transponder requires to be changed or settings reconfigured.



**Appendix O | RESULTS OF INSPECTIONS & SURVEYS OF DEEPWATER HORIZON (2009-2010)**

Date	RMI (ABS) <sup>515</sup>	RMI (DNV) <sup>516</sup>	USCG <sup>517</sup>	ABS <sup>518</sup>	BP <sup>519</sup>	ModuSpec USA Inc. <sup>520</sup>
16 MAY 07		No Non-Conformity				
20 MAR 09				No problem noted		
27 MAY 09	No problems noted					
27 JUL 09			No problems noted			
13 SEP 09				No problems noted		
17 SEP 09					<ul style="list-style-type: none"> <li>▪ Fire pump #1 out of service due to mechanical seal</li> <li>▪ Main engine 1 fuel pump not operational.</li> <li>▪ Fire damper system checks</li> <li>▪ 24,000 and 12,000 hour main engine overhauls are overdue.</li> <li>▪ Maintenance records were complete but quality of reporting was poor.</li> <li>▪ Of 26 remotely activated ventilation dampers spot checked and tested, six failed to operate. Monthly maintenance routine for inspection/activation exists but has not been carried out since July</li> </ul>	

<sup>515</sup> Republic of the Marshall Islands Form MSD 252 MOU/MODU – RMI 00149.

<sup>516</sup> DNV ISM Audit, 000017-000024.

<sup>517</sup> US Coast Guard Marine Inspection Safety & Law Enforcement (MISLE) data base Activity # 3513781.

<sup>518</sup> ABS survey reports 2009-2010, ABSDWH003979-ABSDWH004146.

<sup>519</sup> BP Common Marine Inspection Document dated 13-17 September 2009, BP-HZN-MBI00136211- BP-HZN-MBI00136270, BP-HZN-MBI00170553- BP-HZN-MBI00136669.

<sup>520</sup> MODU Condition Assessment DEEPWATER HORIZON, ModuSpec USA, Inc., 4/1-14/2010, TRN-USCG\_MMS-00038609--00038695.

**Appendix O | RESULTS OF INSPECTIONS & SURVEYS OF DEEPWATER HORIZON (2009-2010)**

Date	RMI (ABS) <sup>515</sup>	RMI (DNV) <sup>516</sup>	USCG <sup>517</sup>	ABS <sup>518</sup>	BP <sup>519</sup>	ModuSpec USA Inc. <sup>520</sup>
					<p>2009.</p> <ul style="list-style-type: none"> <li>▪ A60 classed doors latch mechanisms did not always energize allowing fire doors to be easily blown open.</li> <li>▪ Fire doors were being left open between engine rooms and switchboard rooms, compromising fire integrity of each compartment.</li> <li>▪ Watertight dampers were tested and found to be non-functional</li> <li>▪ Watertight door limit switches were found to be frozen and required fault finding or replacement.</li> <li>▪ Watertight doors automatic closing failed and could only be operated by local emergency hand pump. Unable to close remotely.</li> <li>▪ Watertight door dead man lever springs found to be in poor condition and required replacement.</li> <li>▪ 7 defective fire detector heads need to be changed out</li> <li>▪ 2 defective flammable gas detector heads need to be changed out</li> <li>▪ Two loss of electrical power recover tests were performed. The first test did not fully recover but the MODU was able to recover enough to maintain position. The second test had a full recovery of the system.</li> </ul>	
18 SEP 09	No problems noted			No problems noted		

**Appendix O | RESULTS OF INSPECTIONS & SURVEYS OF DEEPWATER HORIZON (2009-2010)**

Date	RMI (ABS) <sup>515</sup>	RMI (DNV) <sup>516</sup>	USCG <sup>517</sup>	ABS <sup>518</sup>	BP <sup>519</sup>	ModuSpec USA Inc. <sup>520</sup>
23 FEB 10	No problems noted			<ul style="list-style-type: none"> <li>▪ Lube Oil low pressure tripping device on the number5 Main Generator engine inoperable</li> </ul>		
14 APR 10						<ul style="list-style-type: none"> <li>▪ Supply fans for the machinery area on the port and starboard sides of the MODU were corroded severely and the gaskets were in bad condition. Supply duct for the fans on the port side of the MODU had gaskets pieced together in the corners of the hatch covers leaving gap in the gasket.</li> <li>▪ None of the electrical equipment in the hazardous locations on the MODU were tagged</li> <li>▪ Shaker motor starters extremely dirty and covered in mud and several were missing certification labels</li> <li>▪ No ABS approved hazardous area drawings on the MODU at the time of this assessment</li> <li>▪ Fire Detection System – no detectors inhibited or any in alarm.</li> <li>▪ Gas Detection System – no detectors either in fault or inhibited condition, other than</li> </ul>

**Appendix O | RESULTS OF INSPECTIONS & SURVEYS OF DEEPWATER HORIZON (2009-2010)**

---

Date	RMI (ABS) <sup>515</sup>	RMI (DNV) <sup>516</sup>	USCG <sup>517</sup>	ABS <sup>518</sup>	BP <sup>519</sup>	ModuSpec USA Inc. <sup>520</sup>
						units being serviced. <ul style="list-style-type: none"> <li>▪ Port forward air winch wire rubbing against a steel plate on the lower derrick level creating friction</li> </ul>

**JOINT DEPARTMENT OF THE INTERIOR  
AND  
DEPARTMENT OF HOMELAND SECURITY  
STATEMENT OF PRINCIPLES AND CONVENING ORDER  
REGARDING  
INVESTIGATION INTO THE MARINE CASUALTY, EXPLOSION, FIRE,  
POLLUTION, AND SINKING OF MOBILE OFFSHORE DRILLING UNIT  
DEEPWATER HORIZON, WITH LOSS OF LIFE  
IN THE GULF OF MEXICO 21-22 APRIL 2010**

1. The Department of the Interior and the Department of Homeland Security (collectively, “the Agencies”) have determined that a joint investigation (“Joint Investigation”) of the April 21-22, 2010 explosion and sinking of the mobile offshore drilling unit DEEPWATER HORIZON is warranted. Therefore, the Agencies hereby adopt the following statement of principles and convening order regarding the Joint Investigation. Each Agency, at its discretion, may elect to adopt additional internal measures to govern direction and oversight of their respective portion of the Joint Investigation.
2. The Outer Continental Shelf Lands Act (“OCSLA”) grants the Secretaries of the Agencies the authority to investigate incidents resulting from operations on the U.S. Outer Continental Shelf (“OCS”). 43 U.S.C. § 1348. The Minerals Management Service (“MMS”), a unit of the Department of the Interior, and the United States Coast Guard (“USCG”), a component of the Department of Homeland Security, have identified a process for conducting investigations under the authority of the OCSLA in a Memorandum of Agreement (“MOA”), dated 27 March 2009. As set forth in the MOA, the MMS investigates incidents associated with, *inter alia*, exploration and drilling operations for hydrocarbons on the OCS, and the USCG investigates, *inter alia*, deaths, injuries, property loss, and environmental damage arising from such incidents.
3. A Joint Investigation is hereby convened in accordance with the MOA, as modified herein. The Joint Investigation is classified as a Coast Guard Marine Board of Investigation within the meaning of 46 C.F.R. § 4.09 and a Panel Investigation within the meaning of 30 C.F.R. § 250.191. The Joint Investigation is convened pursuant to agency authorities and will be conducted pursuant to the procedures contained in 43 U.S.C. § 1348, 14 U.S.C. § 141, 46 U.S.C §§ 6301 *et seq.*, 33 C.F.R. § 140, Subpart C; 30 C.F.R. §§ 250.186-191, and 46 C.F.R. Part 4.
4. The Agencies intend to conduct the Joint Investigation as follows: The MMS and the USCG will co-chair the Joint Investigation. The Joint Investigation team will investigate thoroughly the matter hereby submitted to it in accordance with the provisions of 43 U.S.C. § 1348, 46 U.S.C. § 6301 *et seq.*, and the applicable regulations thereunder. The Joint Investigation shall have the powers of both Agencies, and, for the public hearing portions of the Joint Investigation, shall follow the policies and procedures for a Marine Board of Investigation contained in 46 C.F.R. § 4.09 and the Coast Guard Marine Safety Manual, Volume V. In cases where the procedures of a Marine Board of Investigation and a Panel Investigation appear to differ, the procedures for a Marine Board of Investigation shall govern. Any issue involving procedure may be referred to

Appendix P | CONVENING ORDER JOINT DEPARTMENT OF THE INTERIOR AND DEPARTMENT OF HOMELAND SECURITY STATEMENT OF PRINCIPLES AND CONVENING ORDER REGARDING INVESTIGATION INTO THE MARINE CASUALTY, EXPLOSION, FIRE, POLLUTION, AND SINKING OF MOBILE OFFSHORE DRILLING UNIT DEEPWATER HORIZON, WITH LOSS OF LIFE IN THE GULF OF MEXICO 21-22 APRIL 2010

---

the Chief of the Accident Investigation Board of the MMS, and the Chief of USCG Office of Investigations and Casualty Analysis. They will refer any unresolved procedural issue to the Chief, Office of Offshore Regulation, MMS, and the Commandant, Director of Prevention Policy (CG-54), USCG, who will consider the matter together and provide guidance jointly to the Joint Investigation.

5. Upon completion, the Joint Investigation team will issue a single report to the Director, MMS, and the Commandant, USCG, containing the evidence adduced, the facts established thereby, and its conclusions and recommendations. The report shall meet the requirements of both the MMS and USCG. Any conclusions or recommendations concerning commendatory actions or misconduct which would warrant further inquiry shall be referred by separate correspondence to the cognizant Regional Coordinator or District Commander. Similarly, any information warranting further evaluation for potential civil violations or criminal activity shall be referred in accordance with applicable procedures. On days that the Joint Investigation conducts a public hearing, a daily summary of significant events shall be transmitted to the Chief of the Accident Investigation Board and the Chief of USCG Office of Investigations and Casualty Analysis. The Joint Investigation team will report its progress, as may be requested by superior authority designated by the Department of Interior or the Department of Homeland Security.

6. The report should be completed and submitted simultaneously to the Director, MMS, and the Commandant, USCG, within nine months of the convening date. If this deadline cannot be met, at least thirty calendar days prior, a written explanation for the delay and the expected completion date shall be submitted to the Director, MMS, and Commandant, USCG. The Joint Investigation team is encouraged to submit interim recommendations intended to prevent similar casualties, if appropriate, early in the Joint Investigation.

7. Prior to submission of the team's report to the Director, MMS, and the Commandant, USCG, the Joint Investigation team will confer with the Chief of the Accident Investigation Board and the Chief of USCG Office of Investigations and Casualty Analysis, both of whom will review the report and reconcile any remaining issues to the maximum extent practicable. If the respective Chiefs are unable to reconcile any remaining issues, they will elevate the issues to appropriate officials within their respective Agency.

8. The Director, MMS, and the Commandant, USCG, will jointly sign and release the final report. If either Agency differs with the other concerning any conclusions or recommendations, either Agency may issue a supplemental or separate report.

9. ██████████ MMS, and Captain Hung Nguyen, USCG, are designated as Co-Chairs of the Joint Investigation. Other Members and the Recorder of the Joint Investigation will be designated by separate correspondence, and each Agency has the right to be equally represented. Agency costs for the Joint Investigation shall be borne by the Agency incurring the expense.

10. The Government of Marshall Islands, the flag state administration of the DEEPWATER HORIZON has requested to participate in this Joint Investigation. It shall be designated as a Party In Interest and given the rights associated with such status in accordance with 46 U.S.C. § 6303.

Appendix P | CONVENING ORDER JOINT DEPARTMENT OF THE INTERIOR AND DEPARTMENT OF HOMELAND SECURITY STATEMENT OF PRINCIPLES AND CONVENING ORDER REGARDING INVESTIGATION INTO THE MARINE CASUALTY, EXPLOSION, FIRE, POLLUTION, AND SINKING OF MOBILE OFFSHORE DRILLING UNIT DEEPWATER HORIZON, WITH LOSS OF LIFE IN THE GULF OF MEXICO 21-22 APRIL 2010

---



THAD W. ALLEN  
Admiral, U.S. Coast Guard  
Commandant

Date: APR 26 2010



JANET NAPOLITANO  
Secretary  
Department of Homeland Security

Date: APR 27 2010



Director  
Minerals Management Service

Date: APR 27 2010

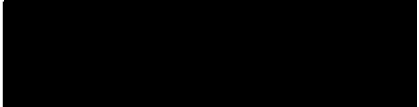

KEN SALAZAR  
Secretary  
Department of the Interior

Date: APR 27 2010

## Appendix Q | USCG INVESTIGATION TEAM MEMBERS

---

CAPT Suzanne Englebert (CG-545)  
CAPT David Fish (CG-545)  
CAPT Mark Higgins (LANTAREA)  
CAPT Hung Nguyen (Sector Ohio Valley/D14)  
CAPT James Whitehead (Sector Houston-Galveston)  
CDR Malcolm "Rob" McLellan (CG-545)  
LCDR [REDACTED] (CG-0942)  
LCDR [REDACTED] (TRACEN Yorktown)  
LCDR [REDACTED] (CG-5451)  
LCDR [REDACTED] (CG-5451)  
LCDR [REDACTED] (Sector Honolulu)  
LCDR [REDACTED] (Offshore National Center of Expertise)  
LCDR [REDACTED] (CG-5451)  
LCDR [REDACTED] (CG-5451)  
LT [REDACTED] (MSU Houma)  
LT [REDACTED] (MSU Morgan City)  
LT [REDACTED] (MSU Morgan City)  
LT [REDACTED] (District Eight)  
LT [REDACTED] (Marine Safety Center)  
LT [REDACTED] (Offshore National Center of Expertise)  
LT [REDACTED] (CG-545)  
LT [REDACTED] (MSU Morgan City)  
CWO4 [REDACTED] (PADET Houston)  
CWO2 [REDACTED] (MSU Morgan City)  
PACS [REDACTED] (District Eight)  
PA1 [REDACTED] (District Eight)  
YN1 [REDACTED] (CG-545)  
YN1 [REDACTED] (MSU Port Arthur)  
PA2 [REDACTED] (PADET Houston)  
PA2 [REDACTED] (District Eight)  
PA2 [REDACTED] (PADET Houston)



**Appendix Q | USCG INVESTIGATION TEAM MEMBERS**

---

YN2 [REDACTED] (Sector New Orleans)  
PA3 [REDACTED] (PADET Houston)  
SK3 [REDACTED] (CG-0948)  
PA3 [REDACTED] (District Eight)  
PA3 [REDACTED] (District Eight)  
Mr. [REDACTED] (Investigations National Center of Expertise)  
Mr. [REDACTED] (CG-5451)  
Mr. [REDACTED] (Investigations National Center of Expertise)  
Mr. [REDACTED] (CG-5214)  
Mr. [REDACTED] (Sector San Francisco)  
Mr. [REDACTED] (CG-5222)  
Mr. [REDACTED] (Offshore National Center of Expertise)  
Ms. [REDACTED] (CG-5453)  
Mr. [REDACTED] (Marine Safety Center)  
Mr. [REDACTED] (Offshore National Center of Expertise)  
Mr. [REDACTED] (Sector San Francisco)  
Mr. [REDACTED] (MSU Morgan City)