

DEPARTMENT OF TRANSPORTATION



**COAST GUARD**

**MARINE CASUALTY REPORT**

COLLAPSE AND SINKING  
OF MOBILE OFFSHORE DRILLING UNIT  
RANGER I IN THE GULF OF MEXICO  
ON 10 MAY 1979 WITH LOSS OF LIFE

U.S. COAST GUARD  
MARINE BOARD OF INVESTIGATION REPORT

AND

COMMANDANT'S ACTION

REPORT NO. USCG 16732/93621

1. Report No. USCG 16732/93261		2. Government Accession No.		3. Recipient's Catalog No.	
4. Title and Subtitle Marine Casualty Report Uninspected Self-Elevating Mobile Drilling Unit RANGER I: collapse and sinking in the Gulf of Mexico on 10 May 1979 with loss of life				5. Report Date 13 May 1981	
				6. Performing Organization Code G-MMI-1/TP24	
7. Author(s)				8. Performing Organization Report No. 16732/93261	
9. Performing Organization Name and Address  U. S. Coast Guard Washington, D. C. 20593				10. Work Unit No.	
				11. Contract or Grant No.	
12. Sponsoring Agency Name and Address Commandant (G-MMI-1/TP24) U. S. Coast Guard Washington, D. C. 20593				13. Type of Report and Period Covered MARINE CASUALTY REPORT 10 May 1979	
				14. Sponsoring Agency Code	
15. Supplementary Notes					
<p>16. Abstract On 10 May 1979, about 2230, c.s.t., the RANGER I collapsed and sank in the Gulf of Mexico while jacked up on location in block 189L, 12 miles offshore Galveston, Texas. The collapse and sinking caused major structural damage to the upper hull, support mat and three support legs. Although these major components were raised from the bottom of the gulf and taken to Galveston, the unit was a total loss. The DELTA SEAHORSE, which was moored to the RANGER I, sustained minor hull damage as a result of being struck by the upper hull of the unit as it collapsed. Of the 30 persons aboard the RANGER I, 7 were killed, 1 is missing and presumed dead and 18 were injured resulting in incapacitation in excess of 72 hours.</p> <p>This report contains the U. S. Coast Guard Marine Board of Investigation Report and the Action taken by the Commandant to determine the proximate cause of the casualty and the recommendations to prevent recurrence.</p> <p>The Commandant has concurred with the Marine Board that the proximate cause of the casualty was an existing fatigue crack in the RANGER I's stern leg. The Marine Board concluded that the fatigue crack existed for at least 300 days prior to the time the RANGER I entered the shipyard for repairs on 12 February 1979. The fatigue crack was not visually detected either by the American Bureau of Shipping (ABS) surveyor or the USCG inspector during the shipyard period. Subsequent to the casualty, ABS amended their rules for inspection of mobile offshore drilling units to provide for the non-destructive testing of critical connections of support legs at periodic intervals.</p>					
17. Key Words Uninspected, shipyard; sinking failures; cracks; stability; drowning; life jackets; emergency; rescue; darkness; ABS; distress; fatalities; injuries			18. Distribution Statement This document is available to the public through the National Technical Information Service, Springfield, Virginia 22121		
19. Security Classif. (of this report) UNCLASSIFIED		20. Security Classif. (of this page) UNCLASSIFIED		21. No. of Pages	22. Price

COLLAPSE AND SINKING OF MOBILE OFFSHORE DRILLING  
UNIT RANGER I IN THE GULF OF MEXICO ON 10 MAY 1979  
WITH LOSS OF LIFE

TABLE OF CONTENTS

	<u>Page</u>
<b>ACTION BY THE COMMANDANT - U. S. COAST GUARD</b>	
Comments on Conclusions.....	1
Action Concerning the Recommendations.....	2
<b>MARINE BOARD OF INVESTIGATION</b>	
Findings of Fact.....	1
Figure 1.....	8
Figure 2.....	9
Figure 3.....	10
Figure 4.....	22
Figure 5.....	24
Figure 6.....	28
Figure 7.....	32
Conclusions.....	35
Recommendations.....	37



DEPARTMENT OF TRANSPORTATION  
UNITED STATES COAST GUARD

MAILING ADDRESS:  
U.S. COAST GUARD (G-MMI-1/TP24)  
WASHINGTON, DC 20593  
PHONE: 202 426-1455

16732/RANGER I

13 MAY 1981

Commandant's Action

on

The Marine Board of Investigation convened to investigate the circumstances surrounding the collapse and sinking of the Un-inspected Self-Elevating Mobile Drilling Unit RANGER I, O.N. 517767, in the Gulf of Mexico on 10 May 1979 with loss of life

The report of the Marine Board of Investigation convened to investigate the subject casualty has been reviewed; and the record, including the findings of fact, conclusions and recommendations, is approved subject to the following comments.

COMMENTS ON CONCLUSIONS

1. With regard to conclusion 6, part 16 of the American Bureau of Shipping (ABS) 1980 Rules for Mobile Offshore Drilling Units, published subsequent to this casualty, now contains provisions for the non-destructive testing of critical connections of support legs at periodic intervals.

ACTION CONCERNING THE RECOMMENDATIONS

1. Recommendation 1:

Action: This recommendation is concurred with. As noted above part 16 of the ABS 1980 Rules for Mobile Offshore Drilling Units has been amended to provide for the non-destructive testing of critical connections of support legs at periodic intervals. A copy of this report has been forwarded to ABS for their further information.



It's a law we  
can live with.

2. Recommendation 2, 3, 4 and 5:

Action: These recommendations are concurred with. Further investigations under the Civil Penalty Proceedings against [REDACTED], the owners of the RANGER I and the owners of the DELTA SEAHORSE were initiated by the Commanding Officer of the Marine Safety Office (MSO) Galveston, Texas. Further investigation under R.S. 4450 in the case of [REDACTED] was also initiated by the Commanding Officer, MSO Galveston.

3. Recommendation 6:

Action: This recommendation is not concurred with. The need for remedial legislation is obviated by the proposed regulatory changes to 33 CFR 140-147 which require that U. S. flag units drilling on the Outer Continental Shelf be inspected and certificated regardless of tonnage. Units that operate in state waters are under state and Occupational Safety and Health Administration (OSHA) jurisdiction. Self-propelled U. S. flag units of less than 300 gross tons operating in foreign waters are not subject to U. S. inspection but would be subject to any requirements imposed by foreign countries in whose waters these rigs are working.

4. Recommendation 7:

Action: This recommendation is concurred with. The proposed changes to 33 CFR 140 will require U. S. flag units operating/drilling on the OCS to be inspected and certificated. Under 46 CFR 109, Subpart E, certificated units will be required to post station bills; furthermore, "the master or person in charge shall....ensure that temporary personnel and visitors are advised of their emergency stations and assigned a seat in a lifeboat or liferaft upon their arrival aboard the unit, and... ensure that all persons on the unit are familiar with the station."

5. Recommendation 8:

Action: This recommendation is concurred with. The number of personnel allowed on drilling units will be fixed by the Certificate of Inspection. Under proposed changes to 33 CFR 140, U. S. flag drilling units operating on the OCS will be inspected and certificated regardless of tonnage or whether the unit is self-propelled.

[REDACTED]  
J. B. HAYES  
Admiral, U.S. Coast Guard  
Commandant



DEPARTMENT OF TRANSPORTATION  
UNITED STATES COAST GUARD

Commandant (G-MMI)  
U.S. Coast Guard  
Washington, D.C. 20593

16732/RANGER I  
12 June 1980

From: Marine Board of Investigation  
To: Commandant (G-MMI)

Subj: Uninspected Self-elevating Mobile Drilling Unit RANGER I,  
O.N. 517767; collapse and sinking in the Gulf of Mexico on  
10 May 1979 with loss of life

FINDINGS OF FACT

1. SUMMARY:



On 10 May 1979, about 2230, c.s.t., the RANGER I collapsed and sank in the Gulf of Mexico while jacked up on location in block 189L, 12 miles offshore Galveston, Tex. The collapse and sinking caused major structural damage to the upper hull, support mat and three support legs. Although these major components were raised from the bottom of the gulf and taken to Galveston, the unit was a total loss. The DELTA SEAHORSE, which was moored to the RANGER I, sustained minor hull damage as a result of being struck by the upper hull of the unit as it collapsed. Of the 30 persons aboard the RANGER I, 7 were killed, 1 is missing and presumed dead and 18 were injured resulting in incapacitation in excess of 72 hours.

2. VESSEL DATA:

NAME:	RANGER I	DELTA SEAHORSE
OFFICIAL NUMBER:	517767	299199
SERVICE:	Oil exploitation	Oil exploitation
RIG:	Oil screw	Oil screw
GROSS TONS:	196.6	179
NET TONS:	196	122
LENGTH:	120 feet	146.7 feet
BREADTH:	84.1 feet	32 feet
DEPTH:	16.1 feet	11.4 feet



It's a law we  
can live with.

PROPULSION:	2 Murray & Tregurtha Harbormaster diesel propulsion units	2 General Motors Diesel engines 12V-149
HORSEPOWER:	1000	1550
HOMEPORT:	Houston, Tex.	Morgan City, La.
OWNER:	Atlantic Pacific Marine Corp. 2425 Fountain View, Suite 300, Houston, Tex. 77057	Seahorse Boat Service, Inc. P. O. Box 968 Morgan City, La. 70380
OPERATOR:	Owner	Owner
MASTER/PERSON IN CHARGE:		
LICENSE:	None	Master of Steam and Motor vessels of less than 300 gross tons, upon the Gulf of Mexico, not more than 100 miles offshore, while engaged in the mineral and oil in- dustry. Also operator of uninspected towing vessels upon oceans not more than 200 miles offshore, and inland waters of the United States, not including the Western Rivers
MERCHANT MARINERS DOCUMENT:	None	
CERTIFICATE OF INSPECTION:	Not required	Required
LAST INSPECTION:	N/A	Biennial
DATE:	N/A	2 May 1979
PLACE OF ISSUE:	N/A	New Orleans, La.

3. PERSONNEL:

a. Known Dead:

(1) NAME: Eddie J. Frederick (SSN [REDACTED])  
AGE: [REDACTED]  
OCCUPATION/EMPLOYER: Derrickman/Atlantic Pacific Marine Corp.  
NEXT OF KIN: [REDACTED] (wife)  
[REDACTED]

CAUSE OF DEATH: Drowning and cranio-cerebral trauma  
PLACE OF INTERMENT: St. Paul Cemetery  
Abbeville, La.

(2) NAME: Cruz H. Palomarez, Jr. (SSN [REDACTED])  
AGE: [REDACTED]  
OCCUPATION/EMPLOYER: Halliburton Service Representative  
NEXT OF KIN: [REDACTED] (wife)

CAUSE OF DEATH: Accidental Drowning  
PLACE OF INTERMENT: San Gabriel Cemetery  
Richmond, Tex.

(3) NAME: Walter K. Fontenot (SSN [REDACTED])  
AGE: [REDACTED]  
OCCUPATION/EMPLOYER: Welder/International Hammers, Inc.  
NEXT OF KIN: [REDACTED] (wife)

CAUSE OF DEATH: Drowning  
PLACE OF INTERMENT: St. Edmond Cemetery  
Branch, La.

(4) NAME: Levence J. Guidry (SSN [REDACTED])  
AGE: [REDACTED]  
OCCUPATION/EMPLOYER: Surveyor/John E. Chance Company  
NEXT OF KIN: [REDACTED] (wife)

CAUSE OF DEATH: Asphyxia due to drowning  
PLACE OF INTERMENT: Greenlawn Memorial Gardens  
Lafayette, La.

(5) NAME: Barton James Sealy (SSN [REDACTED])  
AGE: [REDACTED]  
OCCUPATION/EMPLOYER: Sales Representative/Southwest Oil Field Products  
NEXT OF KIN: [REDACTED] (father)  
[REDACTED]

CAUSE OF DEATH: Cranio-cerebral trauma and asphyxia due to drowning.



PLACE OF INTERMENT: St. Francis De Sales #2  
Houma, La.

(6) NAME: John Perkins  
AGE: [REDACTED]  
OCCUPATION/EMPLOYER: Electrician/Atlantic Pacific Marine Corp.  
NEXT OF KIN: [REDACTED] (father)  
[REDACTED]  
CAUSE OF DEATH: Asphyxia due to drowning  
PLACE OF INTERMENT: Remains retained by Galveston County Coroner

(7) NAME: Clarence Hanks  
AGE: [REDACTED]  
OCCUPATION/EMPLOYER: Welder/International Hammers  
NEXT OF KIN: [REDACTED] (wife)  
[REDACTED]  
CAUSE OF DEATH: Asphyxia due to drowning  
PLACE OF INTERMENT: Remains retained by Galveston County Coroner

b. Missing - Presumed Dead:

(1) NAME: Dennis Ray Smith  
AGE: [REDACTED]  
OCCUPATION/EMPLOYER: Welder/International Hammers  
NEXT OF KIN: [REDACTED] (wife)  
[REDACTED]  
CAUSE OF DEATH: Unknown  
PLACE OF INTERMENT: Missing

c. Injuries in Excess of 72 Hours:

(1) NAME: [REDACTED]  
AGE: [REDACTED]  
ADDRESS: [REDACTED]  
OCCUPATION/EMPLOYER: Field Rep./Southwest Oil Field Service  
INJURY: Caustic burn to leg and bruised head

(2) NAME: [REDACTED]  
AGE: [REDACTED]  
ADDRESS: [REDACTED]  
OCCUPATION/EMPLOYER: Cook/Louisiana Offshore Caterers  
INJURY: Foot laceration

(3) NAME: [REDACTED]  
AGE: [REDACTED]  
ADDRESS: [REDACTED]

OCCUPATION/EMPLOYER: Mechanic/Halliburton  
INJURY: Bruised head and back

(4) NAME: [REDACTED]  
AGE: [REDACTED]  
ADDRESS: [REDACTED]

OCCUPATION/EMPLOYER: Welder/International Hammers  
INJURY: Bruised shoulder and nervous disorder

(5) NAME: [REDACTED]  
AGE: [REDACTED]  
ADDRESS: [REDACTED]

OCCUPATION/EMPLOYER: Welder/International Hammers  
INJURY: Bruised back and nervous disorder

(6) NAME: [REDACTED]  
AGE: [REDACTED]  
ADDRESS: [REDACTED]

OCCUPATION/EMPLOYER: Hammer operator/International Hammers  
INJURY: Caustic burns on legs

(7) NAME: [REDACTED]  
AGE: [REDACTED]  
ADDRESS: [REDACTED]

OCCUPATION/EMPLOYER: Company Man/Mitchell Energy Offshore Corp.  
INJURY: Head laceration and bruised legs

(8) NAME: [REDACTED]  
AGE: [REDACTED]  
ADDRESS: [REDACTED]

OCCUPATION/EMPLOYER: Cook/Louisiana Offshore Caterers  
INJURY: Finger lacerations

(9) NAME: [REDACTED]  
AGE: [REDACTED]  
ADDRESS: [REDACTED]

OCCUPATION/EMPLOYER: Roughneck/Atlantic Pacific Marine Corp.  
INJURY: Arm amputation

(10) NAME: [REDACTED]  
AGE: [REDACTED]  
ADDRESS: [REDACTED]

OCCUPATION/EMPLOYER: Roustabout/Atlantic Pacific Marine Corp.  
INJURY: Caustic burns on legs

(11) NAME: [REDACTED]  
AGE: [REDACTED]

ADDRESS: [REDACTED]

OCCUPATION/EMPLOYER: Welder/Atlantic Pacific Marine Corp.  
INJURY: Extensive caustic burns

(12) NAME: [REDACTED]  
AGE: [REDACTED]  
ADDRESS: [REDACTED]

OCCUPATION/EMPLOYER: Roustabout/Atlantic Pacific Marine Corp.  
INJURY: Head laceration and bruised legs

(13) NAME: [REDACTED]  
AGE: [REDACTED]  
ADDRESS: [REDACTED]

OCCUPATION/EMPLOYER: Crane operator/Atlantic Pacific Marine Corp.  
INJURY: Caustic burns

(14) NAME: [REDACTED]  
AGE: [REDACTED]  
ADDRESS: [REDACTED]

OCCUPATION/EMPLOYER: Derrickman/Atlantic Pacific Marine Corp.  
INJURY: Multiple bruises

(15) NAME: [REDACTED]  
AGE: [REDACTED]  
ADDRESS: [REDACTED]

OCCUPATION/EMPLOYER: Roughneck/Atlantic Pacific Marine Corp.  
INJURY: Head laceration and bruised arm

(16) NAME: [REDACTED]  
AGE: [REDACTED]  
ADDRESS: [REDACTED]

OCCUPATION/EMPLOYER: Driller/Atlantic Pacific Marine Corp.  
INJURY: Lacerated hand

(17) NAME: [REDACTED]  
AGE: [REDACTED]  
ADDRESS: [REDACTED]

OCCUPATION/EMPLOYER: Driller/Atlantic Pacific Marine Corp.  
INJURY: Separated shoulder and head laceration

(18) NAME: [REDACTED]  
AGE: [REDACTED]  
ADDRESS: [REDACTED]

OCCUPATION/EMPLOYER: Toolpusher/Atlantic Pacific Marine Corp.  
INJURY: Bruised back, lacerated foot and head

#### 4. WEATHER DATA:

The weather at the time, date and location of the casualty was as follows:

WIND DIRECTION:	ESE
WIND FORCE:	12-18 Knots
AIR TEMPERATURE:	79° F.
SEA WATER TEMPERATURE:	77° F.
BAROMETER:	28.89
CURRENT:	1.8 Knots
SEA HEIGHT:	3-5 Feet
SEA DIRECTION:	ESE
VISIBILITY:	8 Miles
CLOUDS:	Overcast

#### 5. DESCRIPTION OF RANGER I:

##### a. General:

The RANGER I was designed by the Bethlehem Steel Corporation of Beaumont, Tex. as a self-propelled mobile workover platform. It was constructed in 1968 and was identified during construction as Bethlehem hull number 4841. In current terminology, the RANGER I is identified as a self-elevating mobile offshore drilling unit. It was a small typically designed jack up rig consisting of an upper hull, support mat and three cylindrical legs. (See Figures 1 through 3)

##### b. Upper Hull:

The upper hull was a steel barge-like structure that was 120 feet long, 84 feet wide and 16 feet deep. The hull was divided into 14 ballast tanks, two fuel oil tanks, one potable water tank and a pump room. Three jack houses were located on the main deck, two near the forward end on the port and starboard sides, and one on the centerline aft at the stern. Each jack house was over a structural tube that was built into the upper hull to receive a cylindrical leg. Inside each of these houses was a jacking unit used to engage the leg so that the upper hull or mat could be raised or lowered. The jacking unit consisted of a moveable yoke that contained four square 6½ X 6½ inch high strength steel pins 23 inches long. These pins were actuated by hydraulic cylinders to engage and disengage the pin holes in the legs. There was another set of pins that were located below the moveable yoke. These were called fixed pins because they were in a housing that was welded to the main deck. The fixed pins were used to engage the legs and hold the upper hull while the moveable yoke was positioned to vertically move the upper hull or mat. The support legs extended through an opening in the top of each of the houses. When the upper hull and mat were not being raised or lowered, aluminum wedges were placed between the leg and the periphery of the opening in the top of each of the houses. The wedges reduced the horizontal movement of the legs within the tube in the upper hull.

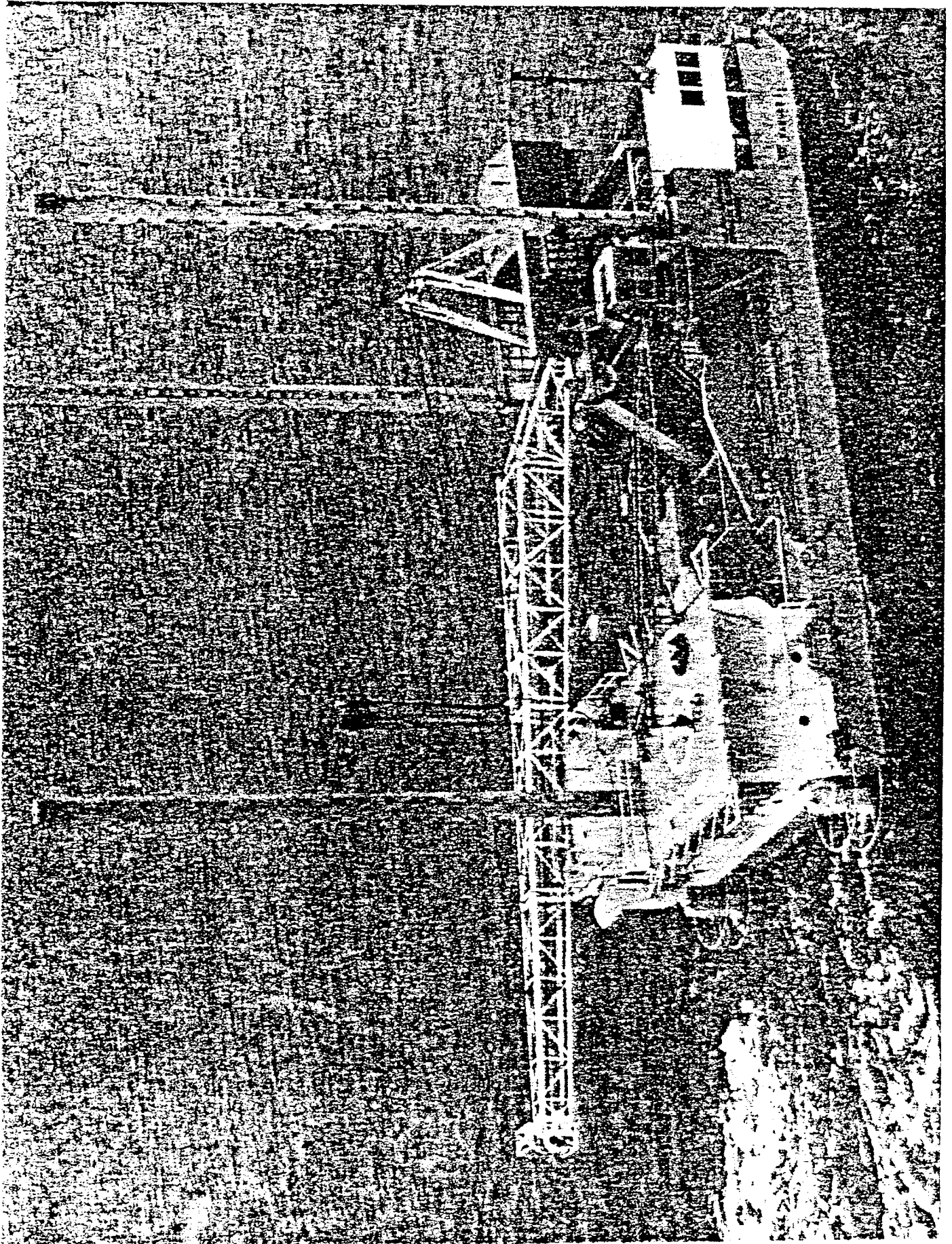

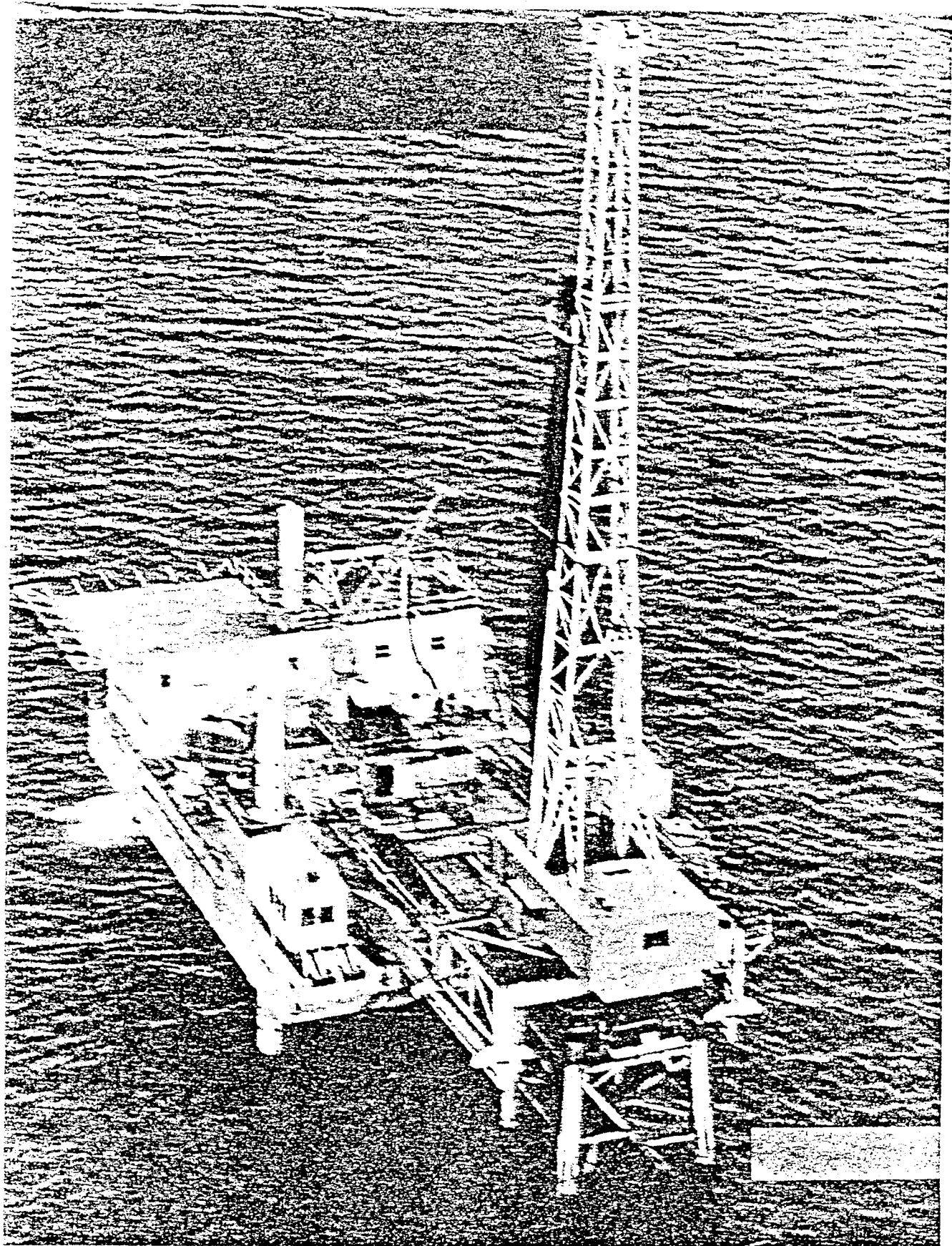

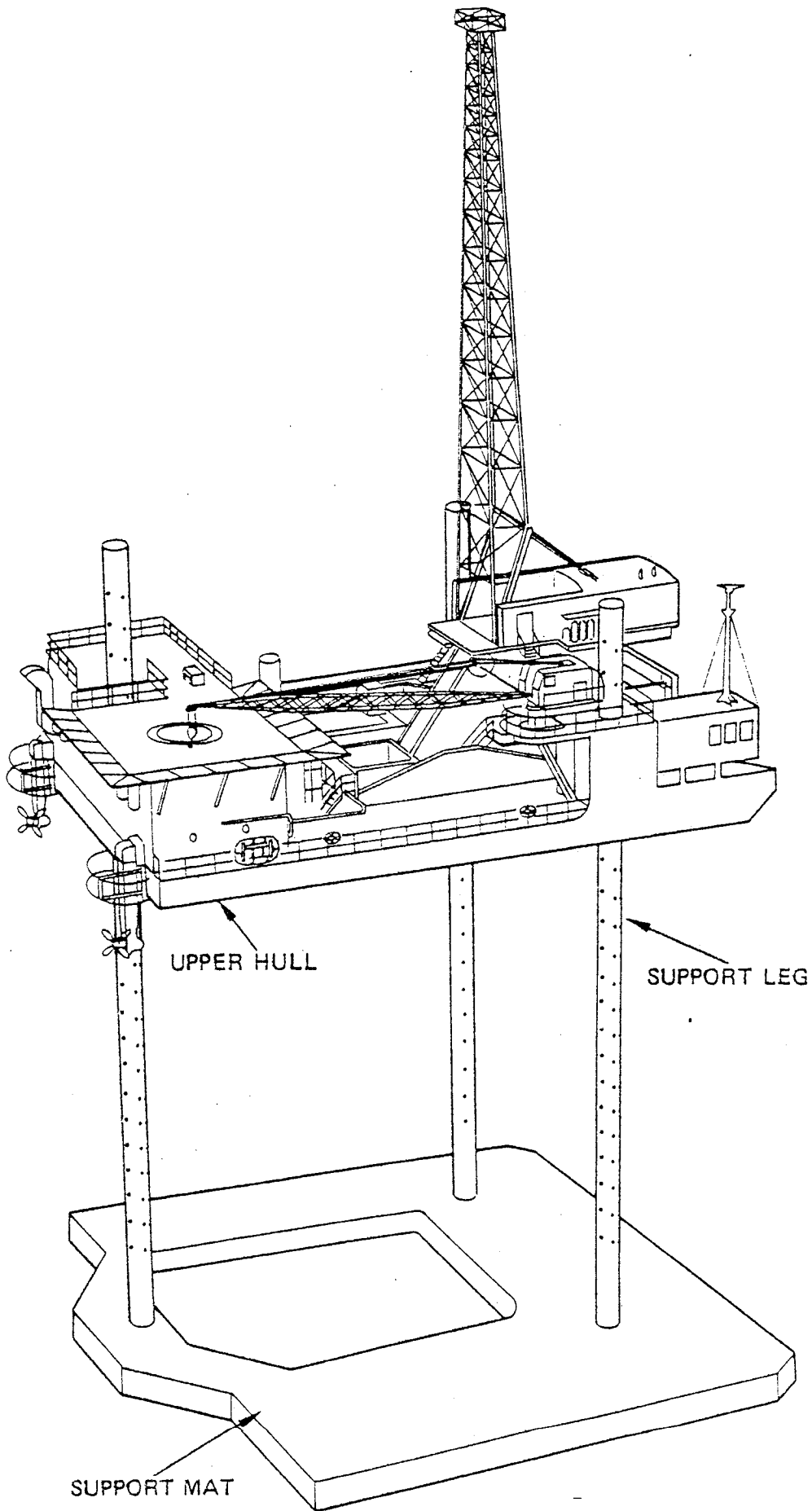

c. Support Mat:

The support mat was also a steel barge-like structure. It was 110 feet long, 84 feet wide and 8 feet deep with a large open section called a moon pool in the center. It was divided into six ballast tanks and had a scour skirt 2 feet deep attached to the outer and inner perimeters on its bottom.

d. Support Legs:

There were three identical support legs that were 4 feet in diameter and 125 feet long. The legs varied in thickness from  $\frac{1}{2}$  to  $1\frac{1}{2}$  inches and were constructed of ASTM A36 steel. These cylindrical legs were connected to the upper hull by the hydraulic jacking units. The lower end of each leg was an integral part of the support mat and was permanently welded in place. Rings of four pin holes spaced 90 degrees apart were cut into the legs at 4 foot intervals. The holes were  $7\frac{1}{2}$  inches high by 10 inches wide with  $\frac{1}{2}$  inch drill holes to relieve stress concentrations at the corners. Steel reinforcing plates to enlarge the pin bearing surface were welded inside the cylindrical legs at the top and bottom of each hole.

e. Rig:

There were two longitudinally moveable skid beams which could be extended over the forward end on the main deck of the upper hull. At the forward end of the skid beams was a carriage and skid unit that could be moved transversely. The drilling rig was mounted on the skid unit and was rated to handle 16,000 feet of 2-7/8 inch drill pipe or 9,000 feet of 4 $\frac{1}{2}$  inch drill pipe.

f. Crew Quarters:

Sleeping quarters for 30 persons, a galley and an office were located on the second deck of the deck house at the stern.

g. Pilot House:

The jacking system controls, propulsion controls, radar and fathometer were located forward on the starboard side in an elevated pilot house.

h. Heliport:

There was a 30 by 30 foot heliport aft on top of the deck house on the starboard side.

i. Machinery Space:

The propulsion and auxiliary machinery was located in the after deck house on the main deck of the upper hull under the living quarters. The machinery included two mud pumps, two Hallibuton units, two 300 KW generators, a switchboard, two diesel engines for the propulsion system and other auxiliary support equipment.



j. Propulsion System:

The propulsion system consisted of two 500 horsepower Murray & Tregurtha Harbormaster right angle drive 360 degree revolving units located at the after end of the upper hull. Each was powered by a Caterpillar Model D379B-TA diesel engine mounted inside the machinery space. The system was able to propel the unit at 2 knots headway without assistance.

k. Main Deck:

In addition to the rig, after deck house, jack houses and pilot house control room, the pipe racks, mud pit, bulk mud "p" tank and crane were located on the main deck.

l. Operating capabilities:

The RANGER I was capable of operating in 70 feet of water in areas such as the Gulf of Mexico with poor low bearing capability soil conditions. It was not designed to withstand hurricane wind and wave forces while on location.

m. Classification:

The American Bureau of Shipping (ABS) classed the RANGER I as a Maltese Cross A1 Drilling Platform for the hull and a Maltese Cross AMS for the propulsion machinery. Also, ABS issued a provisional load line certificate on 22 April 1979 that was valid until 22 September 1979.

6. SHIPYARD PERIOD PRIOR TO CASUALTY:

a. Entering Shipyard:

On 12 February the RANGER I entered Alabama Drydock and Shipbuilding Co. (ADDSCO) for an extended yard period to make repairs, alterations and equipment renewals. Plans were to complete the American Bureau of Shipping surveys and inspection to remain in class and also to undergo Coast Guard inspection for certification.

b. Hull and Mat Repairs:

Extensive structural repairs were made to the upper hull and mat. Repairs to the upper hull included renewal of deteriorated shell plating and internals in 12 ballast tanks, sounding pipes in fuel tanks, deck drains, damaged sections of bulwark, guard rails and sacrificial anodes. Also minor repairs were made to make the jackhouses and tank manholes watertight. The safety net for the heliport was also repaired. The scour skirt and sacrificial anodes on the mat were renewed.

c. Support Leg Repairs:

The extent of support leg repairs was determined from an inspection made at Fourchon, La. on 25 September 1978 for APMC. The inspection was made by representatives from Bethlehem Steel Corporation and ABS. The repairs included renewal of the forward two legs above the 28 foot level and renewal of the stern leg between the 28 and 52 foot levels and between the 64 and 80 foot levels.

d. Alterations:

The second deck of the deck house was extended 4 feet to port to increase the size of the galley. Under deck support was installed in number 5 starboard ballast tank for a new mud pump and the size of the vent piping was increased on the ballast and potable water tanks. Inverted ballast check closing devices were also added to all the vents on these tanks. Number 3 port and starboard ballast tanks were converted to fuel oil tanks and the size of the ballast piping was increased. New draw works and the substructure were installed. A cold start air compressor was installed, the switchboard, electrical power and lighting circuits modified and a telephone system was installed.

e. Equipment Renewal:

The equipment renewals included the rotary table, mud tanks, shale shaker, mud mixing pump and motor, surge tank, two cementing units, two air compressors and two larger auxiliary diesel generator units.

f. ABS Surveys and Inspection:

During the shipyard period, the unit was examined by two ABS surveyors for the biennial drydocking survey, annual classification and load line surveys and the second special periodical survey. The drydock survey included examination of the outside shell plating of the upper hull and mat, support legs, sea chest, sea valves, overboard discharges and propellers. The annual survey included examination of the watertight closures, ventilators, manholes, guard rails, main and auxiliary machinery, windlass, steering system and fire extinguishing apparatus. The load line survey included examination of the unit to verify the location of the load line marks and ensure that alterations did not affect the assigned load line. The second special periodical survey included an examination of the tanks in the upper hull and mat, watertight bulkheads, machinery room, pump room, support legs, jack houses and jacking unit, foundations for the skid unit, crane and machinery, mud tanks, helicopter platform, anchors and anchor wire, diesel engines, air compressors and receivers, pumps, anchor windlass, electrical fixtures, generators, switchboards and motors.

g. Coast Guard Inspection:

On 13 February APMC made application for inspection of the RANGER I to the Coast Guard's Marine Safety Office in Mobile, Ala.

Although the unit was not required to be inspected, the owner chose to undergo a inspection for certification. During the shipyard period, the unit was inspected by four marine inspectors under the provisions of Subchapter I-A-Mobile Offshore Drilling Units and an amplifying Navigation and Inspection Circular No. 4-78 Inspection and Certification of existing Mobile Offshore Drilling Units. The inspection included examination of the hull structure, structural fire protection, means of escape, ventilation, accommodation spaces, railings, stability, fire extinguishing systems, lifesaving equipment, cranes, emergency alarms and instructions, controls for emergency alarms, main and auxiliary machinery and the electrical system. On 20 April, APMC advised the Marine Safety Office that there was not enough time to submit the required stability information to obtain the certificate of inspection and they withdrew the application for inspection.

7. TRANSIT FROM ADDSCO TO BLOCK 189L:

RANGER I departed ADDSCO under tow at 1030 on 24 April en route Galveston, while work crews continued job completion of minor plumbing and electrical work that remained outstanding from the recent yard period. Deteriorating weather was encountered while transiting Mobile Bay with seas mounting 8 to 10 feet. The unit was jacked up in the vicinity of Fort Morgan at 2000 to avoid the seas. At this time, the yoke and fixed pins were unable to enter the pinholes on the stern leg at three levels between the 32 and 46 foot levels. The pinholes were widened by oxyacetylene cutting the leg to accommodate the pins.

Once the seas had moderated, the unit was jacked down, however, two pins in the stern leg failed to fully retract and tore the pin-holes vertically 8-10 inches at the 52 foot level. The toolpusher was operating the jacking gear from the pilot house and was unaware of the malfunction until the crewman in the jackhouse saw the pinhole tearing. The alarm to warn of incomplete pin retraction failed to sound. Later the tool pusher completed jacking down and the RANGER I resumed transit under tow at 1430 on 25 April at 3.8 kts. Its destination was changed to Fourchon, La., in order to repair the damaged pinholes.

Upon arrival at Fourchon on 27 April, William SKINNER of ADDSCO was sent to supervise repairs. The damaged pinholes were cropped and renewed with inserts taken from leg sections removed during the recent yard period. After installation the welds were ultrasonically tested and the rig jacked over the new inserts without difficulty. The voyage to Galveston Block 189L resumed at 0600 on 2 May under tow of the tug GILL HEBERT.

At 1700 RANGER I encountered winds of 15-20 knots and 6 foot seas in the vicinity of Cat Island, La. Again, the unit was jacked up to a 12 foot air gap in 30 feet of water to avoid the seas. The voyage resumed at 1000 the following day. Six foot waves and 20 knot winds required jacking up again at 1930 in the vicinity of

Morgan City, La. While waiting for the weather to improve, [REDACTED] was relieved by [REDACTED] and [REDACTED]. Both men relieved as toolpusher to allow HALL training aboard RANGER I. [REDACTED] was a qualified toolpusher and performed tasks as such without [REDACTED] supervision. The voyage resumed at 1800 on 4 May. [REDACTED] joined the vessel via helicopter the following day as the Mitchell Energy Offshore Corp. representative.

RANGER I arrived at Block 189L at 1600 on 6 May. All ballast was discharged and tanks sounded to insure they were dry prior to arrival on site. The GILL HEBERT towed the unit within 500 feet of the drill site, released the tow lines and stood by to assist. The propulsion system of the RANGER I was used to move the remaining distance to the drill site. The final position was on an easterly heading with a 25 foot separation between the bow and well number 7. Four approaches were made due to wind and current conditions before this position was reached. The easterly heading was acceptable for mooring the supply boat and transferring materials from the unit's starboard bow. Later, the derrick was skidded forward to commence drilling well number 6 within 7 feet of the existing well.

#### 8. ACTIVITIES ON STATION:

After RANGER I was in position, the upper hull was jacked up to a 12-foot air gap and the unit preloaded. The preloading was to insure that a level attitude was maintained on the seabed while drilling. This was accomplished by adding saltwater ballast in the upper hull to exceed the maximum load on the unit during drilling. [REDACTED] was in charge of the preload. He determined that it was necessary to load 900,323 pounds of ballast and selected the ballast tanks to be used. No calculations were performed to determine the placement of the ballast. However, the effect of the ballast on list and trim was considered.

There are two sets of inclinometers in the control house, each consisting of a straight and a curved tubular bubble level. One set rested on the window sill on the fore and aft axis and the other rested on the sill on the athwartship axis of the unit. At the beginning of the preload, the inclinometers indicated a two-tenths degree port list and a one-tenth degree trim by the bow. At the conclusion of preload, the port list was reduced to one-tenth degree and the trim remained unchanged. Preloading commenced at 2130 on 6 May and was completed at 0200 on 7 May. The ballast was held for approximately 4 hours then dumped back into the sea. It took an additional hour for the unit to be jacked up to its working air gap of 32 feet.

Next, a counter weight was established in the upper hull to compensate for the derrick when raised and skidded 18 feet forward of the bow. Saltwater ballast was taken aboard in number 6 tank for this purpose. The derrick was raised at 0930 on 7 May and skidded from the port side to the centerline of the vessel. At 1230 attempts were made to skid the derrick beyond the bow, however, the port skid stuck due to debris. Efforts were made to

free the skid by clearing the debris with compressed air and applying grease to the skids. These attempts were unsuccessful because several hydraulic jacks blew their seals. Extra equipment had to be brought from Houma, La. By noon on 8 May, the derrick had been skidded to within 7 feet of the intended site, at which point another hydraulic jack blew its seal and skidding was stopped.

The derrick was lowered 60' to facilitate positioning. Wind and seas were increasing from previous days. The wind was 18 knots from the South and seas were ranging between 3 to 5 feet. At 1430 the DELTA SEAHORSE with 150 tons of cargo moored along side the starboard bow and began offloading. Included were 400 feet of 30 inch conductor pipe, a hammer, welding machines and other miscellaneous materials. Transfer continued until 0200 the next morning. Skidding the derrick was suspended on 9 May awaiting additional hydraulic jacks. Between 0800 and 0900 that morning, the inclinometers were checked and no change was observed. At noon, there was a crew change. [REDACTED] relieved [REDACTED] and [REDACTED] as toolpusher and they went ashore.

At 1500, the DELTA SEAHORSE attempted to moor its stern to the starboard bow of the RANGER I. This would allow RANGER I's crane to easily reach materials on the aft deck of the supply vessel. The master of the DELTA SEAHORSE, [REDACTED], began mooring by dropping his anchor off RANGER I's starboard bow. He paid out chain as he backed towards the unit. The wind and current were acting on the port beam setting the DELTA SEAHORSE to starboard and causing the vessel to swing on its anchor like a pendulum. [REDACTED] found it difficult to judge distance to the unit and control the supply boat against the strong cross current. The stern of the DELTA SEAHORSE struck the starboard leg of RANGER I, causing a noticeable jolt to both vessels. It was decided that the current was too strong for further attempts. The DELTA SEAHORSE returned to Galveston for more supplies. Rig hands were lowered in a basket over the side to examine the damage to the leg. They found a dish shaped indentation about 15 inches in diameter with a maximum depth of about a quarter of an inch. This damage was considered insignificant and work resumed aboard the unit. No damage was sustained by the DELTA SEAHORSE.

AT 0100 on 10 May, the derrick was raised and skidded to its drilling location. The crew rigged the derrick by pulling the rotary table, slipping the drill line and aligning and leveling the derrick. At 0430, the crew began installing conductor pipe. By noon, a 62,000 pound assembly, consisting of a section of conductor pipe, drill hammer and traveling block, had been hung from the derrick and the conductor pipe was lowered to the sea floor. Additional sections of conductor pipe were welded to this section and hammered into the bottom.

At 1330, the DELTA SEAHORSE moored to the RANGER I to off load fuel and potable water. Soundings at 0600 showed the unit only had 4116 gallons of fuel and no potable water aboard. The DELTA SEAHORSE transferred 9,350 gallons of diesel fuel and 840 barrels of potable water to the unit.

By 1500 the refusal rate of the hammer reached 666 hits per foot of pipe. At this point, hammering was secured with 215 feet of conductor pipe in place. A rough cut of the pipe was made below the drill floor and the cut portion of the pipe was removed and placed on deck with the crane. The hammer was removed from the derrick and placed in its cradle midship just aft of the forward legs.

#### 9. SHUDDER PRIOR TO COLLAPSE:

Between 1500 and 1800 on 10 May, RANGER I experienced a violent shudder. Several different sensations were experienced by those aboard. Some described the shudder as a violent shaking, while others felt they experienced a fall straight down from a couple of inches to a foot. The shudder was accompanied by a loud noise. One crew member saw a piece of drive pipe rolling 4 to 5 inches across the deck. Another saw water puddles standing on the deck with no detectable movement in the outline of the wetted area.

The location and movement of heavy weights prior to the shudder could not be determined. Although the conductor pipe hammering was complete, the hammer may have been hanging in the derrick or cradled on deck. The status of fuel and water transfers is also unknown. In any case, all work activities ceased when the shudder occurred and nearly an hour was spent trying to determine the cause.

██████████ checked each jackhouse personally. All pins were individually examined. Both he and ██████████ observed the inclinometers and found no changes in list or trim. The wedges used to reduce vibration between the top of each jackhouse and leg were also checked. The wedges in jackhouse number 2 appeared to have slipped down a small distance in the space between the leg and the jack house opening. Speculation of possible causes for the shudder included shifting of wedges, settling of the unit or the DELTA SEAHORSE swinging on anchor and striking a support leg. However, the cause was not determined and work resumed. No reports were made to advise the APMC management of the incident and assistance was not requested.

Work continued aboard the unit without incident until the time of the collapse. At 1900, transfer of general cargo from the DELTA SEAHORSE began using RANGER I's crane. The cargo included pallets of chemicals, a blowout preventer and a P-tank. At 2200 the relief crew was roused for their evening meal. Cargo transfer had stopped due to a mechanical problem with the crane. Maintenance and repair work was underway in machinery spaces and on deck, however, no heavy weights were being shifted. The derrick and crane were both inactive and the transfer of bulk liquid had been completed.

#### 10. COLLAPSE AND SINKING:

About 2230, the unit collapsed into the sea. The stern fell first going almost straight down with a slight rotation towards

the port quarter. The DELTA SEAHORSE, still moored to the starboard bow, was struck on its starboard quarter during the fall. The upper hull of the unit plunged into the water and immediately flooded the after section. There was a momentary blockage of the port door entering the galley and also the doors entering the machinery space. Within seconds flooding was sufficient to stop the generators and extinguish the lights. The bow legs supported the upper hull for an instant and then they too gave way. The upper hull rotated 170° to starboard and drifted about ¼ mile westerly of the original position. The DELTA SEAHORSE remained anchored and moored, however, it drifted to the port bow of the unit. Within 20 minutes, the DELTA SEAHORSE's mooring lines were cut to avoid it being dragged under. The upper hull listed to port and continued flooding throughout the next day and finally sank late that night or early the next morning.

The support mat had sufficient buoyancy to float with 21 feet of its bow above the water while the stern rested on the bottom. The mat formed about a 40° angle with the bottom as it worked in the seaway. The port bow leg remained perpendicular to the mat and had separated from the upper hull at the 68-foot level. The starboard bow leg was perpendicular to the mat to the 38-foot level with the remaining portion hairpinned back on itself towards the stern. The mat remained in this condition until salvaged.

#### 11. ABANDONMENT AND RESCUE:

##### a. Abandonment:

When RANGER I collapsed most of those aboard were in the living quarters. Thirteen men were in the galley preparing for a crew change and three were in the office and berthing spaces. Six were working on deck and five were in the machinery spaces. The exact location of three others could not be determined although they were seen minutes before the casualty. The suddenness of the collapse precluded any warning or sounding of alarms. Those in the galley area experienced a rapid fall, a jolt as the upper hull struck the water followed by instantaneous flooding 2 to 3 feet deep. Several men attempted to exit by the port galley door which was initially blocked. Others escaped through galley windows in the forward and after bulkheads. The port galley door was finally opened and several escaped. The central staircase and exit door between the living and machinery spaces was blocked by debris caused by the derrick falling on the deck house. Some returned to their berthing areas to obtain life preservers while others fled from the galley with seat cushions for flotation. Once outside, three abandonment patterns developed. One group climbed to the heliport platform to await rescue. Others swam to the DELTA SEAHORSE which was off the port bow of the RANGER I. Some jumped overboard to clear the upper hull before it sank. The survivors used an assortment of flotation equipment from the unit and the DELTA SEAHORSE. Included were ring buoys with float lights, a personnel transfer basket, cushions from the galley, rafts and life preservers.

b. Rescue:

The DELTA SEAHORSE was standing by for further cargo transfer when the unit collapsed. The loud noise roused Captain [REDACTED] from his quarters. He ran to the bridge and assumed the watch from the mate, [REDACTED]. A short time later [REDACTED] sent a MAYDAY. The vessel's crew, aided by two righands aboard for cargo transfer, threw lifesaving equipment to those being swept away by the current and snatched four men from the sea as they floated close by.

Initially [REDACTED] decided against getting underway because the current was carrying survivors near the vessel's propellers. Later he reasoned that others might be trapped aboard the upper hull and in need of help. He decided to remain at anchor to mark the location with the lights of the DELTA SEAHORSE so that other vessels could have a visible reference.

The MISS ANGELA and FAIRWINDS were towing the POOLE RIG 50 about ½ mile away from RANGER I when it collapsed. The MISS ANGELA immediately released its tow and rushed to the RANGER I as directed by the DELTA SEAHORSE. Upon arrival at 2245 the crew of the MISS ANGELA began recovering survivors from the heliport and crane boom. Some of the survivors entered the water and swam a short distance to the MISS ANGELA because the wreckage and rough seas prevented the vessel from getting to them. When [REDACTED] a non-swimmer, entered the water he nearly drowned. [REDACTED], a deckhand on the MISS ANGELA, jumped overboard and rescued [REDACTED]. After all the survivors from the upper hull were taken aboard the MISS ANGELA the master continued to search for others. In all, fourteen men were saved by the MISS ANGELA.

The FAIRWINDS remained with its tow but provided the communications link with the Coast Guard and assisted the rescue by co-ordinating the movements of several vessels.

Upon notification of the MAYDAY, Coast Guard helicopters were sent from Air Station, Houston. Helicopters 1441 and 1422 arrived at 2327 and 2345 respectively. They recovered four men from the water and evacuated five seriously injured from the DELTA SEAHORSE and MISS ANGELA to Galveston. Other vessels and aircraft joined the search, however, no additional survivors were found.

The first attempt to dive on the upper hull in search of those possibly trapped began at 0244 11 May. Four divers were airlifted by Coast Guard helicopter from the SANDOKAN to the CALYPSO. This attempt was aborted due to upper hull instability and sea conditions. Later that day, the CGC BLACKTHORN arrived on scene for diving support. The first divers entered the water at 1435 to begin their search. Weather and sea conditions deteriorated hampering both the surface and diving searches. The surface search was suspended on the evening of 12 May and the diving search was suspended at 1730 the following day. The remains of seven men were later recovered and identified. Mr.



██████████, who is still missing, was last seen in the galley by members of the hammer crew minutes prior to the collapse.

## 12. DELTA SEAHORSE:

The DELTA SEAHORSE is a 150 foot freight vessel engaged in oil exploitation. It is designed with the superstructure forward of midship thus providing an open cargo deck area 110 feet by 25 feet. Coast Guard inspection of the vessel was completed on 2 May 1979 in Houma, La., and a Certificate of Inspection was issued. The certificate required a licensed master, licensed mate and two able-bodied seamen aboard the vessel when operated not more than 16 hours in any 24 hour period. Upon completion of the inspection, the DELTA SEAHORSE departed for Galveston arriving at 2130 on 4 May. The next several days were spent loading cargo and awaiting notice that RANGER I was ready to receive supplies.

The first cargo was delivered on 9 May. At 1300 on 10 May, the DELTA SEAHORSE moored to the unit for the last time before the collapse. A single line was used to moor the stern to the starboard bow of RANGER I while a bow anchor held the ship perpendicular to the side of the unit. Horizontal separation was about 40 feet. The mooring line had one broken strand. Chaffing gear was rigged and a secondary line was passed with a greater catenary.

After mooring, cargo was transferred from the DELTA SEAHORSE to the RANGER I. Bulk liquid transfer was completed prior to 1930 when ██████████ relieved ██████████ of the watch. Just prior to the collapse, ██████████ and two roustabouts from RANGER I were in the galley awaiting crane repairs so the transfer of deck cargo could continue. ██████████ and the rest of the crew were resting below decks. When the collapse occurred, ██████████ assumed the watch. Others surveyed the vessel for damage, recovered some survivors and threw lifesaving equipment to others. Recovery of survivors was difficult because of the rough seas and the 3 foot freeboard of the DELTA SEAHORSE. Lighting was limited to a single searchlight operated from the bridge and the vessels deck lights. An attempt was made to launch the 14-foot aluminum boat. ██████████ decided that launching the boat was too risky because it did not have a motor and was not suitable for the sea conditions. The use of the line throwing gun was also dismissed for fear of causing further injuries to those survivors still on the unit. The DELTA SEAHORSE sustained minor hull damage. The damage included a ripped and bent starboard quarter and set in plating at the center of the stern. The deck was upset at both locations. Communications were good with nearby vessels via VHF, Channel 16. However, other transmissions during peak traffic periods interfered with the DELTA SEAHORSE's radio traffic.

The DELTA SEAHORSE remained close to the upper hull throughout the night. Early in the morning on 11 May, the Coast Guard planned to airlift divers to the vessel. This plan was changed in favor of another vessel more suitable as a diving platform. The DELTA SEAHORSE departed at 0730 when it received permission

from the Coast Guard to return to Galveston and embark a diving team. However, the divers embarked on the CGC BLACKTHORN to avoid the delay of offloading the deck cargo from the DELTA SEAHORSE. At this time, a partial crew change occurred. The crew at the time of the collapse consisted of [REDACTED] who had a Coast Guard license as Master of Steam and Motor Vessels less than 300 gross tons, [REDACTED] who had a license to Operate and Navigate Passenger Carrying Vessels of less than 100 gross tons and a Merchant Mariner's Document endorsed as Able-Bodied Seaman and Mr. [REDACTED], Mr. [REDACTED] and Mr. [REDACTED] who had Merchant Mariner's Documents endorsed as Ordinary Seamen.

### 13. WRECK REMOVAL:

Wreck removal was influenced by concern for the preservation of evidence, safety of well number 7 and expeditious resumption of mineral exploitation on the site.

The J. RAY McDERMOTT BARGE NUMBER 16 arrived on 17 May and was the primary vessel assigned to remove the mat and legs. The portions of the forward two legs that remained attached to the mat were removed by making circumferential cuts away from the fracture faces to avoid damage. The cut sections were brought aboard the barge, photographed and measured. The fracture faces were preserved with oil to prevent corrosion and wrapped with heavy plastic. The aft leg was recovered from the sea floor on 19 May. It was completely detached with the mat end entering the seabed inside the moon pool. The leg was bent at the 44-foot level with the upper hull end entering the seabed directly astern of the mat. This section was brought aboard the barge in one piece, examined and preserved. The legs were later cut into more manageable sections as agreed to by metallurgists employed by the Coast Guard and parties' in interest.

On 22 May, the CAILLOU SEAHORSE transported the legs to the West India Shipping Company (WISCO) Yard in Houston for examination. Once the legs were recovered, attention was shifted to the mat. It was partially afloat with the bow close to well number 7. The mat posed a threat of damaging the well and causing a blowout. The ANNE T. ORGERON had a tow line with a constant strain on the bow to keep it away from the well. Steps were taken to restore the water tightness of the mat, attach lifting eyes and pump air into its flooded compartments. At 0600 on 22 May, it was refloated. (See figure 4) The ANNE T. ORGERON took the mat in tow on 24 May and transferred the tow to the STAG, a smaller harbor tug. The tow arrived at the Houston Industrial Terminal on 25 May. After inspection of the mat, the stern leg connection to the mat was preserved for subsequent metallurgical and fracture analysis.

At 0800 on 19 June, the barge, OCEAN SALVAGER, the tug, RIGGER II, both owned by Offshore Incorporated of Louisiana, arrived to remove the remaining wreckage and debris so that drilling could resume. Nearly 2 months of work followed. Initially, the heavier items remaining on the upper hull were either lifted to the surface or laid on the seafloor. Damaged tanks and compart-

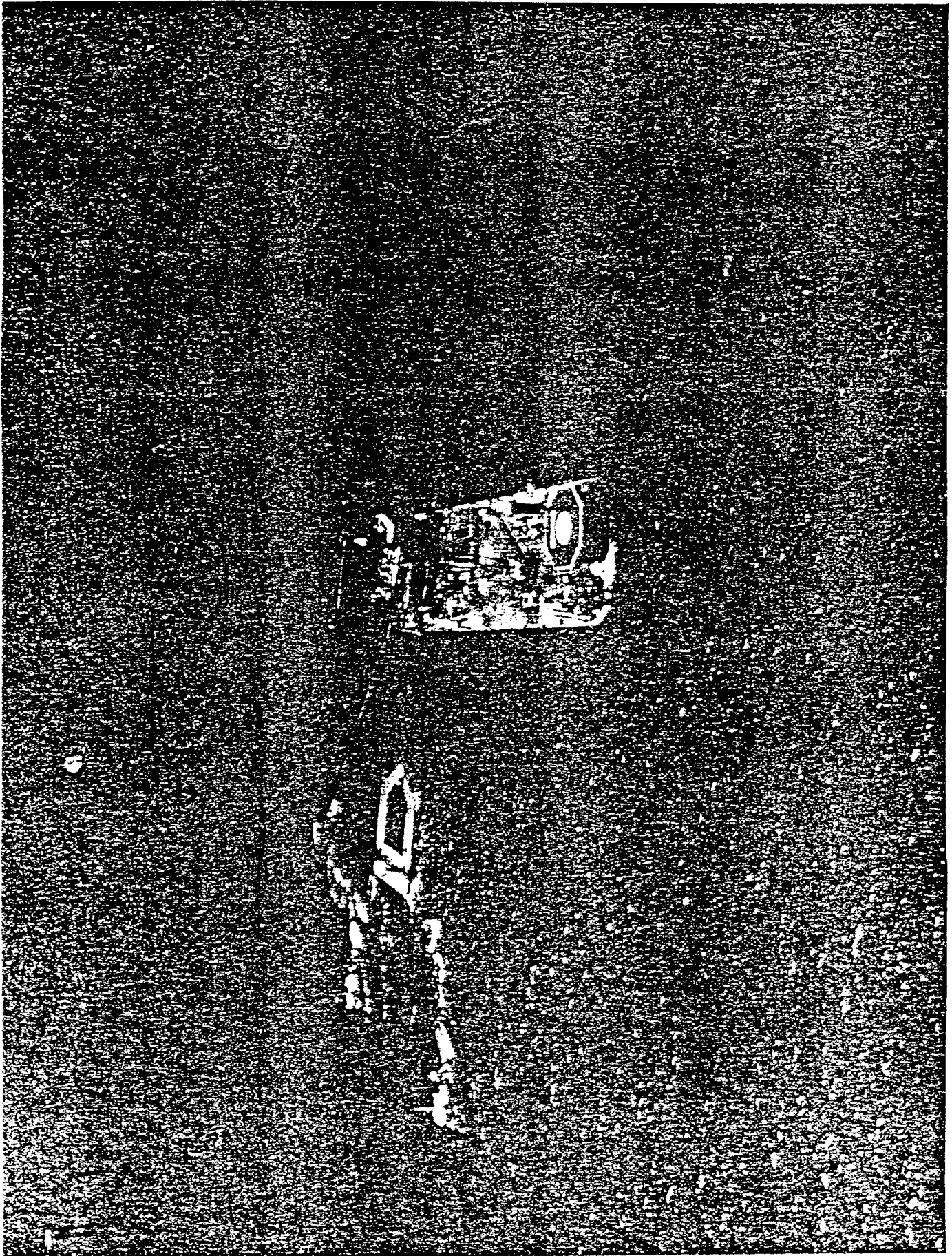

ments were patched to hold air and facilitate raising. Airhose connections were fabricated and installed for air injection.

On 15 July, the RIPTIDE II, owned by Tidex, Inc. arrived to assist in recovering debris. The upper hull was raised on 14 August, towed to Pelican Island and beached. Heavy currents and high seas hampered diving operations and delayed wreckage removal. The remaining debris was removed and a site survey using a side scan sonar and magnetometer was completed on 6 September by the PROTON. RANGER I's upper hull was drydocked in Galveston, debris removed and major deficiencies repaired. The upper hull was towed from Galveston on 9 September for conversion to a salvage vessel. (See figure 5)

#### 14. GALVESTON BLOCK 189:

Galveston Block 189 is in the Gulf of Mexico on the continental shelf about 12 miles southeast of Galveston Island. Block 189L is in its southeast quadrant with a water depth of 60 feet. The block has been leased for drilling since 1947. The designated operators were Bentex Oil in 1947, Pure Oil in 1954, McWood in 1964, Zapata Norness in 1968, C & K Petroleum in 1969, and Mitchell Energy Offshore in 1978. Eight wells were drilled prior to May 1979 and were designated A-1, A-2, A-3, 2, 3, 4, 5 and 7. The last well was drilled for the Mitchell Energy Offshore Corp. by the TELEDYNE 16 and was completed in February 1979. The TELEDYNE 16 is mat supported and similar to the RANGER I in configuration but is larger and heavier.

Previous studies and recent surveys confirmed that the sea floor soils are overconsolidated Pleistocene clays. The soil layering is generally horizontal. Although some faults, erosional channels and buried erosional channels exist around the collapse site, none existed at the site itself. No gas pockets or craters are in the area. The undrained shear strength of the soils at the site varied from 750 pounds per square foot at the sea floor to 1000 pounds per square foot at 50 feet penetration. After the casualty, bottom surveys and additional studies were made using side scan sonar, divers and seismic sub-bottom profiling. A depression was located 75 to 175 feet to the northwest of well number 6. It was 100 to 120 feet long, 30 to 40 feet wide and about 10 feet deep. The mat was found with the stern resting on the bottom of this depression at about a 40° angle. The stern penetrated about 10 feet below the seafloor.

#### 15. SUPERVISORY POSITIONS:

##### a. Drilling Foreman:

FERGUSON was the drilling foreman, commonly referred to as the company man. As the field representative of the lessee, Mitchell Energy Offshore, he was responsible to supervise the drilling of the well. His duties were traditional in nature and not specified in writing. He checked the work of others, such as the mud engineers and the toolpusher, and reported the status of the well to the lessee on a daily basis. FERGUSON had 44 years

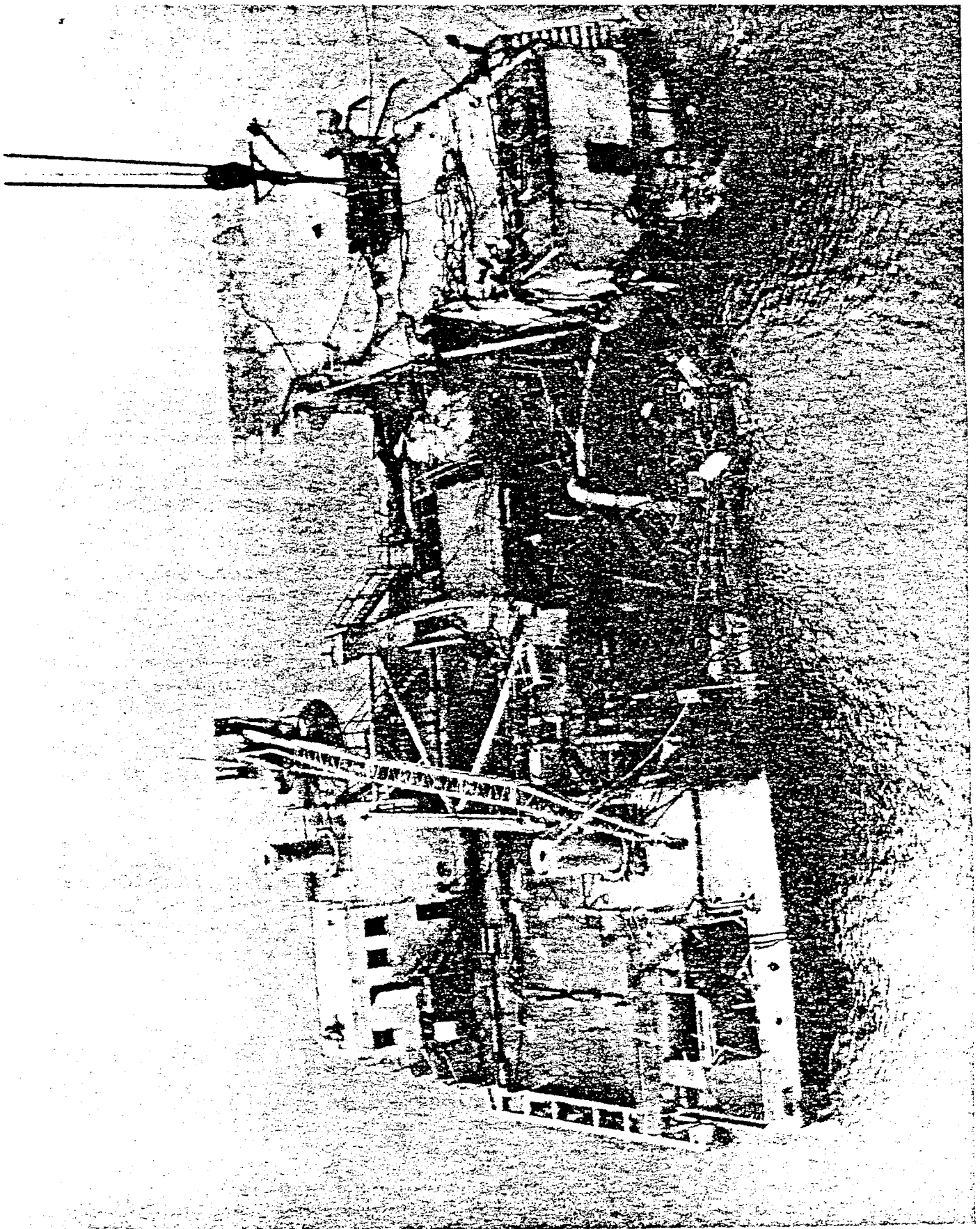

FIGURE 5

experience in the oil field, including 27 years of supervisory experience and 5 years on self-elevating mobile drilling units.

b. Toolpusher:

██████████, the toolpusher, was in charge of RANGER I and the persons aboard. His duties consisted of maintaining a count of those on board, supervising the drilling crews, training new personnel, conducting safety drills and meetings and ensuring that lifesaving equipment was periodically inspected. ██████████ had 18 years experience including 5 years as a roughneck, 8 years as a driller and 5 years as a toolpusher. He spent 9 years on mobile drilling units similar to RANGER I and was employed by APMC for the past 5 years. ██████████ attended several industry oriented schools on drilling procedures and firefighting.

16. SAFETY:

a. Personnel Indoctrination:

APMC established a procedure in their Operations Manual for indoctrinating new personnel in safety aspects of offshore drilling. Indoctrination ashore and on the unit emphasized the importance of utilizing protective equipment such as steel-toe shoes and safety helmets. It also required the employee to expeditiously report accidents and participate in training and drills. The individual was warned against possession of contraband, such as alcohol, drugs and firearms and was required to complete a form acknowledging the above information. Self indoctrination by reading the Safety Manual was encouraged.

The Safety Manual is a pocket-sized publication issued to each employee. Chapters 1 and 2 include the general requirements covered in the indoctrination. The remaining chapters contain a description of the safety observer program, safety inspection requirements of regulatory bodies, procedures in case of injury, check off lists for various unit evolutions, tables which apply to rigging safety and a glossary of drilling terminology. New APMC employees received indoctrination aboard RANGER I consisting of a general work site familiarization noting the location of safety equipment. The toolpusher, however, was unaware of the equipment cited or spaces visited during an indoctrination. There was no established program for the indoctrination. In addition, there was no indoctrination for employees of service companies. There were 15 service company personnel aboard when RANGER I collapsed.

b. Fire and Abandon Ship Procedures:

APMC designed a "Station Bill and General Quarters" to be followed during fire and abandon ship emergencies. This document established the emergency signal for each incident and identified by job title the duties of individuals. The emergency bill included both APMC and service company employees. This emergency bill was not posted at the time RANGER I collapsed. The bulletin board on which it was normally posted had not been mounted after

the recent yard period. One individual who had begun his offshore employment 2 days prior to the collapse received no safety indoctrination or emergency bill assignment.

Coast Guard regulations require emergency drills to be conducted at least once each month. The purpose of the drill is to train all persons aboard the unit in the duties prescribed by the emergency bill. The toolpusher had delegated the responsibility to indoctrinate new drill crew personnel in abandon ship and fire emergency procedures to the driller. The driller delayed this indoctrination believing the best opportunity to present it was during a drill. The new personnel which arrived the day prior to the collapse did not receive any training in emergency drills. No drills were conducted aboard RANGER I from the time it departed the ADDSCO yard on 24 April until the time of its collapse. The last fire and abandon ship drills were conducted 14 January and 5 February, respectively. In addition, the toolpusher and others did not know the difference between the fire and the abandon ship alarms.

c. Equipment:

Coast Guard regulations for Artificial Islands and Fixed Structures on the Outer Continental Shelf, 33 CFR 140-147, established requirements for life saving appliances such as life preservers and ring buoys. For some equipment, such as life floats, the quantity or capacity is directly related to the number of people that will be aboard the unit. RANGER I had on board four lighted ring buoys, two inflatable liferafts, three lifefloats and an unknown quantity of life preservers and work vests. The life preservers and work vests were located in the berthing compartments and near the heliport. The toolpusher did not know how many life preservers were aboard or how many were required. Federal regulations require one life preserver for each person. The toolpusher did not know how many people were aboard at the time of the collapse. Personnel coming aboard checked in with the cook, then prior to making his morning report to the home office, the toolpusher obtained a count from the cook. There was no written procedure to account for or inspect safety equipment. [REDACTED] stated that a monthly inventory including a material inspection of life preservers was held and float lights were inspected weekly by the electrician. Also he stated that the results were reported at the weekly safety meetings and logged. The logs from May 1978 to May 1979, however, show no record of safety equipment inventories or inspection results.

d. Training:

It was APMC's policy to conduct weekly training meetings to upgrade the knowledge of their personnel and correct hazardous equipment deficiencies. The results of the meetings were recorded on an International Association of Drilling Contractors (IADC) form. This form included general information such as the name of the unit, the date of the training and the personnel in attendance. It listed the items discussed and hazards corrected. It provided sections to list drills conducted and blocks for

review signatures. For the period from May 1978 through May 1979, these forms show that about 100 safety meetings were conducted. Drilling and operating safety procedures were discussed on 70 occasions while abandon ship and fire procedures were discussed 4 and 11 times, respectively.

e. Standby Boat:

The standby boat was provided by Mitchell Energy Offshore Corp., the lessee. The company's policy was to employ a standby boat to assist a unit not having a self-propelled lifeboat or survival capsule. The standby boat remained in the vicinity of the unit while on site, unless a work boat or crew boat was tied up to the unit. The CALYPSO was the standby boat. It was supporting a surveying team about 10 miles from RANGER I at the time of the collapse.

17. METALLURGICAL AND FRACTURE ANALYSIS:

a. General:

The board employed Dr. [REDACTED] of EMTEC Corporation, Norman, Ok. and Dr. [REDACTED] of the University of Kansas to provide engineering consulting services. Initially, these services included a macroscopic examination of the three support legs and mat as soon as these parts of the unit were recovered. This was followed by a non-destructive examination of the leg connections to the mat. Subsequently, there was an extensive examination of the stern leg which included a laboratory macroscopic examination, chemical analysis, mechanical testing, metallograph and hardness survey, scanning and transmission electron microscopy and fracture mechanics testing and analysis.

b. Wreckage examination:

The stern support leg was fractured near its connection to the mat. This catastrophic fracture began on the port side of the leg at the upper toe of a continuous fillet weld that attached a stiffener ring to the stern leg. The fracture extended completely around the leg and was inclined upward toward the starboard side. A stub of the stern leg remained attached to the mat. It varied in height from 4 inches on the port to 15 inches on the starboard side. The fractured surfaces showed matted chevrons that pointed to the port side of the leg. The mat deck plating was pushed in on the port side and the barnacles in way of this deformation were scraped off. The lower end of the fractured leg mated with the deformation in deck plating when it was inclined from the vertical about 9 to 11 degrees to starboard. The upper end of this leg was sheared at the 90 foot level. The starboard leg was bent at the 38 foot level and it remained attached to the mat. The upper end was sheared at the 90 foot level. The port leg was broken off at the 68 foot level. (See figure 6)

c. Non-destructive examination:

Magnetic particle and ultrasonic examinations showed cracks in



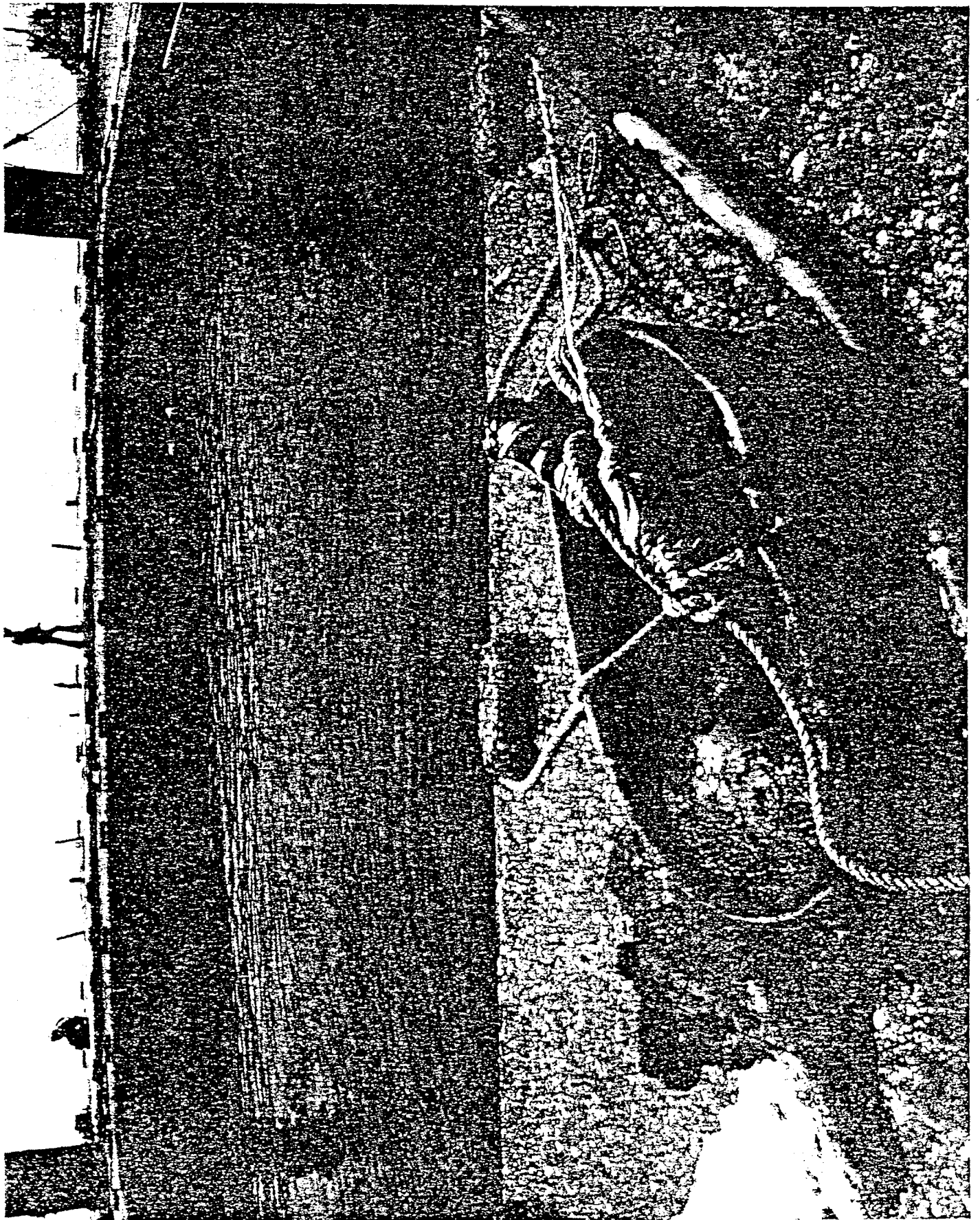

the stern leg stub and the forward leg connections to the mat. The forward side of the stern leg was over a longitudinal vertical bulkhead in the mat and two 3 inch cracks were found on the forward side of the leg stub. One of these cracks was at the toe of a fillet weld attaching the stiffener ring to the leg and the other was at the toe of the fillet weld attaching the mat deck plating to the stiffener ring. There were two 6 inch cracks on the starboard side of the stub. This area of the stern leg was over a transverse vertical bulkhead in the mat. There were three fractures on the port side of the leg. Two were at the upper toe of the fillet weld attaching the mat deck plating to the stiffener ring and the third was at the bottom toe of the weld.

f. Mechanical testing:

The mechanical testing included 8 tensile tests, 58 impact tests of which 22 tests were of the steel near the catastrophic fracture and a full section tensile test of a fatigue crack in the stern leg. The standard 0.505 inch diameter tensile test specimens were cut from the 12, 20, 39 and 88 foot levels of the stern leg. The axis of each specimen was parallel to the axis of the stern leg and transverse to the final rolling direction of the plates used to fabricate the leg. Test results showed that the average yield strength was 38,000 lbs - force per square inch (ksi), average tensile strength was 70 ksi, average elongation in 2 inches was 32 percent and the average reduction in area was 60 percent. These test results showed that the steel met the mechanical requirements of ASTM A-36. The upper and lower shelf fracture energies and transition temperature of the steel in the stern leg was determined using the standard Charpy V-notch (CVN) impact test specimens. The impact values in foot pounds (ft-lbs) increased from 4.5 at 0° F, to 20 at 50° F and 33 at 80° F. The percent shear increased from 15 at 0° F, to 33 at 50° F and 51 at 80° F. The lateral expansion in inches increased from 0.004 at 0° F, to 0.022 at 50° F and 0.033 at 80° F. The 15 ft-lbs transition temperature for the steel in the stern leg was 40° F, the 50 percent shear transition temperature was 80° F.

g. Metallography and hardness survey:

A vertical section was cut from the aft stern leg connection to the mat. The section contained the fillet weld attaching the stiffener ring to the leg and the fillet weld attaching the mat deck plating to the forward side of the stiffener ring. Metallographic mounts were made of both fillet weld joints. Examination of the fillet weld attaching the stiffener ring to the leg showed a small horizontal crack at the upper toe of the fillet weld. The location of this crack corresponded to that of the crack on the port side of the stern leg that initiated the catastrophic fracture of the leg. Also, there were two small cracks at the root of the fillet weld. One extended vertically and the other horizontally. The location of the horizontal crack corresponded to that of the crack found while sectioning the fractured surface on the port side of the stern leg during the laboratory macro examination. Examination of the fillet weld attaching the mat deck plating to the stiffener ring showed a

small forked crack at the upper toe of the weld. The location of this crack corresponded to that of the three fractures on the port side of the stern leg stub. Metallographic examination of the microstructure of the stern leg, stiffener ring and mat deck plating showed that the material was a mild steel such as ASTM A-36. A microhardness survey was made using the Knoop hardness (500 gram load) test method. The Knoop hardness numbers, which were converted to Rockwell B hardness numbers for comparison, were normal for a mild steel. The hardness values ranged from 175 to 188 Knoop (87.5 to 90.4 Rockwell B) for the stern leg, 168 to 179 (85.8 to 88.5) for the stiffener ring, 191 to 195 (91 to 91.6) for the mat, 179 to 215 (88.5 to 94.8) in the heat affected zones around the welds and 222 to 273 (95.4 to 99.7) for the weld.

h. Scanning and transmission electron microscopy:

Electron microscopy was used to determine the failure mode and extent of progressive fracture of three selected fractures in the stern leg. These fractures included the catastrophic fracture, one of the two fractures on the port side of the leg in the upper toe of the fillet weld attaching the mat to the stiffener ring and the fatigue fracture found in the root of this fillet weld while sectioning the catastrophic fracture surface. To document the fatigue and overload failure modes of the steel in the leg, three-point slow bend test specimens were cut from the stub. These specimens were precracked by fatigue loading and then overloaded to failure. Scanning electron microscopy (SEM) and transmission electron microscopy (TEM) of the fracture surfaces of the slow bend test specimens provided a basis for comparison with the fatigue regions and fast fracture regions of the fractures. Examination of the specimens showed that yielding occurred between the fatigue and fast fracture regions, and that failure in the fast fracture region was in the quasi-cleavage mode.

The fatigue fracture at the upper toe of the fillet weld attaching the mat to the stiffener ring had a fatigue region and a fast fracture region caused by the upper part of the stern leg dropping on the deck plating of the mat. SEM and TEM studies of this fracture provided a basis for comparison with the catastrophic fracture. This comparison was used to determine the circumferential limits of the fatigue region and the failure mode of the fast fracture region of the catastrophic fracture. SEM and TEM studies of the fatigue crack at the root of the fillet weld supported the basis for comparison.

SEM studies were inconclusive in identifying fatigue on the catastrophic fracture surface because of heavy oxide and surface deposits. However, TEM studies showed a through-the-wall fatigue crack of about 23 inches centered on the port side of the stern leg and a surface crack of about 14 inches centered on the after port side of the stern leg. The two fatigue cracks joined on the port side. The surface crack extended 50 to 70 percent through-the-wall of the stern leg. Also, the TEM studies were used to count fatigue striations on the surface of the catastrophic

fracture. Although fine fatigue striations were removed by corrosive action of the sea water, the studies showed that the 23 inch fatigue crack was propagating for at least 400 days. TEM studies of the starboard side of the catastrophic fracture showed a quasi-cleavage mode of failure. (See figure 7)

i. Fracture mechanics testing and analysis:

Fracture mechanics is a part of fracture analysis. One of its uses is to relate the fracture toughness of a steel to the stress level and critical crack length needed to initiate failure. A failure can be either brittle, which is generally a fast failure, or tensile overload, which is generally a slow failure. The fracture surface of the stern leg stub contained a 23 inch fatigue crack. Although the fracture toughness of the ASTM A-36 steel was unknown, it was later determined by testing. The stress level around the ends of the fatigue crack was unknown. It could not be determined by a traditional method of stress analysis because the actual loadings on the stern leg at the time of the casualty were unknown. However, knowing the fracture toughness of the steel and the length of the fatigue crack, a fracture mechanics relationship for a through-the-wall crack was used to determine the stress level around the ends of the fatigue crack at the time of the casualty. In any fracture mechanics testing or fracture analysis, the significance of fatigue cracks, brittle fracture and method of stress analysis must be considered.

Fatigue cracks result from the application and removal of loads throughout the lifetime of a structure. On self-elevating drilling units, these loads are caused by such things as wind, waves, "tagging the bottom" with the mat prior to jacking up, jacking up and down, preloading, loading ballast water, fuel oil, mud, other consummables, drilling equipment, drill pipe, daily drilling operations and support vessels tying up to the unit. Welded structures are susceptible to fatigue failures because of weld defects, abrupt changes in geometry such as fillet welds and residual stresses. In the case of a fillet welded joint, the fatigue limit can be as low as 10 ksi. The fatigue life of welded structures depends on the range of stresses resulting from the fatigue loading. A fatigue crack does not manifest itself immediately. As much as 50 percent of the fatigue life of a steel may be taken up in the formation of a small fatigue crack.

Brittle fracture occurs when a tensile stress is applied to a crack or defect in a material and the material is susceptible to fracture at the temperature and loading rate that the stress is applied. Generally, the tensile stress level necessary to cause fracture decreases as the size of the crack increases for a particular level of fracture toughness. The tensile stress causing a brittle fracture can result from the nominal stress in the structure, a high stress around a stress concentration, or a residual stress from welding.

The traditional method of analyzing the stress at the connection of the stern leg to the mat is the strength of materials approach. The nominal stress is calculated as an algebraic sum-

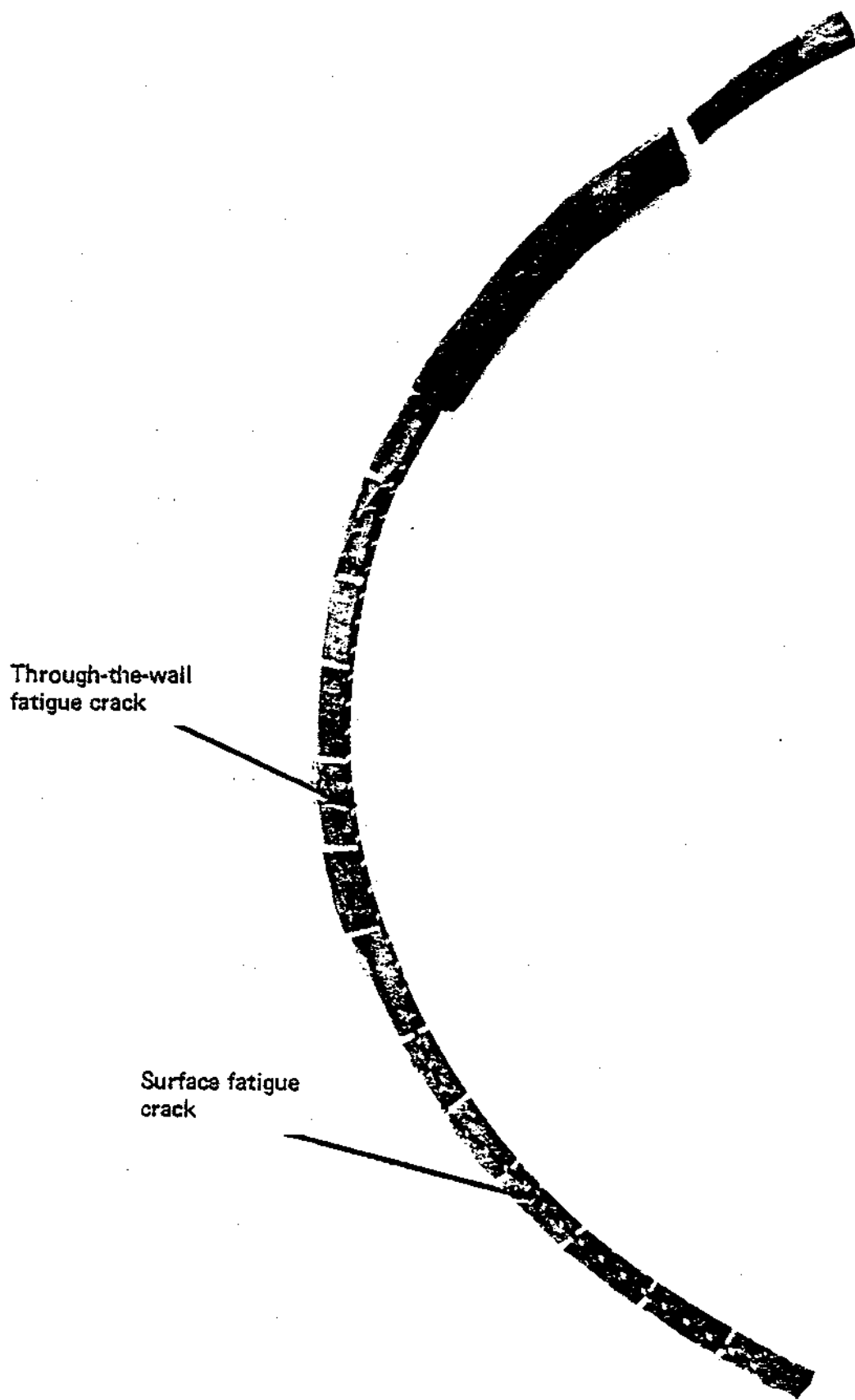

FIGURE 7 – CATASTROPHIC FRACTURE SURFACE OF PORT SIDE OF STERN LEG.

mation of the stresses resulting from axial forces and bending moments. The axial forces and bending moments are determined for various combinations of live and dead loads that represent operational conditions. The nominal stress can be tensile or compressive. In a welded structure, such as the connection of the stern leg to the mat, it is possible for localized tensile stresses to exist even though the calculated nominal stress is compressive. These localized tensile stresses can be caused by fatigue loadings, such as wind and waves, or an eccentric and static loading, such as an irregular seafloor. The magnitude of the localized tensile stresses is increased at the connection because of the stress concentration effect. A stress concentration factor or a finite element analysis that accounts for the actual geometry of the connection can be used to determine the maximum tensile stress.

For the fracture mechanics testing, three-point slow-bend test specimens were cut from the stern leg near the catastrophic fracture. The specimens were 3/4 inch thick, 2 inches wide and 10 inches long, with a test span of 8 inches. Orientation of the specimen notch was parallel to the direction of the catastrophic fracture. Seven specimens were fatigue cracked following the procedures in ASTM Standard E-399 - Standard Test Method for Plane-Strain Fracture Toughness of Metallic Materials. The ratio of crack length to specimen width was 0.5. After being instrumented, the specimens were tested at slow loading rates. The test temperatures were 0°, 32°, 50° and 75° F. Three additional specimens were tested at 50° F. For these specimens, the ratio of crack length to specimen width was decreased to 0.3 to determine the plane-stress fracture toughness.

A preliminary fracture analysis showed that the steel in the stern leg would exhibit plane-stress type behavior rather than plane-strain, or in other words the steel would yield prior to fracture. The seven plane-strain specimens were tested to verify the plane-stress type behavior and to estimate the fracture toughness of the steel. Test results included crack opening displacements (COD) measurements, J-integral analysis and fracture toughness calculations for 5 percent offset secant load, maximum load and plane-strain type behavior. These results were analyzed according to the ASTM Standard E-399. This analysis showed that the specimens exceeded the plane-strain type behavior requirements of the ASTM Standard and that the specimens yielded prior to fracture at the test temperatures. An analysis of the results of the three additional specimens showed that the plane-stress fracture toughness was 80 thousand pounds per square inch times square root inches. COD measurements and J-integral analyses supported this fracture toughness value. The tensile stress level needed to initiate brittle fracture from the 23 inch long fatigue crack was calculated to be about 15 ksi using a fracture mechanics relationship.

#### 18. SAFETY ADVISORY:

On 6 June 1979, the Coast Guard issued a safety advisory to the

owners of self-elevating mobile offshore drilling units similar to the RANGER I. The advisory alerted the owners of the collapse of the RANGER I as a result of a fracture near the stern support leg connection to the mat and they were advised to conduct non-destructive evaluation of the leg to mat connections at the next drydocking.

19. STATUTORY AUTHORITY:

The Outer Continental Shelf Lands Act of 1953 (67 Stat. 462; 43 USC 1331 et seq.) gave the Coast Guard authority to regulate and to promote the safety of life and property on artificial islands and fixed structures on the Outer Continental Shelf (OCS). On 18 September 1978, the President signed into the law the Outer Continental Shelf Lands Act Amendments of 1978, (Public Law 95-372). Title II of these Amendments revised the Outer Continental Shelf Lands Act of 1953 as follows:

- a. The holder of a lease or permit must maintain all places of employment free from recognized hazards to employees, operate in compliance with occupational safety and health standards and other regulations intended to protect persons, property and environment and to allow inspectors prompt access to the site of operations.
- b. There is a provision for both scheduled and unannounced Coast Guard inspections of OCS facilities.
- c. There is a requirement for a Coast Guard investigation and public report on each major fire, major oil spill, death and serious injury resulting from operations on the OCS.
- d. There is a provision for Coast Guard review of any allegation of violation of an occupational safety and health regulation issued under the OCS Act.
- e. There is an authorization for administration of oaths and the subpoena of witnesses and documents in the course of investigations.
- f. There are procedures pertaining to civilian suits, court jurisdiction and judicial review.
- g. There is a provision for a new system of remedies and penalties.
- h. There is a requirement for the Coast Guard to issue regulations that establish the minimum safety standard of design, construction, alteration and repair for vessels, rigs, platforms or other vehicles or structures used for activities on the OCS.

1. There is a provision for the Coast Guard to issue regulations that require certain vessels, rigs, platforms or other vehicles or structures used for OCS activities to be manned by United States Citizens.

## 20. REGULATORY AUTHORITY:

The Coast Guard began development of regulations for bottom bearing mobile offshore drilling and work-over units in 1967. On 1 March 1972, the Coast Guard published proposed rule making to inspect these units under Subchapter I, Title 46 CFR Rules and Regulations for Cargo and Miscellaneous Vessels. The proposed rule making was withdrawn because of public comments that showed the requirements in Subchapter I could not be adopted for these units. A year later, the Coast Guard began formulating rules for mobile offshore drilling units. On 21 November 1978 final rules were promulgated as Subchapter I-A, Title 46 CFR Parts 107 to 109, under the traditional statutory authority for commercial vessel safety regulations. These rules are applicable to vessels (except public vessels of the United States) capable of engaging in drilling operations for the exploration or exploitation of subsea resources that are sea going and 300 or more gross tons and self-propelled by motor, seagoing and 100 or more gross tons and non self-propelled or more than 65 feet in length and propelled by steam. Appendix A of Subchapter I-A promulgates instructions for inspection and certification of existing mobile offshore drilling units.

Subchapter N, Title 33 CFR Parts 140-147 established general requirements for artificial islands and fixed structures on the OCS. On 1 May 1980, the Coast Guard proposed rule making to implement the statutory requirements of Title II of the amendments to the Outer Continental Shelf Lands Act of 1978. This proposed rule making would require a mobile offshore drilling unit to comply with the design, equipment and inspection requirements of Title 46 CFR Parts 107 and 108 in order to engage in OCS activities.

## CONCLUSIONS

1. On 10 May about 1700 an existing fatigue crack in the stern leg of the RANGER I near the connection to the mat reached critical crack length and rapidly propagated into brittle fracture around the circumference of the leg. About 2230, while the rig balanced on the broken leg, the combination of dynamic and static loading caused the broken leg to dislodge from the mat and the rig to collapse into the sea.
2. Seven persons who were aboard the RANGER I were killed and 18 others received injuries resulting in incapacitation for periods in excess of 72 hours as a result of the casualty.
3. [REDACTED] was aboard the RANGER I at the time of the collapse, is missing and presumed dead as a result of the casualty.



4. The casualty may have been prevented had the existing fatigue crack at the connection of the stern support leg to the mat been detected while the unit was in drydock at ADDSCO. However, the commonly accepted method of visual examination was inadequate to detect the crack. Non destructive testing, i.e. dye penetrant, ultrasonic or magnetic particle examination could have detected the fault.

5. The fatigue crack at the stern leg to mat connection existed for at least 300 days before the RANGER I entered ADDSCO. The actual age and length of the crack at that time is unknown. A probable senario of this progressive fracture is that the fatigue crack grew during the life of the unit and was approaching critical crack length at the time the unit entered the shipyard.

6. The American Bureau of Shipping Rules for Building and Classing Offshore Mobile Drilling Units 1973 does not provide sufficient guidance to surveyors on what constitutes particular attention to be given to supporting legs and interacting supporting members during a special periodical survey.

7. The RANGER I was a self-propelled sea going vessel less than 300 gross tons and not subject to Coast Guard inspection for certification.

8. The RANGER I was subject to the provisions of the Outer Continental Shelf Lands Act of 1953 and the 1978 amendments. However, there were no implementing regulations in effect at the time of the casualty that required Coast Guard inspection except for the general requirements in Subchapter N of Title 33.

9. The loss of life and injuries of persons aboard the RANGER I could have been prevented had further action to determine the cause of the shudder at 1700 been taken. The shudder and drop sensation about 5 hours prior to the collapse was significant, startling and uncommon to the experienced crew and should have been significantly alarming to warn of the impending disaster. The unit should have been abandoned, the owner notified and an underwater examination of the legs and mat made. The leg separation would have been easily detectable.

10. The collapse of the unit and the subsequent heavy current and working of the mat in the seafloor while being held by the tug ANNE T. ORGERON from 10 May through 22 May caused the excavation of the oblate and elongated hole near the well site.

11. The number of emergency drills for fire and abandoning the unit was inadequate. The training of the Atlantic Pacific Marine Corp. personnel was weak. There was virtually no safety training for other personnel on the unit.

12. The use of a daily head count each morning to determine the number of persons aboard is an inadequate means of accounting for people and ensuring that there is sufficient lifesaving equipment for them.

13. The crew of the MISS ANGELA saved 14 lives and is worthy of special recognition.
14. The Captain of the FAIRWINDS significantly enhanced the search effort and is worthy of special recognition.
15. There is evidence of violation of 46 USC 222 by [REDACTED], master of the DELTA SEAHORSE, for navigating the vessel without minimum number of licensed mates and able seamen as required by the Coast Guard certificate of inspection.
16. There is evidence of violation of 33 CFR 146.05-25 by the person in charge, [REDACTED], for failure to conduct emergency drills at least once each month.
17. There is evidence of violation of 33 CFR 146.05-30 by the person in charge, [REDACTED], for failure to have the station bill posted in a conspicuous location on the unit.
18. There is evidence of violation of 33 CFR 146.05-25 by the owner of the RANGER I for failure to submit a written report to the cognizant Officer in Charge, Marine Inspection stating why the required emergency drills were not conducted.
19. With the exception of the above there is no evidence of actionable misconduct, inattention to duty, negligence, or willful violation of law or regulation on the part of licensed or certified personnel, nor evidence that failure of inspected material or equipment, nor evidence that any personnel of the Coast Guard, or any other government agency or other persons contributed to the cause of this casualty.

#### RECOMMENDATIONS

1. That a copy of this report be forwarded to the American Bureau of Shipping for their consideration of modifying the rules regarding drydocking, annual and special surveys of self elevating mobile drilling units so that the critical connections of support legs to bottom mats are non-destructively tested at periodic intervals.
2. That further investigation under Civil Penalty Proceedings be initiated against [REDACTED] for possible violation of 33 CFR 146.05-25 and 33 CFR 146.05-30.
3. That further investigation under Civil Penalty Proceedings be initiated against the owner of the RANGER I for possible violation of 33 CFR 146.05-25.
4. That further investigation under Suspension and Revocation Proceedings be taken against [REDACTED], master of the DELTA SEAHORSE, for possible violation of 46 USC 222.

5. That further investigation under Civil Penalty Proceedings be initiated against the owner of the DELTA SEAHORSE for possible violation of 46 USC 222.

6. That the Commandant evaluate the need for remedial legislation to insure that manned self-propelled drilling units of less than 300 GT similar to RANGER I are Coast Guard inspected and certificated.

7. That improved safety indoctrination be provided to all personnel aboard a drilling unit. Its objectives should be that each individual knows how to escape from the unit, that he can locate personnel safety equipment and that he can use it.

8. That a maximum safe occupancy number should be established for a unit and the requisite safety equipment maintained aboard. Transfer of personnel to and from the unit should be controlled to insure the number is not exceeded.

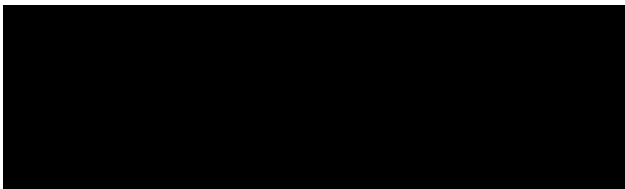

CAPT W. E. WHALEY, JR., USCG  
Chairman

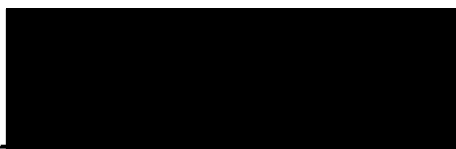

CDR A. E. HENN, USCG  
Member

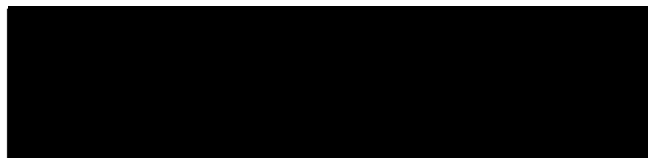

LCDR E. B. KANGERTER III, USCG  
Member and Recorder

