

# Access to TIPS

R2023.NOV

## Trainer Name

Banca d'Italia

## Banca d'Italia

TIPS User Training Course

Date – Training type

*Day 1 - Session TIPS.TR.FN.020*

- 1** **Connectivity (A2A/U2A)**
- 2** **Authentication, authorisation, access rights**
- 3** **Graphical User Interface**

1

## Connectivity (A2A/U2A)

***A2A Connectivity***

***U2A Connectivity***

2

**Authentication, authorisation, access rights**

3

**Graphical User Interface**

## A2A Interactions

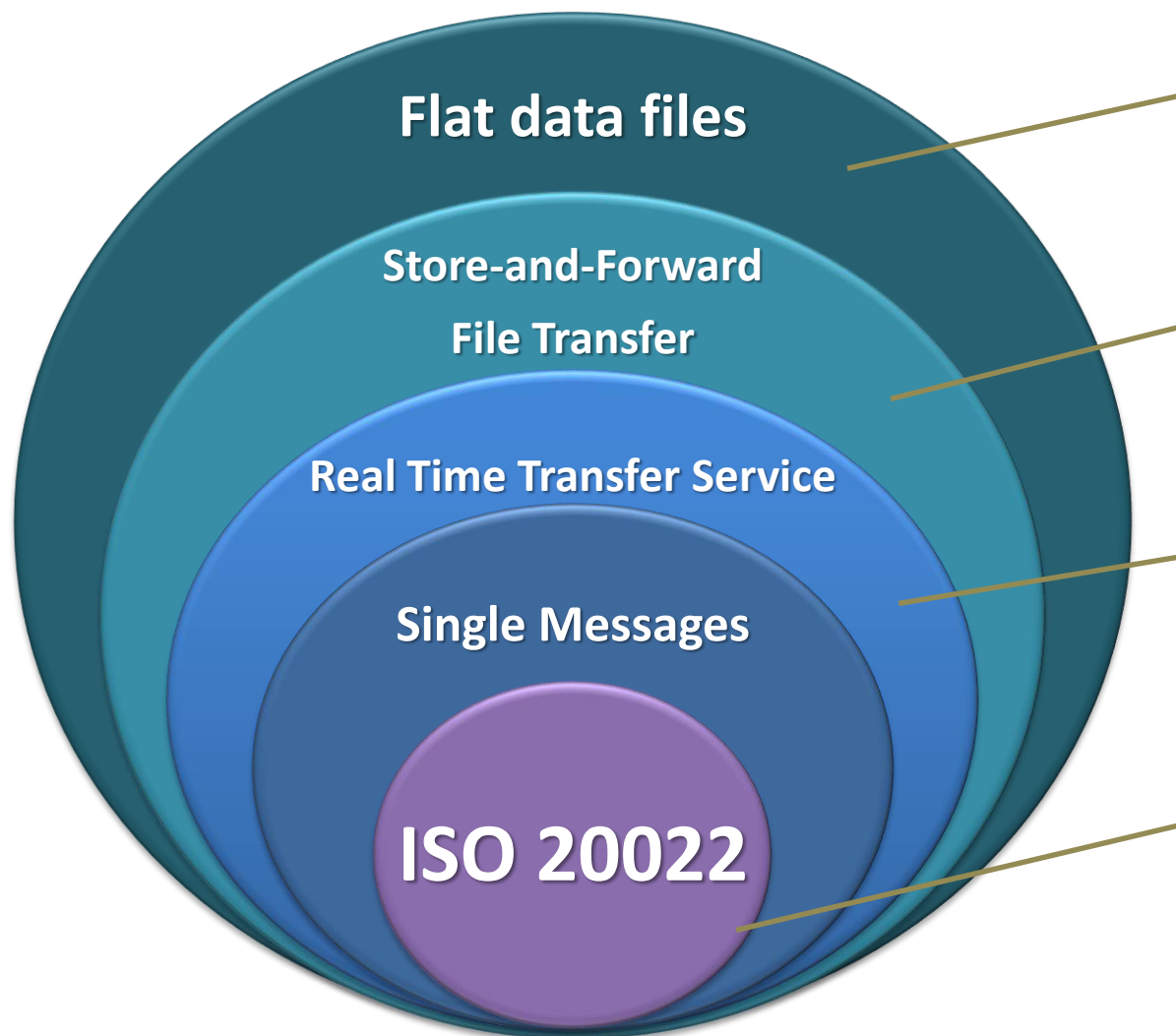

Flat data files

When there is no ISO 20022 standard message available or when the usage of XML technology is not advisable for technical reasons flat data files may be used

Store-and-Forward  
File Transfer

The File-based store-and-forward network service is used by TIPS only to send outbound Reports

Real Time Transfer Service

Data exchange for settlement purpose requires that all the interested actors are available at the same time. If the message cannot be delivered, **no retry mechanism is foreseen**

Single Messages

ISO 20022

A2A Interactions with TIPS are based on XML ISO 20022 standards as described in the **EPC SEPA Inst Scheme**

# TIPS data exchange types

- TIPS data exchange types are mapped against the technical features of the different network services for inbound and outbound communications

Data Exchange	Inbound transfer services	Outbound transfer services
Instant Payment transactions	<i>Instant messaging</i>	<i>Instant messaging</i>
Inbound/Outbound Liquidity transfers	<i>Instant messaging</i>	<i>Instant messaging</i>
Intra-service Liquidity transfers	<i>Instant messaging</i>	<i>Instant messaging</i>
Investigations	<i>Instant messaging</i>	<i>Instant messaging</i>
Queries	<i>Instant messaging</i>	<i>Instant messaging</i>
Recall	<i>Instant messaging</i>	<i>Instant messaging</i>
Notifications	<i>n/a</i>	<i>Instant messaging</i>
Reports (push)	<i>n/a</i>	<i>File-based, store-and-forward</i>
Raw data and data for General Ledger	<i>n/a</i>	<i>File transfer to T2-CLM</i>
General Ledger (external RTGS system)	<i>n/a</i>	<i>Instant messaging to RTGS System</i>

## 1 Connectivity (A2A/U2A)

*A2A Connectivity*

*U2A Connectivity*

2 Authentication, authorisation, access rights

3 Graphical User Interface

## U2A Overview – ESMIG Access

- For specific functionalities, the TIPS Actors can access TIPS Graphical User Interfaces through ESMIG (Eurosystem Single Market Infrastructure Gateway)

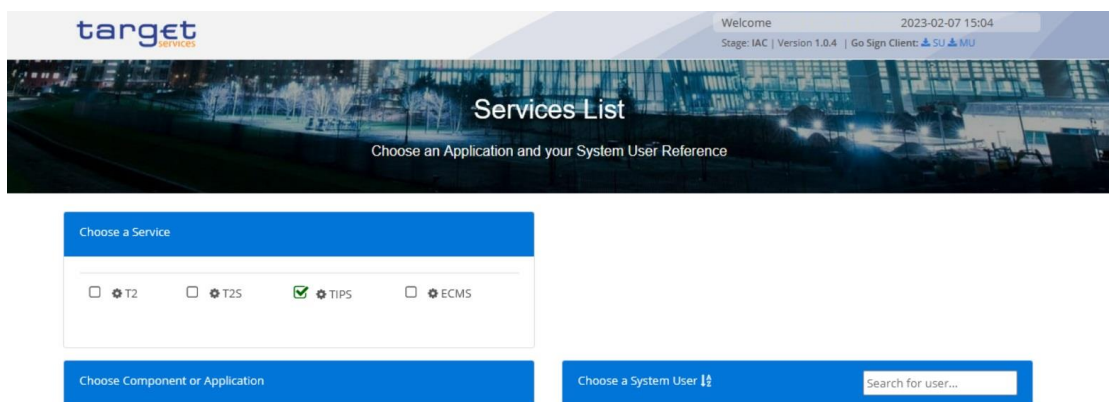

- Upon successful authentication, when **TIPS Service** is selected on top from the available TARGET Services, TIPS GUI is available among the list of other GUIs for Common **Component or Application**:
  - Common Reference Data Management (CRDM)
  - Billing
  - Data Migration Tool
  - Trouble Management System

## U2A Overview – CRDM GUI

- Following the GUI selection and depending on user access right setup, the **System User** can be selected in the right part of the screen
- This channel is foreseen for TIPS Reference Data setup, update and queries

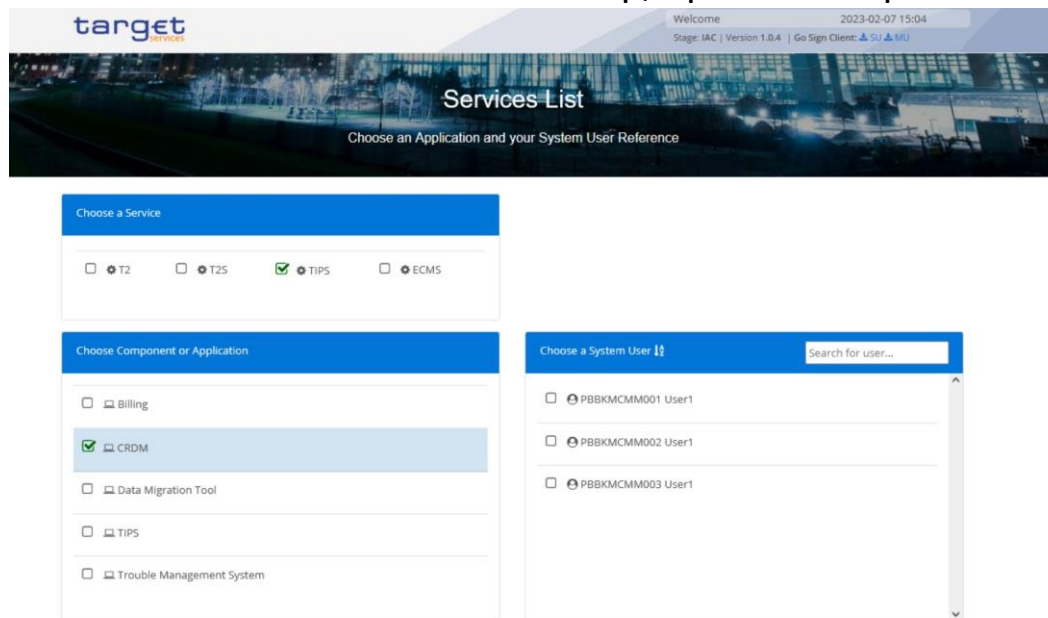

- Each TIPS Actor may trigger all or only a subset of these functions depending on the **participant type** (e.g. Central Bank, TIPS Participant, Ancillary System, etc.) and only in relation to the **objects in its own data scope**
- These functions are available **22 hours a day, 5 days a week**



## U2A Overview – TIPS GUI

- For specific functionalities, the TIPS Actors can access TIPS through a Graphical User Interface
- This channel is foreseen for a small subset of functionalities and queries

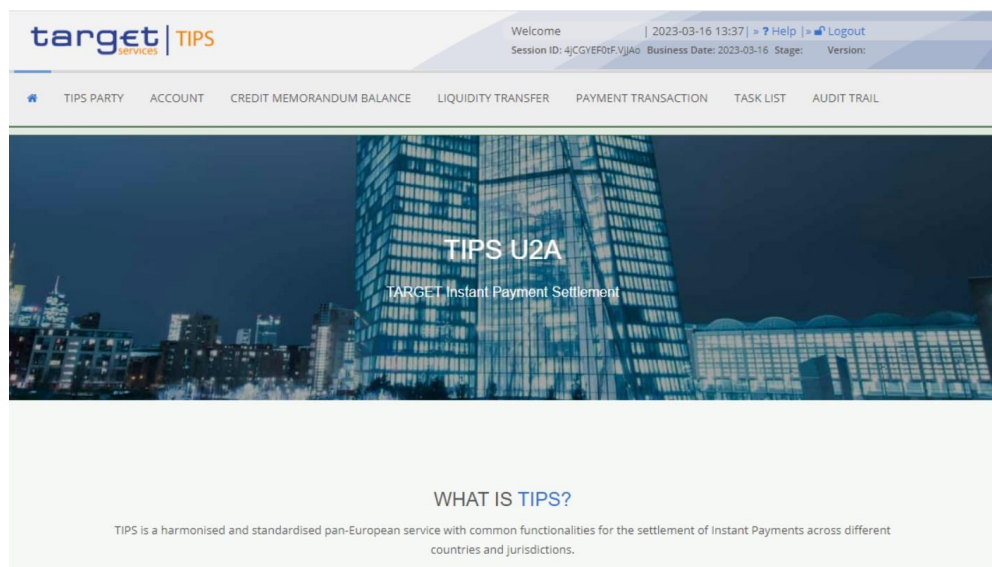

- Each TIPS Actor may trigger all or only a subset of these functions depending on the **participant type** (e.g. Central Bank, TIPS Participant, Ancillary System, etc.) and only in relation to the **objects in its own data scope**
- These functions are available on a **24/7/365** basis

## U2A Functions in the TIPS GUI

FUNCTION	ACTORS			
	TIPS Operator	Central Bank	TIPS Participant, Ancillary Systems or Instructing Party on behalf	Instructing party on behalf of Reachable Party
Block/Unblock Participant or Ancillary System	✓	✓	✗	✗
Block/Unblock TIPS Account or TIPS AS Technical Account	✓	✓	✗	✗
Block/Unblock Credit Memorandum Balance	✓	✓	✓	✗
Adjust Credit Memorandum Balance Limit	✓	✓	✓	✗
Payment Transaction Query / Advanced Query	✓	✓	✓	✓
Query Account Balances and Status	✓	✓	✓	✗
Query CMB Limit and Status	✓	✓	✓	✓
Initiate Outbound Liquidity Transfer	✓	✓	✓	✗
Initiate intra-service Liquidity Transfer	✓	✓	✓	✗
Liquidity Transfer Query / Advanced Query	✓	✓	✓	✓

- 1 **Connectivity (A2A/U2A)**
- 2 **Authentication, authorisation, access rights**

*Authentication and authorisation process*

*Access rights*

- 3 **Graphical User Interface**

## Eurosystem Market Infrastructure Gateway (ESMIG) (1/2)

- **ESMIG** is a single service providing network connectivity and a messaging interface to the different market infrastructures of the Eurosystem.
- ESMIG is a common market infrastructure component that multiple market infrastructures will use; T2S, T2, TIPS and ECMS.
- It reduces operational complexity for both market participants and Eurosystem; it centralizes different networks, harmonizes protocols, graphical interfaces and certificates management.
- ESMIG is based on a **catalogue of services** concept:
  - Network connectivity services
  - Security services
  - U2A services
  - A2A network services
  - A2A message/file services
- The different platforms (T2 / T2S / TIPS / ECMS) can require different set of ESMIG services (i.e. T2, T2S and ECMS use for A2A exchange **DEP** protocol, while TIPS use **MEPT** one).

# Eurosystem Market Infrastructure Gateway (ESMIG) (2/2)

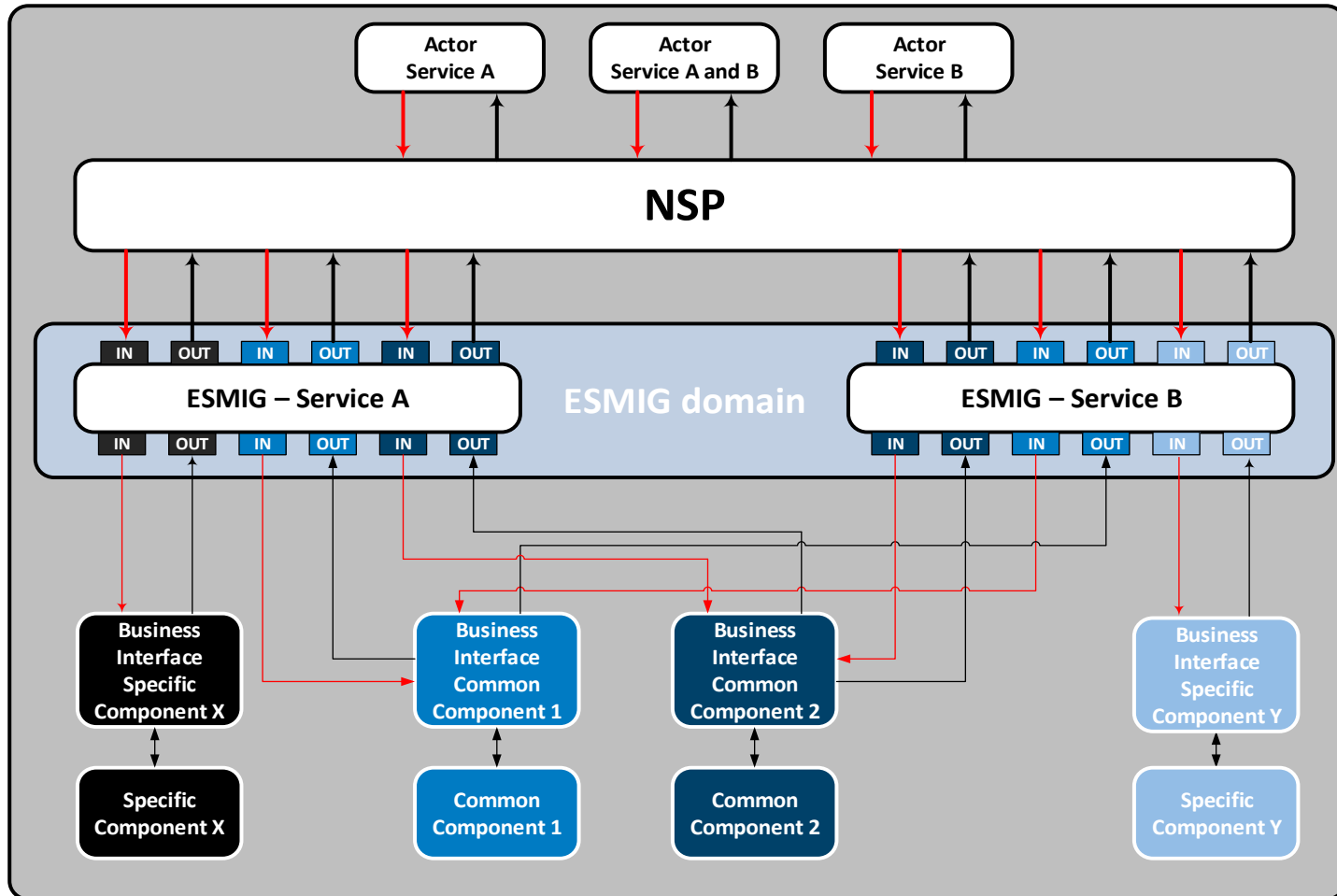

## Authentication and Authorisation for A2A (1/3)

- Any individual or application interacting with TIPS is identified by its Distinguished Name (DN)
- DNs are univocally linked to digital certificates\*, which are issued by the selected NSP and that TIPS Actors assign to their individuals or applications

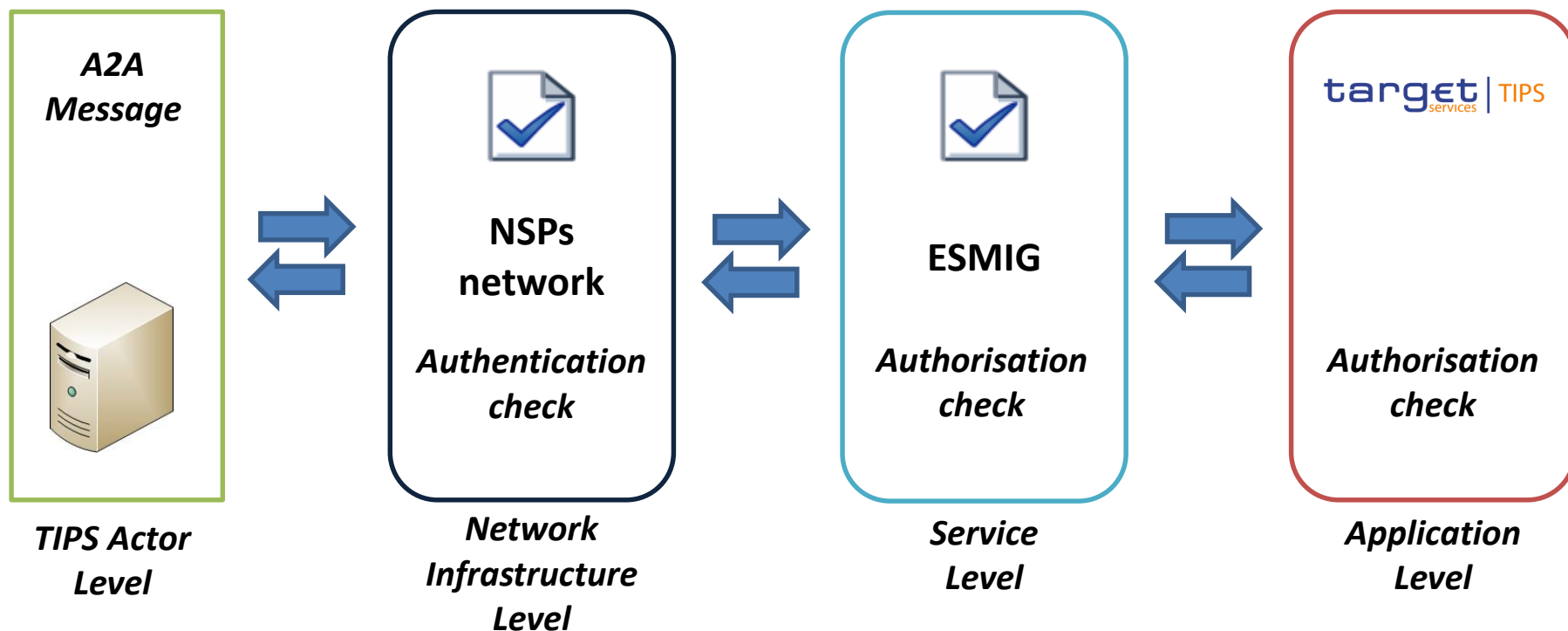

\*A digital certificate is used in the signature processing of the business payload

## Authentication and Authorisation for A2A (2/3)

- Upon successful delivery of an A2A message from the NSP, ESMIG performs:
  - Digital signature verification both at **transport** and **business payload** level
  - **Schema** and **additional technical validations** on the business message



**NSPs  
network**

**Network  
Infrastructure  
Level**

- **MEPT** protocol is used in the interface between each NSP and ESMIG
- If any error is detected during the ESMIG validation, an error message is sent back to the sender:
  - Admi.007
  - A specific business message (e.g. camt.025, pacs.002, etc) with generic code '**MS01**'
- If no error is detected at this stage the message is delivered to the application



**ESMIG**

**Service  
Level**

## Authentication and Authorisation for A2A (3/3)

- Upon successful validation, ESMIG delivers the message to the Message Router component:
  - The **message business payload** extracted from the MEPT envelope
  - The **Distinguished Name** of the business sender, extracted by the Digital Signature Verification process



**ESMIG**

*Service  
Level*

- The Message Router checks:
  - The Access Right profile linked to the DN allows for the submission of the request
  - The business items reported in the message (e.g. accounts, BICs, etc) are consistent with the Reference Data setup
- If errors are detected, a business message (e.g. pacs.002) with proper error code (e.g. 'DNOR') is sent back to the sender
- If no errors are detected, the message is submitted to the TIPS Core for further processing

target | TIPS  
services

**Message  
Router**

*Application  
Level*



## Authentication and Authorisation for U2A (1/3)

- Any Distinguished Name issued by the NSP is inserted in a Closed Group of User (CGU)
- Whenever a user sends a request to reach an URL (e.g. the URL of the ESMIG Portal, the URL of the CRDM GUI), the NSP checks whether the DN is authorised via the CGU
- When ESMIG Portal is reached, authorisation checks against the TIPS IAM\* are executed

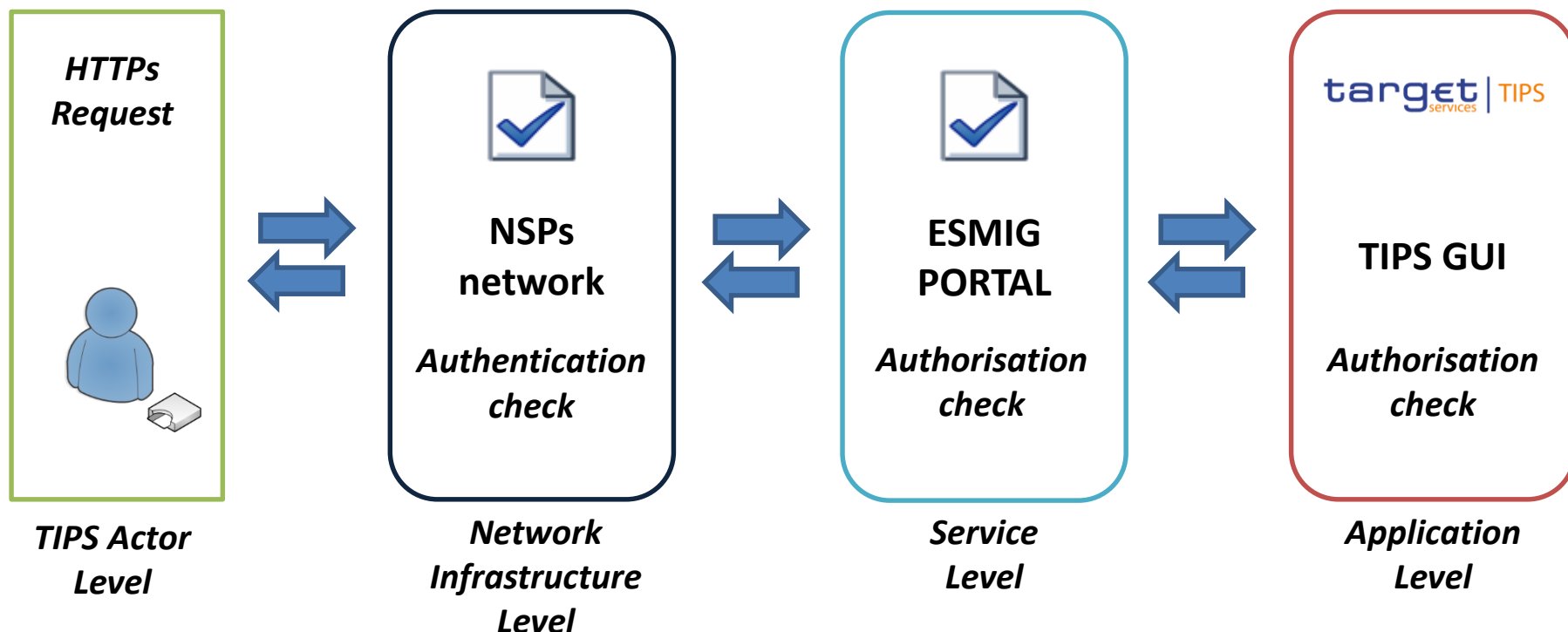

## Authentication and Authorisation for U2A (2/3)

- Upon successful authentication, the user is redirected to the **ESMIG Portal** URL
- Depending on its Access Rights Profile captured in CRDM, each user will be able to reach different services, components or applications

The screenshot shows the ESMIG Portal interface. At the top left is the 'target services' logo. At the top right, it displays 'Welcome | 2019-09-10 14:55' and 'Stage: LOCAL | Version 1.0.0'. The main heading is 'Services List' with the instruction 'Choose an Application and your System User Reference'. Below this, there are three selection panels:

- Choose a Service:** Contains three radio buttons: 'TIPS' (checked), 'T2', and 'T2S'.
- Choose an Application:** Contains three radio buttons: 'CRDM', 'Data Migration Tool', and 'TIPS' (checked).
- Choose a System User:** Includes a search input field 'Search for user...' and a list of four radio buttons with user IDs: '918299', '993393', '993399', and '998899'.

A 'Submit' button is located at the bottom left of the form area.

## Authentication and Authorisation for U2A (3/3)

- The ESMIG portal allows and guides the person accessing the system to:
  - **choose the service** among the authorised services accessible by at least one user-ID linked to the DN of the user;
  - **choose the component/application** among the authorised components and applications accessible by at least one user-ID linked to the DN of the user;
  - **choose the user** to impersonate when accessing the selected component or application.
- After the correct selection, the user will be redirected to the Welcome Page of the requested component (i.e. **CRDM GUI, TIPS GUI**) or application (e.g. **Data Migration Tool, Trouble Management System**, etc.)

## Message routing

TIPS allows Participants and Instructing Parties to use multiple distinguished names (DNs) to communicate with the network service

TIPS actors are able to set up routing configurations, allowing TIPS:

- to accept messages coming from specified DNs
- to route a predefined set of outbound communication to a specified DN

Depending on the direction of communication, a distinction can be made between:

- **Inbound messages** → TIPS allows **many-to-many** relation between Originator Participant or Reachable Party and instructing DNs
  - The same Instructing Party can then play its role for many TIPS Actors
  - A Participant or Reachable Party can authorise many Instructing Parties to act on its behalf
- **Outbound messages** → TIPS allows **many-to-one** relation between Beneficiary Participant or Reachable Party and receiver DNs
  - Any given Beneficiary Participant BIC may be linked to only one Distinguished Name for the reception of instant payment messages

**1** **Connectivity (A2A/U2A)**

**2** **Authentication, authorisation, access rights**

*Authentication and authorisation process*

*Access rights*

**3** **Graphical User Interface**

## User configuration

Given the hierarchical model, each legal entity may define within its Party object in CRDM a certain number of logical Users. In order to operate in TIPS, each logical User shall be:

- Linked to a DN
- Configured with **Main User flag** set to 'TRUE'
- Granted with an Access Rights Profile (i.e. a set of Privileges encapsulated in one or several Role)
- If the User has to operate as 'A2A user', its DN shall also (i) appear in the list of **Party Technical Address** and (ii) be linked with a **Network Service**

When **Data Propagation** from CRDM to TIPS is executed on a daily basis, the "logical User" dimension disappears and only the DN is used for any TIPS validation

TIPS authorises the sender of a given request only if its DN fulfils both of the following conditions:

- The DN has been granted with the relevant privilege(s) required to submit the request
- The DN is authorised to submit the request on the requested business object(s)

## Main User flag (1/2)

**Each user shall be linked to its DN (i.e. the information linked to its digital certificate issued by the responsible NSP)**

- The Main User flag is set in CRDM in the *User-Certificate DN Link* screen
- As a general rule DNs can be linked to multiple users via User-Certificate DN Links with Main User flag set to TRUE
- These users can belong to different Payment Bank parties, but there can only be one user for each Payment Bank that is the Main User for a specific DN

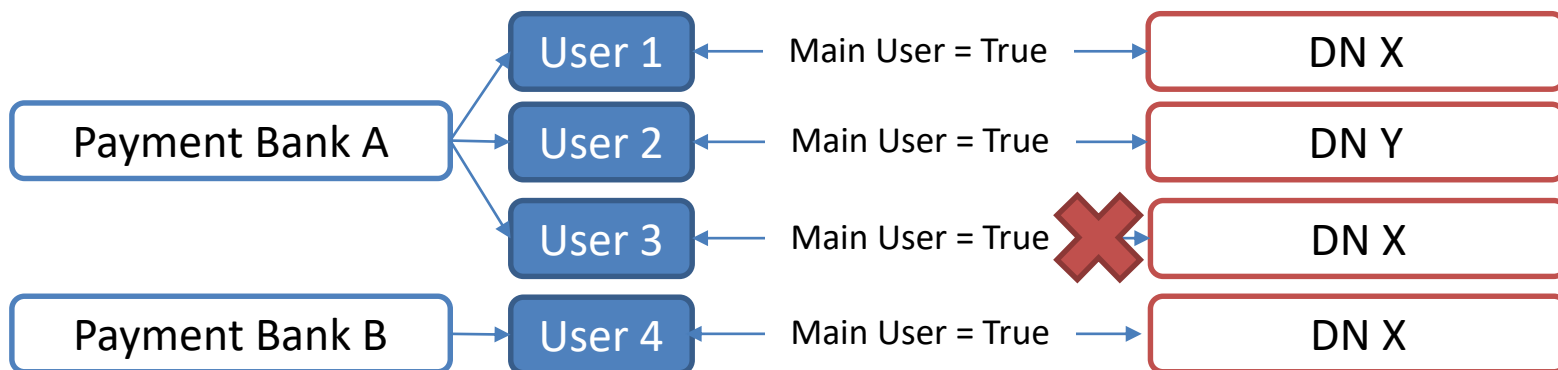

**If the DN has not been flagged as Main User, the user will not be able to use the TIPS function properly**

## Main User flag (2/2)

target | TIPS MENU

Welcome NCBXSKMMXXX User1 | 2021-05-12 17:49 | ? Help | >> Logout  
Session ID: eyJhbGciOiJIUzI1NiJ9 Business Date: 2021-05-14 Stage: TST version: 1.0.10 NRO Enabled

Common / Access Rights Management / User Certificate Distinguished Name Links / Search / New

USER CERTIFICATE DISTINGUISHED NAME NEW

Login Name: NCBXSKMMXXX User1

Certificate Distinguished Name: CN=u2a-nro08, OU=test, OU=t2s, O=trgtxetg, O=swift

Default:  Main User:

+ Submit \* Reset \* Cancel



## Access rights (1/2)

The DN has been granted with the relevant privilege(s) required to submit the request

- The capability to trigger a specific TIPS user function is granted by means of the related **Privilege** (stored within the **CRDM**)
- **CRDM** provides the functionality to group different Privileges into **Roles**
- Roles are then granted to **users**, each of them linked to and identified by a DN
- Privileges for TIPS users can only be propagated through Roles

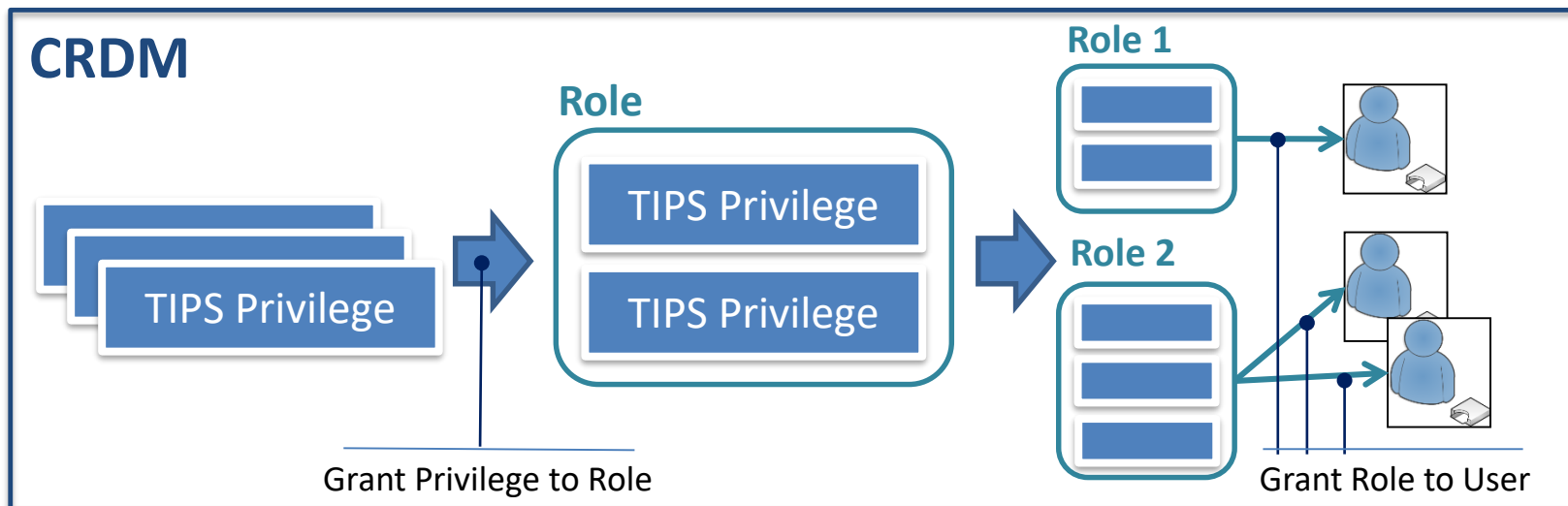

## Access rights (2/2)

### The DN is authorised to submit the request on the requested business object(s)

- This second condition is based on the business object itself on which a request is being performed
  - For instance, in case of **Instant Payment transaction**, the object is represented by the account being debited; in an **Account balance and status query**, the object is the account being queried
- TIPS applies specific business logic, which may differ depending on the request type, to determine whether a certain DN is authorised to act on a certain object
- If a certain DN is authorised to trigger a function (related to a specific Privilege) on a specific object, that object belongs to the DN's **data scope** for that Privilege
  - E.g. a TIPS Account is by default in the data scope of its account owner (i.e. the TIPS Participant)
  - Moreover, the same TIPS Account is in the data scope of the account owner's responsible Central Bank (and the Operator upon contingency)
  - Additionally, the same TIPS Account may be in the data scope of an authorised Instructing Party (e.g. an ACH acting on behalf of the account owner for some functions)

- 1 **Connectivity (A2A/U2A)**
- 2 **Authentication, authorisation, access rights**
- 3 **Graphical User Interface**

**Overview**

## TIPS GUI - Functions

TIPS supports User-to-Application (U2A) access for the following critical functions that must be **available 24/7/365**:

- **Query transactional data**
  - Payment Transaction Status Query
  - Advanced Payment Transaction Status Query
  - Liquidity Transfer Status Query
  - Advanced Liquidity Transfer Status Query
  - Balance and Status of an Account
  - Limit configuration and Status of a CMB
- **Local Reference data functions with immediate effect**
  - Manage TIPS Actor blocking status
  - Manage Account blocking status
  - Manage CMB blocking status and Limit changes
  - Submit Liquidity Transfers (either outbound or intra-service)
- **TIPS Operator functions**
  - Report generation for EPC/CB statistics

## TIPS GUI – Access

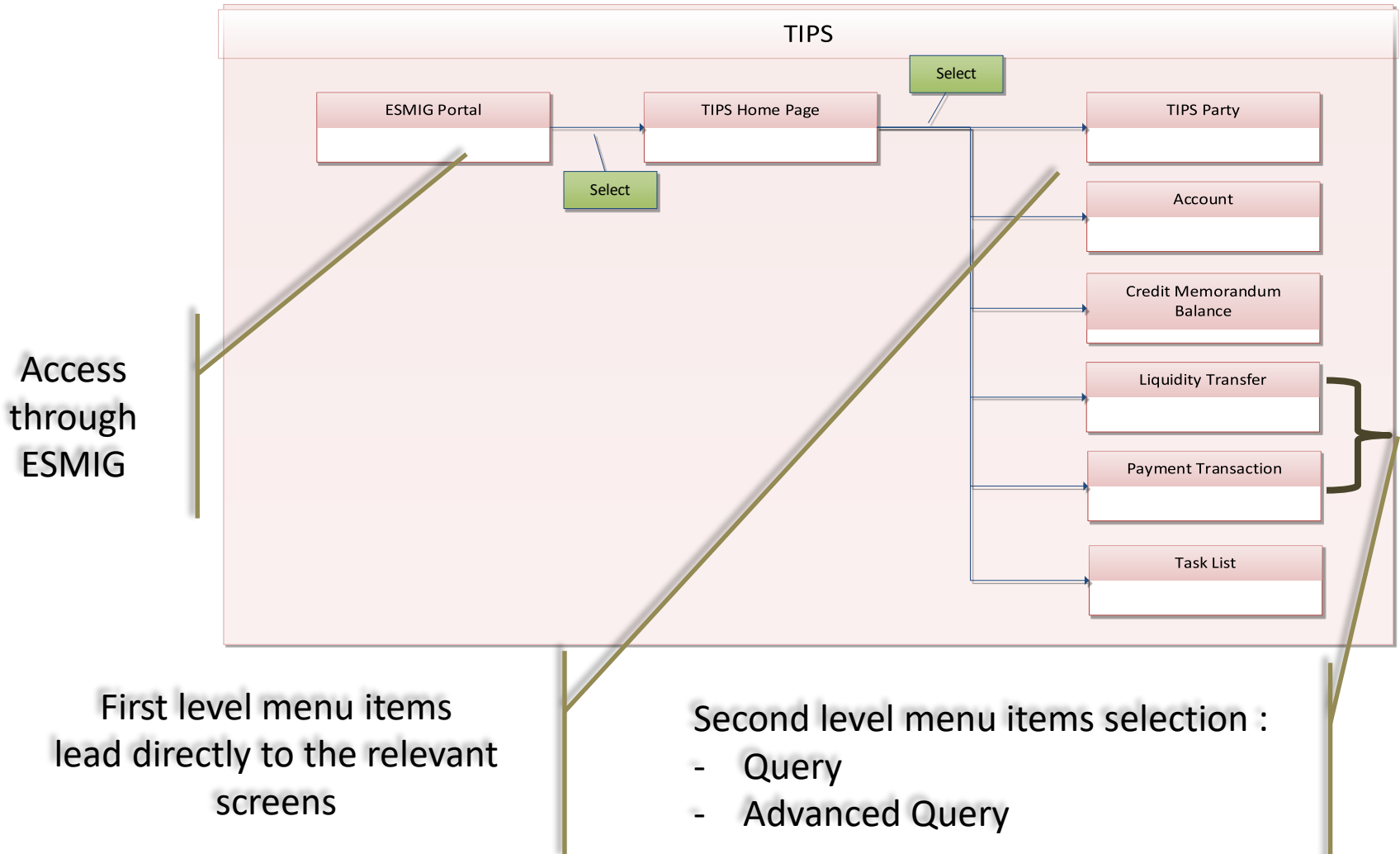

## TIPS GUI - Navigation bar

The GUI menu is structured into two hierarchical menu level. The level is presented as a menu bar containing seven menu items

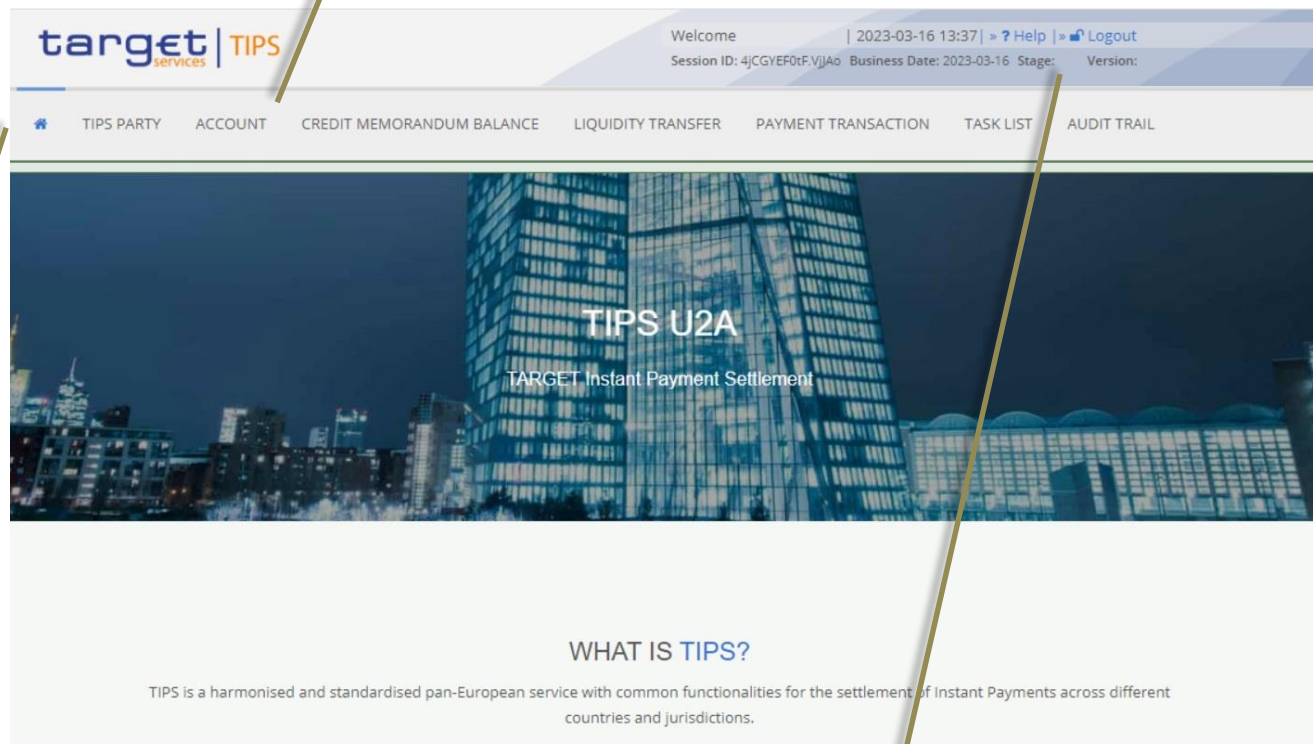

The visibility of the menu entries depends on the user access rights profile

The header appears at the top of every screen. It contains four main elements that provide useful information such as the current business date, the user logged in, the session ID and the Stage/Version

## TIPS GUI - The content area

**Breadcrumb:**  
Shows the main path to the current screen

**Button bar:**  
Shows all available buttons for the current screen

**Print icon and Refresh icon**

**Frame and sub-frame titles:** Groups related information as a structural function

TIPS Account Number:

Q Search    X Reset

**TIPS ACCOUNT LIST**  
search for TIPS accounts

TIPS Participant:	TESTEUNNXXX	Account Number:	cxxc
Currency:	EUR	Account Status:	Unblocked
Timestamp of the reported balance:	2018-03-23 18:04:13	Current Account Balance:	77.000,00 €

Change Status

## TIPS GUI – Basic Query example

Credit Memorandum Balance / Search

CMB Number: BITEURCCIT2RXXX01

Search Reset

CMB user BIC:	TESTEUNNXXX	CMB Number:	BITEURCCIT2RXXX01
Account Number:	TESTACCOUNT1234567	Currency:	EUR
Timestamp of the reported values:	2018-03-26 09:59:56	CMB Status:	Unlocked
Current CMB limit:	1.000,00 €	Current CMB Headroom:	1.000,00 €

Change Status Modify Limit

Only Search criterion is CMB number

Query information available on the same screen

Access to the **Blocking** Screen through the Query screen

Access to the **Modify Limit** Screen through the Query screen



## TIPS GUI – Advanced Query Search/List example

High number of available Search criteria

Query results available in a sortable list in the same screen

Access to the **New** Screen (only for Liquidity Transfer)

Possibility to **Export** the returned list for further processing

LIQUIDITY TRANSFER ADVANCED LIST  
Advanced search for Liquidity Transfer

Liquidity Transfer reference:  Debtor BIC:

Creditor BIC:  Status:

Cash Account:  Direction:

Amount From:  Amount To:

Business date From:  Business date To:

Liquidity Transfer referen...	Debtor BIC	Creditor BIC	Debited Cash Acc...	Credited Cash Acc...	Status	Amount	Settlement ...
TIPLT00230315600	DABAIE2D	BABAIE2B	ACCOUNTNUMBER001	ACCOUNTNUMBER002	Settled	100	2023-03-15
TIPLT00230315601	DABAIE2D	CABAIE2C	ACCOUNTNUMBER001	ACCOUNTNUMBER003	Settled	100	2023-03-15
TIPLT00230315603	CABAIE2C	DABAIE2D	ACCOUNTNUMBER003	ACCOUNTNUMBER004	Settled	200	2023-03-14

Total rows: 3

## TIPS GUI – Advanced Query Search/List main features

**Available only for *Payment Transaction* and *Liquidity Transfer* :**

- High number of available **Search criteria** (e.g. Cash Account, Amount range, Business Date range)
- Query results available in a **sortable list** in the same screen
- Access to the **Display** Screen after selecting a returned item in the list (only available for *Advanced Payment Transaction - List*)
- Access to the **New** Screen via dedicated button (only available for *Liquidity Transfer* starting from *Advanced Liquidity Transfer Search/List screen*)
- Possibility to **export** returned list in CSV format for further processing

**Thank you for the attention!**

---