



FEDERATION INTERNATIONALE DE L'AUTOMOBILE

**Guide and installation specifications for Hybrid and
Hybrid Pro devices in racing competition**

March 2022

Contents

Foreword.....	3
1. Hybrid or Hybrid Pro Selection	3
1.1. Hybrid sizing.....	3
1.2. Hybrid wings or tabs	4
2. Preparation of the a Hybrid	4
2.1. Friction rubber	4
2.2. Padding	4
2.3. FHR Tethers length Adjustment.....	5
2.4. Seat Belt Anchoring System (SAS) Straps on Hybrid devices	6
3. Helmets to be used with a HYBRID or HYBRID PRO.....	7
4. Installation	7
4.1. Seats.....	7
4.2. Harness.....	7
4.2.1. <i>Harness restrictions</i>	8
4.2.2. <i>Position of Adjusters</i>	8
4.2.3. <i>Shoulder belt angles – top view</i>	8
4.2.4. <i>Shoulder belt angles – side view</i>	9
4.3. Headrests and cockpit surrounds with Hybrid.....	10
4.4. Car evacuation with Hybrid.....	10
5. Life of the Hybrid	10

Foreword

A Frontal Head Restraint (FHR) **device** restrains the driver's head relative to his torso during a frontal or angled-frontal impact, thereby, reducing the loads to the head and neck.

There are different types of FHR systems approved, the HYBRID and HYBRID PRO being two of them.

This document aims to **give provide** some basic guidelines on the aspects to take into account when selecting and using a HYBRID or HYBRID PRO device for racing competitions. These guidelines apply to HYBRID and HYBRID PRO **devices** approved according to FIA Standard 8858-2010 that are included in Technical List no°29 available **on in** the FIA website www.fia.com under the homologations section.

1. Hybrid or Hybrid Pro Selection

When choosing a Hybrid or Hybrid Pro **device**, model type and sizing needs to be considered. The Hybrid has a longer rear tail than the Hybrid Pro, and two straps that connect to the safety harness buckle, called **the** Seat Belt Anchoring System (SAS). The Hybrid Pro does not include the SAS.

The seating position angle does not influence the type of Hybrid or Hybrid Pro to select.

Unless specified, when Hybrid is mentioned in this document, it refers to both HYBRID devices and HYBRID PRO devices.

1.1. Hybrid sizing

Hybrid devices are sized by the Hybrid-harness that attaches the device to the wearer. The rigid part of the device is the same for sizes Extra Small to XXX Large. The Hybrid -harness of the device is sized by measuring the wearer's chest **contour circumference** as shown in Figure 1.

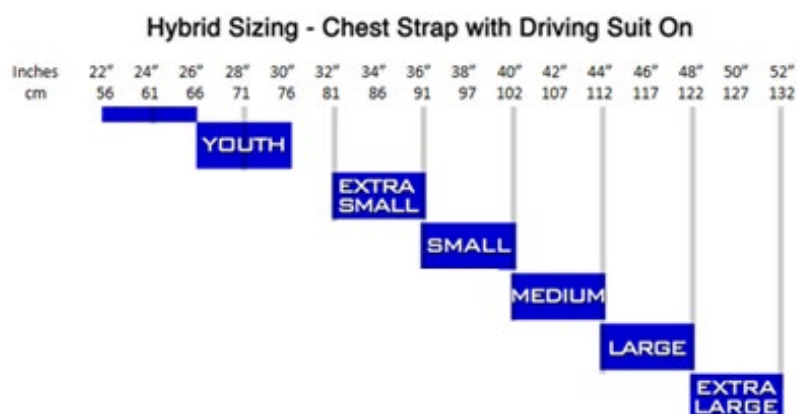

Figure 1 Sizing according to chest **circumference contour**

1.2. Hybrid wings or tabs

Hybrid devices have small wings or tabs at the upper part of the shoulder belt bearing surface, as shown in Figure 2, in order to reduce the lateral movement of the shoulder belts and retain the belts on the device.

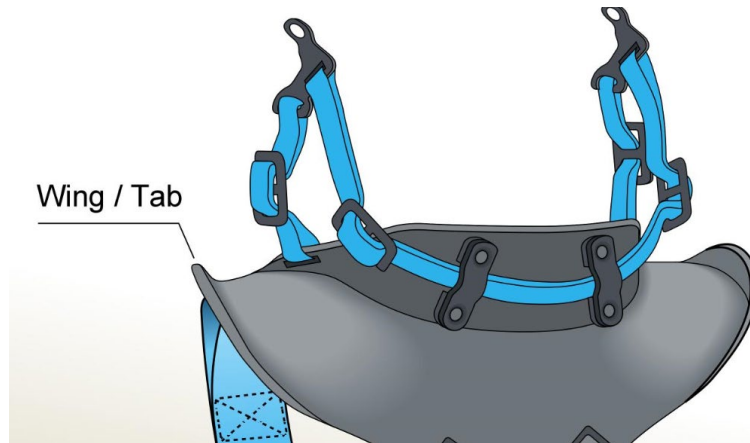

Figure 2 Example of wing on and Hybrid Pro device

2. Preparation of the a Hybrid

The body of the Hybrid device must never be modified but there are some aspects that can be taken into account to prepare the Hybrid or Hybrid Pro.

2.1. Friction rubber

The upper surface of some Hybrid devices is covered in a high friction rubber to grip the lower surface of the shoulder straps. On these devices, drivers must not remove the friction material. The condition of the rubber surface ~~should~~ **shall** be monitored – no breakage, ripping, tears or other damage is acceptable. In case of repair, it shall be done strictly in accordance with the manufacturer's instructions. **The** FIA strongly recommends **that** ~~for~~ this operation ~~to~~ be carried out by device's manufacturer.

If the Hybrid is painted (only in conformity with the manufacturer's instructions) **it is essential that** the rubber ~~is~~ **shall be** left completely uncovered to ensure that the friction with the shoulder belts is not compromised. Any painted Hybrid shall respect the flame resistance requirement of FIA Standard 8858-2010.

2.2. Padding

The surface of the Hybrid device in contact with the driver's body can be padded for comfort. Any padding used between the driver and the Hybrid must not be more than 15 mm thick when the driver is seated in the car fully equipped with the harness tightened. The padding must be covered by a flameproof material, and the padding must not be wider than 8 mm on each side of the Hybrid.

2.3. FHR Tethers length Adjustment

The tether assemblies for a Hybrid need to be adjusted to the individual driver, while seated in **the** racing position with its harnesses tightened.

Hybrid devices have two pairs of FHR tethers, as shown in Figure 3.

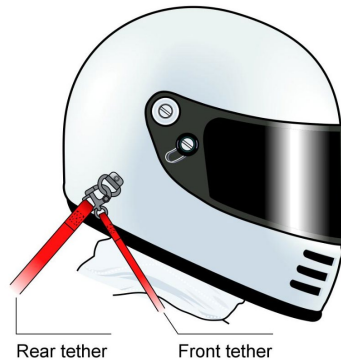

Figure 3 Identification of **the** a Hybrid device's tethers

The procedure to adjust the tether assemblies in the car is as follows:

- 1) Once seated in **the** racing position with the harnesses tightened,
 - The rigid part of the Hybrid must be sitting on the shoulders between the driver's back and the seat, and the shoulder belts **should shall** be on the belt bearing surface on the device.
 - The FHR tethers **should shall** be pulled up slightly to make sure the device is up against the shoulder belts after the belts are tensioned.
- 2) The rear tethers **should shall be** adjusted first.
 - The rear tethers can be partially unlaced from the adjustment 3-bars to allow for adjustment of the tethers.
 - The tether **should shall then be** attached to the helmet on both sides of the helmet.
 - It is recommended to fit the tethers so that they **will** allow the wearer forward head movement in the range of 25 mm to 50 mm, from the wearer's static or starting position in the car, as indicated in Figure 4. The static position is the position that the wearer is in while driving the race vehicle. The helmet should not be up against the rear headrest, but rather **be** in the normal driving position. (The chin should be up while doing this maneuver. It is a straight, forward motion.)

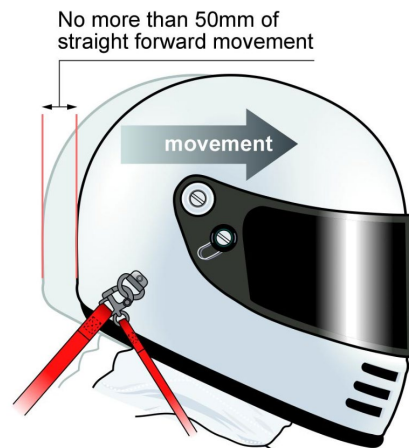

Figure 4 Movement to define the tethers adjustment

- Always adjust the tethers on the right side of the restraint to the same length as the left side of the restraint.
- 3) The front tethers **should shall** be adjusted next.
- With the helmet anchor attached to the helmet, the front tether length **should shall** be adjusted to a suitable length to be able to rotate the head to the left and **the** right. The wearer **should shall** have free movement for at least the first 12 mm to 25 mm. The movement **should shall** be restricted to less than 90° on each side.

The condition of the tethers and clamping brackets and the screws securing them to the back of the Hybrid series **should shall** be closely monitored, and they **should shall** be replaced if any wear is observed.

2.4. Seat Belt Anchoring System (SAS) Straps on Hybrid devices

Hybrid devices have two diagonal straps that run from the bottom of the rigid part of the device, around the wearer to the front of the wearer, and attach into the seat belt buckle. These straps are called the Seat Belt Anchoring System (SAS), and they are not present in Hybrid Pro devices. The end fitting of the SAS should be hooked to either **to** the shoulder straps tongues, the lap strap tongues, or the crotch strap tongues. Figure 5 shows some examples of possible assemblies.

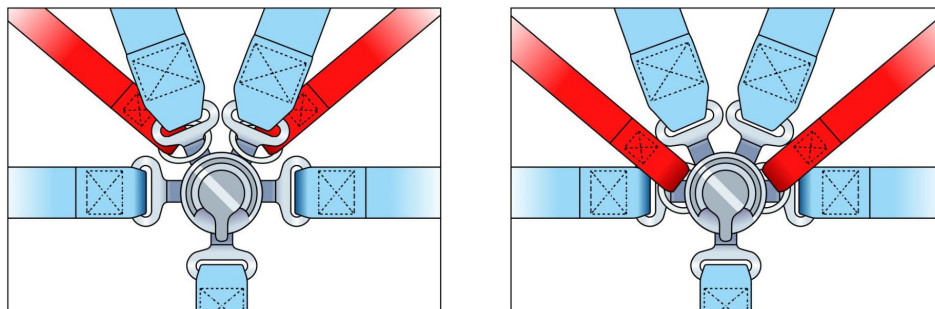

Figure 5 Examples of the SAS assembly into the seat harness buckle

The length of the SAS straps ~~should~~ **shall** be adjusted once the seat belt harness and the rest of the Hybrid straps have been buckled and tightened.

3. Helmets to be used with a ~~an~~ **HYBRID or HYBRID PRO**

An FIA-approved helmet according to FIA Standards 8858-2002, 8858-2010, ~~8860-2004~~, 8860-2010, ~~8860-2018~~ or 8859-2015 is required. Please refer to FIA Technical Lists 33, 41, ~~49~~ and ~~49~~ **69** for a full list of helmets approved for FHR use (including Hybrid and Hybrid pro use). Helmets with FIA labels 8858-2002 or 8858-2010 are only valid when they also have a Snell sticker. Therefore, only helmets with a valid Snell certification are acceptable.

It is important to take into consideration the following dates:

- ~~• Helmets approved in accordance with SA2005 certification will not be valid after 31.12.2018 even if they have an FIA 8858-2002 or 8858-2010 label. Technical List no. 41 details what Snell standard the homologation was based on.~~
- ~~• Helmets approved according to FIA Standard 8860-2004 will not be valid after 31.12.2020.~~
- Helmets approved according to FIA Standards 8858-2002 or 8858-2010 will not be valid after **31.12.2023**, regardless of what Snell certification they may have.

Hybrid devices ~~s~~ shall always be used together with the helmet, and shall be properly fitted (FHR tether end fittings clipped on the helmet and all device straps buckled and tightened).

Therefore, whenever a helmet is not worn, for example on rally liaison sections, the Hybrid shall also be removed.

4. Installation

4.1. Seats

When using a Hybrid with a ~~saloon~~ **salon** car, safety seats homologated according to FIA Standards 8855-1999, ~~8855-2021~~ or 8862-2009 must be used.

In these cases, it is important to ensure that the shoulder straps run freely between the seat shoulder slots. It is therefore recommended to centre the belt traps in the slots ~~so~~ **such** they do not touch the edges of the slots.

4.2. Harness

The safety belts to be used must be minimum five-point harnesses homologated to FIA standard 8853/98 or 8853-2016. Drivers must ensure that they remain properly tightened ~~at~~ **at** all ~~the~~ **the** times ~~s~~.

Teams shall pay particular attention to the installation of the shoulder straps and the position of the buckle. The buckle position is regulated by Article 253.6.2 ~~to the ISC of Appendix J to the 2022 FIA International Sporting Code~~. See below extract of the related regulation:

Article 253.6 Safety Belts

(...)

The lap straps must fit tightly in the bend between the pelvic crest and the upper thigh. Under no conditions must they be worn over the region of the abdomen.

Some teams tend to fit **bungees bungies** on the shoulder belts in order to move them to the side of the seat. However, this also moves the shoulder belt sideways, **such so** that the belt contact area is reduced, adversely affecting the Hybrid Pro series. **Competitors shall ~~be~~ NOT fit bungees bungies on the shoulder belts.**

4.2.1. Harness restrictions

Hybrid devices can be used with harness models that are homologated with the standard shoulder strap width of a minimum of **70 mm**, as well as with models that are homologated with **a** specific shoulder strap width of a minimum of 44 mm and that are marked "for FHR use only", or "for HANS® use only".

FIA Homologated double shoulder belt systems are not necessary or useful for use with the Hybrid or Hybrid Pro devices.

4.2.2. Position of Adjusters

The length adjustment device of the shoulder belt shall be positioned low on the chest.

4.2.3. Shoulder belt angles – top view

The shoulder belt anchorage points on the car shall be symmetrical about the centre line of the driver's seat. When viewed from above, it is recommended that the angle between the belts be approximately 20°-25° and never out of the 10°-25° range. Belts may touch or even be crossed over each other if necessary, as shown in Figure 6.

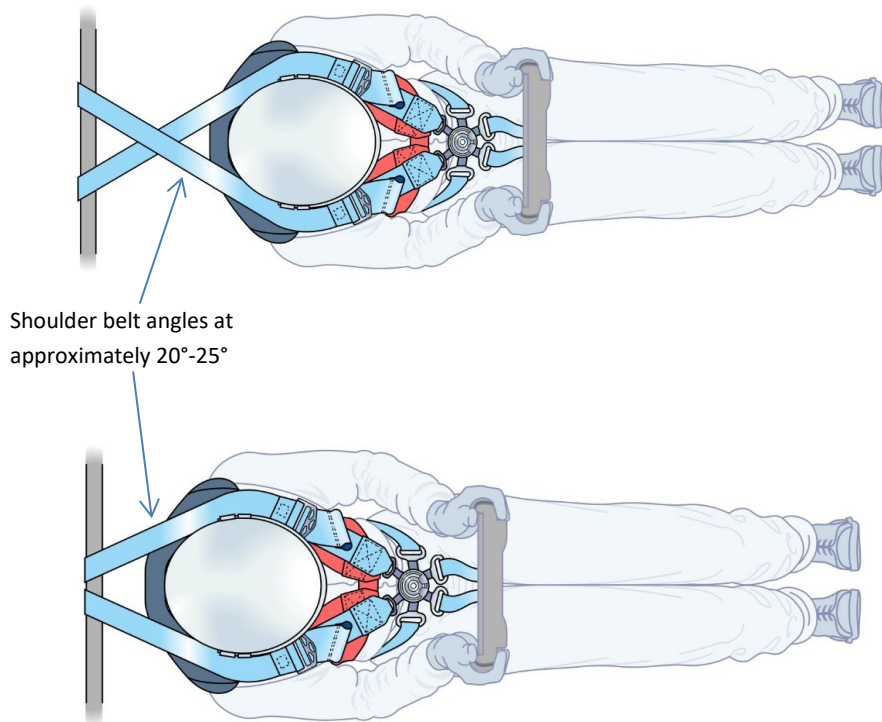

Figure 6 Examples of shoulder belt angles

It is important to make sure that the shoulder strap attachment cannot slide laterally.

4.2.4. Shoulder belt angles – side view

When using a Hybrid or Hybrid pro with a saloon salon car, it is recommended that the rear section of the shoulder strap should shall be horizontal to sloping downwards from the uppermost point of contact with the Hybrid or Hybrid Pro-belt-bearing-surface to the anchorage point on the car. Acceptable angles are preferably Preferably between 0° to 10° below the horizontal, and up to 20° being acceptable, as shown showed in Figure 7.

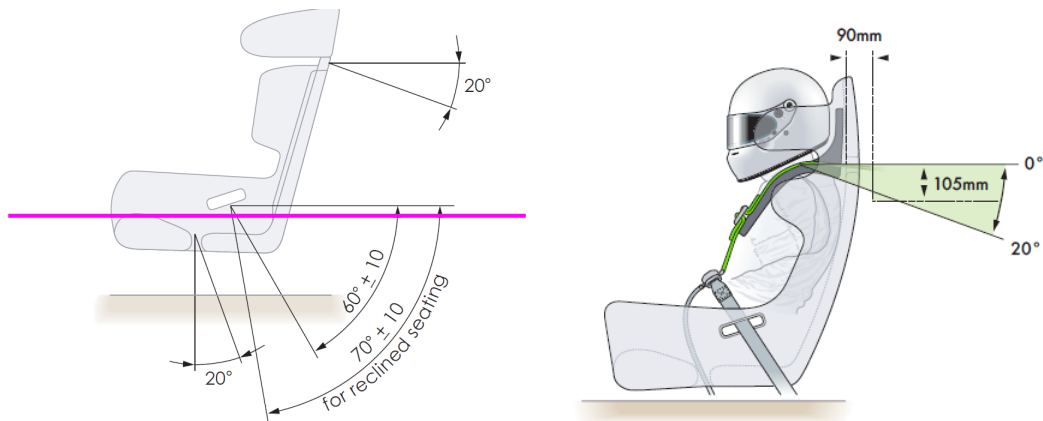

Figure 7 Side view to show recommended belt angles

When using a Hybrid device with a reclined seat (for example in an open cockpit car) it is recommended that the rear section of the shoulder strap is horizontal from the uppermost point of contact with the Hybrid belt-bearing-surface to the anchorage point on the car, preferably a 0° angle. Angles angles between 0° and 10° are being acceptable, as shown in Figure 8.

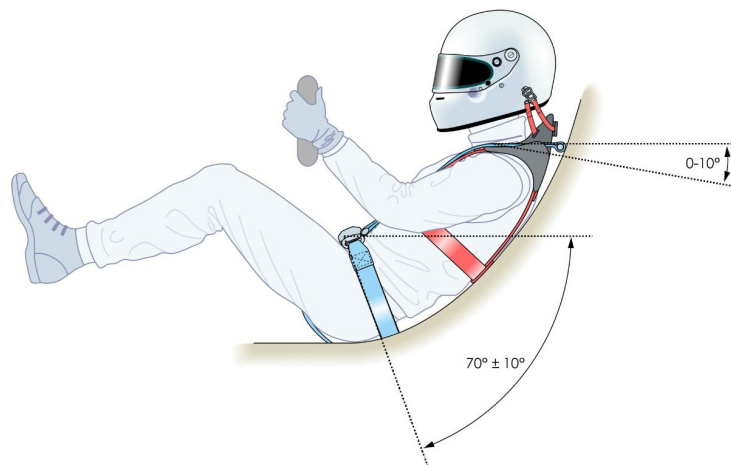

Figure 8 recommended belt angle for open cockpit cars

4.3. Headrests and cockpit surrounds with Hybrid

Since the Hybrid devices have a low collar design, there is no interference is expected with the helmet, headrest or cockpit surround.

4.4. Car evacuation with Hybrid

It is essential to practice rapid evacuations from the car with full race equipment fitted (including race attire, steering wheel, radio system and drinking system if applicable). This will help to ensure successful emergency evacuation, in the case of an accident.

5. Life of the Hybrid

After a heavy impact that involves loading of the Hybrid, it is recommended to replace the helmet and Hybrid device. The respective manufacturers may be able to provide an inspection service to determine whether the helmet or Hybrid device has suffered any damage during less severe impacts.

An accident is considered severe if it is a frontal or angled-frontal with-an-angled impact with the an estimated impact speed over 50 kph.