

MOTTROL

Defense

Applications & Solutions

Ground Sea Sky Space

We create and **precisely control movement** anywhere in the ground, sea, sky and space.



MOTTROL
Creating Motion & Control

Mottrol Co., LTD

171, Wanam-ro, Seongsan-gu, Changwon-si, Gyengsangnam-do, Korea (51528)

☎ +82 55 269 5541 📠 +82 55 269 5224

www.mottrol.com

History

Starting with the development of hydraulic parts for construction machinery, Mottrol, since its establishment in 1974, has **steered the hydraulic components industry** in Korea towards growth by extending its drive **stabilization and precision control technologies** into various sectors such as the defense industry.

With accumulated technology and quality, Mottrol has contributed to **the establishment of a state-of-the-art defense system** by providing **the hydraulic/electronic solutions** as a core function for the defense industry sector.

MOTTROL

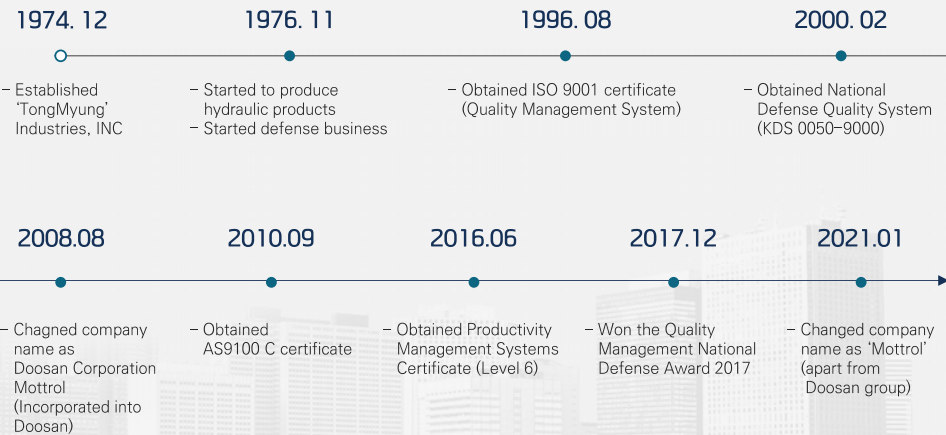

Vision

mottrol vision



Core values

core values

Since its foundation in 1974, Mottrol have manufactured high-quality products that meet the requirements of our clients and their trust through continuous technological innovations. These two values of technological innovation and quality control are of the highest priority and critical to the future growth of Mottrol Co., Ltd.

Mottrol Core Values

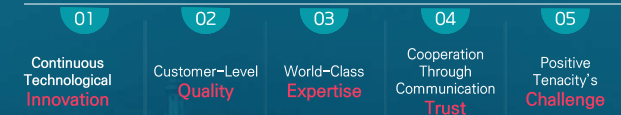

Work place

workplace

Location	(Nae-dong)171, Wanam-ro, Seongsan-gu, Changwon-si, Gyeongnam, Korea 51528
Contact	+82-55-269-5541 FAX : +82 55-269-5224
Web site	www.mottrol.com



Mottrol

Defense division

Creating Motion & Control

Creating Value through Technology

Mottrol has contributed to national defense by developing and supplying the hydraulic systems and electro-hydraulic systems to the Army, Navy and Air force.



Defense Applications & Solutions



1 Driving & Stabilization System

1) Gun/Gun Turret Driving System

- Hydraulic type of Gun/Gun Turret Driving System
- Electric type of Gun/Gun Turret Driving System

2) Precision Driving System for Laser Weapon

- FSM, Fast Steering Mirror
- Pedestal Driving system for Laser Weapon

3) Stabilization Systems for Terminal Antenna Pedestal

4) Electro-Mechanical Servo System for Short Range Tracking Radar

5) Controller for Helicopter gun driving and ammunition feeding

6) Gyroscope for Ground Vehicle

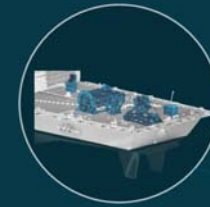
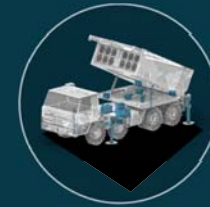

2 Hydraulic Components & System

1) Hydraulic Systems for Missile Launcher

2) Hydraulic Components for Aerospace

- Hydraulic Pump
- EHA, EMA, Accessory parts for turbo-fan engine

3) Hydraulic Servo Valve



3 Hydraulic & Electric Winch System

1) Winch System for Sonar Detection Unit

2) LARS, Launch and Recovery System



4 Hydro-pneumatic Suspension System

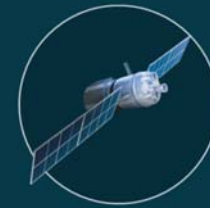

5 Core-components for Space Industry

1) 3 stages TVC(Thrust Vector Control) system for Space Rocket

K55/K55A1SPH

Driving & Stabilization Systems

Hydraulic Gun/Turret Driving System

The hydraulic gun/turret driving system for K55/K55A1 is a key device that supplies hydraulic pressure to the elevation balancing cylinder responsible for up-and- down operation, traverse device for rotating the gun turret and ammunition auto-loading system.

01 **Elevation Balancing Cylinder**

Drives gun up/down with the hydraulic power from gun control system and protects the gun by absorbing the firing shock.

04 **Swivel Valve Block**

This block controls hydraulic oil flow direction to raise or lower loading device assembly.

02 **Elevation Balancing Cylinder**

High angle is limited to prevent loading device collision with the floor.

05 **Hydraulic Power Pack**

Converts the electric power from power supply system to hydraulic power (pressure/flow rate) to supply to elevation, traverse and loading systems.

03 **Ramming Driver**

Piston rod pushes or pulls push-rod assembly for automatic loading.

06 **Manual Elevation Pump**

Raises or lowers gun manually in case of main power line failure.

Key features

- ✓ **Operating gun up-and-down** through Elevation Balancing Cylinder
- ✓ **Rapid loading shells** through auto flick ramming system
- ✓ **Energy saving** through discontinuous drive

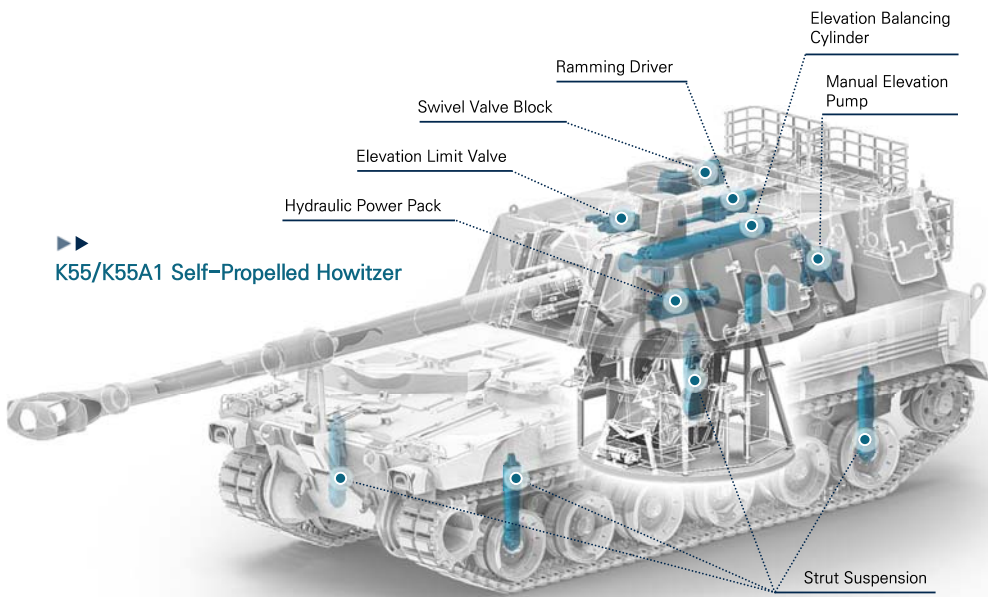

K55/K55A1 Self-Propelled Howitzer

K9 SPH

Driving & Stabilization Systems

Hydraulic Gun/Turret Driving System

The hydraulic drive system of K9 self-propelled howitzer uses hydraulic power generated from the hydraulic power generator to drive the gun up-and-down, drive the gun turret rotation, and it also loads shells into the gun barrel.

01 **Traverse gear box**

Converts hydraulic power into mechanical rotational motion to traverse turret.

04 **Hydraulic system control panel**

Supplies power to the hydraulic system components of turret, and drive electric motor and pump to generate the hydraulic power for turret driving.

02 **Motor, pump, oil reservoir**

Controls hydraulic fluid flow according to the signal from the electronic unit to control the speed of the elevation drive system.

05 **Elevation manual pump**

Raises or lowers gun manually in case of the main line failure.

03 **Filter manifold assembly**

Removes impurities from the hydraulic oil in supply and return lines. A pressure switch triggers alarms when clogged.

06 **Cooling device assembly**

Keeps steady state of hydraulic fluid temperature by blasting external air into turret system.

Key features

- ✓ **Rotating the gun turret** through Traverse gear box
- ✓ **Operating gun up-and-down** through Elevation Balancing Cylinder
- ✓ **Rapid loading shells** through auto flick ramming system
- ✓ **Optimized hydraulic power generator** which is unified by Motor, Pump and Oil reservoir

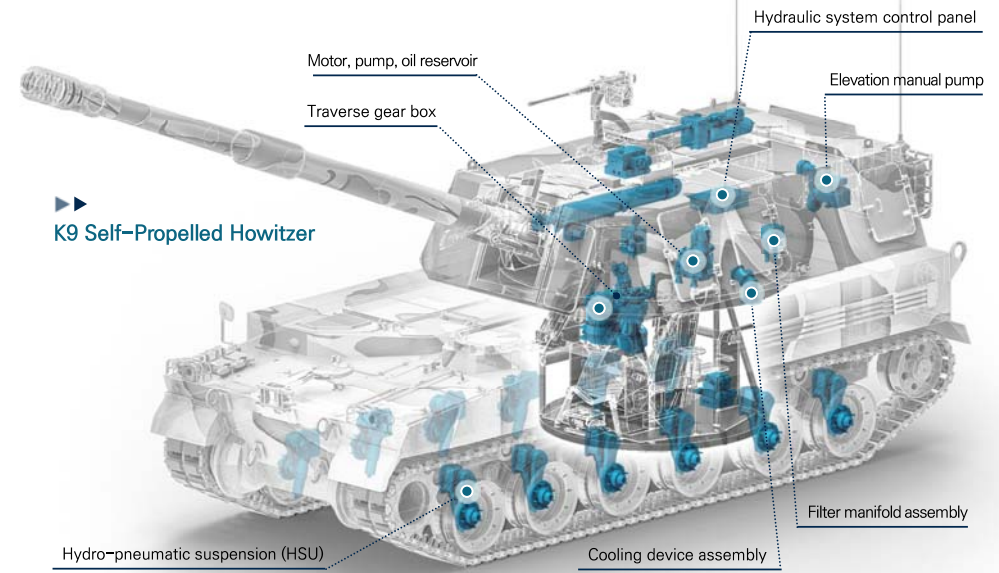

K9 Self-Propelled Howitzer

Driving & Stabilization Systems



Hydraulic Gun/Turret Driving System

The Gun/Turret Driving System (GTDS) on the K1A1 MBT detects the impact of yawing and pitching motion of the vehicle's body onto the gun and turret when actuating the gun and turret or driving on Uneven road surfaces and curved roads, and enables to take aim at the target and to execute the precise fire while driving.

- 01 **Elevation servo system**
Controls hydraulic fluid flow according to the signal from the electronic unit to control the speed of the elevation drive system.
- 02 **Elevation drive system**
Converts hydraulic power into mechanical linear motion to move gun up and down.
- 03 **Reference gyroscope**
Detects and converts the angular speed of gun and turret into electric signals and sends them to the electronic unit
- 04 **Traverse servo system**
Controls hydraulic oil flow according to the signal from the electronic unit to control the speed of traverse system.
- 05 **Traverse drive system**
Rotates turret by converting hydraulic power to mechanical force.
- 06 **Feed-forward gyroscope**
Detects and converts the angular speed of turret and chassis into electric signals and sends them to the electronic unit.

- ### Key features
- ✓ **Electro-hydraulic servo system**
 - ✓ **Feedback control** using servo valves and speed sensors
 - ✓ Technology to **minimize vibration and noise**
 - ✓ **Hydraulic drive control technology** for the overload system

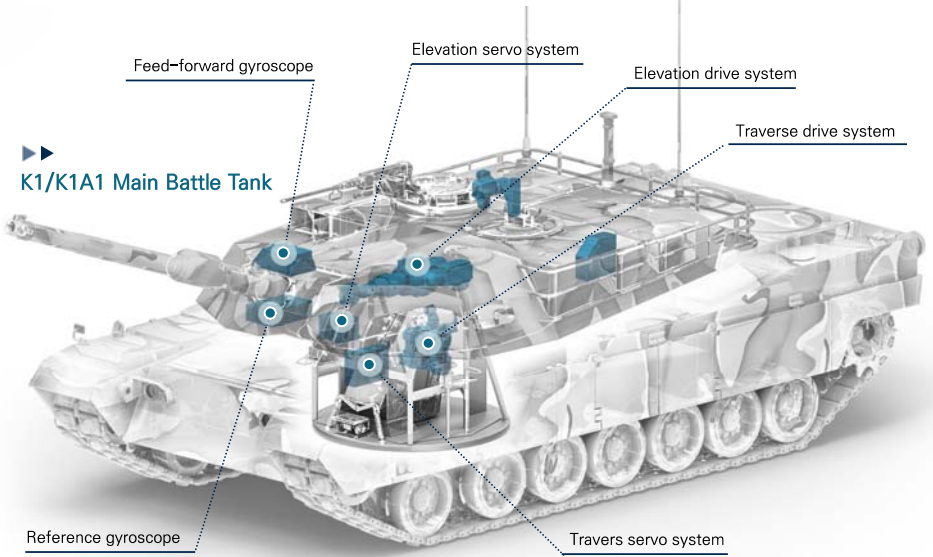

Driving & Stabilization Systems



Electric Gun/Turret Driving System

Electric Gun/Turret Driving System(EGTDS) boosts 28VDC power of the vehicle to 260VDC and Controls the servo motor by high-response control using a power amplifier for elevation/slewing Devices. This enables the EGTDS to perform high efficiency/precision drive control and has improved its performance for advanced stabilization.

- 01 **Elevation/Traverse servo amplifier**
Drives elevation/traverse device with the current input from drive/power controller.
- 02 **Traverse drive system**
Rotates turret at the torque and speed provided from electric motor and reducer using the electric energy according to the control of the commander/artillery man's handle operation.
- 03 **Elevation drive system**
Drives gun up/down at the torque and speed provided from electric motor and reducer using the electric energy according to the control of the commander/artillery man's handle operation.
- 04 **Commander's control handle**
Converts mechanical displacement of handle into electric signal to control the speed and direction of turret.
- 05 **Gunner's control handle**
Converts mechanical displacement of handle into electric signal to control the speed and direction of turret.
- 06 **DC-DC converter**
Steps up 28VDC of battery to 260VDC. And supply it to elevation/swing power amplifier.

- ### Key features
- ✓ **Precision gear design technology** for high stiffness and low backlash
 - ✓ **Noise and vibration reduction technology**
 - ✓ **High efficiency power transmission technology**
 - ✓ **Electric drive control technology** for the overload system

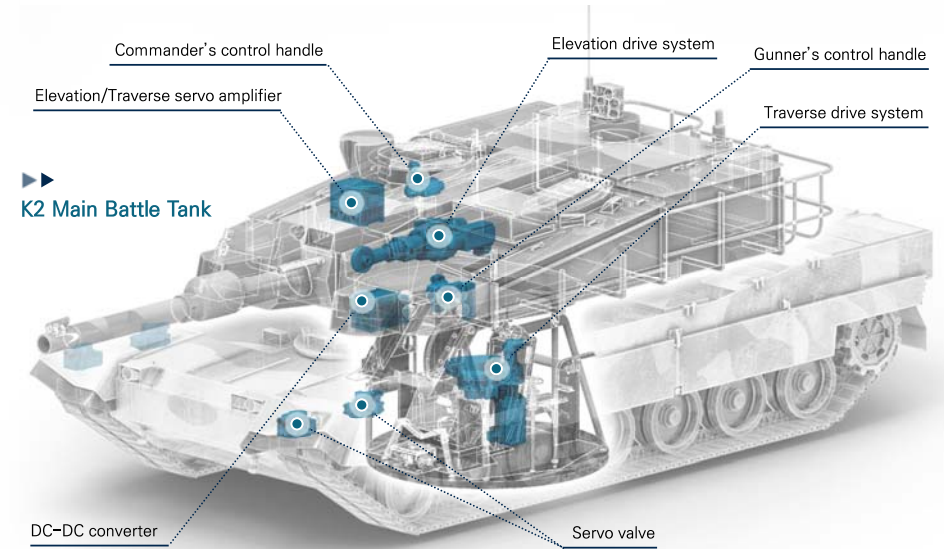

Driving & Stabilization Systems



Electric Gun/Turret Driving System

The electric type of gun/turret driving system uses automation technologies in order to shorten the reaction time, increase the firing rate of the gun, improve the operational continuity, and minimize the number of people.

- 01 **Traverse Mechanism**
Rotating the turret using the torque/speed generated by electric motor and reduction gear
- 02 **Elevation Mechanism**
Moving the gun up/down using the electric motor, linear converter and reduction gear
- 03 **Driving Controller**
Provide gun/turret driving control function, calculation algorithm function for gun/turret driving stabilization, rapid firing control function
- 04 **Electric Power Converter**
Power supply that generates power to drive the gun/turret drive.

- ### Key features
- ✓ Applied **precision gear design technology** for high rigidity and low backlash
 - ✓ Applied **vibration/noise reduction technology**
 - ✓ Applied **high-efficiency power transmission technology**
 - ✓ Applied **electric drive control technology** against heavy load

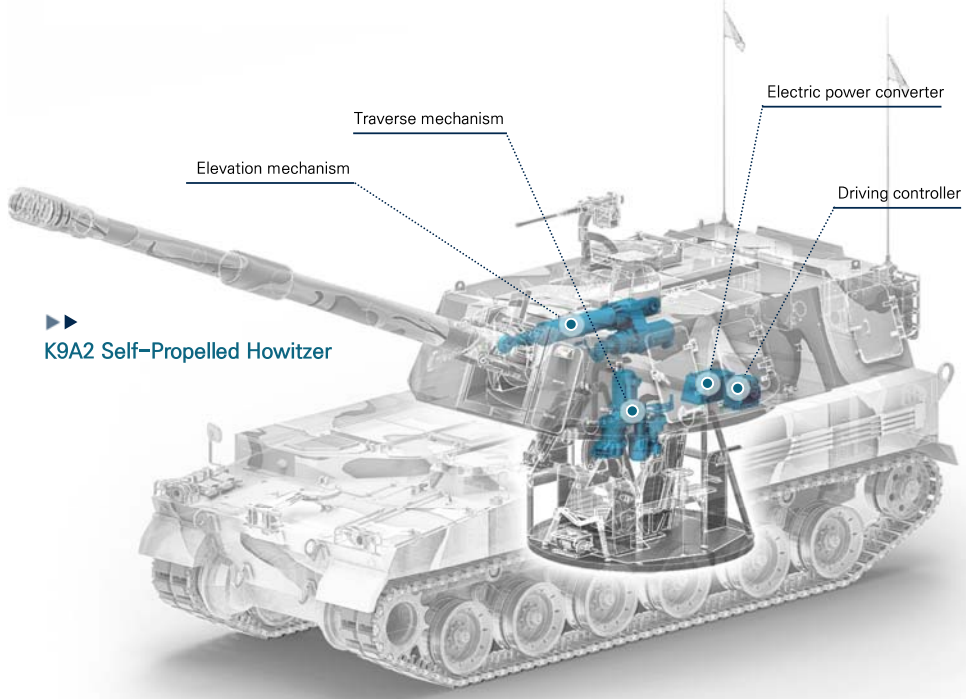

Driving & Stabilization Systems

History of Driving & Stabilization Systems

Starting with the production of hydraulic systems for K200 armored vehicles, Mottrol has developed and supplied various types of gun/turret driving & stabilization systems applied to defense ground vehicles. Since 2000s, Mottrol has successfully developed and applied high-precision electric gun/turret driving & stabilization systems to mass production by reflecting the latest technology trends and customer needs.

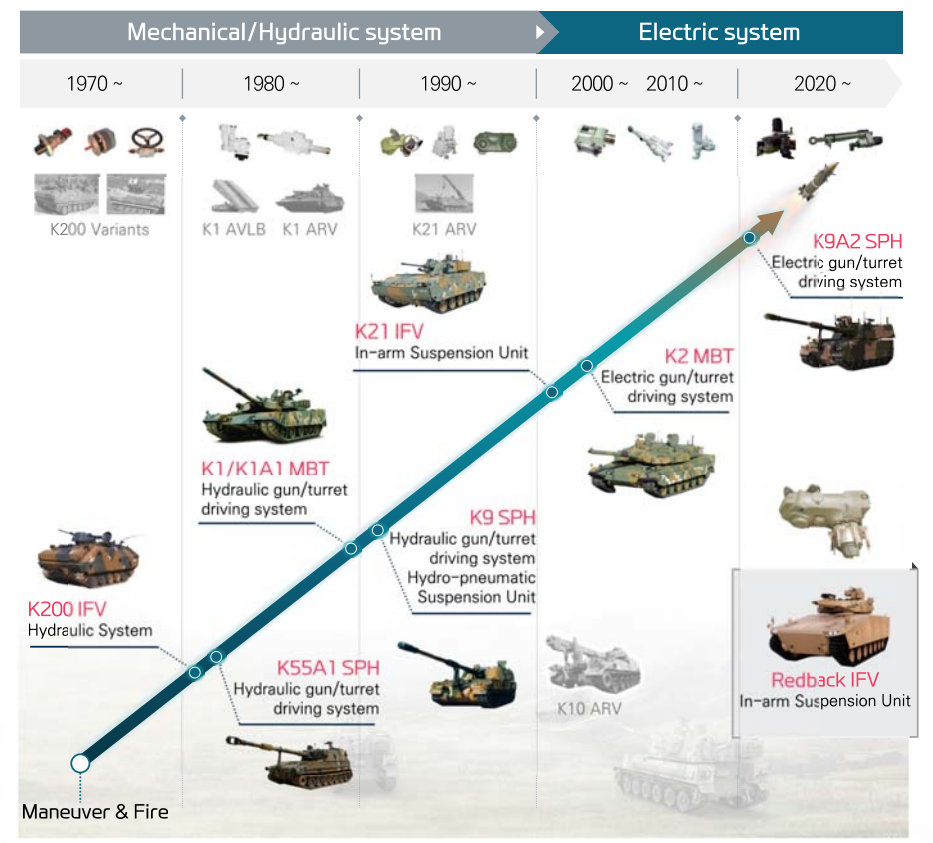

Performance improvement
Increased user convenience

Driving & Stabilization Systems

Precision Driving System for Laser Weapon

It is a key part of the laser weapon system that neutralizes the target with a high-energy laser beam, and it plays a role in maintaining the aiming point precisely while focusing the high-energy laser on the weak area of the target. In addition, it is possible to expand into the field of ultra-high-speed space optical communication that uses lasers to exchange data between the ground and satellites orbiting in space.

Applications



Fixed laser weapon



Naval laser weapon



Movable laser weapon



Aerial laser weapon



Space & optical communication

FSM (Fast Steering Mirror)

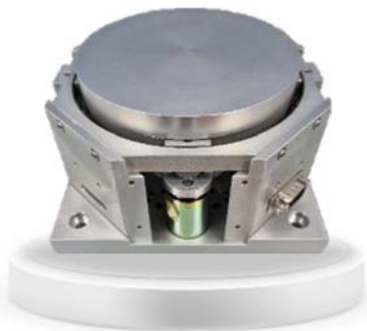

Key features

- ✓ Voice Coil Motor(VCM)
By applying the electro-magnetic actuator, it provide **wide driving range, excellent linearity and rapid response.**
- ✓ Driving range : ±5 mrad
- ✓ Driving bandwidth : 150 Hz
- ✓ Driving accuracy : 10 urad

Pedestal Driving System for Laser Weapon

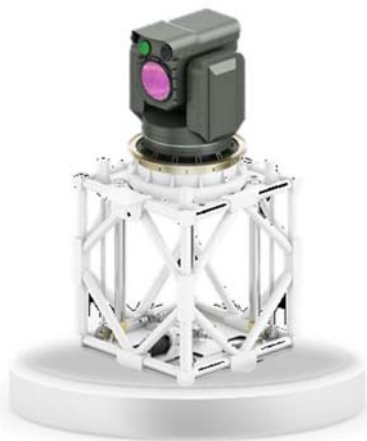

Key features

- ✓ **High tracking precision** with a heavy load and direct driving mechanism
- ✓ **High rigidity structure**
- ✓ **Zero Backlash**
- ✓ Position repeatability < 1 arc-sec
- ✓ Retractable and deployable lift structure
- ✓ Height repeatability < 20 μm

Driving & Stabilization Systems

Stabilization System for Terminal Antenna Pedestal

Precise, stabilized pedestal for surface ship antenna to enable accurate satellite tracking automatically or manually. Ship's roll, pitch, yaw are automatically compensated for uninterrupted military satellite communication.

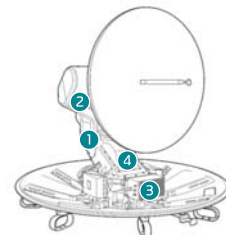

Function	3-axis stabilization
Load	250 [kg]
Driving Range	Elevation : -30°~120° Cross: -55°~ 55° Azimuth : 360°
Angular velocity	Max. 20 [deg/sec]
Angular acceleration	Max. 25 [deg/sec ²]
Control accuracy	Less than 3.4 [mrad-rms]

1 Pedestal Control Unit



High speed DSP is applied to compensate external source of disturbance by waves, and an algorithm for precise satellite tracking control is built-in.

2 Sensor Box



Consists of the rate sensor for measuring external disturbance signals and tilt sensor for measuring inclination.

3 Power Supply Unit



Supplies electric power to motor drive, pedestal control assembly board and various sensors.

4 Pedestal Device



A device for low backlash and high speed precision control. This device controls satellite antenna direction with 3-axes electric precision drive control.

Electro-Mechanical Servo System for Short Range Tracking Radar

Electro-Mechanical Servo System drives and controls drives and controls a radar system that improves the survivability of a ship from a threat target.



Function	2-axis stabilization
Load	380 [kg]
Driving Range	Elevation : -20° ~ 85° Azimuth : 360°
Angular velocity	Max. 114 [deg/sec]
Angular acceleration	Max. 401 [deg/sec ²]
Control accuracy	Less than 0.3 [mrad-rms]

Servo Amplifier



This device is for the operation of the high voltage, high precision BLDC motor for precise control of servo driver.

Servo Controller



Compensates the external disturbance, such as waves, to the ship by applying high speed DSP. An algorithm for precise tracking is built-in.

Servo Driver



A device for low backlash and high speed precision control of antenna direction based on 2-axis electric precision drive control.

Emulator



The emulator tests and analyzes servo system performance by creating drive commands.

Driving & Stabilization Systems

Controller for Helicopter Gun Driving and Ammunition Feeding

Control of turret-type machine gun driving/ammunition feeding system by receiving the driving & firing commands from the Store Management Computer (SMC).

Main functions

- ✓ **Number of machine gun firing and fire control**
 - Firing control : number of ammunitions
 - Firing/Stop function
 - Safety control : Firing limit function in landing
- ✓ **Control for Turret driving**
 - Rotating range : -110 ~ +110deg
 - Elevation range : -50 ~ +23deg
 - Max. speed : 90deg/sec
- ✓ **Control for ammunition feeding**
 - Feeding control while firing
 - Manual feeding control in landing
- ✓ **Firing and driving power control**
 - Machine gun/turret driving,
 - Supplying electric power to feeding system

Key features

- ✓ **BIT(Built-In Test) self-diagnosis function** : Gun Jamming, over current, low voltage
- ✓ **Specifications**
 - MIL-STD-1553B communication : interlocking with SMC
 - Discrete Input/Output : interlocking with SMFD, AFCS



Light Armed Helicopter (LAH)

Controller for Gun Driving and Ammunition Feeding System

※ Abbreviations

- GCU (Gun Control Unit)
- SMC (Store Management Computer)
- TGS (Turret Gun System)
- LAH (Light Armed Helicopter)
- AFCS (Automatic Flight Control System)
- SMFD (Smart Multi Function Display)

Driving & Stabilization Systems

Gyroscope for Ground Vehicle

Electrically/physically compatible with existing type of gyroscopes (mechanical & electrical type)

- High impact resistance
- High reliability

Key feature

- Key sensors for gun/turret **speed control and stabilization**
- Provide targeting and tracking functions** with GPS, CPS
- Accuracy aiming and targeting** when shooting and vehicle maneuvering
- Compatible /replaceable** with existing mechanical type of 'reference gyro' and 'feed forward gyro'

Applications :
K1/K1A1/K2 MBT, M1 series MBT, IFV, SPH etc.

Electronic type of Gyroscope

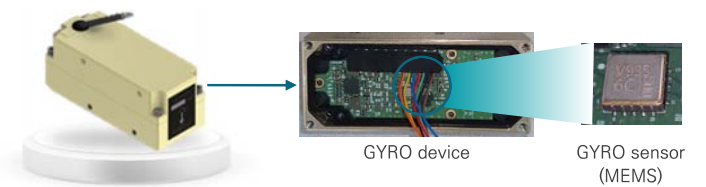

Input Rate	±100 °/sec
Sensitivity	100mV/°/sec
Linearity	≤ 5 % + 0.02 °/sec
Start-up time	≤ 1 sec.
Band width	> 70 Hz @-90°
Size	635 x 264 x 264 mm

Final Gyroscope Assemblies



Hydraulic Components & Systems



Hydraulic Systems for Missile Launcher

Efficient operation is possible by applying the BLAC motor and the constant-power pump, and the elevation cylinder and jack cylinder with mechanical self-locking mechanism enables stable operation of the missile launcher.



01 Hydraulic power pack



02 Elevation cylinder



03 Manifold



04 Jack cylinder



05 Oil reservoir



06 Flame deflection cylinder

Key features

- ✓ Applied high-efficiency servo motor and **constant power type of pump**
- ✓ Jack cylinder with improved **mechanical self-locking** mechanism
- ✓ Elevation cylinder including hydraulic locking unit supports heavy loads
- ✓ **Sequential operation** of hydraulic actuators
- ✓ **Emergency operation** through auxiliary power device
- ✓ **Cylinder protection** from flame by application of bellows

L-SAM Launcher

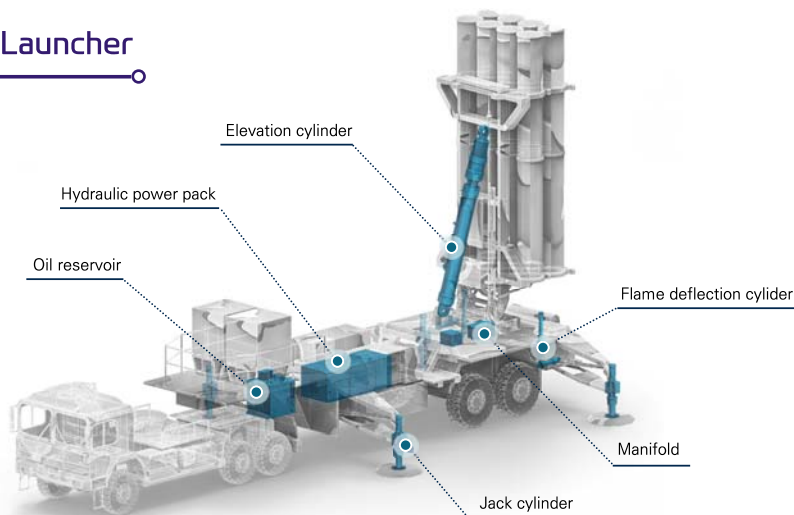

Hydraulic Components & Systems



Hydraulic Systems for Missile Launcher

Hydraulic Drive System supports the MLRS(Multiple Launch Rocket System) when it firing and drives the pod up/down, turns it to the right/left. It plays a role in improving firing accuracy by driving quickly and precisely.



01 Servo motor
Drives the launching ramp to precise position and angle with the hydraulic power from the main pump controlled with servo valve.



04 Main pump
Generates hydraulic power from the energy of engine, and supply the power to hydraulic system.



02 Hydraulic pressure system
Provides hydraulic power to hydraulic system during engine stop to enable firing.



05 Jack cylinder
Supports vehicle horizontally for accurate firing control using the hydraulic power from the main pump.



03 Oil reservoir
The reservoir of the hydraulic oil, which cools down the oil from its metallic surface.



06 Swivel joint
This device provides hydraulic oil paths from the hydraulic power system beneath the vehicle to the hydraulic motor for rotate up/down and left/right.

Key features

- ✓ **High precision position control** by using the electro-hydraulic servo motor
- ✓ **Feedback control** by servo valve and yoke position sensor
- ✓ **Optimal system design** for the hydraulic system and energy saving

MLRS

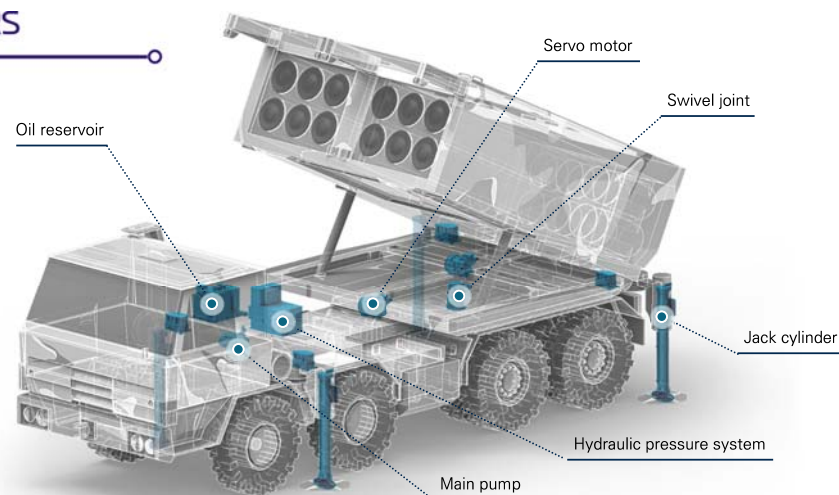

Hydraulic Components & Systems



Hydraulic Systems for Missile Launcher

Hydraulic Drive System and Controller for KM-SAM(Korean Medium range Surface-to-Air Missile) Launcher is capable of combining and separating vehicle from launcher, supporting launcher, driving launcher up/down and controlling attitude.

01 Elevation driver



Being connected with the lower and upper frames, the driver extends to move the projectile to the position.

02 Elevation drive distributor



Controls the pressure and low fed to, returned from elevation driver according to the control signal of the launching ramp.

03 Jack cylinder



Extends jack to fix, support the launching ramp and lifts ramp up for separation, combination with vehicle.

04 Hydraulic power pack



Comprised of the hydraulic pressure generator with electric motor and hydraulic oil reservoir.

05 Locking cylinder



Locks high angle driver and outrigger during travel.

06 Extension cylinder



Extends front outrigger and rear rotating beam to allow vehicle separation.

Key features

- ✓ Applied **mechanical automatic locking jack cylinder**
- ✓ **Low energy consumption** under 9KW
- ✓ Possible to **separate the launcher and vehicle** by using the jack and extension cylinder
- ✓ Operating temperature : -32 ~ 50°C
- ✓ Max. installation slop angle : 5°

KM-SAM Launcher

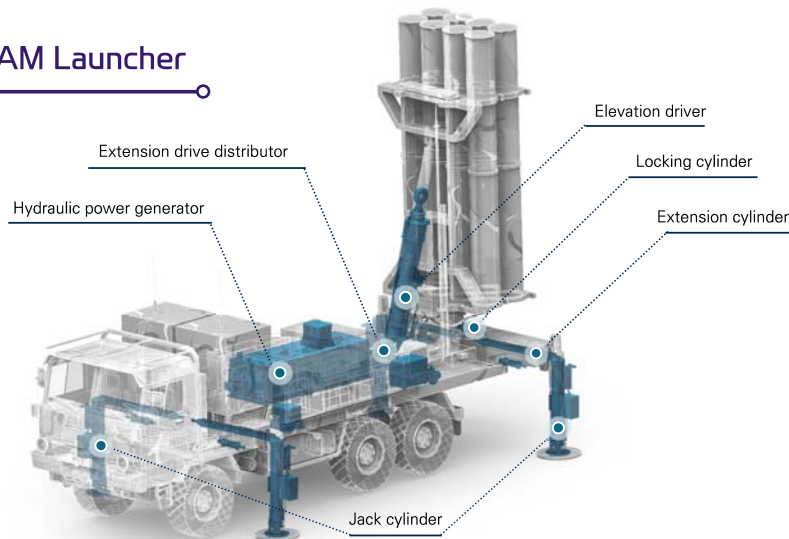

Hydraulic Components & Systems



Hydraulic Systems for Missile Launcher

Hydraulic Drive System and Controller for KM-SAM MFR(Multi-Function Radar) is capable of combining and separating vehicle from radar, supporting radar, driving radar up/down and controlling attitude.

01 Hydraulic power pack



Using electric motor, generates hydraulic power and supply the power to hydraulic devices.

02 Antenna up-down cylinder



Extends/retracts cylinder to raise/lower antenna.

03 Antenna Lock device



At start/completion of antenna up-down, locks or releases antenna locking device.

04 Hydraulic unit



Controls antenna up-down cylinder and locking device.

05 Hydraulic jack



Extends hydraulic jack for stable support of antenna base, or raises antenna base for separation, combination with vehicle.

06 Oil reservoir



Stores hydraulic oil.

Key features

- ✓ Applied **mechanical automatic locking jack cylinder**
- ✓ **Low energy consumption** under 9KW
- ✓ Possible to **separate the launcher and vehicle** by using the jack and extension cylinder
- ✓ Operating temperature : -32 ~ 50°C
- ✓ Max. installation slop angle : 5°

KM-SAM MFR

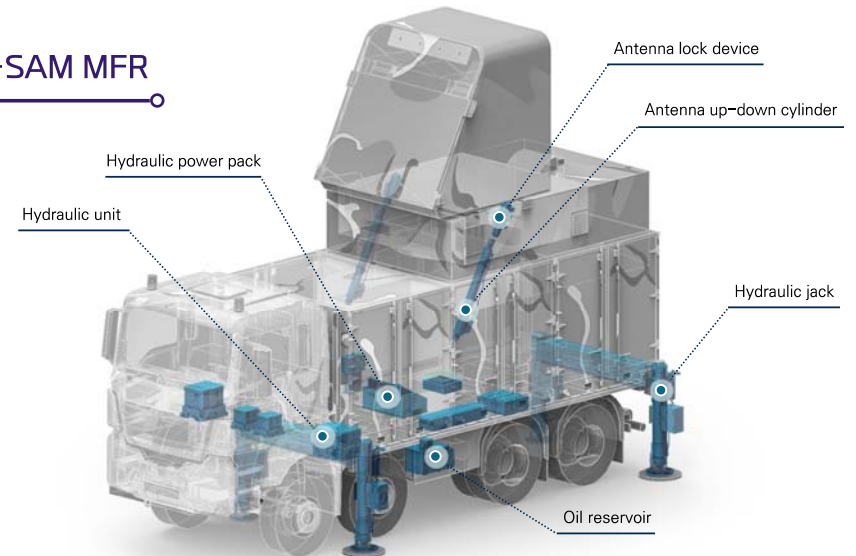

Hydraulic Components & Systems

Hydraulic Components for Aerospace_Rotary-wing aircraft

Starting with the successful localization of hydraulic pumps for UH-60 helicopters, Mottrol has secured own technology. And, Mottrol has been proven their technical capability through completion of successful development and mass production of hydraulic pumps for LCH/LAH helicopters.

Main hydraulic pump/auxiliary hydraulic pump for LCH/LAH

Main hydraulic pump



Auxiliary hydraulic pump

items	specifications
Rated discharge pressure (M Pa)	14.0
Rated discharge flow rate (lpm)	Min. 27.0
Displacement (cc/rev)	5.29
Rated rotation speed (rpm)	5,862 & 6,004
Total efficiency (%)	Max. 85.0
Weight (kg)	Max. 3.2
Rated operating temp. (° C)	110

Key features

- ✓ High efficiency and light weight variable capacitive type of piston hydraulic pump
- ✓ Meet with SAE-AS-19692, MIL-STD-810, RTCA-DO 160

items	specifications
Rated discharge pressure (M Pa)	12.5
Rated discharge flow rate (lpm)	Min. 1.1
Displacement (cc/rev)	0.243
Electric current (A)	Max. 23
Weight (kg)	Max. 1.56
Rated operating temp. (° C)	- 45 ° ~ 70

Key features

- ✓ Geared type of hydraulic pump with integrated with electric motor
- ✓ Supplies flow rates to the hydraulic system when helicopter is landing in ground for inspection
- ✓ Meet with MIL-STD-810, RTCA-DO 160

Hydraulic pump for KUH



items	specifications
Rated rotation speed (rpm)	4,723
Rated flow rate(l/min)	Min. 20.0
Displacement (cc/rev)	4.87
Rated outlet pressure (M Pa)	20.7
Rated operating temp. (° C)	107.2
Weight (kgf)	Max. 2.67

Key features

- ✓ High efficiency and light weight variable capacitive type of piston hydraulic pump
- ✓ Meets durability requirements of 2,000 hours including 20,000 case pressure cycle tests per SAE-AS1962
- ✓ Meet with MIL-STD-810

Hydraulic Components & Systems

Hydraulic Components for Aerospace_Fixed-wing aircraft

Based on accumulated and proven technologies in ground vehicles and guided weapons, Mottrol have completed the development of hydraulic pumps for fixed-wing aircraft. Through continuous R&D, Mottrol have secured design and development capabilities for various actuators of unmanned aerial vehicles and core engine accessories parts.

Hydraulic pump for KF-21 fighter jet



items	specifications
Rated rotation speed (rpm)	4,480
Rated flow rate(l/min)	Min. 295
Displacement (cc/rev)	70.58
Rated outlet pressure (M Pa)	20.7
Rated operating temp. (° C)	107.2
Weight (kgf)	17.85

Key features

- ✓ High efficiency and light weight variable capacitive type of piston hydraulic pump
- ✓ Meet with SAE-AS-19692, MIL-STD-810, MIL-STD-704
- ✓ Minimized pulsation by using the 11 units of piston

Actuators and engine accessory parts for UAV



EHA (Electro-Hydraulic Actuator)



EMA (Electro-Mechanical Actuator)



Fuel Control Unit Fuel Pump

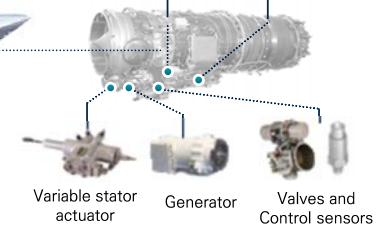

Variable stator actuator Generator Valves and Control sensors

Key features

- ✓ Components design and manufacturing for environment resistant, light weight, high reliability
- ✓ Applied self-developed high precision and high response servo valve
- ✓ Applied high linearity (within 0.5%) LVDT LVDT
- ✓ Generator with maximized cooling efficiency
- ✓ Applied duplexing control design for securing the back-up function
- ✓ Applied high-temperature/high-pressure blush type air seal

Hydraulic Components & Systems

Hydraulic Servo Valve

Servo valve can make **accuracy pressure and flow control** using the low current electric signal and are **suitable for electro-hydraulic position, speed, pressure or force control** systems with **high dynamic response requirements**.

Applications



Defense



Steel/Power plant



Aerospace



Test equipment



Robot

Nozzle Flapper type of Servo Valve



Spool & Sleeve

Armature Assembly



Model	Rated Flow (@3000 psi, gpm)	Maximum Leakage (@3000 psi, gpm)	Frequency of Phase Point(Hz)	Maximum Amplitude Ratio(dB)
NF03	3.0	< 0.2	> 200	< 2
NF08	8.0	< 0.3	> 170	< 2
NF14	14.0	< 0.4	> 160	< 2
NF19	19.0	< 0.6	> 110	< 2
NF44	44.0	< 0.8	> 80	< 2

Hydraulic Components & Systems

Hydraulic Servo Valve

Mottrol developed and produced various types of servo valves applying to applications through continuous R&D investment. And, Mottrol is **expanding business area into the servo driving systems** based on accumulated technologies.

Jet pipe type of Servo Valve

- Has a **structure for resistant to contamination** of hydraulic oil
- **Applicable to aviation actuators** and **fuel control devices** that requires reliability



Key features

- ✓ Structure in which nozzle flow is sprayed from the armature.
- ✓ Simple structure operated by differential pressure between nozzle and receiver

Design and testing technologies

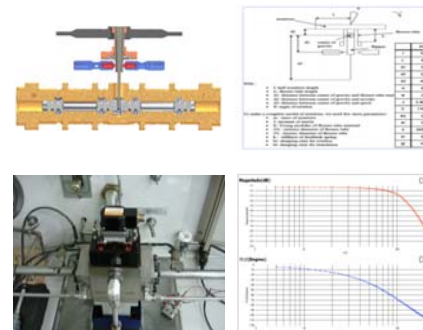

3D printing tech. of Servo Valve

- By using the advantages of 3D printing technology, designed and analyzed inside of housing and sleeve suitable for 3D printing
- Developed servo valves that **realized parts simplification** and **weight reduction**



Key features

- ✓ Integrated housing and sleeve
- ✓ Reduced the number of parts
- ✓ Light weight (33% lighter than before)

High-precision machining technologies

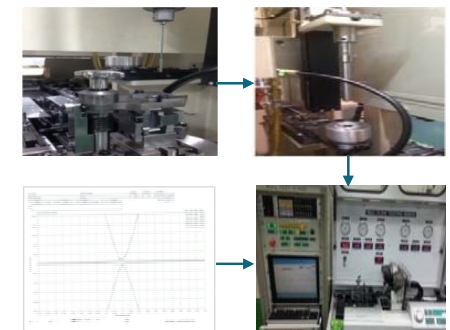

Hydraulic & Electric Winch Systems

Winch System for Sonar Detection Unit

Using the signals reflected by the target when surface vessels generates a sound wave, the hydraulic winch for sonar detects enemy submarines or sea mines by dropping the active sonar unit and tow cable onto the water surface for surveillance and salvage of the unit.

Applications



TASS for KDX I, II



ULTASS for AGS



TACM for FF

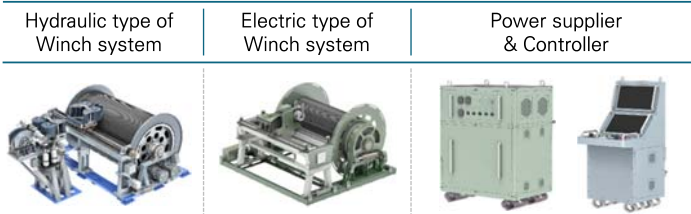
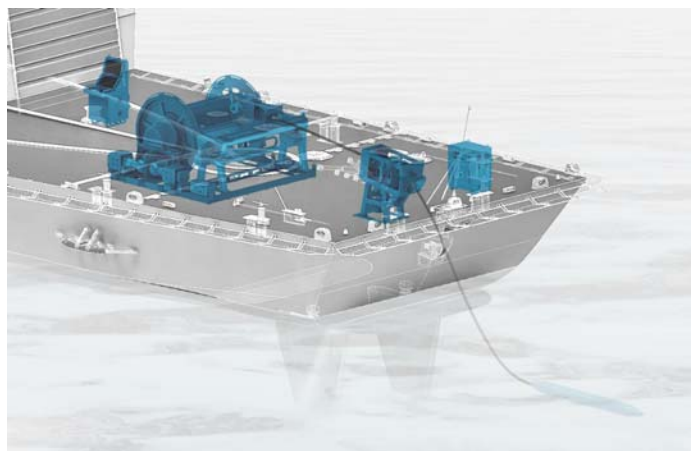

Key features

- Automatic, semi-automatic, manual control possible
- Deployment, retrieval, towing possible at sea state level 3
- Corrosion-resistant design considering seawater contact
- Securing the stability of deployment, retrieval, towing through the optimal design of the drive unit
- Application of tow cable emergency cutter considering emergency situations
- Improved equipment reliability through physical/functional duplexing of main components

Hydraulic & Electric Winch Systems

LARS (Launch and Recovery System)

LARS system mounted on a naval ship works as an active stability control device for launching and recovering the variable depth sonar assembly unit and tow cable at sea for operating a low-frequency variable depth active sound detector(LFPA) that detects an enemy submarine.

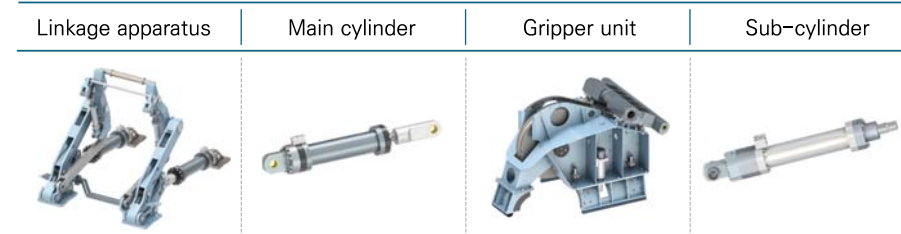
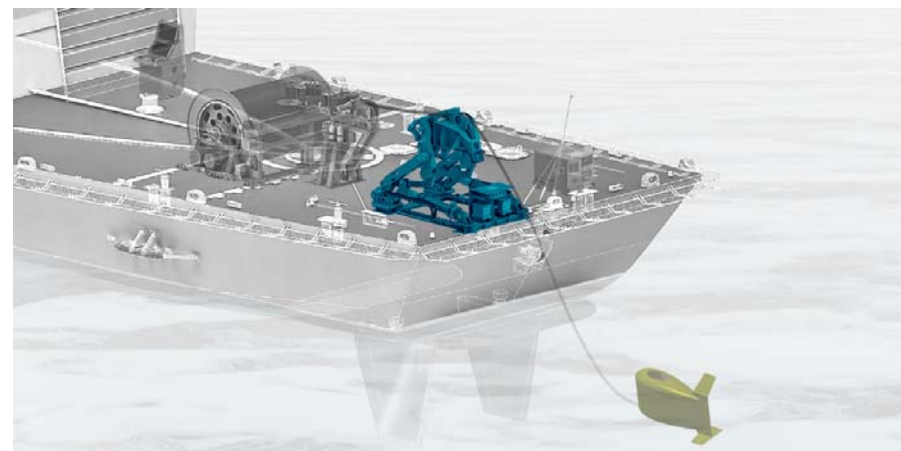

Key features

- Applied hydraulic servo drive type of cylinder manipulator structure
- Automatic, semi-auto, manual mode control considering operating conditions
- Application of individual control and interlocking control for each cylinder
- Improved equipment reliability through duplexing of main components
- Corrosion-resistant design considering seawater contact

Hydro-pneumatic Suspension Systems

Hydro-pneumatic Suspension Systems

Hydro-pneumatic suspension uses the non-linear spring characteristics of nitrogen gas(N2) and the damping characteristics of the damper to minimize vibration and shock transmitted from the road surface when driving the vehicle, thereby improving the vehicle's off-road performance, riding comfort and improving vehicle's maneuverability.

Line-up of Hydro-pneumatic Suspension Units			
Item	In-arm Suspension Unit (ISU)		Strut suspension
Shape			
Application	 ▶ Redback	 ▶ K21/K21 ARV	 ▶ K55A1
Max. load	22.5 ton	18.0 ton	10.0 ton
Wheel travel	Up to 320 mm	Up to 360 mm	Up to 180 mm
Static load	40~45 kN	25~30 kN	7 kN
Weight	less than 180 kg	less than 120 kg	less than 30 kg
Size	717 x 512 x 345 mm	702 x 470 x 435 mm	∅120 x 740 mm

Key features

- Increasing the interior space** of the vehicle's body by removing the torsion bar.
- Shock absorption and improved rideability** through characteristics of nonlinear spring and fixed hydraulic damper
- Easy maintenance** as independently installed outside the vehicle's body
- Easy control and operate** the vehicle's ground level by adjusting the spring force for each wheel position



Hydro-pneumatic Suspension Systems

Hydro-pneumatic Suspension Systems

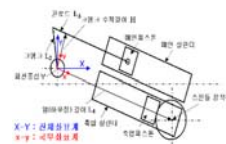
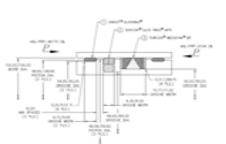
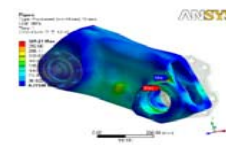
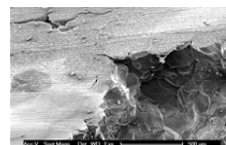
Based on more than 30 years of hydraulic suspension development capabilities and track records, Mottrol is providing optimal solutions to meet customer needs and fit vehicle interfaces.

Design/analysis capabilities	
<p>Optimal design technologies for spring and damping</p>  <p>Kinematic analysis</p>	<p>High pressure lubrication/sealing Mechanism design technology</p>  <p>Design of sealing configuration</p>
<p>Structural and lightweight Design technology</p>  <p>Structure analysis with M&S</p>	<p>Test evaluation and Failure Analysis</p>  <p>Analysis of Micro section</p>

▶ Mottrol have various types of hydro-pneumatic suspension system line-up and have proven technologies and production facilities which can supply the products to customers in a timely manner.

Test facilities			
Items	Spring test	Damping test	Proof pressure test
Image			
Spec.	<ul style="list-style-type: none"> Max. travel : 600 mm Max. speed : 0.7 m/s Max. load : 25 ton 	<ul style="list-style-type: none"> Flow rate : 25~600 lpm Pressure : 0~200bar 	<ul style="list-style-type: none"> Max. pressure : 15,000 psi
Quantity	<ul style="list-style-type: none"> HSU : 1 unit ISU/HSU : 1 unit Strut : 1 unit 	<ul style="list-style-type: none"> 1 unit 	<ul style="list-style-type: none"> 1 unit

Core Components for Space Industry

3 stages TVC(Thrust Vector Control) system for Space Rocket

As a key component, the 3 stages nozzle 'Thrust Vector Control system' applied to the space rocket is **maintaining the flight trajectory** and have a **role for entering the space rocket to high-altitude orbit**. Mottrol has completed successful development and performance verification through the accumulated technologies and know-hows in the field of guided weapons for the past 40 years.



Key features

- ✓ Realized **high rigidity & light weight** through high power-to-weight control
- ✓ Applied **proven technology** for stable performance in high-altitude space environments
- ✓ Thermal Vacuum and Cycling Test Certification (ECSS)
- ✓ Realized **high-response characteristics** through the self-developed/manufactured special servo valves.
- ✓ Applied **flexible shape design technology** considering the interface of space rocket

IPS (Integrated Product Support)

IPS (Integrated Product Support)

Based on **own organization/manpower and specialized capabilities/experience**, Mottrol has been continuously **contributing to the maintenance and operation of armed forces over the past 40 years**. Moreover, Mottrol is conducting the whole required IPS(Integrated Product Support) elements throughout the entire life cycle from product development to disposal.

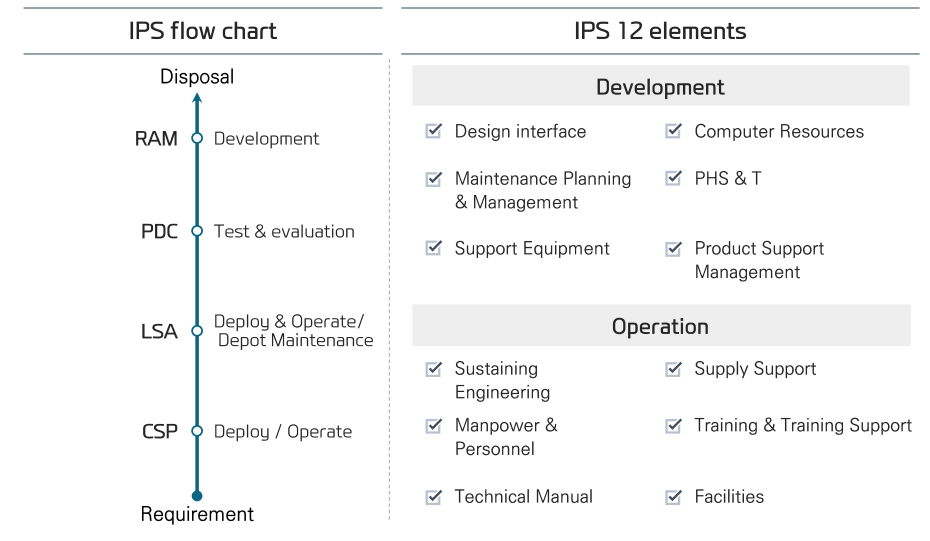

IPS work experiences



Quality Management

Quality Control

By **establishing the quality management system** and **establishing the performance/environment verification system**, Mottrol is **securing product reliability** required for various weapon systems and **realizing the customer satisfaction**.



3D Measuring equipment



Environmental test facility



Inspection room

Certificates

Mottrol pursues customer satisfaction with the best products and services, Mottrol is **building a solid quality management system** that considers **safety and the environment beyond quality**.



ISO 9001



ISO 14001



OHSAS 18001



AS9100D



KDS



PMS



MOTTROL

The **Best** Solution Provider in **Motion & Control**

Mottrol strives to continue into a company that **contributes** to the society and **offers values** to our clients via constant **quality improvement** and **innovations**.

